

# TEST REPORT

<b>FCC ID</b> .....	2AJ3G-CH248M3CN	
<b>Test Report No</b> .....	TCT210803E004	
<b>Date of issue</b> .....	Aug. 05, 2021	
<b>Testing laboratory</b> .....	SHENZHEN TONGCE TESTING LAB	
<b>Testing location/ address:</b>	TCT Testing Industrial Park Fuqiao 5th Industrial Zone, Fuhai Street, Bao'an District Shenzhen, Guangdong, 518103, People's Republic of China	
<b>Applicant's name</b> .....	Zhuhai RaySharp Technology Co., Ltd	
<b>Address</b> .....	NO.100 OF TECHNOLOGY ROAD 6, NATIONAL HI-TECH ZONE, ZHUHAI, China	
<b>Manufacturer's name</b> ...	Zhuhai RaySharp Technology Co., Ltd	
<b>Address</b> .....	NO.100 OF TECHNOLOGY ROAD 6, NATIONAL HI-TECH ZONE, ZHUHAI, China	
<b>Standard(s)</b> .....	FCC CFR Title 47 Part 15 Subpart C Section 15.247 FCC KDB 558074 D01 15.247 Meas Guidance v05r02 ANSI C63.10:2013	
<b>Test item description</b> .....	Wireless Camera	
<b>Trade Mark</b> .....	N/A	
<b>Model/Type reference</b> .....	RS-CH248M3CN-WL-TLA-36W, A03-CH248M3CN-WL-TLA-36W, NVW-800CAM, zzyy-CHxxxzyzzz-zzz-zzyyyyzz-zzz (x= 0-9; y=0-9 or blank; z= A-Z or blank)	
<b>Rating(s)</b> .....	DC 12V	
<b>Date of receipt of test item</b> .....	Aug. 03, 2021	
<b>Date (s) of performance of test</b> .....	See dates for each test case	
<b>Tested by (+signature)</b> ...	Kevin Huang	<i>Kevin Huang</i>
<b>Check by (+signature)</b> ....	Beryl Zhao	<i>Beryl Zhao</i>
<b>Approved by (+signature):</b>	Tomsin	<i>Tomsin</i>

**General disclaimer:**

This report shall not be reproduced except in full, without the written approval of SHENZHEN TONGCE TESTING LAB. This document may be altered or revised by SHENZHEN TONGCE TESTING LAB personnel only, and shall be noted in the revision section of the document. The test results in the report only apply to the tested sample.

## TABLE OF CONTENTS

<b>1. General Product Information .....</b>	<b>3</b>
1.1. EUT description .....	3
1.2. Model(s) list.....	3
1.3. Operation Frequency .....	4
<b>2. Test Result Summary .....</b>	<b>5</b>
<b>3. General Information.....</b>	<b>6</b>
3.1. Test environment and mode.....	6
3.2. Description of Support Units.....	7
<b>4. Facilities and Accreditations .....</b>	<b>8</b>
4.1. Facilities .....	8
4.2. Location .....	8
4.3. Measurement Uncertainty.....	8
<b>5. Test Results and Measurement Data .....</b>	<b>9</b>
5.1. Antenna requirement .....	9
5.2. Conducted Emission.....	10
5.3. Maximum Conducted (Average) Output Power .....	14
5.4. Emission Bandwidth .....	15
5.5. Power Spectral Density.....	16
5.6. Conducted Band Edge and Spurious Emission Measurement .....	17
5.7. Radiated Spurious Emission Measurement.....	19
<b>Appendix A: Test Result of Conducted Test</b>	
<b>Appendix B: Photographs of Test Setup</b>	
<b>Appendix C: Photographs of EUT</b>	

## 1. General Product Information

### 1.1. EUT description

Test item description .....	Wireless Camera
Model/Type reference.....	RS-CH248M3CN-WL-TLA-36W
Operation Frequency .....	2412MHz~2462MHz (802.11b/802.11g/802.11n(HT20))
Channel Separation.....	5MHz
Number of Channel .....	11 for 802.11b/802.11g/802.11n(HT20)
Modulation Technology .....	802.11b: Direct Sequence Spread Spectrum (DSSS) 802.11g/802.11n: Orthogonal Frequency Division Multiplexing(OFDM)
Data speed .....	802.11b: 1Mbps, 2Mbps, 5.5Mbps, 11Mbps 802.11g: 6Mbps, 9Mbps, 12Mbps, 18Mbps, 24Mbps, 36Mbps, 48Mbps, 54Mbps 802.11n: Up to 150Mbps
Antenna Type.....	External antenna
Antenna Gain.....	2.5dBi
Rating(s).....	DC 12V
Remark.....	/

Note: The antenna gain listed in this report is provided by applicant, and the test laboratory is not responsible for this parameter.

### 1.2. Model(s) list

No.	Model No.	Tested with
1	RS-CH248M3CN-WL-TLA-36W	<input checked="" type="checkbox"/>
Other models	A03-CH248M3CN-WL-TLA-36W, NVW-800CAM, zzyy-CHxxxzyzzz-zzz-zzyyyzz-zzz (x= 0-9; y=0-9 or blank; z= A-Z or blank)	<input type="checkbox"/>

Note: RS-CH248M3CN-WL-TLA-36W is tested model, other models are derivative models. The models are identical in circuit and PCB layout, only different on the model names. So the test data of RS-CH248M3CN-WL-TLA-36W can represent the remaining models.

### 1.3. Operation Frequency

#### For 802.11b/g/n(HT20)

Channel	Frequency	Channel	Frequency	Channel	Frequency	Channel	Frequency
1	2412MHz	4	2427MHz	7	2442MHz	10	2457MHz
2	2417MHz	5	2432MHz	8	2447MHz	11	2462MHz
3	2422MHz	6	2437MHz	9	2452MHz	--	--

**Note:**

In section 15.31(m), regards to the operating frequency range over 10 MHz, the Lowest frequency, the middle frequency, and the highest frequency of channel were selected to perform the test, and the selected channel see below:

#### 802.11b/802.11g/802.11n (HT20)

Channel	Frequency
The lowest channel	2412MHz
The middle channel	2437MHz
The Highest channel	2462MHz

## 2. Test Result Summary

Requirement	CFR 47 Section	Result
Antenna requirement	§15.203/§15.247 (c)	PASS
AC Power Line Conducted Emission	§15.207	PASS
Conducted Peak Output Power	§15.247 (b)(3)	PASS
6dB Emission Bandwidth	§15.247 (a)(2)	PASS
Power Spectral Density	§15.247 (e)	PASS
Band Edge	§15.247(d)	PASS
Spurious Emission	§15.205/§15.209	PASS

**Note:**

1. PASS: Test item meets the requirement.
2. Fail: Test item does not meet the requirement.
3. N/A: Test case does not apply to the test object.
4. The test result judgment is decided by the limit of test standard.

### 3. General Information

#### 3.1. Test environment and mode

Operating Environment:		
Condition	Conducted Emission	Radiated Emission
Temperature:	28.7 °C	24.6 °C
Humidity:	52 % RH	39 % RH
Atmospheric Pressure:	1010 mbar	1010 mbar
Test Mode:		
Engineering mode:	Keep the EUT in continuous transmitting by select channel and modulations	
<p>The sample was placed 0.8m &amp; 1.5m for the measurement below &amp; above 1GHz above the ground plane of 3m chamber. Measurements in both horizontal and vertical polarities were performed. During the test, each emission was maximized by: having the EUT continuously working, investigated all operating modes, rotated about all 3 axis (X, Y &amp; Z) and considered typical configuration to obtain worst position, manipulating interconnecting cables, rotating the turntable, varying antenna height from 1m to 4m in both horizontal and vertical polarizations. The emissions worst-case( Z axis) are shown in Test Results of the following pages.</p>		

We have verified the construction and function in typical operation. All the test modes were carried out with the EUT in transmitting operation, which was shown in this test report and defined as follows:

**Per-scan all kind of data rate in lowest channel, and found the follow list which it was worst case.**

Mode	Data rate
802.11b	1Mbps
802.11g	6Mbps
802.11n(H20)	6.5Mbps

### 3.2. Description of Support Units

The EUT has been tested as an independent unit together with other necessary accessories or support units. The following support units or accessories were used to form a representative test configuration during the tests.

Equipment	Model No.	Serial No.	FCC ID	Trade Name
Adapter	CS-1202000	/	/	/

**Note:**

1. All the equipment/cables were placed in the worst-case configuration to maximize the emission during the test.
2. Grounding was established in accordance with the manufacturer's requirements and conditions for the intended use.
3. For conducted measurements (Output Power, 6dB Emission Bandwidth, Power Spectral Density, Spurious Emissions), the antenna of EUT is connected to the test equipment via temporary antenna connector, the antenna connector is soldered on the antenna port of EUT, and the temporary antenna connector is listed in the Test Instruments.

## 4. Facilities and Accreditations

### 4.1. Facilities

The test facility is recognized, certified, or accredited by the following organizations:

- FCC - Registration No.: 645098  
SHENZHEN TONGCE TESTING LAB  
Designation Number: CN1205

The testing lab has been registered and fully described in a report with the (FCC) Federal Communications Commission. The acceptance letter from the FCC is maintained in our files.

- IC - Registration No.: 10668A-1  
SHENZHEN TONGCE TESTING LAB  
CAB identifier: CN0031

The testing lab has been registered by Certification and Engineering Bureau of Industry Canada for radio equipment testing.

### 4.2. Location

SHENZHEN TONGCE TESTING LAB

Address: TCT Testing Industrial Park Fuqiao 5th Industrial Zone, Fuhai Street, Bao'an District Shenzhen, Guangdong, 518103, People's Republic of China

TEL: +86-755-27673339

### 4.3. Measurement Uncertainty

The reported uncertainty of measurement  $y \pm U$ , where expanded uncertainty  $U$  is based on a standard uncertainty multiplied by a coverage factor of  $k=2$ , providing a level of confidence of approximately 95 %.

No.	Item	MU
1	Conducted Emission	$\pm 3.10$ dB
2	RF power, conducted	$\pm 0.12$ dB
3	Spurious emissions, conducted	$\pm 0.11$ dB
4	All emissions, radiated(<1 GHz)	$\pm 4.56$ dB
5	All emissions, radiated(1 GHz - 18 GHz)	$\pm 4.22$ dB
6	All emissions, radiated(18 GHz- 40 GHz)	$\pm 4.36$ dB



## 5. Test Results and Measurement Data

### 5.1. Antenna requirement

**Standard requirement:**

FCC Part15 C Section 15.203 /247(c)

15.203 requirement:

An intentional radiator shall be designed to ensure that no antenna other than that furnished by the responsible party shall be used with the device. The use of a permanently attached antenna or of an antenna that uses a unique coupling to the intentional radiator, the manufacturer may design the unit so that a broken antenna can be replaced by the user, but the use of a standard antenna jack or electrical connector is prohibited.

15.247(c) (1)(i) requirement:

(i) Systems operating in the 2400-2483.5 MHz band that is used exclusively for fixed. Point-to-point operations may employ transmitting antennas with directional gain greater than 6dBi provided the maximum conducted output power of the intentional radiator is reduced by 1 dB for every 3 dB that the directional gain of the antenna exceeds 6dBi.

**E.U.T Antenna:**

The WIFI antenna is external antenna which permanently attached, and the best case gain of the antenna is 2.5dBi.

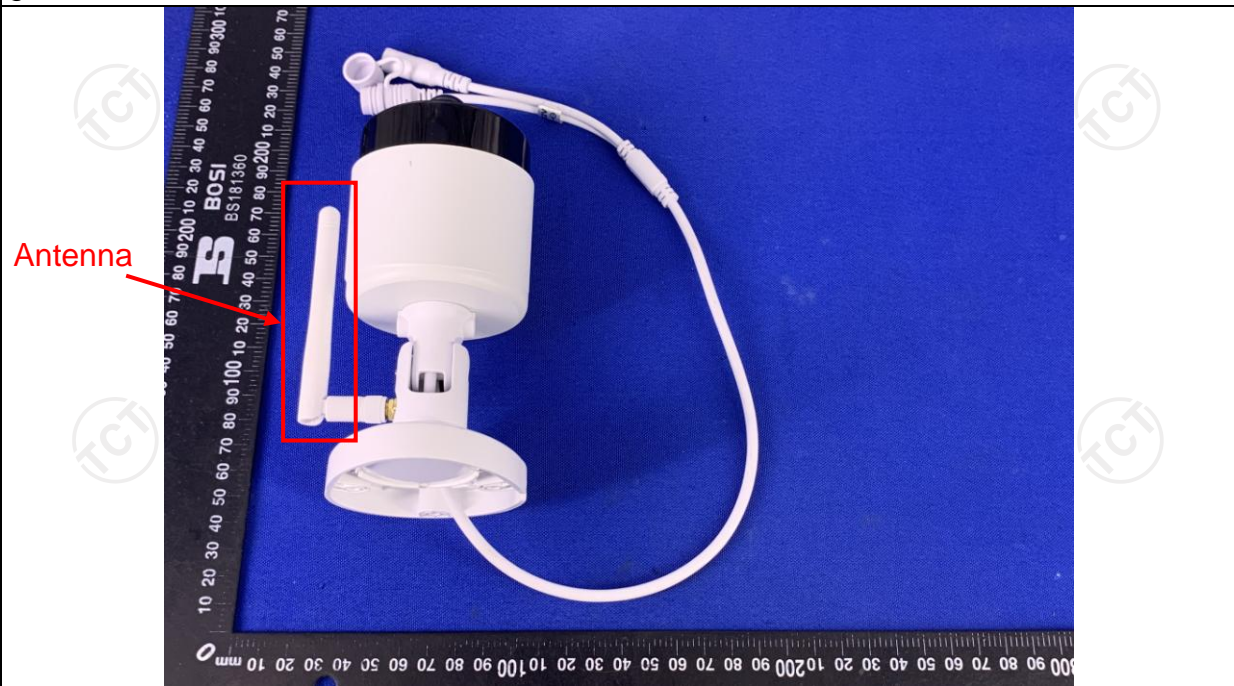

## 5.2. Conducted Emission

### 5.2.1. Test Specification

<b>Test Requirement:</b>	FCC Part15 C Section 15.207														
<b>Test Method:</b>	ANSI C63.10:2013														
<b>Frequency Range:</b>	150 kHz to 30 MHz														
<b>Receiver setup:</b>	RBW=9 kHz, VBW=30 kHz, Sweep time=auto														
<b>Limits:</b>	<table border="1"> <thead> <tr> <th rowspan="2">Frequency range (MHz)</th> <th colspan="2">Limit (dBuV)</th> </tr> <tr> <th>Quasi-peak</th> <th>Average</th> </tr> </thead> <tbody> <tr> <td>0.15-0.5</td> <td>66 to 56*</td> <td>56 to 46*</td> </tr> <tr> <td>0.5-5</td> <td>56</td> <td>46</td> </tr> <tr> <td>5-30</td> <td>60</td> <td>50</td> </tr> </tbody> </table>	Frequency range (MHz)	Limit (dBuV)		Quasi-peak	Average	0.15-0.5	66 to 56*	56 to 46*	0.5-5	56	46	5-30	60	50
Frequency range (MHz)	Limit (dBuV)														
	Quasi-peak	Average													
0.15-0.5	66 to 56*	56 to 46*													
0.5-5	56	46													
5-30	60	50													
<b>Test Setup:</b>	<p><i>Remark</i> E.U.T: Equipment Under Test LISN: Line Impedance Stabilization Network Test table height=0.8m</p>														
<b>Test Mode:</b>	Charging + transmitting with modulation														
<b>Test Procedure:</b>	<ol style="list-style-type: none"> <li>The E.U.T is connected to the main power through a line impedance stabilization network (L.I.S.N.). This provides a 50ohm/50uH coupling impedance for the measuring equipment.</li> <li>The peripheral devices are also connected to the main power through a LISN that provides a 50ohm/50uH coupling impedance with 50ohm termination. (Please refer to the block diagram of the test setup and photographs).</li> <li>Both sides of A.C. line are checked for maximum conducted interference. In order to find the maximum emission, the relative positions of equipment and all of the interface cables must be changed according to ANSI C63.10: 2013 on conducted measurement.</li> </ol>														
<b>Test Result:</b>	PASS														

**5.2.2. Test Instruments**

Conducted Emission Shielding Room Test Site (843)				
Equipment	Manufacturer	Model	Serial Number	Calibration Due
Test Receiver	R&S	ESCI3	100898	Jul. 07, 2022
LISN-2	Schwarzbeck	NSLK 8126	8126453	Sep. 11, 2021
Line-5	TCT	CE-05	N/A	Sep. 02, 2021
EMI Test Software	Shurple Technology	EZ-EMC	N/A	N/A

5.2.3. Test data

Please refer to following diagram for individual

Conducted Emission on Line Terminal of the power line (150 kHz to 30MHz)

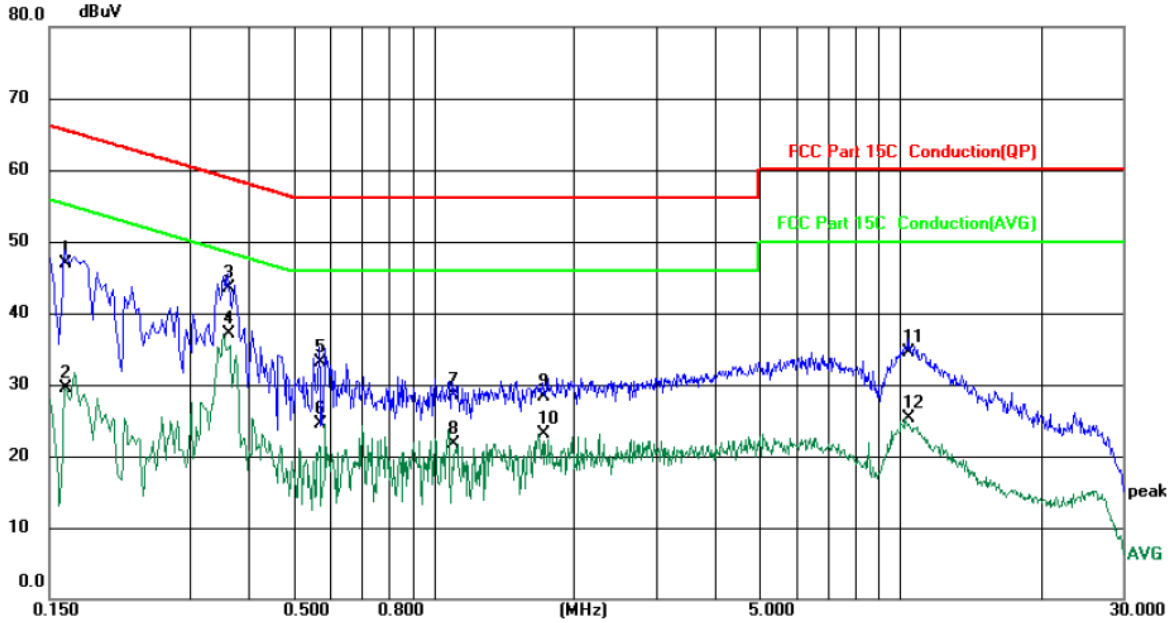

Site: Phase: **L1** Temperature: 28.7 (C)  
Limit: FCC Part 15C Conduction(QP) Power: AC 120 V/60 Hz Humidity: 52 %RH

No.	Mk.	Freq. MHz	Reading Level dBuV	Correct Factor dB	Measure- ment dBuV	Limit dBuV	Over dB	Detector	Comment
1		0.1620	37.44	9.44	46.88	65.36	-18.48	QP	
2		0.1620	20.13	9.44	29.57	55.36	-25.79	AVG	
3		0.3620	34.14	9.30	43.44	58.68	-15.24	QP	
4	*	0.3620	27.78	9.30	37.08	48.68	-11.60	AVG	
5		0.5700	23.96	9.24	33.20	56.00	-22.80	QP	
6		0.5700	15.21	9.24	24.45	46.00	-21.55	AVG	
7		1.0980	19.03	9.41	28.44	56.00	-27.56	QP	
8		1.0980	12.33	9.41	21.74	46.00	-24.26	AVG	
9		1.7100	18.85	9.47	28.32	56.00	-27.68	QP	
10		1.7100	13.61	9.47	23.08	46.00	-22.92	AVG	
11		10.4139	24.81	9.68	34.49	60.00	-25.51	QP	
12		10.4139	15.67	9.68	25.35	50.00	-24.65	AVG	

**Note:**

- Freq. = Emission frequency in MHz
- Reading level (dBuV) = Receiver reading
- Corr. Factor (dB) = LISN factor + Cable loss
- Measurement (dBuV) = Reading level (dBuV) + Corr. Factor (dB)
- Limit (dBuV) = Limit stated in standard
- Margin (dB) = Measurement (dBuV) – Limits (dBuV)
- Q.P. =Quasi-Peak
- AVG =average
- \* is meaning the worst frequency has been tested in the frequency range 150 kHz to 30MHz.

**Conducted Emission on Neutral Terminal of the power line (150 kHz to 30MHz)**

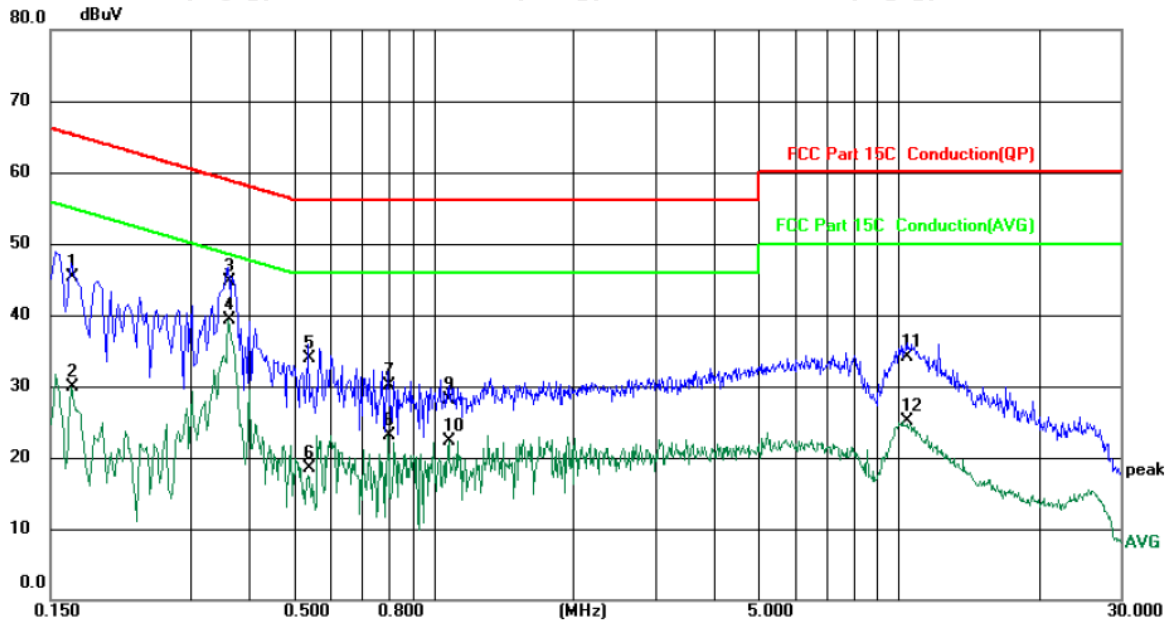

Site: Phase: **N** Temperature: 28.7 (C)  
Limit: FCC Part 15C Conduction(QP) Power: AC 120 V/60 Hz Humidity: 52 %RH

No.	Mk.	Freq. MHz	Reading Level dBuV	Correct Factor dB	Measure- ment dBuV	Limit dBuV	Over dB	Detector	Comment
1		0.1660	35.85	9.42	45.27	65.16	-19.89	QP	
2		0.1660	20.44	9.42	29.86	55.16	-25.30	AVG	
3		0.3620	35.39	9.33	44.72	58.68	-13.96	QP	
4	*	0.3620	30.04	9.33	39.37	48.68	-9.31	AVG	
5		0.5380	24.62	9.27	33.89	56.00	-22.11	QP	
6		0.5380	9.19	9.27	18.46	46.00	-27.54	AVG	
7		0.7980	20.85	9.31	30.16	56.00	-25.84	QP	
8		0.7980	13.81	9.31	23.12	46.00	-22.88	AVG	
9		1.0780	18.65	9.39	28.04	56.00	-27.96	QP	
10		1.0780	12.96	9.39	22.35	46.00	-23.65	AVG	
11		10.4379	24.48	9.69	34.17	60.00	-25.83	QP	
12		10.4379	15.37	9.69	25.06	50.00	-24.94	AVG	

**Note:**

Freq. = Emission frequency in MHz

Reading level (dBuV) = Receiver reading

Corr. Factor (dB) = LISN factor + Cable loss

Measurement (dBuV) = Reading level (dBuV) + Corr. Factor (dB)

Limit (dBuV) = Limit stated in standard

Margin (dB) = Measurement (dBuV) – Limits (dBuV)

Q.P. =Quasi-Peak

AVG =average

\* is meaning the worst frequency has been tested in the frequency range 150 kHz to 30MHz.

### 5.3. Maximum Conducted (Average) Output Power

#### 5.3.1. Test Specification

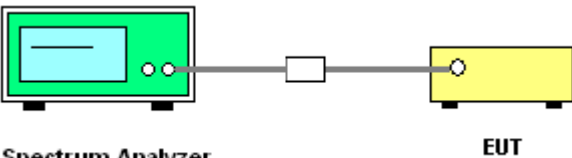
<b>Test Requirement:</b>	FCC Part15 C Section 15.247 (b)(3)
<b>Test Method:</b>	KDB 558074 D01 v05r02
<b>Limit:</b>	30dBm
<b>Test Setup:</b>	 <p style="text-align: center;">Spectrum Analyzer                      EUT</p>
<b>Test Mode:</b>	Transmitting mode with modulation
<b>Test Procedure:</b>	<ol style="list-style-type: none"> <li>1. The RF output of EUT was connected to the spectrum analyzer by RF cable and attenuator. The path loss was compensated to the results for each measurement.</li> <li>2. Set to the maximum power setting and enable the EUT transmit continuously.</li> <li>3. Measure the conducted output power and record the results in the test report.</li> </ol>
<b>Test Result:</b>	PASS

#### 5.3.2. Test Instruments

RF Test Room				
Equipment	Manufacturer	Model	Serial Number	Calibration Due
Spectrum Analyzer	Agilent	N9020A	MY49100619	Sep. 11, 2021
RF Cable (9KHz-26.5GHz)	TCT	RE-06	N/A	Sep. 11, 2021
Antenna Connector	TCT	RFC-01	N/A	Sep. 11, 2021

## 5.4. Emission Bandwidth

### 5.4.1. Test Specification

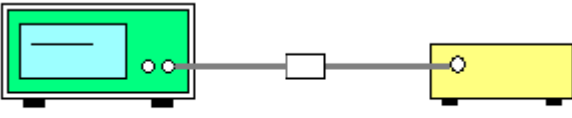
<b>Test Requirement:</b>	FCC Part15 C Section 15.247 (a)(2)
<b>Test Method:</b>	KDB 558074 D01 v05r02
<b>Limit:</b>	>500kHz
<b>Test Setup:</b>	 <p style="text-align: center;">Spectrum Analyzer                      EUT</p>
<b>Test Mode:</b>	Transmitting mode with modulation
<b>Test Procedure:</b>	<p>The testing follows:</p> <ol style="list-style-type: none"> <li>1. Set to the maximum power setting and enable the EUT transmit continuously.</li> <li>2. Make the measurement with the spectrum analyzer's resolution bandwidth (RBW) = 100 kHz. Set the Video bandwidth (VBW) = 300 kHz. In order to make an accurate measurement. The 6dB bandwidth must be greater than 500 kHz.</li> <li>3. Measure and record the results in the test report.</li> </ol>
<b>Test Result:</b>	PASS

### 5.4.2. Test Instruments

RF Test Room				
Equipment	Manufacturer	Model	Serial Number	Calibration Due
Spectrum Analyzer	Agilent	N9020A	MY49100619	Sep. 11, 2021
RF Cable (9KHz-26.5GHz)	TCT	RE-06	N/A	Sep. 11, 2021
Antenna Connector	TCT	RFC-01	N/A	Sep. 11, 2021

## 5.5. Power Spectral Density

### 5.5.1. Test Specification

<b>Test Requirement:</b>	FCC Part15 C Section 15.247 (e)
<b>Test Method:</b>	KDB 558074
<b>Limit:</b>	The peak power spectral density shall not be greater than 8dBm in any 3kHz band at any time interval of continuous transmission.
<b>Test Setup:</b>	 <p style="text-align: center;">Spectrum Analyzer                      EUT</p>
<b>Test Mode:</b>	Transmitting mode with modulation
<b>Test Procedure:</b>	<ol style="list-style-type: none"> <li>1. The RF output of EUT was connected to the spectrum analyzer by RF cable and attenuator. The path loss was compensated to the results for each measurement.</li> <li>2. Set to the maximum power setting and enable the EUT transmit continuously.</li> <li>3. Make the measurement with the spectrum analyzer's resolution bandwidth (RBW): <math>3 \text{ kHz} \leq \text{RBW} \leq 100 \text{ kHz}</math>. Video bandwidth VBW <math>\geq 3 \times \text{RBW}</math>. Set the span to at least 1.5 times the OBW.</li> <li>4. Detector = RMS, Sweep time = auto couple.</li> <li>5. Employ trace averaging (RMS) mode over a minimum of 100 traces. Use the peak marker function to determine the maximum power level.</li> <li>6. Measure and record the results in the test report.</li> </ol>
<b>Test Result:</b>	PASS

### 5.5.2. Test Instruments

RF Test Room				
Equipment	Manufacturer	Model	Serial Number	Calibration Due
Spectrum Analyzer	Agilent	N9020A	MY49100619	Sep. 11, 2021
RF Cable (9KHz-26.5GHz)	TCT	RE-06	N/A	Sep. 11, 2021
Antenna Connector	TCT	RFC-01	N/A	Sep. 11, 2021



## 5.6. Conducted Band Edge and Spurious Emission Measurement

### 5.6.1. Test Specification

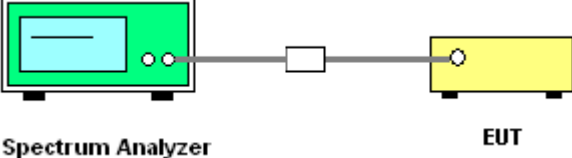
<b>Test Requirement:</b>	FCC Part15 C Section 15.247 (d)
<b>Test Method:</b>	KDB558074
<b>Limit:</b>	In any 100 kHz bandwidth outside of the authorized frequency band, the emissions which fall in the non-restricted bands shall be attenuated at least 20 dB / 30dB relative to the maximum PSD level in 100 kHz by RF conducted measurement and radiated emissions which fall in the restricted bands, as defined in Section 15.205(a), must also comply with the radiated emission limits specified in Section 15.209(a).
<b>Test Setup:</b>	 <p style="text-align: center;">Spectrum Analyzer                      EUT</p>
<b>Test Mode:</b>	Transmitting mode with modulation
<b>Test Procedure:</b>	<ol style="list-style-type: none"> <li>1. The RF output of EUT was connected to the spectrum analyzer by RF cable and attenuator. The path loss was compensated to the results for each measurement.</li> <li>2. Set to the maximum power setting and enable the EUT transmit continuously.</li> <li>3. Set RBW = 100 kHz, VBW=300 kHz, Peak Detector. Unwanted Emissions measured in any 100 kHz bandwidth outside of the authorized frequency band shall be attenuated by at least 20 dB relative to the maximum in-band peak PSD level in 100 kHz when maximum peak conducted output power procedure is used. If the transmitter complies with the conducted power limits based on the use of RMS averaging over a time interval, the attenuation required under this paragraph shall be 30 dB instead of 20 dB.</li> <li>4. Measure and record the results in the test report.</li> <li>5. The RF fundamental frequency should be excluded against the limit line in the operating frequency band.</li> </ol>
<b>Test Result:</b>	PASS

**5.6.2. Test Instruments**

RF Test Room				
Equipment	Manufacturer	Model	Serial Number	Calibration Due
Spectrum Analyzer	Agilent	N9020A	MY49100619	Sep. 11, 2021
RF Cable (9KHz-26.5GHz)	TCT	RE-06	N/A	Sep. 11, 2021
Antenna Connector	TCT	RFC-01	N/A	Sep. 11, 2021

## 5.7. Radiated Spurious Emission Measurement

### 5.7.1. Test Specification

<b>Test Requirement:</b>	FCC Part15 C Section 15.209																													
<b>Test Method:</b>	ANSI C63.10: 2013																													
<b>Frequency Range:</b>	9 kHz to 25 GHz																													
<b>Measurement Distance:</b>	3 m																													
<b>Antenna Polarization:</b>	Horizontal & Vertical																													
<b>Operation mode:</b>	Transmitting mode with modulation																													
<b>Receiver Setup:</b>	<table border="1"> <thead> <tr> <th>Frequency</th> <th>Detector</th> <th>RBW</th> <th>VBW</th> <th>Remark</th> </tr> </thead> <tbody> <tr> <td>9kHz- 150kHz</td> <td>Quasi-peak</td> <td>200Hz</td> <td>1kHz</td> <td>Quasi-peak Value</td> </tr> <tr> <td>150kHz- 30MHz</td> <td>Quasi-peak</td> <td>9kHz</td> <td>30kHz</td> <td>Quasi-peak Value</td> </tr> <tr> <td>30MHz-1GHz</td> <td>Quasi-peak</td> <td>120KHz</td> <td>300KHz</td> <td>Quasi-peak Value</td> </tr> <tr> <td rowspan="2">Above 1GHz</td> <td>Peak</td> <td>1MHz</td> <td>3MHz</td> <td>Peak Value</td> </tr> <tr> <td>Peak</td> <td>1MHz</td> <td>10Hz</td> <td>Average Value</td> </tr> </tbody> </table>	Frequency	Detector	RBW	VBW	Remark	9kHz- 150kHz	Quasi-peak	200Hz	1kHz	Quasi-peak Value	150kHz- 30MHz	Quasi-peak	9kHz	30kHz	Quasi-peak Value	30MHz-1GHz	Quasi-peak	120KHz	300KHz	Quasi-peak Value	Above 1GHz	Peak	1MHz	3MHz	Peak Value	Peak	1MHz	10Hz	Average Value
	Frequency	Detector	RBW	VBW	Remark																									
	9kHz- 150kHz	Quasi-peak	200Hz	1kHz	Quasi-peak Value																									
	150kHz- 30MHz	Quasi-peak	9kHz	30kHz	Quasi-peak Value																									
	30MHz-1GHz	Quasi-peak	120KHz	300KHz	Quasi-peak Value																									
Above 1GHz	Peak	1MHz	3MHz	Peak Value																										
	Peak	1MHz	10Hz	Average Value																										
<b>Limit:</b>	<b>General field strength limits at frequencies above 30 MHz</b>																													
	<table border="1"> <thead> <tr> <th>Frequency</th> <th>Field Strength (microvolts/meter)</th> <th>Measurement Distance (meters)</th> </tr> </thead> <tbody> <tr> <td>30-88</td> <td>100</td> <td>3</td> </tr> <tr> <td>88-216</td> <td>150</td> <td>3</td> </tr> <tr> <td>216-960</td> <td>200</td> <td>3</td> </tr> <tr> <td>Above 960</td> <td>500</td> <td>3</td> </tr> </tbody> </table>	Frequency	Field Strength (microvolts/meter)	Measurement Distance (meters)	30-88	100	3	88-216	150	3	216-960	200	3	Above 960	500	3														
	Frequency	Field Strength (microvolts/meter)	Measurement Distance (meters)																											
	30-88	100	3																											
	88-216	150	3																											
	216-960	200	3																											
	Above 960	500	3																											
<b>General field strength limits at frequencies below 30 MHz</b>																														
<table border="1"> <thead> <tr> <th>Frequency</th> <th>Magnetic field strength (H-Field) (<math>\mu</math>A/m)</th> <th>Measurement Distance (meters)</th> </tr> </thead> <tbody> <tr> <td>0.009-0 490</td> <td><math>6.37/F</math> (F in kHz)</td> <td>300</td> </tr> <tr> <td>0.490-1.705</td> <td><math>63.7/F</math> (F in kHz)</td> <td>30</td> </tr> <tr> <td>1.705-30</td> <td>0.08</td> <td>30</td> </tr> </tbody> </table>	Frequency	Magnetic field strength (H-Field) ( $\mu$ A/m)	Measurement Distance (meters)	0.009-0 490	$6.37/F$ (F in kHz)	300	0.490-1.705	$63.7/F$ (F in kHz)	30	1.705-30	0.08	30																		
Frequency	Magnetic field strength (H-Field) ( $\mu$ A/m)	Measurement Distance (meters)																												
0.009-0 490	$6.37/F$ (F in kHz)	300																												
0.490-1.705	$63.7/F$ (F in kHz)	30																												
1.705-30	0.08	30																												
<b>General field strength limits at frequencies above 1 GHz</b>																														
<table border="1"> <thead> <tr> <th>Frequency</th> <th>Field Strength (microvolts/meter)</th> <th>Measurement Distance (meters)</th> <th>Detector</th> </tr> </thead> <tbody> <tr> <td rowspan="2">Above 1GHz</td> <td>500</td> <td>3</td> <td>Average</td> </tr> <tr> <td>5000</td> <td>3</td> <td>Peak</td> </tr> </tbody> </table>	Frequency	Field Strength (microvolts/meter)	Measurement Distance (meters)	Detector	Above 1GHz	500	3	Average	5000	3	Peak																			
Frequency	Field Strength (microvolts/meter)	Measurement Distance (meters)	Detector																											
Above 1GHz	500	3	Average																											
	5000	3	Peak																											
<b>Test setup:</b>	For radiated emissions below 30MHz																													
	<p>30MHz to 1GHz</p>																													

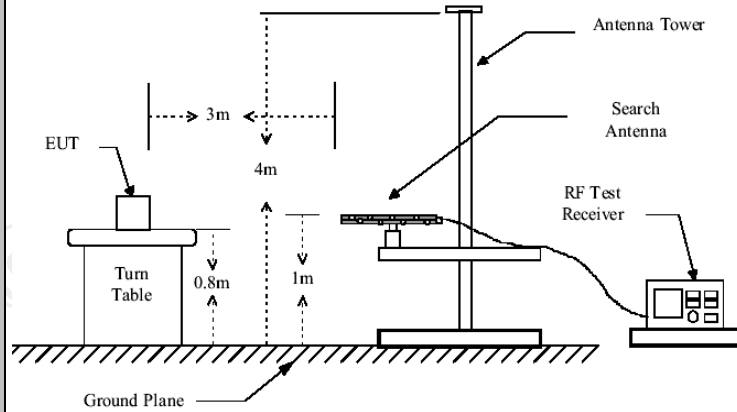

Above 1GHz

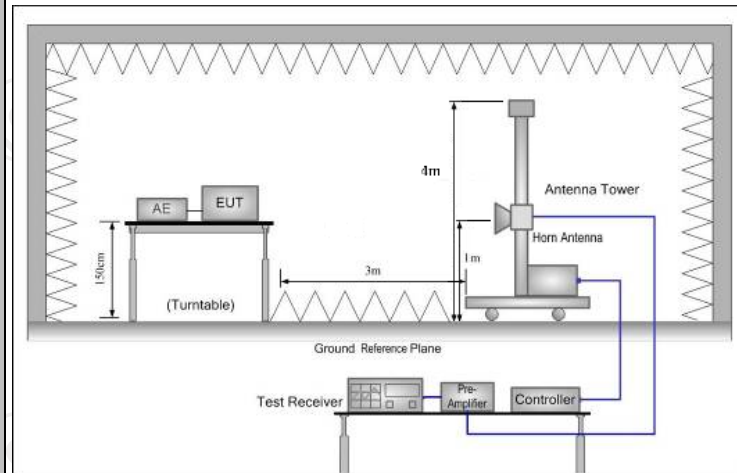

**Test Procedure:**

1. For the radiated emission test below 1GHz:  
The EUT was placed on a turntable with 0.8 meter above ground. The EUT was set 3 meters from the interference receiving antenna, which was mounted on the top of a variable height antenna tower. The EUT was arranged to its worst case and then tune the antenna tower (from 1 m to 4 m) and turntable (from 0 degree to 360 degrees) to find the maximum reading. A pre-amp and a high PASS filter are used for the test in order to get better signal level.
- For the radiated emission test above 1GHz:  
Place the measurement antenna on a turntable with 1.5 meter above ground, which is away from each area of the EUT determined to be a source of emissions at the specified measurement distance, while keeping the measurement antenna aimed at the source of emissions at each frequency of significant emissions, with polarization oriented for maximum response. The measurement antenna may have to be higher or lower than the EUT, depending on the radiation pattern of the emission and staying aimed at the emission source for receiving the maximum signal. The final measurement antenna elevation shall be that which

	<p>maximizes the emissions. The measurement antenna elevation for maximum emissions shall be restricted to a range of heights of from 1 m to 4 m above the ground or reference ground plane.</p> <p>3. Corrected Reading: Antenna Factor + Cable Loss + Read Level - Preamp Factor = Level</p> <p>4. For measurement below 1GHz, If the emission level of the EUT measured by the peak detector is 3 dB lower than the applicable limit, the peak emission level will be reported. Otherwise, the emission measurement will be repeated using the quasi-peak detector and reported.</p> <p>5. Use the following spectrum analyzer settings:</p> <p>(1) Span shall wide enough to fully capture the emission being measured;</p> <p>(2) Set RBW=120 kHz for <math>f &lt; 1</math> GHz; VBW <math>\geq</math> RBW; Sweep = auto; Detector function = peak; Trace = max hold;</p> <p>(3) Set RBW = 1 MHz, VBW= 3MHz for <math>f &gt; 1</math> GHz for peak measurement.</p> <p>For average measurement: VBW = 10 Hz, when duty cycle is no less than 98 percent. VBW <math>\geq 1/T</math>, when duty cycle is less than 98 percent where T is the minimum transmission duration over which the transmitter is on and is transmitting at its maximum power control level for the tested mode of operation.</p>
<b>Test results:</b>	PASS

5.7.2. Test Instruments

Radiated Emission Test Site (966)				
Name of Equipment	Manufacturer	Model	Serial Number	Calibration Due
Test Receiver	ROHDE&SCHW ARZ	ESIB7	100197	Jul. 07, 2022
Spectrum Analyzer	ROHDE&SCHW ARZ	FSQ40	200061	Sep. 11, 2021
Pre-amplifier	EM Electronics Corporation CO.,LTD	EM30265	07032613	Sep. 02, 2021
Pre-amplifier	HP	8447D	2727A05017	Sep. 02, 2021
Loop antenna	ZHINAN	ZN30900A	12024	Sep. 05, 2022
Broadband Antenna	Schwarzbeck	VULB9163	340	Sep. 04, 2022
Horn Antenna	Schwarzbeck	BBHA 9120D	631	Sep. 04, 2022
Horn Antenna	A-INFO	LB-180400-KF	J211020657	Sep. 04, 2022
Antenna Mast	Keleto	RE-AM	N/A	N/A
Line-4	TCT	RE-high-04	N/A	Sep. 02, 2021
Line-8	TCT	RE-01	N/A	Sep. 02, 2021
EMI Test Software	Shurple Technology	EZ-EMC	N/A	N/A

**5.7.3. Test Data**

Please refer to following diagram for individual  
Below 1GHz

Horizontal:

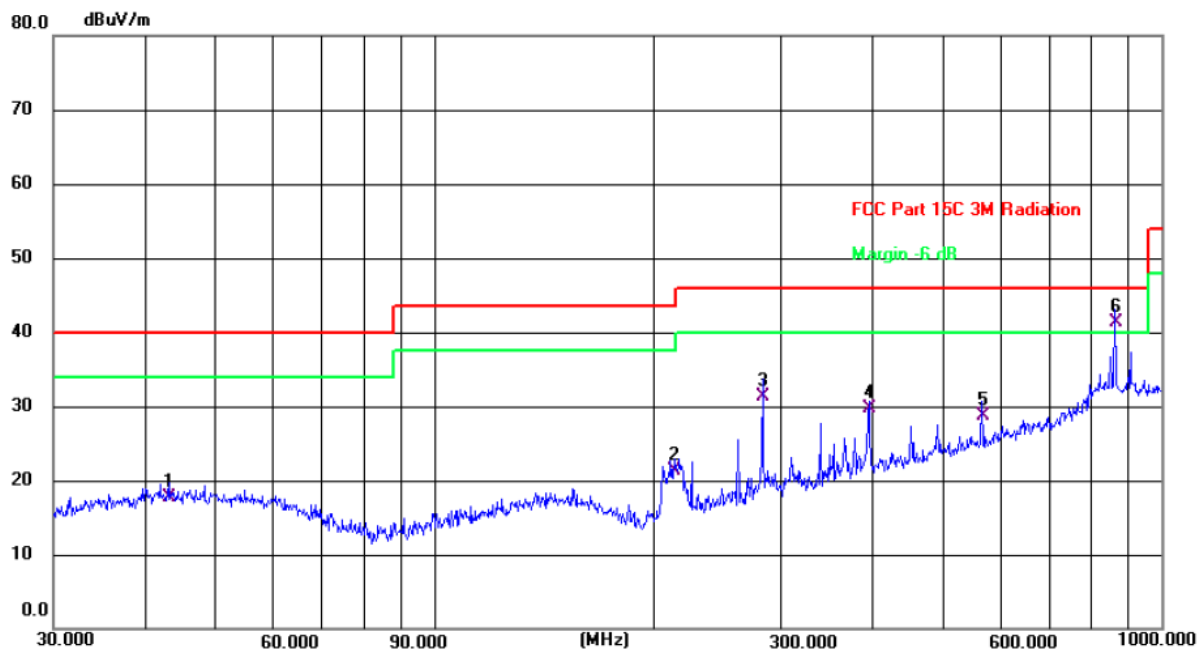

Site: Polarization: *Horizontal* Temperature: 24.6(C)  
Limit: FCC Part 15C 3M Radiation Power: AC 120V/60Hz Humidity: 39 %

No.	Frequency (MHz)	Reading (dBuV)	Factor (dB/m)	Level (dBuV/m)	Limit (dBuV/m)	Margin (dB)	Detector	P/F
1	43.2017	3.72	13.93	17.65	40.00	-22.35	QP	P
2	213.7634	10.22	11.08	21.30	43.50	-22.20	QP	P
3	282.9852	17.23	14.13	31.36	46.00	-14.64	QP	P
4	396.2415	12.52	17.13	29.65	46.00	-16.35	QP	P
5	566.6223	8.06	20.63	28.69	46.00	-17.31	QP	P
6 *	863.0562	15.40	25.96	41.36	46.00	-4.64	QP	P

Vertical:

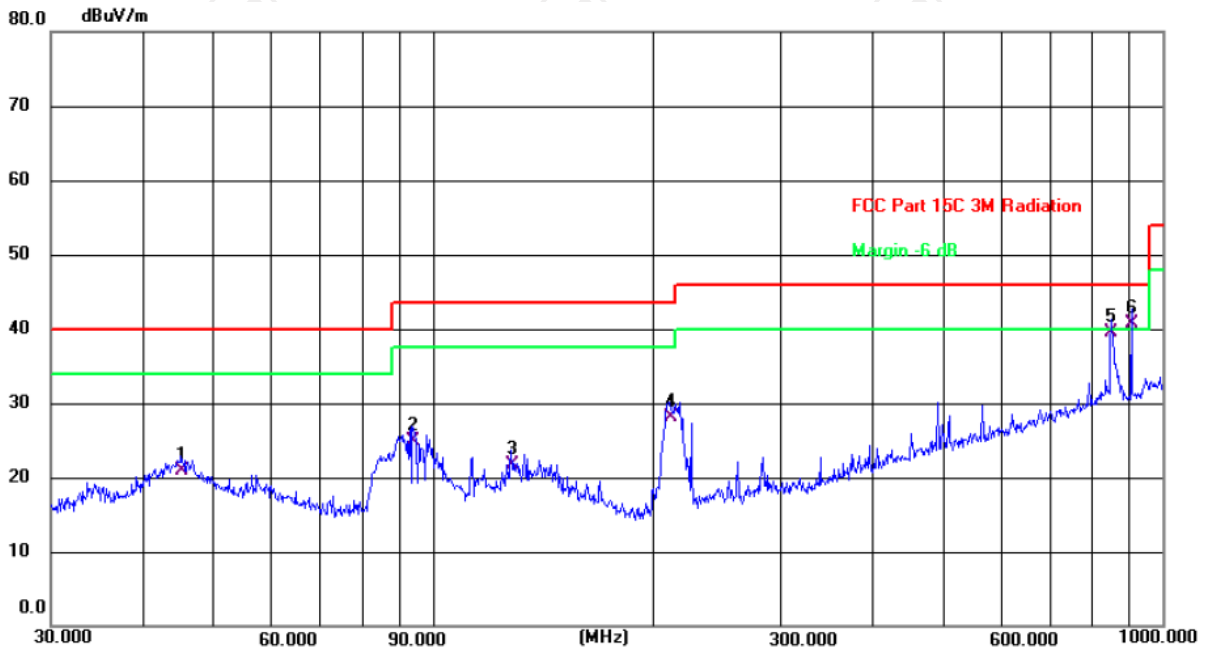

Site: Polarization: **Vertical** Temperature: 24.6(C)  
Limit: FCC Part 15C 3M Radiation Power: AC 120V/60Hz Humidity: 39%

No.	Frequency (MHz)	Reading (dBuV)	Factor (dB/m)	Level (dBuV/m)	Limit (dBuV/m)	Margin (dB)	Detector	P/F
1	45.2166	6.96	13.88	20.84	40.00	-19.16	QP	P
2	93.7685	15.33	9.67	25.00	43.50	-18.50	QP	P
3	128.1130	9.27	12.48	21.75	43.50	-21.75	QP	P
4	211.5265	17.26	10.94	28.20	43.50	-15.30	QP	P
5	851.0353	13.66	25.79	39.45	46.00	-6.55	QP	P
6 *	906.4824	14.08	26.55	40.63	46.00	-5.37	QP	P

**Note:** 1. The low frequency, which started from 9KHz~30MHz, was pre-scanned and the result which was 20dB lower than the limit line per 15.31(o) was not reported  
2. Measurements were conducted in all three channels (high, middle, low) and all modulation(802.11b, 802.11g, 802.11n(HT20)), and the worst case Mode (Middle channel and 802.11b) was submitted only.  
3. Freq. = Emission frequency in MHz  
Measurement (dBuV/m) = Reading level (dBuV) + Corr. Factor (dB)  
Correction Factor= Antenna Factor + Cable loss – Pre-amplifier  
Limit (dBuV/m) = Limit stated in standard  
Margin (dB) = Measurement (dBuV/m) – Limits (dBuV/m)  
\* is meaning the worst frequency has been tested in the test frequency range



Test Result of Radiated Spurious at Band edges

Lowest channel 2412:

Horizontal:

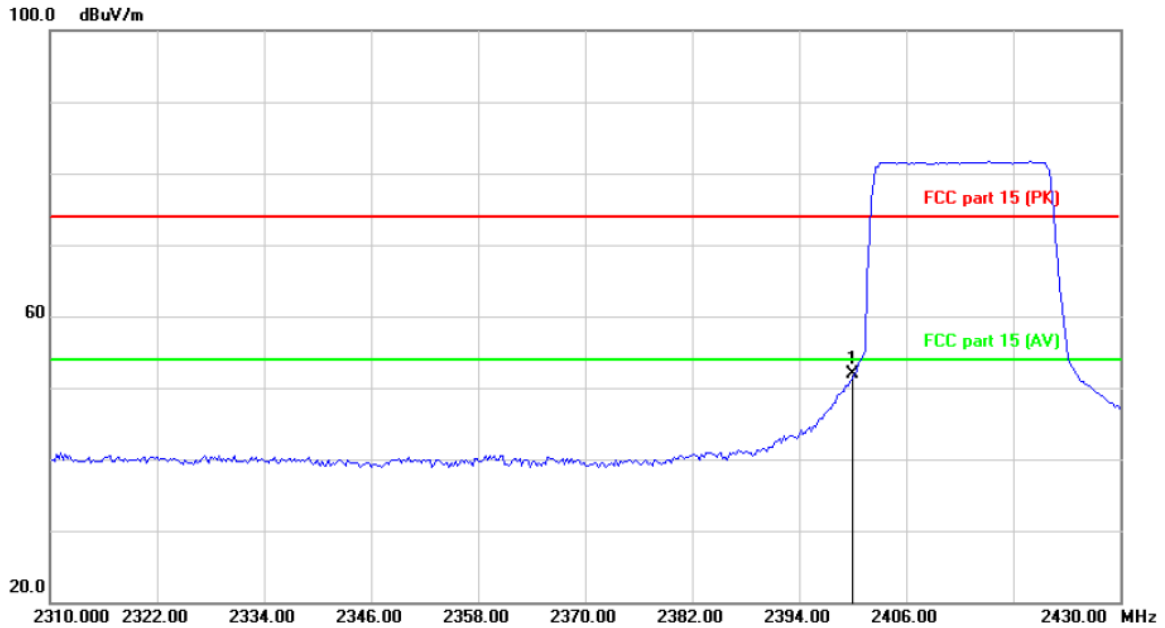

Site: Polarization: *Horizontal* Temperature: 25  
Limit: FCC part 15 (PK) Power: Humidity: 55 %

No.	Mk.	Freq.	Reading Level	Correct Factor	Measurement	Limit	Over	Detector
		MHz	dBuV	dB	dBuV/m	dB/m	dB	
1	*	2400.000	64.92	-13.02	51.90	74.00	-22.10	peak

Vertical:

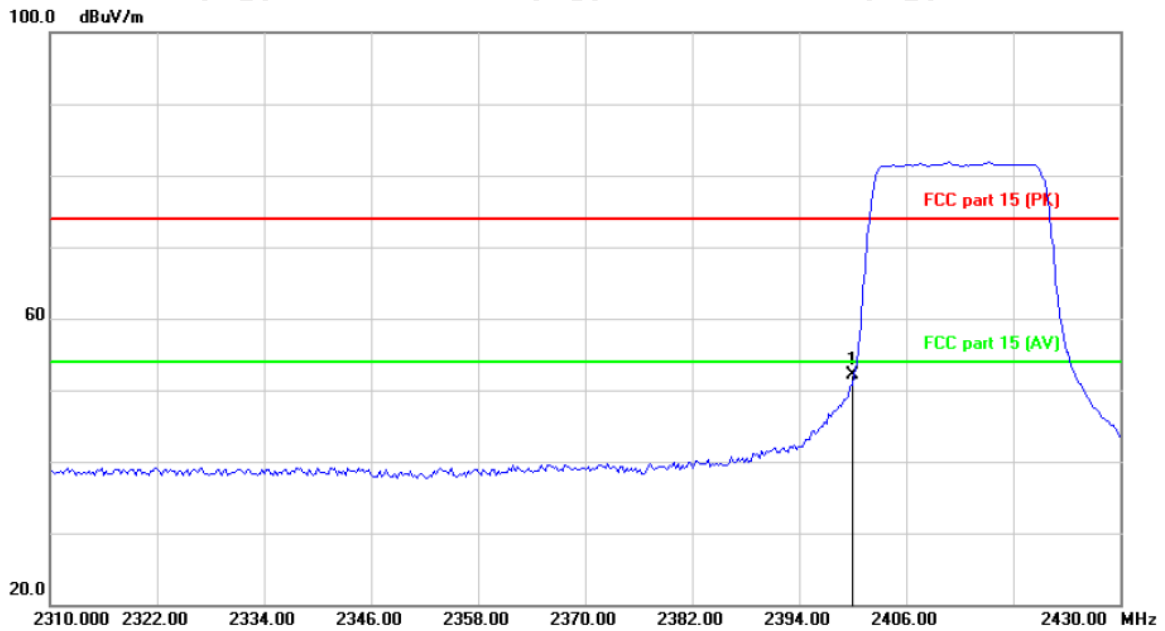

Site: Polarization: *Vertical* Temperature: 25  
 Limit: FCC part 15 (PK) Power: Humidity: 55 %

No.	Mk.	Freq.	Reading Level	Correct Factor	Measurement	Limit	Over	Detector
		MHz	dBuV	dB	dBuV/m	dB/m	dB	
1	*	2400.000	65.20	-13.12	52.08	74.00	-21.92	peak

Highest channel 2462:

Horizontal:

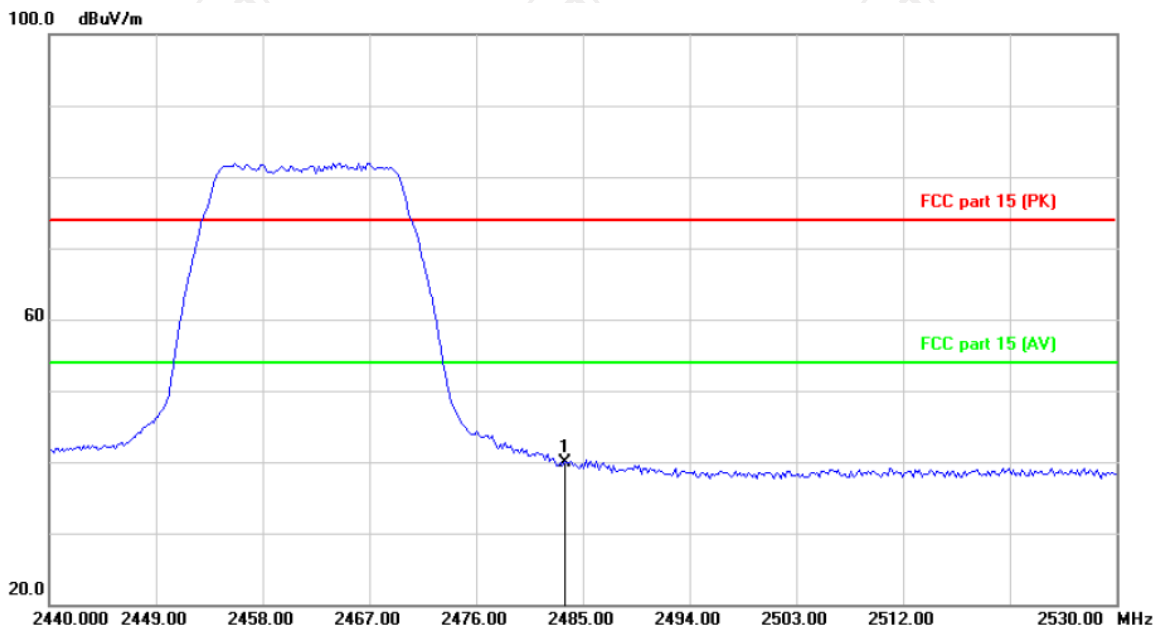

Site: Polarization: *Horizontal* Temperature: 25  
 Limit: FCC part 15 (PK) Power: Humidity: 55 %

No.	Mk.	Freq. MHz	Reading Level dBuV	Correct Factor dB	Measure- ment dBuV/m	Limit dB/m	Over dB	Detector
1	*	2483.500	52.83	-12.84	39.99	74.00	-34.01	peak

Vertical:

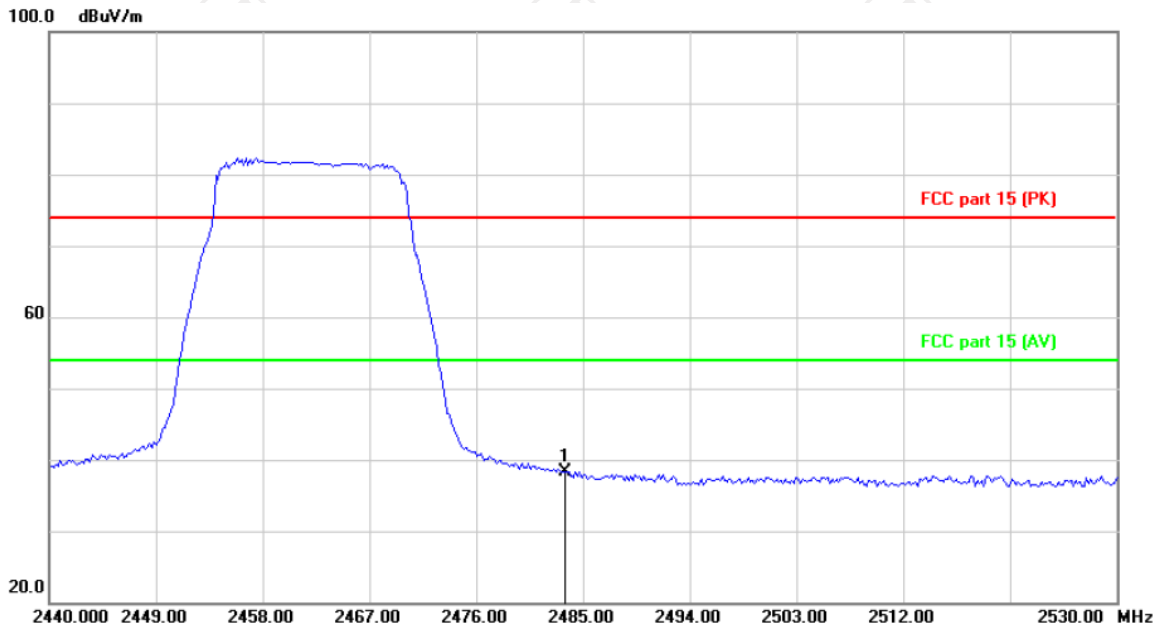

Site: Polarization: **Vertical** Temperature: 25  
Limit: FCC part 15 (PK) Power: Humidity: 55 %

No.	Mk.	Freq.	Reading Level	Correct Factor	Measurement	Limit	Over
		MHz	dBuV	dB	dBuV/m	dB/m	dB
1	*	2483.500	51.08	-12.84	38.24	74.00	-35.76
							peak

**Note:**

1. Peak Final Emission Level=Peak Reading + Correction Factor;
2. Correction Factor= Antenna Factor + Cable loss – Pre-amplifier
3. Measurements were conducted in all modulation(802.11b, 802.11g, 802.11n(HT20)), and the worst case Mode 802.11n(HT20) was submitted only.

## Above 1GHz

Modulation Type: 802.11b

Low channel: 2412 MHz

Frequency (MHz)	Ant. Pol. H/V	Peak reading (dB $\mu$ V)	AV reading (dB $\mu$ V)	Correction Factor (dB/m)	Emission Level		Peak limit (dB $\mu$ V/m)	AV limit (dB $\mu$ V/m)	Margin (dB)
					Peak (dB $\mu$ V/m)	AV (dB $\mu$ V/m)			
4824	H	48.12	---	0.75	48.87	---	74	54	-5.13
7236	H	40.05	---	9.87	49.92	---	74	54	-4.08
---	H	---	---	---	---	---	---	---	---
4824	V	46.48	---	0.75	47.23	---	74	54	-6.77
7236	V	39.02	---	9.87	48.89	---	74	54	-5.11
---	V	---	---	---	---	---	---	---	---

Middle channel: 2437MHz

Frequency (MHz)	Ant. Pol. H/V	Peak reading (dB $\mu$ V)	AV reading (dB $\mu$ V)	Correction Factor (dB/m)	Emission Level		Peak limit (dB $\mu$ V/m)	AV limit (dB $\mu$ V/m)	Margin (dB)
					Peak (dB $\mu$ V/m)	AV (dB $\mu$ V/m)			
4874	H	47.76	---	0.97	48.73	---	74	54	-5.27
7311	H	40.35	---	9.83	50.18	---	74	54	-3.82
---	H	---	---	---	---	---	---	---	---
4874	V	47.96	---	0.97	48.93	---	74	54	-5.07
7311	V	37.11	---	9.83	46.94	---	74	54	-7.06
---	V	---	---	---	---	---	---	---	---

High channel: 2462 MHz

Frequency (MHz)	Ant. Pol. H/V	Peak reading (dB $\mu$ V)	AV reading (dB $\mu$ V)	Correction Factor (dB/m)	Emission Level		Peak limit (dB $\mu$ V/m)	AV limit (dB $\mu$ V/m)	Margin (dB)
					Peak (dB $\mu$ V/m)	AV (dB $\mu$ V/m)			
4924	H	48.59	---	1.18	49.77	---	74	54	-4.23
7386	H	37.71	---	10.07	47.78	---	74	54	-6.22
---	H	---	---	---	---	---	---	---	---
4924	V	47.02	---	1.18	48.20	---	74	54	-5.80
7386	V	39.76	---	10.07	49.83	---	74	54	-4.17
---	V	---	---	---	---	---	---	---	---

### Note:

1. Emission Level=Peak Reading + Correction Factor; Correction Factor= Antenna Factor + Cable loss – Pre-amplifier
2. Margin (dB) = Emission Level (Peak) (dB $\mu$ V/m)-Average limit (dB $\mu$ V/m)
3. The emission levels of other frequencies are very lower than the limit and not show in test report.
4. Measurements were conducted from 1 GHz to the 10th harmonic of highest fundamental frequency. The highest test frequency is 25GHz.
5. Data of measurement shown "----" in the above table mean that the reading of emissions is attenuated more than 20 dB below the limits or the field strength is too small to be measured.

Modulation Type: 802.11g

Low channel: 2412 MHz

Frequency (MHz)	Ant. Pol. H/V	Peak reading (dB $\mu$ V)	AV reading (dB $\mu$ V)	Correction Factor (dB/m)	Emission Level		Peak limit (dB $\mu$ V/m)	AV limit (dB $\mu$ V/m)	Margin (dB)
					Peak (dB $\mu$ V/m)	AV (dB $\mu$ V/m)			
4824	H	48.75	---	0.75	49.50	---	74	54	-4.50
7236	H	39.46	---	9.87	49.33	---	74	54	-4.67
---	H	---	---	---	---	---	---	---	---
4824	V	46.82	---	0.75	47.57	---	74	54	-6.43
7236	V	39.40	---	9.87	49.27	---	74	54	-4.73
---	V	---	---	---	---	---	---	---	---

Middle channel: 2437MHz

Frequency (MHz)	Ant. Pol. H/V	Peak reading (dB $\mu$ V)	AV reading (dB $\mu$ V)	Correction Factor (dB/m)	Emission Level		Peak limit (dB $\mu$ V/m)	AV limit (dB $\mu$ V/m)	Margin (dB)
					Peak (dB $\mu$ V/m)	AV (dB $\mu$ V/m)			
4874	H	47.48	---	0.97	48.45	---	74	54	-5.55
7311	H	39.73	---	9.83	49.56	---	74	54	-4.44
---	H	---	---	---	---	---	---	---	---
4874	V	47.12	---	0.97	48.09	---	74	54	-5.91
7311	V	40.38	---	9.83	50.21	---	74	54	-3.79
---	V	---	---	---	---	---	---	---	---

High channel: 2462 MHz

Frequency (MHz)	Ant. Pol. H/V	Peak reading (dB $\mu$ V)	AV reading (dB $\mu$ V)	Correction Factor (dB/m)	Emission Level		Peak limit (dB $\mu$ V/m)	AV limit (dB $\mu$ V/m)	Margin (dB)
					Peak (dB $\mu$ V/m)	AV (dB $\mu$ V/m)			
4924	H	46.78	---	1.18	47.96	---	74	54	-6.04
7386	H	38.02	---	10.07	48.09	---	74	54	-5.91
---	H	---	---	---	---	---	---	---	---
4924	V	45.81	---	1.18	46.99	---	74	54	-7.01
7386	V	34.05	---	10.07	44.12	---	74	54	-9.88
---	V	---	---	---	---	---	---	---	---

**Note:**

1. Emission Level=Peak Reading + Correction Factor; Correction Factor= Antenna Factor + Cable loss – Pre-amplifier
2. Margin (dB) = Emission Level (Peak) (dB $\mu$ V/m)-Average limit (dB $\mu$ V/m)
3. The emission levels of other frequencies are very lower than the limit and not show in test report.
4. Measurements were conducted from 1 GHz to the 10th harmonic of highest fundamental frequency. The highest test frequency is 25GHz.
5. Data of measurement shown “---“in the above table mean that the reading of emissions is attenuated more than 20 dB below the limits or the field strength is too small to be measured.

Modulation Type: 802.11n (HT20)

Low channel: 2412 MHz

Frequency (MHz)	Ant. Pol. H/V	Peak reading (dB $\mu$ V)	AV reading (dB $\mu$ V)	Correction Factor (dB/m)	Emission Level		Peak limit (dB $\mu$ V/m)	AV limit (dB $\mu$ V/m)	Margin (dB)
					Peak (dB $\mu$ V/m)	AV (dB $\mu$ V/m)			
4824	H	49.41	---	0.75	50.16	---	74	54	-3.84
7236	H	39.82	---	9.87	49.69	---	74	54	-4.31
---	H	---	---	---	---	---	---	---	---
4824	V	46.97	---	0.75	47.72	---	74	54	-6.28
7236	V	39.48	---	9.87	49.35	---	74	54	-4.65
---	V	---	---	---	---	---	---	---	---

Middle channel: 2437MHz

Frequency (MHz)	Ant. Pol. H/V	Peak reading (dB $\mu$ V)	AV reading (dB $\mu$ V)	Correction Factor (dB/m)	Emission Level		Peak limit (dB $\mu$ V/m)	AV limit (dB $\mu$ V/m)	Margin (dB)
					Peak (dB $\mu$ V/m)	AV (dB $\mu$ V/m)			
4874	H	47.20	---	0.97	48.17	---	74	54	-5.83
7311	H	39.33	---	9.83	49.16	---	74	54	-4.84
---	H	---	---	---	---	---	---	---	---
4874	V	47.09	---	0.97	48.06	---	74	54	-5.94
7311	V	38.86	---	9.83	48.69	---	74	54	-5.31
---	V	---	---	---	---	---	---	---	---

High channel: 2462 MHz

Frequency (MHz)	Ant. Pol. H/V	Peak reading (dB $\mu$ V)	AV reading (dB $\mu$ V)	Correction Factor (dB/m)	Emission Level		Peak limit (dB $\mu$ V/m)	AV limit (dB $\mu$ V/m)	Margin (dB)
					Peak (dB $\mu$ V/m)	AV (dB $\mu$ V/m)			
4924	H	48.24	---	1.18	49.42	---	74	54	-4.58
7386	H	39.58	---	10.07	49.65	---	74	54	-4.35
---	H	---	---	---	---	---	---	---	---
4924	V	46.99	---	1.18	48.17	---	74	54	-5.83
7386	V	40.10	---	10.07	50.17	---	74	54	-3.83
---	V	---	---	---	---	---	---	---	---

**Note:**

1. Emission Level=Peak Reading + Correction Factor; Correction Factor= Antenna Factor + Cable loss – Pre-amplifier
2. Margin (dB) = Emission Level (Peak) (dB $\mu$ V/m)-Average limit (dB $\mu$ V/m)
3. The emission levels of other frequencies are very lower than the limit and not show in test report.
4. Measurements were conducted from 1 GHz to the 10th harmonic of highest fundamental frequency. The highest test frequency is 25GHz.
5. Data of measurement shown “---“in the above table mean that the reading of emissions is attenuated more than 20 dB below the limits or the field strength is too small to be measured.

## Appendix A: Test Result of Conducted Test

### DTS Bandwidth

#### Test Result

Test Mode	Channel	DTS BW [MHz]	FL [MHz]	FH [MHz]	Limit [MHz]	Verdict
11B	2412	9.160	2407.440	2416.600	0.5	PASS
	2437	8.640	2432.480	2441.120	0.5	PASS
	2462	9.080	2457.480	2466.560	0.5	PASS
11G	2412	16.600	2403.720	2420.320	0.5	PASS
	2437	16.600	2428.720	2445.320	0.5	PASS
	2462	16.560	2453.760	2470.320	0.5	PASS
11N20SISO	2412	17.840	2403.120	2420.960	0.5	PASS
	2437	17.800	2428.160	2445.960	0.5	PASS
	2462	17.800	2453.120	2470.920	0.5	PASS

#### Test Graphs

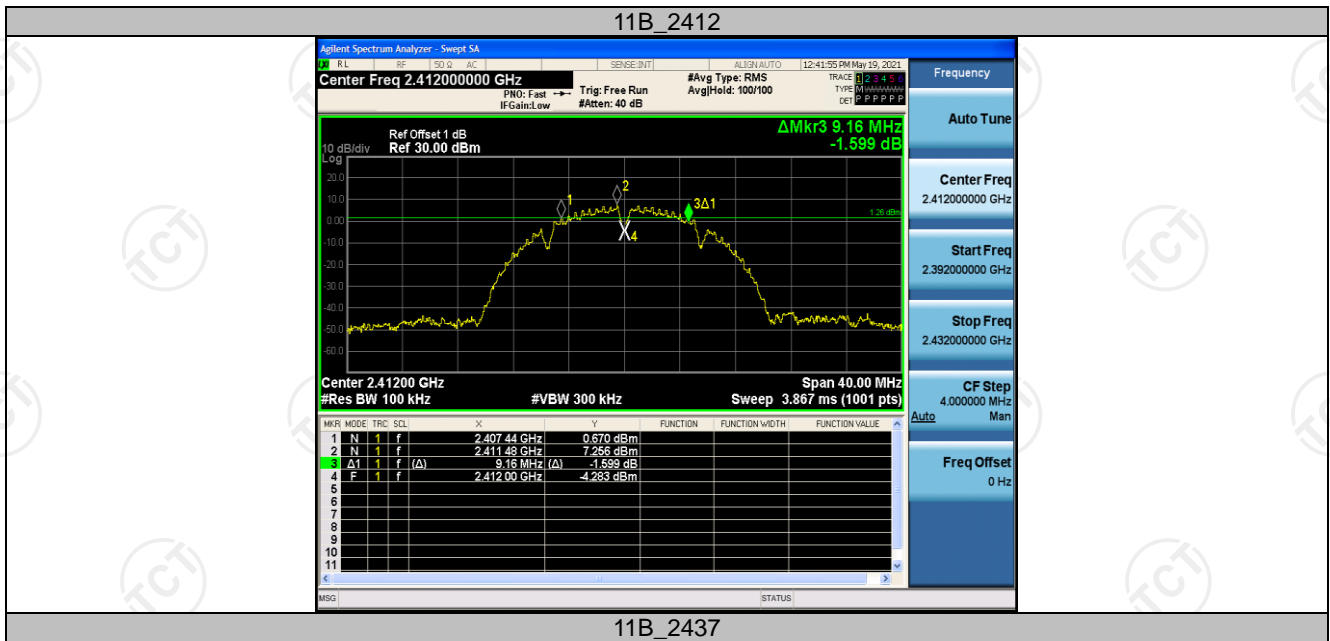





11B\_2462

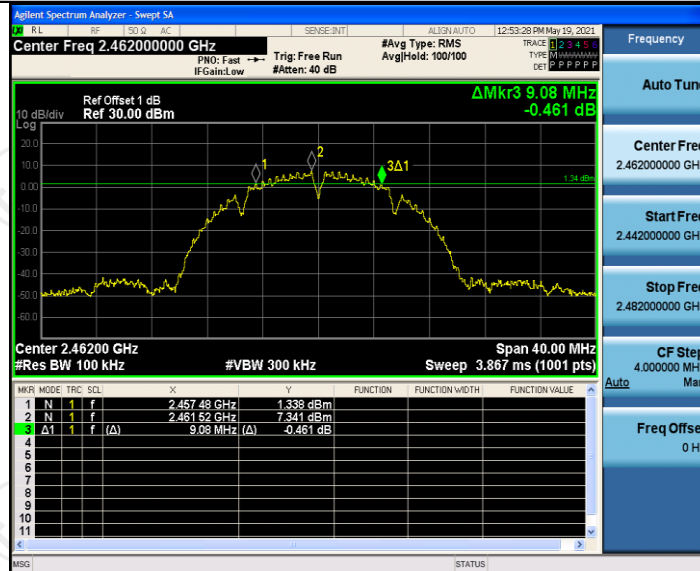

11G\_2412

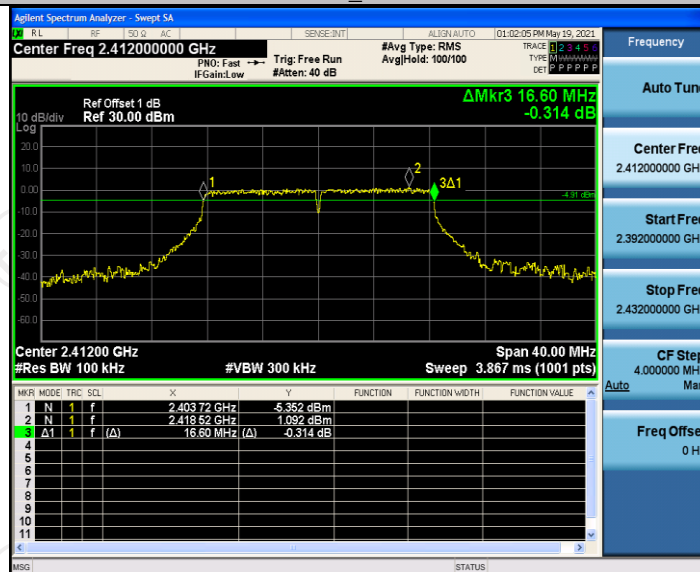

11G\_2437

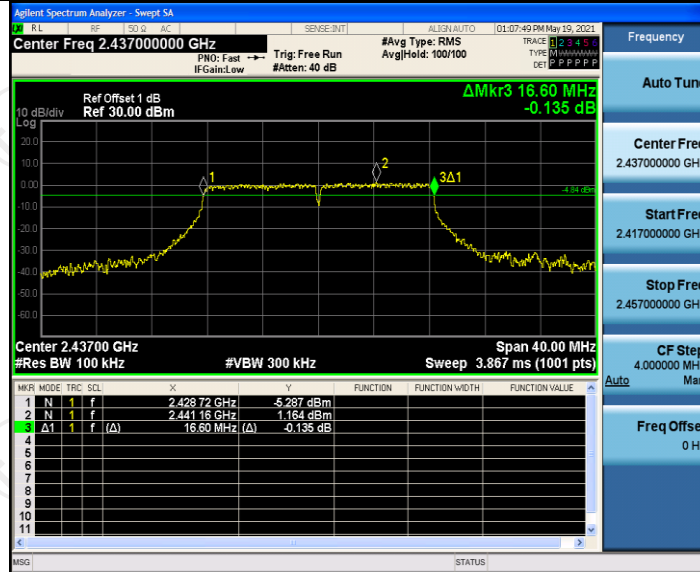

11G\_2462

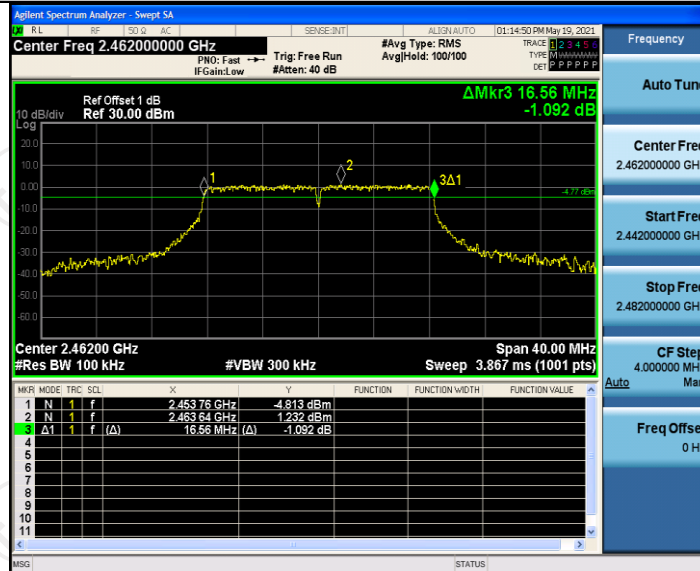

11N20SISO\_2412

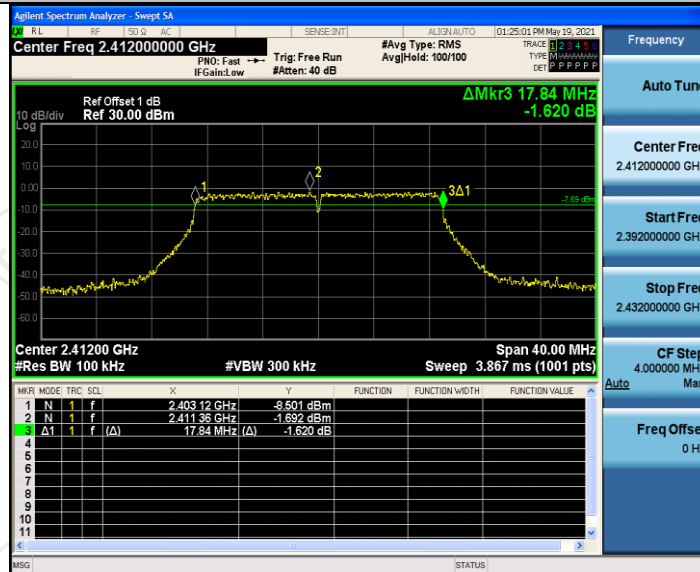

11N20SISO\_2437

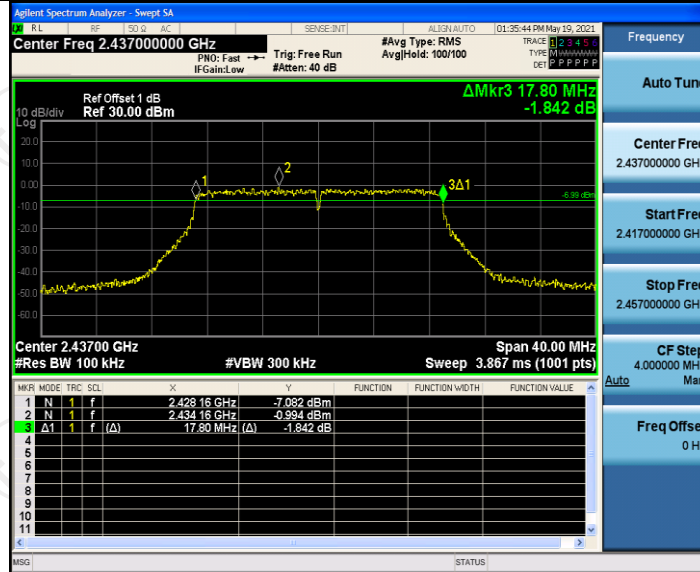

11N20SISO\_2462

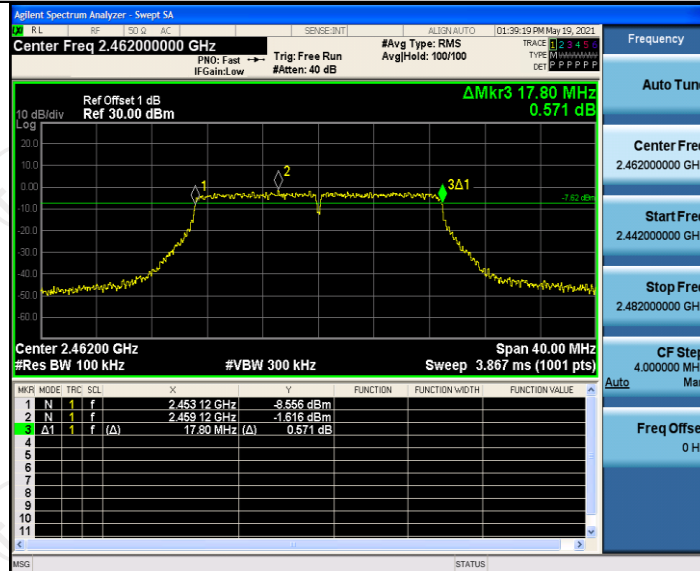

## Maximum conducted output power

### Test Result

Test Mode	Channel	Result [dBm]	Limit[dBm]	Verdict
11B	2412	16.47	<=30	PASS
	2437	16.64	<=30	PASS
	2462	16.52	<=30	PASS
11G	2412	15.32	<=30	PASS
	2437	15.48	<=30	PASS
	2462	15.59	<=30	PASS
11N20SISO	2412	12.82	<=30	PASS
	2437	13.01	<=30	PASS
	2462	12.49	<=30	PASS

### Test Graphs



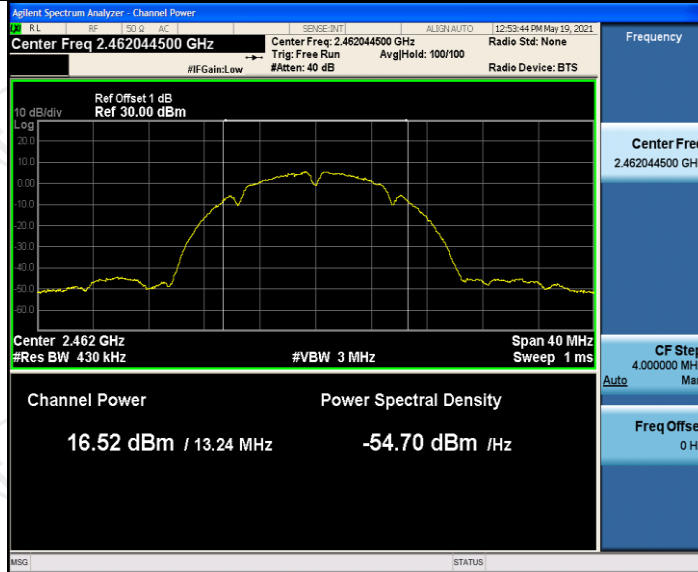

11G\_2412

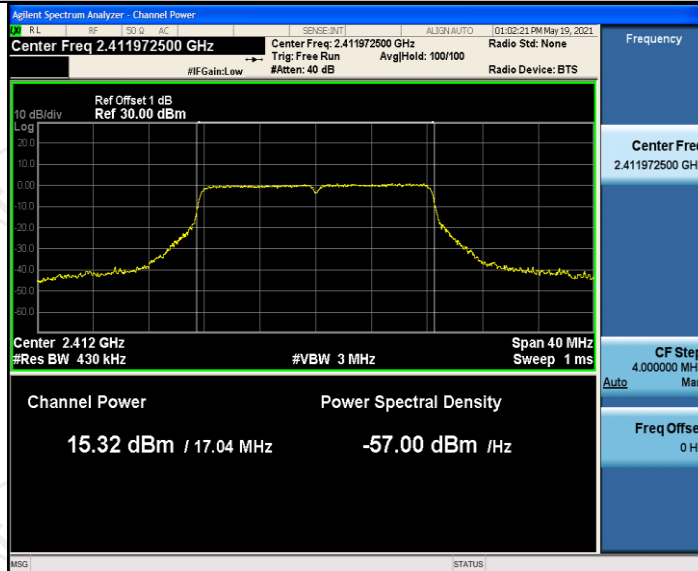

11G\_2437

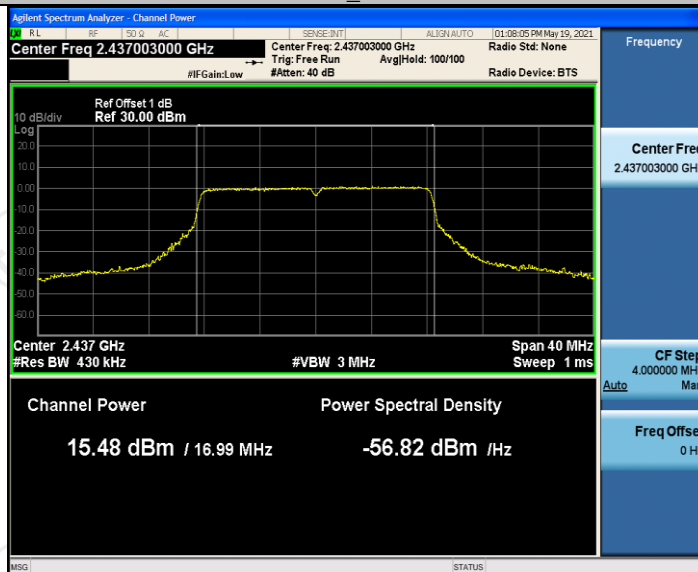

11G\_2462

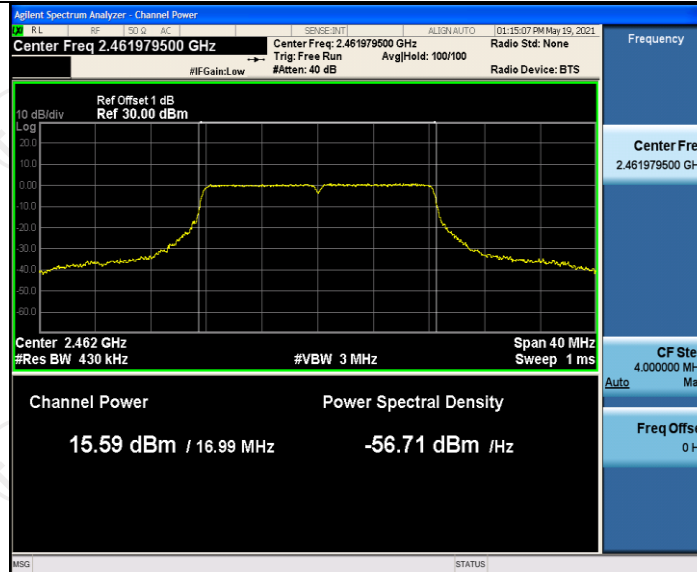

11N20SISO\_2412

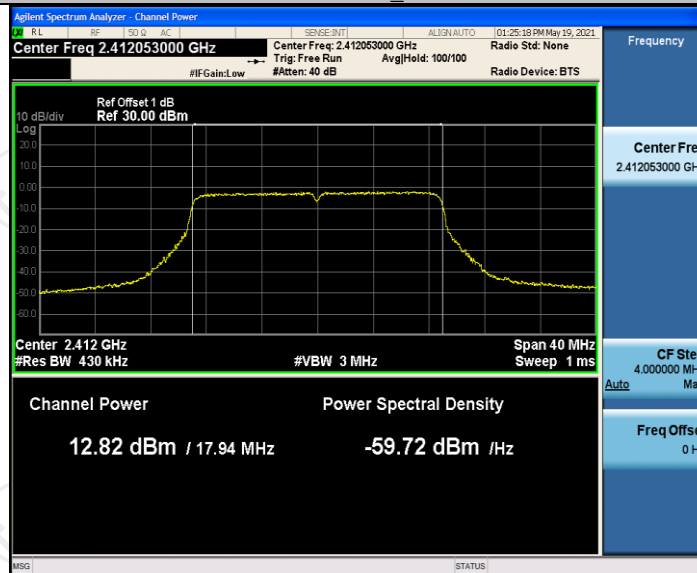

11N20SISO\_2437

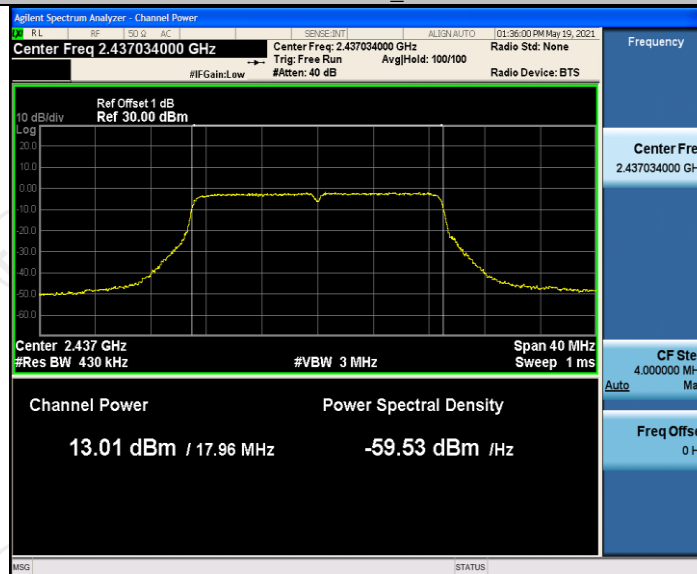

11N20SISO\_2462

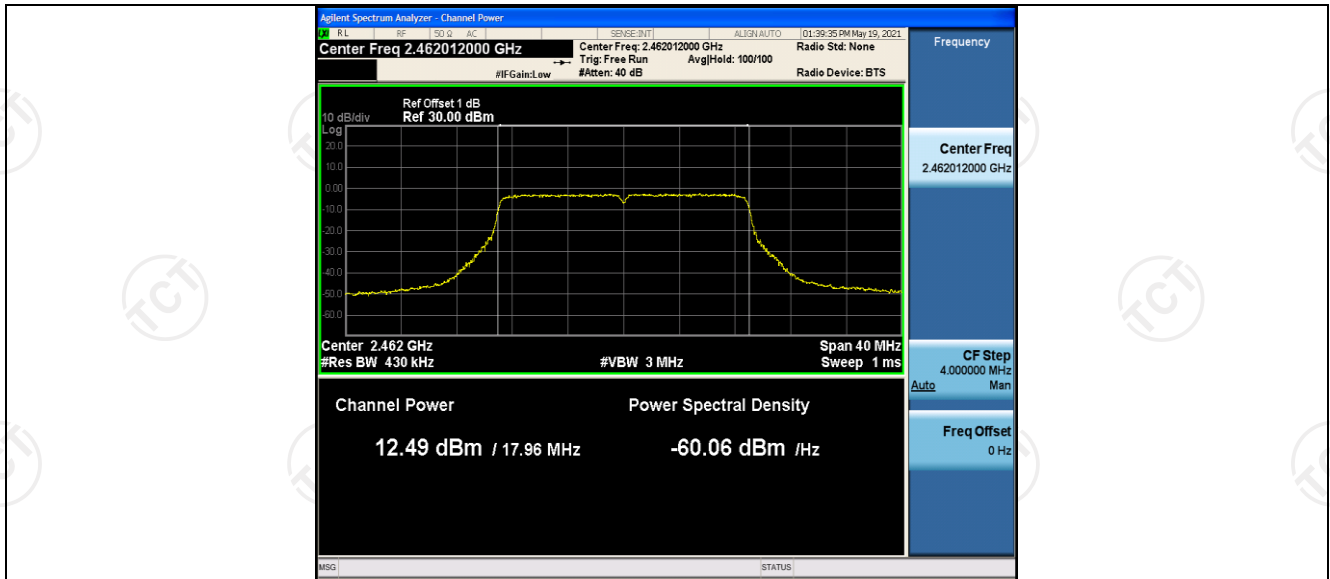

### Maximum power spectral density

#### 5.7.4. Test Result

Test Mode	Channel	Result [dBm/10kHz]	Result [dBm/3kHz]	Limit [dBm/3kHz]	Verdict
11B	2412	-9.48	-14.71	<=8	PASS
	2437	-9.38	-14.61	<=8	PASS
	2462	-9.55	-14.78	<=8	PASS
11G	2412	-13.32	-18.55	<=8	PASS
	2437	-12.17	-17.40	<=8	PASS
	2462	-12.98	-18.21	<=8	PASS
11N20SISO	2412	-15.49	-20.72	<=8	PASS
	2437	-15.45	-20.68	<=8	PASS
	2462	-16.49	-21.72	<=8	PASS

#### Test Graphs

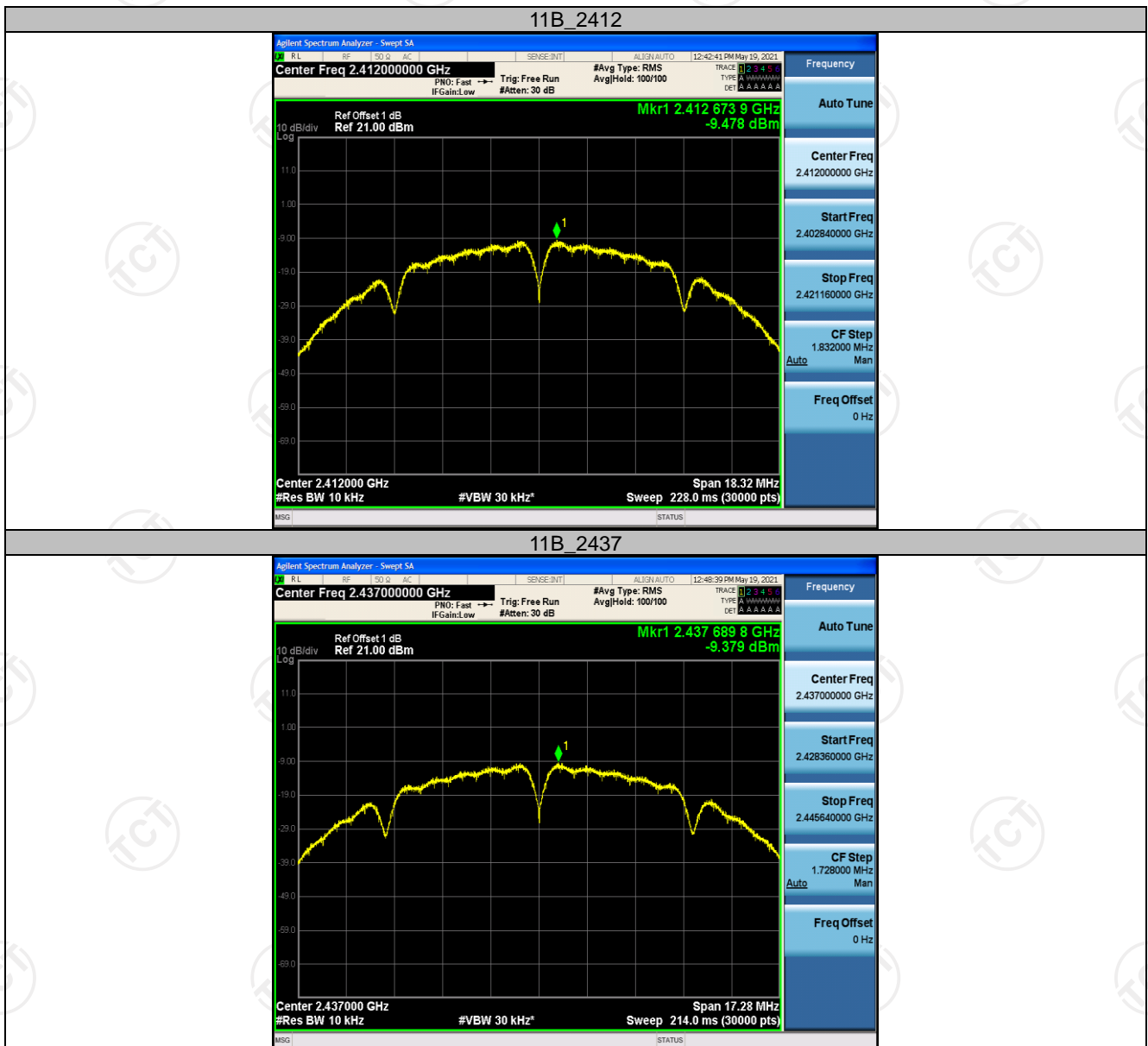



11B\_2462



11G\_2412

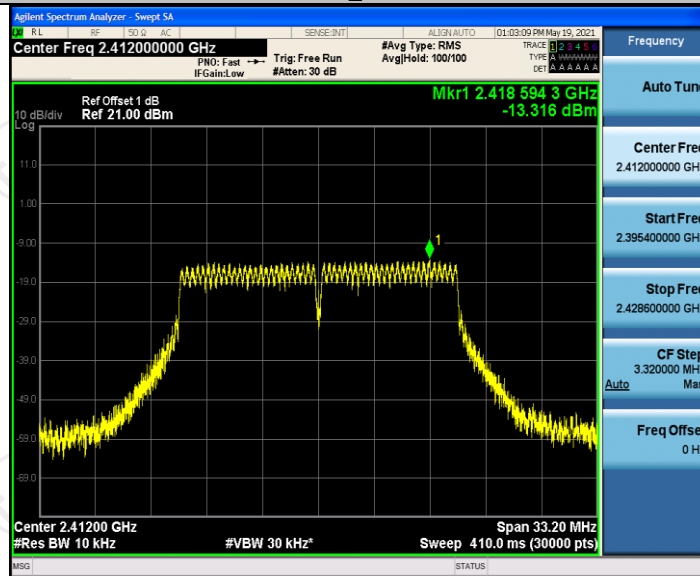

11G\_2437

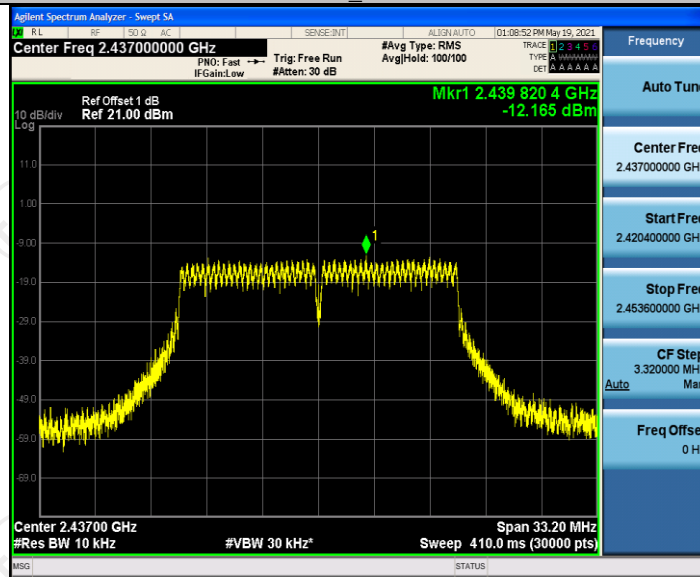

11G\_2462

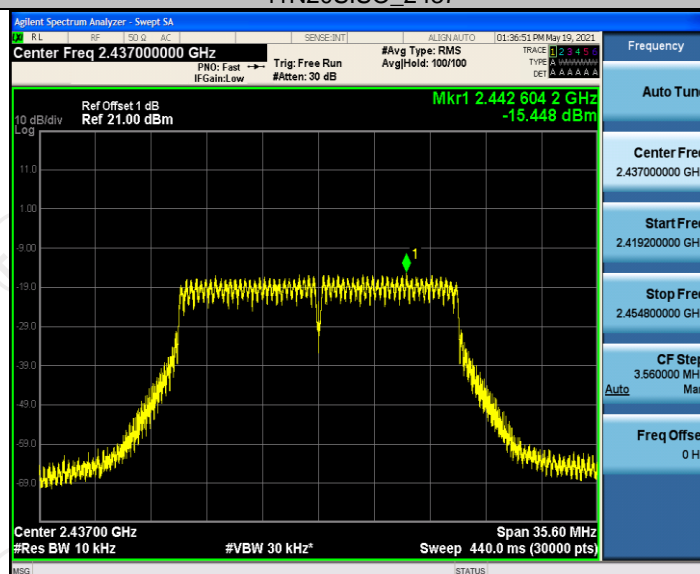
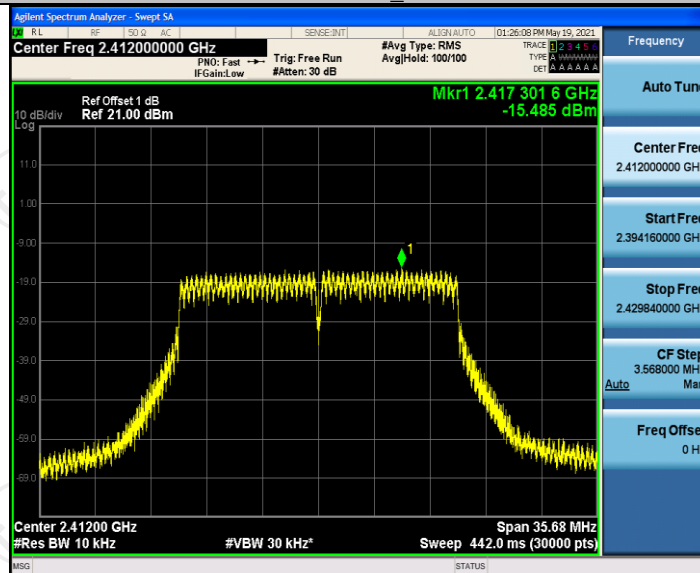
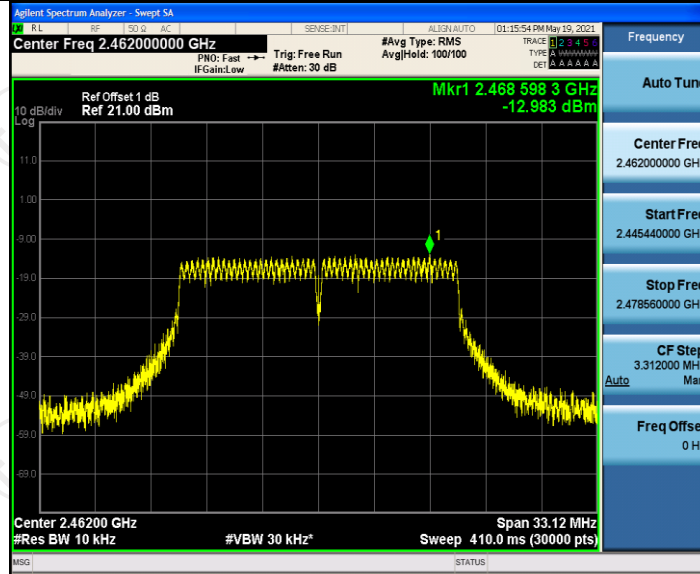



## Band edge measurements

### Test Result

Test Mode	Ch Name	Channel	Ref Level [dBm]	Result [dBm]	Limit [dBm]	Verdict
11B	Low	2412	7.25	-45.41	<=-22.75	PASS
	High	2462	7.29	-51.67	<=-22.71	PASS
11G	Low	2412	1.09	-32.74	<=-28.91	PASS
	High	2462	1.24	-36.21	<=-28.76	PASS
11N20SISO	Low	2412	-1.24	-38.74	<=-31.24	PASS
	High	2462	-1.53	-48.05	<=-31.53	PASS

### Test Graphs

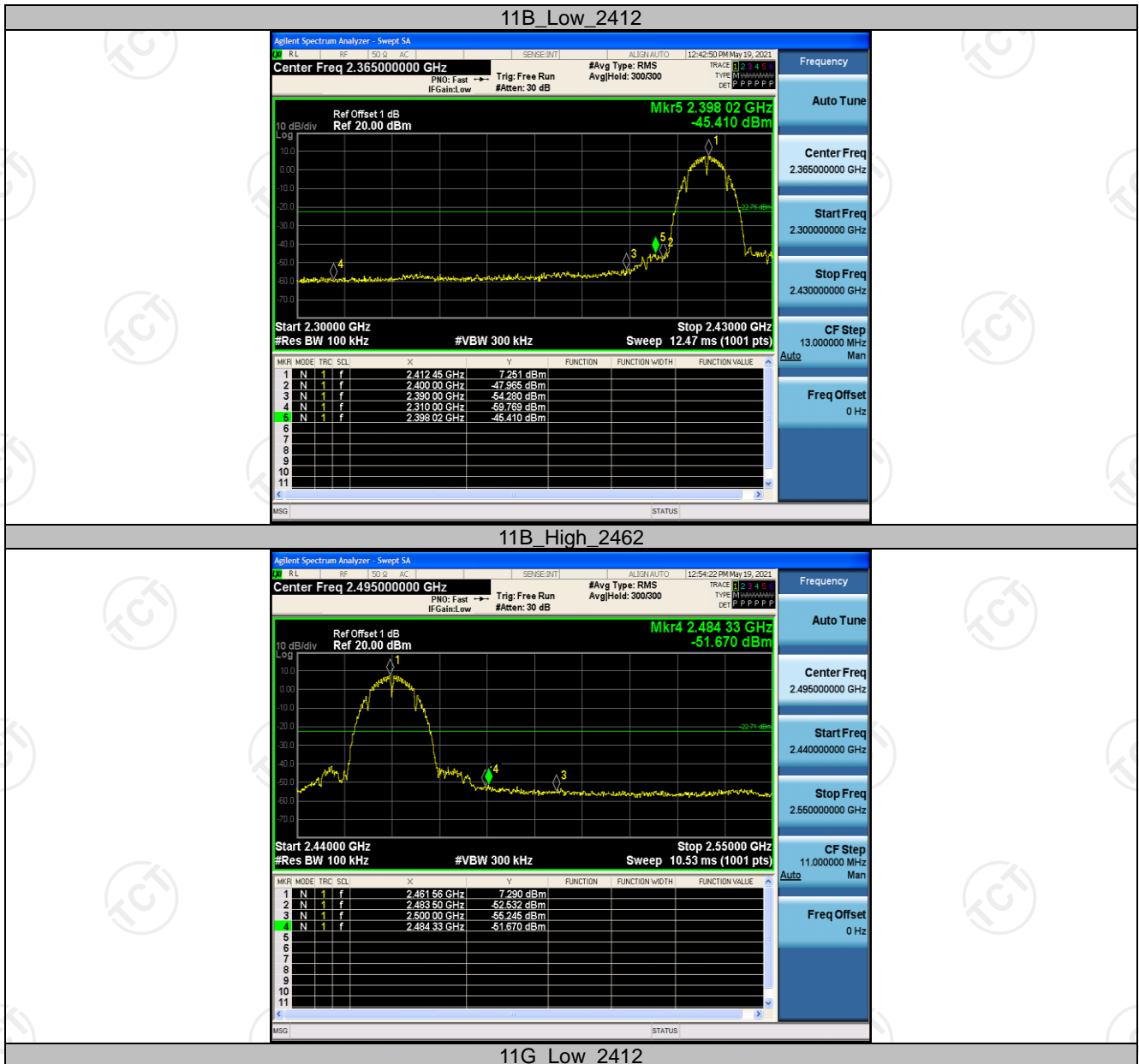

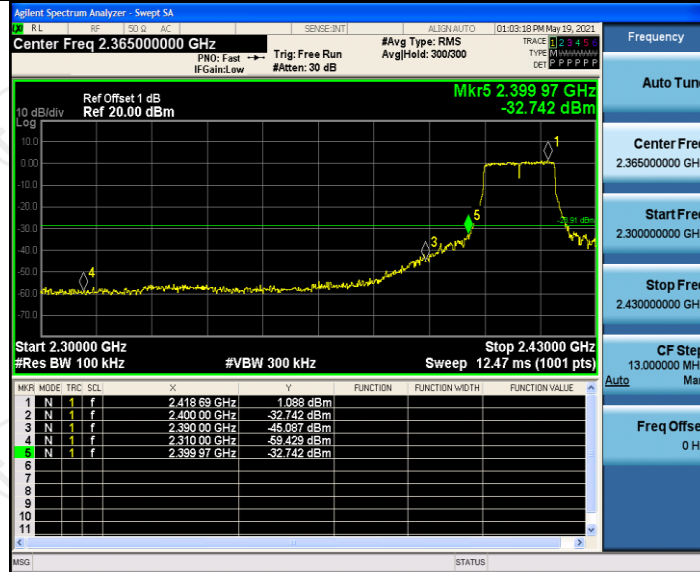

11G\_High\_2462

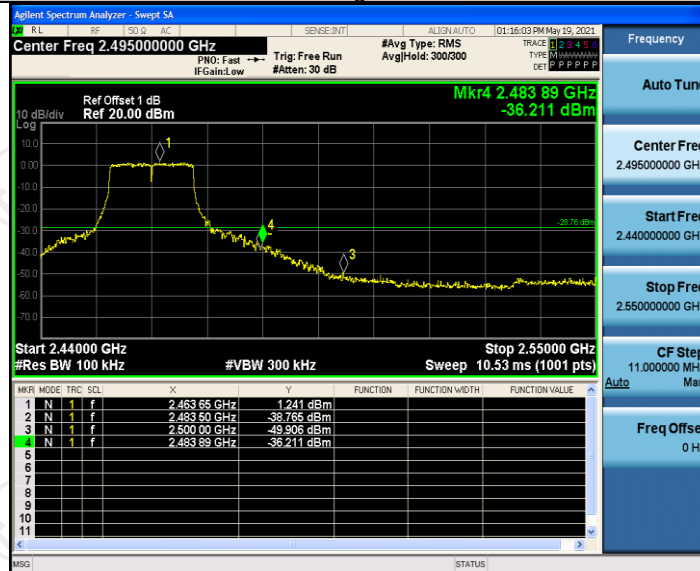

11N20SISO\_Low\_2412

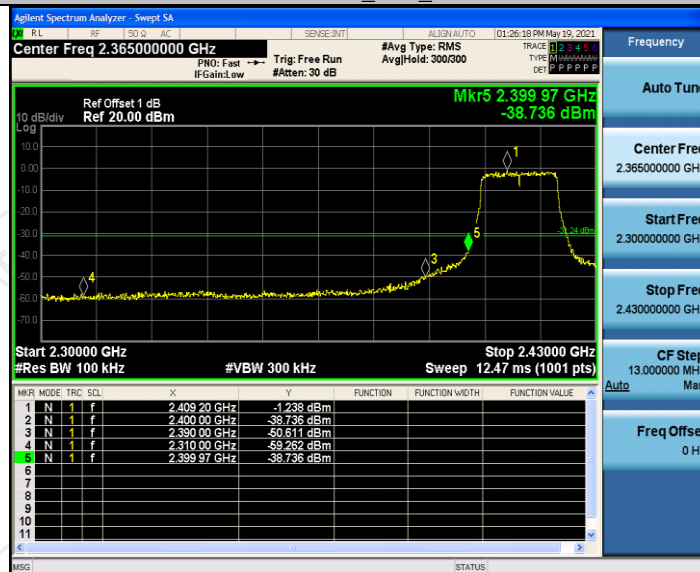

11N20SISO\_High\_2462

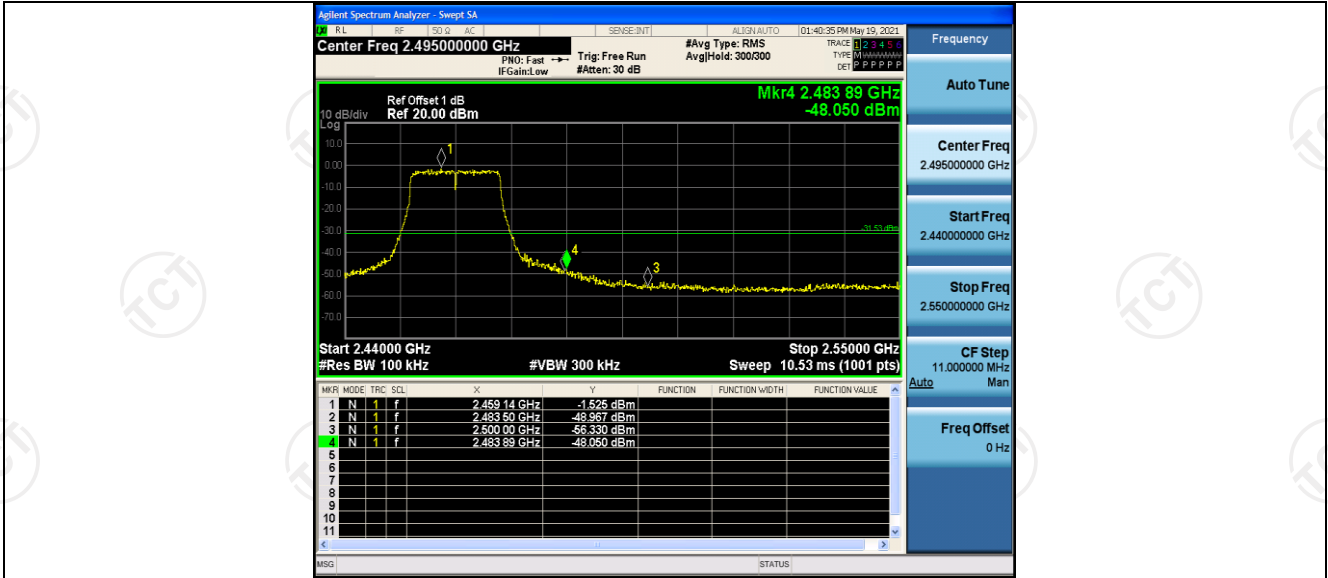

### Conducted Spurious Emission

#### Test Result

Test Mode	Channel	Freq Range [Mhz]	Ref Level [dBm]	Result [dBm]	Limit [dBm]	Verdict
11B	2412	Reference	7.23	7.23	---	PASS
		30~1000	30~1000	-67.939	<=-22.772	PASS
		1000~26500	1000~26500	-30.717	<=-22.772	PASS
	2437	Reference	7.43	7.43	---	PASS
		30~1000	30~1000	-68.557	<=-22.575	PASS
		1000~26500	1000~26500	-31.717	<=-22.575	PASS
	2462	Reference	7.24	7.24	---	PASS
		30~1000	30~1000	-67.947	<=-22.764	PASS
		1000~26500	1000~26500	-32.743	<=-22.764	PASS
11G	2412	Reference	1.14	1.14	---	PASS
		30~1000	30~1000	-68.703	<=-28.863	PASS
		1000~26500	1000~26500	-39.587	<=-28.863	PASS
	2437	Reference	1.14	1.14	---	PASS
		30~1000	30~1000	-67.849	<=-28.859	PASS
		1000~26500	1000~26500	-41.344	<=-28.859	PASS
	2462	Reference	1.20	1.20	---	PASS
		30~1000	30~1000	-67.457	<=-28.799	PASS
		1000~26500	1000~26500	-42.101	<=-28.799	PASS
11N20SISO	2412	Reference	-1.36	-1.36	---	PASS
		30~1000	30~1000	-67.591	<=-31.358	PASS
		1000~26500	1000~26500	-42.556	<=-31.358	PASS
	2437	Reference	-1.05	-1.05	---	PASS
		30~1000	30~1000	-68.628	<=-31.051	PASS
		1000~26500	1000~26500	-43.217	<=-31.051	PASS
	2462	Reference	-2.06	-2.06	---	PASS
		30~1000	30~1000	-68.34	<=-32.064	PASS
		1000~26500	1000~26500	-42.339	<=-32.064	PASS

#### Test Graphs

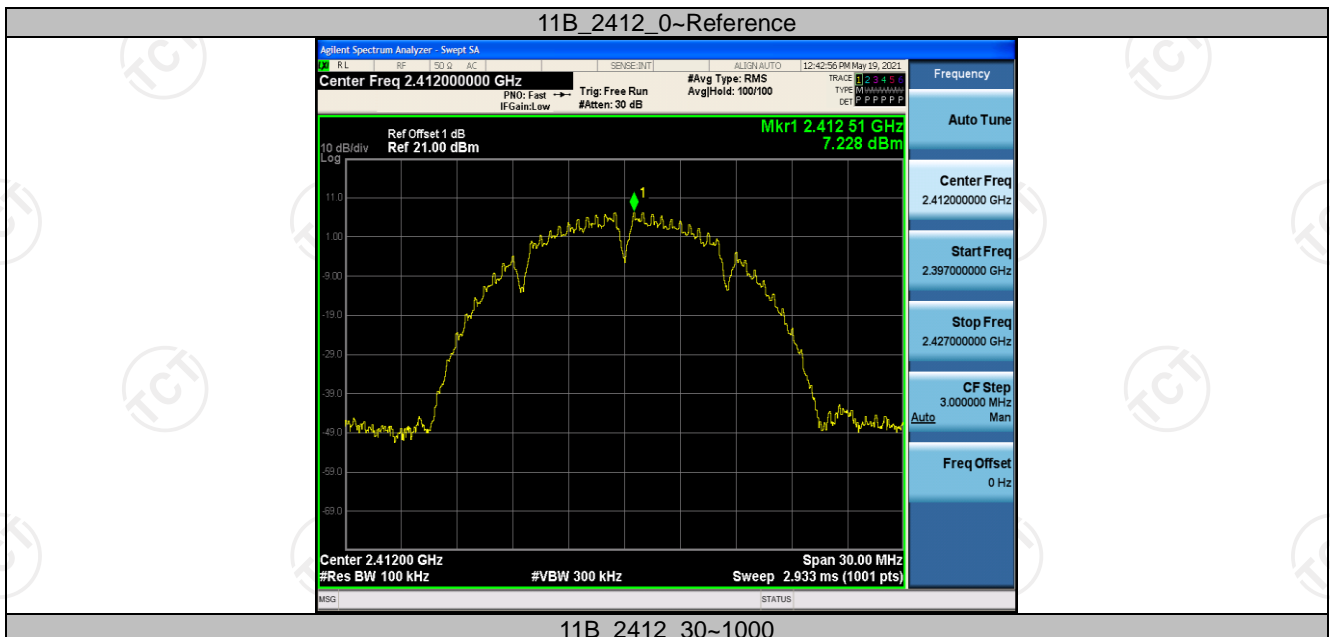

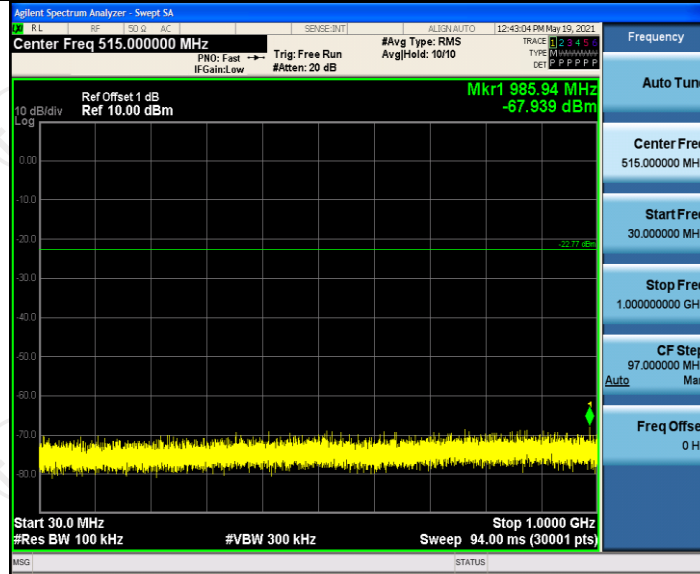

11B\_2412\_1000~26500

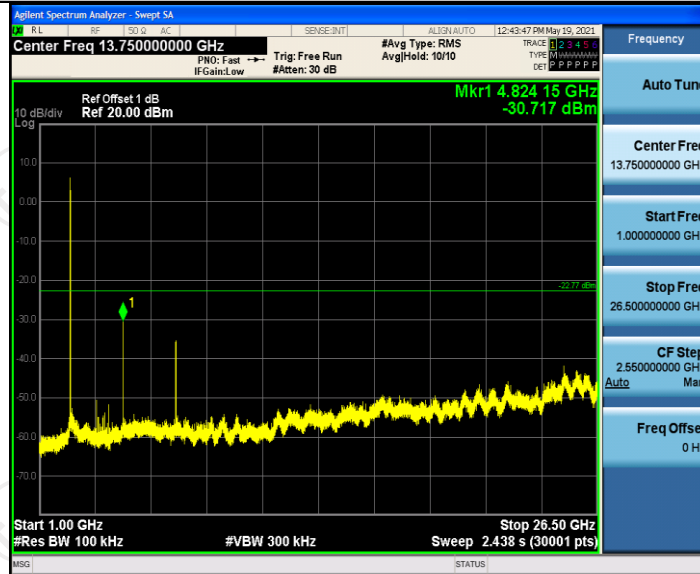

11B\_2437\_0~Reference



11B\_2437\_30~1000



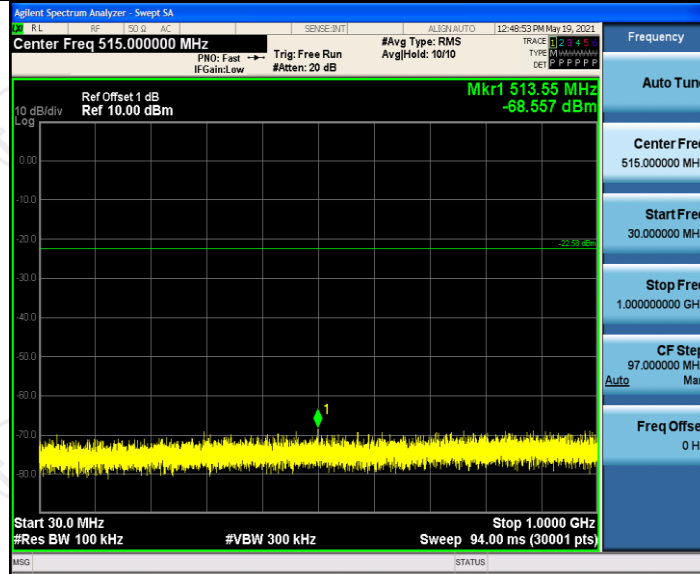

11B\_2437\_1000~26500

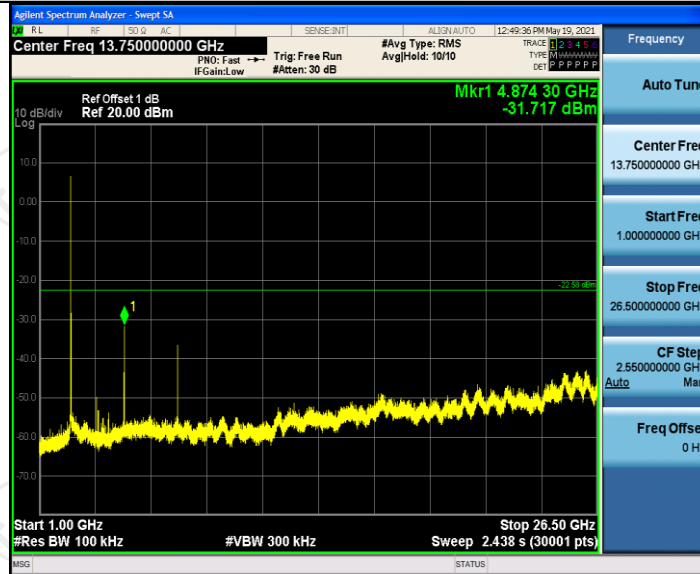

11B\_2462\_0-Reference



11B\_2462\_30~1000