



TEST REPORT

FCC PART 15.247

Report Reference No.: **CTL1808163251-WF02**

Compiled by: (position+printed name+signature)	Allen Wang (File administrators)	<u>Allen Wang</u>
Tested by: (position+printed name+signature)	Nice Nong (Test Engineer)	<u>Nice Nong</u>
Approved by: (position+printed name+signature)	Ivan Xie (Manager)	<u>Ivan Xie</u>

Product Name.....: AR LIGHT W:BLUETOOTH SPEAKER

Model/Type reference: L-CH832PST-A

List Model(s).....: L-CH349PST-C1, L-CH453PST-A

Trade Mark.....: N/A

FCC ID.....: 2AJ34L-CH832PST-A

Applicant's name: **Jiashan Dinghao Outdoor Leisure Products Co., Ltd**

Address of applicant: BUILDING8.9.NO.8HUIXIN ROAD, HUIMMIN STREET,
JIASHAN COUNTY, JIAXING, CHINA

Test Firm: **Shenzhen CTL Testing Technology Co., Ltd.**

Address of Test Firm: Floor 1-A, Baisha Technology Park, No.3011, Shaheci Road,
Nanshan District, Shenzhen, China 518055

Test specification.....:

Standard.....: **FCC Part 15.247:** Operation within the bands 902-928 MHz,
2400-2483.5 MHz and 5725-5850 MHz.

TRF Originator: Shenzhen CTL Testing Technology Co., Ltd.

Master TRF: Dated 2011-01

Date of Receipt.....: Sept. 03, 2018

Date of Test Date.....: Sept. 03, 2018–Sept. 17, 2018

Data of Issue.....: Sept. 17, 2018

Result.....: **Pass**

Shenzhen CTL Testing Technology Co., Ltd. All rights reserved.

This publication may be reproduced in whole or in part for non-commercial purposes as long as the Shenzhen CTL Testing Technology Co., Ltd. is acknowledged as copyright owner and source of the material. Shenzhen CTL Testing Technology Co., Ltd. takes no responsibility for and will not assume liability for damages resulting from the reader's interpretation of the reproduced material due to its placement and context.

TEST REPORT

Test Report No. :	CTL1808163251-WF02	Sept. 17, 2018 Date of issue
--------------------------	---------------------------	---------------------------------

Equipment under Test : AR LIGHT W:BLUETOOTH SPEAKER

Model /Type : L-CH832PST-A

Listed Models : L-CH349PST-C1, L-CH453PST-A

Applicant : **Jiashan Dinghao Outdoor Leisure Products Co., Ltd**

Address : BUILDING8.9.NO.8HUIXIN ROAD, HUIMMIN STREET, JIASHAN COUNTY, JIAXING, CHINA

Manufacturer : **Jiashan Dinghao Outdoor Leisure Products Co., Ltd**

Address : BUILDING8.9.NO.8HUIXIN ROAD, HUIMMIN STREET, JIASHAN COUNTY, JIAXING, CHINA

Test result	Pass *
--------------------	---------------

* In the configuration tested, the EUT complied with the standards specified page 5.

The test report merely corresponds to the test sample.

It is not permitted to copy extracts of these test result without the written permission of the test laboratory.

**** Modified History ****

Revisions	Description	Issued Data	Report No.	Remark
Version 1.0	Initial Test Report Release	2018-09-17	CTL1808163251-WF02	Tracy Qi



Table of Contents

Page

1. SUMMARY.....	5
1.1. TEST STANDARDS.....	5
1.2. TEST DESCRIPTION.....	5
1.3. TEST FACILITY.....	6
1.4. STATEMENT OF THE MEASUREMENT UNCERTAINTY.....	6
2. GENERAL INFORMATION.....	7
2.1. ENVIRONMENTAL CONDITIONS.....	7
2.2. GENERAL DESCRIPTION OF EUT.....	7
2.3. DESCRIPTION OF TEST MODES AND TEST FREQUENCY.....	7
2.4. EQUIPMENTS USED DURING THE TEST.....	8
2.5. RELATED SUBMITTAL(S) / GRANT (S).....	8
2.6. MODIFICATIONS.....	8
3. TEST CONDITIONS AND RESULTS.....	9
3.1. CONDUCTED EMISSIONS TEST.....	9
3.2. RADIATED EMISSIONS AND BAND EDGE.....	12
3.3. MAXIMUM CONDUCTED OUTPUT POWER.....	19
3.4. POWER SPECTRAL DENSITY.....	20
3.5. 6dB BANDWIDTH.....	22
3.6. OUT-OF-BAND EMISSIONS.....	24
3.7. ANTENNA REQUIREMENT.....	28
4. TEST SETUP PHOTOS OF THE EUT.....	29
5. EXTERNAL AND INTERNAL PHOTOS OF THE EUT.....	30



1. SUMMARY

1.1. TEST STANDARDS

The tests were performed according to following standards:

[FCC Rules Part 15.247](#): Frequency Hopping, Direct Spread Spectrum and Hybrid Systems that are in operation within the bands of 902-928 MHz, 2400-2483.5 MHz, and 5725-5850 MHz

[ANSI C63.10: 2013](#): American National Standard for Testing Unlicensed Wireless Devices

[KDB558074 D01 15.247 Meas Guidance v05](#): GUIDANCE FOR COMPLIANCE MEASUREMENTS ON DIGITAL TRANSMISSION SYSTEM,

FREQUENCY HOPPING SPREAD SPECTRUM SYSTEM, AND HYBRID SYSTEM DEVICES OPERATING UNDER SECTION 15.247 OF THE FCC RULES

1.2. Test Description

FCC PART 15.247		
FCC Part 15.207	AC Power Conducted Emission	PASS
FCC Part 15.247(a)(2)	6dB Bandwidth	PASS
FCC Part 15.247(d)	Spurious RF Conducted Emission	PASS
FCC Part 15.247(b)(3)	Maximum Conducted Output Power	PASS
FCC Part 15.247(e)	Power Spectral Density	PASS
FCC Part 15.205/ 15.209	Radiated Emissions	PASS
FCC Part 15.247(d)	Band Edge	PASS
FCC Part 15.203	Antenna Requirement	PASS

1.3. Test Facility

1.3.1 Address of the test laboratory

Shenzhen CTL Testing Technology Co., Ltd.

Floor 1-A, Baisha Technology Park, No. 3011, Shahexi Road, Nanshan, Shenzhen 518055 China

There is one 3m semi-anechoic chamber and two line conducted labs for final test. The Test Sites meet the requirements in documents ANSI C63.4 and CISPR 32/EN 55032 requirements.

1.3.2 Laboratory accreditation

The test facility is recognized, certified, or accredited by the following organizations:

IC Registration No.: 9618B

The 3m alternate test site of Shenzhen CTL Testing Technology Co., Ltd. EMC Laboratory has been registered by Certification and Engineer Bureau of Industry Canada for the performance of with Registration No.: 9618B on November 13, 2013.

FCC-Registration No.: 399832

Shenzhen CTL Testing Technology Co., Ltd. EMC Laboratory has been registered and fully described in a report filed with the (FCC) Federal Communications Commission. The acceptance letter from the FCC is maintained in our files. Registration 399832, December 08, 2017.

1.4. Statement of the measurement uncertainty

The data and results referenced in this document are true and accurate. The reader is cautioned that there may be errors within the calibration limits of the equipment and facilities. The measurement uncertainty was calculated for all measurements listed in this test report acc. to CISPR 16 - 4 "Specification for radio disturbance and immunity measuring apparatus and methods – Part 4: Uncertainty in EMC Measurements" and is documented in the Shenzhen CTL Testing Technology Co., Ltd. quality system acc. to DIN EN ISO/IEC 17025. Furthermore, component and process variability of devices similar to that tested may result in additional deviation. The manufacturer has the sole responsibility of continued compliance of the device.

Hereafter the best measurement capability for CTL laboratory is reported:

Test	Measurement Uncertainty	Notes
Transmitter power conducted	±0.57 dB	(1)
Transmitter power Radiated	±2.20 dB	(1)
Conducted spurious emission 9KHz-40 GHz	±2.20 dB	(1)
Occupied Bandwidth	±0.01ppm	(1)
Radiated Emission 30~1000MHz	±4.10dB	(1)
Radiated Emission Above 1GHz	±4.32dB	(1)
Conducted Disturbance0.15~30MHz	±3.20dB	(1)

- (1) This uncertainty represents an expanded uncertainty expressed at approximately the 95% confidence level using a coverage factor of k=2.

2. GENERAL INFORMATION

2.1. Environmental conditions

During the measurement the environmental conditions were within the listed ranges:

Normal Temperature:	25°C
Relative Humidity:	55 %
Air Pressure:	101 kPa

2.2. General Description of EUT

Product Name:	AR LIGHT W:BLUETOOTH SPEAKER
Model/Type reference:	L-CH832PST-A
Power supply:	DC 3.7V from battery
Adapter information:	Model: LX050100 Input: 100-240V~, 50/60Hz Output: 5V---1A
Bluetooth LE	
Supported type:	Bluetooth low Energy
Modulation:	GFSK
Operation frequency:	2402MHz to 2480MHz
Channel number:	40
Channel separation:	2 MHz
Antenna type:	PCB Antenna
Antenna gain:	0dBi

Note: For more details, please refer to the user's manual of the EUT.

2.3. Description of Test Modes and Test Frequency

The Applicant provides communication tools software to control the EUT for staying in continuous transmitting (Duty Cycle more than 98%) and receiving mode for testing.

There are 39 channels provided to the EUT and Channel 00/19/39 were selected for BLE test.

Operation Frequency List :

Channel	Frequency (MHz)
00	2402
02	2404
03	2406
⋮	⋮
19	2440
⋮	⋮
37	2476
38	2478
39	2480

Note: The line display in grey were the channel selected for testing

2.4. Equipments Used during the Test

Test Equipment	Manufacturer	Model No.	Serial No.	Calibration Date	Calibration Due Date
LISN	R&S	ENV216	3560.6550.1 2	2018/05/20	2019/05/19
LISN	R&S	ESH2-Z5	860014/010	2018/05/20	2019/05/19
Bilog Antenna	Sunol Sciences Corp.	JB1	A061713	2018/05/20	2019/05/19
EMI Test Receiver	R&S	ESCI	103710	2018/05/20	2019/05/19
Spectrum Analyzer	Agilent	E4407B	MY41440676	2018/05/20	2019/05/19
Spectrum Analyzer	Agilent	N9020	US46220290	2018/05/20	2019/05/19
Power Meter	Anritsu	ML2487B	110553	2018/05/20	2019/05/19
Power Sensor	Anritsu	MA2411B	100345	2018/05/20	2019/05/19
Controller	EM Electronics	Controller EM 1000	N/A	2018/05/20	2019/05/19
Horn Antenna	Sunol Sciences Corp.	DRH-118	A062013	2018/05/20	2019/05/19
Active Loop Antenna	SCHWARZBECK	FMZB1519	1519-037	2018/05/20	2019/05/19
Amplifier	Agilent	8349B	3008A02306	2018/05/20	2019/05/19
Amplifier	Agilent	8447D	2944A10176	2018/05/20	2019/05/19
Temperature/Humidity Meter	Gangxing	CTH-608	02	2018/05/20	2019/05/19
High-Pass Filter	K&L	9SH10-2700/X1 2750-O/O	N/A	2018/05/20	2019/05/19
High-Pass Filter	K&L	41H10-1375/U1 2750-O/O	N/A	2018/05/20	2019/05/19
Coaxial Cables	HUBER+SUHNER	SUCOFLEX 104PEA-10M	10m	2018/05/20	2019/05/19
Coaxial Cables	HUBER+SUHNER	SUCOFLEX 104PEA-3M	3m	2018/05/20	2019/05/19
Coaxial Cables	HUBER+SUHNER	SUCOFLEX 104PEA-3M	3m	2018/05/20	2019/05/19
RF Cable	Megalon	RF-A303	N/A	2018/05/20	2019/05/19

The calibration interval was one year

2.5. Related Submittal(s) / Grant (s)

This submittal(s) (test report) is intended to comply with Section 15.247 of the FCC Part 15, Subpart C Rules.

2.6. Modifications

No modifications were implemented to meet testing criteria.

3. TEST CONDITIONS AND RESULTS

3.1. Conducted Emissions Test

LIMIT

FCC CFR Title 47 Part 15 Subpart C Section 15.207

Frequency range (MHz)	Limit (dBuV)	
	Quasi-peak	Average
0.15-0.5	66 to 56*	56 to 46*
0.5-5	56	46
5-30	60	50

* Decreases with the logarithm of the frequency.

TEST CONFIGURATION

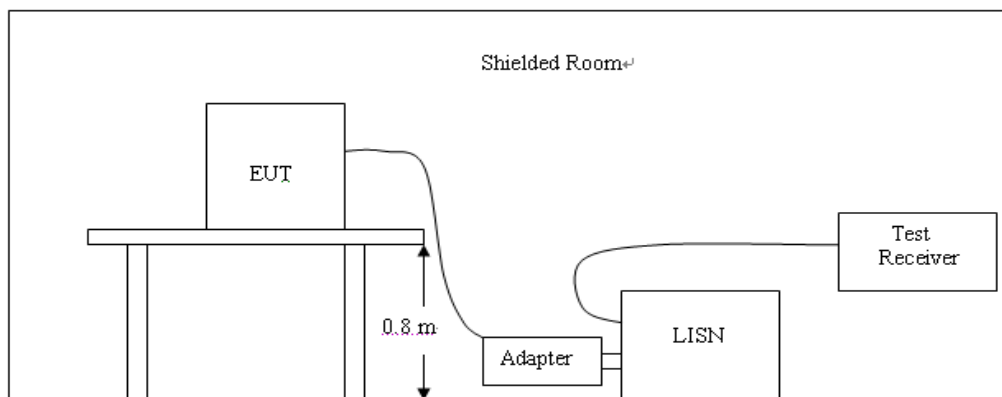

TEST PROCEDURE

1. The equipment was set up as per the test configuration to simulate typical actual usage per the user's manual. The EUT is a tabletop system; a wooden table with a height of 0.8 meters is used and is placed on the ground plane as per ANSI C63.10:2013.
2. Support equipment, if needed, was placed as per ANSI C63.10:2013.
3. All I/O cables were positioned to simulate typical actual usage as per ANSI C63.10:2013.
4. The adapter received AC120V/60Hz power through a Line Impedance Stabilization Network (LISN) which supplied power source and was grounded to the ground plane.
5. All support equipments received AC power from a second LISN, if any.
6. The EUT test program was started. Emissions were measured on each current carrying line of the EUT using a spectrum Analyzer / Receiver connected to the LISN powering the EUT. The LISN has two monitoring points: Line 1 (Hot Side) and Line 2 (Neutral Side). Two scans were taken: one with Line 1 connected to Analyzer / Receiver and Line 2 connected to a 50 ohm load; the second scan had Line 1 connected to a 50 ohm load and Line 2 connected to the Analyzer / Receiver.
7. Analyzer / Receiver scanned from 150 KHz to 30MHz for emissions in each of the test modes.
8. During the above scans, the emissions were maximized by cable manipulation.

TEST RESULTS

SCAN TABLE: "Voltage (9K-30M) FIN"

Short Description: 150K-30M Voltage

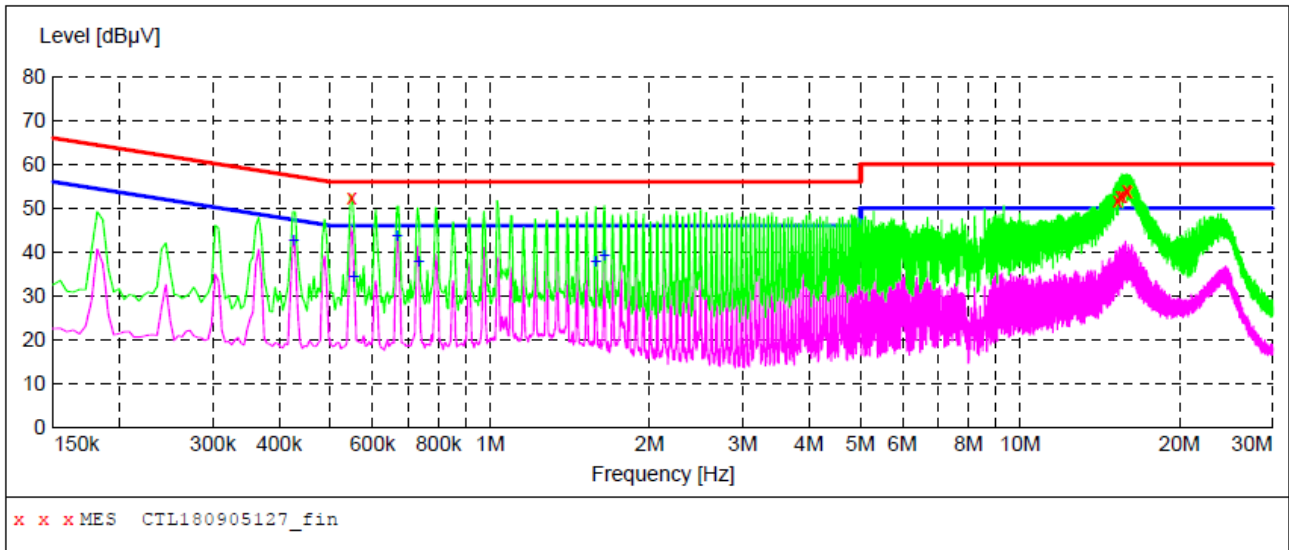

MEASUREMENT RESULT: "CTL180905127_fin"

2018-9-5 02:31??

Frequency MHz	Level dBµV	Transd dB	Limit dBµV	Margin dB	Detector	Line	PE
0.548000	52.50	10.2	56	3.5	QP	L1	GND
15.272000	51.70	10.7	60	8.3	QP	L1	GND
15.452000	52.70	10.7	60	7.3	QP	L1	GND
15.596000	52.90	10.7	60	7.1	QP	L1	GND
15.890000	54.20	10.7	60	5.8	QP	L1	GND
15.944000	53.80	10.7	60	6.2	QP	L1	GND

MEASUREMENT RESULT: "CTL180905127_fin2"

2018-9-5 02:31??

Frequency MHz	Level dBµV	Transd dB	Limit dBµV	Margin dB	Detector	Line	PE
0.426000	42.80	10.2	47	4.5	AV	L1	GND
0.554000	34.60	10.2	46	11.4	AV	L1	GND
0.668000	43.70	10.2	46	2.3	AV	L1	GND
0.734000	38.00	10.2	46	8.0	AV	L1	GND
1.586000	37.90	10.3	46	8.1	AV	L1	GND
1.646000	39.20	10.3	46	6.8	AV	L1	GND

SCAN TABLE: "Voltage (9K-30M) FIN"

Short Description: 150K-30M Voltage

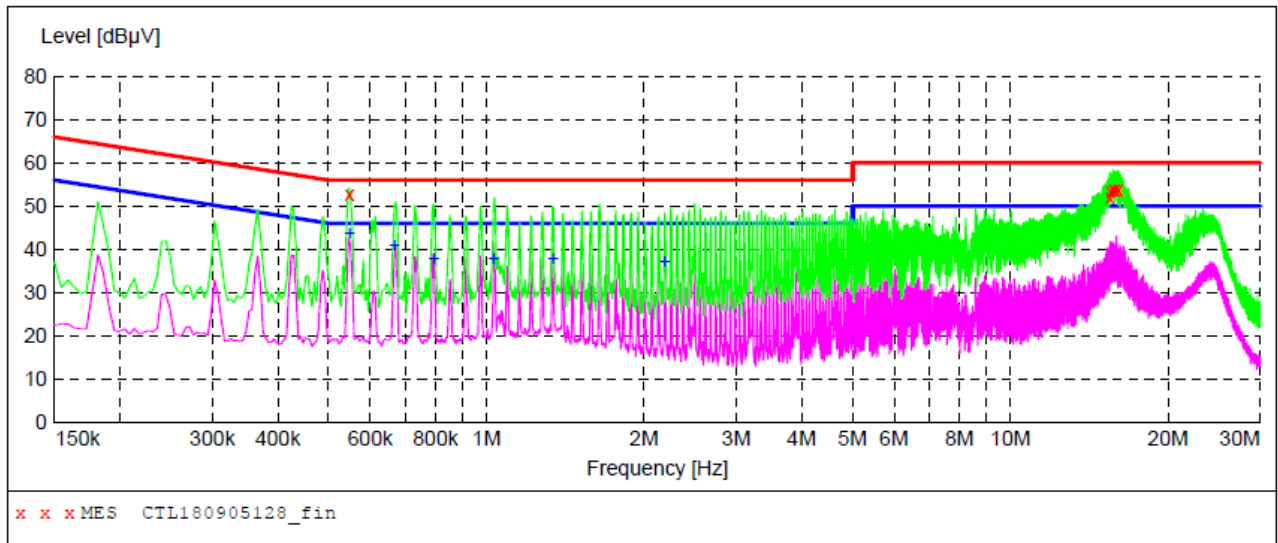

MEASUREMENT RESULT: "CTL180905128_fin"

2018-9-5 02:34??

Frequency MHz	Level dBµV	Transd dB	Limit dBµV	Margin dB	Detector	Line	PE
0.548000	52.70	10.2	56	3.3	QP	N	GND
15.512000	51.90	10.7	60	8.1	QP	N	GND
15.530000	53.50	10.7	60	6.5	QP	N	GND
15.716000	53.80	10.7	60	6.2	QP	N	GND
15.890000	53.80	10.7	60	6.2	QP	N	GND
16.082000	53.70	10.7	60	6.3	QP	N	GND

MEASUREMENT RESULT: "CTL180905128_fin2"

2018-9-5 02:34??

Frequency MHz	Level dBµV	Transd dB	Limit dBµV	Margin dB	Detector	Line	PE
0.548000	43.70	10.2	46	2.3	AV	N	GND
0.668000	40.90	10.2	46	5.1	AV	N	GND
0.794000	38.00	10.2	46	8.0	AV	N	GND
1.034000	37.90	10.3	46	8.1	AV	N	GND
1.340000	38.00	10.3	46	8.0	AV	N	GND
2.192000	37.10	10.4	46	8.9	AV	N	GND

3.2. Radiated Emissions and Band Edge

Limit

For intentional device, according to § 15.209(a), the general requirement of field strength of radiated emission out of authorized band shall not exceed the following table at a 3 meters measurement distance.

In addition, radiated emissions which fall in the restricted bands, as defined in §15.205(a), must also comply with the radiated emission limits specified in §15.209(a)

Radiated emission limits

Frequency (MHz)	Distance (Meters)	Radiated (dB μ V/m)	Radiated (μ V/m)
0.009-0.49	3	$20\log(2400/F(\text{KHz}))+40\log(300/3)$	$2400/F(\text{KHz})$
0.49-1.705	3	$20\log(24000/F(\text{KHz}))+40\log(30/3)$	$24000/F(\text{KHz})$
1.705-30	3	$20\log(30)+40\log(30/3)$	30
30-88	3	40.0	100
88-216	3	43.5	150
216-960	3	46.0	200
Above 960	3	54.0	500

TEST CONFIGURATION

(A) Radiated Emission Test Set-Up, Frequency Below 30MHz

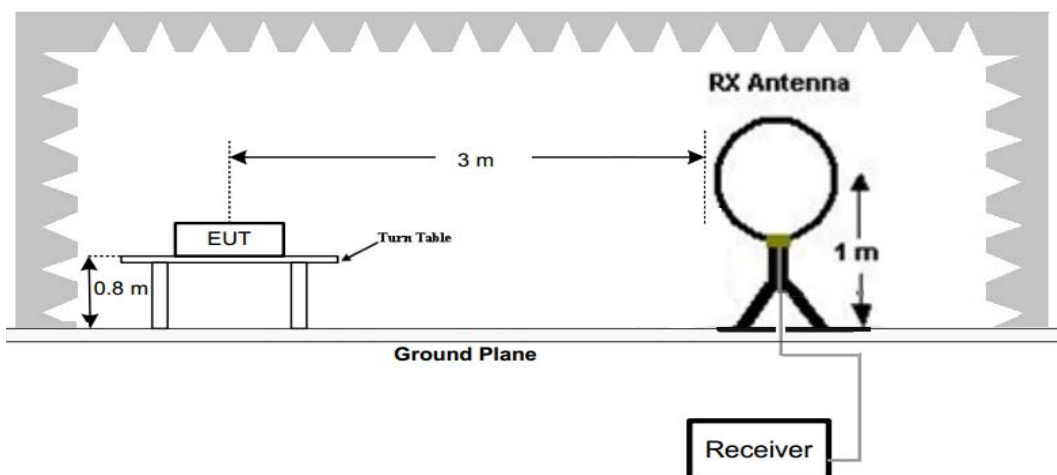

(B) Radiated Emission Test Set-Up, Frequency below 1000MHz

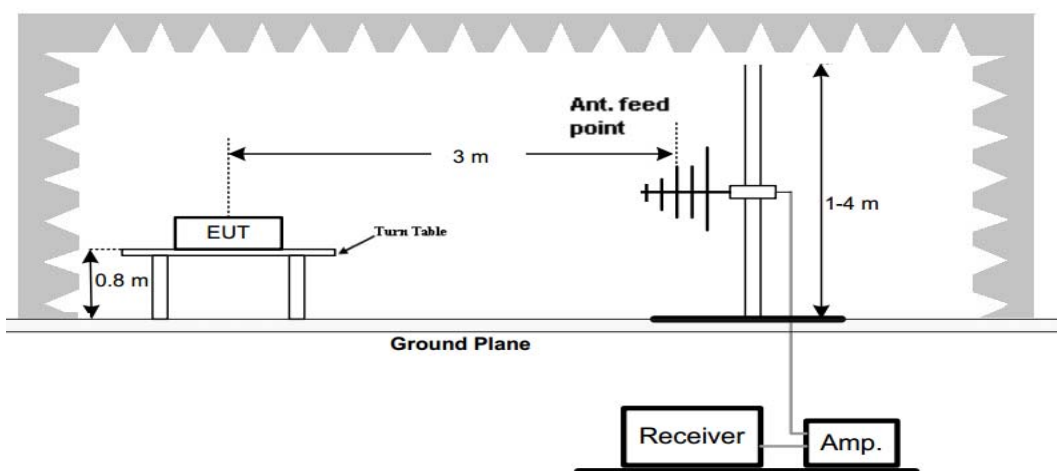

(C) Radiated Emission Test Set-Up, Frequency above 1000MHz

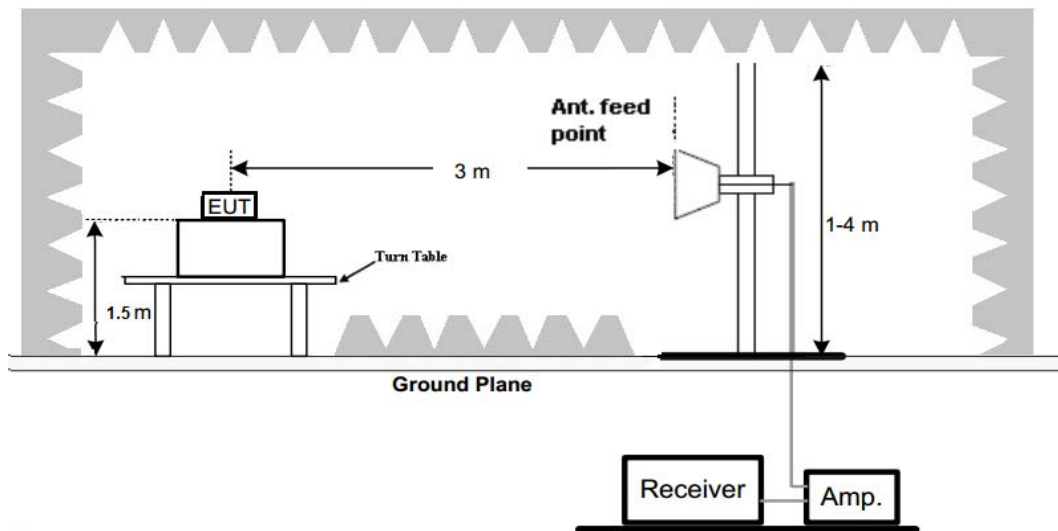

Test Procedure

1. Below 1GHz measurement the EUT is placed on a turntable which is 0.8m above ground plane, and above 1GHz measurement EUT was placed on a low permittivity and low loss tangent turn table which is 1.5m above ground plane.
2. Maximum procedure was performed by raising the receiving antenna from 1m to 4m and rotating the turn table from 0° to 360° to acquire the highest emissions from EUT
3. And also, each emission was to be maximized by changing the polarization of receiving antenna both horizontal and vertical.
4. Repeat above procedures until all frequency measurements have been completed.

TEST RESULTS

Remark:

1. For below 1GHz testing recorded worst at BLE low channel.
2. Radiated emission test from 9 KHz to 10th harmonic of fundamental was verified, and no emission found except system noise floor in 9 KHz to 30MHz and not recorded in this report.

For 30MHz-1GHz

Horizontal

SWEEP TABLE: "test (30M-1G)"

Short Description: Field Strength
 Start Stop Detector Meas. IF Transducer
 Frequency Frequency Time Bandw.
 30.0 MHz 1.0 GHz MaxPeak 200.0 ms 120 kHz VULB 9168

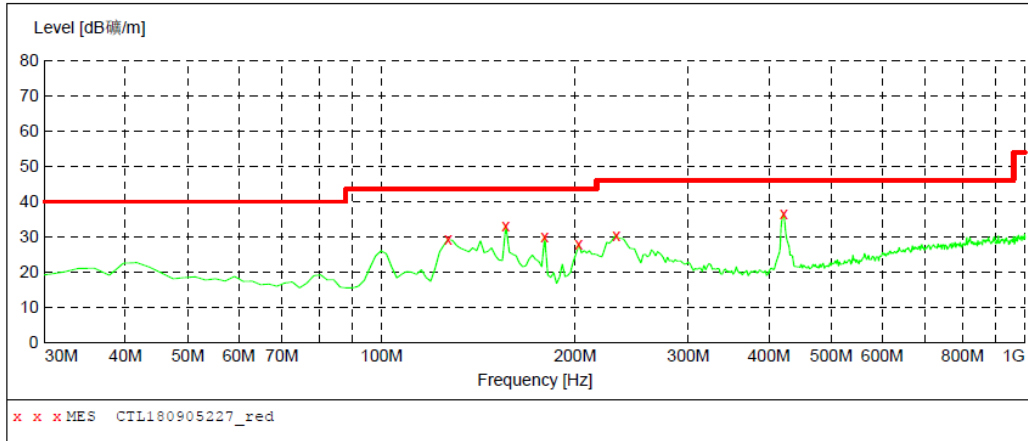

MEASUREMENT RESULT: "CTL180905227_red"

2018-9-5 8:58

Frequency MHz	Level dB/m	Transd dB	Limit dB/m	Margin dB	Det.	Height cm	Azimuth deg	Polarization
127.000000	29.20	13.6	43.5	14.3	---	0.0	0.00	HORIZONTAL
156.100000	33.20	15.2	43.5	10.3	---	0.0	0.00	HORIZONTAL
179.380000	30.00	12.9	43.5	13.5	---	0.0	0.00	HORIZONTAL
202.660000	27.80	11.1	43.5	15.7	---	0.0	0.00	HORIZONTAL
231.760000	30.40	12.5	46.0	15.6	---	0.0	0.00	HORIZONTAL
421.880000	36.50	16.8	46.0	9.5	---	0.0	0.00	HORIZONTAL

Vertical

SWEEP TABLE: "test (30M-1G)"

Short Description: Field Strength
 Start Stop Detector Meas. IF Transducer
 Frequency Frequency Time Bandw.
 30.0 MHz 1.0 GHz MaxPeak 200.0 ms 120 kHz VULB 9168

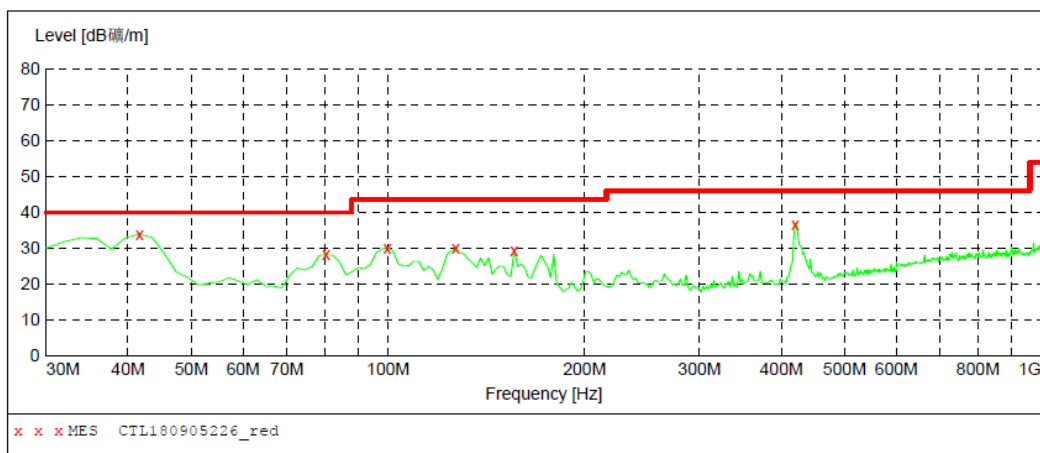

MEASUREMENT RESULT: "CTL180905226_red"

2018-9-5 8:56

Frequency MHz	Level dB/m	Transd dB	Limit dB/m	Margin dB	Det.	Height cm	Azimuth deg	Polarization
41.640000	33.90	14.7	40.0	6.1	---	0.0	0.00	VERTICAL
80.440000	28.20	10.1	40.0	11.8	---	0.0	0.00	VERTICAL
99.840000	30.10	11.0	43.5	13.4	---	0.0	0.00	VERTICAL
127.000000	29.90	13.6	43.5	13.6	---	0.0	0.00	VERTICAL
156.100000	29.30	15.2	43.5	14.2	---	0.0	0.00	VERTICAL
419.940000	36.70	16.8	46.0	9.3	---	0.0	0.00	VERTICAL

For 1GHz to 25GHz

BLE Mode (above 1GHz)

Frequency(MHz):			2402		Polarity:			HORIZONTAL	
Frequency (MHz)	Emission Level (dBuV/m)		Limit (dBuV/m)	Margin (dB)	Raw Value (dBuV)	Antenna Factor (dB/m)	Cable Factor (dB)	Pre-amplifier (dB)	Correction Factor (dB/m)
4804.00	51.72	PK	74.00	22.28	47.21	33.49	6.91	35.89	4.51
4804.00	--	AV	54.00	--	--	--	--	--	--
5180.50	43.05	PK	74.00	30.95	35.84	34.38	7.10	34.27	7.21
5180.50	--	AV	54.00	--	--	--	--	--	--
7206.00	47.32	PK	74.00	26.68	36.22	36.95	9.18	35.03	11.10
7206.00	--	AV	54.00	--	--	--	--	--	--

Frequency(MHz):			2402		Polarity:			VERTICAL	
Frequency (MHz)	Emission Level (dBuV/m)		Limit (dBuV/m)	Margin (dB)	Raw Value (dBuV)	Antenna Factor (dB/m)	Cable Factor (dB)	Pre-amplifier (dB)	Correction Factor (dB/m)
4804.00	50.93	PK	74.00	23.07	46.42	33.49	6.91	35.89	4.51
4804.00	--	AV	54.00	--	--	--	--	--	--
5180.50	42.47	PK	74.00	31.53	34.91	34.69	7.23	34.36	7.56
5180.50	--	AV	54.00	--	--	--	--	--	--
7206.00	48.16	PK	74.00	25.84	37.06	36.95	9.18	35.03	11.10
7206.00	--	AV	54.00	--	--	--	--	--	--

Frequency(MHz):			2440		Polarity:			HORIZONTAL	
Frequency (MHz)	Emission Level (dBuV/m)		Limit (dBuV/m)	Margin (dB)	Raw Value (dBuV)	Antenna Factor (dB/m)	Cable Factor (dB)	Pre-amplifier (dB)	Correction Factor (dB/m)
4880.00	50.78	PK	74.00	23.22	44.53	33.60	6.95	34.30	6.25
4880.00	--	AV	54.00	--	--	--	--	--	--
5236.75	43.61	PK	74.00	30.39	35.98	34.57	7.16	34.10	7.63
5236.75	--	AV	54.00	--	--	--	--	--	--
7320.00	47.37	PK	74.00	26.63	35.68	37.46	9.23	35.00	11.69
7320.00	--	AV	54.00	--	--	--	--	--	--

Frequency(MHz):			2440		Polarity:			VERTICAL	
Frequency (MHz)	Emission Level (dBuV/m)		Limit (dBuV/m)	Margin (dB)	Raw Value (dBuV)	Antenna Factor (dB/m)	Cable Factor (dB)	Pre-amplifier (dB)	Correction Factor (dB/m)
4880.00	51.06	PK	74.00	22.94	44.81	33.60	6.95	34.30	6.25
4880.00	--	AV	54.00	--	--	--	--	--	--
5236.75	43.98	PK	74.00	30.02	36.34	34.58	7.16	34.10	7.64
5236.75	--	AV	54.00	--	--	--	--	--	--
7320.00	47.74	PK	74.00	26.26	36.05	37.46	9.23	35.00	11.69
7320.00	--	AV	54.00	--	--	--	--	--	--

Frequency(MHz):			2480		Polarity:			HORIZONTAL	
Frequency (MHz)	Emission Level (dBuV/m)		Limit (dBuV/m)	Margin (dB)	Raw Value (dBuV)	Antenna Factor (dB/m)	Cable Factor (dB)	Pre-amplifier (dB)	Correction Factor (dB/m)
4960.00	50.96	PK	74.00	23.04	46.04	33.84	7.00	35.92	4.92
4960.00	--	AV	54.00	--	--	--	--	--	--
5325.50	43.52	PK	74.00	30.48	35.98	34.67	7.22	34.35	7.54
5325.50	--	AV	54.00	--	--	--	--	--	--
7440.00	47.49	PK	74.00	26.51	35.54	37.64	9.28	34.97	11.95
7440.00	--	AV	54.00	--	--	--	--	--	--

Frequency(MHz):			2480		Polarity:			VERTICAL	
Frequency (MHz)	Emission Level (dBuV/m)		Limit (dBuV/m)	Margin (dB)	Raw Value (dBuV)	Antenna Factor (dB/m)	Cable Factor (dB)	Pre-amplifier (dB)	Correction Factor (dB/m)
4960.00	51.16	PK	74.00	22.84	46.24	33.84	7.00	35.92	4.92
4960.00	--	AV	54.00	--	--	--	--	--	--
5325.25	43.72	PK	74.00	30.28	36.53	34.36	7.10	34.27	7.19
5325.25	--	AV	54.00	--	--	--	--	--	--
7440.00	48.01	PK	74.00	25.99	36.06	37.64	9.28	34.97	11.95
7440.00	--	AV	54.00	--	--	--	--	--	--

REMARKS:

1. Emission level (dBuV/m) =Raw Value (dBuV)+Correction Factor (dB/m)
2. Correction Factor (dB/m) = Antenna Factor (dB/m)+Cable Factor (dB)-Pre-amplifier Factor
3. Margin value = Limit value- Emission level.
4. -- Mean the PK detector measured value is below average limit.
5. The other emission levels were very low against the limit.
6. RBW1MHz VBW3MHz Peak detector is for PK value; RBW 1MHz VBW10Hz Peak detector is for AV value.

Results of Band Edges Test (Radiated)

Frequency(MHz):			2402		Polarity:			HORIZONTAL	
Frequency (MHz)	Emission Level (dBuV/m)		Limit (dBuV/m)	Margin (dB)	Raw Value (dBuV)	Antenna Factor (dB/m)	Cable Factor (dB)	Pre-amplifier (dB)	Correction Factor (dB/m)
2402.00	90.13	PK	--	--	56.74	28.78	4.61	0.00	33.39
2402.00	85.48	AV	--	--	52.09	28.78	4.61	0.00	33.39
2367.75	43.07	PK	74.00	30.93	9.99	28.52	4.56	0.00	33.08
2367.75	--	AV	54.00	--	--	--	--	--	--
2390.00	46.92	PK	74.00	27.08	13.60	28.72	4.60	0.00	33.32
2390.00	--	AV	54.00	--	--	--	--	--	--
2400.00	47.41	PK	74.00	26.59	14.02	28.78	4.61	0.00	33.39
2400.00	--	AV	54.00	--	--	--	--	--	--

Frequency(MHz):			2402		Polarity:			VERTICAL	
Frequency (MHz)	Emission Level (dBuV/m)		Limit (dBuV/m)	Margin (dB)	Raw Value (dBuV)	Antenna Factor (dB/m)	Cable Factor (dB)	Pre-amplifier (dB)	Correction Factor (dB/m)
2402.00	90.47	PK	--	--	57.08	28.78	4.61	0	33.39
2402.00	85.22	AV	--	--	51.83	28.78	4.61	0	33.39
2367.75	43.07	PK	74	30.93	9.99	28.52	4.56	0	33.08
2367.75	--	AV	54	--	--	--	--	--	--
2390.00	46.15	PK	74	27.85	12.83	28.72	4.60	0	33.32
2390.00	--	AV	54	--	--	--	--	--	--
2400.00	47.26	PK	74	26.74	13.87	28.78	4.61	0	33.39
2400.00	--	AV	54	--	--	--	--	--	--

Frequency(MHz):			2480		Polarity:			HORIZONTAL	
Frequency (MHz)	Emission Level (dBuV/m)		Limit (dBuV/m)	Margin (dB)	Raw Value (dBuV)	Antenna Factor (dB/m)	Cable Factor (dB)	Pre-amplifier (dB)	Correction Factor (dB/m)
2480.00	90.71	PK	--	--	57.09	28.92	4.70	0.00	33.62
2480.00	85.35	AV	--	--	51.73	28.92	4.70	0.00	33.62
2483.50	43.82	PK	74	30.18	10.19	28.93	4.70	0.00	33.63
2483.50	--	AV	54	--	--	--	--	--	--
2491.95	43.17	PK	74	30.83	9.51	28.95	4.71	0.00	33.66
2491.95	--	AV	54	--	--	--	--	--	--
2500.00	47.95	PK	74	26.05	14.27	28.96	4.72	0.00	33.68
2500.00	--	AV	54	--	--	--	--	--	--

Frequency(MHz):			2480		Polarity:			VERTICAL	
Frequency (MHz)	Emission Level (dBuV/m)		Limit (dBuV/m)	Margin (dB)	Raw Value (dBuV)	Antenna Factor (dB/m)	Cable Factor (dB)	Pre-amplifier (dB)	Correction Factor (dB/m)
2480.00	91.07	PK	--	--	57.45	28.92	4.70	0.00	33.62
2480.00	86.04	AV	--	--	52.42	28.92	4.70	0.00	33.62
2483.50	43.96	PK	74	30.04	10.33	28.93	4.70	0.00	33.63
2483.50	--	AV	54	--	--	--	--	--	--
2489.05	42.58	PK	74	31.42	8.92	28.95	4.71	0.00	33.66
2489.05	--	AV	54	--	--	--	--	--	--
2500.00	48.05	PK	74	25.95	14.37	28.96	4.72	0.00	33.68
2500.00	--	AV	54	--	--	--	--	--	--

REMARKS:

1. Emission level (dBuV/m) =Raw Value (dBuV)+Correction Factor (dB/m)
2. Correction Factor (dB/m) = Antenna Factor (dB/m)+Cable Factor (dB)-Pre-amplifier Factor
3. Margin value = Limit value- Emission level.
4. -- Mean the PK detector measured value is below average limit.
5. The other emission levels were very low against the limit.
6. RBW 1MHz VBW 3MHz Peak detector is for PK value; RBW 1MHz VBW 10Hz Peak detector is for AV value.



3.3. Maximum Conducted Output Power

Limit

The Maximum Peak Output Power Measurement is 30dBm.

Test Procedure

Remove the antenna from the EUT and then connect a low loss RF cable from the antenna port to the power sensor.

Test Configuration

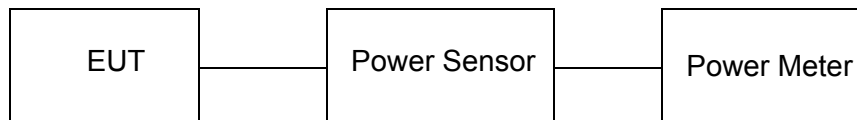

Test Results

Type	Channel	PK Output power (dBm)	Limit (dBm)	Result
GFSK	00	-5.350	30.00	Pass
	19	-5.220		
	39	-5.384		

Note: 1.The test results including the cable lose.

3.4. Power Spectral Density

Limit

For digitally modulated systems, the power spectral density conducted from the intentional radiator to the antenna shall not be greater than 8 dBm in any 3 kHz band during any time interval of continuous transmission.

Test Procedure

1. Use this procedure when the maximum peak conducted output power in the fundamental emission is used to demonstrate compliance.
2. Set the RBW \geq 3 kHz.
3. Set the VBW \geq 3 \times RBW.
4. Set the span to 1.5 times the DTS channel bandwidth.
5. Detector = peak.
6. Sweep time = auto couple.
7. Trace mode = max hold.
8. Allow trace to fully stabilize.
9. Use the peak marker function to determine the maximum power level.
10. If measured value exceeds limit, reduce RBW (no less than 3 kHz) and repeat.
11. The resulting peak PSD level must be 8dBm.

Test Configuration



Test Results

Type	Channel	Power Spectral Density (dBm/3KHz)	Limit (dBm/3KHz)	Result
GFSK	00	-20.910	8.00	Pass
	19	-20.694		
	39	-20.924		

Test plot as follows:

BLE GFSK

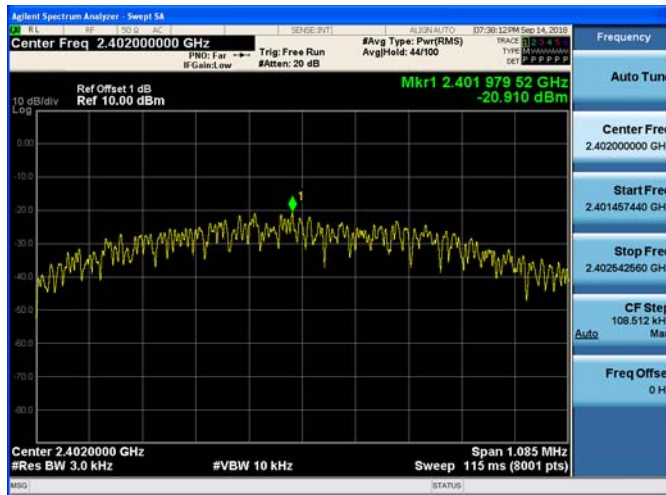

CH00

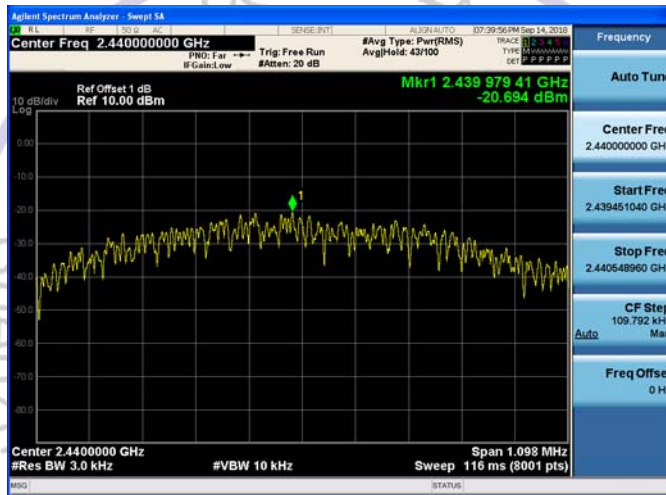

CH19

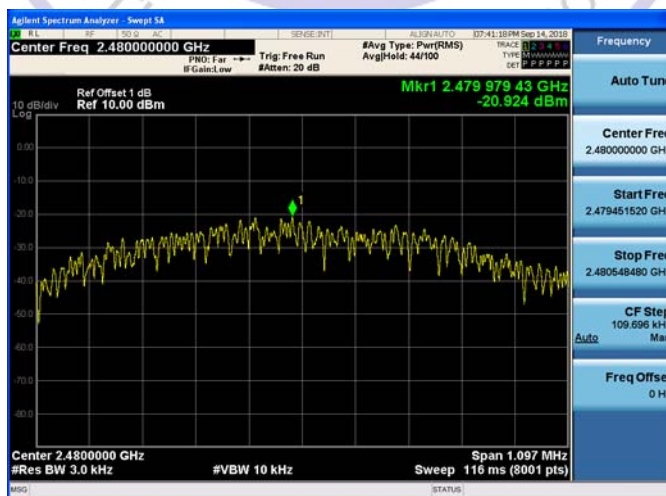

CH39

3.5. 6dB Bandwidth

Limit

For digital modulation systems, the minimum 6 dB bandwidth shall be at least 500 kHz

Test Procedure

The transmitter output was connected to the spectrum analyzer through an attenuator. The bandwidth of the fundamental frequency was measured by spectrum analyzer with 100 KHz RBW and 300 KHz VBW. The 6dB bandwidth is defined as the total spectrum the power of which is higher than peak power minus 6dB.

Test Configuration



Test Results

Type	Channel	6dB Bandwidth (MHz)	99% OBW (MHz)	Limit (KHz)	Result
GFSK	00	0.6782	1.0265	≥500	Pass
	19	0.6862	1.0298		
	39	0.6856	1.0290		

Test plot as follows:

BLE GFSK



CH00

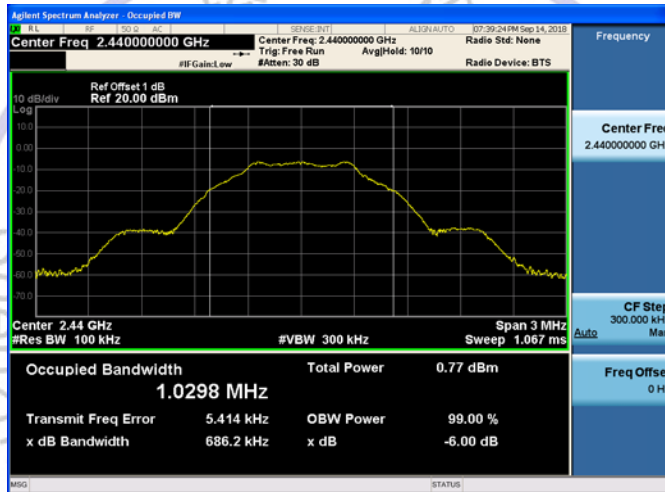

CH19



CH39

3.6. Out-of-band Emissions

Limit

In any 100 kHz bandwidth outside the frequency band in which the spread spectrum or digitally modulated intentional radiator is operating, the radio frequency power that is produced by the intentional radiator shall be at least 20 dB below that in the 100 kHz bandwidth within the band that contains the highest level of the desired power, based on either an RF conducted or a radiated measurement, provided the transmitter demonstrates compliance with the peak conducted power limits. If the transmitter complies with the conducted power limits based on the use of RMS averaging over a time interval, as permitted under paragraph (b)(3) of this section, the attenuation required under this paragraph shall be 30 dB instead of 20 dB. Attenuation below the general limits specified in §15.209(a) is not required.

Test Procedure

Connect the transmitter output to spectrum analyzer using a low loss RF cable, and set the spectrum analyzer to RBW=100 kHz, VBW= 300 kHz, peak detector, and max hold. Measurements utilizing these settings are made of the in-band reference level, band-edge and out-of-band emissions.

Test Configuration



Test Results

Remark: The measurement frequency range is from 30MHz to the 10th harmonic of the fundamental frequency. The lowest, middle and highest channels are tested to verify the spurious emissions and band-edge measurement data.

Test plot as follows:

CH00

CH19



Reference

Reference

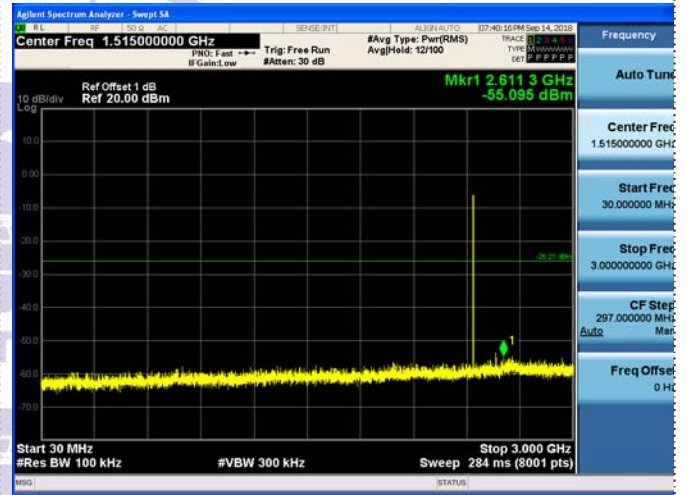
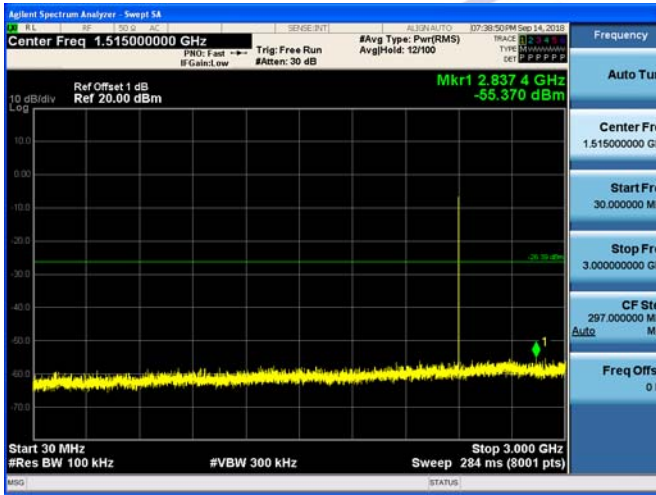

30MHz-3GHz

30MHz-3GHz

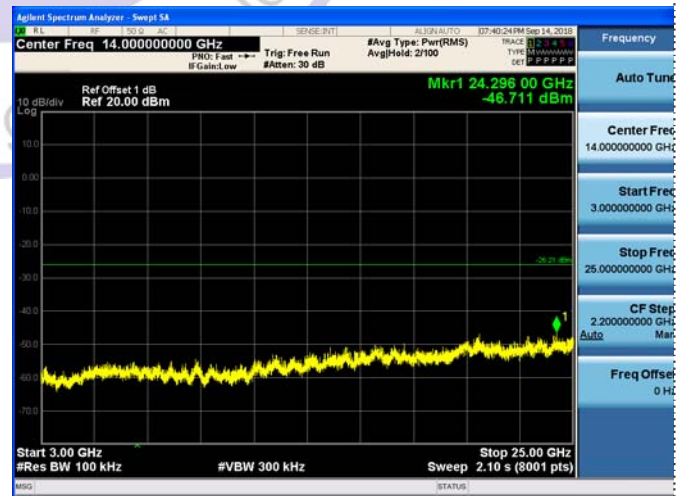
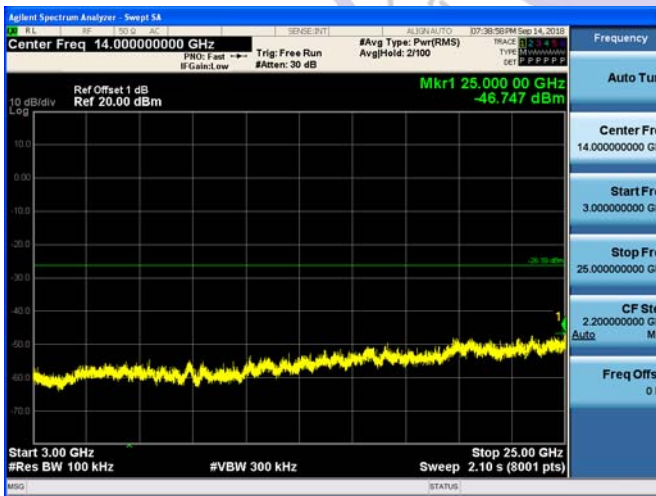

3GHz-25GHz

3GHz-25GHz

CH39



Reference

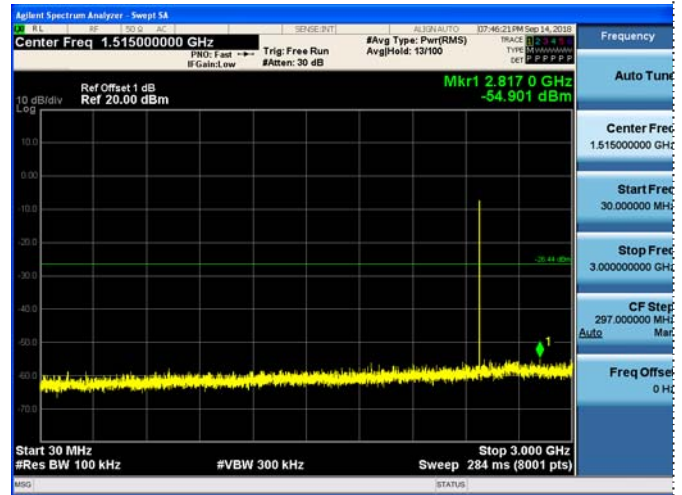

30MHz-3GHz

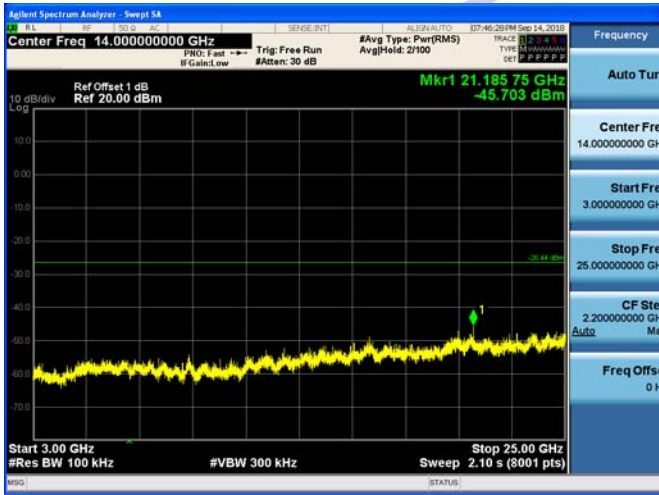

3GHz-25GHz

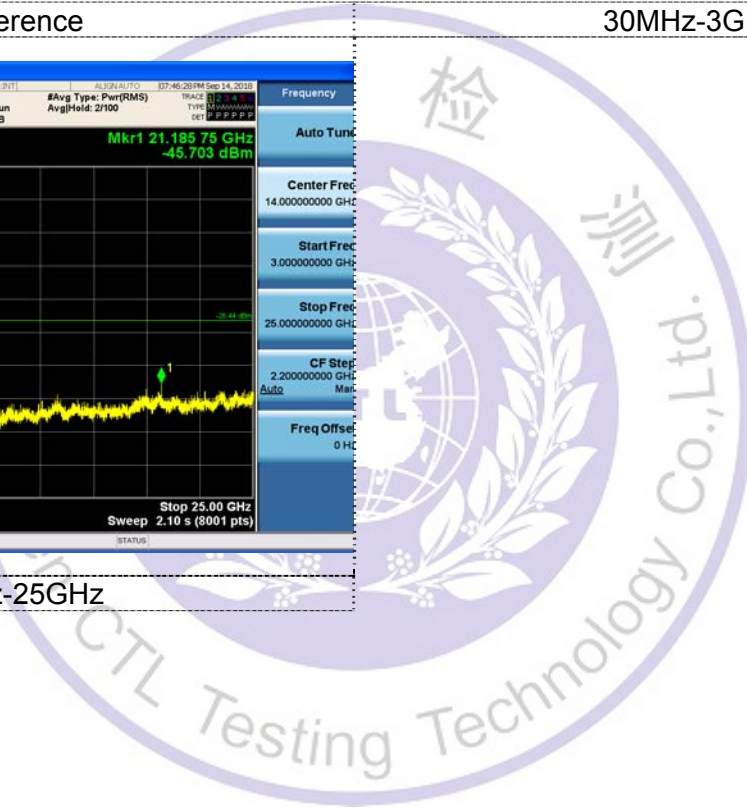

Band-edge Measurements for RF Conducted Emissions:

BLE GFSK

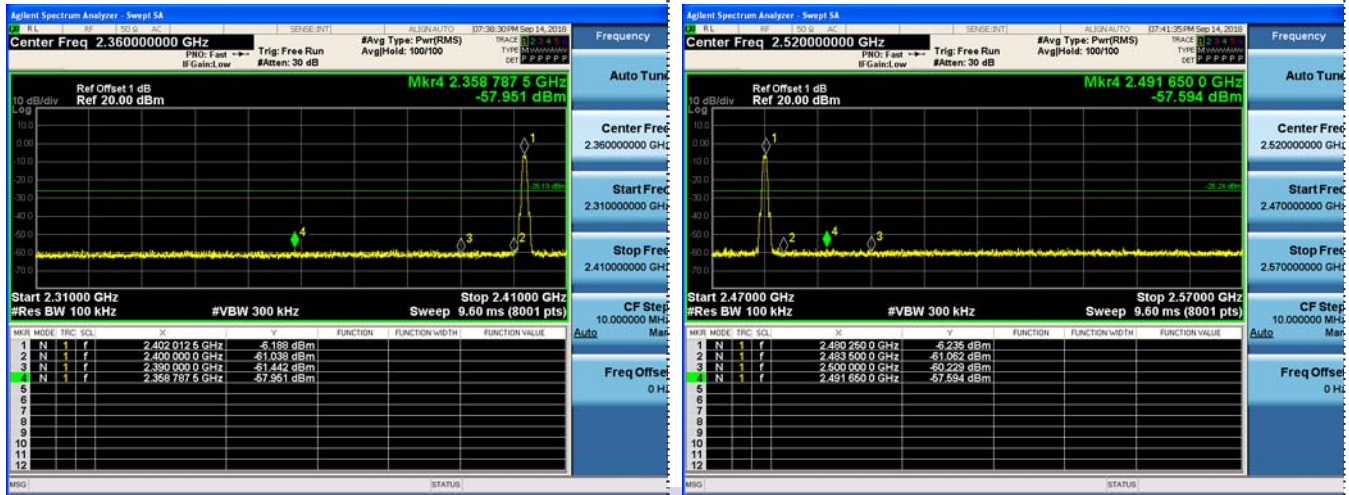

Left bandedge

Right bandedge

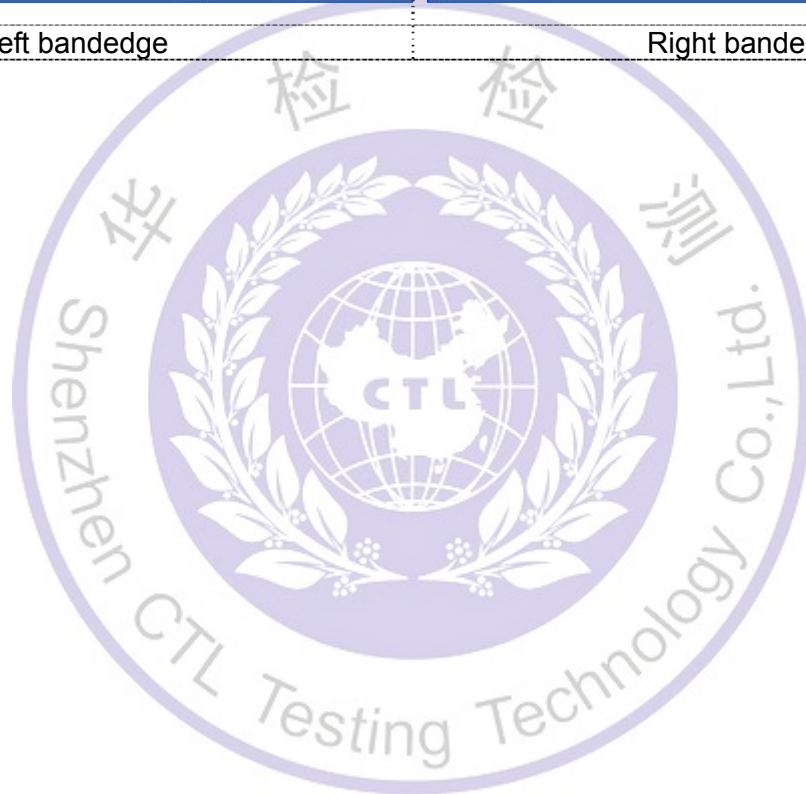

3.7. Antenna Requirement

Standard Applicable

For intentional device, according to FCC 47 CFR Section 15.203:

An intentional radiator shall be designed to ensure that no antenna other than that furnished by the responsible party shall be used with the device. The use of a permanently attached antenna or of an antenna that uses a unique coupling to the intentional radiator, the manufacturer may design the unit so that a broken antenna can be replaced by the user, but the use of a standard antenna jack or electrical connector is prohibited

FCC CFR Title 47 Part 15 Subpart C Section 15.247(c) (1) (I):

(i) Systems operating in the 2400-2483.5 MHz band that is used exclusively for fixed. Point-to-point operations may employ transmitting antennas with directional gain greater than 6dBi provided the maximum conducted output power of the intentional radiator is reduced by 1 dB for every 3 dB that the directional gain of the antenna exceeds 6dBi.

Test Result:

The maximum gain of antenna was 0dBi.

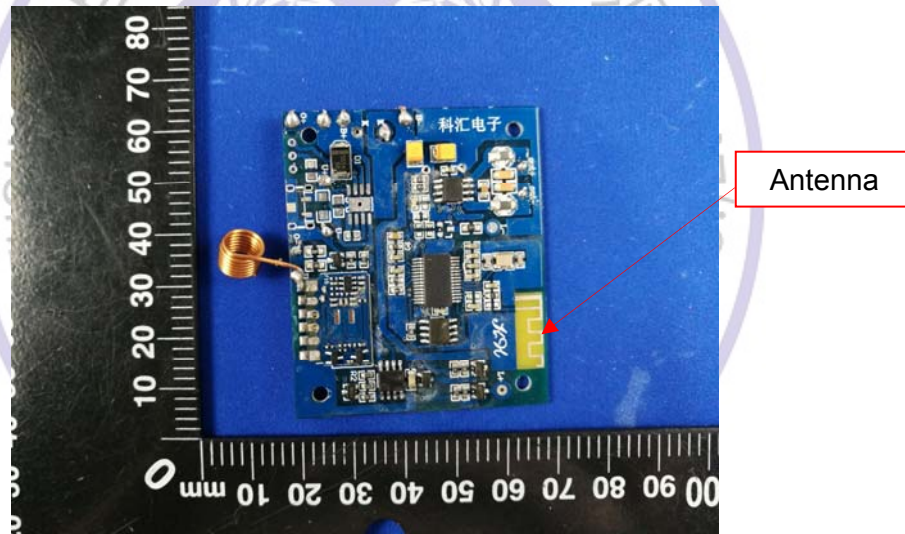

4. Test Setup Photos of the EUT



5. External and Internal Photos of the EUT

External Photos of EUT







Internal Photos of EUT



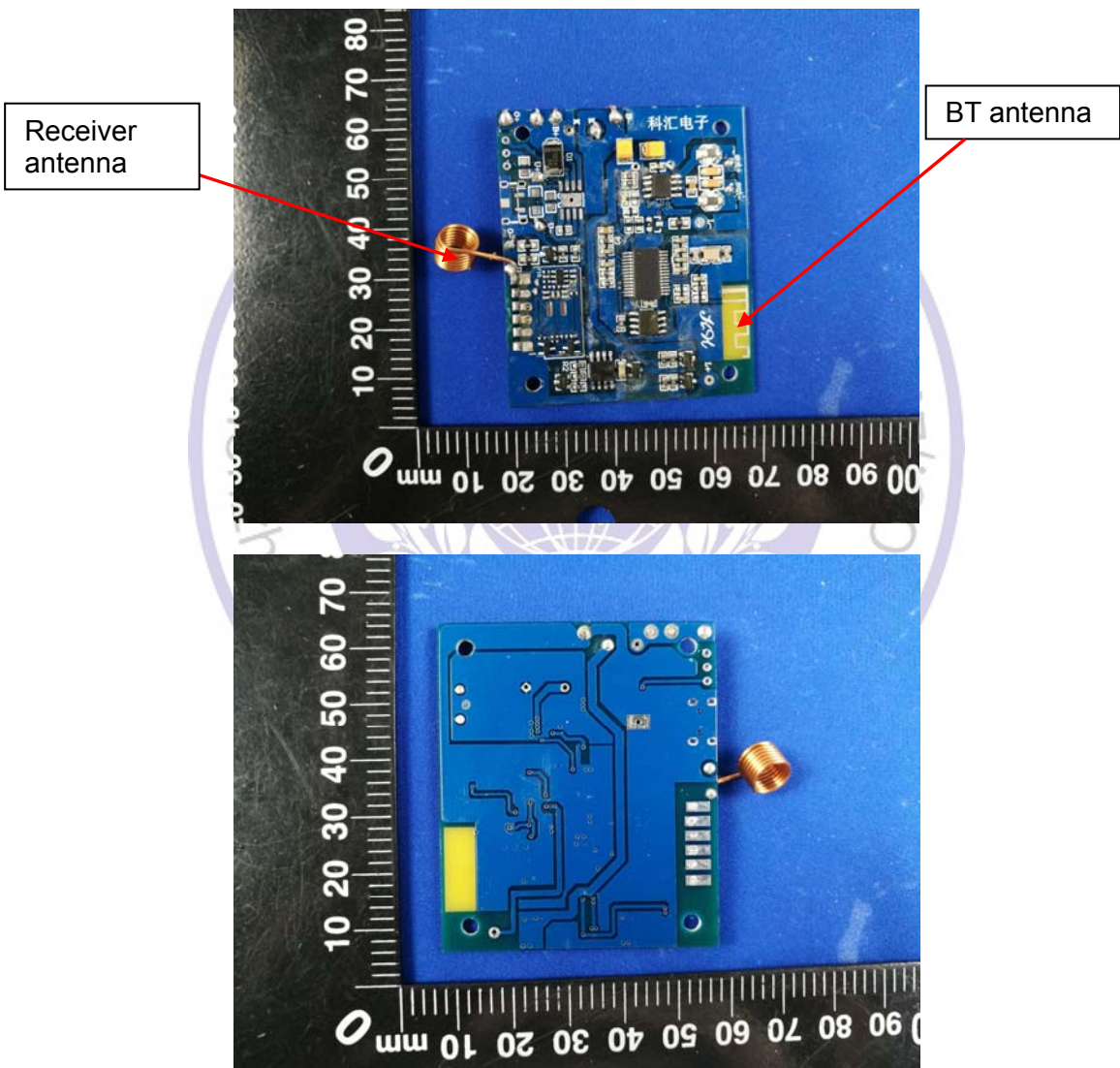
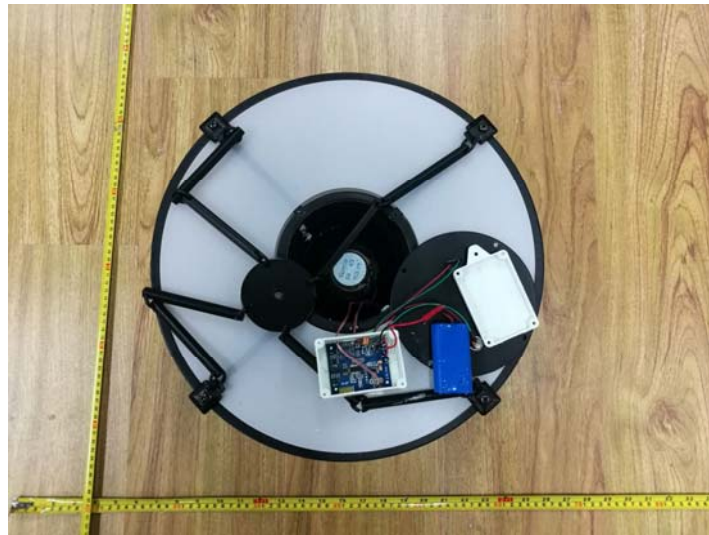

***** End of Report *****