

User Manual

Product Name: Key Master DP PLUS

Model: DP80, Key Master DP PLUS,X300 DP
PLUS ,Key Master DP 2,X300 DP 2,Key Master PAD,
X300 PAD,DP800,TW DP,TW PAD,MD DP,
MD PAD,DIAG MOTOR PAD

Manufacture: OBDSTAR Technology Co., Ltd

★Please read the manual carefully before operating your device.

Copyright information

Copyright 2017 by OBDSTAR Technology Co., Ltd. (called OBDSTAR for short) all rights reserved. No part of this publication may be reproduced, stored in a retrieval system, or transmitted in any form or by any means, electronic, mechanical, photocopying, recording or otherwise, without prior written permission of OBDSTAR. The information contained herein is designed only for the use of the unit. OBDSTAR is not responsible for any use of this information as applied to other use.

Neither OBDSTAR nor its affiliates shall be liable to the purchaser of this unit or third parties for damages, losses, costs, or expenses, incurred by purchaser or third parties as a result of : accident, misuse, or abuse of this unit or unauthorized modifications, repairs, or alternations to this unit, failure to strictly comply with OBDSTAR operating and maintenance instructions. OBDSTAR shall not be liable for any damages or problems arising from the use of any options or any consumable products other than those designated as original OBDSTAR products or the products approved by OBDSTAR.

Trademark Information

OBDSTAR is a registered trademark of OBDSTAR Technology Co., Ltd (called OBDSTAR for short) in China and other countries. In countries where any of the OBDSTAR trademarks, service marks, domain names, logos and company names are not registered, OBDSTAR claims other rights associated with unregistered trademarks, service marks, domain names, logos, and company names. Other products or company names referred to in this manual may be trademarks of their respective owners. You may not use any trademark, service mark, domain name, logo, or company name of OBDSTAR or any third party without permission from the owner of the applicable trademark, service mark, domain name, logo, or company name. You may contact OBDSTAR by visiting the website at www.obdstar.com, or writing to OBDSTAR Technology Co., LTD., West Block 4 floor. NO. 8 building of Xinwu industrial area, Taoyuan Street, Nanshan District, Shenzhen, Guangdong, China, to request written permission to use Materials.

Safety Precautions

Before using Key Master DP PLUS, please read the following safety information carefully.

1. Never collide, throw, or punch Key Master DP PLUS, and avoid falling, extruding and blending it.
2. Do not use Key Master DP PLUS in exceptionally cold or hot, dusty, damp or dry environments.
3. In places where Key Master DP PLUS is forbidden or using Key Master DP PLUS may cause interference or generate a potential risk, please turn off it.
4. Do not use Key Master DP PLUS while driving.
5. Turn off Key Master DP PLUS before boarding any airplane.
6. Never place Key Master DP PLUS into apparatus with strong electromagnetic field.
7. Do not dismantle Key Master DP PLUS by yourself. If there is any inquiry, please contact the dealer.
8. Keep Key Master DP PLUS far away from magnetic devices because its radiations may erase

the data stored on the devices.

OBDSTAR Key Master DP PLUS User's Manual

9. Do not use Key Master DP PLUS in high temperature and other environment with flammable gas, such as gas station.
10. Store Key Master DP PLUS out of the reach of children and do not allow children to use it in unsupervised state.
11. Please use the included battery and charger. Otherwise, explosion may happen.
12. Adhere to laws and regulation, respect people's privacy and legal rights, during operating Key Master DP.
13. Follow the instructions strictly when using USB cable, otherwise, it will damage your Key Master DP and PC.

Precautions on Using Key Master DP PLUS

- The ignition switch should be OFF while plugging or unplugging the diagnostic connector.
- Do not disconnect the vehicle inner consumer when the ignition switch is on. High voltage transients may encounter at the moment of disconnecting, which may damage the sensors and the ECU.
- Keep the computer away from magnetic object.
- Do cut off the power supply of ECU system before welding on the vehicle.
- Pay more attention to the ECU and the sensors when the operation is next to them.
- Ground yourself when you disassemble PROM, otherwise, ECU and sensors will be damaged by static electricity.
- Do connect ECU harness connector firmly, otherwise, electronic elements, such as IC inside ECU, will be damaged.

Content

| | |
|--|----|
| 1 INTRODUCTION | 1 |
| 1.1 PRODUCT PROFILE..... | 1 |
| 1.2 FEATURES | 1 |
| 1.3 KNOWLEDGE OF Key Master DP PLUS..... | 1 |
| 1.3.1 Key Master DP PLUS whole set..... | 1 |
| 1.3.2 Key Master DP PLUS Tablet Computer | 2 |
| 1.4 TECHNICAL PARAMETER..... | 3 |
| 1.5 Accessory | 3 |
| 1.5.1 Main Test Cable..... | 3 |
| 1.5.2 OBD Connector..... | 4 |
| 1.5.3 Others..... | 4 |
| 2 PREPARATION | 5 |
| 2.1 CHARGE Key Master DP PLUS..... | 5 |
| 2.2 USING BATTERY | 5 |
| 2.3 POWER ON/POWER OFF Key Master DP PLUS..... | 6 |
| 2.3.1 POWER ON | 6 |
| 2.3.2 POWER OFF | 6 |
| 2.4 ABOUT DESKTOP | 6 |
| 2.5 CUSTOMIZE YOUR DESKTOP | 6 |
| 2.5.1 Add items on the desktop | 6 |
| 2.5.2 Move items on the desktop | 6 |
| 2.5.3 Delete items on the desktop | 7 |
| 2.5.4 Change your wallpaper | 7 |
| 2.5.5 Create a folder on the desktop..... | 7 |
| 2.6 ON USING TOUCH SCREEN | 7 |
| 2.7 AUTO-ROTATE THE SCREEN..... | 7 |
| 2.8 LOCK&UNLOCK..... | 7 |
| 2.8.1 Lock the screen | 7 |
| 2.8.2 Unlock the screen..... | 8 |
| 2.9 NOTIFICATION BAR..... | 8 |
| 2.9.1 Turn on the notification panel..... | 8 |
| 2.9.2 Turn off the notification panel | 8 |
| 2.10 INPUT METHOD..... | 8 |
| 2.11 HOW TO SET AS AIRPLANE MODE..... | 8 |
| 3 HOW TO DIAGNOSE | 9 |
| 3.1 CONNECT VEHICLE | 9 |
| 3.2 DIAGNOSIS FLOWCHAT..... | 9 |
| 3.3 USER REGISTRATION & DIAGNOSTIC SOFTWARE DOWNLOADING..... | 9 |
| 3.3.1 User registration..... | 10 |
| 3.3.2 Download diagnosis software | 11 |

| | |
|--|----|
| 3.3.3 Diagnostic software main interface introduction..... | 12 |
| 3.4 Start Diagnosing | 13 |
| 3.4.1 Read vehicle information | 16 |
| 3.4.2 Read trouble code | 16 |
| 3.4.3 Clear trouble code..... | 17 |
| 3.4.4 Read data stream | 17 |
| 3.5 MAINTENANCE DATABASE | 18 |
| 3.6 VIDEO CENTER..... | 18 |
| 3.7 ONE KEY UPGRADE..... | 18 |
| 3.8 SYSTEM SETTINGS | 19 |
| 3.8.1 VCI Information | 19 |
| 3.8.2 Language | 19 |
| 3.8.3 Unit..... | 20 |
| 3.8.4 Data records | 20 |
| 3.8.5 User information | 22 |
| 3.8.5.1 User login | 21 |
| 3.8.5.2 User registration..... | 23 |
| 3.8.5.3 Forget Password | 23 |
| 3.8.5.4 Registration information | 24 |
| 3.8.5.5 Modify Information | 24 |
| 3.8.5.6 Modify Password..... | 25 |
| 3.8.6 Help | 25 |
| 3.8.7 About..... | 26 |
| 3.9 Remote Assistance | 26 |
| 3.10 REPORT CENTER | 26 |
| 4 OTHERS..... | 27 |
| 4.1 EMAIL | 27 |
| 4.1.1 Add an email account..... | 27 |
| 4.1.2 Delete an email account..... | 28 |
| 4.1.3 Send an email..... | 28 |
| 4.1.4 View email..... | 28 |
| 4.2 WLAN | 30 |
| 4.2.1 Open WLAN..... | 28 |
| 4.2.2 Connect WLAN..... | 28 |
| 4.3 Browser | 28 |
| 4.3.1 Open browser..... | 29 |
| 4.3.2 Browser webpage..... | 29 |
| 4.3.3 Zoom in/Zoom out a page | 29 |
| 4.3.4 Save favorite webpage to bookmark..... | 29 |
| 4.3.5 Open multiple pages | 29 |
| 4.3.6 Customize internet settings..... | 30 |
| 4.4 CAMERA | 30 |
| 4.4.1 Open and close camera..... | 31 |
| 4.4.2 Take a photo | 32 |

| | |
|--|----|
| 4.4.3 View a photo | 32 |
| 4.4.4 Record a video..... | 32 |
| 4.4.5 View a video | 32 |
| 4.4.6 Customize camera settings..... | 33 |
| 4.4.7 Customize camrecorder setting..... | 33 |
| 4.5 GALLERY | 33 |
| 4.5.1 Open gallery | 33 |
| 4.5.2 Browse images | 34 |
| 4.6 MUSIC..... | 34 |
| 4.7 CALCULATOR..... | 34 |
| 4.8 CALENDAR | 34 |
| 4.9 ALARMS..... | 34 |
| 4.9.1 Add an alarm | 34 |
| 4.9.2 Delete an alarm..... | 35 |
| 4.9.3 Customize your alarm | 35 |
| 4.9.4 Countdown set | 35 |
| 4.9.5 Second clock setting | 35 |
| 4.10 ES FILE VIEWER..... | 34 |
| 4.11 DISPLAY..... | 34 |
| 4.11.1 Brightness..... | 34 |
| 4.11.2 Auto-rotate the screen | 34 |
| 4.12 SET SCREEN LOCK | 34 |
| 4.13 APPLICATION | 35 |
| 4.13.1 View installed applications..... | 35 |
| 4.13.2 View the running applications..... | 35 |
| 4.14 LANGUAGE & INPUT METHOD..... | 35 |
| 4.15 SET DATE & TIME..... | 35 |
| 4.16 RESTORE KEY MASTER TO FACTORY SETTINGS..... | 36 |
| 4.17 STORE | 36 |
| 4.18 APPS INSTALLATION/ UNINSTALLATION | 36 |
| Attachments..... | 37 |

1 INTRODUCTION

1.1 PRODUCT PROFILE

Key Master DP Plus is a new Android-based vehicle trouble diagnostic device developed for internet applications. It inherits from OBDSTAR advanced diagnosing technology and it characterized by covering wide range of vehicles, featuring powerful function, and providing precise result. Through vehicle diagnostic OBD connector and variant mobile intelligent terminals, it achieves vehicle trouble diagnosis for full car model and full system vehicle.

Meanwhile, taking advantage of mobile internet, Key Master DP Plus integrates more application and service, such as Maintenance Database, remote assistant, One Key Update etc.

1.2 FEATURES

1. Diagnostic function:

- Can diagnose the electronic control system of prevailing vehicle models covering Asian, European, American and Chinese. Diagnosis functions include: Read DTCs, Clear DTCs, Read data stream, Special functions etc.
- Classify special function: ABS, EEPROM Adapter, Battery match, CVT learning, EPB, Gear learning, Immobilizer, TPMS (low tire) reset, Mileage adjustment, ECU programming, steering angle reset.
- Specially designed for Android platform with clear and user-friendly interface;

2. Maintenance database: equipped with powerful database.

3. Video center: large amount of videos help users to operate device easily.

4. One Key Upgrade: built-in WIFI mode can realize application downloading and diagnostic function by one key upgrade.

5. System setting: set VCI formation, language, unit, data logging, user information etc.

6. Remote assistance: achieve remote assistance by this function.

7. Report center: record maintenance data logging and create reports during operation.

1.3 KNOWLEDGE OF KEY MASTER DP PLUS

1.3.1 Key Master whole set

Key Master DP PLUS is composed of Key Master DP PLUS tablet computer, main test cable and sort of connectors.

1.3.2 Key Master DP PLUS Tablet Computer

Product Picture:



1.4 TECHNICAL PARAMETER

- Operation system: Android 5.1.1
- CPU: Exynos4418 Dual Core ARM Cortex A9 1.4GHz
- Battery: 3700mh, rechargeable polymer lithium battery
- Extension memory card: 32G Micro SD (TF)card supported
- Memory capacity: 2GB
- Storage capacity: 32GB
- LCD: 8.0 inch
- LCD resolution: 1280*800
- Touch screen: capacitive touch screen
- Camera: 5 mega rear view camera
- Wi-Fi: supported
- Working temperature: -10°C~55°C (14°F~131°F)
- Storage temperature: -20°C~70°C (-4°F~158°F)
- Weight: about 1.0 Kg
- Dimension: 254mm*174*mm*35mm

1.5 ACCESSORY (Standard Configuration)

1.5.1 Main Test Cable

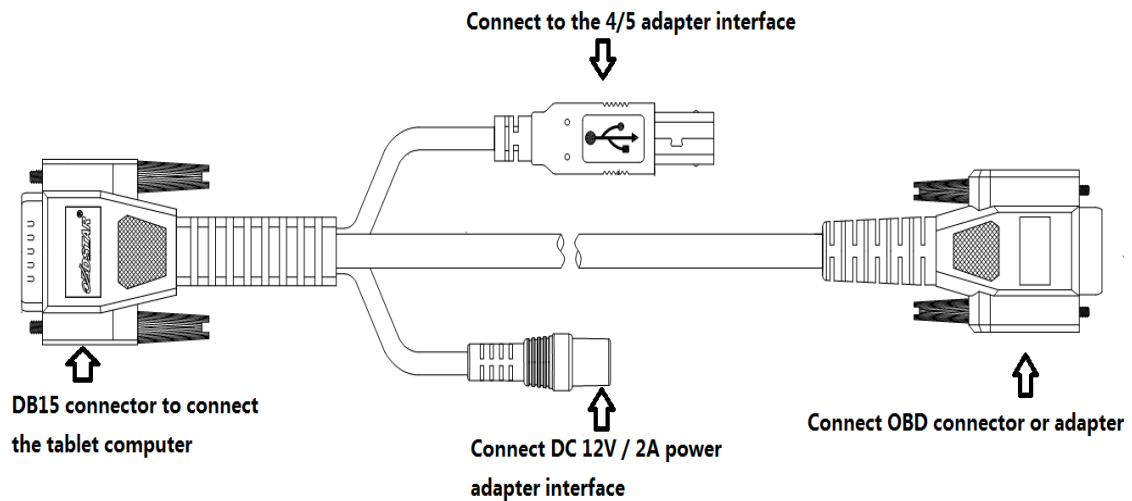

1.5.2 OBD Connector

OBD I connector to connect the diagnosis port of non-OBD II vehicles.

To choose the connector according to the vehicle brand and models.

Common connectors are as below:

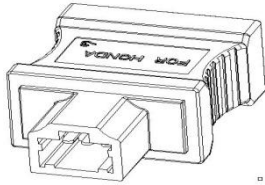

HONDA 3

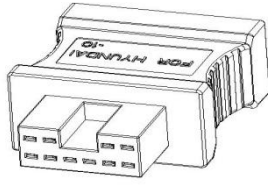

HYUNDAI 10

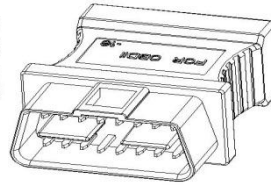

OBD16

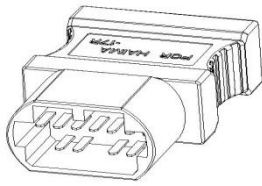

HAIMA 17

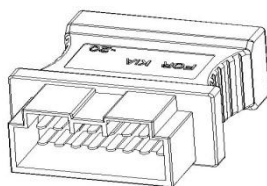

KIA20

1.5.3 Others

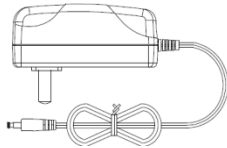

DC Power Adapter (Output DC 12V/2A)

To power up the tablet via connecting with outside power supply

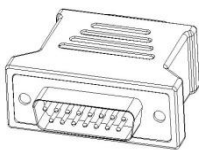

Adapter DB15-HDB15

Connect with EEPROM/PIC adapter via adapter



User Manual

To learn more about the product and operation

2 PREPARATION

2.1 CHARGE KEY MASTER DP PLUS

1. Connect the included USB cable with charger.
2. Plug the charger into AC outlet.
3. When it connects to charger, battery logo indicates



, it indicates that the battery is in charging

4. When battery logo changes into



, it indicates that the battery is fully charged and then disconnect charger from AC outlet.

5. Unplug USB cable on the charger from Key Master DP Plus.



2.2 USING BATTERY

- If the battery keeps unused for a long time or battery is completely discharged, it is normal if it can not be turned on while being charged. Please charge it for a period and then turn it on.
- Using data service will cause more power consumption and shorten the standby time.
- The charging time of battery varies with temperature condition and battery consumption status.
- While Key Master DP Plus has low battery, a beep will sound. If it is very low, Key Master DP Plus will be switched off automatically.

Note: Do one of the followings to save power:

1. When Key Master DP Plus keeps unattended, press POWER key to turn off the LCD.
2. Shorten the standby time: Enter main menu, choose "Settings" > "DEVICE"> "Display" > "Sleep" to select a shorter standby time.
3. Decrease the brightness of LCD display: Enter main menu, choose "Settings" > "DEVICE" > "Display" > "Brightness", and then drag the slider to adjust it.
4. Change "Live wallpaper" into "Gallery".
5. Set Bluetooth off: Enter main menu, choose "Settings" > "Wireless & Network" > "Bluetooth", and then toggle the switch to OFF.
6. Set Wi-Fi off: Enter main menu, choose "Settings" > "Wireless & Network" > "Wi-Fi", and then toggle the switch to OFF.

7. Press VOLUME key to decrease the volume.

2.3 POWER ON/POWER OFF KEY MASTER DP PLUS

2.3.1 POWER ON

Press and hold Power button for three seconds to turn on Key Master DP Plus.

Note: set date, time and time zone.

2.3.2 POWER OFF

1. Press and hold Power button for three seconds to turn off Key Master DP Plus.

2.4 ABOUT DESKTOP

The screen is shown as blow:

A. Print screen : make a quick screenshot and save it to gallery

B. Back button : go back to previous interface or exit program.

C. Home button : return to the desktop

D. Touch screen menu button : select desired item

E. DP button : enter diagnose and program interface

F. VIC button : enter system settings

2.5 CUSTOMIZE YOUR DESKTOP

2.5.1 Add items on the desktop

On the main menu, hold and press the desired item, the system will automatically enter the desktop and place the icon into the circle.

Hint: If many applications occupy the desktop, hold and press the desired one to move it to other extension desktop.

2.5.2 Move items on the desktop

1. Hold and press the item to be moved.
2. After a movable circle appears on the screen, drag it to the target location.

2.5.3 Delete items on the desktop

1. Hold and press the desired item, "X Delete" appears in the upper middle of the screen.
2. Drag the item to "X Delete".
3. When the item and icon turn red and then release it.

2.5.4 Change your wallpaper

1. Hold and press a blank area on the desktop, a pop-up wallpaper will be shown on the screen.
2. Choose desired wallpaper.
3. Click upper left corner ✓ to set wallpaper.

2.5.5 Create a folder on the desktop

1. Drag one icon to another icon, the system will create a folder.
2. Input the folder name.

2.6 ON USING TOUCH SCREEN

- Tap: Use your finger to tap desired items to confirm or open it.
- Long-press: press and hold the current interface, icon or input field to open the available operation options.
- Slide: use your finger to slide the screen horizontally or vertically.
- Drag: hold and press the desired item, then drag it to any location.

2.7 AUTO-ROTATE THE SCREEN

To perform such operations as browsing webpage, viewing images etc, rotate Key Master DP Plus, the screen will automatically change the display direction. To disable this function, click "Settings" and click "display" to enter. Unselect the option "Auto-rotate the screen".

2.8 LOCK&UNLOCK

2.8.1 Lock the screen

- When Key Master is ON, press POWER key to lock the screen.
- The system will lock the screen automatically after Key Master DP Plus remains idle for a long time.

2.8.2 Unlock the screen

Press POWER key to activate the screen and then drag the lock to “Unlock position.”

2.9 NOTIFICATION BAR

The notice bar is used to display some activities, messages to remind and inform users.

2.9.1 Turn on the notification panel

1. When a new notification icon appears on the status bar, slide the status bar upwards to open it.
2. In the notification panel, click the desired notification item to open it.

2.9.2 Turn off the notification panel

Slide the panel upwards, and then specify the notifications as OFF to turn it off.

2.10 INPUT METHOD

Set input method:

Enter main menu, and then select “Settings”->“Language and keyboard” to choose desired input method.

The default input method, Sogou input can support powerful word stock engine, intelligent Sogou input and multiple keyboard mode. Android keyboard and Google input method and make input easier. To start text input mode, please click any text input entry.

2.11 HOW TO SET AS AIRPLANE MODE

According to the regulations of some countries or areas, PC device must be turned off before boarding on the airplane. The way to disable functions of Key Master DP Plus is to set it as airplane mode. In this mode, all wireless radio waves will be disabled, including mobile network, Bluetooth and WLAN.

Do one of the followings to enable or disable airplane mode:

- Press POWER key and choose "Airplane mode" from the pop-up option menu.
- Access the main menu, and choose "Settings" > "WLAN" > "More..." > "Airplane mode".

3 HOW TO DIAGNOSE

3.1 CONNECT VCI CONNECTOR

Procedure to connect VCI connector:

1. Locate vehicle's DLC socket. The DLC (Data Link Connector or Diagnostic Link Connector) is the standardized 16-cavity connector where diagnostic code readers interface with the vehicle's on-board computer. The DLC is usually located 12 inches from the center of the instrument panel (dash), under or around the driver's side for most vehicles. If Data Link Connector is not located under dashboard, a label should be there telling location. For some Asian and European vehicles, the DLC is located behind the ashtray and the ashtray must be removed to access the connector. If the DLC cannot be found, refer to the vehicle's service manual for the location.



2. Plug the diagnostic connector into the vehicle's DLC socket (It is suggested to use the OBD 2 extension cable to connect VCI connector and DLC socket.). For non-16PIN DLC socket, please select the corresponding non-16 pin connector adapter, then plug the non-16 pin end of the adapter into the DLC socket, and then connect the standard 16 pin end VCI connector.

3.2 DIAGNOSIS FLOWCHAT

For new users, please follow the 3.1 to get familiar with and start using Key Master DP PLUS.
 connect the diagnostic connector →user registration→user login→download or upgrade software→select function or vehicle type→proceed diagnosis

3.3 USER REGISTRATION & DIAGNOSTIC SOFTWARE DOWNLOADING

3.3.1 User registration

Click  to enter diagnostic software, select “the user information” in “settings” menu, then enter user registration window. As shown in following photo:



Fill in the information in each field (Items with * must be filled). After inputting, tap “OK”
 If you have registered to be a member, click “the user information” to enter user login page, as following picture shown:

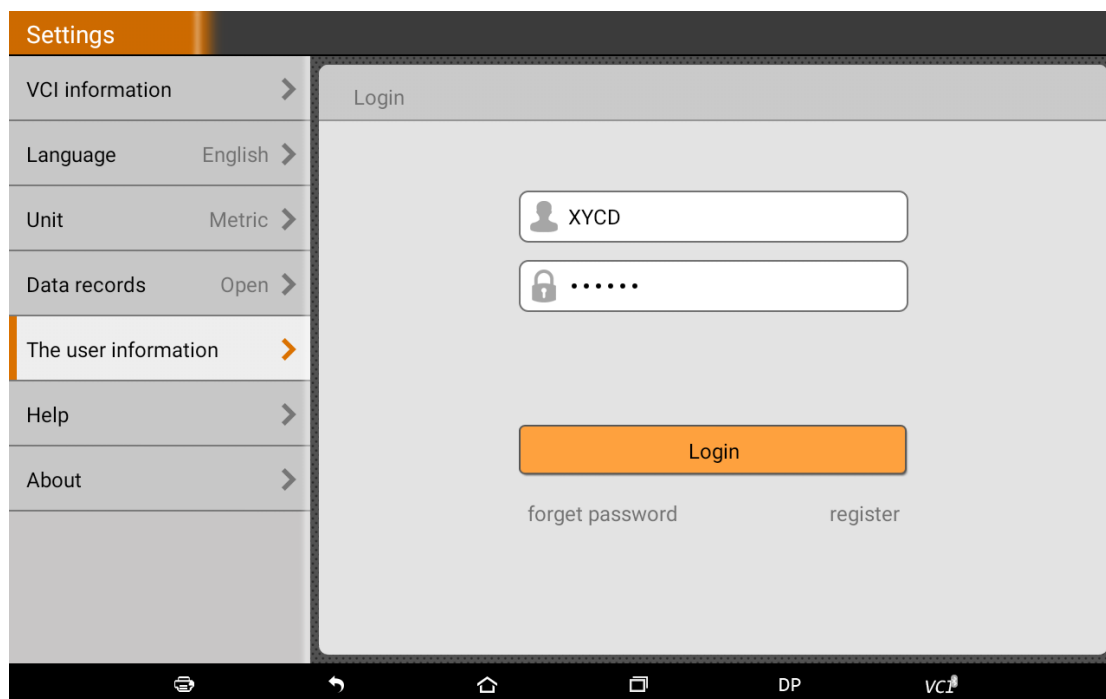

3.3.2 Download diagnosis software

Tap “One Key Upgrade” to enter one key upgrade page, as following picture shown:

| One Key Upgr... | | | | | SN:81330000050 |
|--------------------------|-------------------------|-----------------|----------------|------|------------------------------|
| <input type="checkbox"/> | Software name | Current version | Update version | 0/61 | Batch update |
| <input type="checkbox"/> | QNLLOTUS IMMO | 0.0 | 30.04 | | Download ready |
| <input type="checkbox"/> | QOROS IMMO | 0.0 | 30.03 | | Download ready |
| <input type="checkbox"/> | RENAULT IMMO | 0.0 | 30.01 | | Download ready |
| <input type="checkbox"/> | ROEWE IMMO | 0.0 | 31.05 | | Download ready |
| <input type="checkbox"/> | SGMW IMMO | 0.0 | 30.08 | | Download ready |
| <input type="checkbox"/> | SMART IMMO | 0.0 | 30.01 | | Download ready |
| <input type="checkbox"/> | SSANGYONG IMMO | 0.0 | 30.02 | | Download ready |
| <input type="checkbox"/> | SUBARU IMMO | 0.0 | 30.06 | | Download ready |
| <input type="checkbox"/> | SUZUKI IMMO | 0.0 | 30.05 | | Download ready |
| <input type="checkbox"/> | TOYOTA/LEXUS IMMO | 0.0 | 31.05 | | Download ready |
| <input type="checkbox"/> | VW/AUDI/SKODA/SEAT IMMO | 0.0 | 31.09 | | Download ready |

Tap “One Key Upgrade” to start downloading, enter main interface after finishing downloading. (Notes: Ensure internet connection is normal when updating. Besides, because of many software, it may take several minutes, please wait patiently) If need to cancel a software, just tap corresponding Check Box as following picture shown:

| One Key Upgr... | | | | SN:813300000050 | |
|-------------------------------------|-----------------------|-----------------|----------------|------------------|------|
| <input checked="" type="checkbox"/> | Software name | Current version | Update version | 16/60 | Stop |
| <input checked="" type="checkbox"/> | DFFENGSHEN IMMO | 0.0 | 30.07 | Unzip complete | |
| <input checked="" type="checkbox"/> | DFLIUZHOU IMMO | 0.0 | 30.11 | 15.1% [中文简体 1/1] | |
| <input checked="" type="checkbox"/> | FAW JIABAO | 0.0 | 30.01 | Unzip complete | |
| <input checked="" type="checkbox"/> | FIAT IMMO | 0.0 | 30.08 | Unzip complete | |
| <input checked="" type="checkbox"/> | FORD IMMO | 0.0 | 31.09 | Unzip complete | |
| <input checked="" type="checkbox"/> | GEELY/HUAPU/SQYL IMMO | 0.0 | 30.13 | 33.8% [中文简体 1/1] | |
| <input checked="" type="checkbox"/> | GM IMMO | 0.0 | 30.42 | 15.2% [中文简体 1/1] | |
| <input checked="" type="checkbox"/> | GREATWALL IMMO | 0.0 | 31.24 | -0.0% [中文简体 1/1] | |
| <input checked="" type="checkbox"/> | HAFEI IMMO | 0.0 | 30.03 | Download ready | |
| <input checked="" type="checkbox"/> | HAWTAI IMMO | 0.0 | 30.09 | Download ready | |
| <input checked="" type="checkbox"/> | HIMIKO IMMO | 0.0 | 30.00 | Download ready | |
| <input checked="" type="checkbox"/> | HONDA IMMO | 0.0 | 30.00 | Download ready | |

3.3.3 Diagnostic software main interface introduction

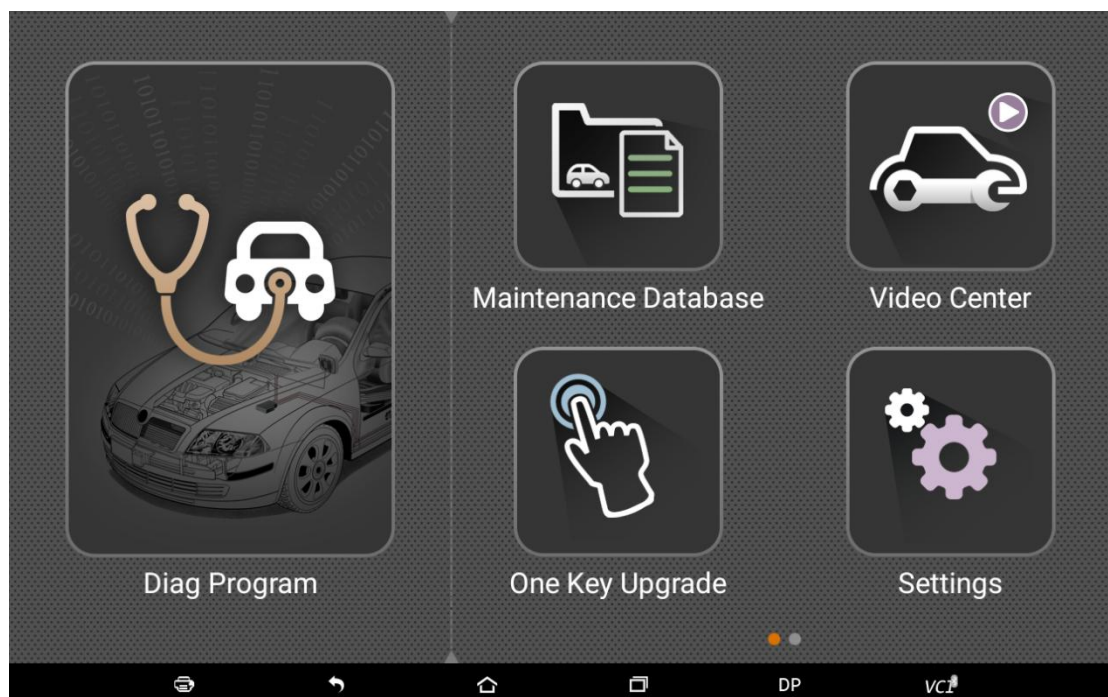

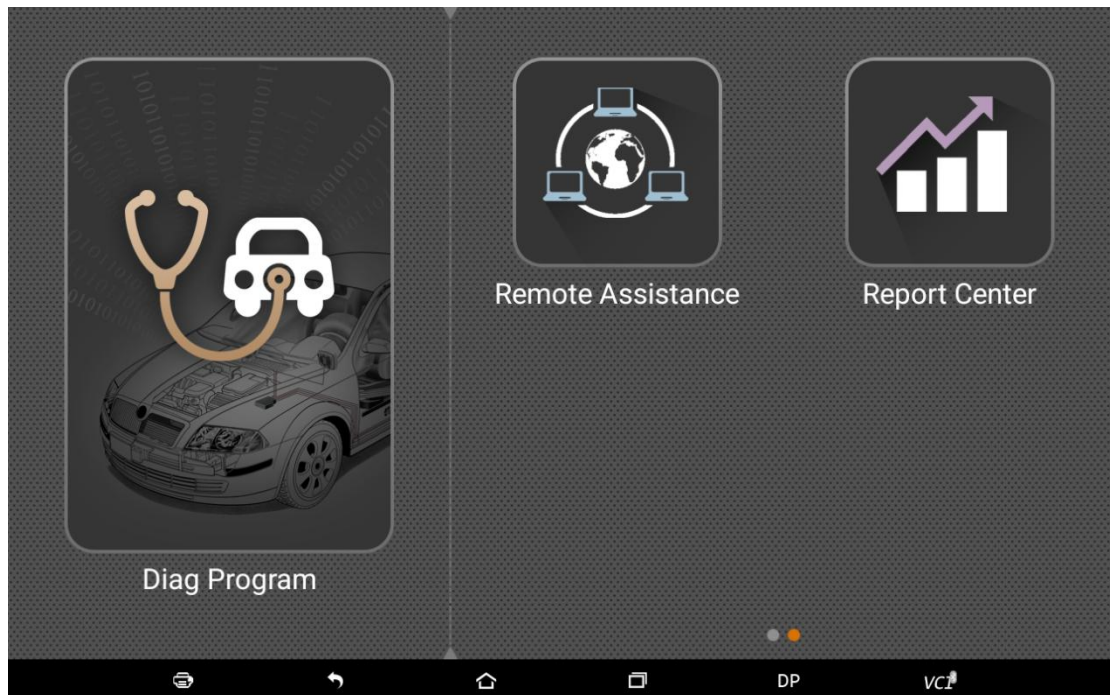

Function menu included as follows:

Diag Program: operate as a diagnostic tool.

Maintenance Database: Provides abundant automotive technology, handbook and repair case for your reference.

Video Center: to guide users by video.

One Key Upgrade: To download diagnostic software or upgrade diagnostic software to the latest version.

Settings: It includes VCI information, language, unit, data records, user information, help, about.

Remote assistance: Can realize remote hosting operation.

Report Center: Can record maintenance data and diagnostic report.

Inspection Camera: To do a complete detection via flexible tube with HD camera into the vehicles.

3.4 Start Diagnosing

Tap on the main menu screen, and then choose "DP" to enter the function selection and vehicle selection page. As following photo shown:



Hereinafter, take OBDII for example, to introduce how to start diagnosing.
 Tap " OBDII ", and tap "OBDII" icon. As following photo shown:



To select software version, as following photo shown:

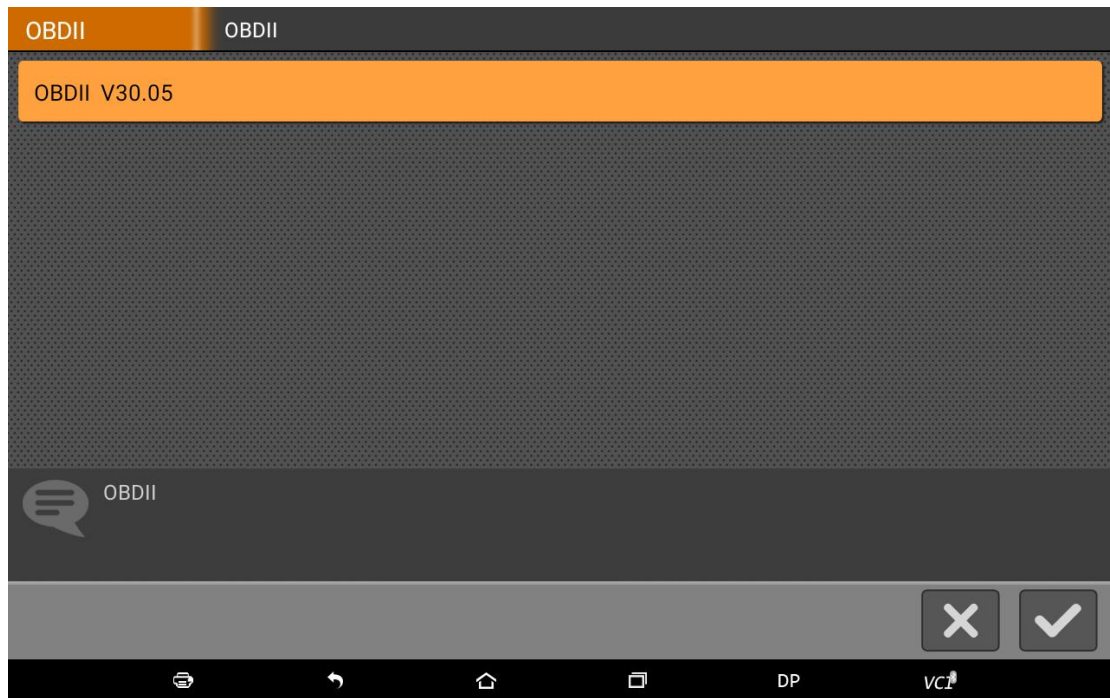

To enter diagnostic function menu, as following photo shown:



To select AUTO SCAN, as following photo shown:

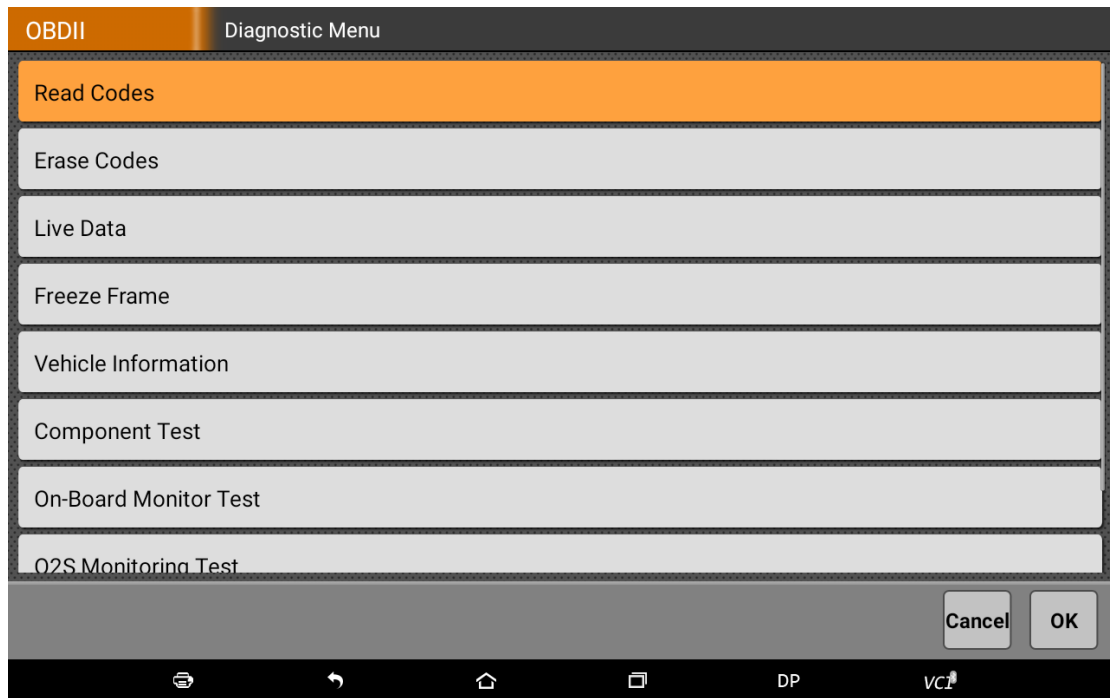

3.4.1 Read vehicle information

Tap "Read vehicle information", as following photo shown:

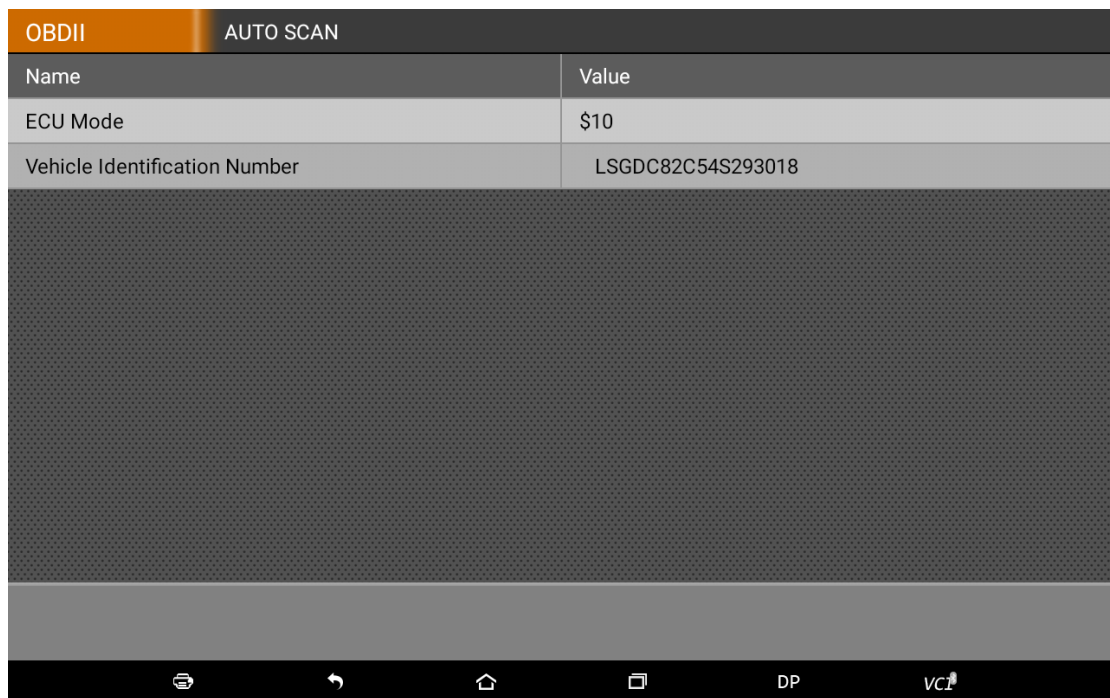

3.4.2 Read trouble code

Tap "Read trouble code", as following photo shown:

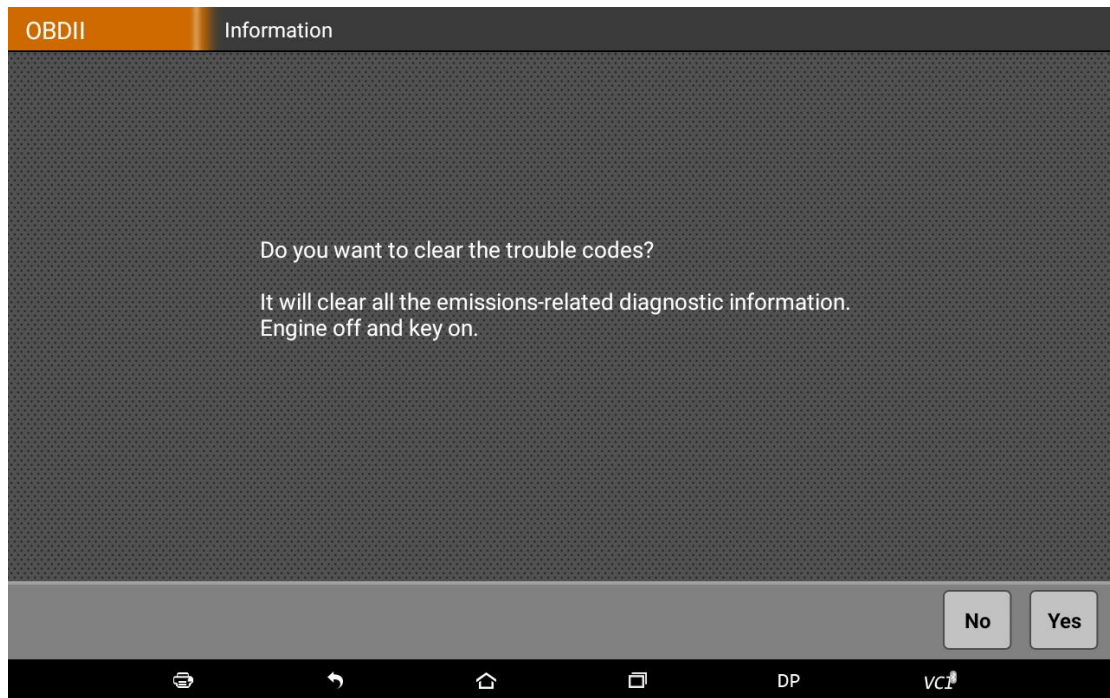

3 .4.3Clear trouble code

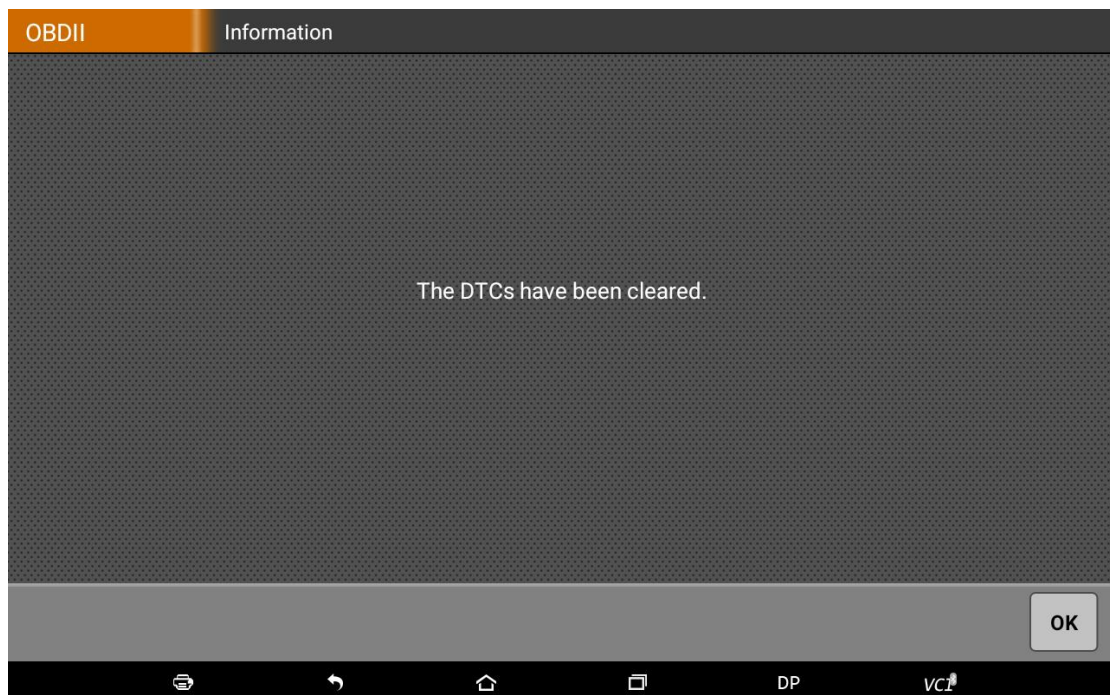

3.4.4 Read data stream

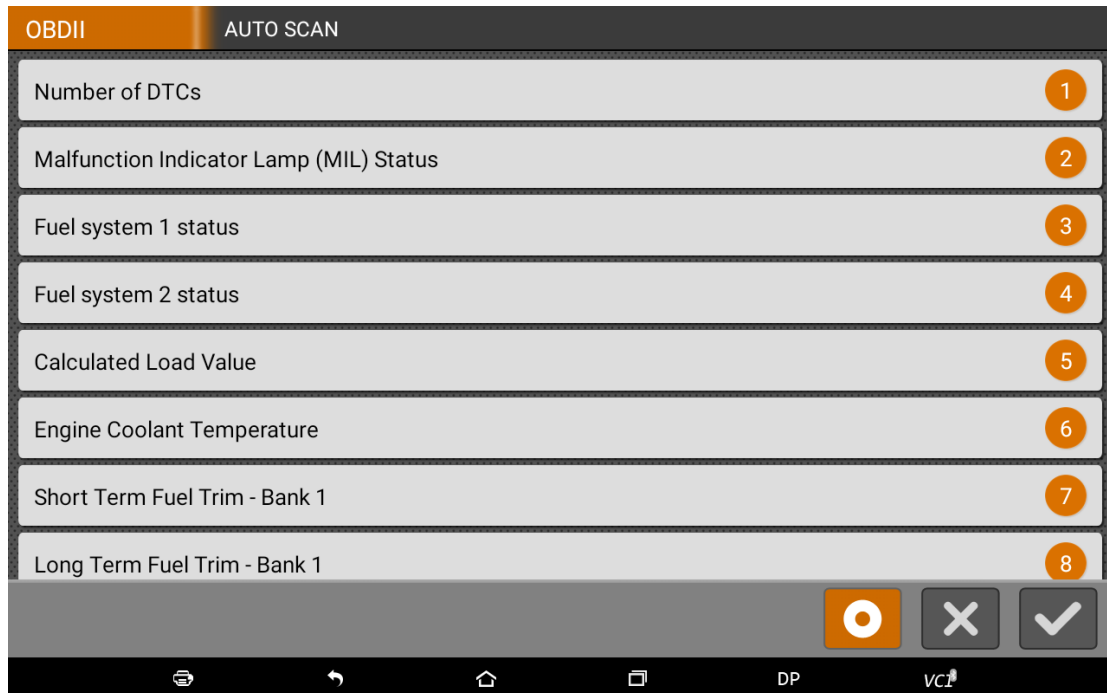

| Data stream name | Value | Unit |
|---|----------|-------|
| Fuel system 1 status | OL | |
| Fuel system 2 status | Not Used | |
| Calculated Load Value | 0.0 | % |
| Engine Coolant Temperature | -39 | deg C |
| Short Term Fuel Trim - Bank 1 | -0.0 | % |
| Long Term Fuel Trim - Bank 1 | -0.0 | % |
| Intake Manifold Absolute Pressure | 10 | Kpa |
| Engine RPM | 0 | Rpm |
| Vehicle Speed Sensor | 0 | Km/H |
| Ignition Timing Advance for #1 Cylinder | 0.0 | deg |
| Intake Air Temperature | -39 | deg C |

3.5 MAINTENANCE DATABASE

We have powerful database maintenance.

3.6 VIDEO CENTER

We have the details of the operation method of video.

3.7 ONE KEY UPGRADE

Can download and upgrade software by “One Key Upgrade”



Tap main screen “batch update” , start downloading and upgrading

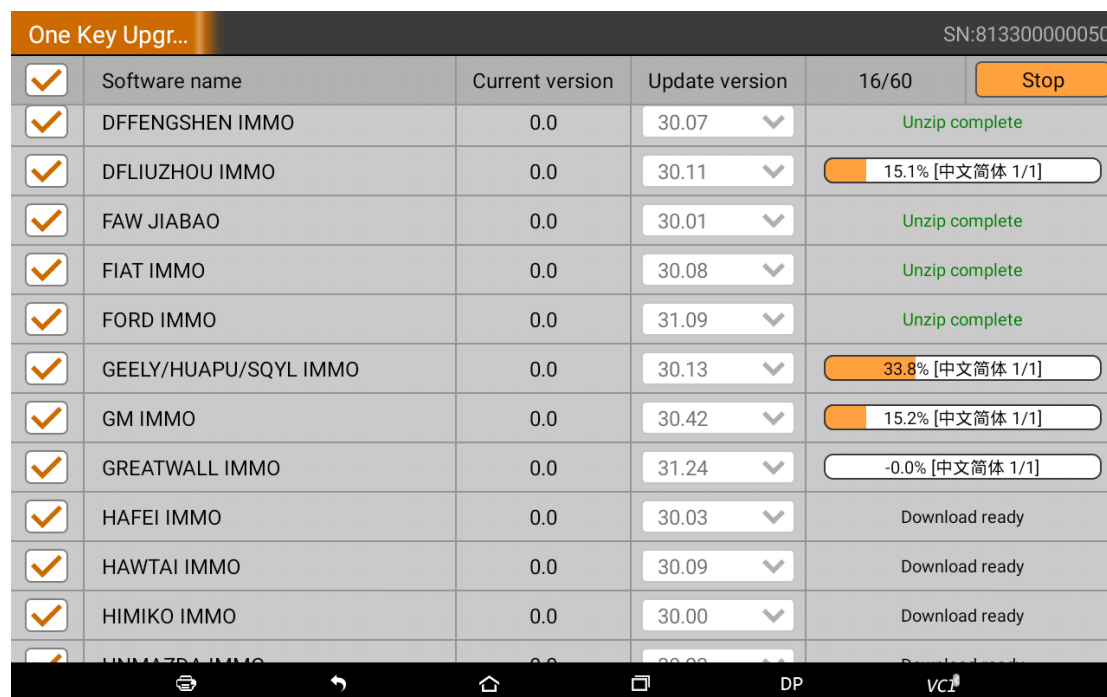

3.8 SYSTEM SETTINGS

It includes VCI information, language, unit, data records, user information, help, about.

3.8.1 VCI Information

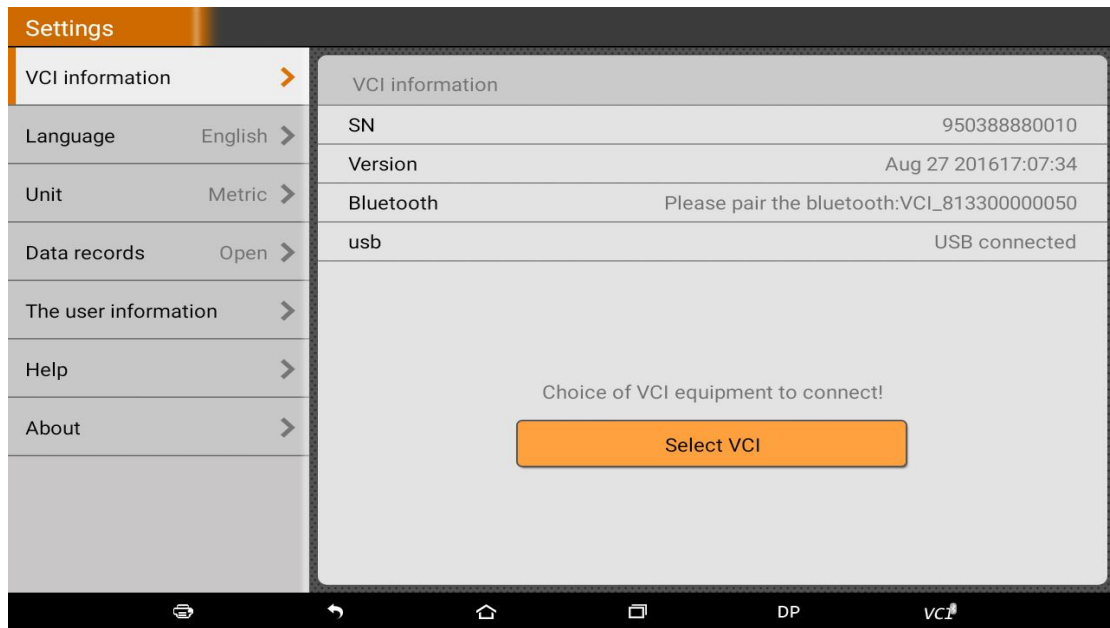

3.8.2 Language

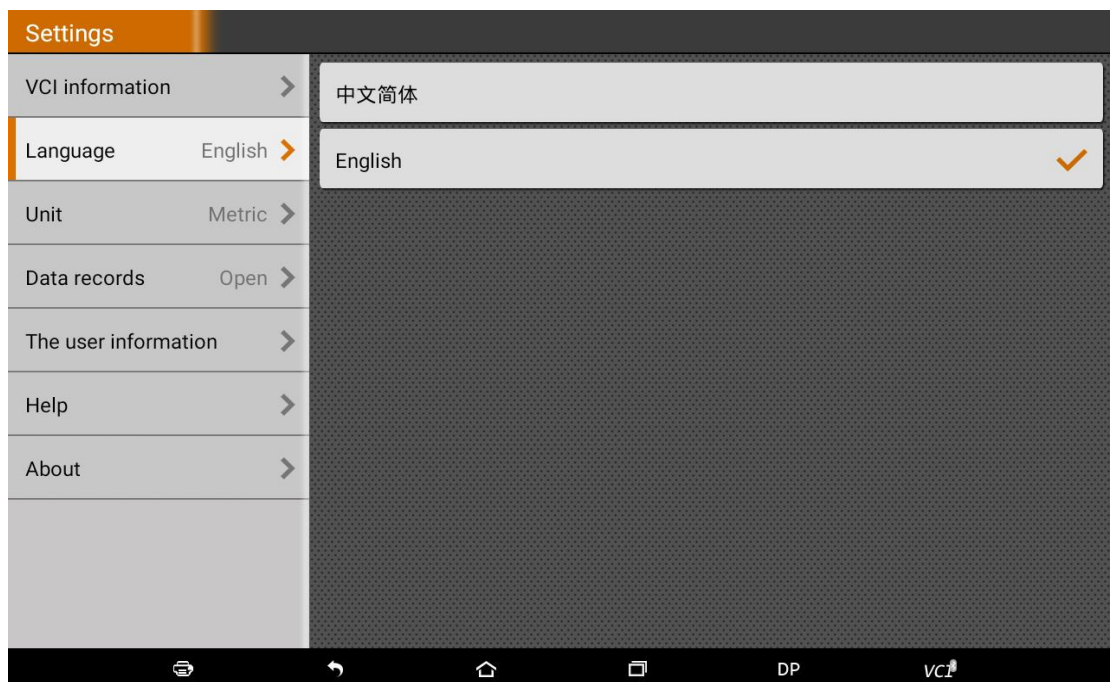

3.8.3 Unit

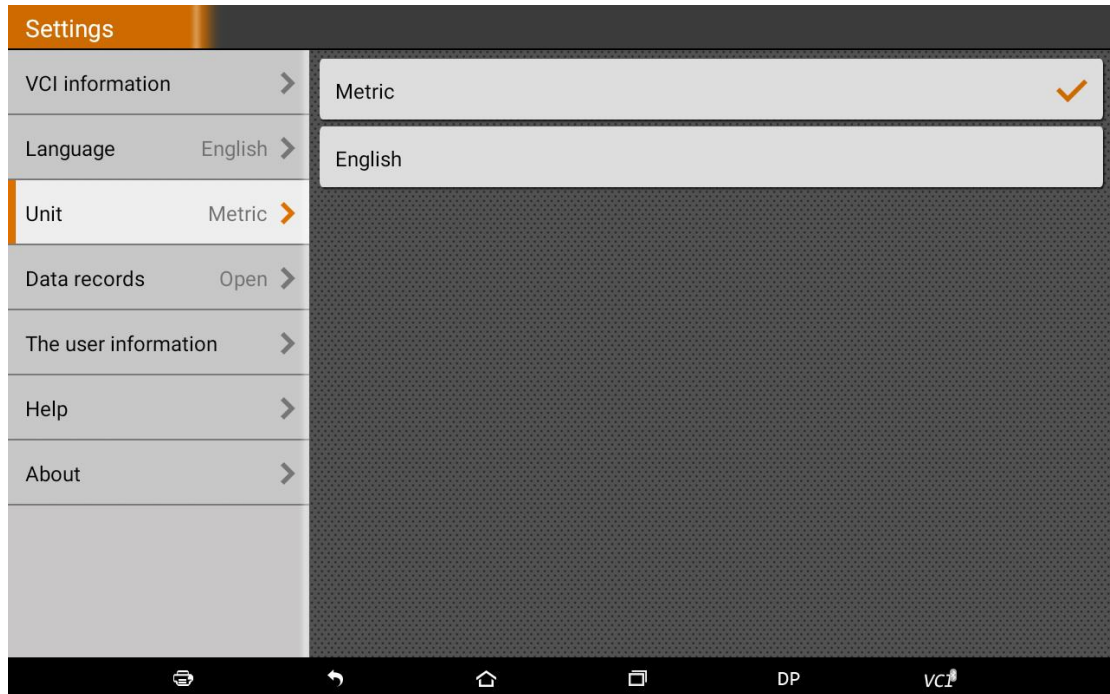

3.8.4 Data records

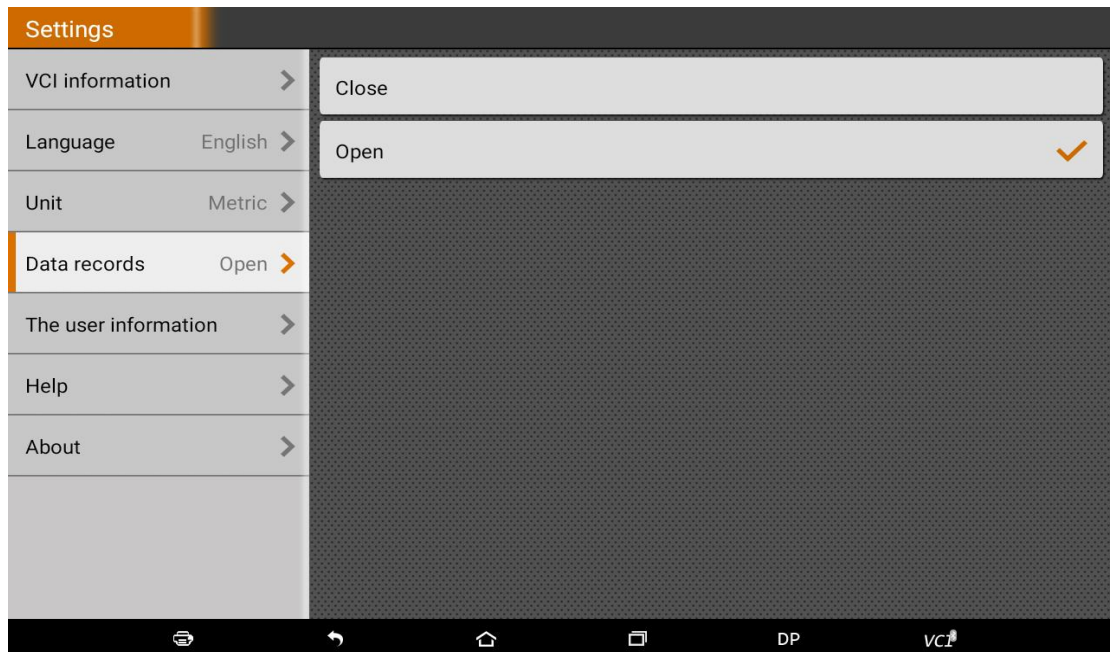

3.8.5 User information

It used to set and manage user's information.

3.8.5.1 User login

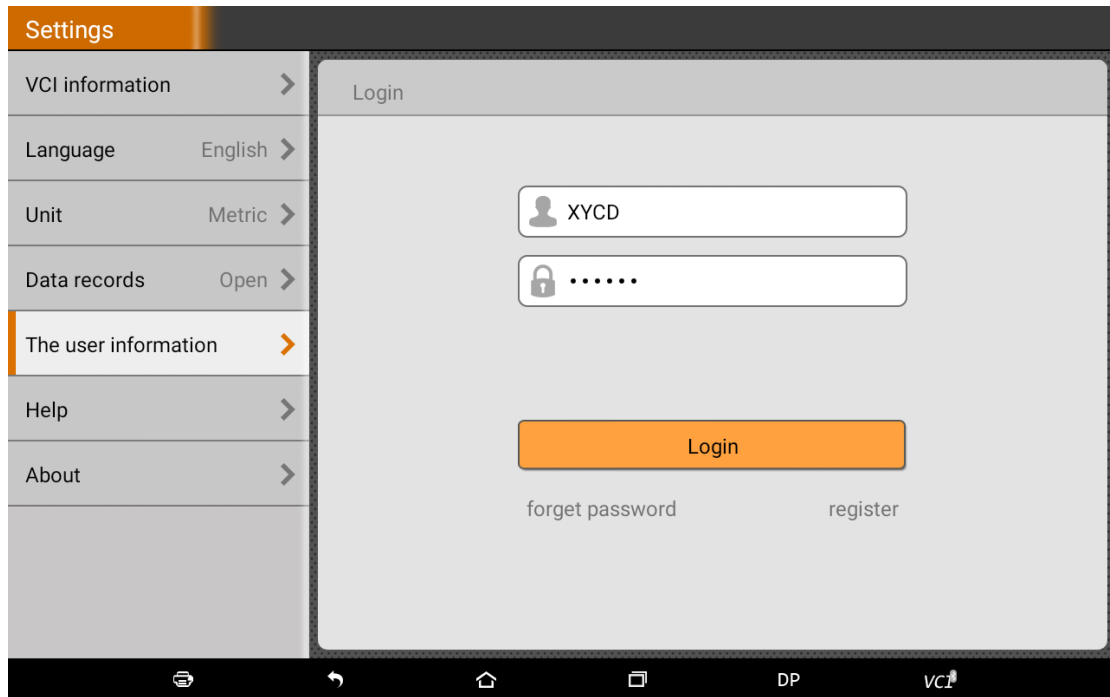

3.8.5.2 User registration

The screenshot shows the 'register' form within the 'Settings' application. The left sidebar contains menu items: VCI information, Language (English), Unit (Metric), Data records (Open), The user information (selected), Help, and About. The main form area is titled 'register' and contains the following fields:

- * SN
- * Register Password
- * Sale SN
- * user name
- * Password
- * Confirm password
- * user email
- Company Name
- Address
- Person Name
- Phone
- Post Code

At the bottom of the form, there are two buttons: 'OK' (orange) and 'Back' (grey). The bottom status bar shows icons for home, back, and VCI.

3.8.5.3 Forget Password

The screenshot shows the 'Password back' form within the 'Settings' application. The left sidebar is identical to the previous screenshot, with 'The user information' selected. The main form area is titled 'Password back' and contains the following fields and buttons:

- Registered email (with an '@' icon) and a 'Send code' button
- Verification code (with a fingerprint icon)
- New password (with a lock icon)
- Confirm password (with a lock icon)

At the bottom of the form, there is an orange 'OK' button. Below the form, there are two navigation options: 'Login' and 'register'. The bottom status bar shows icons for home, back, and VCI.

3.8.5.4 Registration information

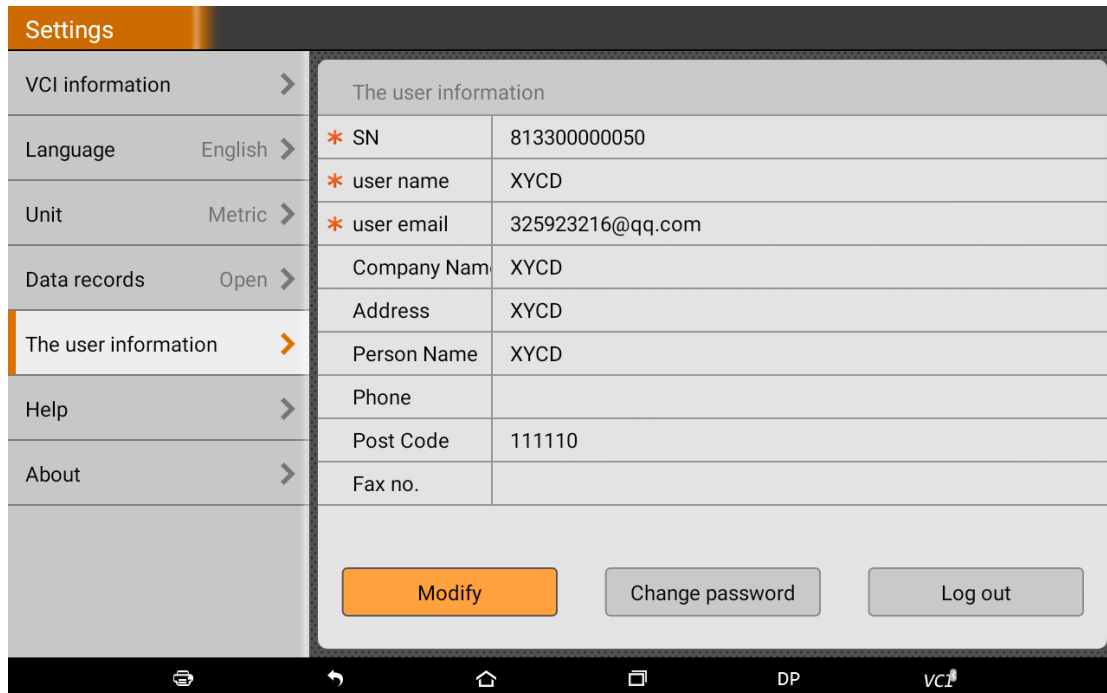

3.8.5.5 Modify Information

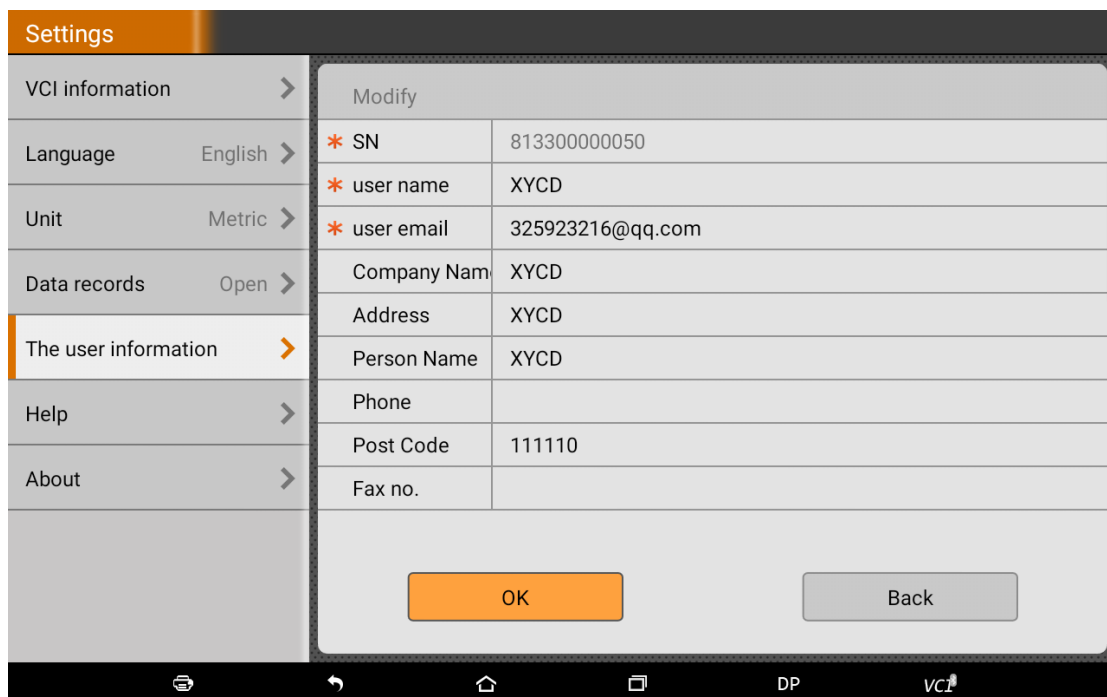

3.8.5.6 Modify Password

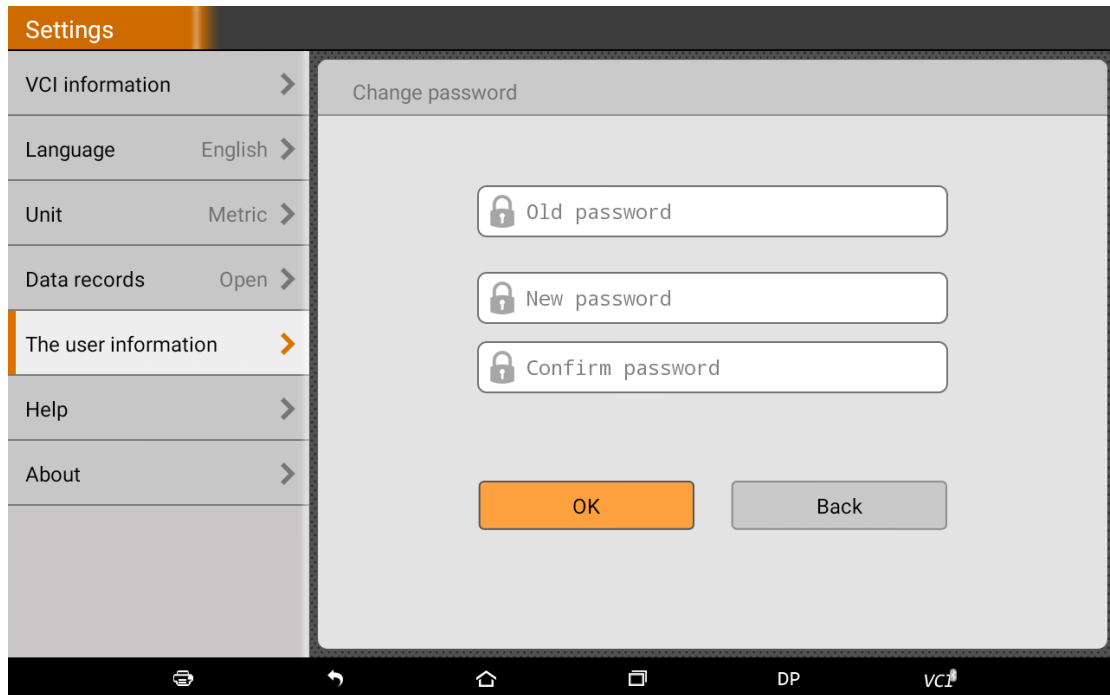

3.8.6 Help

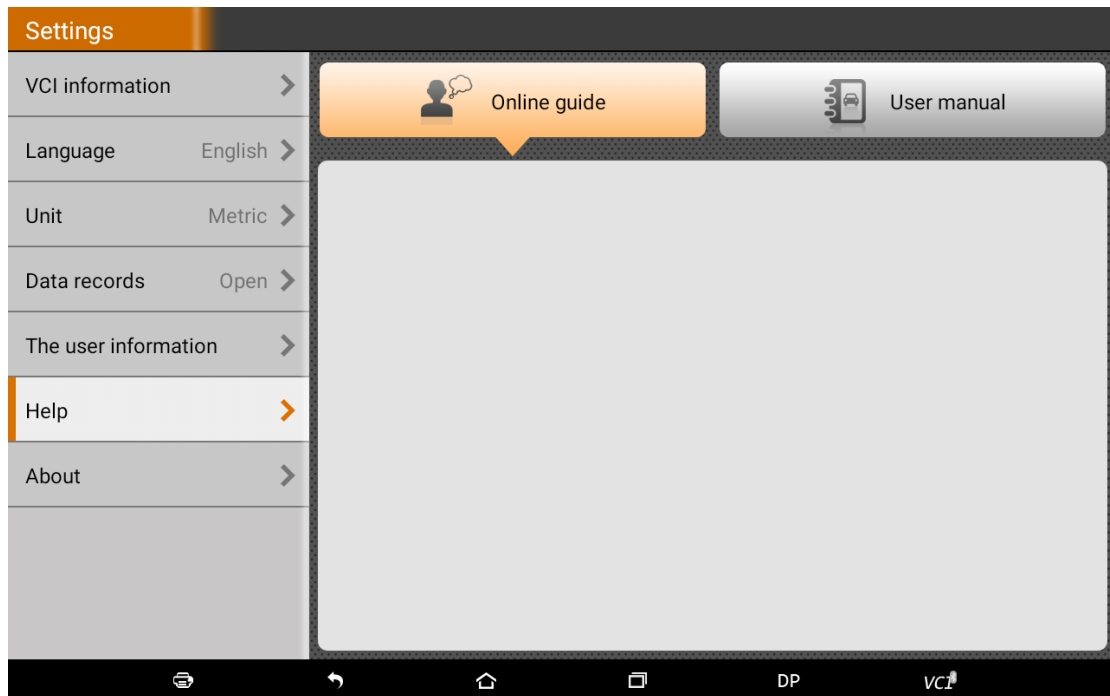



3.8.7 About

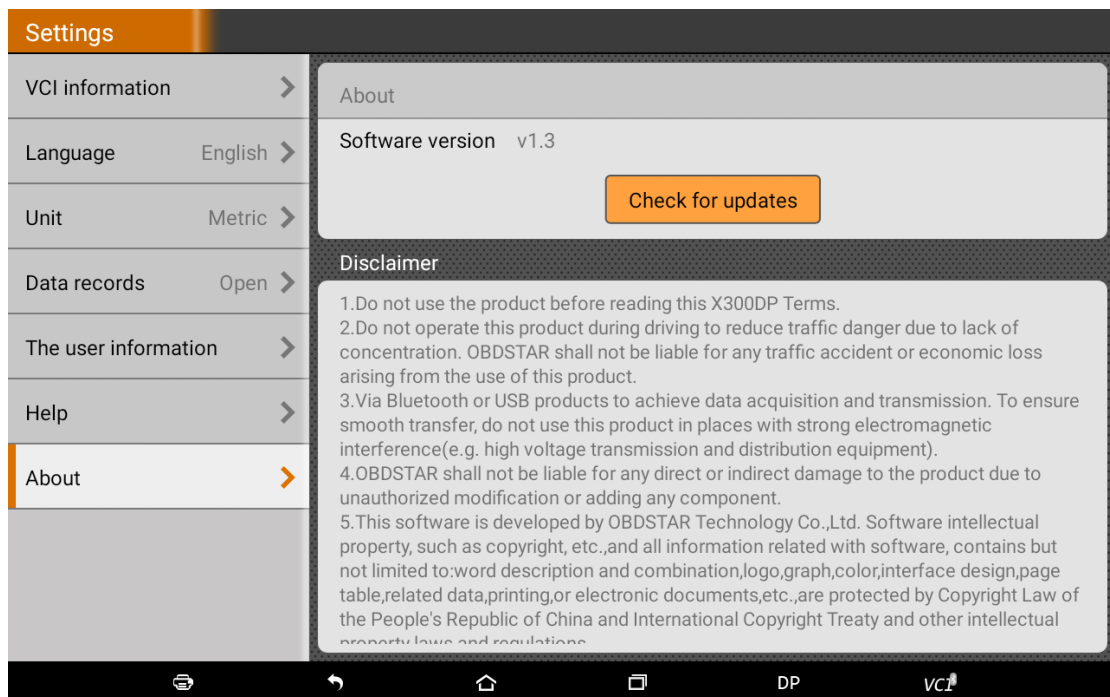

Tap “check for updates”, can check if any upgrade software version

3.9 Remote Assistance

This application can realize remote hosting operation via the Third Party’s software: QuickSupport.。

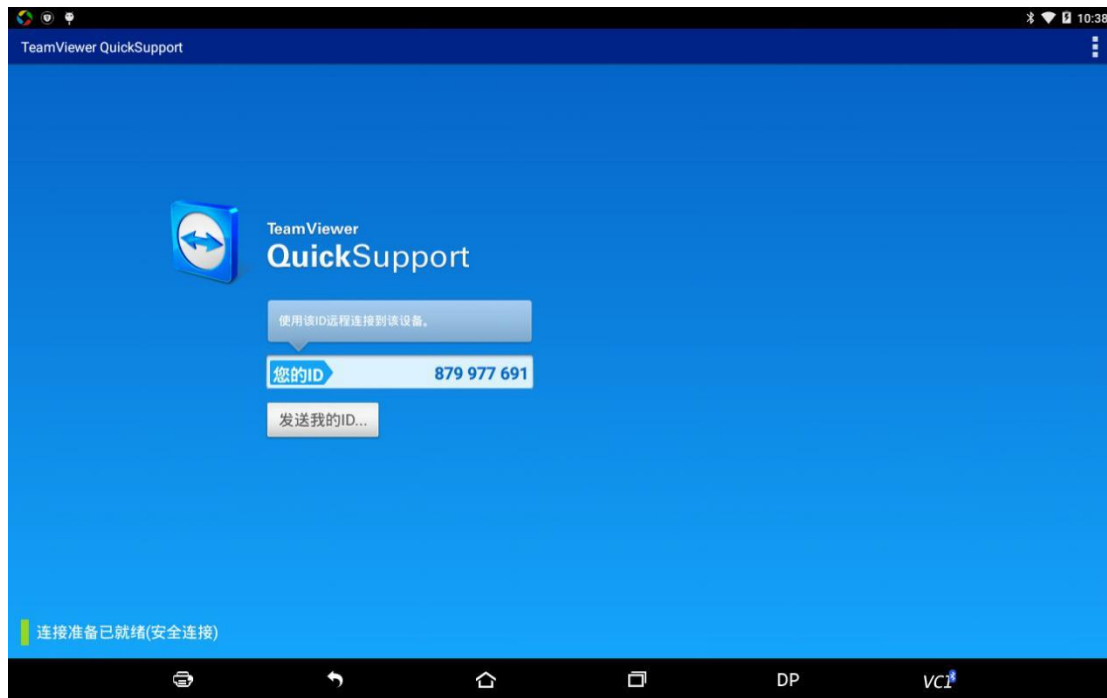

3.10 REPORT CENTER

Diagnostic Report: Each diagnosis operation will create new diagnostic report. Those reports will be grouped by Month.

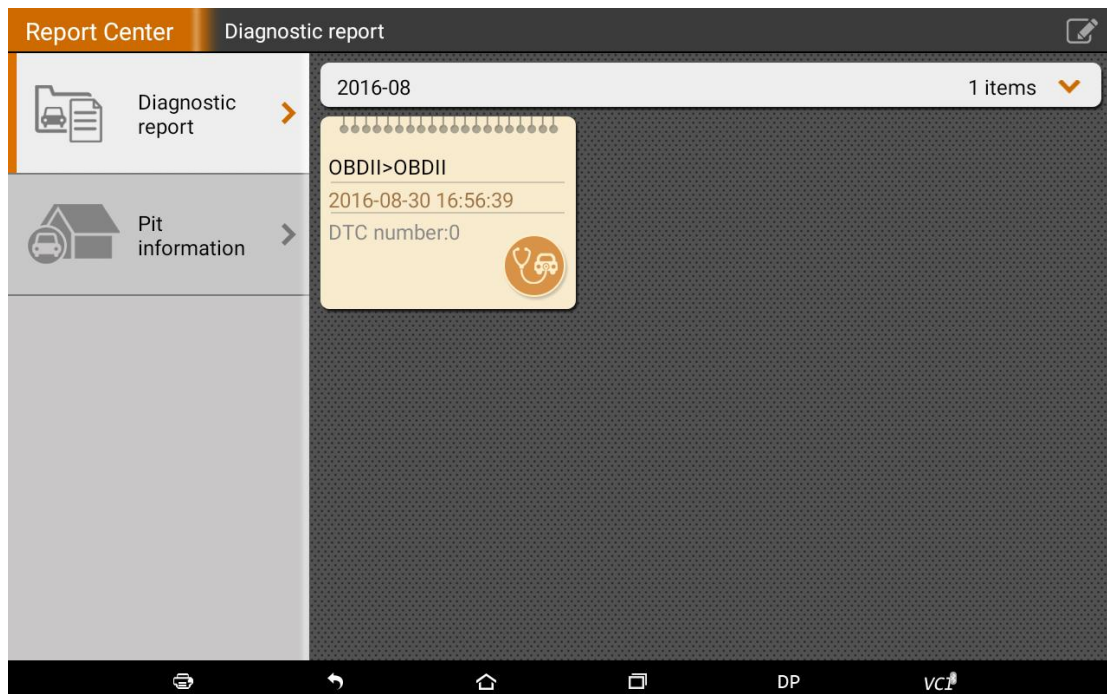

Report Center Diagnostic report

OBDII>OBDII

Diagnostic report

Pit information

Vehicle information

| | | | |
|----------|-------------|-----------|--|
| Year | | VIN | |
| Brand | OBDII>OBDII | Licens... | |
| Model | | Mileage | |
| Sub m... | | Color | |
| Engine | | State | |

Maintenance record

The tester

Testers note

Trouble code

| System | DTC id | DTC description | State |
|-----------------|--------|-----------------|-------|
| No trouble code | | | |

Maintenance Station Information: Can record related information of Maintenance Station.

Report Center Pit information

Pit information

Diagnostic report

Pit information

| | | | |
|-----------|--|-----------|--|
| Name | | | |
| Address | | | |
| Post C... | | | |
| City | | Manag... | |
| Province | | Manag... | |
| Phone | | user e... | |
| Fax no. | | URL | |

Note

4 OTHERS

4.1 EMAIL

The function allows you to send and receive email. You can add common web email service provider in Key Master DP Plus. For example: Yahoo!®, Sohu, 163 and other manufacturers of external Key Master DP Plus or IMAP email account.

4.1.1 Add an email account

Note: Before sending or receiving email, you have to set up an email account. In addition, this function required a stable network connection.

1. On the desktop, tap  to enter main menu screen, and then tap
2. Input email address, tap “next step” or “manual setup”
3. Tap the desired account type (here take Key Master DP Plus as example) to enter the incoming settings screen, tap “Next”.
4. Configure some sending settings, and tap “Next” to enter frequency settings.
5. After setting, tap “Next” and the system will prompt account setup has been finished.
6. Tap “Next” to enter email main menu.

4.1.2 Delete an email account

1. Enter main menu screen, and tap to enter account screen.
2. Tap the desired account, and then tap to choose “Settings”.
3. Tap the account to be deleted to enter, and then scroll the screen until “Remove account” appears, tap it to delete.

4.1.3 Send an email

1. Enter main menu screen, and tap to enter account screen.
2. Tap the desired email account.
3. Tap to enter new mail writing interface.
4. Input the receiver address in To field.
5. Input a title in Subject column.
6. Enter the content in Compose email area.
7. After inputting, tap , you can perform any one of the followings: attach file, add CC/BCC, savedraft, discard and setting.
8. Tap to send email.

4.1.4 View email

1. Enter main menu screen, and tap to enter account screen.
2. Tap the desired email account.
3. Tap to refresh the inbox.
4. Tap the desired one to read.

4.2 WLAN

This function enables you to enjoy surfing on the internet and downloading data from the internet via Wi-Fi.

4.2.1 Set Wi-Fi on

1. Enter main menu screen, choose "Settings" > WLAN
2. When the WLAN sign appears blue, it indicates Wi-Fi has been activated already.

Note: To prolong the battery life, please switch Wi-Fi off when it keeps unattended.

4.2.2 Connect to WLAN

Start WLAN, if Key Master DP Plus within range of WLAN, Key Master DP Plus can automatically detect and connect to current WLAN, select desired network and input password, then you can surf the internet by WLAN.

4.3 Browser

You can use any APP based on browse website and network.

4.3.1 Open browser

Enter main menu screen, tap to OBDSTAR the browser. You can choose the desired homepage or input the website address to browse.

1. Tap to input or edit the web link

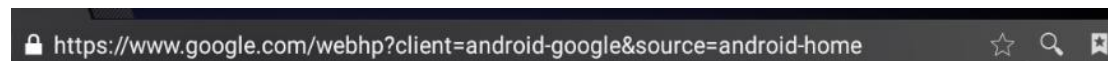

2. Web page display area

3. Tap to open bookmarks , view history and saved web pages.

4.3.2 Browser webpage

1. Open the browser.

2. Input the web address, and tap “Go” on the keyboard to visit the website.

Tips: Alternatively, you can also tap , and then choose “Bookmarks/History” from the pull-down list to choose the web link you want to access.

3. After a webpage is open, slide the screen with the tip of your finger to view other hidden content.

4.3.3 Zoom in/Zoom out a page

There are two ways to zoom in/ zoom out while browsing a webpage.

- To zoom in so that the text on a webpage appears in a column that fits your device’s screen, double-tap with the tip of your finger.
- To zoom in manually, place two fingers on the screen and then spread them apart. To zoom out, either double-tap again or place two fingers apart on the screen and then pinch them together.

4.3.4 Save favorite webpage to bookmark

While browsing a webpage, tap and choose “Save to bookmarks”.

2. Edit a label for the bookmark.
3. Tap “OK” to confirm and save it.

4.3.5 Open multiple pages

The browser allows you to open multiple web pages and you can toggle between these pages.

1. While browsing a webpage, tap  and open new window.
2. Another web page will be displayed in the new window.

4.3.6 Customize internet settings

While browsing a webpage, choose “Settings”, you can view or change browser settings, privacy & security setting and advanced setting etc.

4.4 CAMERA

4.4.1 Open and close camera

- Enter main menu screen, tap camera.
- In shoot mode, tap back button to exit the camera.

4.4. 2 Take a photo

1. Open camera, select whether to remember the shoot spot of the photo ? Tap the next step.
2. In shoot mode, aim the camera lens at the object you want to photograph and adjust it as desired.



3. Tap  to take a photo.

4.4. 3 View a photo

1. After a picture is taken, the picture will be stored automatically. Swipe the screen leftwards to view the photo.
2. While browsing a picture, you can do any one of the followings:
 - Tap to delete the picture.
 - Share, tap to send this picture to your friend or upload it online.
 - Edit, beautify the photo, and view the detailed information of the photo.
 - Tap the back button on photo interface to return to the shoot mode.
3. Swipe the screen rightwards or leftwards to view the next/previous picture.

4.4. 4 Record a video

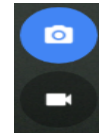

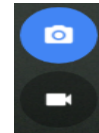
1. Open the camera, and swipe the screen rightwards to display button  , and switch to video mode.
2. Aim the camera lens at the object you want to photograph and adjust it as desired.



3. Tap  to start recording.

4. Tap  to stop recording.

4.4. 5 View a video

1. After a video is recorded, the video will be stored automatically. Swipe the screen leftwards to view the video
2. The following operations can be done:
 - Delete, delete the video.
 - Share, send this video file to your friend or upload it online.



- Tap to back button on the video interface to return to the view state.
3. When the video is playing, swipe the screen leftwards and rightwards to control the speed of

video playing, and tap  to stop video playing, and tap  to start video playing.

4.4.6 Customize camera settings

In camera mode:

Tap  to enter camera setting screen:

- Tap  to set Camera scratchable latex mode;
- Tap  to turn on /off flash mode;
- Tap  to set timer of selfie, 3s or 10s

4.4.7 Customize camrecorder setting

In video mode:

Tap  to enter video setting screen:

Tap  to turn on/off flash light;

Tap  to turn on/off scratchable latex mode

4.5 GALLERY

This option is used to manage pictures and video files.

4.5.1 Open gallery

Enter main menu screen, tap “Gallery” to access it. The system searches images and videos in Key Master DP Plus and SD card automatically, and categorizes it into corresponding folders.

4.5.2 Browse images

1. Enter main menu screen, tap "Gallery".
2. Tap the picture folder you want to view.
3. Tap the desired image to browse.
4. Swipe the screen rightwards or leftwards to view the next/previous picture.

4.6 MUSIC

Music files are stored into 4 categories: Artists, Albums, Songs and Playlist.

Tap the desired music to display music. Press the button on the right side to increase or decrease the volume.

Tips: While playing, tap back button to switch to other applications and the player will be running in background. Open the status bar and choose the audio file to return to the player screen.

4.7 CALCULATOR

You can use calculator to operate algorithm of plus, subtract, multiply and divide, and function operation of sin, cos, tan and log.

4.8 CALENDAR

This function lets you view calendar or create to-do events.

Enter main menu screen, tap "Calendar". Swipe up and down to switch to month;



Tap some day, the followings can be done.

Tap  to refresh, search, hide control and setting.

4.9 ALARMS

4.9.1 Add an alarm

1. Enter main menu, and tap "Alarm".

2. Tap  to add alarms.
3. Set the detailed information of the alarm.
4. Tap  to pack up the alarm to store the setting.

4.9.2 Delete an alarm





1. Enter main menu screen, tap "Alarms".
2. Tap the desired alarm.
3. Tap  to delete it.

Tips: After the alarm is deleted, you can choose to cancel delete alarm on the right side from the option menu.

4.9.3 Customize your alarm

1. Enter main menu screen, tap "Alarms".
2. Tap menu button , and then choose "Settings".
3. Alarm volume: Set the volume of alarms.
4. Set the duration of alarm.
5. Set the duration the alarm snooze next time.
6. Volume buttons: set what these buttons function when pressed during an alarm.
7. Set default ringtone: choose the alarm ringtone.





4.9.4 Countdown set

1. Enter the main menu to tap  to choose count down alarm;;
2. Set the time of count down;
3. Tap  to add count down alarm, and tap  to delete alarm;
4. Tap  to start count down, and tap  to stop count down;

Notice: after the count down ends, the device will ring alarm sound.

4.9.5 Second clock setting

1. Enter the main menu to tap  to choose second clock;

2. Tap  to start second and clock, and tap  to stop second clock;
3. Tap  to reset second time;
4. Tap  on the right side to display the smaller unit counter of second clock;

4.10 ES FILE VIEWER

Open ES file viewer, and enter main menu.

You can manage SD card, browse by category and browse all music, picture, video, document application, package, favorites, installation package, management recommended through catalogue.

4.11 DISPLAY

4.11.1 Brightness

1. Enter main menu screen, tap “Settings” > “Display”.
2. Tap “Brightness” to enter.
3. Drag the slider leftward to lower the screen brightness. Drag the slider rightward to increase the screen brightness.

4.11 .2 Auto-rotate the screen

1. Enter main menu screen, tap “Settings” > “Display”.
2. When setting the rotation of device, remain the orientation of the rotated screen.

4.12 SET SCREEN LOCK

You can set the screen lock pattern, and when the screen is locked, it will not be unlocked until you draw the right pattern.

1. Enter main menu screen, tap “Settings” > “Security” > “Screen lock”.
2. There are several options available for your selection. To define a pattern, follow the on-screen prompts to plot your pattern.
3. After drawing, tap “Confirm” to save your setting.

4.13 APPLICATION

4.13.1 View installed applications

1. Enter main menu screen, tap "Settings" > "Apps" to open the downloaded application list.
2. The following operations are available:
 - Tap the desired one to view the application information.
 - Tap and choose "Sort by size" from the pull-down menu, the applications will be displayed in size order automatically.
 - Tap and choose "Reset app preferences" from the pull-down menu, a confirmation dialog box will appear on the screen, tap "Reset apps" to proceed; tap "Cancel" to abort.
3. To uninstall an application, tap it to enter the application information screen.
4. Tap "Uninstall" and then follow the on-screen instructions to finish it.

4.13.2 View the running applications

1. Enter the main menu screen, tap "Settings" > "Apps". Scroll the screen from right to left to RUNNING tab to open the currently running application list.
3. The following operations can be done:
 - View the currently running applications;
 - Tap any one to stop it.

4.14 LANGUAGE&INPUT METHOD

1. Enter the main menu screen, tap "Settings" > "Language & input">Tap language.
2. Tap "Language" and choose the desired language in the Key Master DP Plus
The setting of input method
The device provides several kinds of input methods. Tap setting before the desired input method.

4.15 SET DATE&TIME

Key Master DP Plus is preset to use the network-provided date, time zone and time.

Note: If Automatic date & time is set as Use network-provided time, date, time and time zone will not be defined.

1. Enter the main menu screen, and tap "Settings" > "Date & time".
2. Tap "Set date", and scroll the screen upwards and downwards until the desired numbers appear on the highlight area.

3. Tap "Select time zone", and choose the desired one from the time zone list. Scroll the screen upwards and downwards to view more.
4. Tap "Set time" and scroll the screen upwards and downwards to adjust the hour and minute. After setting, tap "Done" to confirm.
5. Select or deselect "Use 24-hour format" to switch between 12-hour format and 24-hour format.
6. Tap "Choose date format" to choose the desired date of Key Master DP Plus format from the list.

4.16 RESTORE KEY MASTER TO FACTORY SETTINGS

This option enables you to restore Key Master DP Plus to the default factory settings.

Once it is reset, all data (including downloaded applications) will be deleted.

Note: Before resetting to factory data, please back up all important data saved in Your Key Master DP Plus.

1. Enter the main menu screen, tap "Settings" > "Backup & reset" > "Factory data reset".
2. Follow the instructions on the screen to proceed.

4.17 STORE

Enter the main menu, and tap setting> store check the store situation of the device.

Store the download content in the default browser to the download content list.

4.18 APPS INSTALLATION/ UNINSTALLATION

1. Install: Put the application package under the root directory of SD card, enter "File Manager" and then tap the desired package to start installing.
2. Uninstall: Tap "Settings" > "Apps", and choose the desired one to uninstall.

▪ ATTACHMENTS

Warranty

THIS WARRANTY IS EXPRESSLY LIMITED TO PERSONS WHO PURCHASE OBDSTAR PRODUCTS FOR PURPOSES OF RESALE OR USE IN THE ORDINARY COURSE OF THE BUYER'S BUSINESS.

OBDSTAR electronic product is warranted against defects in materials and workmanship for one year from date of delivery to the user.

This warranty does not cover any part that has been abused, altered, used for a purpose other than for which it was intended, or used in a manner inconsistent with instructions regarding use. The exclusive remedy for any automotive meter found to be defective is repair or replacement, and OBDSTAR shall not be liable for any consequential or incidental damages.

Final determination of defects shall be made by OBDSTAR in accordance with procedures established by OBDSTAR. No agent, employee, or representative of OBDSTAR has any authority to bind OBDSTAR to any affirmation, representation, or warranty concerning OBDSTAR automotive meters, except as stated herein.

Disclaimer

The above warranty is in lieu of any other warranty, expressed or implied, including any warranty of merchantability or fitness for a particular purpose.

Purchase Order

Replaceable and optional parts can be ordered directly from your OBDSTAR authorized tool supplier. Your order should include the following information:

Order quantity

Part number

Part name

Customer Service

Any question during the operation, please call 4008889161.

If your unit requires repair service, return it to the manufacturer with a copy of the sales receipt and a note describing the problem. If the unit is determined to be in warranty, it will be repaired or replaced at no charge. If the unit is determined to be out of warranty, it will be repaired for a nominal service charge plus return freight. Send the unit pre-paid to:

Attn: Customer Service Department

OBDSTAR Technology Co., Ltd

West Block 4 floor, NO. 8 building of Xinwu industrial areas, Taoyuan street, Nanshan District, Shenzhen, China

OBDSTAR WEB: www.obdstar.com

FCC Caution.

This device complies with part 15 of the FCC Rules. Operation is subject to the following two conditions: (1) This device may not cause harmful interference, and (2) this device must accept any interference received, including interference that may cause undesired operation.

Any Changes or modifications not expressly approved by the party responsible for compliance could void the user's authority to operate the equipment.

Note: This equipment has been tested and found to comply with the limits for a Class B digital device, pursuant to part 15 of the FCC Rules. These limits are designed to provide reasonable protection against harmful interference in a residential installation. This equipment generates uses and can radiate radio frequency energy and, if not installed and used in accordance with the instructions, may cause harmful interference to radio communications. However, there is no guarantee that interference will not occur in a particular installation. If this equipment does cause harmful interference to radio or television reception, which can be determined by turning the equipment off and on, the user is encouraged to try to correct the interference by one or more of the following measures:

- Reorient or relocate the receiving antenna.
- Increase the separation between the equipment and receiver.
- Connect the equipment into an outlet on a circuit different from that to which the receiver is connected.
- Consult the dealer or an experienced radio/TV technician for help.

The device has been evaluated to meet general RF exposure requirement. The device can be used in portable exposure condition without restriction.