

LTE Band IV - Low CH QPSK-15

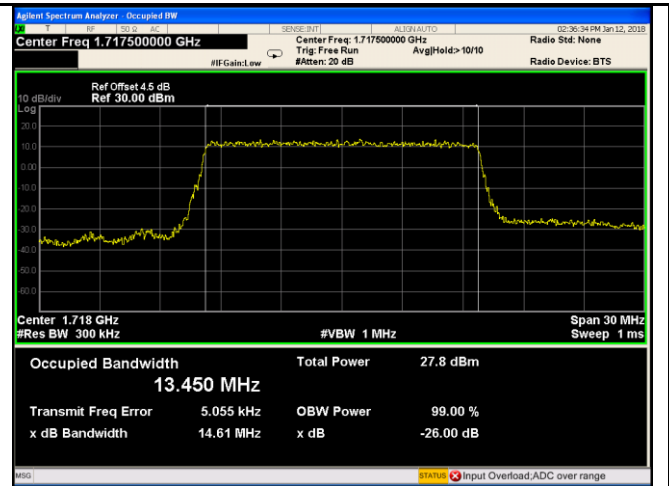

LTE Band IV - Low CH 16QAM-15

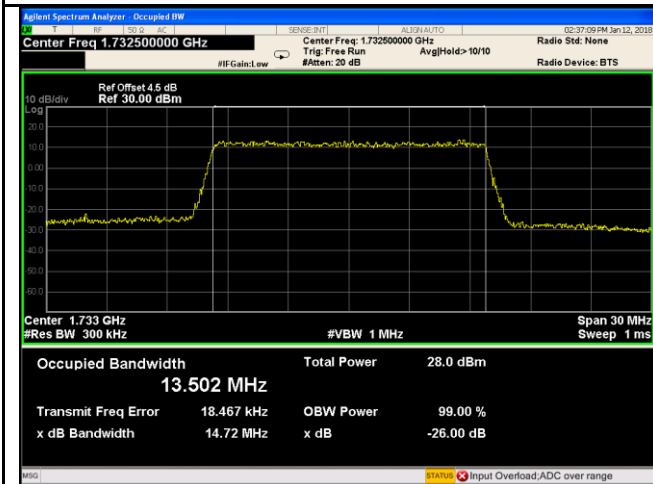

LTE Band IV - Middle CH QPSK-15

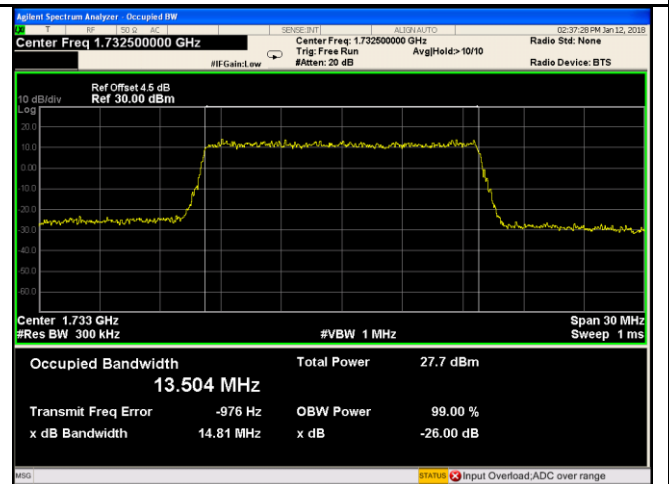

LTE Band IV - Middle CH 16QAM-15

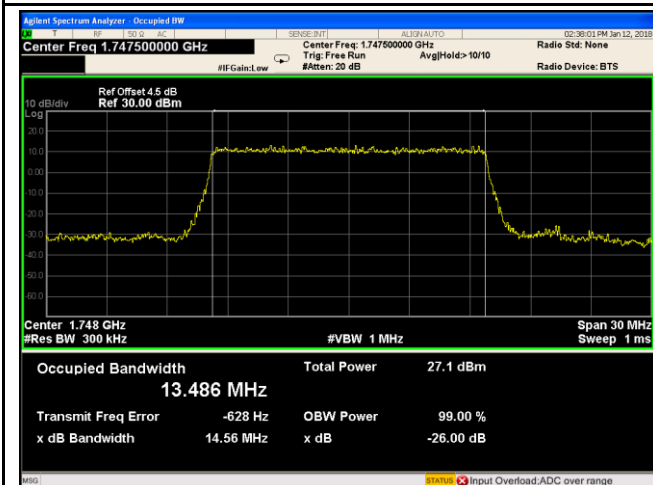

LTE Band IV - High CH QPSK-15

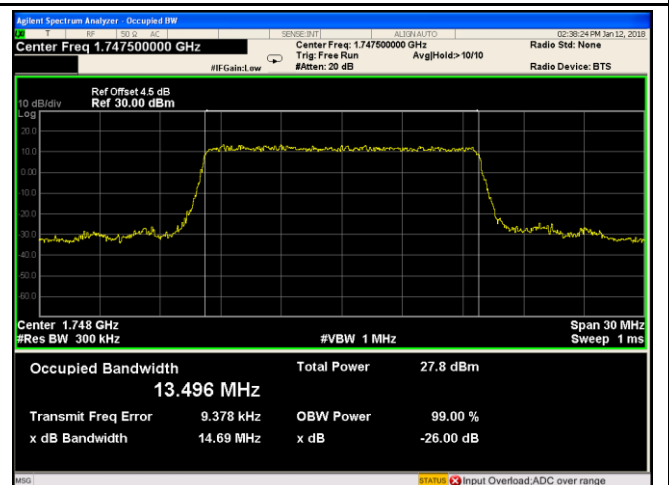

LTE Band IV - High CH 16QAM-15

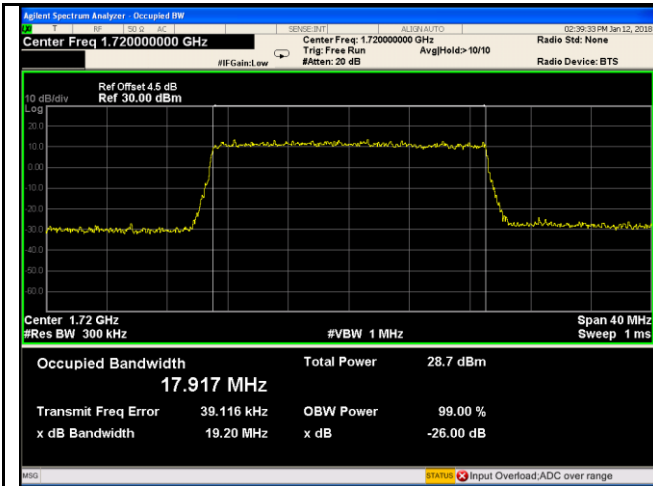

LTE Band IV - Low CH QPSK-20

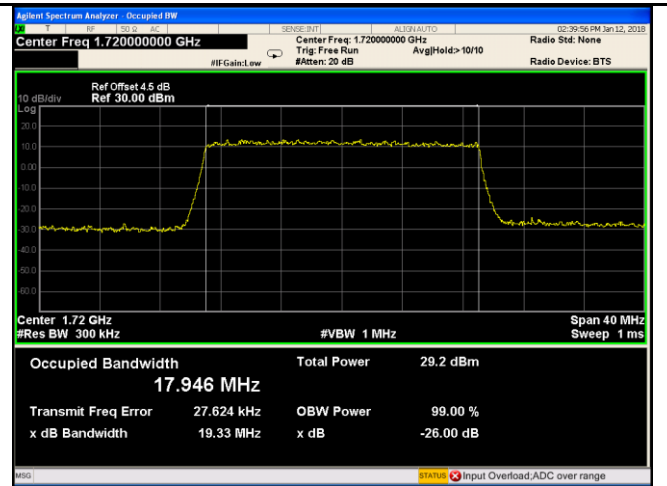

LTE Band IV - Low CH 16QAM-20

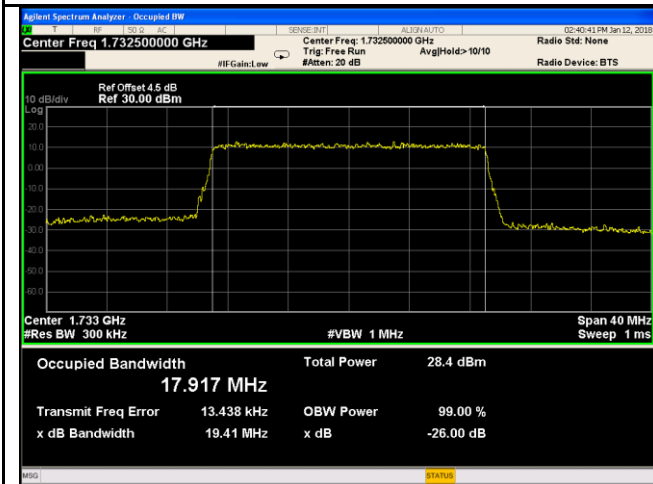

LTE Band IV - Middle CH QPSK-20

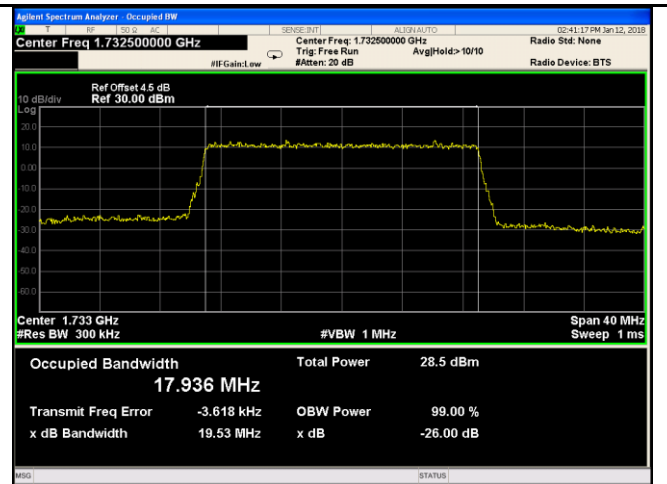

LTE Band IV - Middle CH 16QAM-20

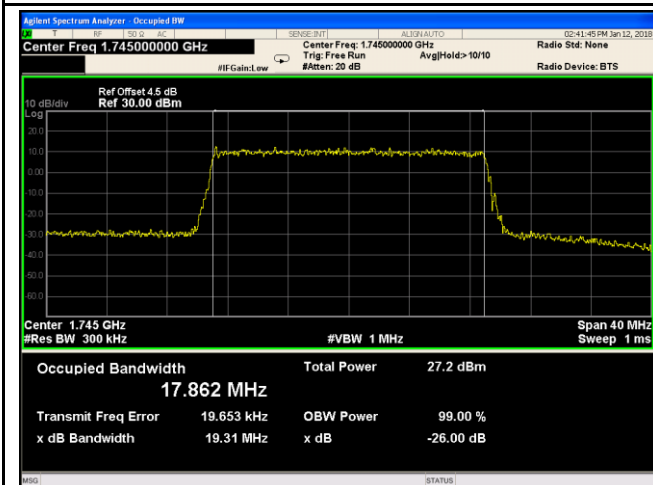

LTE Band IV - High CH QPSK-20

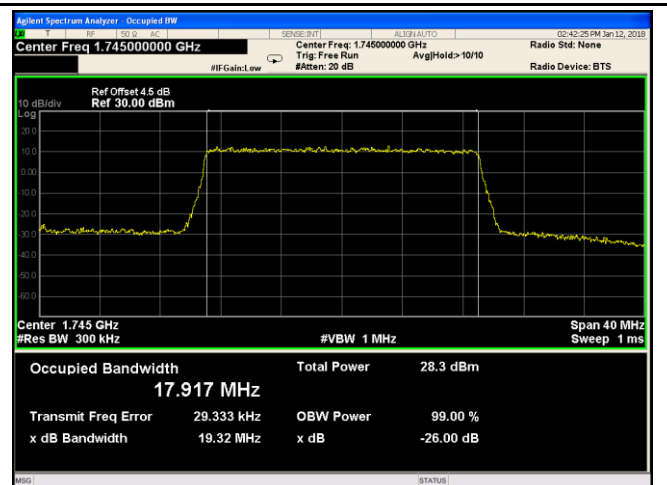

LTE Band IV - High CH 16QAM-20

LTE Band V (Part 22H)

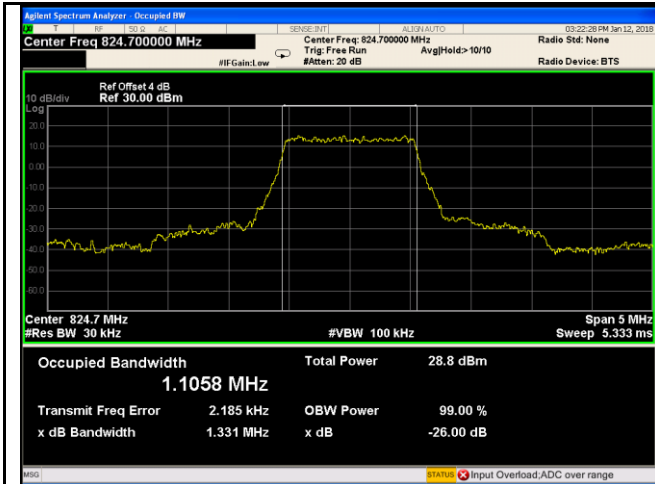

LTE Band V - Low CH QPSK-1.4

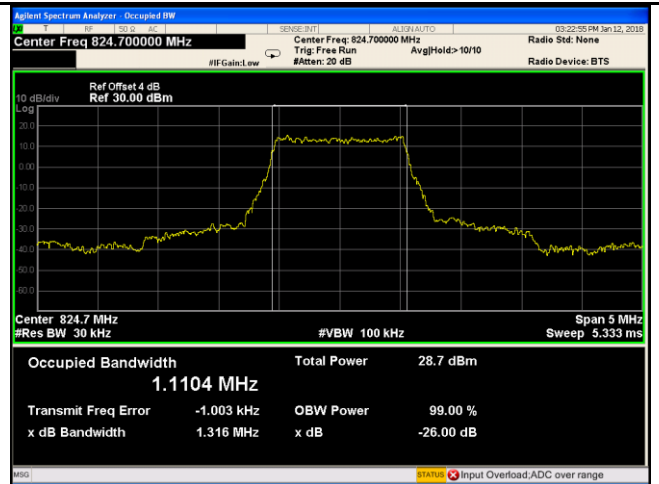

LTE Band V - Low CH 16QAM-1.4

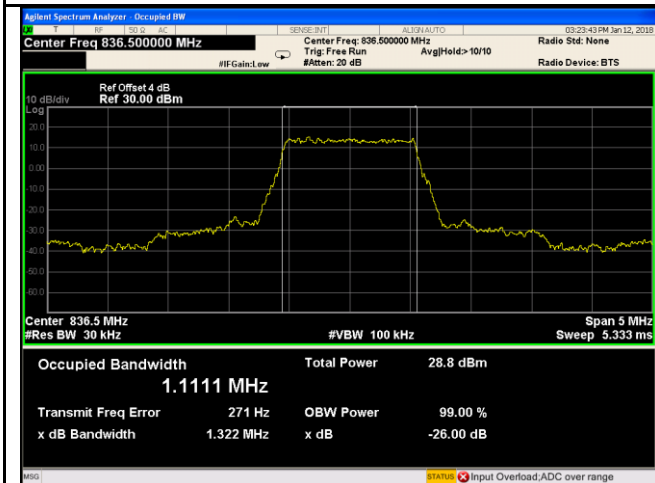

LTE Band V - Middle CH QPSK-1.4

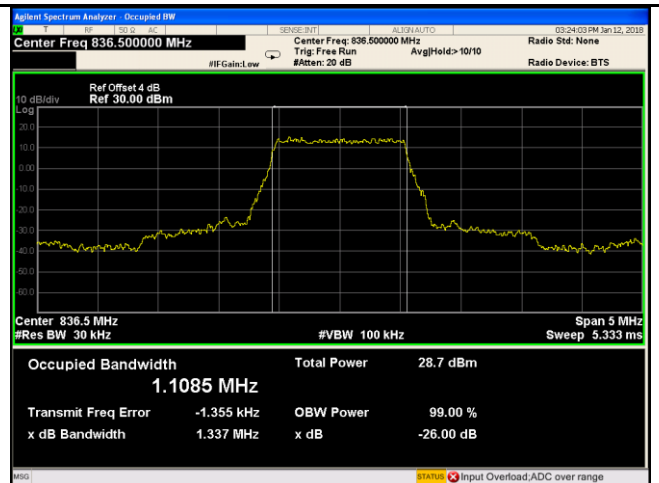

LTE Band V - Middle CH 16QAM-1.4

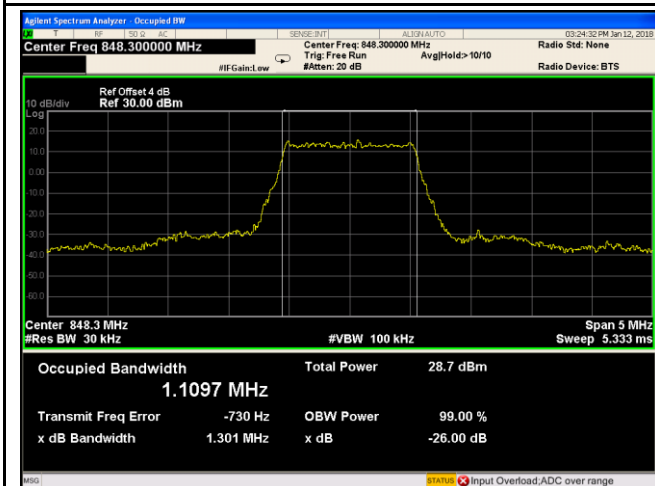

LTE Band V - High CH QPSK-1.4

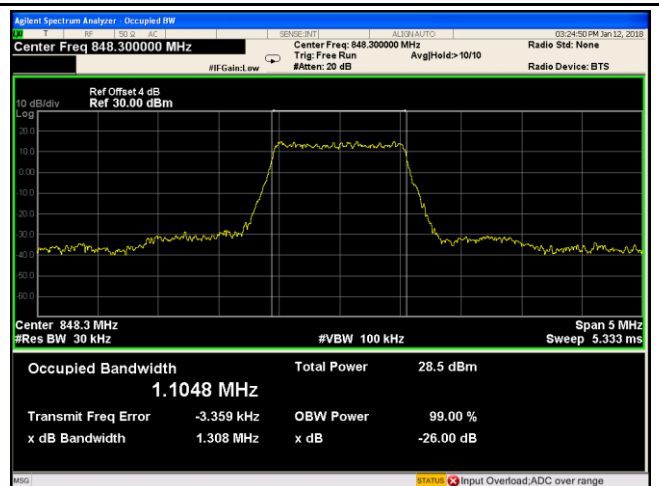

LTE Band V - High CH 16QAM-1.4

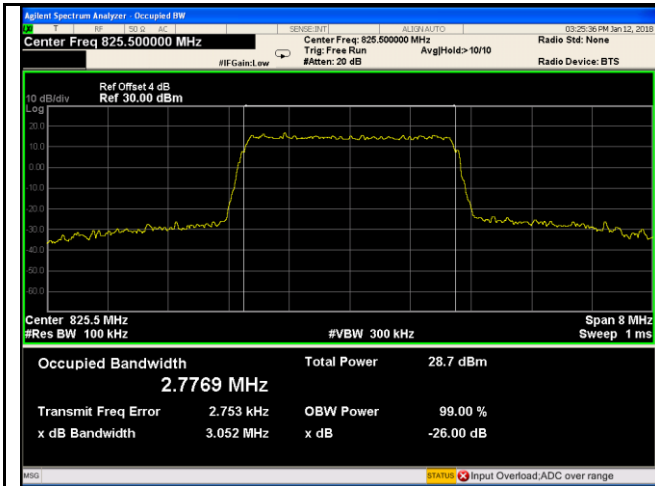

LTE Band V - Low CH QPSK-3

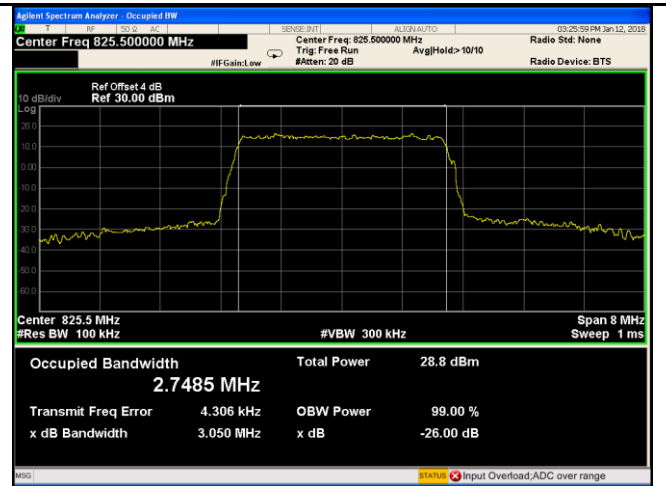

LTE Band V - Low CH 16QAM-3

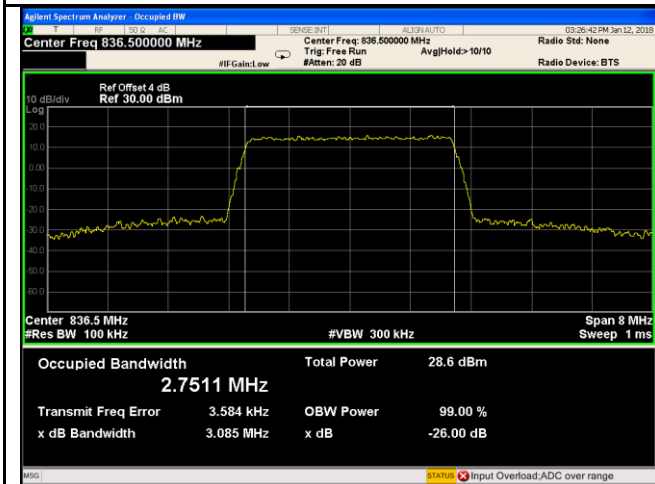

LTE Band V - Middle CH QPSK-3

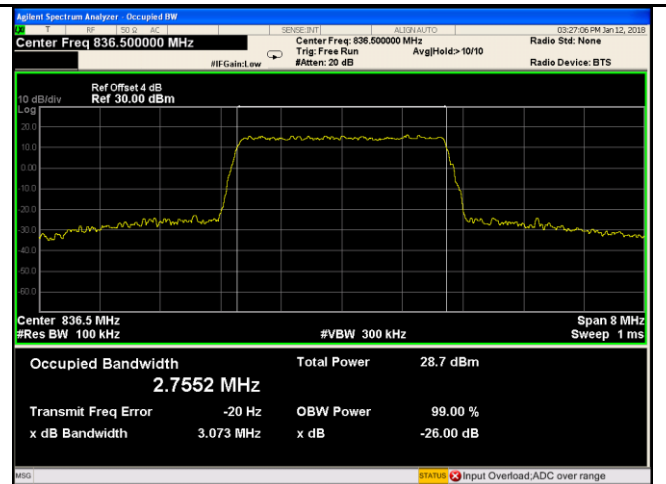

LTE Band V - Middle CH 16QAM-3

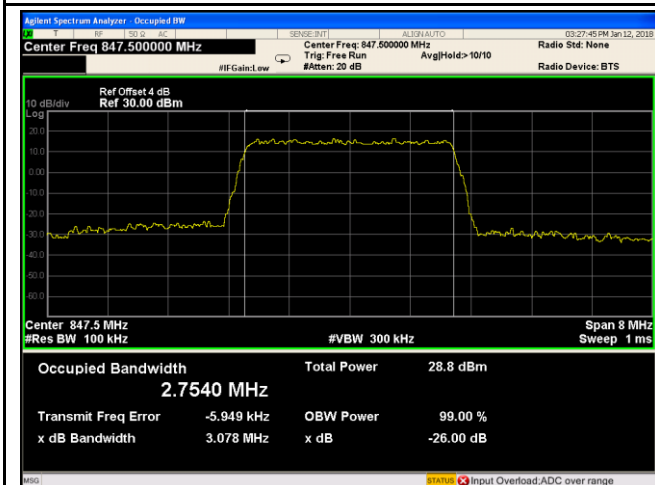

LTE Band V - High CH QPSK-3

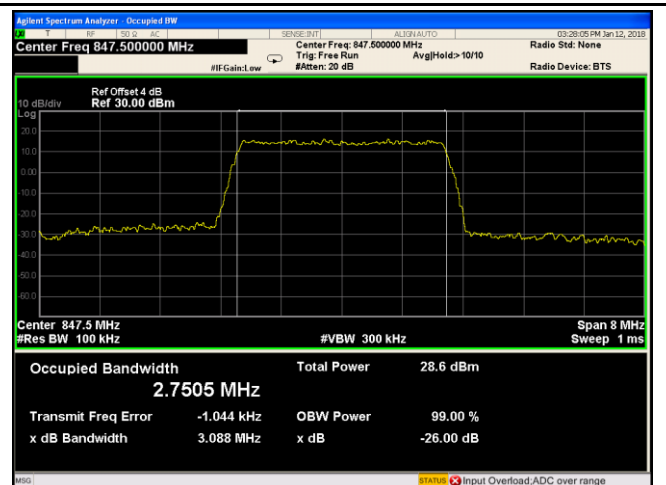

LTE Band V - High CH 16QAM-3

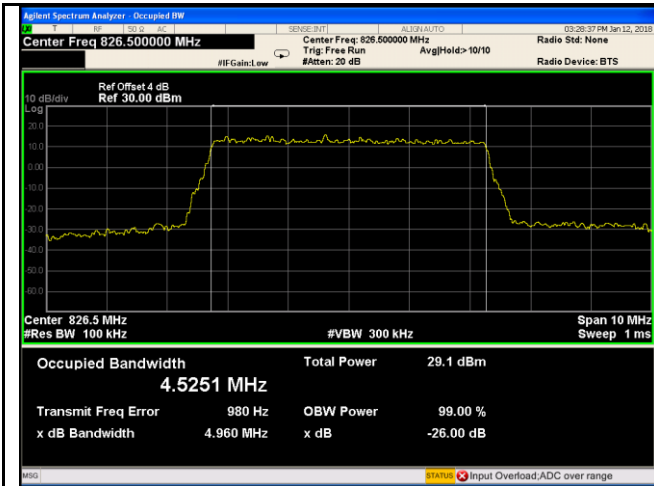

LTE Band V - Low CH QPSK-5

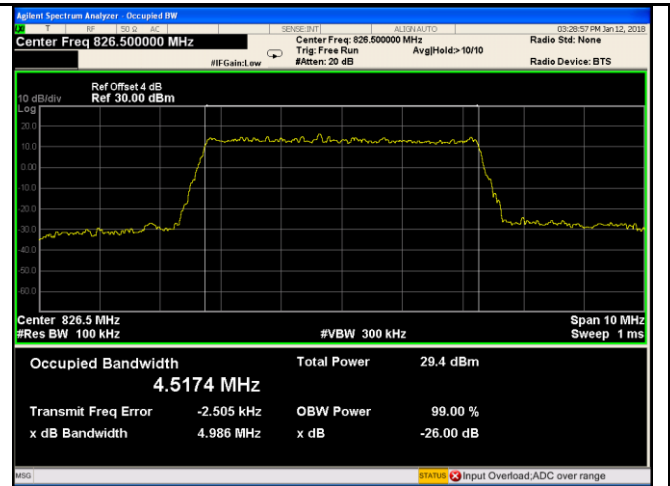

LTE Band V - Low CH 16QAM-5

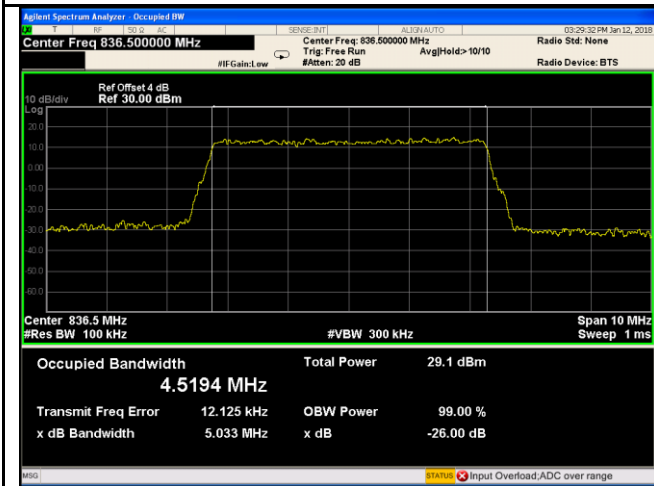

LTE Band V - Middle CH QPSK-5

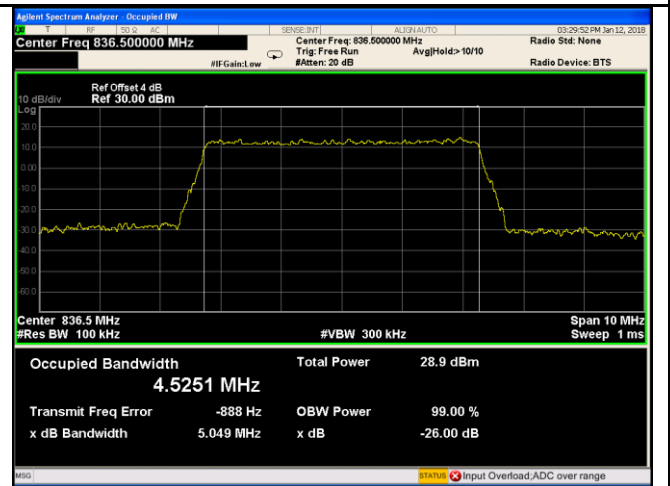

LTE Band V - Middle CH 16QAM-5

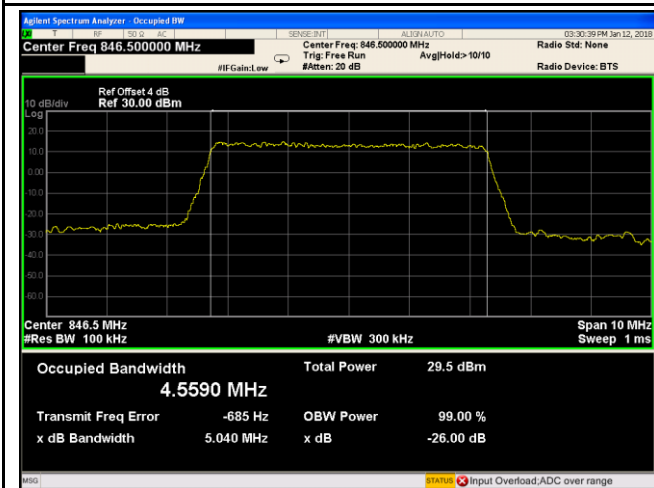

LTE Band V - High CH QPSK-5

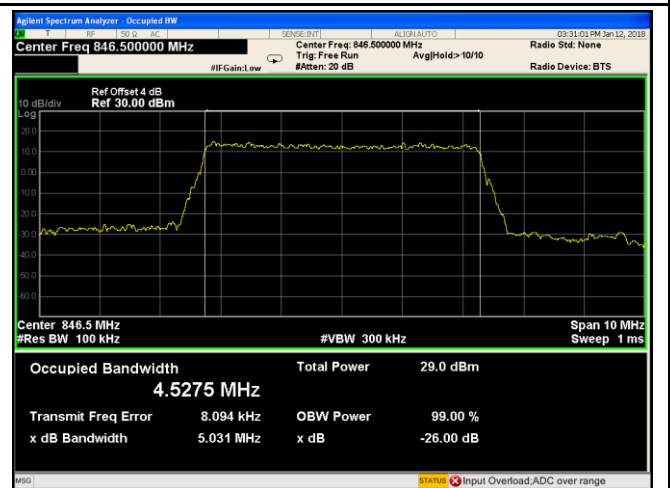

LTE Band V - High CH 16QAM-5

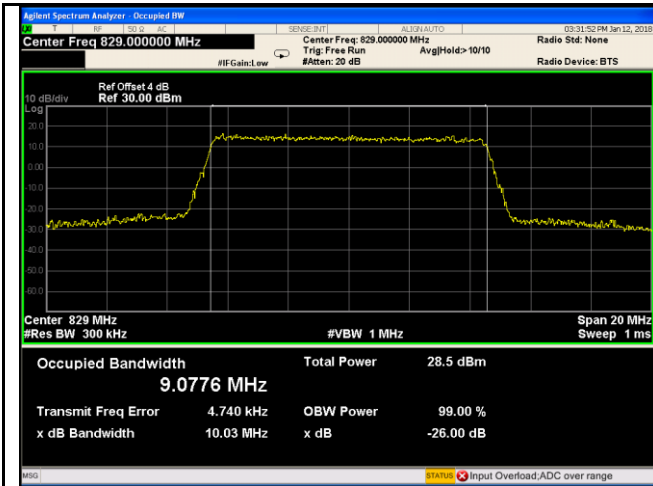

LTE Band V - Low CH QPSK-10

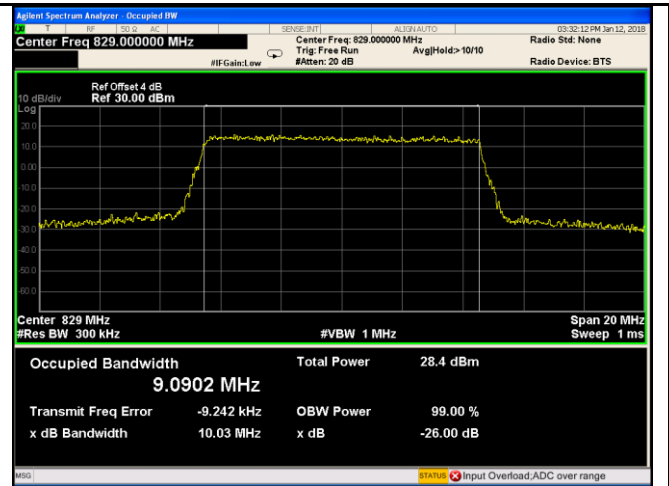

LTE Band V - Low CH 16QAM-10

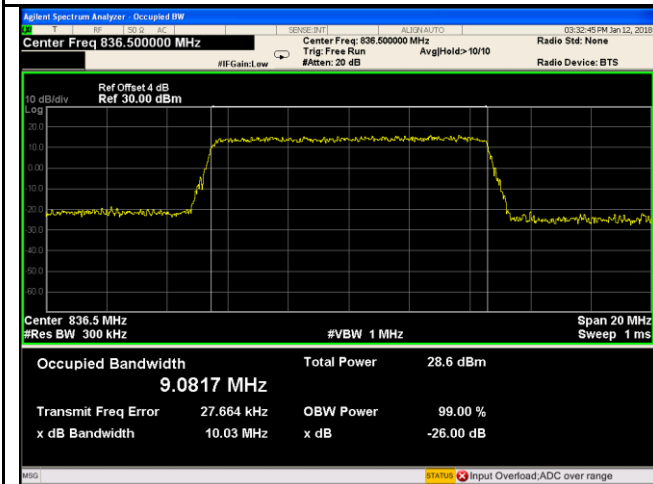

LTE Band V - Middle CH QPSK-10

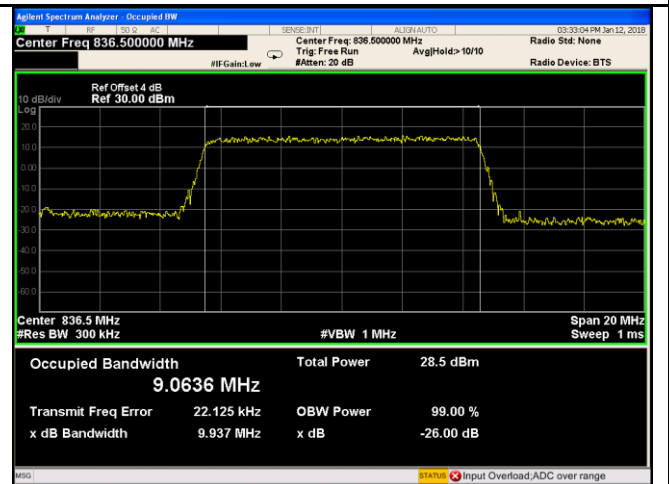

LTE Band V - Middle CH 16QAM-10

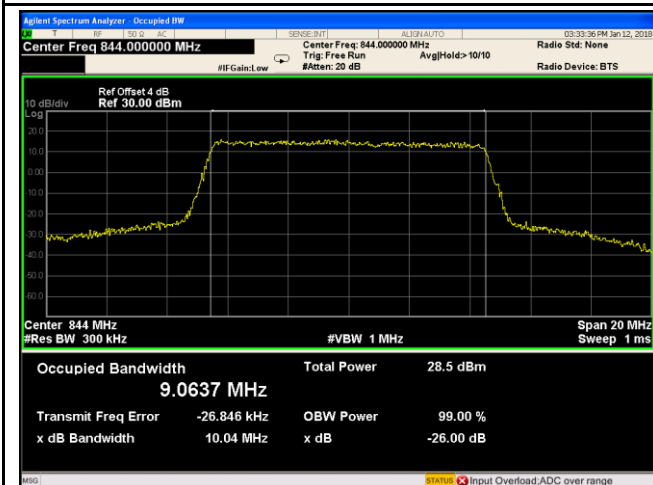

LTE Band V - High CH QPSK-10

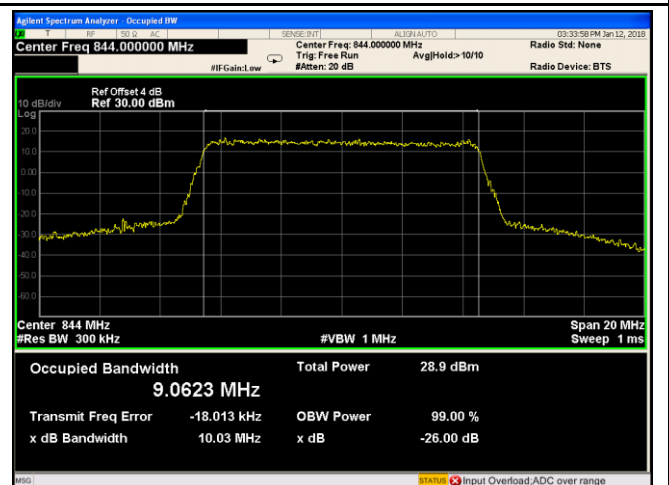

LTE Band V - High CH 16QAM-10

6.5 Spurious Emissions at Antenna Terminals

Temperature	25°C
Relative Humidity	53%
Atmospheric Pressure	1010mbar
Test date :	January 12, 2018
Tested By :	Aaron Liang

Requirement(s):

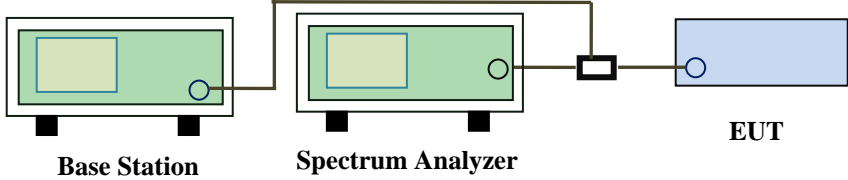
Spec	Item	Requirement	Applicable
§2.1051, §22.917(a)& §24.238(a) § 27.53(h)	a)	The power of any emission outside of the authorized operating frequency ranges must be lower than the transmitter power (P) by a factor of at least $43 + 10 \log(P)$ dB	<input checked="" type="checkbox"/>
Test Setup	 <p style="text-align: center;">Base Station Spectrum Analyzer EUT</p>		
Test Procedure	<ul style="list-style-type: none"> - The EUT was connected to Spectrum Analyzer and Base Station via power divider. - The Band Edges of low and high channels for the highest RF powers were measured. - Setting RBW as roughly BW/100. 		
Remark			
Result	<input checked="" type="checkbox"/> Pass <input type="checkbox"/> Fail		

Test Data Yes N/A
 Test Plot Yes (See below) N/A

Test Plots 30MHz-5GHz
LTE Band II (Part 24E)

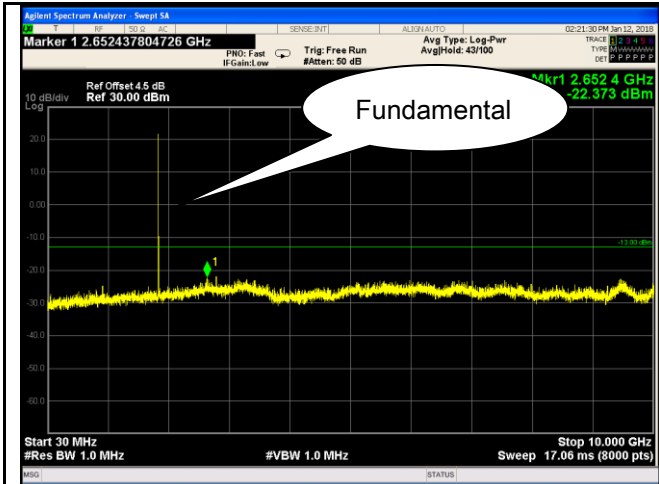

LTE Band II - Low Channel-1

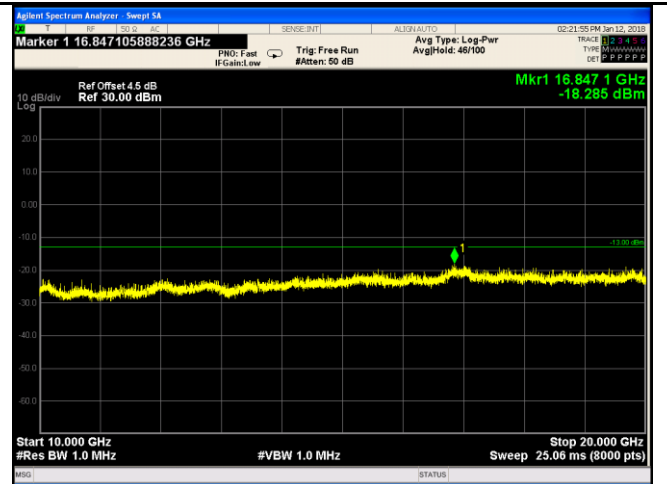

LTE Band II - Low Channel-2

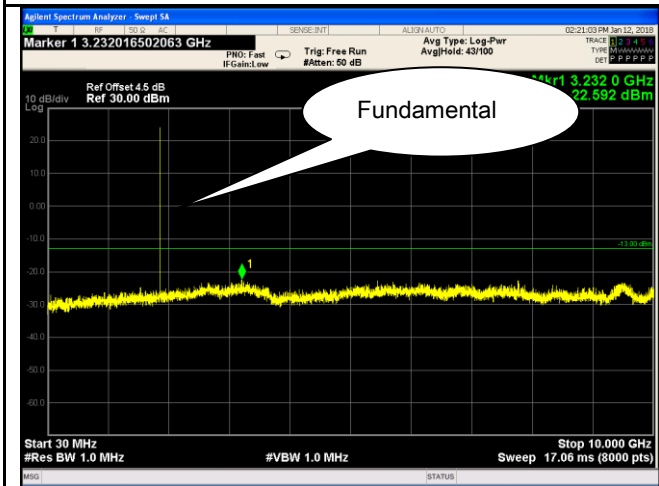

LTE Band II Middle Channel-1

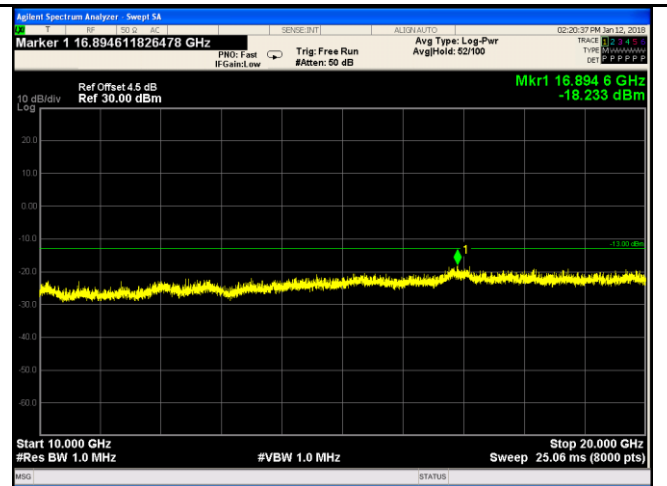

LTE Band II Middle Channel-2

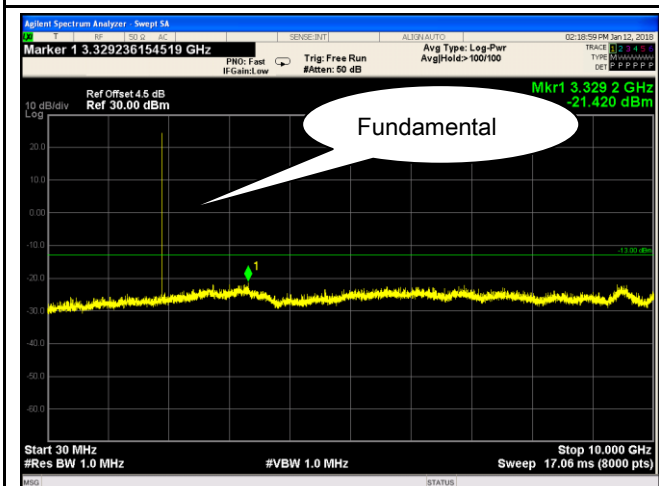

LTE Band II - High Channel-1

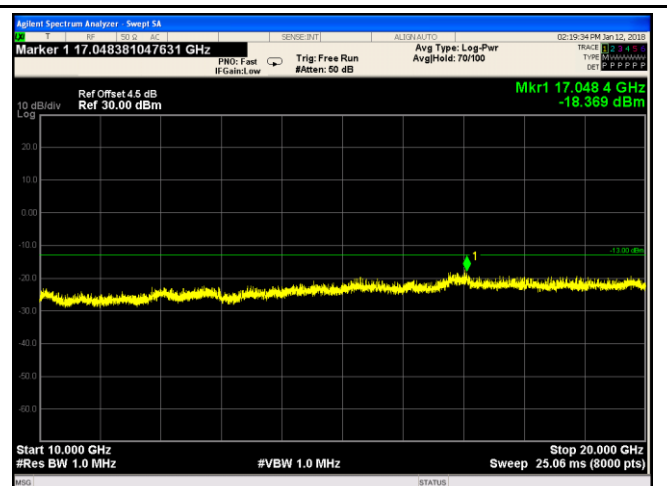

LTE Band II - High Channel-2

LTE Band IV (Part27) result

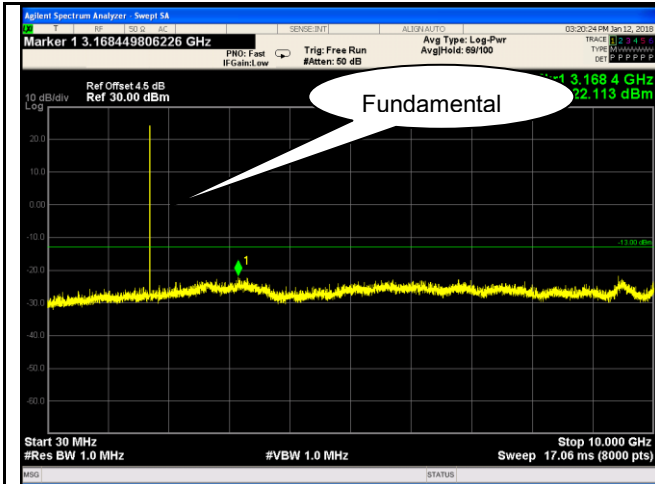

LTE Band IV - Low Channel-1

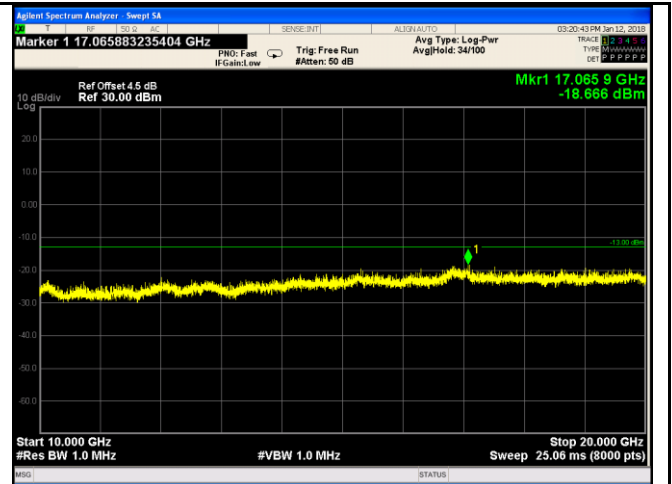

LTE Band IV - Low Channel-2

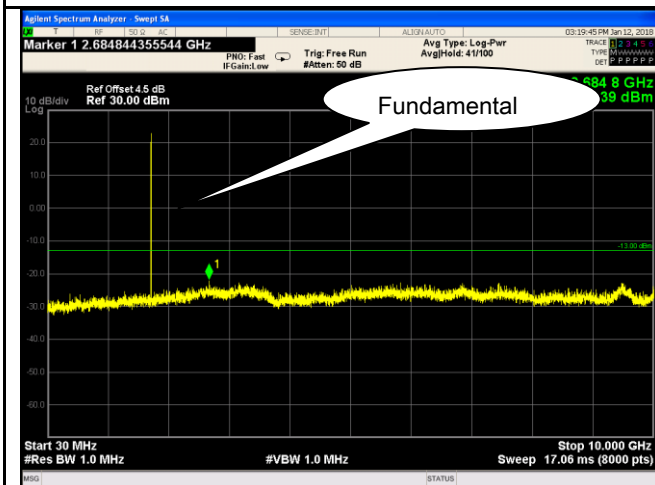

LTE Band IV - Middle Channel-1

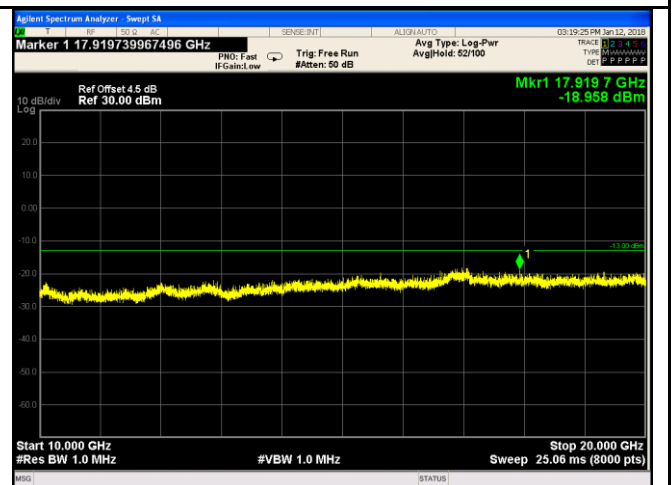

LTE Band IV - Middle Channel-2

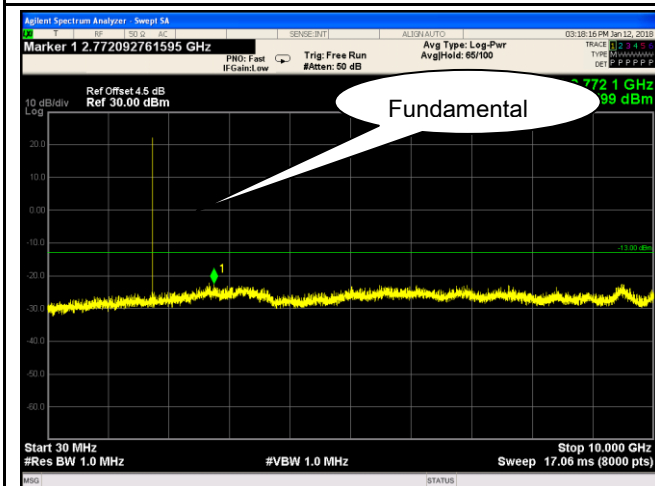

LTE Band IV - High Channel-1

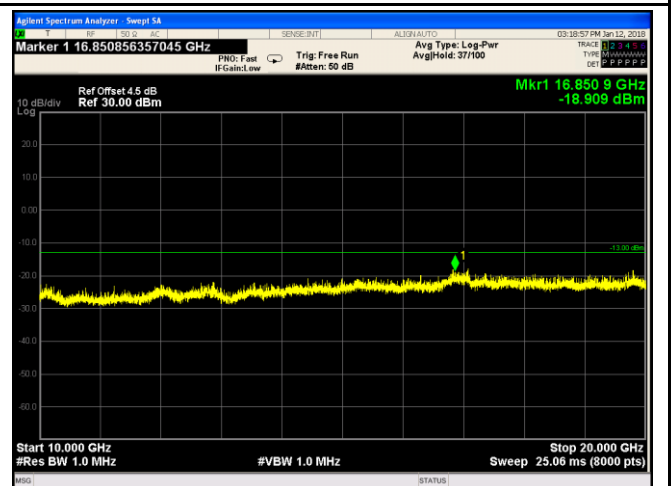

LTE Band IV - High Channel-2

LTE Band V (Part 22H)

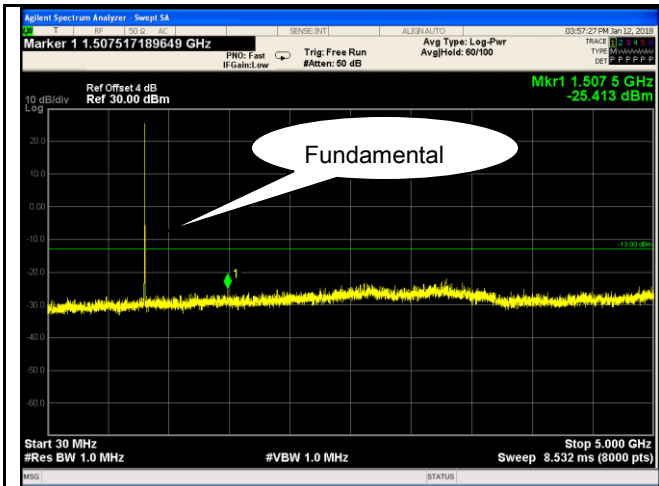

LTE Band V - Low Channel-1

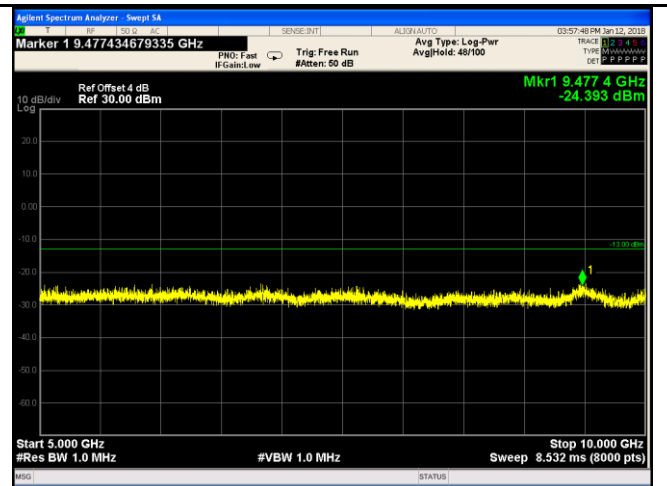

LTE Band V - Low Channel-2

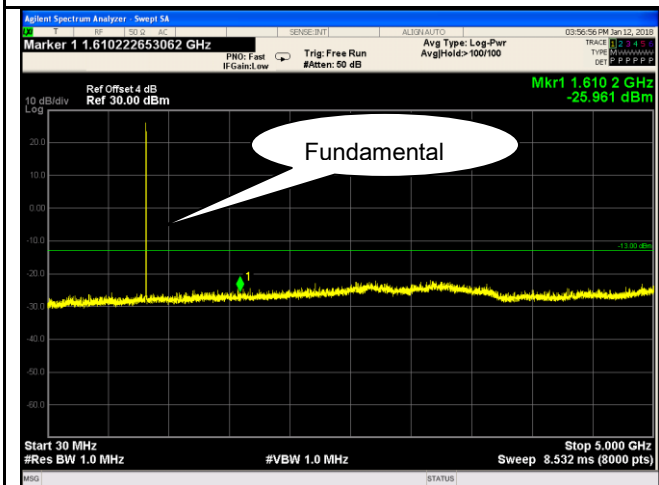

LTE Band V - Middle Channel-1

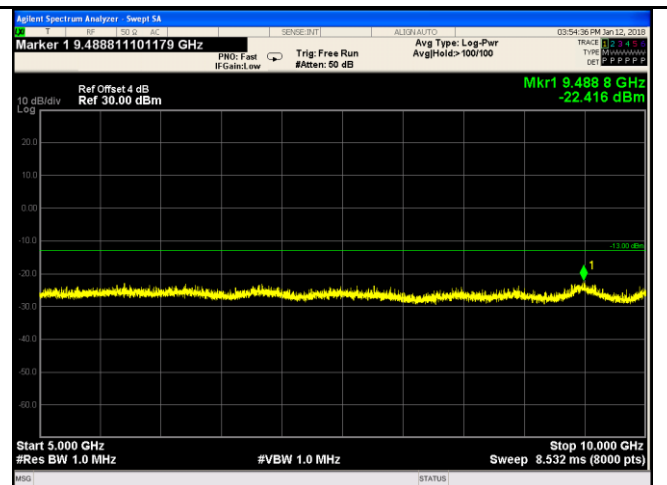

LTE Band V - Middle Channel-2

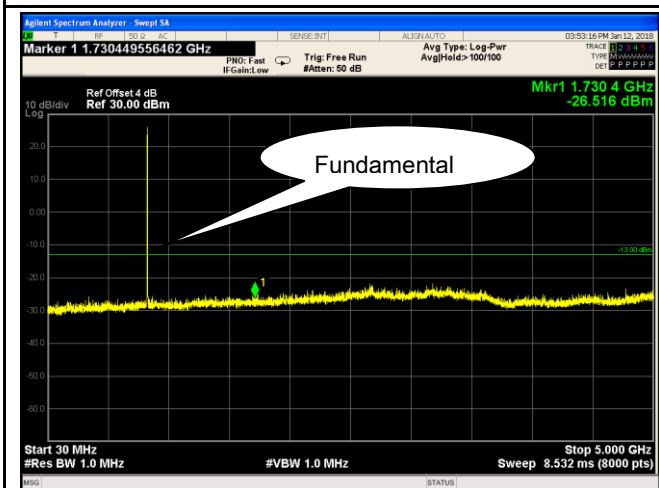

LTE Band V - High Channel-1

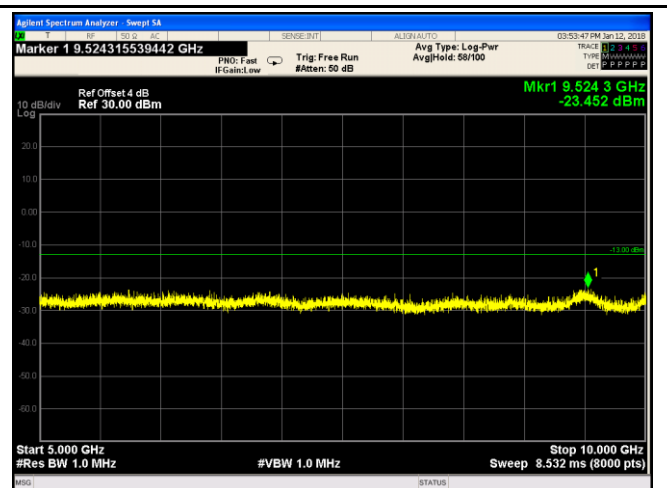

LTE Band V - High Channel-2

6.6 Spurious Radiated Emissions

Temperature	25°C
Relative Humidity	57%
Atmospheric Pressure	1023mbar
Test date :	January 27, 2018
Tested By :	Aaron Liang

Requirement(s):

Spec	Item	Requirement	Applicable
§2.1053, §22.917 & §24.238 § 27.53(h)	a)	The power of any emission outside of the authorized operating frequency ranges must be attenuated below the transmitter power (P) by a factor of at least $43 + 10 \log (P)$ dB. The spectrum is scanned from 30 MHz up to a frequency including its 10th harmonic.	<input checked="" type="checkbox"/>

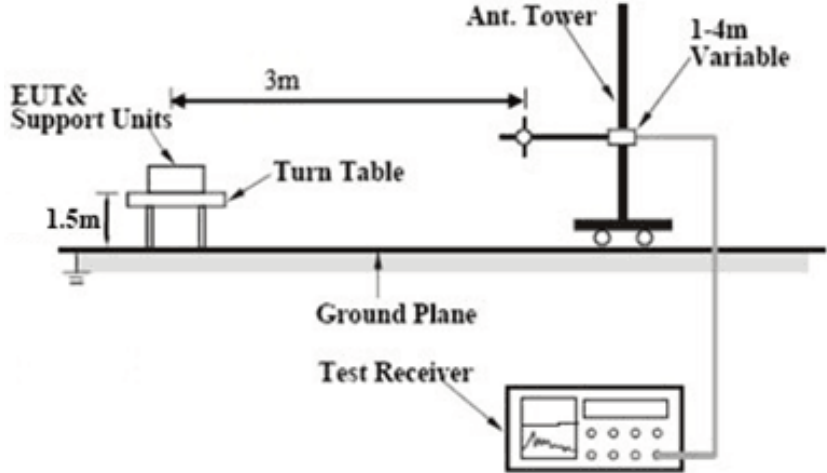
Test setup	
------------	--------------------------------------------------------------------------------------

Test Procedure	<ol style="list-style-type: none"> The transmitter was placed on a wooden turntable, and it was transmitting into a non-radiating load which was also placed on the turntable. The measurement antenna was placed at a distance of 3 meters from the EUT. During the tests, the antenna height and polarization as well as EUT azimuth were varied in order to identify the maximum level of emissions from the EUT. The test was performed by placing the EUT on 3-orthogonal axis. Remove the EUT and replace it with substitution antenna. A signal generator was connected to the substitution antenna by a non-radiating cable. The absolute levels of the spurious emissions were measured by the substitution. <p>Sample Calculation:</p> $\text{EUT Field Strength} = \text{Raw Amplitude (dB}\mu\text{V/m)} - \text{Amplifier Gain (dB)} + \text{Antenna Factor (dB)} + \text{Cable Loss (dB)} + \text{Filter Attenuation (dB, if used)}$
----------------	-------------------------------------------------------------------------------------------------------------------------------------------------------------------------------------------------------------------------------------------------------------------------------------------------------------------------------------------------------------------------------------------------------------------------------------------------------------------------------------------------------------------------------------------------------------------------------------------------------------------------------------------------------------------------------------------------------------------------------------------------------------------------------------------------------------------------------------------------------------------------------------------------------------------------------------------------------------------------------------

Test Report	17071218-FCC-R5
Page	66 of 109

Remark	
Result	<input checked="" type="checkbox"/> Pass <input type="checkbox"/> Fail

Test Data Yes N/A

Test Plot Yes (See below) N/A

LTE Band II (Part 24E) result

Low channel

Frequency (MHz)	Substituted level (dBm)	Polarity (H/V)	Antenna Gain Correction (dB)	Cable Loss (dB)	Corrected Reading (dBm)	Limit (dBm)	Margin (dB)
3720	-49.18	V	10.25	2.73	-41.66	-13	-28.66
3720	-50.67	H	10.25	2.73	-43.15	-13	-30.15
291.17	-52.76	V	5.86	0.28	-47.18	-13	-34.18
702.09	-52.75	H	6.21	0.42	-46.96	-13	-33.96

Middle channel

Frequency (MHz)	Substituted level (dBm)	Polarity (H/V)	Antenna Gain Correction (dB)	Cable Loss (dB)	Corrected Reading (dBm)	Limit (dBm)	Margin (dB)
3760	-48.3	V	10.25	2.73	-40.78	-13	-27.78
3760	-49.06	H	10.25	2.73	-41.54	-13	-28.54
422	-53.13	V	5.93	0.29	-47.49	-13	-34.49
643.64	-54.07	H	6.17	0.44	-48.34	-13	-35.34

High channel

Frequency (MHz)	Substituted level (dBm)	Polarity (H/V)	Antenna Gain Correction (dB)	Cable Loss (dB)	Corrected Reading (dBm)	Limit (dBm)	Margin (dB)
3800	-49.03	V	10.36	2.73	-41.4	-13	-28.4
3800	-49.36	H	10.36	2.73	-41.73	-13	-28.73
841	-53.36	V	6.23	0.44	-47.57	-13	-34.57
386.63	-53.59	H	5.85	0.28	-48.02	-13	-35.02

Note:

- 1, The testing has been conformed to $10 \times 1907.5 \text{ MHz} = 19,075 \text{ MHz}$
- 2, All other emissions more than 30 dB below the limit
- 3, X-Axis, Y-Axis and Z-Axis were investigated. The results above show only the worst case.

LTE Band IV (Part27) result

Low channel

Frequency (MHz)	Substituted level (dBm)	Polarity (H/V)	Antenna Gain Correction (dB)	Cable Loss (dB)	Corrected Reading (dBm)	Limit (dBm)	Margin (dB)
3440	-49.52	V	10.06	2.52	-41.98	-13	-28.98
3440	-50.35	H	10.06	2.52	-42.81	-13	-29.81
520.59	-54.3	V	6.42	0.38	-48.26	-13	-35.26
524.04	-53.68	H	6.39	0.39	-47.68	-13	-34.68

Middle channel

Frequency (MHz)	Substituted level (dBm)	Polarity (H/V)	Antenna Gain Correction (dB)	Cable Loss (dB)	Corrected Reading (dBm)	Limit (dBm)	Margin (dB)
3465	-49.65	V	10.09	2.52	-42.08	-13	-29.08
3465	-50.05	H	10.09	2.52	-42.48	-13	-29.48
791.88	-52.84	V	6.21	0.47	-47.1	-13	-34.1
810.83	-53.24	H	6.17	0.41	-47.48	-13	-34.48

High channel

Frequency (MHz)	Substituted level (dBm)	Polarity (H/V)	Antenna Gain Correction (dB)	Cable Loss (dB)	Corrected Reading (dBm)	Limit (dBm)	Margin (dB)
3490	-49.58	V	10.09	2.52	-42.01	-13	-29.01
3490	-50.27	H	10.09	2.52	-42.7	-13	-29.7
442.86	-52.85	V	6.39	0.33	-46.79	-13	-33.79
699.87	-53.91	H	6.2	0.46	-48.17	-13	-35.17

Note:

- 1, The testing has been conformed to $10 \times 1752.5 \text{ MHz} = 17,525 \text{ MHz}$
- 2, All other emissions more than 30 dB below the limit
- 3, X-Axis, Y-Axis and Z-Axis were investigated. The results above show only the worst case.

LTE Band V (Part22H) result

Low channel

Frequency (MHz)	Substituted level (dBm)	Polarity (H/V)	Antenna Gain Correction (dB)	Cable Loss (dB)	Corrected Reading (dBm)	Limit (dBm)	Margin (dB)
1658	-49.49	V	7.95	0.78	-42.32	-13	-29.32
1658	-49.63	H	7.95	0.78	-42.46	-13	-29.46
646.66	-53.56	V	6.21	0.48	-47.83	-13	-34.83
383.2	-53.67	H	5.9	0.29	-48.06	-13	-35.06

Middle channel

Frequency (MHz)	Substituted level (dBm)	Polarity (H/V)	Antenna Gain Correction (dB)	Cable Loss (dB)	Corrected Reading (dBm)	Limit (dBm)	Margin (dB)
1673	-49.9	V	7.95	0.78	-42.73	-13	-29.73
1673	-49.56	H	7.95	0.78	-42.39	-13	-29.39
846.8	-53.41	V	6.24	0.47	-47.64	-13	-34.64
704.78	-52.99	H	6.21	0.41	-47.19	-13	-34.19

High channel

Frequency (MHz)	Substituted level (dBm)	Polarity (H/V)	Antenna Gain Correction (dB)	Cable Loss (dB)	Corrected Reading (dBm)	Limit (dBm)	Margin (dB)
1688	-49.97	V	7.95	0.78	-42.8	-13	-29.8
1688	-50.28	H	7.95	0.78	-43.11	-13	-30.11
812.14	-52.59	V	6.16	0.42	-46.85	-13	-33.85
800.1	-53.94	H	6.23	0.44	-48.15	-13	-35.15

Note:

- 1, The testing has been conformed to $10 \times 846.5 \text{ MHz} = 8,465 \text{ MHz}$
- 2, All other emissions more than 30 dB below the limit
- 3, X-Axis, Y-Axis and Z-Axis were investigated. The results above show only the worst case.

6.7 Band Edge

Temperature	25°C
Relative Humidity	53%
Atmospheric Pressure	1010mbar
Test date :	January 12, 2018
Tested By :	Aaron Liang

Requirement(s):

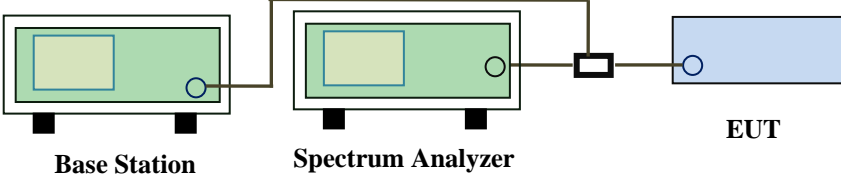
Spec	Item	Requirement	Applicable
§22.917(a) §24.238(a) § 27.53(h)	a)	The power of any emission outside of the authorized operating frequency ranges must be lower than the transmitter power (P) by a factor of at least $43 + 10 \log (P)$ dB.	<input checked="" type="checkbox"/>
Test setup	 <p>The diagram shows a Base Station (green box) connected to a Spectrum Analyzer (green box) and an EUT (blue box) via a power divider (black box). The Base Station and Spectrum Analyzer are connected to each other, and the Spectrum Analyzer is connected to the power divider, which then splits the signal to the EUT.</p>		
Procedure	<ul style="list-style-type: none"> - The EUT was connected to Spectrum Analyzer and Base Station via power divider. - The Band Edges of low and high channels for the highest RF powers were measured. Setting RBW as roughly BW/100. 		
Remark			
Result	<input checked="" type="checkbox"/> Pass <input type="checkbox"/> Fail		

Test Data Yes N/A

Test Plot Yes (See below) N/A

LTE Band II (Part 24E) result

BW(MHz)	Channel	Frequency (MHz)	Mode	Emission (dBm)	Limit (dBm)
1.4	18607	1850	QPSK	-30.071	-13
			16QAM	-29.852	-13
1.4	18900	1910	QPSK	-23.556	-13
			16QAM	-24.056	-13
3	18615	1850	QPSK	-22.920	-13
			16QAM	-24.044	-13
3	19185	1910	QPSK	-24.132	-13
			16QAM	-25.458	-13
5	18625	1850	QPSK	-22.482	-13
			16QAM	-25.563	-13
5	19175	1910	QPSK	-27.783	-13
			16QAM	-27.780	-13
10	18650	1850	QPSK	-30.401	-13
			16QAM	-26.867	-13
10	19150	1910	QPSK	-23.210	-13
			16QAM	-27.566	-13
15	18675	1850	QPSK	-28.334	-13
			16QAM	-29.699	-13
15	19125	1910	QPSK	-27.534	-13
			16QAM	-29.399	-13
20	18700	1850	QPSK	-27.285	-13
			16QAM	-30.670	-13
20	19100	1910	QPSK	-20.828	-13
			16QAM	-21.666	-13

LTE Band IV (Part 27) result

BW(MHz)	Channel	Frequency (MHz)	Mode	Emission (dBm)	Limit (dBm)
1.4	19957	1709.9	QPSK	-26.691	-13
			16QAM	-28.696	-13
1.4	20393	1755	QPSK	-25.211	-13
			16QAM	-26.739	-13
3	19965	1709.9	QPSK	-21.848	-13
			16QAM	-20.844	-13
3	20385	1755	QPSK	-23.997	-13
			16QAM	-25.361	-13
5	19975	1709.9	QPSK	-26.615	-13
			16QAM	-25.915	-13
5	20375	1755	QPSK	-26.442	-13
			16QAM	-24.365	-13
10	20000	1709.9	QPSK	-21.501	-13
			16QAM	-20.428	-13
10	20350	1755	QPSK	-24.623	-13
			16QAM	-28.202	-13
15	20025	1709.9	QPSK	-28.287	-13
			16QAM	-29.483	-13
15	20325	1755	QPSK	-26.903	-13
			16QAM	-25.832	-13
20	20050	1709.9	QPSK	-27.589	-13
			16QAM	-27.584	-13
20	20300	1755	QPSK	-29.939	-13
			16QAM	-30.561	-13

LTE Band V (Part 22H) result

BW(MHz)	Channel	Frequency (MHz)	Mode	Emission (dBm)	Limit (dBm)
1.4	20407	823.9	QPSK	-29.174	-13
			16QAM	-30.179	-13
1.4	20643	849	QPSK	-24.794	-13
			16QAM	-25.395	-13
3	20415	824	QPSK	-21.428	-13
			16QAM	-20.495	-13
3	20635	849	QPSK	-22.852	-13
			16QAM	-25.646	-13
5	20425	824	QPSK	-21.802	-13
			16QAM	-25.077	-13
5	20625	849	QPSK	-19.426	-13
			16QAM	-23.254	-13
10	20450	824	QPSK	-23.824	-13
			16QAM	-23.824	-13
10	20800	849	QPSK	-26.278	-13
			16QAM	-27.267	-13

Test Plots

LTE Band II (Part 24E)

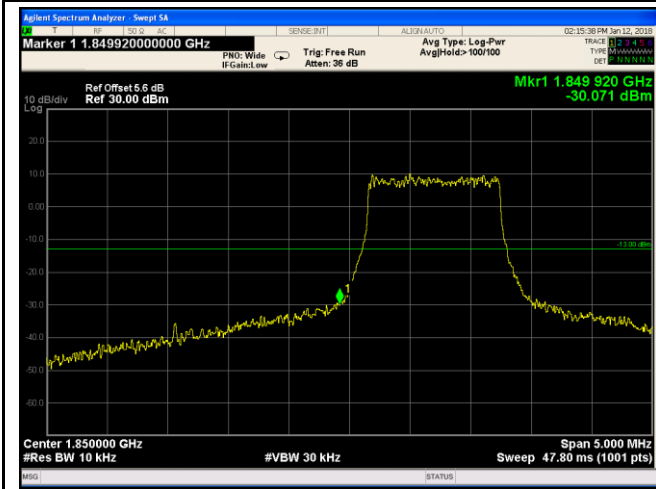

LTE Band II - Low Channel QPSK-1.4

Note: Offset=Cable loss (4.5) + 10log
 (13.05/10)=4.5+1.1=5.6dB

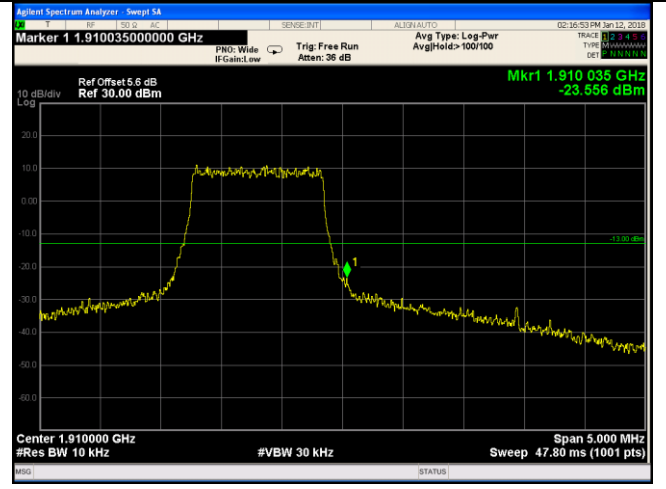

LTE Band II - High Channel QPSK-1.4

Note: Offset=Cable loss (4.5) + 10log
 (13.03/10)=4.5+1.1=5.6dB

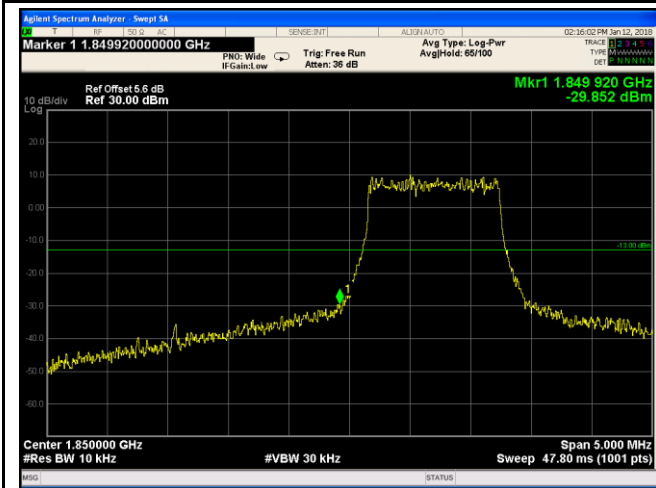

LTE Band II - Low Channel 16QAM-1.4

Note: Offset=Cable loss (4.5) + 10log
 (12.88/10)=4.5+1.1=5.6 dB

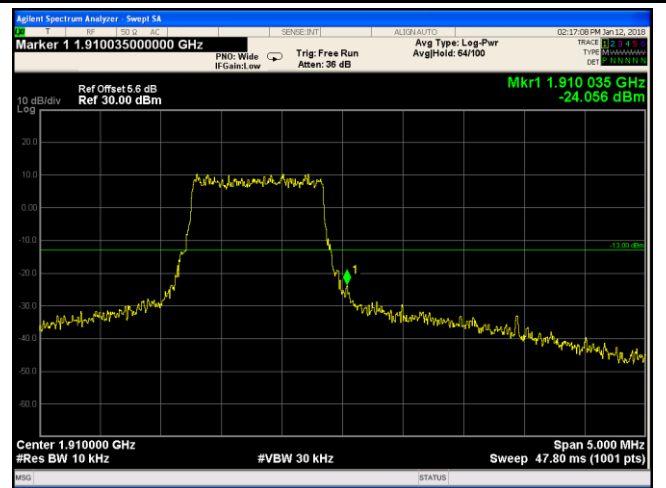

LTE Band II - High Channel 16QAM-1.4

Note: Offset=Cable loss (4.5) + 10log
 (13.00/10)=4.5+1.1=5.6 dB

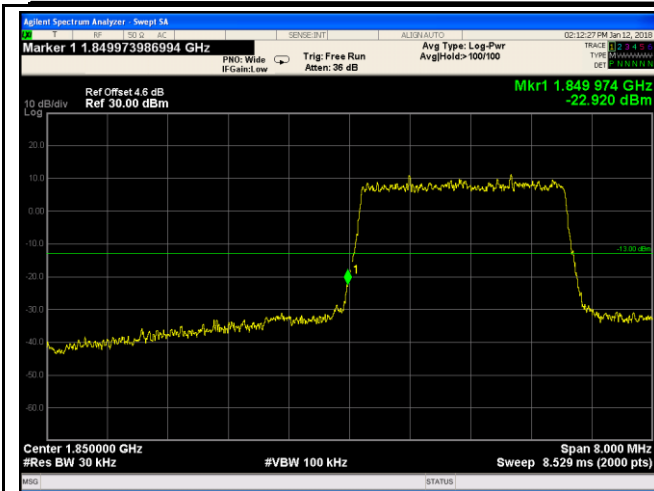

LTE Band II - Low Channel QPSK-3

Note: Offset=Cable loss (4.5) + 10log
(30.57/30)=4.5+0.1=4.6 dB

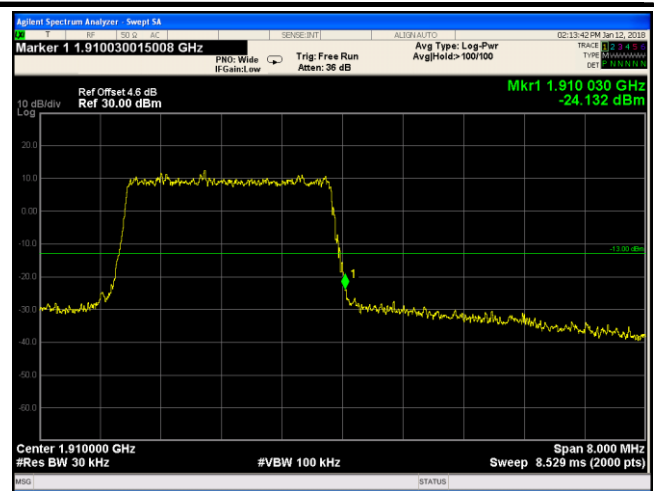

LTE Band II - High Channel QPSK-3

Note: Offset=Cable loss (4.5) + 10log
(30.50/30)=4.5+0.1=4.6 dB

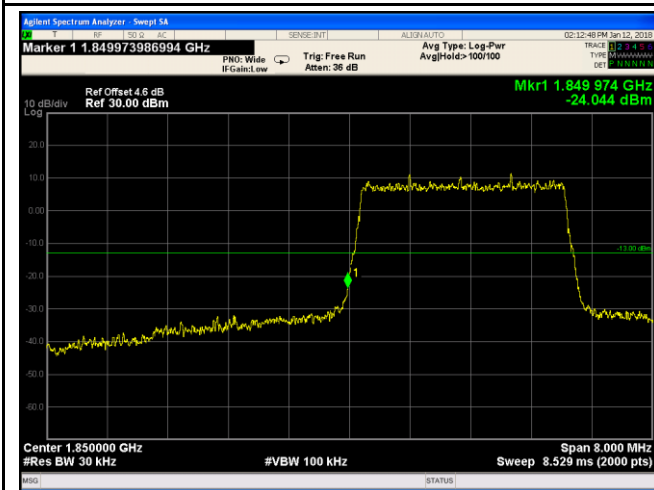

LTE Band II - Low Channel 16QAM-3

Note: Offset=Cable loss (4.5) + 10log
(30.57/30)=4.5+0.1=4.6 dB

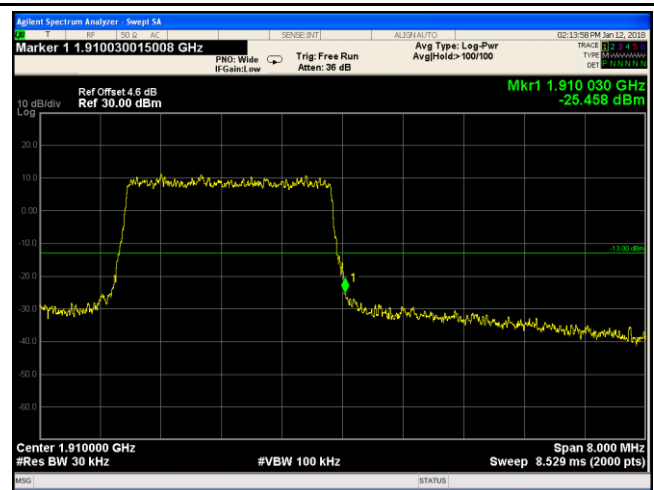

LTE Band II - High Channel 16QAM-3

Note: Offset=Cable loss (4.5) + 10log
(30.89/30)=4.5+0.1=4.6 dB

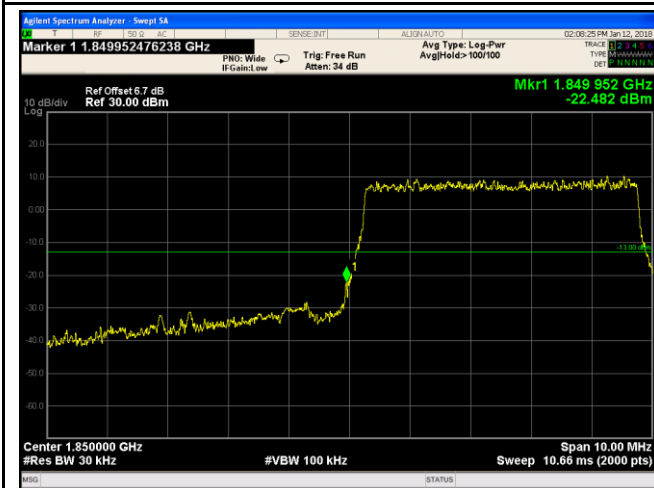

LTE Band II - Low Channel QPSK-5

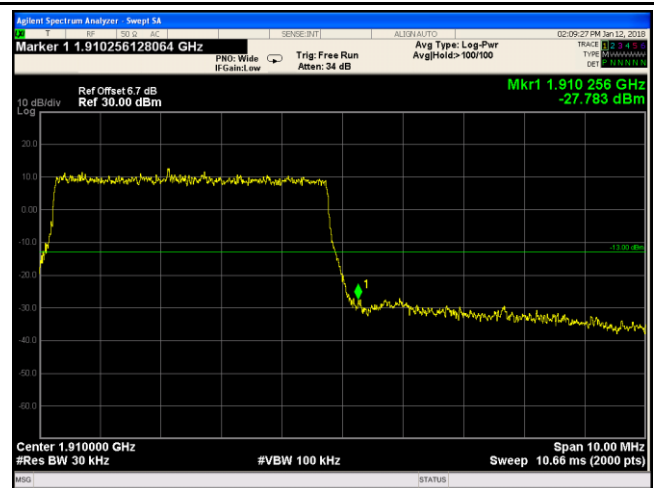

LTE Band II - High Channel QPSK-5

Note: Offset=Cable loss (4.5) + 10log
(49.92/30)=4.5+2.2=6.7dB

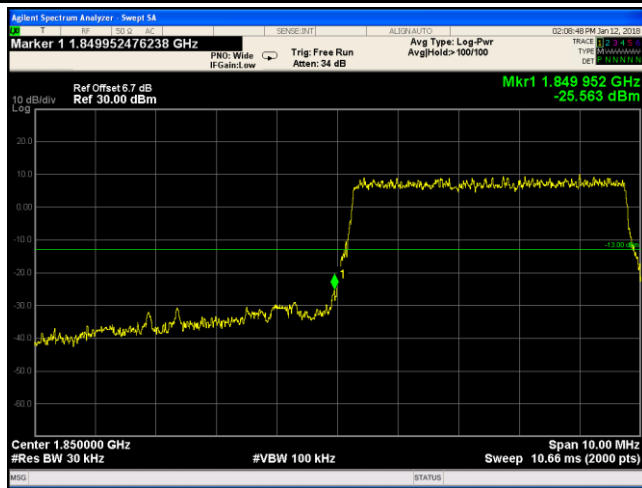

LTE Band II - Low Channel 16QAM-5

Note: Offset=Cable loss (4.5) + 10log
(49.41/30)=4.5+2.2=6.7 dB

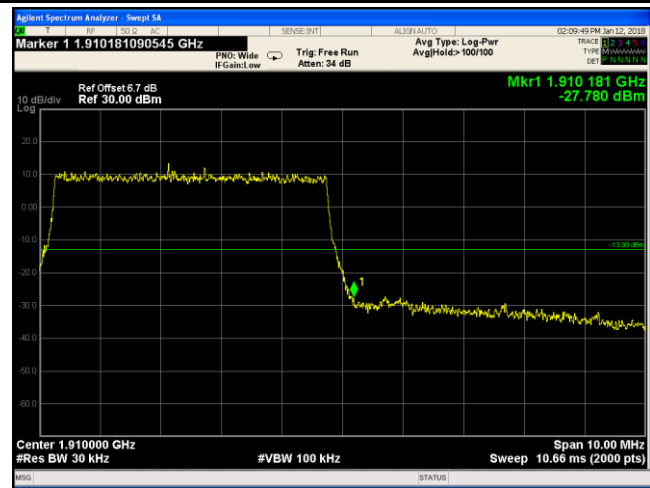

LTE Band II - High Channel 16QAM-5

Note: Offset=Cable loss (4.5) + 10log
(50.23/30)=4.5+2.2=6.7 dB

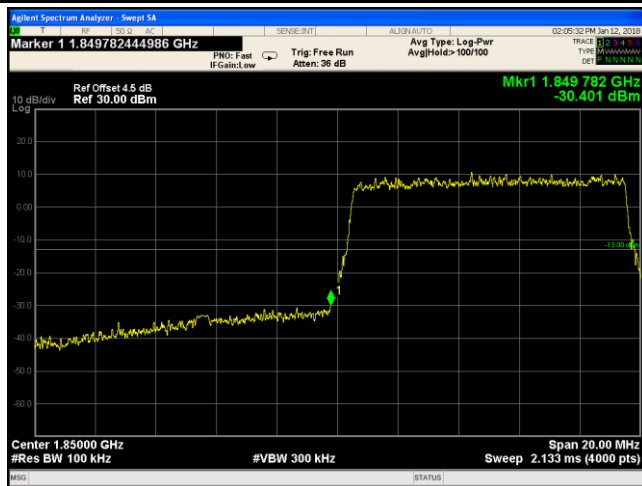

LTE Band II - Low Channel QPSK-10

Note: Offset=Cable loss (4.5) + 10log
(50.08/30)=4.5+2.2=6.7 dB

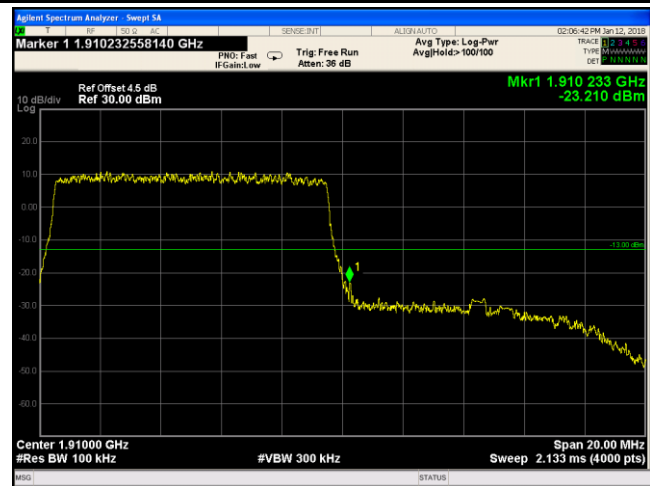

LTE Band II - High Channel QPSK-10

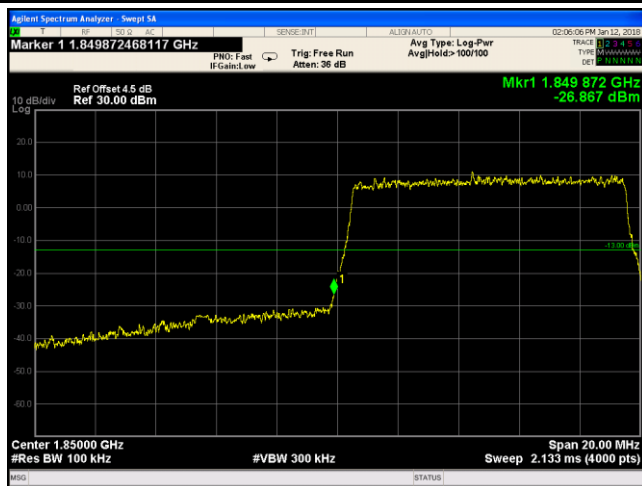

LTE Band II - Low Channel 16QAM-10

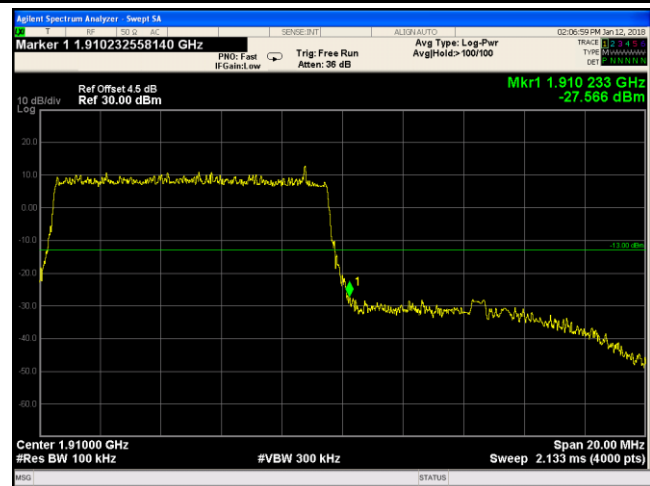

LTE Band II - High Channel 16QAM-10

Note: Offset=Cable loss (4.5) + 10log
(98.64/100)=4.5+0.0=4.5 dB

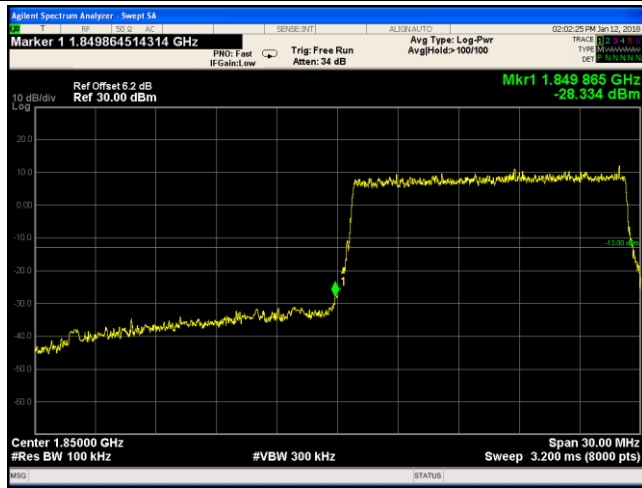

LTE Band II - Low Channel QPSK-15

Note: Offset=Cable loss (4.5) + 10log
(100.2/100)=4.5+0.0=4.5 dB

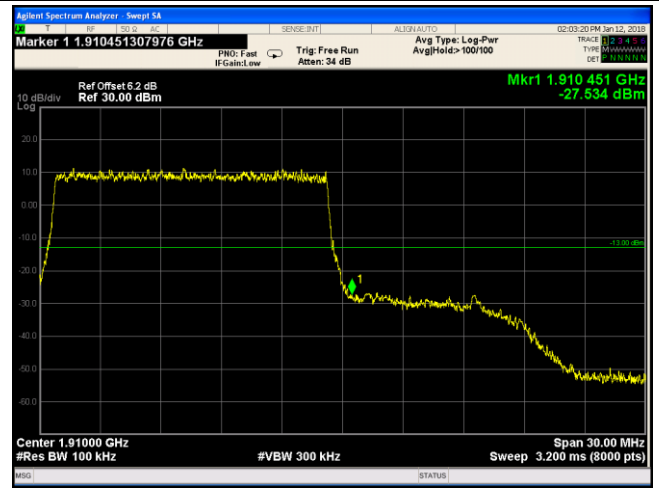

LTE Band II - High Channel QPSK-15

Note: Offset=Cable loss (4.5) + 10log
(148.5/100)=4.5+2.3=6.2 dB

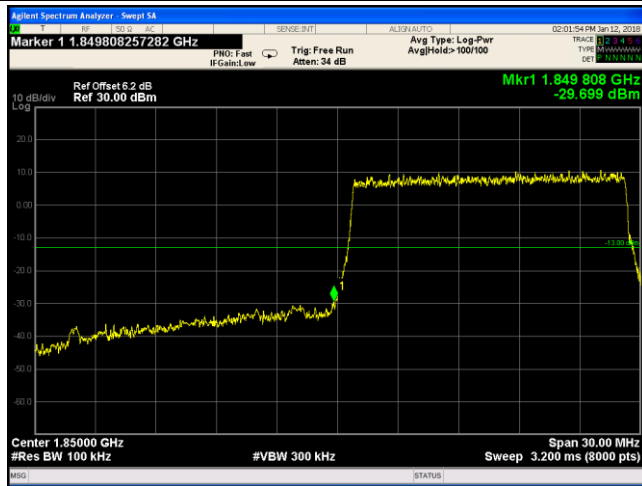

LTE Band II - Low Channel 16QAM-15

Note: Offset=Cable loss (4.5) + 10log
(146.6/100)=4.5+2.3=6.2 dB

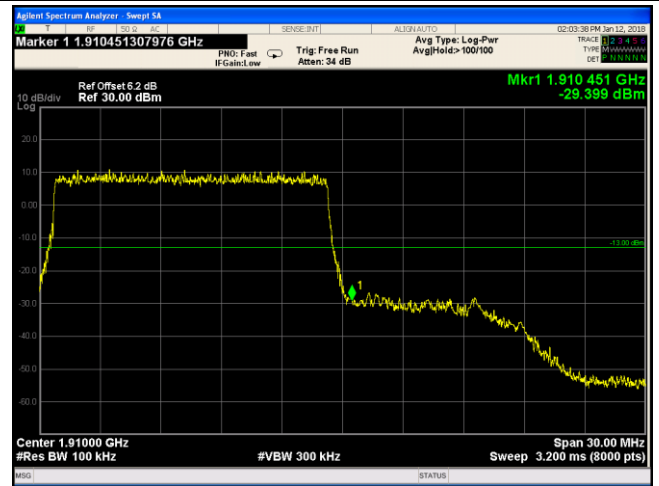

LTE Band II - High Channel 16QAM-15

Note: Offset=Cable loss (4.5) + 10log
(146.5/100)=4.5+2.3=6.2 dB

Note: Offset=Cable loss (4.5) + 10log
(147.1/100)=4.5+2.3=6.2dB

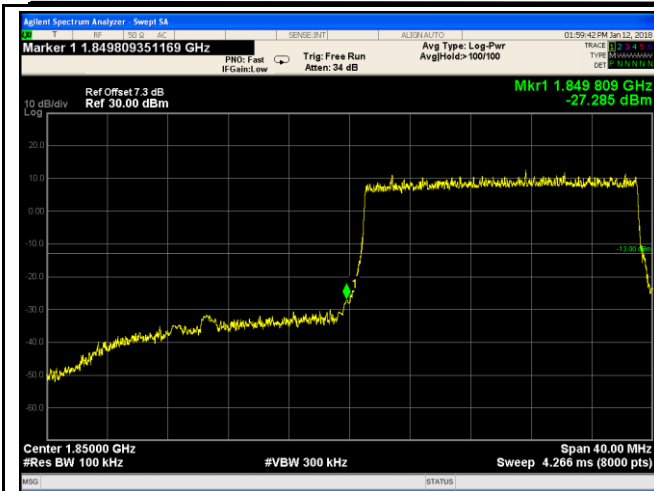

LTE Band II - Low Channel QPSK-20

Note: Offset=Cable loss (4.5) + 10log
(190.9/100)=4.5+2.8=7.3 dB

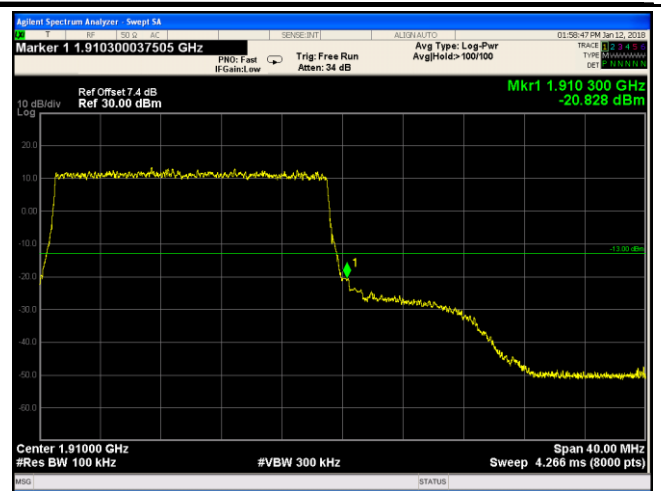

LTE Band II - High Channel QPSK-20

Note: Offset=Cable loss (4.5) + 10log
(193/100)=4.5+2.9=7.4 dB

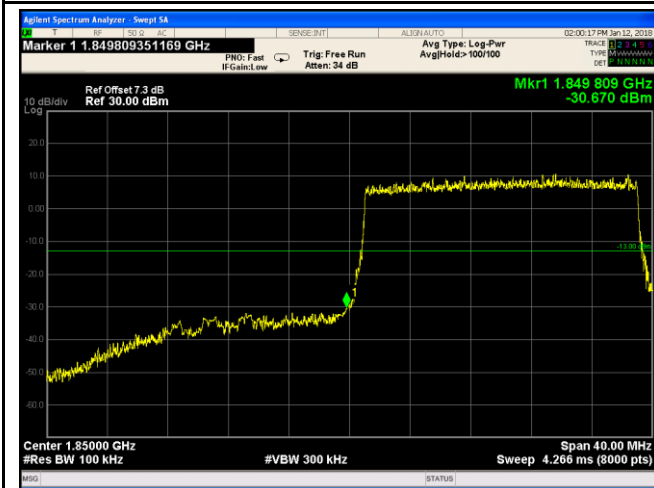

LTE Band II - Low Channel 16QAM-20

Note: Offset=Cable loss (4.5) + 10log
(191/100)=4.5+2.8=7.3dB

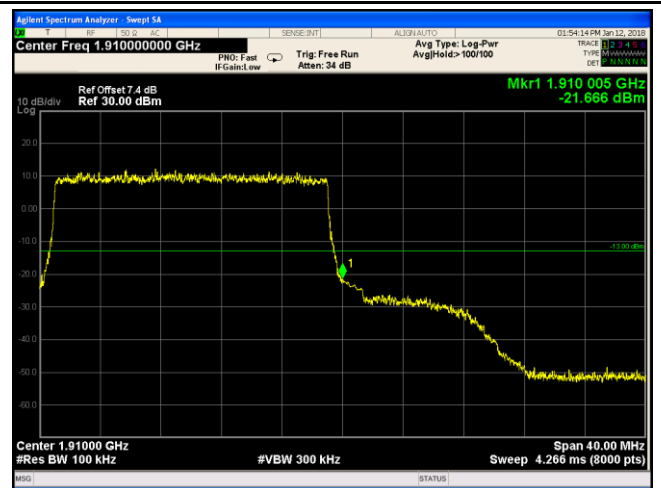

LTE Band II - High Channel 16QAM-20

Note: Offset=Cable loss (4.5) + 10log
(191.5/100)=4.5+2.9=7.4 dB