

FCC Test Report

Report No.: AGC01684180501FE07

FCC ID : 2AJ2B-TPS360
APPLICATION PURPOSE : Original Equipment
PRODUCT DESIGNATION : Handheld Fingerprint Terminal
BRAND NAME : N/A
MODEL NAME : TPS360
CLIENT : Telepower Communication Co., Ltd
DATE OF ISSUE : July 13, 2018
STANDARD(S) : FCC Part 22 Rules
FCC Part 24 Rules
FCC Part 27 Rules
REPORT VERSION : V1.2

Attestation of Global Compliance (Shenzhen) Co., Ltd.

CAUTION:

This report shall not be reproduced except in full without the written permission of the test laboratory and shall not be quoted out of context.



The results shown in this test report refer only to the sample(s) tested unless otherwise stated and the sample(s) are retained for 30 days only. The document is issued by AGC, this document cannot be reproduced except in full with our prior written permission. The more details and the authenticity of the report will be confirmed at <http://www.agc-cert.com>.

REPORT REVISE RECORD

Report Version	Revise Time	Issued Date	Valid Version	Notes
V1.0	/	June 25, 2018	Invalid	Original Report
V1.1	1 st	July 12, 2018	Invalid	Revise Report P6 P56-60 113
V1.2	2 nd	July 13, 2018	Valid	Revise Report P15 P52-53 P60-61

The results shown in this test report refer only to the sample(s) tested unless otherwise stated and the sample(s) are retained for 30 days only. The document is issued by AGC, this document cannot be reproduced except in full with our prior written permission. The more details and the authenticity of the report will be confirmed at <http://www.agc-cert.com>.

TABLE OF CONTENTS

1. VERIFICATION OF COMPLIANCE **5**

2. GENERAL INFORMATION **6**

 2.1 PRODUCT DESCRIPTION 6

 2.2 RELATED SUBMITTAL(S) / GRANT (S) 8

 2.3 TEST METHODOLOGY 8

 2.4 TEST FACILITY 9

 2.5 SPECIAL ACCESSORIES 11

 2.6 EQUIPMENT MODIFICATIONS 11

3. SYSTEM TEST CONFIGURATION **12**

 3.1 EUT CONFIGURATION 12

 3.2 EUT EXERCISE 12

 3.3 GENERAL TECHNICAL REQUIREMENTS 12

 3.4 CONFIGURATION OF EUT SYSTEM 13

4. SUMMARY OF TEST RESULTS **14**

5. DESCRIPTION OF TEST MODES **15**

6. OUTPUT POWER **20**

 6.1 CONDUCTED OUTPUT POWER 20

 6.1.1 MEASUREMENT METHOD 20

 6.2 RADIATED OUTPUT POWER 48

 6.2.1 MEASUREMENT METHOD 48

 6.3. PEAK-TO-AVERAGE RATIO 62

 6.3.1 MEASUREMENT METHOD 62

7. SPURIOUS EMISSION **97**

 7.1 CONDUCTED SPURIOUS EMISSION 97

 7.2 RADIATED SPURIOUS EMISSION 99

8. FREQUENCY STABILITY **107**

 8.1 MEASUREMENT METHOD 107

 8.2 PROVISIONS APPLICABLE 108

 8.3 MEASUREMENT RESULT (WORST) 109

9. OCCUPIED BANDWIDTH **112**

 9.1 MEASUREMENT METHOD 112

 9.2 PROVISIONS APPLICABLE 112

 9.3 MEASUREMENT RESULT 112

10. EMISSION BANDWIDTH **123**

The results shown in this test report refer only to the sample(s) tested unless otherwise stated and the sample(s) are retained for 30 days only. The document is issued by AGC, this document cannot be reproduced except in full with our prior written permission. The more details and the authenticity of the report will be confirmed at <http://www.agc-cert.com>.

10.1 MEASUREMENT METHOD	123
10.2 PROVISIONS APPLICABLE	123
10.3 MEASUREMENT RESULT	123
11. BAND EDGE	134
11.1 MEASUREMENT METHOD	134
11.2 PROVISIONS APPLICABLE	134
11.3 MEASUREMENT RESULT	134
APPENDIX A TEST PLOTS FOR CONDUCTED SPURIOUS EMISSION	135
APPENDIX B TEST PLOTS FOR OCCUPIED BANDWIDTH (99%).....	150
EMISSION BANDWIDTH (-26dBc).....	150
APPENDIX C TEST PLOTS FOR BAND EDGES.....	177
APPENDIX D PHOTOGRAPHS OF TEST SETUP	203

The results shown in this test report refer only to the sample(s) tested unless otherwise stated and the sample(s) are retained for 30 days only. The document is issued by AGC, this document cannot be reproduced except in full with our prior written permission. The more details and the authenticity of the report will be confirmed at <http://www.agc-cert.com>.

1. VERIFICATION OF COMPLIANCE

Applicant	Telepower Communication Co., Ltd
Address	5 Bld, Zone A, Hantian Technology Town, No.17 ShenHai RD, Nanhai District Foshan, China
Manufacturer	Telepower Communication Co., Ltd
Address	5 Bld, Zone A, Hantian Technology Town, No.17 ShenHai RD, Nanhai District Foshan, China
Product Designation	Handheld Fingerprint Terminal
Brand Name	N/A
Test Model	TPS360
Date of test	May. 28, 2018~June 25, 2018
Deviation	None
Condition of Test Sample	Normal

We hereby certify that:

The above equipment was tested by Attestation of Global Compliance (Shenzhen) Co., Ltd. The data evaluation, test procedures, and equipment configurations shown in this report were made in accordance with the procedures given in ANSI/TIA-603-E-2016. The sample tested as described in this report is in compliance with the FCC Rules Part 22, 24 and 27.

The test results of this report relate only to the tested sample identified in this report.

Tested By

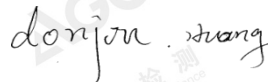

Donjon Huang (Huang
Dongyang)

June 25, 2018

Reviewed By



Bart Xie (Xie Xiaobin)

July 13, 2018

Approved By



Forrest Lei (Lei Yonggang)
Authorized Officer

July 13, 2018

The results shown in this test report refer only to the sample(s) tested unless otherwise stated and the sample(s) are retained for 30 days only. The document is issued by AGC, this document cannot be reproduced except in full with our prior written permission. The more details and the authenticity of the report will be confirmed at <http://www.agc-cert.com>.

2. GENERAL INFORMATION

2.1 PRODUCT DESCRIPTION

A major technical description of EUT is described as following:

Radio System Type:	LTE	
Hardware version:	MAIN-360D-V2.4	
Software version:	TPS360_V1.0.0	
Frequency Bands:	<input checked="" type="checkbox"/> FDD Band 2 <input checked="" type="checkbox"/> FDD Band 4 <input checked="" type="checkbox"/> FDD Band 5 <input checked="" type="checkbox"/> FDD Band 7 <input type="checkbox"/> FDD Band 12 <input checked="" type="checkbox"/> FDD Band 25 <input type="checkbox"/> FDD Band 26 <input type="checkbox"/> TDD Band 41 (U.S. Bands) <input type="checkbox"/> FDD Band 1 <input type="checkbox"/> FDD Band 3 <input type="checkbox"/> FDD Band 7 <input type="checkbox"/> FDD Band 8 <input type="checkbox"/> FDD Band 20 <input type="checkbox"/> TDD Band 33 <input type="checkbox"/> TDD Band 34 <input type="checkbox"/> TDD Band 38 <input type="checkbox"/> FDD Band 40 <input type="checkbox"/> FDD Band 42 <input type="checkbox"/> FDD Band 43 (Non-U.S. Bands)	
Frequency Range	LTE Band 2	Transmission (TX): 1850 to 1909.9 MHz
		Receiving (RX): 1930 to 1989.9 MHz
	LTE Band 4	Transmission (TX): 1710 to 1754.9 MHz
		Receiving (RX): 2110 to 2154.9 MHz
	LTE Band 5	Transmission (TX): 824 to 848.9 MHz
		Receiving (RX): 869 to 893.9 MHz
	LTE Band 7	Transmission (TX): 2500 to 2569.9MHz
		Receiving (RX): 2620 to 2689.9 MHz
	LTE Band 25	Transmission (TX): 1850 to 1914.9 MHz
		Receiving (RX): 1930 to 1994.9 MHz
Supported Channel Bandwidth	LTE Band 2	<input checked="" type="checkbox"/> 1.4 MHz <input checked="" type="checkbox"/> 3 MHz <input checked="" type="checkbox"/> 5 MHz
		<input checked="" type="checkbox"/> 10 MHz <input checked="" type="checkbox"/> 15 MHz <input checked="" type="checkbox"/> 20 MHz
	LTE Band 4	<input checked="" type="checkbox"/> 1.4 MHz <input checked="" type="checkbox"/> 3 MHz <input checked="" type="checkbox"/> 5 MHz
		<input checked="" type="checkbox"/> 10 MHz <input checked="" type="checkbox"/> 15 MHz <input checked="" type="checkbox"/> 20 MHz
	LTE Band 5	<input checked="" type="checkbox"/> 1.4 MHz <input checked="" type="checkbox"/> 3 MHz <input checked="" type="checkbox"/> 5 MHz <input checked="" type="checkbox"/> 10 MHz
LTE Band 7	<input checked="" type="checkbox"/> 5 MHz <input checked="" type="checkbox"/> 10 MHz <input checked="" type="checkbox"/> 15 MHz <input checked="" type="checkbox"/> 20 MHz	
LTE Band 25	<input checked="" type="checkbox"/> 1.4 MHz <input checked="" type="checkbox"/> 3 MHz <input checked="" type="checkbox"/> 5 MHz <input checked="" type="checkbox"/> 10 MHz <input checked="" type="checkbox"/> 15 MHz <input checked="" type="checkbox"/> 20 MHz	
Antenna:	PIFA Antenna	
Type of Modulation	QPSK/16QAM	
Antenna gain:	-1.60dBi(LTE band 2),-1.25dBi (LTE band 4), -1.47dBi (LTE band 5), -1.32dBi(Band 7) -1.71dBi (LTE band 25),	
Power Supply:	DC 3.8V by battery	
Dual Card:	GSM/WCDMA/LTE Card Slot	

The results shown in this test report refer only to the sample(s) tested unless otherwise stated and the sample(s) are retained for 30 days only. The document is issued by AGC, this document cannot be reproduced except in full with our prior written permission. The more details and the authenticity of the report will be confirmed at <http://www.agc-cert.com>.

Power Class	3
Extreme Vol. Limits:	DC3.4V to 4.35 V (Normal: 3.8 V)
Temperature range	-10°C to +50°C
Note1: The High Voltage DC4.35V and Low Voltage DC3.4V were declared by manufacturer, The EUT couldn't be operating normally with higher or lower voltage..	

The results shown in this test report refer only to the sample(s) tested unless otherwise stated and the sample(s) are retained for 30 days only. The document is issued by AGC, this document cannot be reproduced except in full with our prior written permission. The more details and the authenticity of the report will be confirmed at <http://www.agc-cert.com>.

2.2 RELATED SUBMITTAL(S) / GRANT (S)

This submittal(s) (test report) is intended for **FCC ID: 2AJ2B-TPS360**, filing to comply with the FCC Part 22, Part 24 and Part 27 requirements

2.3 TEST METHODOLOGY

The radiated emission testing was performed according to the procedures of ANSI/TIA-603-E-2016, and FCC KDB 971168 D01 Power Means License Digital Systems V03R01.

The results shown in this test report refer only to the sample(s) tested unless otherwise stated and the sample(s) are retained for 30 days only. The document is issued by AGC, this document cannot be reproduced except in full with our prior written permission. The more details and the authenticity of the report will be confirmed at <http://www.agc-cert.com>.

2.4 TEST FACILITY

Site	Attestation of Global Compliance (Shenzhen) Co., Ltd
Location	1-2F., Bldg.2, No.1-4, ChaxiSanwei Technical Industrial Park, Gushu, Xixiang, Bao'an District B112-B113, Bldg.12, BaoanBldg Materials Center, No.1 of Xixiang Inner Ring Road, Baoan District, Shenzhen 518012
NVLAP LAB CODE	600153-0
Designation Number	CN5028
Description	Attestation of Global Compliance(Shenzhen) Co., Ltd is accredited by National Voluntary Laboratory Accreditation program, NVLAP Code 600153-0

ALL TEST EQUIPMENT LIST

Equipment	Manufacturer	Model	S/N	Cal. Date	Cal. Due
TEST RECEIVER	R&S	ESPI	101206	Jun.20, 2017	Jun.19, 2018
TEST RECEIVER	R&S	ESPI	101206	Jun.18, 2018	Jun.17, 2019
LISN	R&S	ESH2-Z5	100086	Aug.21, 2017	Aug.20, 2018
TEST RECEIVER	R&S	ESCI	10096	Jun.20, 2017	Jun.19, 2018
TEST RECEIVER	R&S	ESCI	10096	Jun.18, 2018	Jun.17, 2019
EXA Signal Analyzer	Aglient	N9010A	MY53470504	Dec.08, 2017	Dec.07, 2018
Horn antenna	SCHWARZBECK	BBHA 9170	#768	Sep.20, 2017	Sep.19, 2018
preamplifier	ChengYi	EMC184045SE	980508	Sep.15, 2017	Sep.14, 2018
Double-Ridged Waveguide Horn	ETS LINDGREN	3117	00034609	May.18, 2017	May.17, 2019
Broadband Preamplifier	SCHWARZBECK	BBV 9718	9718-205	Jun.20, 2017	Jun.19, 2018
Broadband Preamplifier	SCHWARZBECK	BBV 9718	9718-205	Jun.18, 2018	Jun.17, 2019
ANTENNA	SCHWARZBECK	VULB9168	D69250	Sep.28, 2017	Sep.27, 2018
SIGNAL ANALYZER	Agilent	N9020A	MY52090123	Sep. 21, 2017	Sep. 20, 2018
USB Wideband Power Sensor	Agilent	U2021XA	MY54110007	Sep. 21, 2017	Sep. 20, 2018
Universal Radio Communication Tester	R&S	CMU200	120237	Mar.01,2018	Feb.28,2019
Universal Radio Communication Tester	Agilent	8960	GB46200384	July 16,2017	July 15,2018
Wireless communication test	R&S	CMW500	120909	July 13, 2017	July 12, 2018

The results shown in this test report refer only to the sample(s) tested unless otherwise stated and the sample(s) are retained for 30 days only. The document is issued by AGC, this document cannot be reproduced except in full with our prior written permission. The more details and the authenticity of the report will be confirmed at <http://www.agc-cert.com>.

Power Splitter	Agilent	11636A	34	Sep.21,2017	Sep.20,2018
Attenuator	JFW	50FHC-006-50	N/A	Jun.20, 2017	Jun.19, 2018
Attenuator	JFW	50FHC-006-50	N/A	Jun.18, 2018	Jun.17, 2019

The results shown in this test report refer only to the sample(s) tested unless otherwise stated and the sample(s) are retained for 30 days only. The document is issued by AGC, this document cannot be reproduced except in full with our prior written permission. The more details and the authenticity of the report will be confirmed at <http://www.agc-cert.com>.

2.5 SPECIAL ACCESSORIES

The battery was supplied by the applicant were used as accessories and being tested with EUT intended for FCC grant together.

2.6 EQUIPMENT MODIFICATIONS

Not available for this EUT intended for grant.

The results shown in this test report refer only to the sample(s) tested unless otherwise stated and the sample(s) are retained for 30 days only. The document is issued by AGC, this document cannot be reproduced except in full with our prior written permission. The more details and the authenticity of the report will be confirmed at <http://www.agc-cert.com>.

3. SYSTEM TEST CONFIGURATION

3.1 EUT CONFIGURATION

The EUT configuration for testing is installed on RF field strength measurement to meet the Commission's requirement and operating in a manner which intends to maximize its emission characteristics in a continuous normal application.

3.2 EUT EXERCISE

The Transmitter was operated in the maximum output power mode through Communication Tester. The TX frequency was fixed which was for the purpose of the measurements.

3.3 GENERAL TECHNICAL REQUIREMENTS

Item Number	Item Description		FCC Rules
1	Output Power	Conducted output power	2.1046/22.913(a)(2)/24.232(c)/ 27.50(d)(4)/ 27.50(h)(2)
		Radiated output power	
2	Peak-to-Average Ratio	Peak-to-Average Ratio	24.232(d)
3	Spurious Emission	Conducted spurious emission	2.1051/22.917(a)/24.238(a) 27.53(h)/ 27.53(g)
		Radiated spurious emission	
4	Frequency Stability		2.1055/22.355/24.235/27.54
5	Occupied Bandwidth		2.1049 (h)(i)
6	Band Edge		2.1051/22.917(a)/24.238(a) 27.53(h)/ 27.53(g)

Note: Testing was performed by configuring EUT to maximum output power status, the declared output power class for different.

The results shown in this test report refer only to the sample(s) tested unless otherwise stated and the sample(s) are retained for 30 days only. The document is issued by AGC, this document cannot be reproduced except in full with our prior written permission. The more details and the authenticity of the report will be confirmed at <http://www.agc-cert.com>.

3.4 CONFIGURATION OF EUT SYSTEM

Fig. 2-1 Configuration of EUT System



Table 2-1 Equipment Used in EUT System

Item	Equipment	Model No.	ID or Specification	Remark
1	Handheld Fingerprint Terminal	TPS360	2AJ2B-TPS360	EUT
2	Adapter	SC/10WA050200US	DC 5.0V 2A	Accessory
3	Battery	HDT-7100	DC3.8V/ 3000mAh	Accessory
4	USB	N/A	N/A	Accessory

***Note: All the accessories have been used during the test. The following “EUT” in setup diagram means EUT system.

4. SUMMARY OF TEST RESULTS

Item Number	Item Description		FCC Rules	Result
1	Output Power	Conducted Output Power	2.1046/22.913(a)(2)/24.232(c)/ 27.50(d)(4)/ 27.50(h)(2)	Pass
		Radiated Output Power		
2	Peak-to-Average Ratio	Peak-to-Average Ratio	24.232(d)	Pass
3	Spurious Emission	Conducted Spurious Emission	2.1051/22.917(a)/24.238(a) 27.53(h)/ 27.53(g)	Pass
		Radiated Spurious Emission		
4	Frequency Stability		2.1055/22.355/24.235/27.54	Pass
5	Occupied Bandwidth		2.1049 (h)(i)	Pass
6	Band Edge		2.1051/22.917(a)/24.238(a) 27.53(h)/ 27.53(g)	Pass

The results shown in this test report refer only to the sample(s) tested unless otherwise stated and the sample(s) are retained for 30 days only. The document is issued by AGC, this document cannot be reproduced except in full with our prior written permission. The more details and the authenticity of the report will be confirmed at <http://www.agc-cert.com>.

5. DESCRIPTION OF TEST MODES

During the testing, the EUT was controlled via Rhode & Schwarz Digital Radio Communication Tester (CMW 500) to ensure max power transmission and proper modulation. Three channels (The top channel, the middle channel and the bottom channel) were chosen for testing on both LTE frequency band.

The worst condition was recorded in the test report if no other modes test data.

Test Mode	Test Modes Description
LTE	LTE system, QPSK modulation
LTE	LTE system, 16QAM modulation

Test Mode	TX / RX	RF Channel		
		Low (B)	Middle (M)	High (T)
LTE Band 2	TX (1.4M)	Channel 18607	Channel 18900	Channel 19193
		1850.7 MHz	1880 MHz	1909.3 MHz
	TX (3M)	Channel 18615	Channel 18900	Channel 19185
		1851.5 MHz	1880 MHz	1908.5 MHz
	TX (5M)	Channel 18625	Channel 18900	Channel 19175
		1852.5 MHz	1880 MHz	1907.5 MHz
	TX (10M)	Channel 18650	Channel 18900	Channel 19150
		1855.0 MHz	1880 MHz	1905.0 MHz
	TX (15M)	Channel 18675	Channel 18900	Channel 19125
		1857.5 MHz	1880 MHz	1902.5 MHz
	TX (20M)	Channel 18700	Channel 18900	Channel 19100
		1860.0 MHz	1880 MHz	1900.0MHz
	RX (1.4M)	Channel 607	Channel 900	Channel 1193
		1930.7 MHz	1960 MHz	1989.3 MHz
	RX (3M)	Channel 615	Channel 900	Channel 1185
		1931.5 MHz	1960 MHz	1988.5 MHz
	RX (5M)	Channel 625	Channel 900	Channel 1175
		1932.5 MHz	1960 MHz	1987.5 MHz
	RX (10M)	Channel 650	Channel 900	Channel 1150
		1935 MHz	1960 MHz	1985 MHz
RX (15M)	Channel 675	Channel 900	Channel 1125	
	1937.5 MHz	1960 MHz	1982.5 MHz	
RX (20M)	Channel 700	Channel 900	Channel 1100	
	1940.0 MHz	1960.0 MHz	1980.0 MHz	

The results shown in this test report refer only to the sample(s) tested unless otherwise stated and the sample(s) are retained for 30 days only. The document is issued by AGC, this document cannot be reproduced except in full with our prior written permission. The more details and the authenticity of the report will be confirmed at <http://www.agc-cert.com>.

Test Mode	TX / RX	RF Channel		
		Low (B)	Middle (M)	High (T)
LTE Band 4	TX (1.4M)	Channel 19957	Channel 20175	Channel 20393
		1710.7 MHz	1732.5 MHz	1754.3 MHz
	TX (3M)	Channel 19965	Channel 20175	Channel 20385
		1711.5 MHz	1732.5 MHz	1753.5 MHz
	TX (5M)	Channel 19975	Channel 20175	Channel 20375
		1712.5 MHz	1732.5 MHz	1752.5 MHz
	TX (10M)	Channel 20000	Channel 20175	Channel 20350
		1715 MHz	1732.5 MHz	1750 MHz
	TX (15M)	Channel 20025	Channel 20175	Channel 20325
		1717.5 MHz	1732.5 MHz	1747.5 MHz
	TX (20M)	Channel 20050	Channel 20175	Channel 20300
		1720 MHz	1732.5 MHz	1745 MHz
	RX (1.4M)	Channel 1957	Channel 2175	Channel 2393
		2110.7 MHz	2132.5 MHz	2154.3 MHz
	RX (3M)	Channel 1965	Channel 2175	Channel 2385
		2111.5 MHz	2132.5 MHz	2153.5 MHz
	RX (5M)	Channel 1975	Channel 2175	Channel 2375
		2112.5 MHz	2132.5 MHz	2152.5 MHz
	RX (10M)	Channel 2000	Channel 2175	Channel 2350
		2115 MHz	2132.5 MHz	2150 MHz
RX (15M)	Channel 2025	Channel 2175	Channel 2325	
	2117.5 MHz	2132.5 MHz	2147.5 MHz	
RX (20M)	Channel 2050	Channel 2175	Channel 2300	
	2120 MHz	2132.5 MHz	2145 MHz	

The results shown in this test report refer only to the sample(s) tested unless otherwise stated and the sample(s) are retained for 30 days only. The document is issued by AGC, this document cannot be reproduced except in full with our prior written permission. The more details and the authenticity of the report will be confirmed at <http://www.agc-cert.com>.

Test Mode	TX / RX	RF Channel		
		Low (B)	Middle (M)	High (T)
LTE Band 5	TX (1.4M)	Channel 20407	Channel 20525	Channel 20643
		824.7 MHz	836.5 MHz	848.3 MHz
	TX (3M)	Channel 20415	Channel 20525	Channel 20635
		825.5 MHz	836.5 MHz	847.5 MHz
	TX (5M)	Channel 20425	Channel 20525	Channel 20625
		826.5 MHz	836.5 MHz	846.5 MHz
	TX (10M)	Channel 20450	Channel 20525	Channel 20600
		829 MHz	836.5 MHz	844 MHz
	RX (1.4M)	Channel 2404	Channel 2525	Channel 2463
		869.4 MHz	881.5 MHz	893.3 MHz
	RX (3M)	Channel 2415	Channel 2525	Channel 2635
		870.5 MHz	881.5 MHz	892.5 MHz
	RX (5M)	Channel 2425	Channel 2525	Channel 2625
		871.5 MHz	881.5 MHz	891.5 MHz
	RX (10M)	Channel 2450	Channel 2525	Channel 2600
		874 MHz	881.5 MHz	889 MHz

The results shown in this test report refer only to the sample(s) tested unless otherwise stated and the sample(s) are retained for 30 days only. The document is issued by AGC, this document cannot be reproduced except in full with our prior written permission. The more details and the authenticity of the report will be confirmed at <http://www.agc-cert.com>.

Test Mode	TX / RX	RF Channel		
		Low (B)	Middle (M)	High (T)
LTE Band 7	TX (5M)	Channel 20775	Channel 21100	Channel 21425
		2502.5 MHz	2535 MHz	2567.5 MHz
	TX (10M)	Channel 20800	Channel 21100	Channel 21400
		2505 MHz	2535 MHz	2565 MHz
	TX (15M)	Channel 20825	Channel 21100	Channel 21375
		2507.5 MHz	2535 MHz	2562.5 MHz
	TX (20M)	Channel 20850	Channel 21100	Channel 21350
		2510 MHz	2535 MHz	2560 MHz
	RX (5M)	Channel 2775	Channel 3100	Channel 3425
		2622.5 MHz	2655 MHz	2687.5 MHz
	RX (10M)	Channel 2800	Channel 3100	Channel 3400
		2625 MHz	2655 MHz	2685 MHz
	RX (15M)	Channel 2825	Channel 3100	Channel 3375
		2627.5 MHz	2655 MHz	2682.5 MHz
	RX (20M)	Channel 2850	Channel 3100	Channel 3350
		2630 MHz	2655 MHz	2680 MHz

The results shown in this test report refer only to the sample(s) tested unless otherwise stated and the sample(s) are retained for 30 days only. The document is issued by AGC, this document cannot be reproduced except in full with our prior written permission. The more details and the authenticity of the report will be confirmed at <http://www.agc-cert.com>.

Test Mode	TX / RX	RF Channel		
		Low (B)	Middle (M)	High (T)
LTE Band 25	TX (1.4M)	Channel 26047	Channel 26365	Channel 26683
		1850.7MHz	1882.5 MHz	1914.3 MHz
	TX (3M)	Channel 26055	Channel 26365	Channel 26675
		1851.5 MHz	1882.5 MHz	1913.5 MHz
	TX (5M)	Channel 26065	Channel 26365	Channel 26665
		1852.5 MHz	1882.5 MHz	1912.5 MHz
	TX (10M)	Channel 26090	Channel 26365	Channel 26640
		1855.0 MHz	1882.5 MHz	1910.0MHz
	TX (15M)	Channel 26115	Channel 26365	Channel 26615
		1857.5 MHz	1882.5 MHz	1907.5 MHz
	TX (20M)	Channel 26140	Channel 26365	Channel 26590
		1860.0 MHz	1882.5 MHz	1905.0 MHz
	RX (1.4M)	Channel 8047	Channel 8365	Channel 8683
		1930.7 MHz	1962.5 MHz	1994.3 MHz
	RX (3M)	Channel 8055	Channel 8365	Channel 8675
		1931.5 MHz	1962.5 MHz	1993.5 MHz
	RX (5M)	Channel 8065	Channel 8365	Channel 8665
		1932.5 MHz	1962.5 MHz	1992.5 MHz
	RX (10M)	Channel 8090	Channel 8365	Channel 8640
		1935.0 MHz	1962.5 MHz	1990.0 MHz
RX (15M)	Channel 8115	Channel 8365	Channel 8615	
	1937.5 MHz	1962.5 MHz	1987.5 MHz	
RX (20M)	Channel 8140	Channel 8365	Channel 8590	
	1940.0 MHz	1962.5 MHz	1985.0 MHz	

The results shown in this test report refer only to the sample(s) tested unless otherwise stated and the sample(s) are retained for 30 days only. The document is issued by AGC, this document cannot be reproduced except in full with our prior written permission. The more details and the authenticity of the report will be confirmed at <http://www.agc-cert.com>.

6. OUTPUT POWER

6.1 CONDUCTED OUTPUT POWER

6.1.1 MEASUREMENT METHOD

The EUT is coupled to the SS with attenuator through power splitter; the RF load attached to EUT antenna terminal is 50ohm, the path loss as the factor is calibrated to correct the reading. A system simulator was used to establish communication with the EUT , Its parameters were set to force the EUT transmitting at maximum output power. The measured power in the radio frequency on the transmitter output terminals shall be reported. The measurements were performed on all modes at 3 typical channels (the Top Channel, the Middle Channel and the Bottom Channel) for each band.

6.1.2 MEASUREMENT RESULT

Conducted Output Power Limits		
Mode	Average Power	Tolerance(dB)
LTE	23 dBm (0.2W)	± 2.7

The results shown in this test report refer only to the sample(s) tested unless otherwise stated and the sample(s) are retained for 30 days only. The document is issued by AGC, this document cannot be reproduced except in full with our prior written permission. The more details and the authenticity of the report will be confirmed at <http://www.agc-cert.com>.

LTE Band 2

BW (MHz)	Ch	Freq. (MHz)	Mode	UL RB Allocation	UL RB Offset	MPR	Average power (dBm)
20MHz	18700	1860.0	QPSK	1	0	0	21.86
				1	49	0	22.82
				1	99	0	21.99
				50	0	1	21.00
				50	25	1	20.99
				50	49	1	21.03
			16QAM	100	0	1	20.82
				1	0	1	21.10
				1	49	1	21.13
				1	99	1	21.09
				50	0	2	20.01
				50	25	2	20.05
	18900	1880.0	QPSK	50	49	2	20.00
				100	0	2	19.84
				1	0	0	23.18
				1	49	0	23.22
				1	99	0	23.23
				50	0	1	22.14
			16QAM	50	25	1	22.22
				50	49	1	22.15
				100	0	1	22.41
				1	0	1	22.02
				1	49	1	23.15
				1	99	1	23.30
	19100	1900.0	QPSK	50	0	2	21.13
				50	25	2	21.22
				50	49	2	21.19
				100	0	2	21.44
				1	0	0	23.04
				1	49	0	21.99
16QAM			1	99	0	23.14	
			50	0	1	21.13	
			50	25	1	21.15	
			50	49	1	21.20	
			100	0	1	21.39	
			1	0	1	21.96	
			1	49	1	21.03	
			1	99	1	21.58	
			50	0	2	20.09	
			50	25	2	20.17	
			50	49	2	20.35	
			100	0	2	20.36	

The results shown in this test report refer only to the sample(s) tested unless otherwise stated and the sample(s) are retained for 30 days only. The document is issued by AGC, this document cannot be reproduced except in full with our prior written permission. The more details and the authenticity of the report will be confirmed at <http://www.agc-cert.com>.

BW (MHz)	Ch	Freq. (MHz)	Mode	UL RB Allocation	UL RB Offset	MPR	Average power (dBm)
15MHz	18675	1857.5	QPSK	1	0	0	21.62
				1	37	0	21.84
				1	74	0	22.07
				36	0	1	20.88
				36	16	1	20.43
				36	35	1	20.46
			16QAM	75	0	1	20.75
				1	0	1	20.90
				1	37	1	20.59
				1	74	1	21.70
				36	0	2	19.89
				36	16	2	20.03
	18900	1880.0	QPSK	36	35	2	19.91
				75	0	2	19.79
				1	0	0	23.12
				1	37	0	23.46
				1	74	0	23.75
				36	0	1	22.15
			16QAM	36	16	1	22.09
				36	35	1	22.31
				75	0	1	22.58
				1	0	1	22.99
				1	37	1	23.11
				1	74	1	23.07
	19125	1902.5	QPSK	36	0	2	21.09
				36	16	2	21.36
				36	35	2	21.44
				75	0	2	21.63
				1	0	0	22.70
				1	37	0	22.69
			16QAM	1	74	0	21.73
				36	0	1	21.15
				36	16	1	21.00
				36	35	1	21.16
				75	0	1	21.40
				1	0	1	22.33
16QAM	1	37	1	21.69			
	1	74	1	21.44			
	36	0	2	20.17			
	36	16	2	20.15			
	36	35	2	20.23			
	75	0	2	20.50			

The results shown in this test report refer only to the sample(s) tested unless otherwise stated and the sample(s) are retained for 30 days only. The document is issued by AGC, this document cannot be reproduced except in full with our prior written permission. The more details and the authenticity of the report will be confirmed at <http://www.agc-cert.com>.

BW (MHz)	Ch	Freq. (MHz)	Mode	UL RB Allocation	UL RB Offset	MPR	Average power (dBm)
10MHz	18650	1855.0	QPSK	1	0	0	21.52
				1	24	0	21.58
				1	49	0	21.92
				25	0	1	20.69
				25	12	1	20.74
				25	25	1	20.82
			16QAM	50	0	1	20.67
				1	0	1	20.91
				1	24	1	21.16
				1	49	1	21.34
				25	0	2	19.46
				25	12	2	19.59
				25	25	2	19.76
				50	0	2	19.71
	18900	1880.0	QPSK	1	0	0	23.85
				1	24	0	23.49
				1	49	0	23.25
				25	0	1	22.46
				25	12	1	22.19
				25	25	1	22.38
			16QAM	50	0	1	22.46
				1	0	1	23.22
				1	24	1	23.11
				1	49	1	23.03
				25	0	2	21.40
				25	12	2	21.39
				25	25	2	21.42
				50	0	2	21.48
	19150	1905.0	QPSK	1	0	0	22.51
				1	24	0	21.99
1				49	0	21.77	
25				0	1	19.35	
25				12	1	19.49	
25				25	1	19.76	
16QAM			50	0	1	19.71	
			1	0	1	22.14	
			1	24	1	21.98	
			1	49	1	21.52	
			25	0	2	20.06	
			25	12	2	20.10	
			25	25	2	20.12	
			50	0	2	20.34	

The results shown in this test report refer only to the sample(s) tested unless otherwise stated and the sample(s) are retained for 30 days only. The document is issued by AGC, this document cannot be reproduced except in full with our prior written permission. The more details and the authenticity of the report will be confirmed at <http://www.agc-cert.com>.

BW (MHz)	Ch	Freq. (MHz)	Mode	UL RB Allocation	UL RB Offset	MPR	Average power (dBm)		
5MHz	18625	1852.5	QPSK	1	0	0	21.46		
				1	12	0	21.29		
				1	24	0	21.63		
				12	0	1	20.49		
				12	6	1	20.50		
				12	11	1	20.57		
			25	0	1	20.44			
			16QAM	1	0	1	20.84		
				1	12	1	21.11		
				1	24	1	21.27		
				12	0	2	19.44		
				12	6	2	19.46		
				12	11	2	19.73		
				25	0	2	19.80		
	18900	QPSK		1880.0	1	0	0	23.61	
			1		12	0	23.53		
			1		24	0	23.23		
			12		0	1	22.26		
			12		6	1	22.38		
			12		11	1	22.49		
			25		0	1	22.52		
			16QAM		1	0	1	23.21	
					1	12	1	23.11	
		1		24	1	23.01			
		12		0	2	22.87			
		12		6	2	22.99			
		12		11	2	21.72			
		25		0	2	21.59			
		19175		QPSK	1907.5	1	0	0	22.21
						1	12	0	22.19
			1			24	0	21.80	
			12			0	1	20.74	
	12		6			1	20.79		
	12		11			1	20.98		
	25		0			1	21.20		
	16QAM		1	0	1	21.36			
1			12	1	20.55				
1			24	1	20.29				
12			0	2	20.00				
12			6	2	20.05				
12			11	2	20.07				
25			0	2	20.35				

The results shown in this test report refer only to the sample(s) tested otherwise stated and the sample(s) are retained for 30 days only. The document is issued by AGC, this document cannot be reproduced except in full with our prior written permission. The more details and the authenticity of the report will be confirmed at <http://www.agc-cert.com>.

BW (MHz)	Ch	Freq. (MHz)	Mode	UL RB Allocation	UL RB Offset	MPR	Average power (dBm)		
3MHz	18615	1851.5	QPSK	1	0	0	21.55		
				1	7	0	21.42		
				1	14	0	21.68		
				8	0	1	20.11		
				8	4	1	20.33		
				8	7	1	20.57		
			15	0	1	20.43			
			16QAM	1	0	1	20.75		
				1	7	1	20.89		
				1	14	1	21.26		
				8	0	2	19.44		
				8	4	2	19.36		
				8	7	2	19.54		
			18900	1880.0	QPSK	1	0	0	23.73
						1	7	0	23.46
	1	14				0	23.54		
	8	0				1	22.40		
	8	4				1	22.34		
	8	7				1	22.59		
	15	0			1	22.68			
	16QAM	1			0	1	23.11		
		1			7	1	23.03		
		1			14	1	22.94		
		8			0	2	21.48		
		8			4	2	21.39		
		8			7	2	21.58		
	19185	1908.5			QPSK	1	0	0	22.37
						1	7	0	22.09
			1	14		0	21.75		
			8	0		1	20.11		
8			4	1		20.52			
8			7	1		20.87			
15			0	1	20.83				
16QAM			1	0	1	21.79			
			1	7	1	21.45			
			1	14	1	21.32			
			8	0	2	19.52			
			8	4	2	19.27			
			8	7	2	19.85			
15			0	2	19.88				

The results shown in this test report refer only to the sample(s) tested unless otherwise stated and the sample(s) are retained for 30 days only. The document is issued by AGC, this document cannot be reproduced except in full with our prior written permission. The more details and the authenticity of the report will be confirmed at <http://www.agc-cert.com>.

BW (MHz)	Ch	Freq. (MHz)	Mode	UL RB Allocation	UL RB Offset	MPR	Average power (dBm)
1.4MHz	18607	1850.7	QPSK	1	0	0	21.29
				1	3	0	21.23
				1	5	0	21.45
				3	0	0	21.37
				3	2	0	21.28
				3	3	0	21.39
			16QAM	6	0	1	20.43
				1	0	1	21.54
				1	2	1	21.49
				1	5	1	21.58
				3	0	1	20.22
				3	1	1	20.09
				3	2	1	20.50
				6	0	2	19.45
	18900	1880.0	QPSK	1	0	0	23.63
				1	2	0	23.46
				1	5	0	23.52
				3	0	0	23.15
				3	1	0	23.54
				3	2	0	23.60
			16QAM	6	0	1	22.76
				1	0	1	23.14
				1	2	1	23.09
				1	5	1	23.27
				3	0	1	22.39
				3	1	1	22.45
				3	2	1	22.62
				6	0	2	21.70
	19193	1909.3	QPSK	1	0	0	21.81
				1	2	0	21.77
1				5	0	21.84	
3				0	0	21.52	
3				1	0	21.60	
3				2	0	21.76	
16QAM			6	0	1	20.94	
			1	0	1	21.29	
			1	2	1	21.06	
			1	5	1	21.22	
			3	0	1	20.55	
			3	1	1	20.59	
			3	2	1	20.85	
			6	0	2	20.01	

The results shown in this test report refer only to the sample(s) tested unless otherwise stated and the sample(s) are retained for 30 days only. The document is issued by AGC, this document cannot be reproduced except in full with our prior written permission. The more details and the authenticity of the report will be confirmed at <http://www.agc-cert.com>.

LTE Band 4

BW (MHz)	Ch	Freq. (MHz)	Mode	UL RB Allocation	UL RB Offset	MPR	Average power (dBm)
20MHz	20050	1720.0	QPSK	1	0	0	23.46
				1	49	0	23.11
				1	99	0	22.58
				50	0	1	21.45
				50	25	1	21.50
				50	49	1	21.75
				100	0	1	21.98
			16QAM	1	0	1	22.33
				1	49	1	22.16
				1	99	1	21.36
				50	0	2	20.52
				50	25	2	20.49
				50	49	2	20.69
				100	0	2	21.04
	20175	1732.5	QPSK	1	0	0	22.76
				1	49	0	23.20
				1	99	0	23.30
				50	0	1	21.73
				50	25	1	21.58
				50	49	1	21.76
				100	0	1	21.79
			16QAM	1	0	1	21.48
				1	49	1	21.53
				1	99	1	21.80
				50	0	2	21.44
				50	25	2	21.74
				50	49	2	20.84
				100	0	2	20.99
	20300	1745.0	QPSK	1	0	0	23.02
				1	49	0	22.94
1				99	0	22.66	
50				0	1	21.06	
50				25	1	21.34	
50				49	1	21.38	
100				0	1	21.57	
16QAM			1	0	1	22.31	
			1	49	1	21.94	
			1	99	1	21.91	
			50	0	2	20.36	
			50	25	2	20.12	
			50	49	2	20.44	
			100	0	2	20.65	

The results shown in this test report refer only to the sample(s) tested unless otherwise stated and the sample(s) are retained for 30 days only. The document is issued by AGC, this document cannot be reproduced except in full with our prior written permission. The more details and the authenticity of the report will be confirmed at <http://www.agc-cert.com>.

BW (MHz)	Ch	Freq. (MHz)	Mode	UL RB Allocation	UL RB Offset	MPR	Average power (dBm)
15MHz	20025	1717.5	QPSK	1	0	0	23.51
				1	37	0	23.42
				1	74	0	22.43
				36	0	1	22.29
				36	16	1	22.19
				36	35	1	21.70
			16QAM	75	0	1	21.95
				1	0	1	23.48
				1	37	1	23.09
				1	74	1	21.83
				36	0	2	20.44
				36	16	2	20.39
	20175	1732.5	QPSK	36	35	2	20.72
				75	0	2	21.01
				1	0	0	22.94
				1	37	0	23.07
				1	74	0	23.21
				36	0	1	21.49
			16QAM	36	16	1	21.22
				36	35	1	21.81
				75	0	1	21.84
				1	0	1	22.08
				1	37	1	21.97
				1	74	1	22.86
	20325	1747.5	QPSK	36	0	2	20.48
				36	16	2	20.66
				36	35	2	20.88
				75	0	2	20.80
				1	0	0	22.96
				1	37	0	22.85
			16QAM	1	74	0	22.39
				36	0	1	21.44
				36	16	1	21.39
				36	35	1	21.40
				75	0	1	21.62
				1	0	1	22.66
16QAM	1	37	1	22.44			
	1	74	1	22.08			
	36	0	2	20.49			
	36	16	2	20.77			
	36	35	2	20.53			
	75	0	2	20.68			

The results shown in this test report refer only to the sample(s) tested unless otherwise stated and the sample(s) are retained for 30 days only. The document is issued by AGC, this document cannot be reproduced except in full with our prior written permission. The more details and the authenticity of the report will be confirmed at <http://www.agc-cert.com>.

BW (MHz)	Ch	Freq. (MHz)	Mode	UL RB Allocation	UL RB Offset	MPR	Average power (dBm)
10MHz	20000	1715.0	QPSK	1	0	0	23.49
				1	24	0	23.74
				1	49	0	22.66
				25	0	1	21.55
				25	12	1	21.49
				25	25	1	21.98
			16QAM	50	0	1	22.14
				1	0	1	23.03
				1	24	1	23.01
				1	49	1	22.42
				25	0	2	21.00
				25	12	2	20.85
				25	25	2	20.96
				50	0	2	21.17
	20175	1732.5	QPSK	1	0	0	23.01
				1	24	0	22.99
				1	49	0	23.25
				25	0	1	21.48
				25	12	1	21.77
				25	25	1	21.91
			16QAM	50	0	1	22.02
				1	0	1	22.12
				1	24	1	22.47
				1	49	1	22.89
				25	0	2	20.96
				25	12	2	20.84
				25	25	2	21.12
				50	0	2	21.06
	20350	1750.0	QPSK	1	0	0	22.69
				1	24	0	22.57
1				49	0	22.18	
25				0	1	21.33	
25				12	1	21.45	
25				25	1	21.46	
16QAM			50	0	1	21.42	
			1	0	1	22.39	
			1	24	1	22.81	
			1	49	1	22.03	
			25	0	2	20.52	
			25	12	2	20.44	
			25	25	2	20.56	
			50	0	2	20.49	

The results shown in this test report refer only to the sample(s) tested unless otherwise stated and the sample(s) are retained for 30 days only. The document is issued by AGC, this document cannot be reproduced except in full with our prior written permission. The more details and the authenticity of the report will be confirmed at <http://www.agc-cert.com>.

BW (MHz)	Ch	Freq. (MHz)	Mode	UL RB Allocation	UL RB Offset	MPR	Average power (dBm)
5MHz	19975	1712.5	QPSK	1	0	0	23.37
				1	12	0	23.41
				1	24	0	23.07
				12	0	1	21.59
				12	6	1	22.15
				12	11	1	22.25
			16QAM	25	0	1	22.27
				1	0	1	22.95
				1	12	1	22.84
				1	24	1	22.76
				12	0	2	21.44
				12	6	2	21.27
				12	11	2	21.37
				25	0	2	21.35
				20175	1732.5	QPSK	1
	1	12	0				22.58
	1	24	0				22.93
	12	0	1				21.58
	12	6	1				21.87
	12	11	1				21.94
	16QAM	25	0			1	21.92
		1	0			1	22.32
		1	12			1	22.41
		1	24			1	22.52
		12	0			2	21.12
		12	6			2	21.17
		12	11			2	21.08
		25	0			2	21.06
		20375	1752.5			QPSK	1
	1			12	0		22.03
1	24			0	22.63		
12	0			1	21.54		
12	6			1	21.39		
12	11			1	21.37		
16QAM	25			0	1	21.44	
	1			0	1	21.52	
	1			12	1	21.30	
	1			24	1	21.55	
	12			0	2	20.44	
	12			6	2	20.49	
	12			11	2	20.52	
	25			0	2	20.56	

The results shown in this test report refer only to the sample(s) tested unless otherwise stated and the sample(s) are retained for 30 days only. The document is issued by AGC, this document cannot be reproduced except in full with our prior written permission. The more details and the authenticity of the report will be confirmed at <http://www.agc-cert.com>.

BW (MHz)	Ch	Freq. (MHz)	Mode	UL RB Allocation	UL RB Offset	MPR	Average power (dBm)
3MHz	19965	1711.5	QPSK	1	0	0	23.54
				1	7	0	23.15
				1	14	0	23.31
				8	0	1	23.09
				8	4	1	23.15
				8	7	1	22.22
			15	0	1	22.28	
			16QAM	1	0	1	22.61
				1	7	1	22.54
				1	14	1	22.49
				8	0	2	21.17
				8	4	2	22.27
				8	7	2	21.35
			15	0	2	21.33	
			20175	1732.5	QPSK	1	0
	1	7				0	23.12
	1	14				0	23.02
	8	0				1	22.98
	8	4				1	22.54
	8	7				1	21.91
	15	0			1	21.92	
	16QAM	1			0	1	22.25
		1			7	1	22.19
		1			14	1	22.30
		8			0	2	20.85
		8			4	2	21.03
		8			7	2	21.06
	15	0			2	20.99	
	20385	1753.5			QPSK	1	0
			1	7		0	22.18
1			14	0		22.71	
8			0	1		22.63	
8			4	1		21.37	
8			7	1		21.56	
15			0	1	21.36		
16QAM			1	0	1	22.00	
			1	7	1	22.25	
			1	14	1	22.19	
			8	0	2	20.49	
			8	4	2	20.57	
			8	7	2	20.59	
15			0	2	20.50		

The results shown in this test report refer only to the sample(s) tested unless otherwise stated and the sample(s) are retained for 30 days only. The document is issued by AGC, this document cannot be reproduced except in full with our prior written permission. The more details and the authenticity of the report will be confirmed at <http://www.agc-cert.com>.

BW (MHz)	Ch	Freq. (MHz)	Mode	UL RB Allocation	UL RB Offset	MPR	Average power (dBm)
1.4MHz	19957	1710.7	QPSK	1	0	0	23.47
				1	2	0	23.54
				1	5	0	23.33
				3	0	0	23.11
				3	1	0	23.09
				3	2	0	23.31
			16QAM	1	0	1	23.17
				1	2	1	23.08
				1	5	1	23.17
				3	0	1	22.44
				3	1	1	22.28
				3	2	1	22.35
	20175	1732.5	QPSK	6	0	2	21.27
				1	0	0	23.11
				1	2	0	23.06
				1	5	0	23.00
				3	0	0	22.48
				3	1	0	22.65
			16QAM	3	2	0	22.94
				6	0	1	21.93
				1	0	1	22.78
				1	2	1	22.54
				1	5	1	22.82
				3	0	1	22.25
	20393	1754.3	QPSK	3	1	1	22.19
				3	2	1	22.63
				6	0	2	21.48
				1	0	0	22.51
				1	2	0	22.46
				1	5	0	22.86
			16QAM	3	0	0	22.03
				3	1	0	21.95
				3	2	0	22.04
				6	0	1	21.03
				1	0	1	22.16
				1	2	1	22.35
				1	5	1	22.75
				3	0	1	21.48
				3	1	1	21.64
				3	2	1	21.86
				6	0	2	20.56

The results shown in this test report refer only to the sample(s) tested unless otherwise stated and the sample(s) are retained for 30 days only. The document is issued by AGC, this document cannot be reproduced except in full with our prior written permission. The more details and the authenticity of the report will be confirmed at <http://www.agc-cert.com>.

LTE Band 5

BW (MHz)	Ch	Freq. (MHz)	Mode	UL RB Allocation	UL RB Offset	MPR	Average power (dBm)
10MHz	20450	829	QPSK	1	0	0	23.35
				1	24	0	23.25
				1	49	0	23.20
				25	0	1	23.00
				25	12	1	23.18
				25	25	1	23.12
			16QAM	50	0	1	22.26
				1	0	1	23.24
				1	24	1	22.84
				1	49	1	22.99
				25	0	2	22.48
				25	12	2	22.53
				25	25	2	22.50
				50	0	2	21.33
	20525	836.5	QPSK	1	0	0	23.17
				1	24	0	23.10
				1	49	0	23.14
				25	0	1	23.00
				25	12	1	23.13
				25	25	1	23.07
			16QAM	50	0	1	23.28
				1	0	1	23.71
				1	24	1	23.58
				1	49	1	23.83
				25	0	2	23.11
				25	12	2	23.31
				25	25	2	23.26
20600	844	QPSK	50	0	2	22.20	
			1	0	0	23.98	
			1	24	0	23.77	
			1	49	0	23.74	
			25	0	1	23.98	
			25	12	1	23.87	
		16QAM	25	25	1	24.06	
			50	0	1	23.08	
			1	0	1	23.74	
			1	24	1	23.16	
			1	49	1	23.23	
			25	0	2	23.04	
			25	12	2	23.00	
			25	25	2	23.07	
50	0	2	22.24				

The results shown in this test report refer only to the sample(s) tested unless otherwise stated and the sample(s) are retained for 30 days only. The document is issued by AGC, this document cannot be reproduced except in full with our prior written permission. The more details and the authenticity of the report will be confirmed at <http://www.agc-cert.com>.

BW (MHz)	Ch	Freq. (MHz)	Mode	UL RB Allocation	UL RB Offset	MPR	Average power (dBm)
5MHz	20425	826.5	QPSK	1	0	0	23.25
				1	12	0	23.01
				1	24	0	23.21
				12	0	1	22.52
				12	6	1	22.49
				12	11	1	22.28
			16QAM	25	0	1	22.24
				1	0	1	22.68
				1	12	1	22.03
				1	24	1	22.77
				12	0	2	22.27
				12	6	2	21.94
	20525	836.5	QPSK	12	11	2	21.33
				25	0	2	21.11
				1	0	0	22.13
				1	12	0	22.11
				1	24	0	22.78
				12	0	1	23.11
			16QAM	12	6	1	23.10
				12	11	1	23.27
				25	0	1	23.20
				1	0	1	23.05
				1	12	1	22.98
				1	24	1	22.60
20625	846.5	QPSK	12	0	2	22.58	
			12	6	2	22.47	
			12	11	2	22.48	
			25	0	2	22.18	
			1	0	0	22.32	
			1	12	0	22.18	
		16QAM	1	24	0	22.64	
			12	0	1	22.84	
			12	6	1	22.69	
			12	11	1	23.01	
			25	0	1	23.13	
			1	0	1	23.09	
			QPSK	1	12	1	22.49
				1	24	1	22.42
				12	0	2	22.52
				12	6	2	22.34
			16QAM	12	11	2	22.16
				25	0	2	22.32

The results shown in this test report refer only to the sample(s) tested unless otherwise stated and the sample(s) are retained for 30 days only. The document is issued by AGC, this document cannot be reproduced except in full with our prior written permission. The more details and the authenticity of the report will be confirmed at <http://www.agc-cert.com>.

BW (MHz)	Ch	Freq. (MHz)	Mode	UL RB Allocation	UL RB Offset	MPR	Average power (dBm)		
3MHz	20415	825.5	QPSK	1	0	0	23.44		
				1	7	0	22.69		
				1	14	0	23.30		
				8	0	1	22.02		
				8	4	1	22.00		
				8	7	1	22.22		
			15	0	1	22.26			
			16QAM	1	0	1	22.62		
				1	7	1	22.43		
				1	14	1	22.46		
				8	0	2	22.15		
				8	4	2	21.54		
				8	7	2	21.39		
			20525	836.5	QPSK	15	0	2	21.32
						1	0	0	22.22
	1	7				0	21.98		
	1	14				0	21.96		
	8	0				1	22.36		
	8	4				1	22.18		
	16QAM	8			7	1	22.20		
		15			0	1	21.26		
		1			0	1	21.80		
		1			7	1	21.16		
		1			14	1	22.50		
		8			0	2	22.52		
	20635	847.5			QPSK	8	4	2	22.46
						8	7	2	22.37
						15	0	2	22.22
			1	0		0	24.23		
			1	7		0	23.12		
1			14	0		23.61			
16QAM			8	0	1	23.00			
			8	4	1	23.01			
			8	7	1	23.09			
			15	0	1	23.10			
			1	0	1	24.08			
			1	7	1	23.56			
16QAM			1	14	1	23.40			
			8	0	2	22.01			
			8	4	2	22.11			
	8	7	2	22.17					
	15	0	2	22.09					

The results shown in this test report refer only to the sample(s) tested unless otherwise stated and the sample(s) are retained for 30 days only. The document is issued by AGC, this document cannot be reproduced except in full with our prior written permission. The more details and the authenticity of the report will be confirmed at <http://www.agc-cert.com>.

BW (MHz)	Ch	Freq. (MHz)	Mode	UL RB Allocation	UL RB Offset	MPR	Average power (dBm)
1.4MHz	20407	824.7	QPSK	1	0	0	23.35
				1	2	0	23.01
				1	5	0	23.20
				3	0	0	23.00
				3	1	0	23.09
				3	2	0	23.12
			16QAM	1	0	1	22.24
				1	2	1	22.48
				1	5	1	22.99
				3	0	1	22.05
				3	1	1	22.17
				3	2	1	22.50
	20525	836.5	QPSK	6	0	2	21.33
				1	0	0	21.37
				1	2	0	21.55
				1	5	0	22.00
				3	0	0	22.21
				3	1	0	22.07
			16QAM	3	2	0	23.28
				6	0	1	23.15
				1	0	1	23.71
				1	2	1	23.19
				1	5	1	23.83
				3	0	1	23.58
	20643	848.3	QPSK	3	1	1	23.14
				3	2	1	23.26
				6	0	2	22.20
				1	0	0	23.98
				1	2	0	23.85
				1	5	0	23.74
			16QAM	3	0	0	22.36
				3	1	0	22.18
				3	2	0	22.06
				6	0	1	23.08
				1	0	1	23.74
				1	2	1	23.45
				1	5	1	23.23
				3	0	1	23.00
				3	1	1	22.94
				3	2	1	23.07
				6	0	2	22.24

The results shown in this test report refer only to the sample(s) tested unless otherwise stated and the sample(s) are retained for 30 days only. The document is issued by AGC, this document cannot be reproduced except in full with our prior written permission. The more details and the authenticity of the report will be confirmed at <http://www.agc-cert.com>.

LTE Band 7

BW (MHz)	Ch	Freq. (MHz)	Mode	UL RB Allocation	UL RB Offset	MPR	Average power (dBm)
20MHz	20850	2510	QPSK	1	0	0	22.74
				1	49	0	21.23
				1	99	0	21.74
				50	0	1	21.33
				50	25	1	21.42
				50	49	1	22.25
			16QAM	100	0	1	22.11
				1	0	1	22.18
				1	49	1	21.00
				1	99	1	21.10
				50	0	2	22.22
				50	25	2	21.26
	21100	2535	QPSK	50	49	2	22.23
				100	0	2	21.10
				1	0	0	22.95
				1	49	0	22.19
				1	99	0	22.33
				50	0	1	21.45
			16QAM	50	25	1	22.39
				50	49	1	22.20
				100	0	1	21.19
				1	0	1	22.92
				1	49	1	22.89
				1	99	1	22.45
	21350	2560	QPSK	50	0	2	22.11
				50	25	2	22.06
				50	49	2	22.09
				100	0	2	21.96
				1	0	0	22.55
				1	49	0	22.49
16QAM			1	99	0	22.36	
			50	0	1	22.29	
			50	25	1	21.64	
			50	49	1	21.74	
			100	0	1	21.82	
			1	0	1	21.88	
				1	49	1	21.93
				1	99	1	21.73
				50	0	2	22.61
				50	25	2	22.06
				50	49	2	22.27
				100	0	2	21.99

The results shown in this test report refer only to the sample(s) tested otherwise stated and the sample(s) are retained for 30 days only. The document is issued by AGC, this document cannot be reproduced except in full with our prior written permission. The more details and the authenticity of the report will be confirmed at <http://www.agc-cert.com>.

BW (MHz)	Ch	Freq. (MHz)	Mode	UL RB Allocation	UL RB Offset	MPR	Average power (dBm)			
15MHz	20825	2507.5	QPSK	1	0	0	22.34			
				1	37	0	22.22			
				1	74	0	22.16			
				36	0	1	21.99			
				36	16	1	21.84			
				36	35	1	21.64			
				75	0	1	22.06			
			16QAM	1	0	1	22.10			
				1	37	1	22.02			
				1	74	1	21.52			
				36	0	2	21.33			
				36	16	2	21.49			
				36	35	2	22.10			
				75	0	2	22.31			
	21100	2535	QPSK	1	0	0	22.56			
				1	37	0	22.44			
				1	74	0	22.66			
				36	0	1	22.25			
				36	16	1	22.18			
				36	35	1	22.17			
				75	0	1	22.09			
			16QAM	1	0	1	21.88			
				1	37	1	21.74			
				1	74	1	22.03			
				36	0	2	21.88			
				36	16	2	22.01			
				36	35	2	22.33			
				75	0	2	21.66			
				21375	2562.5	QPSK	1	0	0	22.23
							1	37	0	22.28
1	74	0	22.16							
36	0	1	21.33							
36	16	1	21.34							
36	35	1	21.43							
75	0	1	22.25							
16QAM	1	0	1			22.09				
	1	37	1			22.14				
	1	74	1			21.83				
	36	0	2			22.13				
	36	16	2			22.14				
	36	35	2			22.16				
75	0	2	22.25							

The results shown in this test report refer only to the sample(s) tested unless otherwise stated and the sample(s) are retained for 30 days only. The document is issued by AGC, this document cannot be reproduced except in full with our prior written permission. The more details and the authenticity of the report will be confirmed at <http://www.agc-cert.com>.

BW (MHz)	Ch	Freq. (MHz)	Mode	UL RB Allocation	UL RB Offset	MPR	Average power (dBm)
10MHz	20800	2505	QPSK	1	0	0	22.42
				1	24	0	22.37
				1	49	0	22.43
				25	0	1	21.79
				25	12	1	22.03
				25	25	1	21.94
			16QAM	50	0	1	22.03
				1	0	1	22.01
				1	24	1	21.98
				1	49	1	21.45
	21100	2535	QPSK	25	0	2	21.37
				25	12	2	21.44
				25	25	2	22.03
				50	0	2	22.41
				1	0	0	22.25
				1	24	0	22.00
			16QAM	1	49	0	21.46
				25	0	1	22.11
				25	12	1	22.10
				25	25	1	22.34
21400	2565	QPSK	50	0	1	22.16	
			1	0	1	21.77	
			1	24	1	21.86	
			1	49	1	21.69	
			25	0	2	21.13	
			25	12	2	21.52	
		16QAM	25	25	2	21.49	
			50	0	2	21.55	
			1	0	0	21.67	
			1	24	0	21.59	
21400	2565	QPSK	1	49	0	21.58	
			25	0	1	22.20	
			25	12	1	22.64	
			25	25	1	22.49	
			50	0	1	22.51	
			1	0	1	22.13	
		16QAM	1	24	1	22.61	
			1	49	1	22.82	
			25	0	2	22.15	
			25	12	2	22.16	
21400	2565	16QAM	25	25	2	22.23	
			50	0	2	21.58	

The results shown in this test report refer only to the sample(s) tested unless otherwise stated and the sample(s) are retained for 30 days only. The document is issued by AGC, this document cannot be reproduced except in full with our prior written permission. The more details and the authenticity of the report will be confirmed at <http://www.agc-cert.com>.

BW (MHz)	Ch	Freq. (MHz)	Mode	UL RB Allocation	UL RB Offset	MPR	Average power (dBm)
5MHz	20775	2502.5	QPSK	1	0	0	21.76
				1	12	0	21.85
				1	24	0	21.69
				12	0	1	21.78
				12	6	1	21.40
				12	13	1	21.44
			16QAM	25	0	1	22.39
				1	0	1	22.43
				1	12	1	22.28
				1	24	1	22.42
				12	0	2	21.94
				12	6	2	21.69
				12	13	2	22.45
				25	0	2	22.11
				21100	2535	QPSK	1
	1	12	0				21.59
	1	24	0				21.69
	12	0	1				21.58
	12	6	1				22.43
	12	13	1				22.37
	16QAM	25	0			1	22.46
		1	0			1	21.69
		1	12			1	22.52
		1	24			1	21.67
		12	0			2	22.03
		12	6			2	21.56
		12	13			2	21.69
		25	0			2	21.44
		21425	2567.5			QPSK	1
	1			12	0		21.58
1	24			0	22.36		
12	0			1	22.43		
12	6			1	22.38		
12	13			1	21.46		
16QAM	25			0	1	21.69	
	1			0	1	22.11	
	1			12	1	21.96	
	1			24	1	21.58	
	12			0	2	21.44	
	12			6	2	22.36	
	12			13	2	22.49	
	25			0	2	22.44	

The results shown in this test report refer only to the sample(s) tested unless otherwise stated and the sample(s) are retained for 30 days only. The document is issued by AGC, this document cannot be reproduced except in full with our prior written permission. The more details and the authenticity of the report will be confirmed at <http://www.agc-cert.com>.

LTE Band 25

BW (MHz)	Ch	Freq. (MHz)	Mode	UL RB Allocation	UL RB Offset	MPR	Average power (dBm)
20MHz	26140	1860.0	QPSK	1	0	0	22.65
				1	49	0	22.45
				1	99	0	22.64
				50	0	1	20.11
				50	25	1	20.49
				50	49	1	20.57
				100	0	1	20.57
			16QAM	1	0	1	22.31
				1	49	1	22.45
				1	99	1	22.39
				50	0	2	20.41
				50	25	2	20.23
				50	49	2	20.63
				100	0	2	20.50
	26365	1882.5	QPSK	1	0	0	22.94
				1	49	0	22.45
				1	99	0	22.76
				50	0	1	21.65
				50	25	1	21.46
				50	49	1	21.43
				100	0	1	21.54
			16QAM	1	0	1	21.26
				1	49	1	21.06
				1	99	1	21.00
				50	0	2	20.45
				50	25	2	20.37
				50	49	2	20.32
				100	0	2	20.57
	26590	1905.0	QPSK	1	0	0	22.43
				1	49	0	22.25
1				99	0	22.91	
50				0	1	21.49	
50				25	1	21.55	
50				49	1	21.52	
100				0	1	21.59	
16QAM			1	0	1	21.11	
			1	49	1	21.05	
			1	99	1	21.85	
			50	0	2	20.58	
			50	25	2	20.46	
			50	49	2	20.49	
			100	0	2	20.57	

The results shown in this test report refer only to the sample(s) tested unless otherwise stated and the sample(s) are retained for 30 days only. The document is issued by AGC, this document cannot be reproduced except in full with our prior written permission. The more details and the authenticity of the report will be confirmed at <http://www.agc-cert.com>.

BW (MHz)	Ch	Freq. (MHz)	Mode	UL RB Allocation	UL RB Offset	MPR	Average power (dBm)			
15MHz	26115	1857.5	QPSK	1	0	0	22.87			
				1	37	0	22.45			
				1	74	0	22.76			
				36	0	1	20.25			
				36	18	1	20.33			
				36	38	1	20.61			
				75	0	1	20.60			
			16QAM	1	0	1	22.27			
				1	37	1	22.15			
				1	74	1	22.33			
				36	0	2	20.58			
				36	18	2	20.47			
				36	38	2	20.64			
				75	0	2	20.59			
	26365	1882.5	QPSK	1	0	0	23.06			
				1	37	0	22.59			
				1	74	0	22.53			
				36	0	1	21.45			
				36	18	1	21.47			
				36	38	1	21.50			
				75	0	1	21.68			
			16QAM	1	0	1	22.26			
				1	37	1	22.49			
				1	74	1	21.76			
				36	0	2	20.29			
				36	18	2	20.33			
				36	38	2	20.53			
				75	0	2	20.65			
				26615	1907.5	QPSK	1	0	0	22.91
							1	37	0	22.54
1	74	0	22.59							
36	0	1	21.58							
36	18	1	21.73							
36	38	1	21.65							
16QAM	75	0	1			21.51				
	1	0	1			22.56				
	1	37	1			22.51				
				1	74	1	22.41			
				36	0	2	20.55			
				36	18	2	20.49			
				36	38	2	20.46			
				75	0	2	20.58			
				75	0	2	20.58			

The results shown in this test report refer only to the sample(s) tested unless otherwise stated and the sample(s) are retained for 30 days only. The document is issued by AGC, this document cannot be reproduced except in full with our prior written permission. The more details and the authenticity of the report will be confirmed at <http://www.agc-cert.com>.

BW (MHz)	Ch	Freq. (MHz)	Mode	UL RB Allocation	UL RB Offset	MPR	Average power (dBm)
10MHz	26090	1855.0	QPSK	1	0	0	22.56
				1	24	0	22.32
				1	49	0	22.54
				25	0	1	20.42
				25	12	1	20.18
				25	25	1	20.51
				50	0	1	20.73
			16QAM	1	0	1	22.20
				1	24	1	22.08
				1	49	1	22.23
				25	0	2	20.44
				25	12	2	20.18
				25	25	2	20.65
				50	0	2	20.66
	26365	1882.5	QPSK	1	0	0	22.81
				1	24	0	22.36
				1	49	0	22.54
				25	0	1	21.43
				25	12	1	21.34
				25	25	1	21.56
				50	0	1	21.55
			16QAM	1	0	1	22.05
				1	24	1	21.88
				1	49	1	21.85
				25	0	2	20.45
				25	12	2	20.33
				25	25	2	20.49
				50	0	2	20.56
	26640	1910.0	QPSK	1	0	0	22.81
				1	24	0	22.77
1				49	0	22.52	
25				0	1	21.59	
25				12	1	21.66	
25				25	1	21.62	
50				0	1	21.63	
16QAM			1	0	1	22.48	
			1	24	1	22.25	
			1	49	1	22.13	
			25	0	2	20.35	
			25	12	2	20.33	
			25	25	2	20.51	
			50	0	2	20.58	

The results shown in this test report refer only to the sample(s) tested unless otherwise stated and the sample(s) are retained for 30 days only. The document is issued by AGC, this document cannot be reproduced except in full with our prior written permission. The more details and the authenticity of the report will be confirmed at <http://www.agc-cert.com>.

BW (MHz)	Ch	Freq. (MHz)	Mode	UL RB Allocation	UL RB Offset	MPR	Average power (dBm)
5MHz	26065	1852.5	QPSK	1	0	0	22.88
				1	12	0	22.63
				1	24	0	22.81
				12	0	1	20.48
				12	6	1	20.33
				12	13	1	20.57
				25	0	1	20.64
			16QAM	1	0	1	22.02
				1	12	1	22.06
				1	24	1	22.04
				12	0	2	20.19
				12	6	2	20.18
				12	13	2	20.65
				25	0	2	20.75
	26365	1882.5	QPSK	1	0	0	22.59
				1	12	0	22.49
				1	24	0	22.39
				12	0	1	21.33
				12	6	1	21.39
				12	13	1	21.56
				25	0	1	21.61
			16QAM	1	0	1	22.11
				1	12	1	21.55
				1	24	1	21.94
				12	0	2	21.59
				12	6	2	20.74
				12	13	2	20.76
				25	0	2	20.59
	26665	1912.5	QPSK	1	0	0	22.42
				1	12	0	22.25
1				24	0	22.24	
12				0	1	21.59	
12				6	1	21.33	
12				13	1	21.58	
25				0	1	21.57	
16QAM			1	0	1	22.19	
			1	12	1	22.26	
			1	24	1	22.15	
			12	0	2	20.77	
			12	6	2	20.79	
			12	13	2	20.86	
			25	0	2	20.56	

The results shown in this test report refer only to the sample(s) tested unless otherwise stated and the sample(s) are retained for 30 days only. The document is issued by AGC, this document cannot be reproduced except in full with our prior written permission. The more details and the authenticity of the report will be confirmed at <http://www.agc-cert.com>.

BW (MHz)	Ch	Freq. (MHz)	Mode	UL RB Allocation	UL RB Offset	MPR	Average power (dBm)		
3MHz	26055	1851.5	QPSK	1	0	0	22.64		
				1	7	0	22.35		
				1	14	0	22.62		
				8	0	1	20.31		
				8	4	1	20.22		
				8	7	1	20.19		
			15	0	1	20.55			
			16QAM	1	0	1	22.52		
				1	7	1	22.49		
				1	14	1	22.36		
				8	0	2	21.39		
				8	4	2	21.55		
				8	7	2	22.08		
			26365	1882.5	QPSK	1	0	0	22.72
						1	7	0	22.25
	1	14				0	22.44		
	8	0				1	21.28		
	8	4				1	21.43		
	8	7				1	21.53		
	15	0			1	21.54			
	16QAM	1			0	1	21.88		
		1			7	1	21.54		
		1			14	1	21.79		
		8			0	2	20.25		
		8			4	2	20.31		
		8			7	2	20.63		
	26675	1913.5			QPSK	1	0	0	22.66
						1	7	0	22.39
			1	14		0	22.78		
			8	0		1	21.37		
8			4	1		21.43			
8			7	1		21.64			
15			0	1	21.67				
16QAM			1	0	1	22.19			
			1	7	1	22.43			
			1	14	1	22.04			
			8	0	2	20.41			
			8	4	2	20.36			
			8	7	2	20.66			
15			0	2	20.65				

The results shown in this test report refer only to the sample(s) tested unless otherwise stated and the sample(s) are retained for 30 days only. The document is issued by AGC, this document cannot be reproduced except in full with our prior written permission. The more details and the authenticity of the report will be confirmed at <http://www.agc-cert.com>.

BW (MHz)	Ch	Freq. (MHz)	Mode	UL RB Allocation	UL RB Offset	MPR	Average power (dBm)
1.4MHz	26047	1850.7	QPSK	1	0	0	22.84
				1	3	0	22.77
				1	5	0	22.82
				3	0	1	22.57
				3	2	1	22.83
				3	3	1	22.78
			16QAM	6	0	1	22.65
				1	0	1	22.05
				1	3	1	21.89
				1	5	1	21.97
				3	0	2	21.57
				3	2	2	21.69
	26365	1882.5	QPSK	3	3	2	21.76
				6	0	2	21.73
				1	0	0	22.49
				1	3	0	22.35
				1	5	0	22.46
				3	0	1	22.28
			16QAM	3	2	1	22.39
				3	3	1	22.43
				6	0	1	21.54
				1	0	1	22.09
				1	3	1	22.33
				1	5	1	22.27
	26683	1914.3	QPSK	3	0	2	21.32
				3	2	2	21.51
				3	3	2	21.63
				6	0	2	20.33
				1	0	0	22.46
				1	3	0	22.54
			16QAM	1	5	0	22.46
				3	0	1	22.25
				3	2	1	22.33
				3	3	1	22.61
				6	0	1	21.50
				1	0	1	22.03
16QAM	1	3	1	22.39			
	1	5	1	22.47			
	3	0	2	21.55			
	3	2	2	21.58			
	3	3	2	21.78			
	6	0	2	20.73			

The results shown in this test report refer only to the sample(s) tested unless otherwise stated and the sample(s) are retained for 30 days only. The document is issued by AGC, this document cannot be reproduced except in full with our prior written permission. The more details and the authenticity of the report will be confirmed at <http://www.agc-cert.com>.

According to 3GPP 36.521 sub-clause 6.2.3.3, the maximum output power is allowed to be reduced by following the table.

Table 6.2.3.3-1: Maximum Power Reduction (MPR) for Power Class 3

Modulation	Channel bandwidth / Transmission bandwidth configuration [RB]						MPR (dB)
	1.4 MHz	3.0 MHz	5 MHz	10 MHz	15 MHz	20 MHz	
QPSK	> 5	> 4	> 8	> 12	> 16	> 18	≤ 1
16 QAM	≤ 5	≤ 4	≤ 8	≤ 12	≤ 16	≤ 18	≤ 1
16 QAM	> 5	> 4	> 8	> 12	> 16	> 18	≤ 2

The device supports MPR to solve linearity issues (ACLR or SEM) due to the higher peak-to average ratios (PAR) of the HSUPA signal. This prevents saturating the full range of the TX DAC inside of device and provides a reduced power output to the RF transceiver chip according to the Cubic Metric (For PRACH, PUCCH and SRS transmission, the allowed MPR is according to that specified for PUSCH QPSK modulation for the corresponding transmission bandwidth.).

When PRACH, PUCCH are present the beta gains on those channels are reduced firsts to try to get the power under the allowed limit. If the beta gains are lowered as far as possible, then a hard limiting is applied at the maximum allowed level.

For each subframe, the MPR is evaluated per slot and given by the maximum value taken over the transmission(s) within the slot, the maximum MPR over the two slots is then applied for the entire subframe.

For the UE maximum output power modified by MPR, the power limits specified in subclause 6.2.5.3 apply. The normative reference for this requirement is TS 36.101 clause 6.2.3.

The end effect is that the DUT output power is identical to the case where there is no MPR in the device.

The results shown in this test report refer only to the sample(s) tested unless otherwise stated and the sample(s) are retained for 30 days only. The document is issued by AGC, this document cannot be reproduced except in full with our prior written permission. The more details and the authenticity of the report will be confirmed at <http://www.agc-cert.com>.

6.2 RADIATED OUTPUT POWER

6.2.1 MEASUREMENT METHOD

The measurements procedures specified in ANSI/TIA-603-E-2016 were applied.

- 1 In an anechoic antenna test chamber, a half-wave dipole antenna for the frequency band of interest is placed at the reference centre of the chamber. An RF Signal source for the frequency band of interest is connected to the dipole with a cable that has been constructed to not interfere with the radiation pattern of the antenna. A known (measured) power (P_{in}) is applied to the input of the dipole, and the power received (P_r) at the chamber's probe antenna is recorded.
- 2 The substitution method is used. Substitution values at each frequency are measured before and saved to the test software. A "reference path loss" is established as $AR_{pl} = P_{in} - P_r$. The AR_{pl} is the attenuation of "reference path loss", and including the gain of receive antenna, the cable loss and the air loss. The measurement results are obtained as described below: $Power = P_{Mea} + AR_{pl}$
- 3 The EUT is substituted for the dipole at the reference centre of the chamber and a scan is performed to obtain the radiation pattern.
- 4 From the radiation pattern, the co-ordinates where the maximum antenna gain occurs are identified.
- 5 The EUT is then put into continuously transmitting mode at its maximum power level.
- 6 Power mode measurements are performed with the receiving antenna placed at the coordinates determined in Step 3 to determine the output power as defined in Rule 27.50(d)(4). The "reference path loss" from Step1 is added to this result.
- 7 This value is EIRP since the measurement is calibrated using a half-wave dipole antenna of known gain (2.15 dBi) and known input power (P_{in}).
- 8 ERP can be calculated from EIRP by subtracting the gain of the dipole, $ERP = EIRP - 2.15dBi$.

Test Setup

NOTE: Effective radiated power (ERP) refers to the radiation power output of the EUT, assuming all emissions are radiated from half-wave dipole antennas.

The results shown in this test report refer only to the sample(s) tested unless otherwise stated and the sample(s) are retained for 30 days only. The document is issued by AGC, this document cannot be reproduced except in full with our prior written permission. The more details and the authenticity of the report will be confirmed at <http://www.agc-cert.com>.

Step 1: Pre-test

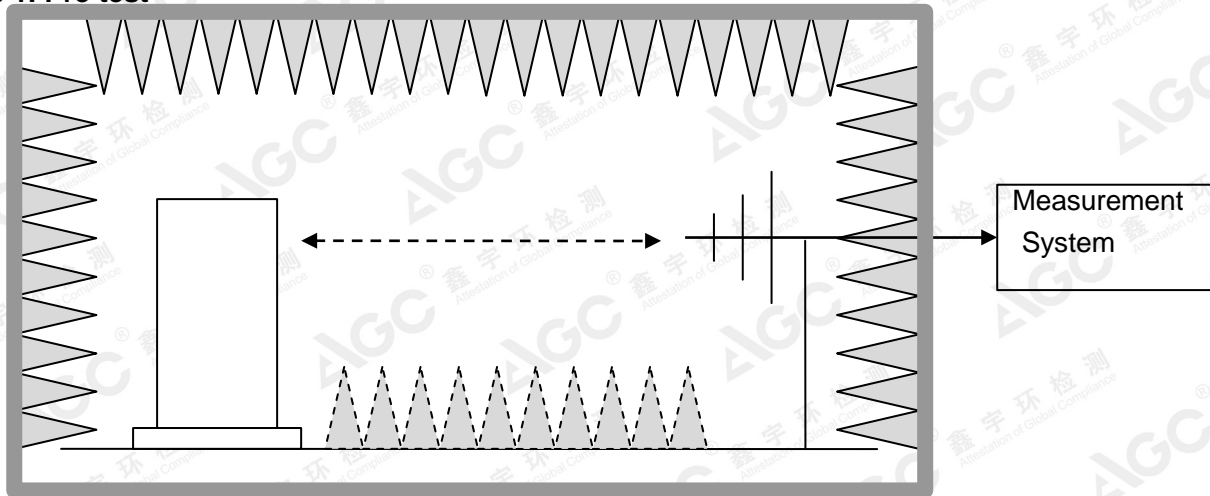

Step 2: Substitution method to verify the maximum ERP

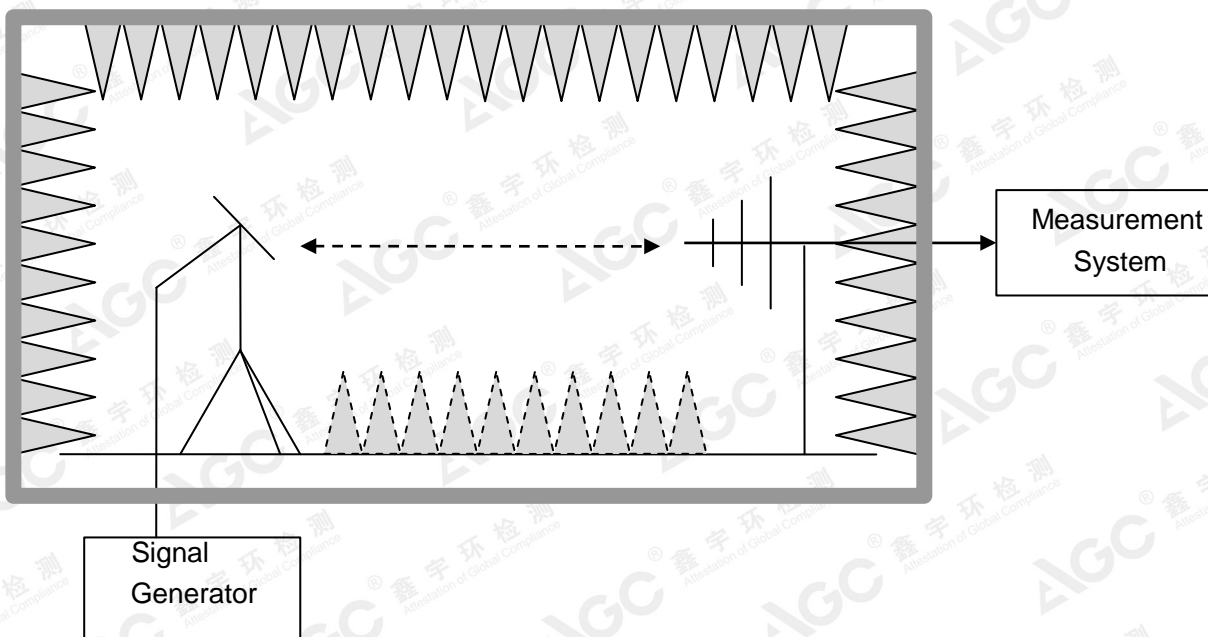

The results shown in this test report refer only to the sample(s) tested unless otherwise stated and the sample(s) are retained for 30 days only. The document is issued by AGC, this document cannot be reproduced except in full with our prior written permission. The more details and the authenticity of the report will be confirmed at <http://www.agc-cert.com>.

6.2.2 PROVISIONS APPLICABLE

This is the test for the maximum radiated power from the EUT. Rule Part 24.232(c) specifies, "Mobile/portable stations are limited to 2 watts e.i.r.p."

Mode	Nominal Peak Power
LTE Band 2	<=33dBm (2W)
LTE Band 4	<=30dBm (1W)
LTE Band 5	<=38.45dBm(7W)
LTE Band 7	<=33dBm (2W)
LTE Band 25	<=33dBm (2W)

The results shown in this test report refer only to the sample(s) tested unless otherwise stated and the sample(s) are retained for 30 days only. The document is issued by AGC, this document cannot be reproduced except in full with our prior written permission. The more details and the authenticity of the report will be confirmed at <http://www.agc-cert.com>.

6.2.3 MEASUREMENT RESULT
EIRP for LTE Band 2

Frequency	Channel Bandwidth	Mode.	RB	Substituted level	Antenna Polarization	Antenna Gain correction	Cable Loss	Absolute Level	Limit (dBm)
1850.7	1.4	QPSK	1/0	12.87	V	7.95	0.79	20.03	33
1880.0	1.4	QPSK	1/0	11.20	V	7.95	0.79	18.36	33
1909.3	1.4	QPSK	1/0	11.64	V	7.95	0.79	18.80	33
1850.7	1.4	QPSK	1/0	12.17	H	7.95	0.79	19.33	33
1880.0	1.4	QPSK	1/0	10.37	H	7.95	0.79	17.53	33
1909.3	1.4	QPSK	1/0	11.64	H	7.95	0.79	18.80	33
1850.7	1.4	16-QAM	1/5	11.92	V	7.95	0.79	19.08	33
1880.0	1.4	16-QAM	1/0	9.81	V	7.95	0.79	16.97	33
1909.3	1.4	16-QAM	1/0	10.47	V	7.95	0.79	17.63	33
1850.7	1.4	16-QAM	1/5	12.19	H	7.95	0.79	19.35	33
1880.0	1.4	16-QAM	1/0	11.16	H	7.95	0.79	18.32	33
1909.3	1.4	16-QAM	1/0	9.98	H	7.95	0.79	17.14	33
1851.5	3	QPSK	1/0	9.92	V	7.95	0.79	17.08	33
1880.0	3	QPSK	1/0	12.92	V	7.95	0.79	20.08	33
1908.5	3	QPSK	1/0	12.81	V	7.95	0.79	19.97	33
1851.5	3	QPSK	1/0	12.23	H	7.95	0.79	19.39	33
1880.0	3	QPSK	1/0	9.69	H	7.95	0.79	16.85	33
1908.5	3	QPSK	1/0	10.21	H	7.95	0.79	17.37	33
1851.5	3	16-QAM	1/0	11.13	V	7.95	0.79	18.29	33
1880.0	3	16-QAM	1/0	10.69	V	7.95	0.79	17.85	33
1908.5	3	16-QAM	1/0	11.02	V	7.95	0.79	18.18	33
1851.5	3	16-QAM	1/0	11.08	H	7.95	0.79	18.24	33
1880.0	3	16-QAM	1/0	11.97	H	7.95	0.79	19.13	33
1908.5	3	16-QAM	1/0	13.27	H	7.95	0.79	20.43	33
1852.5	5	QPSK	1/0	13.11	V	7.95	0.79	20.27	33
1880.0	5	QPSK	1/0	12.47	V	7.95	0.79	19.63	33
1907.5	5	QPSK	1/24	13.77	V	7.95	0.79	20.93	33
1852.5	5	QPSK	1/0	13.75	H	7.95	0.79	20.91	33
1880.0	5	QPSK	1/0	11.79	H	7.95	0.79	18.95	33
1907.5	5	QPSK	1/24	11.81	H	7.95	0.79	18.97	33
1852.5	5	16-QAM	1/0	12.06	V	7.95	0.79	19.22	33
1880.0	5	16-QAM	1/0	12.19	V	7.95	0.79	19.35	33

The results shown in this test report refer only to the sample(s) tested unless otherwise stated and the sample(s) are retained for 30 days only. The document is issued by AGC, this document cannot be reproduced except in full with our prior written permission. The more details and the authenticity of the report will be confirmed at <http://www.agc-cert.com>.

1907.5	5	16-QAM	1/24	10.63	V	7.95	0.79	17.79	33
1852.5	5	16-QAM	1/0	10.38	H	7.95	0.79	17.54	33
1880.0	5	16-QAM	1/0	13.03	H	7.95	0.79	20.19	33
1907.5	5	16-QAM	1/24	11.08	H	7.95	0.79	18.24	33
1855	10	QPSK	1/0	11.14	V	7.95	0.79	18.30	33
1880	10	QPSK	1/49	10.87	V	7.95	0.79	18.03	33
1905	10	QPSK	1/0	11.20	V	7.95	0.79	18.36	33
1855	10	QPSK	1/0	11.12	H	7.95	0.79	18.28	33
1880	10	QPSK	1/49	12.08	H	7.95	0.79	19.24	33
1905	10	QPSK	1/0	11.72	H	7.95	0.79	18.88	33
1855	10	16-QAM	1/0	12.55	V	7.95	0.79	19.71	33
1880	10	16-QAM	1/49	11.40	V	7.95	0.79	18.56	33
1905	10	16-QAM	1/0	12.24	V	7.95	0.79	19.40	33
1855	10	16-QAM	1/0	12.80	H	7.95	0.79	19.96	33
1880	10	16-QAM	1/49	12.40	H	7.95	0.79	19.56	33
1905	10	16-QAM	1/0	12.37	H	7.95	0.79	19.53	33
1920	15	QPSK	1/0	11.77	V	7.95	0.79	18.93	33
1950	15	QPSK	1/74	11.46	V	7.95	0.79	18.62	33
1920	15	QPSK	1/0	11.53	V	7.95	0.79	18.69	33
1920	15	QPSK	1/0	12.01	H	7.95	0.79	19.17	33
1950	15	QPSK	1/74	12.13	H	7.95	0.79	19.29	33
1920	15	QPSK	1/0	11.58	H	7.95	0.79	18.74	33
1920	15	16-QAM	1/0	11.64	V	7.95	0.79	18.80	33
1950	15	16-QAM	1/74	11.58	V	7.95	0.79	18.74	33
1920	15	16-QAM	1/0	12.42	V	7.95	0.79	19.58	33
1920	15	16-QAM	1/0	12.33	H	7.95	0.79	19.49	33
1950	15	16-QAM	1/74	11.37	H	7.95	0.79	18.53	33
1920	15	16-QAM	1/0	10.99	H	7.95	0.79	18.15	33
1930	20	QPSK	1/99	11.41	V	7.95	0.79	18.57	33
1950	20	QPSK	1/99	10.89	V	7.95	0.79	18.05	33
1970	20	QPSK	1/0	10.78	V	7.95	0.79	17.94	33
1930	20	QPSK	1/99	11.12	H	7.95	0.79	18.28	33
1950	20	QPSK	1/99	11.41	H	7.95	0.79	18.57	33
1970	20	QPSK	1/0	11.28	H	7.95	0.79	18.44	33
1930	20	16-QAM	1/99	11.34	V	7.95	0.79	18.50	33
1950	20	16-QAM	1/99	11.52	V	7.95	0.79	18.68	33

The results shown in this test report refer only to the sample(s) tested unless otherwise stated and the sample(s) are retained for 30 days only. The document is issued by AGC, this document cannot be reproduced except in full with our prior written permission. The more details and the authenticity of the report will be confirmed at <http://www.agc-cert.com>.

1970	20	16-QAM	1/0	11.37	V	7.95	0.79	18.53	33
1930	20	16-QAM	1/99	11.39	H	7.95	0.79	18.55	33
1950	20	16-QAM	1/99	11.14	H	7.95	0.79	18.30	33
1970	20	16-QAM	1/0	11.28	H	7.95	0.79	18.44	33

The results shown in this test report refer only to the sample(s) tested unless otherwise stated and the sample(s) are retained for 30 days only. The document is issued by AGC, this document cannot be reproduced except in full with our prior written permission. The more details and the authenticity of the report will be confirmed at <http://www.agc-cert.com>.

EIRP for LTE Band 4

Frequency	Channel Bandwidth	Mode.	RB	Substituted level	Antenna Polarization	Antenna Gain correction	Cable Loss	Absolute Level	Limit (dBm)
1710.7	1.4	QPSK	1/0	12.80	V	7.95	0.79	19.96	30
1732.5	1.4	QPSK	1/0	12.62	V	7.95	0.79	19.78	30
1754.3	1.4	QPSK	1/0	12.98	V	7.95	0.79	20.14	30
1710.7	1.4	QPSK	1/0	12.16	H	7.95	0.79	19.32	30
1732.5	1.4	QPSK	1/0	11.23	H	7.95	0.79	18.39	30
1754.3	1.4	QPSK	1/0	10.94	H	7.95	0.79	18.1	30
1710.7	1.4	16-QAM	1/5	11.89	V	7.95	0.79	19.05	30
1732.5	1.4	16-QAM	1/0	13.37	V	7.95	0.79	20.53	30
1754.3	1.4	16-QAM	1/0	10.68	V	7.95	0.79	17.84	30
1710.7	1.4	16-QAM	1/5	10.78	H	7.95	0.79	17.94	30
1732.5	1.4	16-QAM	1/0	11.40	H	7.95	0.79	18.56	30
1754.3	1.4	16-QAM	1/0	12.58	H	7.95	0.79	19.74	30
1711.5	3	QPSK	1/0	11.07	V	7.95	0.79	18.23	30
1732.5	3	QPSK	1/0	11.89	V	7.95	0.79	19.05	30
1753.5	3	QPSK	1/0	14.51	V	7.95	0.79	21.67	30
1711.5	3	QPSK	1/0	12.22	H	7.95	0.79	19.38	30
1732.5	3	QPSK	1/0	12.15	H	7.95	0.79	19.31	30
1753.5	3	QPSK	1/0	10.58	H	7.95	0.79	17.74	30
1711.5	3	16-QAM	1/0	12.18	V	7.95	0.79	19.34	30
1732.5	3	16-QAM	1/0	12.06	V	7.95	0.79	19.22	30
1753.5	3	16-QAM	1/0	12.93	V	7.95	0.79	20.09	30
1711.5	3	16-QAM	1/0	12.36	H	7.95	0.79	19.52	30
1732.5	3	16-QAM	1/0	15.41	H	7.95	0.79	22.57	30
1753.5	3	16-QAM	1/0	13.55	H	7.95	0.79	20.71	30
1712.5	5	QPSK	1/0	13.02	V	7.95	0.79	20.18	30
1732.5	5	QPSK	1/0	14.66	V	7.95	0.79	21.82	30
1752.5	5	QPSK	1/24	12.20	V	7.95	0.79	19.36	30
1712.5	5	QPSK	1/0	13.91	H	7.95	0.79	21.07	30
1732.5	5	QPSK	1/0	11.50	H	7.95	0.79	18.66	30
1752.5	5	QPSK	1/24	11.91	H	7.95	0.79	19.07	30
1712.5	5	16-QAM	1/0	12.40	V	7.95	0.79	19.56	30
1732.5	5	16-QAM	1/0	10.49	V	7.95	0.79	17.65	30
1752.5	5	16-QAM	1/24	10.57	V	7.95	0.79	17.73	30
1712.5	5	16-QAM	1/0	11.46	H	7.95	0.79	18.62	30
1732.5	5	16-QAM	1/0	9.75	H	7.95	0.79	16.91	30
1752.5	5	16-QAM	1/24	12.12	H	7.95	0.79	19.28	30

The results shown in this test report refer only to the sample(s) tested unless otherwise stated and the sample(s) are retained for 30 days only. The document is issued by AGC, this document cannot be reproduced except in full with our prior written permission. The more details and the authenticity of the report will be confirmed at <http://www.agc-cert.com>.

1715	10	QPSK	1/0	13.04	V	7.95	0.79	20.2	30
1732.5	10	QPSK	1/49	10.35	V	7.95	0.79	17.51	30
1750	10	QPSK	1/0	10.66	V	7.95	0.79	17.82	30
1715	10	QPSK	1/0	12.73	H	7.95	0.79	19.89	30
1732.5	10	QPSK	1/49	12.48	H	7.95	0.79	19.64	30
1750	10	QPSK	1/0	11.91	H	7.95	0.79	19.07	30
1715	10	16-QAM	1/0	12.65	V	7.95	0.79	19.81	30
1732.5	10	16-QAM	1/49	11.57	V	7.95	0.79	18.73	30
1750	10	16-QAM	1/0	10.98	V	7.95	0.79	18.14	30
1715	10	16-QAM	1/0	12.13	H	7.95	0.79	19.29	30
1732.5	10	16-QAM	1/49	12.65	H	7.95	0.79	19.81	30
1750	10	16-QAM	1/0	13.05	H	7.95	0.79	20.21	30
1717.5	15	QPSK	1/0	11.63	V	7.95	0.79	18.79	30
1732.5	15	QPSK	1/74	11.73	V	7.95	0.79	18.89	30
1747.5	15	QPSK	1/0	10.08	V	7.95	0.79	17.24	30
1717.5	15	QPSK	1/0	11.98	H	7.95	0.79	19.14	30
1732.5	15	QPSK	1/74	12.05	H	7.95	0.79	19.21	30
1747.5	15	QPSK	1/0	11.59	H	7.95	0.79	18.75	30
1717.5	15	16-QAM	1/0	12.51	V	7.95	0.79	19.67	30
1732.5	15	16-QAM	1/74	10.14	V	7.95	0.79	17.3	30
1747.5	15	16-QAM	1/0	11.66	V	7.95	0.79	18.82	30
1717.5	15	16-QAM	1/0	9.43	H	7.95	0.79	16.59	30
1732.5	15	16-QAM	1/74	12.03	H	7.95	0.79	19.19	30
1747.5	15	16-QAM	1/0	11.33	H	7.95	0.79	18.49	30
1720	20	QPSK	1/99	11.39	V	7.95	0.79	18.55	30
1732.5	20	QPSK	1/99	12.18	V	7.95	0.79	19.34	30
1745	20	QPSK	1/0	12.56	V	7.95	0.79	19.72	30
1720	20	QPSK	1/99	11.02	H	7.95	0.79	18.18	30
1732.5	20	QPSK	1/99	11.38	H	7.95	0.79	18.54	30
1745	20	QPSK	1/0	12.86	H	7.95	0.79	20.02	30
1720	20	16-QAM	1/99	10.51	V	7.95	0.79	17.67	30
1732.5	20	16-QAM	1/99	11.61	V	7.95	0.79	18.77	30
1745	20	16-QAM	1/0	11.06	V	7.95	0.79	18.22	30
1720	20	16-QAM	1/99	12.54	H	7.95	0.79	19.7	30
1732.5	20	16-QAM	1/99	10.79	H	7.95	0.79	17.95	30
1745	20	16-QAM	1/0	11.63	H	7.95	0.79	18.79	30

The results shown in this test report refer only to the sample(s) tested unless otherwise stated and the sample(s) are retained for 30 days only. The document is issued by AGC, this document cannot be reproduced except in full with our prior written permission. The more details and the authenticity of the report will be confirmed at <http://www.agc-cert.com>.

EIRP for LTE Band 5

Frequency	Channel Bandwidth	Mode.	RB	Substituted level	Antenna Polarization	Antenna Gain correction	Cable Loss	Absolute Level	Limit (dBm)
824.7	1.4	QPSK	1/0	13.50	V	6.7	0.49	20.66	38.45
836.5	1.4	QPSK	1/0	12.06	V	6.7	0.49	19.22	38.45
848.3	1.4	QPSK	1/0	13.07	V	6.7	0.49	20.23	38.45
824.7	1.4	QPSK	1/0	12.40	H	6.7	0.49	19.56	38.45
836.5	1.4	QPSK	1/0	12.57	H	6.7	0.49	19.73	38.45
848.3	1.4	QPSK	1/0	11.27	H	6.7	0.49	18.43	38.45
824.7	1.4	16-QAM	1/0	11.95	V	6.7	0.49	19.11	38.45
836.5	1.4	16-QAM	1/0	13.76	V	6.7	0.49	20.92	38.45
848.3	1.4	16-QAM	1/0	11.72	V	6.7	0.49	18.88	38.45
824.7	1.4	16-QAM	1/0	10.43	H	6.7	0.49	17.59	38.45
836.5	1.4	16-QAM	1/0	12.28	H	6.7	0.49	19.44	38.45
848.3	1.4	16-QAM	1/0	12.39	H	6.7	0.49	19.55	38.45
825.5	3	QPSK	1/0	11.33	V	6.7	0.49	18.49	38.45
836.5	3	QPSK	1/0	12.79	V	6.7	0.49	19.95	38.45
847.5	3	QPSK	1/0	12.50	V	6.7	0.49	19.66	38.45
825.5	3	QPSK	1/0	11.67	H	6.7	0.49	18.83	38.45
836.5	3	QPSK	1/0	12.73	H	6.7	0.49	19.89	38.45
847.5	3	QPSK	1/0	10.86	H	6.7	0.49	18.02	38.45
825.5	3	16-QAM	1/0	11.29	V	6.7	0.49	18.45	38.45
836.5	3	16-QAM	1/0	13.68	V	6.7	0.49	20.84	38.45
847.5	3	16-QAM	1/0	13.25	V	6.7	0.49	20.41	38.45
825.5	3	16-QAM	1/0	12.60	H	6.7	0.49	19.76	38.45
836.5	3	16-QAM	1/0	12.10	H	6.7	0.49	19.26	38.45
847.5	3	16-QAM	1/0	13.12	H	6.7	0.49	20.28	38.45
826.5	5	QPSK	1/0	14.12	V	6.7	0.49	21.28	38.45
836.5	5	QPSK	1/0	14.64	V	6.7	0.49	21.80	38.45
846.5	5	QPSK	1/0	14.55	V	6.7	0.49	21.71	38.45
826.5	5	QPSK	1/0	13.75	H	6.7	0.49	20.91	38.45
836.5	5	QPSK	1/0	13.31	H	6.7	0.49	20.47	38.45
846.5	5	QPSK	1/0	12.19	H	6.7	0.49	19.35	38.45
826.5	5	16-QAM	1/0	12.21	V	6.7	0.49	19.37	38.45
836.5	5	16-QAM	1/0	12.39	V	6.7	0.49	19.55	38.45
846.5	5	16-QAM	1/0	11.48	V	6.7	0.49	18.64	38.45
826.5	5	16-QAM	1/0	10.92	H	6.7	0.49	18.08	38.45
836.5	5	16-QAM	1/0	14.09	H	6.7	0.49	21.25	38.45
846.5	5	16-QAM	1/0	12.44	H	6.7	0.49	19.60	38.45

The results shown in this test report refer only to the sample(s) tested unless otherwise stated and the sample(s) are retained for 30 days only. The document is issued by AGC, this document cannot be reproduced except in full with our prior written permission. The more details and the authenticity of the report will be confirmed at <http://www.agc-cert.com>.

829	10	QPSK	1/0	11.91	V	6.7	0.49	19.07	38.45
836.5	10	QPSK	1/0	10.48	V	6.7	0.49	17.64	38.45
844	10	QPSK	1/0	13.01	V	6.7	0.49	20.17	38.45
829	10	QPSK	1/0	10.48	H	6.7	0.49	17.64	38.45
836.5	10	QPSK	1/0	11.47	H	6.7	0.49	18.63	38.45
844	10	QPSK	1/0	11.16	H	6.7	0.49	18.32	38.45
829	10	16-QAM	1/0	11.04	V	6.7	0.49	18.20	38.45
836.5	10	16-QAM	1/0	12.94	V	6.7	0.49	20.10	38.45
844	10	16-QAM	1/0	11.61	V	6.7	0.49	18.77	38.45
829	10	16-QAM	1/0	11.85	H	6.7	0.49	19.01	38.45
836.5	10	16-QAM	1/0	10.81	H	6.7	0.49	17.97	38.45
844	10	16-QAM	1/0	10.94	H	6.7	0.49	18.10	38.45

The results shown in this test report refer only to the sample(s) tested unless otherwise stated and the sample(s) are retained for 30 days only. The document is issued by AGC, this document cannot be reproduced except in full with our prior written permission. The more details and the authenticity of the report will be confirmed at <http://www.agc-cert.com>.

EIRP for LTE Band 7

Frequency	Channel Bandwidth	Mode.	RB	Substituted level	Antenna Polarization	Antenna Gain correction	Cable Loss	Absolute Level	Limit (dBm)
2502.5	5	QPSK	1/0	12.8	V	8.23	1.12	19.91	33
2535	5	QPSK	1/0	12.62	V	8.23	1.12	19.73	33
2567.5	5	QPSK	1/24	12.98	V	8.23	1.12	20.09	33
2502.5	5	QPSK	1/0	12.16	H	8.23	1.12	19.27	33
2535	5	QPSK	1/0	11.23	H	8.23	1.12	18.34	33
2567.5	5	QPSK	1/24	10.94	H	8.23	1.12	18.05	33
2502.5	5	16-QAM	1/0	11.89	V	8.23	1.12	19.00	33
2535	5	16-QAM	1/0	13.37	V	8.23	1.12	20.48	33
2567.5	5	16-QAM	1/24	10.68	V	8.23	1.12	17.79	33
2502.5	5	16-QAM	1/0	10.78	H	8.23	1.12	17.89	33
2535	5	16-QAM	1/0	11.4	H	8.23	1.12	18.51	33
2567.5	5	16-QAM	1/24	12.58	H	8.23	1.12	19.69	33
2505	10	QPSK	1/0	11.07	V	8.23	1.12	18.18	33
2535	10	QPSK	1/49	11.89	V	8.23	1.12	19.00	33
2565	10	QPSK	1/0	14.51	V	8.23	1.12	21.62	33
2505	10	QPSK	1/0	12.22	H	8.23	1.12	19.33	33
2535	10	QPSK	1/49	12.15	H	8.23	1.12	19.26	33
2565	10	QPSK	1/0	10.58	H	8.23	1.12	17.69	33
2505	10	16-QAM	1/0	12.18	V	8.23	1.12	19.29	33
2535	10	16-QAM	1/49	12.06	V	8.23	1.12	19.17	33
2565	10	16-QAM	1/0	12.93	V	8.23	1.12	20.04	33
2505	10	16-QAM	1/0	12.36	H	8.23	1.12	19.47	33
2535	10	16-QAM	1/49	15.41	H	8.23	1.12	22.52	33
2565	10	16-QAM	1/0	13.55	H	8.23	1.12	20.66	33
2507.5	15	QPSK	1/0	13.02	V	8.23	1.12	20.13	33
2535	15	QPSK	1/74	14.66	V	8.23	1.12	21.77	33
2562.5	15	QPSK	1/0	12.2	V	8.23	1.12	19.31	33
2507.5	15	QPSK	1/0	13.91	H	8.23	1.12	21.02	33
2535	15	QPSK	1/74	11.5	H	8.23	1.12	18.61	33
2562.5	15	QPSK	1/0	11.91	H	8.23	1.12	19.02	33
2507.5	15	16-QAM	1/0	12.4	V	8.23	1.12	19.51	33
2535	15	16-QAM	1/74	10.49	V	8.23	1.12	17.60	33
2562.5	15	16-QAM	1/0	10.57	V	8.23	1.12	17.68	33
2507.5	15	16-QAM	1/0	11.46	H	8.23	1.12	18.57	33
2535	15	16-QAM	1/74	9.75	H	8.23	1.12	16.86	33

The results shown in this test report refer only to the sample(s) tested unless otherwise stated and the sample(s) are retained for 30 days only. The document is issued by AGC, this document cannot be reproduced except in full with our prior written permission. The more details and the authenticity of the report will be confirmed at <http://www.agc-cert.com>.

2562.5	15	16-QAM	1/0	12.12	H	8.23	1.12	19.23	33
2510	20	QPSK	1/99	13.04	V	8.23	1.12	20.15	33
2535	20	QPSK	1/99	10.35	V	8.23	1.12	17.46	33
2560	20	QPSK	1/0	10.66	V	8.23	1.12	17.77	33
2510	20	QPSK	1/99	12.73	H	8.23	1.12	19.84	33
2535	20	QPSK	1/99	12.48	H	8.23	1.12	19.59	33
2560	20	QPSK	1/0	11.91	H	8.23	1.12	19.02	33
2510	20	16-QAM	1/99	12.65	V	8.23	1.12	19.76	33
2535	20	16-QAM	1/99	11.57	V	8.23	1.12	18.68	33
2560	20	16-QAM	1/0	10.98	V	8.23	1.12	18.09	33
2510	20	16-QAM	1/99	12.13	H	8.23	1.12	19.24	33
2535	20	16-QAM	1/99	12.65	H	8.23	1.12	19.76	33
2560	20	16-QAM	1/0	13.05	H	8.23	1.12	20.16	33

The results shown in this test report refer only to the sample(s) tested unless otherwise stated and the sample(s) are retained for 30 days only. The document is issued by AGC, this document cannot be reproduced except in full with our prior written permission. The more details and the authenticity of the report will be confirmed at <http://www.agc-cert.com>.

EIRP for LTE Band 25

Frequency	Channel Bandwidth	Mode.	RB	Substituted level	Antenna Polarization	Antenna Gain correction	Cable Loss	Absolute Level	Limit (dBm)
1850	1.4	QPSK	1/0	13.16	V	7.95	0.79	20.32	33
1882.5	1.4	QPSK	1/0	12.40	V	7.95	0.79	19.56	33
1914.3	1.4	QPSK	1/0	12.94	V	7.95	0.79	20.1	33
1850	1.4	QPSK	1/0	13.32	H	7.95	0.79	20.48	33
1882.5	1.4	QPSK	1/0	12.03	H	7.95	0.79	19.19	33
1914.3	1.4	QPSK	1/0	10.69	H	7.95	0.79	17.85	33
1850	1.4	16-QAM	1/5	11.69	V	7.95	0.79	18.85	33
1882.5	1.4	16-QAM	1/0	12.76	V	7.95	0.79	19.92	33
1914.3	1.4	16-QAM	1/0	11.62	V	7.95	0.79	18.78	33
1850	1.4	16-QAM	1/5	11.53	H	7.95	0.79	18.69	33
1882.5	1.4	16-QAM	1/0	12.65	H	7.95	0.79	19.81	33
1914.3	1.4	16-QAM	1/0	11.20	H	7.95	0.79	18.36	33
1851.5	3	QPSK	1/0	12.14	V	7.95	0.79	19.30	33
1882.5	3	QPSK	1/0	11.91	V	7.95	0.79	19.07	33
1913.5	3	QPSK	1/0	13.35	V	7.95	0.79	20.51	33
1851.5	3	QPSK	1/0	11.54	H	7.95	0.79	18.7	33
1882.5	3	QPSK	1/0	12.02	H	7.95	0.79	19.18	33
1913.5	3	QPSK	1/0	11.58	H	7.95	0.79	18.74	33
1851.5	3	16-QAM	1/0	12.95	V	7.95	0.79	20.11	33
1882.5	3	16-QAM	1/0	12.23	V	7.95	0.79	19.39	33
1913.5	3	16-QAM	1/0	13.26	V	7.95	0.79	20.42	33
1851.5	3	16-QAM	1/0	12.03	H	7.95	0.79	19.19	33
1882.5	3	16-QAM	1/0	14.71	H	7.95	0.79	21.87	33
1913.5	3	16-QAM	1/0	13.67	H	7.95	0.79	20.83	33
1852.5	5	QPSK	1/0	12.98	V	7.95	0.79	20.14	33
1882.5	5	QPSK	1/0	13.63	V	7.95	0.79	20.79	33
1912.5	5	QPSK	1/24	12.57	V	7.95	0.79	19.73	33
1852.5	5	QPSK	1/0	13.74	H	7.95	0.79	20.9	33
1882.5	5	QPSK	1/0	11.71	H	7.95	0.79	18.87	33
1912.5	5	QPSK	1/24	11.61	H	7.95	0.79	18.77	33
1852.5	5	16-QAM	1/0	12.25	V	7.95	0.79	19.41	33
1882.5	5	16-QAM	1/0	11.01	V	7.95	0.79	18.17	33
1912.5	5	16-QAM	1/24	11.29	V	7.95	0.79	18.45	33
1852.5	5	16-QAM	1/0	10.04	H	7.95	0.79	17.2	33
1882.5	5	16-QAM	1/0	10.88	H	7.95	0.79	18.04	33
1912.5	5	16-QAM	1/24	11.09	H	7.95	0.79	18.25	33

The results shown in this test report refer only to the sample(s) tested unless otherwise stated and the sample(s) are retained for 30 days only. The document is issued by AGC, this document cannot be reproduced except in full with our prior written permission. The more details and the authenticity of the report will be confirmed at <http://www.agc-cert.com>.

1855	10	QPSK	1/0	13.00	V	7.95	0.79	20.16	33
1882.5	10	QPSK	1/49	11.38	V	7.95	0.79	18.54	33
1910	10	QPSK	1/0	10.63	V	7.95	0.79	17.79	33
1855	10	QPSK	1/0	13.32	H	7.95	0.79	20.48	33
1882.5	10	QPSK	1/49	12.69	H	7.95	0.79	19.85	33
1910	10	QPSK	1/0	11.26	H	7.95	0.79	18.42	33
1855	10	16-QAM	1/0	12.95	V	7.95	0.79	20.11	33
1882.5	10	16-QAM	1/49	12.84	V	7.95	0.79	20.00	33
1910	10	16-QAM	1/0	11.49	V	7.95	0.79	18.65	33
1855	10	16-QAM	1/0	12.62	H	7.95	0.79	19.78	33
1882.5	10	16-QAM	1/49	12.87	H	7.95	0.79	20.03	33
1910	10	16-QAM	1/0	12.16	H	7.95	0.79	19.32	33
1857.5	15	QPSK	1/0	11.50	V	7.95	0.79	18.66	33
1882.5	15	QPSK	1/74	11.35	V	7.95	0.79	18.51	33
1907.5	15	QPSK	1/0	9.96	V	7.95	0.79	17.12	33
1857.5	15	QPSK	1/0	12.05	H	7.95	0.79	19.21	33
1882.5	15	QPSK	1/74	11.04	H	7.95	0.79	18.20	33
1907.5	15	QPSK	1/0	11.30	H	7.95	0.79	18.46	33
1857.5	15	16-QAM	1/0	13.35	V	7.95	0.79	20.51	33
1882.5	15	16-QAM	1/74	9.61	V	7.95	0.79	16.77	33
1907.5	15	16-QAM	1/0	11.17	V	7.95	0.79	18.33	33
1857.5	15	16-QAM	1/0	9.37	H	7.95	0.79	16.53	33
1882.5	15	16-QAM	1/74	11.82	H	7.95	0.79	18.98	33
1907.5	15	16-QAM	1/0	10.28	H	7.95	0.79	17.44	33
1860	20	QPSK	1/99	10.99	V	7.95	0.79	18.15	33
1882.5	20	QPSK	1/99	11.85	V	7.95	0.79	19.01	33
1905	20	QPSK	1/0	13.46	V	7.95	0.79	20.62	33
1860	20	QPSK	1/99	10.32	H	7.95	0.79	17.48	33
1882.5	20	QPSK	1/99	12.70	H	7.95	0.79	19.86	33
1905	20	QPSK	1/0	12.38	H	7.95	0.79	19.54	33
1860	20	16-QAM	1/99	11.13	V	7.95	0.79	18.29	33
1882.5	20	16-QAM	1/99	10.81	V	7.95	0.79	17.97	33
1905	20	16-QAM	1/0	10.39	V	7.95	0.79	17.55	33
1860	20	16-QAM	1/99	12.40	H	7.95	0.79	19.56	33
1882.5	20	16-QAM	1/99	10.66	H	7.95	0.79	17.82	33
1905	20	16-QAM	1/0	12.21	H	7.95	0.79	19.37	33

Note: Above is the worst mode data.

The results shown in this test report refer only to the sample(s) tested unless otherwise stated and the sample(s) are retained for 30 days only. The document is issued by AGC, this document cannot be reproduced except in full with our prior written permission. The more details and the authenticity of the report will be confirmed at <http://www.agc-cert.com>.

6.3. PEAK-TO-AVERAGE RATIO

6.3.1 MEASUREMENT METHOD

The peak-to-average power ratio (PAPR) of the transmitter output power must not exceed 13 dB. The PAPR measurements should be made using either an instrument with complementary cumulative distribution function (CCDF) capabilities to determine that PAPR will not exceed 13 dB for more than 0.1 percent of the time or other Commission approved procedure. The measurement must be performed using a signal corresponding to the highest PAPR expected during periods of continuous transmission.

According to KDB 971168 D01v03 - Section 5.7:

- a) Refer to instrument's analyzer instruction manual for details on how to use the power statistics /CCDF function;
- b) Set resolution/measurement bandwidth \geq signal's occupied bandwidth;
- c) Set the number of counts to a value that stabilizes the measured CCDF curve;
- d) Set the measurement interval to 1 ms
- e) Record the maximum PAPR level associated with a probability of 0.1%

6.3.2 PROVISIONS APPLICABLE

This is the test for the Peak-to-Average Ratio from the EUT.

Power Complementary Cumulative Distribution Function (CCDF) curves provide a means for characterizing the power peaks of a digitally modulated signal on a statistical basis. A CCDF curve depicts the probability of the peak signal amplitude exceeding the average power level. Most contemporary measurement instrumentation include the capability to produce CCDF curves for an input signal provided that the instrument's resolution bandwidth can be set wide enough to accommodate the entire input signal bandwidth. In measuring transmissions in this band using an average power technique, the peak-to-average ratio (PAR) of the transmission may not exceed 13 dB.

The results shown in this test report refer only to the sample(s) tested unless otherwise stated and the sample(s) are retained for 30 days only. The document is issued by AGC, this document cannot be reproduced except in full with our prior written permission. The more details and the authenticity of the report will be confirmed at <http://www.agc-cert.com>.

6.3.3 MEASUREMENT RESULT
LTE Band 2
Channel Bandwidth: 1.4 MHz

Channel Bandwidth: 1.4 MHz							
Modulation	Channel	RB Configuration		Peak-to-Average Ratio (dB)	Limit (dB)	Verdict	
		Size	Offset				
QPSK	LCH	1	0	4.37	<13	PASS	
		1	3	4.33	<13	PASS	
		1	5	4.35	<13	PASS	
		3	0	4.50	<13	PASS	
		3	2	4.32	<13	PASS	
		3	3	4.49	<13	PASS	
	MCH	6	0	5.14	<13	PASS	
		1	0	4.33	<13	PASS	
		1	3	4.11	<13	PASS	
		1	5	4.28	<13	PASS	
		3	0	4.31	<13	PASS	
		3	2	4.28	<13	PASS	
		3	3	4.38	<13	PASS	
	HCH	6	0	4.72	<13	PASS	
		1	0	4.42	<13	PASS	
		1	3	4.48	<13	PASS	
		1	5	4.56	<13	PASS	
		3	0	4.35	<13	PASS	
		3	2	4.18	<13	PASS	
	16QAM	LCH	3	3	4.64	<13	PASS
			6	0	5.18	<13	PASS
1			0	4.97	<13	PASS	
1			3	5.00	<13	PASS	
1			5	5.03	<13	PASS	
3			0	5.15	<13	PASS	
MCH		3	2	5.44	<13	PASS	
		3	3	5.40	<13	PASS	
		6	0	6.05	<13	PASS	
		1	0	5.01	<13	PASS	
		1	3	4.87	<13	PASS	
		1	5	5.17	<13	PASS	
		3	0	5.11	<13	PASS	
		3	2	5.25	<13	PASS	

The results shown in this test report refer only to the sample(s) tested unless otherwise stated and the sample(s) are retained for 30 days only. The document is issued by AGC, this document cannot be reproduced except in full with our prior written permission. The more details and the authenticity of the report will be confirmed at <http://www.agc-cert.com>.

		3	3	5.29	<13	PASS
		6	0	5.59	<13	PASS
	HCH	1	0	5.09	<13	PASS
		1	3	5.00	<13	PASS
		1	5	5.24	<13	PASS
		3	0	5.15	<13	PASS
		3	2	5.25	<13	PASS
		3	3	5.41	<13	PASS
		6	0	6.04	<13	PASS

Channel Bandwidth: 3 MHz

Channel Bandwidth: 3 MHz						
Modulation	Channel	RB Configuration		Peak-to-Average Ratio [dB]	Limit [dB]	Verdict
		Size	Offset			
QPSK	LCH	1	0	4.30	<13	PASS
		1	7	4.27	<13	PASS
		1	14	4.43	<13	PASS
		8	0	4.58	<13	PASS
		8	4	4.19	<13	PASS
		8	7	4.74	<13	PASS
		15	0	4.98	<13	PASS
	MCH	1	0	4.22	<13	PASS
		1	7	4.21	<13	PASS
		1	14	4.10	<13	PASS
		8	0	4.26	<13	PASS
		8	4	4.18	<13	PASS
		8	7	4.70	<13	PASS
		15	0	4.84	<13	PASS
	HCH	1	0	4.36	<13	PASS
		1	7	4.25	<13	PASS
		1	14	4.63	<13	PASS
		8	0	4.58	<13	PASS
		8	4	4.93	<13	PASS
		8	7	4.95	<13	PASS
		15	0	5.18	<13	PASS
16QAM	LCH	1	0	5.20	<13	PASS
		1	7	5.15	<13	PASS

The results shown in this test report refer only to the sample(s) tested unless otherwise stated and the sample(s) are retained for 30 days only. The document is issued by AGC, this document cannot be reproduced except in full with our prior written permission. The more details and the authenticity of the report will be confirmed at <http://www.agc-cert.com>.

		1	14	5.17	<13	PASS
		8	0	5.15	<13	PASS
		8	4	5.58	<13	PASS
		8	7	5.63	<13	PASS
		15	0	6.10	<13	PASS
	MCH	1	0	4.75	<13	PASS
		1	7	5.00	<13	PASS
		1	14	5.14	<13	PASS
		8	0	5.48	<13	PASS
		8	4	5.37	<13	PASS
		8	7	5.58	<13	PASS
	HCH	15	0	5.89	<13	PASS
		1	0	5.02	<13	PASS
		1	7	5.18	<13	PASS
		1	14	5.39	<13	PASS
8		0	5.31	<13	PASS	
8		4	5.23	<13	PASS	
8		7	5.74	<13	PASS	
		15	0	5.89	<13	PASS

Channel Bandwidth: 5 MHz

Channel Bandwidth: 5 MHz						
Modulation	Channel	RB Configuration		Peak-to-Average Ratio [dB]	Limit [dB]	Verdict
		Size	Offset			
QPSK	LCH	1	0	4.35	<13	PASS
		1	12	4.28	<13	PASS
		1	24	4.25	<13	PASS
		12	0	4.05	<13	PASS
		12	6	4.99	<13	PASS
		12	13	4.71	<13	PASS
	MCH	25	0	5.06	<13	PASS
		1	0	4.02	<13	PASS
		1	12	4.35	<13	PASS
		1	24	3.82	<13	PASS
12		0	3.97	<13	PASS	
		12	6	4.16	<13	PASS

The results shown in this test report refer only to the sample(s) tested unless otherwise stated and the sample(s) are retained for 30 days only. The document is issued by AGC, this document cannot be reproduced except in full with our prior written permission. The more details and the authenticity of the report will be confirmed at <http://www.agc-cert.com>.

		12	13	4.69	<13	PASS
		25	0	4.89	<13	PASS
	HCH	1	0	4.29	<13	PASS
		1	12	4.26	<13	PASS
		1	24	4.37	<13	PASS
		12	0	4.28	<13	PASS
		12	6	4.36	<13	PASS
		12	13	4.78	<13	PASS
		25	0	5.19	<13	PASS
16QAM	LCH	1	0	5.25	<13	PASS
		1	12	4.25	<13	PASS
		1	24	4.99	<13	PASS
		12	0	5.16	<13	PASS
		12	6	5.23	<13	PASS
		12	13	5.65	<13	PASS
		25	0	6.06	<13	PASS
	MCH	1	0	4.75	<13	PASS
		1	12	4.26	<13	PASS
		1	24	4.62	<13	PASS
		12	0	5.00	<13	PASS
		12	6	5.61	<13	PASS
		12	13	5.52	<13	PASS
		25	0	5.76	<13	PASS
	HCH	1	0	5.22	<13	PASS
		1	12	5.11	<13	PASS
		1	24	5.14	<13	PASS
		12	0	5.14	<13	PASS
		12	6	5.26	<13	PASS
		12	13	5.71	<13	PASS
		25	0	5.87	<13	PASS

Channel Bandwidth: 10 MHz

Channel Bandwidth: 10 MHz						
Modulation	Channel	RB Configuration		Peak-to-Average Ratio [dB]	Limit [dB]	Verdict
		Size	Offset			
QPSK	LCH	1	0	4.31	<13	PASS

The results shown in this test report refer only to the sample(s) tested unless otherwise stated and the sample(s) are retained for 30 days only. The document is issued by AGC, this document cannot be reproduced except in full with our prior written permission. The more details and the authenticity of the report will be confirmed at <http://www.agc-cert.com>.

		1	24	4.31	<13	PASS
		1	49	4.57	<13	PASS
		25	0	4.29	<13	PASS
		25	12	4.67	<13	PASS
		25	25	4.88	<13	PASS
		50	0	5.05	<13	PASS
	MCH	1	0	4.54	<13	PASS
		1	24	4.33	<13	PASS
		1	49	4.16	<13	PASS
		25	0	4.25	<13	PASS
		25	12	4.39	<13	PASS
		25	25	4.63	<13	PASS
		50	0	4.74	<13	PASS
	HCH	1	0	4.65	<13	PASS
		1	24	4.26	<13	PASS
		1	49	4.57	<13	PASS
		25	0	4.11	<13	PASS
		25	12	4.75	<13	PASS
		25	25	4.69	<13	PASS
		50	0	4.99	<13	PASS
	16QAM	LCH	1	0	5.11	<13
1			24	5.13	<13	PASS
1			49	5.42	<13	PASS
25			0	5.32	<13	PASS
25			12	5.28	<13	PASS
25			25	5.66	<13	PASS
50			0	5.94	<13	PASS
MCH		1	0	5.16	<13	PASS
		1	24	5.10	<13	PASS
		1	49	4.73	<13	PASS
		25	0	5.27	<13	PASS
		25	12	5.46	<13	PASS
		25	25	5.57	<13	PASS
		50	0	5.71	<13	PASS
HCH		1	0	5.64	<13	PASS
	1	24	5.29	<13	PASS	

The results shown in this test report refer only to the sample(s) tested unless otherwise stated and the sample(s) are retained for 30 days only. The document is issued by AGC, this document cannot be reproduced except in full with our prior written permission. The more details and the authenticity of the report will be confirmed at <http://www.agc-cert.com>.

		1	49	5.23	<13	PASS
		25	0	5.21	<13	PASS
		25	12	5.19	<13	PASS
		25	25	5.60	<13	PASS
		50	0	5.81	<13	PASS

Channel Bandwidth: 15 MHz

Channel Bandwidth: 15 MHz						
Modulation	Channel	RB Configuration		Peak-to-Average Ratio [dB]	Limit [dB]	Verdict
		Size	Offset			
QPSK	LCH	1	0	4.16	<13	PASS
		1	37	4.32	<13	PASS
		1	74	4.90	<13	PASS
		37	0	4.87	<13	PASS
		37	18	4.99	<13	PASS
		37	38	4.93	<13	PASS
		75	0	5.47	<13	PASS
	MCH	1	0	4.46	<13	PASS
		1	37	4.32	<13	PASS
		1	74	4.17	<13	PASS
		37	0	4.20	<13	PASS
		37	18	4.28	<13	PASS
		37	38	4.49	<13	PASS
		75	0	5.05	<13	PASS
	HCH	1	0	4.64	<13	PASS
		1	37	5.00	<13	PASS
		1	74	4.50	<13	PASS
		37	0	4.57	<13	PASS
		37	18	4.69	<13	PASS
		37	38	4.77	<13	PASS
		75	0	5.17	<13	PASS
16QAM	LCH	1	0	5.07	<13	PASS
		1	37	5.03	<13	PASS
		1	74	5.58	<13	PASS
		37	0	5.86	<13	PASS
		37	18	5.78	<13	PASS
		37	38	5.86	<13	PASS
		75	0	6.10	<13	PASS
	MCH	1	0	5.17	<13	PASS

The results shown in this test report refer only to the sample(s) tested unless otherwise stated and the sample(s) are retained for 30 days only. The document is issued by AGC, this document cannot be reproduced except in full with our prior written permission. The more details and the authenticity of the report will be confirmed at <http://www.agc-cert.com>.

		1	37	5.23	<13	PASS
		1	74	5.02	<13	PASS
		37	0	5.25	<13	PASS
		37	18	5.27	<13	PASS
		37	38	5.54	<13	PASS
		75	0	5.93	<13	PASS
	HCH	1	0	5.63	<13	PASS
		1	37	5.26	<13	PASS
		1	74	5.06	<13	PASS
		37	0	5.31	<13	PASS
		37	18	5.18	<13	PASS
		37	38	5.57	<13	PASS
		75	0	5.92	<13	PASS

Channel Bandwidth: 20 MHz

Channel Bandwidth: 20 MHz						
Modulation	Channel	RB Configuration		Peak-to-Average Ratio [dB]	Limit [dB]	Verdict
		Size	Offset			
QPSK	LCH	1	0	4.24	<13	PASS
		1	49	4.65	<13	PASS
		1	99	4.80	<13	PASS
		50	0	5.23	<13	PASS
		50	25	5.18	<13	PASS
		50	50	5.13	<13	PASS
		100	0	5.39	<13	PASS
	MCH	1	0	4.65	<13	PASS
		1	49	4.52	<13	PASS
		1	99	4.26	<13	PASS
		50	0	4.33	<13	PASS
		50	25	4.36	<13	PASS
		50	50	4.65	<13	PASS
		100	0	4.91	<13	PASS
	HCH	1	0	4.41	<13	PASS
		1	49	4.36	<13	PASS
		1	99	4.50	<13	PASS
		50	0	4.25	<13	PASS
		50	25	4.64	<13	PASS
		50	50	4.72	<13	PASS
		100	0	5.09	<13	PASS

The results shown in this test report refer only to the sample(s) tested unless otherwise stated and the sample(s) are retained for 30 days only. The document is issued by AGC, this document cannot be reproduced except in full with our prior written permission. The more details and the authenticity of the report will be confirmed at <http://www.agc-cert.com>.

16QAM	LCH	1	0	4.98	<13	PASS
		1	49	4.89	<13	PASS
		1	99	5.66	<13	PASS
		50	0	5.22	<13	PASS
		50	25	5.33	<13	PASS
		50	50	5.97	<13	PASS
		100	0	6.11	<13	PASS
	MCH	1	0	5.35	<13	PASS
		1	49	5.28	<13	PASS
		1	99	5.24	<13	PASS
		50	0	5.11	<13	PASS
		50	25	5.36	<13	PASS
		50	50	5.63	<13	PASS
		100	0	5.80	<13	PASS
	HCH	1	0	4.98	<13	PASS
		1	49	4.97	<13	PASS
		1	99	5.11	<13	PASS
		50	0	5.09	<13	PASS
		50	25	5.32	<13	PASS
		50	50	5.63	<13	PASS
		100	0	5.89	<13	PASS

The results shown in this test report refer only to the sample(s) tested unless otherwise stated and the sample(s) are retained for 30 days only. The document is issued by AGC, this document cannot be reproduced except in full with our prior written permission. The more details and the authenticity of the report will be confirmed at <http://www.agc-cert.com>.

LTE Band 4
Channel Bandwidth: 1.4 MHz

Channel Bandwidth: 1.4 MHz						
Modulation	Channel	RB Configuration		Peak-to-Average Ratio (dB)	Limit (dB)	Verdict
		Size	Offset			
QPSK	LCH	1	0	4.41	<13	PASS
		1	3	4.36	<13	PASS
		1	5	4.40	<13	PASS
		3	0	4.22	<13	PASS
		3	2	4.29	<13	PASS
		3	3	4.58	<13	PASS
		6	0	4.99	<13	PASS
	MCH	1	0	4.52	<13	PASS
		1	3	4.25	<13	PASS
		1	5	4.46	<13	PASS
		3	0	4.36	<13	PASS
		3	2	4.57	<13	PASS
		3	3	4.57	<13	PASS
		6	0	4.72	<13	PASS
	HCH	1	0	4.47	<13	PASS
		1	3	4.33	<13	PASS
		1	5	4.58	<13	PASS
		3	0	4.44	<13	PASS
		3	2	4.29	<13	PASS
		3	3	4.52	<13	PASS
		6	0	4.74	<13	PASS
16QAM	LCH	1	0	5.01	<13	PASS
		1	3	4.99	<13	PASS
		1	5	5.15	<13	PASS
		3	0	5.02	<13	PASS
		3	2	5.33	<13	PASS
		3	3	5.49	<13	PASS
		6	0	5.83	<13	PASS
	MCH	1	0	5.29	<13	PASS
		1	3	5.28	<13	PASS
		1	5	5.35	<13	PASS
		3	0	5.46	<13	PASS
		3	2	5.44	<13	PASS
		3	3	5.42	<13	PASS

The results shown in this test report refer only to the sample(s) tested unless otherwise stated and the sample(s) are retained for 30 days only. The document is issued by AGC, this document cannot be reproduced except in full with our prior written permission. The more details and the authenticity of the report will be confirmed at <http://www.agc-cert.com>.

	HCH	6	0	5.53	<13	PASS
		1	0	5.24	<13	PASS
		1	3	5.16	<13	PASS
		1	5	5.33	<13	PASS
		3	0	5.22	<13	PASS
		3	2	5.28	<13	PASS
		3	3	5.30	<13	PASS
		6	0	5.52	<13	PASS

Channel Bandwidth: 3 MHz

Channel Bandwidth: 3 MHz						
Modulation	Channel	RB Configuration		Peak-to-Average Ratio [dB]	Limit [dB]	Verdict
		Size	Offset			
QPSK	LCH	1	0	4.44	<13	PASS
		1	7	4.52	<13	PASS
		1	14	4.42	<13	PASS
		8	0	4.39	<13	PASS
		8	4	4.45	<13	PASS
		8	7	4.72	<13	PASS
		15	0	4.96	<13	PASS
	MCH	1	0	4.34	<13	PASS
		1	7	4.58	<13	PASS
		1	14	4.32	<13	PASS
		8	0	4.48	<13	PASS
		8	4	4.29	<13	PASS
		8	7	4.63	<13	PASS
		15	0	4.73	<13	PASS
	HCH	1	0	4.39	<13	PASS
		1	7	4.80	<13	PASS
		1	14	4.34	<13	PASS
		8	0	4.44	<13	PASS
		8	4	4.36	<13	PASS
		8	7	4.67	<13	PASS
		15	0	4.75	<13	PASS
16QAM	LCH	1	0	5.22	<13	PASS
		1	7	5.12	<13	PASS
		1	14	5.26	<13	PASS
		8	0	5.36	<13	PASS
		8	4	5.27	<13	PASS

The results shown in this test report refer only to the sample(s) tested unless otherwise stated and the sample(s) are retained for 30 days only. The document is issued by AGC, this document cannot be reproduced except in full with our prior written permission. The more details and the authenticity of the report will be confirmed at <http://www.agc-cert.com>.

		8	7	5.68	<13	PASS
		15	0	5.90	<13	PASS
	MCH	1	0	5.14	<13	PASS
		1	7	5.13	<13	PASS
		1	14	5.20	<13	PASS
		8	0	5.42	<13	PASS
		8	4	5.33	<13	PASS
		8	7	5.50	<13	PASS
		15	0	5.62	<13	PASS
	HCH	1	0	5.16	<13	PASS
		1	7	5.11	<13	PASS
		1	14	5.16	<13	PASS
		8	0	5.23	<13	PASS
		8	4	5.28	<13	PASS
		8	7	5.38	<13	PASS
15		0	5.51	<13	PASS	

Channel Bandwidth: 5 MHz

Channel Bandwidth: 5 MHz						
Modulation	Channel	RB Configuration		Peak-to-Average Ratio [dB]	Limit [dB]	Verdict
		Size	Offset			
QPSK	LCH	1	0	4.26	<13	PASS
		1	12	4.27	<13	PASS
		1	24	4.36	<13	PASS
		12	0	4.33	<13	PASS
		12	6	4.25	<13	PASS
		12	13	4.61	<13	PASS
		25	0	4.98	<13	PASS
	MCH	1	0	3.91	<13	PASS
		1	12	3.48	<13	PASS
		1	24	3.70	<13	PASS
		12	0	4.15	<13	PASS
		12	6	4.37	<13	PASS
		12	13	4.56	<13	PASS
		25	0	4.93	<13	PASS
	HCH	1	0	4.15	<13	PASS
		1	12	4.43	<13	PASS
		1	24	3.88	<13	PASS
		12	0	3.87	<13	PASS

The results shown in this test report refer only to the sample(s) tested unless otherwise stated and the sample(s) are retained for 30 days only. The document is issued by AGC, this document cannot be reproduced except in full with our prior written permission. The more details and the authenticity of the report will be confirmed at <http://www.agc-cert.com>.

16QAM		12	6	4.25	<13	PASS
		12	13	4.42	<13	PASS
		25	0	4.76	<13	PASS
	LCH	1	0	5.14	<13	PASS
		1	12	5.16	<13	PASS
		1	24	5.31	<13	PASS
		12	0	5.58	<13	PASS
		12	6	5.49	<13	PASS
		12	13	5.54	<13	PASS
		25	0	5.86	<13	PASS
	MCH	1	0	4.81	<13	PASS
		1	12	4.29	<13	PASS
		1	24	4.62	<13	PASS
		12	0	4.56	<13	PASS
		12	6	4.33	<13	PASS
		12	13	5.26	<13	PASS
		25	0	5.59	<13	PASS
	HCH	1	0	4.60	<13	PASS
		1	12	4.28	<13	PASS
		1	24	4.49	<13	PASS
		12	0	5.31	<13	PASS
		12	6	5.46	<13	PASS
		12	13	5.33	<13	PASS
		25	0	5.51	<13	PASS

Channel Bandwidth: 10 MHz

Channel Bandwidth: 20 MHz						
Modulation	Channel	RB Configuration		Peak-to-Average Ratio [dB]	Limit [dB]	Verdict
		Size	Offset			
QPSK	LCH	1	0	4.26	<13	PASS
		1	49	4.23	<13	PASS
		1	99	4.50	<13	PASS
		50	0	4.66	<13	PASS
		50	25	4.48	<13	PASS
		50	50	4.78	<13	PASS
		100	0	4.98	<13	PASS
	MCH	1	0	4.40	<13	PASS
		1	49	4.25	<13	PASS
		1	99	4.31	<13	PASS

The results shown in this test report refer only to the sample(s) tested unless otherwise stated and the sample(s) are retained for 30 days only. The document is issued by AGC, this document cannot be reproduced except in full with our prior written permission. The more details and the authenticity of the report will be confirmed at <http://www.agc-cert.com>.

		50	0	4.61	<13	PASS		
		50	25	4.31	<13	PASS		
		50	50	4.65	<13	PASS		
		100	0	5.07	<13	PASS		
	HCH	1	0	4.39	<13	PASS		
		1	49	4.44	<13	PASS		
		1	99	4.34	<13	PASS		
		50	0	4.36	<13	PASS		
		50	25	4.49	<13	PASS		
		50	50	4.63	<13	PASS		
		100	0	4.97	<13	PASS		
		16QAM	LCH	1	0	5.13	<13	PASS
				1	49	5.26	<13	PASS
1	99			5.27	<13	PASS		
50	0			5.25	<13	PASS		
50	25			5.11	<13	PASS		
50	50			5.62	<13	PASS		
100	0			5.74	<13	PASS		
MCH	1		0	4.87	<13	PASS		
	1		49	4.58	<13	PASS		
	1		99	5.08	<13	PASS		
	50		0	5.23	<13	PASS		
	50		25	5.94	<13	PASS		
	50		50	5.60	<13	PASS		
	100	0	5.78	<13	PASS			
HCH	1	0	5.15	<13	PASS			
	1	49	5.32	<13	PASS			
	1	99	5.05	<13	PASS			
	50	0	5.15	<13	PASS			
	50	25	5.23	<13	PASS			
	50	50	5.51	<13	PASS			
	100	0	5.82	<13	PASS			

Channel Bandwidth: 15 MHz

Channel Bandwidth: 15 MHz						
Modulation	Channel	RB Configuration		Peak-to-Average Ratio [dB]	Limit [dB]	Verdict
		Size	Offset			
QPSK	LCH	1	0	4.25	<13	PASS
		1	37	4.22	<13	PASS

The results shown in this test report refer only to the sample(s) tested unless otherwise stated and the sample(s) are retained for 30 days only. The document is issued by AGC, this document cannot be reproduced except in full with our prior written permission. The more details and the authenticity of the report will be confirmed at <http://www.agc-cert.com>.

		1	74	4.23	<13	PASS	
		37	0	4.56	<13	PASS	
		37	18	4.17	<13	PASS	
		37	38	4.59	<13	PASS	
		75	0	5.08	<13	PASS	
	MCH	1	0	4.44	<13	PASS	
		1	37	4.36	<13	PASS	
		1	74	4.33	<13	PASS	
		37	0	4.25	<13	PASS	
		37	18	4.18	<13	PASS	
		37	38	4.51	<13	PASS	
		75	0	4.92	<13	PASS	
	HCH	1	0	4.24	<13	PASS	
		1	37	4.34	<13	PASS	
		1	74	4.33	<13	PASS	
		37	0	4.28	<13	PASS	
		37	18	4.18	<13	PASS	
		37	38	4.44	<13	PASS	
		75	0	4.97	<13	PASS	
	16QAM	LCH	1	0	4.99	<13	PASS
			1	37	5.03	<13	PASS
1			74	5.05	<13	PASS	
37			0	5.12	<13	PASS	
37			18	5.36	<13	PASS	
37			38	5.45	<13	PASS	
75			0	5.86	<13	PASS	
MCH		1	0	5.21	<13	PASS	
		1	37	5.12	<13	PASS	
		1	74	5.06	<13	PASS	
		37	0	5.18	<13	PASS	
		37	18	5.36	<13	PASS	
		37	38	5.37	<13	PASS	
		75	0	5.61	<13	PASS	
HCH		1	0	5.17	<13	PASS	
		1	37	5.22	<13	PASS	
		1	74	5.15	<13	PASS	
		37	0	5.32	<13	PASS	
		37	18	5.28	<13	PASS	
		37	38	5.34	<13	PASS	
		75	0	5.76	<13	PASS	

The results shown in this test report refer only to the sample(s) tested unless otherwise stated and the sample(s) are retained for 30 days only. The document is issued by AGC, this document cannot be reproduced except in full with our prior written permission. The more details and the authenticity of the report will be confirmed at <http://www.agc-cert.com>.

Channel Bandwidth: 20 MHz

Channel Bandwidth: 20 MHz							
Modulation	Channel	RB Configuration		Peak-to-Average Ratio [dB]	Limit [dB]	Verdict	
		Size	Offset				
QPSK	LCH	1	0	4.26	<13	PASS	
		1	49	4.27	<13	PASS	
		1	99	4.51	<13	PASS	
		50	0	4.59	<13	PASS	
		50	25	4.33	<13	PASS	
		50	50	4.78	<13	PASS	
		100	0	4.98	<13	PASS	
	MCH	1	0	4.45	<13	PASS	
		1	49	4.28	<13	PASS	
		1	99	4.31	<13	PASS	
		50	0	4.26	<13	PASS	
		50	25	4.11	<13	PASS	
		50	50	4.65	<13	PASS	
		100	0	5.07	<13	PASS	
	HCH	1	0	4.39	<13	PASS	
		1	49	4.29	<13	PASS	
		1	99	4.34	<13	PASS	
		50	0	4.37	<13	PASS	
		50	25	4.19	<13	PASS	
		50	50	4.63	<13	PASS	
		100	0	4.97	<13	PASS	
16QAM	LCH	1	0	5.13	<13	PASS	
		1	49	5.21	<13	PASS	
		1	99	5.27	<13	PASS	
		50	0	5.28	<13	PASS	
		50	25	5.37	<13	PASS	
		50	50	5.62	<13	PASS	
		100	0	5.74	<13	PASS	
	MCH	1	0	4.87	<13	PASS	
		1	49	5.01	<13	PASS	
		1	99	5.08	<13	PASS	
		50	0	5.55	<13	PASS	
		50	25	5.49	<13	PASS	
		50	50	5.63	<13	PASS	
		100	0	5.78	<13	PASS	

The results shown in this test report refer only to the sample(s) tested unless otherwise stated and the sample(s) are retained for 30 days only. The document is issued by AGC, this document cannot be reproduced except in full with our prior written permission. The more details and the authenticity of the report will be confirmed at <http://www.agc-cert.com>.

HCH	1	0	5.15	<13	PASS
	1	49	5.28	<13	PASS
	1	99	5.05	<13	PASS
	50	0	5.43	<13	PASS
	50	25	5.38	<13	PASS
	50	50	5.51	<13	PASS
	100	0	5.82	<13	PASS

The results shown in this test report refer only to the sample(s) tested unless otherwise stated and the sample(s) are retained for 30 days only. The document is issued by AGC, this document cannot be reproduced except in full with our prior written permission. The more details and the authenticity of the report will be confirmed at <http://www.agc-cert.com>.

LTE BAND 5
Channel Bandwidth: 1.4 MHz

Channel Bandwidth: 1.4 MHz						
Modulation	Channel	RB Configuration		Peak-to-Average Ratio (dB)	Limit (dB)	Verdict
		Size	Offset			
QPSK	LCH	1	0	4.26	<13	PASS
		1	3	4.77	<13	PASS
		1	5	4.25	<13	PASS
		3	0	4.33	<13	PASS
		3	2	4.12	<13	PASS
		3	3	4.00	<13	PASS
		6	0	4.31	<13	PASS
	MCH	1	0	3.56	<13	PASS
		1	3	4.11	<13	PASS
		1	5	3.49	<13	PASS
		3	0	5.00	<13	PASS
		3	2	5.12	<13	PASS
		3	3	4.98	<13	PASS
		6	0	5.15	<13	PASS
	HCH	1	0	4.58	<13	PASS
		1	3	4.89	<13	PASS
		1	5	4.31	<13	PASS
		3	0	4.12	<13	PASS
		3	2	4.25	<13	PASS
		3	3	4.58	<13	PASS
		6	0	4.61	<13	PASS
16QAM	LCH	1	0	5.00	<13	PASS
		1	3	5.13	<13	PASS
		1	5	5.08	<13	PASS
		3	0	3.98	<13	PASS
		3	2	4.03	<13	PASS
		3	3	4.41	<13	PASS
		6	0	4.33	<13	PASS
	MCH	1	0	4.18	<13	PASS
		1	3	4.35	<13	PASS
		1	5	4.29	<13	PASS
		3	0	4.16	<13	PASS
		3	2	4.13	<13	PASS
		3	3	4.32	<13	PASS

The results shown in this test report refer only to the sample(s) tested unless otherwise stated and the sample(s) are retained for 30 days only. The document is issued by AGC, this document cannot be reproduced except in full with our prior written permission. The more details and the authenticity of the report will be confirmed at <http://www.agc-cert.com>.

	HCH	6	0	4.25	<13	PASS
		1	0	3.22	<13	PASS
		1	3	3.65	<13	PASS
		1	5	3.47	<13	PASS
		3	0	4.26	<13	PASS
		3	2	4.54	<13	PASS
		3	3	4.65	<13	PASS
		6	0	5.15	<13	PASS

Channel Bandwidth: 3 MHz

Channel Bandwidth: 3 MHz						
Modulation	Channel	RB Configuration		Peak-to-Average Ratio [dB]	Limit [dB]	Verdict
		Size	Offset			
QPSK	LCH	1	0	4.43	<13	PASS
		1	7	4.28	<13	PASS
		1	14	3.89	<13	PASS
		8	0	3.26	<13	PASS
		8	4	4.14	<13	PASS
		8	7	3.42	<13	PASS
		15	0	4.23	<13	PASS
	MCH	1	0	4.08	<13	PASS
		1	7	3.16	<13	PASS
		1	14	4.96	<13	PASS
		8	0	5.55	<13	PASS
		8	4	3.14	<13	PASS
		8	7	4.09	<13	PASS
		15	0	4.14	<13	PASS
	HCH	1	0	5.25	<13	PASS
		1	7	3.79	<13	PASS
		1	14	5.27	<13	PASS
		8	0	3.66	<13	PASS
		8	4	5.47	<13	PASS
		8	7	3.22	<13	PASS
		15	0	4.50	<13	PASS
16QAM	LCH	1	0	4.84	<13	PASS
		1	7	4.75	<13	PASS
		1	14	3.81	<13	PASS
		8	0	3.98	<13	PASS
		8	4	3.71	<13	PASS

The results shown in this test report refer only to the sample(s) tested unless otherwise stated and the sample(s) are retained for 30 days only. The document is issued by AGC, this document cannot be reproduced except in full with our prior written permission. The more details and the authenticity of the report will be confirmed at <http://www.agc-cert.com>.

		8	7	5.81	<13	PASS
		15	0	4.70	<13	PASS
	MCH	1	0	4.20	<13	PASS
		1	7	4.17	<13	PASS
		1	14	4.83	<13	PASS
		8	0	2.88	<13	PASS
		8	4	3.38	<13	PASS
		8	7	4.00	<13	PASS
		15	0	4.50	<13	PASS
	HCH	1	0	5.02	<13	PASS
		1	7	4.55	<13	PASS
		1	14	4.01	<13	PASS
		8	0	4.09	<13	PASS
		8	4	5.26	<13	PASS
		8	7	4.23	<13	PASS
15		0	3.06	<13	PASS	

Channel Bandwidth: 5 MHz

Channel Bandwidth: 5 MHz						
Modulation	Channel	RB Configuration		Peak-to-Average Ratio [dB]	Limit [dB]	Verdict
		Size	Offset			
QPSK	LCH	1	0	3.22	<13	PASS
		1	12	3.84	<13	PASS
		1	24	4.41	<13	PASS
		12	0	3.81	<13	PASS
		12	6	4.41	<13	PASS
		12	13	3.87	<13	PASS
		25	0	5.56	<13	PASS
	MCH	1	0	4.16	<13	PASS
		1	12	4.75	<13	PASS
		1	24	3.38	<13	PASS
		12	0	4.67	<13	PASS
		12	6	4.12	<13	PASS
		12	13	3.89	<13	PASS
		25	0	3.38	<13	PASS
	HCH	1	0	5.69	<13	PASS
		1	12	4.12	<13	PASS
		1	24	5.14	<13	PASS
		12	0	3.09	<13	PASS

The results shown in this test report refer only to the sample(s) tested unless otherwise stated and the sample(s) are retained for 30 days only. The document is issued by AGC, this document cannot be reproduced except in full with our prior written permission. The more details and the authenticity of the report will be confirmed at <http://www.agc-cert.com>.

		12	6	5.70	<13	PASS
		12	13	4.27	<13	PASS
		25	0	5.40	<13	PASS
16QAM	LCH	1	0	3.59	<13	PASS
		1	12	4.62	<13	PASS
		1	24	3.06	<13	PASS
		12	0	5.97	<13	PASS
		12	6	4.86	<13	PASS
		12	13	5.27	<13	PASS
		25	0	3.76	<13	PASS
	MCH	1	0	4.12	<13	PASS
		1	12	4.98	<13	PASS
		1	24	4.74	<13	PASS
		12	0	4.69	<13	PASS
		12	6	3.43	<13	PASS
		12	13	4.33	<13	PASS
		25	0	4.69	<13	PASS
	HCH	1	0	4.16	<13	PASS
		1	12	4.87	<13	PASS
		1	24	5.54	<13	PASS
		12	0	4.40	<13	PASS
		12	6	5.87	<13	PASS
		12	13	4.54	<13	PASS
		25	0	4.66	<13	PASS

Channel Bandwidth: 10 MHz

Channel Bandwidth: 10 MHz						
Modulation	Channel	RB Configuration		Peak-to-Average Ratio [dB]	Limit [dB]	Verdict
		Size	Offset			
QPSK	LCH	1	0	3.44	<13	PASS
		1	24	3.63	<13	PASS
		1	49	3.96	<13	PASS
		25	0	3.41	<13	PASS
		25	12	3.25	<13	PASS
		25	25	4.33	<13	PASS
		50	0	4.15	<13	PASS
	MCH	1	0	3.25	<13	PASS
		1	24	3.20	<13	PASS
		1	49	3.44	<13	PASS

The results shown in this test report refer only to the sample(s) tested unless otherwise stated and the sample(s) are retained for 30 days only. The document is issued by AGC, this document cannot be reproduced except in full with our prior written permission. The more details and the authenticity of the report will be confirmed at <http://www.agc-cert.com>.

		25	0	4.28	<13	PASS		
		25	12	4.03	<13	PASS		
		25	25	3.49	<13	PASS		
		50	0	4.00	<13	PASS		
	HCH	1	0	3.12	<13	PASS		
		1	24	3.46	<13	PASS		
		1	49	3.11	<13	PASS		
		25	0	3.25	<13	PASS		
		25	12	3.36	<13	PASS		
		25	25	4.24	<13	PASS		
		50	0	3.77	<13	PASS		
		16QAM	LCH	1	0	3.63	<13	PASS
				1	24	3.36	<13	PASS
1	49			3.12	<13	PASS		
25	0			3.21	<13	PASS		
25	12			3.15	<13	PASS		
25	25			3.23	<13	PASS		
50	0			4.28	<13	PASS		
MCH	1		0	3.42	<13	PASS		
	1		24	3.29	<13	PASS		
	1		49	3.45	<13	PASS		
	25		0	3.20	<13	PASS		
	25		12	4.69	<13	PASS		
	25		25	4.41	<13	PASS		
	50		0	4.22	<13	PASS		
HCH	1	0	3.89	<13	PASS			
	1	24	3.13	<13	PASS			
	1	49	3.41	<13	PASS			
	25	0	3.36	<13	PASS			
	25	12	4.16	<13	PASS			
	25	25	3.79	<13	PASS			
	50	0	4.63	<13	PASS			

The results shown in this test report refer only to the sample(s) tested unless otherwise stated and the sample(s) are retained for 30 days only. The document is issued by AGC, this document cannot be reproduced except in full with our prior written permission. The more details and the authenticity of the report will be confirmed at <http://www.agc-cert.com>.

LTE BAND 7
Channel Bandwidth: 5 MHz

Channel Bandwidth: 5 MHz						
Modulation	Channel	RB Configuration		Peak-to-Average Ratio [dB]	Limit [dB]	Verdict
		Size	Offset			
QPSK	LCH	1	0	4.32	<13	PASS
		1	12	4.26	<13	PASS
		1	24	4.25	<13	PASS
		12	0	4.44	<13	PASS
		12	6	4.77	<13	PASS
		12	13	4.69	<13	PASS
		25	0	5.07	<13	PASS
	MCH	1	0	4.33	<13	PASS
		1	12	4.46	<13	PASS
		1	24	4.35	<13	PASS
		12	0	4.96	<13	PASS
		12	6	4.88	<13	PASS
		12	13	4.72	<13	PASS
		25	0	5.07	<13	PASS
	HCH	1	0	4.43	<13	PASS
		1	12	5.03	<13	PASS
		1	24	4.16	<13	PASS
		12	0	4.89	<13	PASS
		12	6	4.63	<13	PASS
		12	13	4.72	<13	PASS
		25	0	5.13	<13	PASS
16QAM	LCH	1	0	5.17	<13	PASS
		1	12	5.23	<13	PASS
		1	24	5.13	<13	PASS
		12	0	5.49	<13	PASS
		12	6	5.47	<13	PASS
		12	13	5.55	<13	PASS
		25	0	5.86	<13	PASS
	MCH	1	0	5.26	<13	PASS
		1	12	5.31	<13	PASS
		1	24	4.97	<13	PASS
		12	0	5.13	<13	PASS
		12	6	5.15	<13	PASS
		12	13	5.66	<13	PASS

The results shown in this test report refer only to the sample(s) tested unless otherwise stated and the sample(s) are retained for 30 days only. The document is issued by AGC, this document cannot be reproduced except in full with our prior written permission. The more details and the authenticity of the report will be confirmed at <http://www.agc-cert.com>.

	HCH	25	0	5.89	<13	PASS
		1	0	5.29	<13	PASS
		1	12	5.22	<13	PASS
		1	24	5.13	<13	PASS
		12	0	5.64	<13	PASS
		12	6	5.43	<13	PASS
		12	13	5.57	<13	PASS
		25	0	5.91	<13	PASS

Channel Bandwidth: 10 MHz

Channel Bandwidth: 10 MHz						
Modulation	Channel	RB Configuration		Peak-to-Average Ratio [dB]	Limit [dB]	Verdict
		Size	Offset			
QPSK	LCH	1	0	4.31	<13	PASS
		1	24	4.28	<13	PASS
		1	49	4.28	<13	PASS
		25	0	4.52	<13	PASS
		25	12	4.59	<13	PASS
		25	25	4.64	<13	PASS
		50	0	5.01	<13	PASS
	MCH	1	0	4.53	<13	PASS
		1	24	4.15	<13	PASS
		1	49	4.31	<13	PASS
		25	0	4.84	<13	PASS
		25	12	4.66	<13	PASS
		25	25	4.78	<13	PASS
		50	0	5.03	<13	PASS
	HCH	1	0	4.27	<13	PASS
		1	24	4.21	<13	PASS
		1	49	4.18	<13	PASS
		25	0	4.39	<13	PASS
		25	12	4.46	<13	PASS
		25	25	4.78	<13	PASS
		50	0	5.15	<13	PASS
16QAM	LCH	1	0	5.07	<13	PASS
		1	24	4.89	<13	PASS
		1	49	4.91	<13	PASS
		25	0	5.78	<13	PASS
		25	12	5.37	<13	PASS

The results shown in this test report refer only to the sample(s) tested unless otherwise stated and the sample(s) are retained for 30 days only. The document is issued by AGC, this document cannot be reproduced except in full with our prior written permission. The more details and the authenticity of the report will be confirmed at <http://www.agc-cert.com>.

		25	25	5.53	<13	PASS
		50	0	5.82	<13	PASS
	MCH	1	0	5.15	<13	PASS
		1	24	5.16	<13	PASS
		1	49	5.06	<13	PASS
		25	0	5.13	<13	PASS
		25	12	5.24	<13	PASS
		25	25	5.66	<13	PASS
		50	0	5.87	<13	PASS
		HCH	1	0	5.14	<13
	1		24	5.42	<13	PASS
	1		49	5.04	<13	PASS
	25		0	5.28	<13	PASS
	25		12	5.44	<13	PASS
	25		25	5.58	<13	PASS
	50		0	5.91	<13	PASS

Channel Bandwidth: 15 MHz

Channel Bandwidth: 15 MHz						
Modulation	Channel	RB Configuration		Peak-to-Average Ratio [dB]	Limit [dB]	Verdict
		Size	Offset			
QPSK	LCH	1	0	4.28	<13	PASS
		1	37	4.24	<13	PASS
		1	74	4.33	<13	PASS
		37	0	4.25	<13	PASS
		37	18	4.29	<13	PASS
		37	38	4.64	<13	PASS
		75	0	5.21	<13	PASS
	MCH	1	0	4.38	<13	PASS
		1	37	4.33	<13	PASS
		1	74	4.32	<13	PASS
		37	0	4.37	<13	PASS
		37	18	4.77	<13	PASS
		37	38	4.72	<13	PASS
		75	0	5.17	<13	PASS
	HCH	1	0	4.08	<13	PASS
		1	37	4.21	<13	PASS
		1	74	4.12	<13	PASS
		37	0	4.39	<13	PASS

The results shown in this test report refer only to the sample(s) tested unless otherwise stated and the sample(s) are retained for 30 days only. The document is issued by AGC, this document cannot be reproduced except in full with our prior written permission. The more details and the authenticity of the report will be confirmed at <http://www.agc-cert.com>.

16QAM		37	18	4.85	<13	PASS
		37	38	4.83	<13	PASS
		75	0	5.34	<13	PASS
	LCH	1	0	5.02	<13	PASS
		1	37	5.11	<13	PASS
		1	74	4.81	<13	PASS
		37	0	5.33	<13	PASS
		37	18	5.49	<13	PASS
		37	38	5.48	<13	PASS
		75	0	5.88	<13	PASS
	MCH	1	0	5.18	<13	PASS
		1	37	5.15	<13	PASS
		1	74	4.96	<13	PASS
		37	0	5.36	<13	PASS
		37	18	5.39	<13	PASS
		37	38	5.56	<13	PASS
		75	0	5.93	<13	PASS
	HCH	1	0	4.63	<13	PASS
		1	37	4.19	<13	PASS
		1	74	5.03	<13	PASS
		37	0	5.31	<13	PASS
37		18	5.49	<13	PASS	
37		38	5.73	<13	PASS	
75		0	6.04	<13	PASS	

Channel Bandwidth: 20 MHz

Channel Bandwidth: 20 MHz						
Modulation	Channel	RB Configuration		Peak-to-Average Ratio [dB]	Limit [dB]	Verdict
		Size	Offset			
QPSK	LCH	1	0	4.25	<13	PASS
		1	49	4.44	<13	PASS
		1	99	4.32	<13	PASS
		50	0	4.25	<13	PASS
		50	25	4.36	<13	PASS
		50	50	4.74	<13	PASS
		100	0	5.01	<13	PASS
	MCH	1	0	4.36	<13	PASS
		1	49	4.48	<13	PASS
		1	99	4.15	<13	PASS

The results shown in this test report refer only to the sample(s) tested unless otherwise stated and the sample(s) are retained for 30 days only. The document is issued by AGC, this document cannot be reproduced except in full with our prior written permission. The more details and the authenticity of the report will be confirmed at <http://www.agc-cert.com>.

		50	0	4.28	<13	PASS
		50	25	4.36	<13	PASS
		50	50	4.68	<13	PASS
		100	0	4.96	<13	PASS
	HCH	1	0	4.13	<13	PASS
		1	49	4.23	<13	PASS
		1	99	4.19	<13	PASS
		50	0	4.84	<13	PASS
		50	25	4.69	<13	PASS
		50	50	4.87	<13	PASS
		100	0	5.26	<13	PASS
		16QAM	LCH	1	0	4.92
1	49			4.58	<13	PASS
1	99			4.85	<13	PASS
50	0			5.25	<13	PASS
50	25			5.55	<13	PASS
50	50			5.52	<13	PASS
100	0			5.81	<13	PASS
MCH	1			0	5.07	<13
	1		49	5.46	<13	PASS
	1		99	4.98	<13	PASS
	50		0	5.92	<13	PASS
	50		25	5.74	<13	PASS
	50		50	5.58	<13	PASS
	100		0	5.79	<13	PASS
	HCH		1	0	4.84	<13
1			49	5.33	<13	PASS
1			99	5.14	<13	PASS
50			0	5.31	<13	PASS
50			25	5.28	<13	PASS
50			50	5.68	<13	PASS
100			0	6.02	<13	PASS

The results shown in this test report refer only to the sample(s) tested unless otherwise stated and the sample(s) are retained for 30 days only. The document is issued by AGC, this document cannot be reproduced except in full with our prior written permission. The more details and the authenticity of the report will be confirmed at <http://www.agc-cert.com>.

LTE BAND 25
Channel Bandwidth: 1.4 MHz

Channel Bandwidth: 1.4 MHz						
Modulation	Channel	RB Configuration		Peak-to-Average Ratio (dB)	Limit (dB)	Verdict
		Size	Offset			
QPSK	LCH	1	0	8.36	<13	PASS
		1	3	7.96	<13	PASS
		1	5	8.43	<13	PASS
		3	0	8.44	<13	PASS
		3	2	8.16	<13	PASS
		3	3	8.48	<13	PASS
		6	0	8.49	<13	PASS
	MCH	1	0	4.44	<13	PASS
		1	3	4.31	<13	PASS
		1	5	4.47	<13	PASS
		3	0	4.59	<13	PASS
		3	2	4.33	<13	PASS
		3	3	4.57	<13	PASS
		6	0	5.17	<13	PASS
	HCH	1	0	4.61	<13	PASS
		1	3	5.02	<13	PASS
		1	5	4.41	<13	PASS
		3	0	5.30	<13	PASS
		3	2	4.96	<13	PASS
		3	3	4.46	<13	PASS
		6	0	5.24	<13	PASS
16QAM	LCH	1	0	8.47	<13	PASS
		1	3	7.99	<13	PASS
		1	5	8.41	<13	PASS
		3	0	6.96	<13	PASS
		3	2	6.48	<13	PASS
		3	3	6.36	<13	PASS
		6	0	8.44	<13	PASS
	MCH	1	0	5.17	<13	PASS
		1	3	8.01	<13	PASS
		1	5	5.06	<13	PASS
		3	0	4.96	<13	PASS
		3	2	5.65	<13	PASS
		3	3	5.45	<13	PASS

The results shown in this test report refer only to the sample(s) tested unless otherwise stated and the sample(s) are retained for 30 days only. The document is issued by AGC, this document cannot be reproduced except in full with our prior written permission. The more details and the authenticity of the report will be confirmed at <http://www.agc-cert.com>.

HCH	6	0	6.01	<13	PASS
	1	0	5.08	<13	PASS
	1	3	5.69	<13	PASS
	1	5	5.06	<13	PASS
	3	0	5.11	<13	PASS
	3	2	5.79	<13	PASS
	3	3	5.34	<13	PASS
	6	0	6.14	<13	PASS

Channel Bandwidth: 3 MHz

Channel Bandwidth: 3 MHz							
Modulation	Channel	RB Configuration		Peak-to-Average Ratio [dB]	Limit [dB]	Verdict	
		Size	Offset				
QPSK	LCH	1	0	8.52	<13	PASS	
		1	7	8.13	<13	PASS	
		1	14	8.48	<13	PASS	
		8	0	8.22	<13	PASS	
		8	4	8.36	<13	PASS	
		8	7	8.42	<13	PASS	
		15	0	8.39	<13	PASS	
	MCH	1	0	4.44	<13	PASS	
		1	7	5.00	<13	PASS	
		1	14	4.51	<13	PASS	
		8	0	5.01	<13	PASS	
		8	4	5.15	<13	PASS	
		8	7	4.96	<13	PASS	
		15	0	5.16	<13	PASS	
	HCH	1	0	4.73	<13	PASS	
		1	7	4.36	<13	PASS	
		1	14	4.07	<13	PASS	
		8	0	5.02	<13	PASS	
		8	4	4.59	<13	PASS	
		8	7	5.07	<13	PASS	
		15	0	5.34	<13	PASS	
	16QAM	LCH	1	0	8.55	<13	PASS
			1	7	8.49	<13	PASS
			1	14	8.45	<13	PASS
8			0	7.96	<13	PASS	
8			4	8.00	<13	PASS	

The results shown in this test report refer only to the sample(s) tested unless otherwise stated and the sample(s) are retained for 30 days only. The document is issued by AGC, this document cannot be reproduced except in full with our prior written permission. The more details and the authenticity of the report will be confirmed at <http://www.agc-cert.com>.

		8	7	8.42	<13	PASS
		15	0	8.36	<13	PASS
	MCH	1	0	5.22	<13	PASS
		1	7	4.96	<13	PASS
		1	14	5.12	<13	PASS
		8	0	4.39	<13	PASS
		8	4	5.12	<13	PASS
		8	7	5.82	<13	PASS
		15	0	6.11	<13	PASS
	HCH	1	0	5.17	<13	PASS
		1	7	5.69	<13	PASS
		1	14	4.61	<13	PASS
		8	0	5.31	<13	PASS
		8	4	6.12	<13	PASS
		8	7	6.19	<13	PASS
15		0	6.23	<13	PASS	

Channel Bandwidth: 5 MHz

Channel Bandwidth: 5 MHz						
Modulation	Channel	RB Configuration		Peak-to-Average Ratio [dB]	Limit [dB]	Verdict
		Size	Offset			
QPSK	LCH	1	0	8.55	<13	PASS
		1	12	7.89	<13	PASS
		1	24	8.44	<13	PASS
		12	0	8.01	<13	PASS
		12	6	7.59	<13	PASS
		12	13	8.41	<13	PASS
		25	0	8.42	<13	PASS
	MCH	1	0	4.45	<13	PASS
		1	12	4.36	<13	PASS
		1	24	4.46	<13	PASS
		12	0	4.25	<13	PASS
		12	6	4.92	<13	PASS
		12	13	4.80	<13	PASS
		25	0	5.15	<13	PASS
	HCH	1	0	4.82	<13	PASS
		1	12	4.33	<13	PASS
		1	24	4.36	<13	PASS
		12	0	4.39	<13	PASS

The results shown in this test report refer only to the sample(s) tested unless otherwise stated and the sample(s) are retained for 30 days only. The document is issued by AGC, this document cannot be reproduced except in full with our prior written permission. The more details and the authenticity of the report will be confirmed at <http://www.agc-cert.com>.

16QAM		12	6	4.5	<13	PASS
		12	13	5.18	<13	PASS
		25	0	5.57	<13	PASS
	LCH	1	0	8.42	<13	PASS
		1	12	7.56	<13	PASS
		1	24	8.47	<13	PASS
		12	0	7.45	<13	PASS
		12	6	7.36	<13	PASS
		12	13	8.38	<13	PASS
		25	0	8.43	<13	PASS
	MCH	1	0	5.05	<13	PASS
		1	12	5.11	<13	PASS
		1	24	5.03	<13	PASS
		12	0	4.59	<13	PASS
		12	6	5.31	<13	PASS
		12	13	5.68	<13	PASS
		25	0	5.96	<13	PASS
	HCH	1	0	5.50	<13	PASS
		1	12	5.11	<13	PASS
		1	24	5.06	<13	PASS
		12	0	5.28	<13	PASS
		12	6	5.39	<13	PASS
		12	13	6.09	<13	PASS
		25	0	6.38	<13	PASS

Channel Bandwidth: 10 MHz

Channel Bandwidth: 10 MHz						
Modulation	Channel	RB Configuration		Peak-to-Average Ratio [dB]	Limit [dB]	Verdict
		Size	Offset			
QPSK	LCH	1	0	8.33	<13	PASS
		1	24	8.42	<13	PASS
		1	49	8.50	<13	PASS
		25	0	7.59	<13	PASS
		25	12	8.00	<13	PASS
		25	25	8.48	<13	PASS
		50	0	8.39	<13	PASS
	MCH	1	0	4.57	<13	PASS
		1	24	5.12	<13	PASS
		1	49	4.51	<13	PASS

The results shown in this test report refer only to the sample(s) tested unless otherwise stated and the sample(s) are retained for 30 days only. The document is issued by AGC, this document cannot be reproduced except in full with our prior written permission. The more details and the authenticity of the report will be confirmed at <http://www.agc-cert.com>.

		25	0	5.13	<13	PASS		
		25	12	5.06	<13	PASS		
		25	25	4.91	<13	PASS		
		50	0	5.05	<13	PASS		
	HCH	1	0	4.66	<13	PASS		
		1	24	4.15	<13	PASS		
		1	49	4.37	<13	PASS		
		25	0	4.59	<13	PASS		
		25	12	4.63	<13	PASS		
		25	25	5.15	<13	PASS		
		50	0	5.43	<13	PASS		
		16QAM	LCH	1	0	8.49	<13	PASS
				1	24	8.64	<13	PASS
1	49			8.49	<13	PASS		
25	0			7.59	<13	PASS		
25	12			7.18	<13	PASS		
25	25			8.29	<13	PASS		
50	0			8.44	<13	PASS		
MCH	1		0	5.46	<13	PASS		
	1		24	5.11	<13	PASS		
	1		49	5.36	<13	PASS		
	25		0	5.16	<13	PASS		
	25		12	5.35	<13	PASS		
	25		25	5.73	<13	PASS		
HCH	50	0	5.94	<13	PASS			
	1	0	5.17	<13	PASS			
	1	24	4.98	<13	PASS			
	1	49	4.93	<13	PASS			
	25	0	5.32	<13	PASS			
	25	12	5.16	<13	PASS			
	25	25	6.22	<13	PASS			
50	0	6.44	<13	PASS				

The results shown in this test report refer only to the sample(s) tested unless otherwise stated and the sample(s) are retained for 30 days only. The document is issued by AGC, this document cannot be reproduced except in full with our prior written permission. The more details and the authenticity of the report will be confirmed at <http://www.agc-cert.com>.

Channel Bandwidth: 15 MHz

Channel Bandwidth: 15 MHz						
Modulation	Channel	RB Configuration		Peak-to-Average Ratio [dB]	Limit [dB]	Verdict
		Size	Offset			
QPSK	LCH	1	0	8.41	<13	PASS
		1	37	7.87	<13	PASS
		1	74	8.45	<13	PASS
		37	0	7.98	<13	PASS
		37	18	7.94	<13	PASS
		37	38	8.44	<13	PASS
		75	0	8.34	<13	PASS
	MCH	1	0	4.52	<13	PASS
		1	37	5.03	<13	PASS
		1	74	4.66	<13	PASS
		37	0	4.59	<13	PASS
		37	18	4.38	<13	PASS
		37	38	4.92	<13	PASS
		75	0	5.36	<13	PASS
	HCH	1	0	4.76	<13	PASS
		1	37	5.33	<13	PASS
		1	74	4.41	<13	PASS
		37	0	5.15	<13	PASS
		37	18	5.18	<13	PASS
		37	38	5.21	<13	PASS
		75	0	5.65	<13	PASS
16QAM	LCH	1	0	8.41	<13	PASS
		1	37	8.36	<13	PASS
		1	74	8.38	<13	PASS
		37	0	8.44	<13	PASS
		37	18	8.47	<13	PASS
		37	38	8.43	<13	PASS
		75	0	8.34	<13	PASS
	MCH	1	0	5.25	<13	PASS
		1	37	5.58	<13	PASS
		1	74	5.22	<13	PASS
		37	0	5.23	<13	PASS
		37	18	5.28	<13	PASS
		37	38	5.86	<13	PASS
		75	0	6.22	<13	PASS

The results shown in this test report refer only to the sample(s) tested unless otherwise stated and the sample(s) are retained for 30 days only. The document is issued by AGC, this document cannot be reproduced except in full with our prior written permission. The more details and the authenticity of the report will be confirmed at <http://www.agc-cert.com>.

HCH	1	0	5.88	<13	PASS
	1	37	5.74	<13	PASS
	1	74	4.89	<13	PASS
	37	0	4.25	<13	PASS
	37	18	6.11	<13	PASS
	37	38	6.21	<13	PASS
	75	0	6.32	<13	PASS

Channel Bandwidth: 20 MHz

Channel Bandwidth: 20 MHz						
Modulation	Channel	RB Configuration		Peak-to-Average Ratio [dB]	Limit [dB]	Verdict
		Size	Offset			
QPSK	LCH	1	0	8.52	<13	PASS
		1	49	7.89	<13	PASS
		1	99	8.46	<13	PASS
		50	0	7.45	<13	PASS
		50	25	7.64	<13	PASS
		50	50	8.41	<13	PASS
		100	0	8.53	<13	PASS
	MCH	1	0	4.78	<13	PASS
		1	49	5.00	<13	PASS
		1	99	4.63	<13	PASS
		50	0	4.96	<13	PASS
		50	25	4.58	<13	PASS
		50	50	4.84	<13	PASS
		100	0	5.23	<13	PASS
	HCH	1	0	4.82	<13	PASS
		1	49	5.03	<13	PASS
		1	99	4.46	<13	PASS
		50	0	4.96	<13	PASS
		50	25	5.03	<13	PASS
		50	50	5.08	<13	PASS
		100	0	5.37	<13	PASS
16QAM	LCH	1	0	8.35	<13	PASS
		1	49	7.99	<13	PASS
		1	99	8.39	<13	PASS
		50	0	8.21	<13	PASS
		50	25	8.46	<13	PASS
		50	50	8.41	<13	PASS

The results shown in this test report refer only to the sample(s) tested unless otherwise stated and the sample(s) are retained for 30 days only. The document is issued by AGC, this document cannot be reproduced except in full with our prior written permission. The more details and the authenticity of the report will be confirmed at <http://www.agc-cert.com>.

		100	0	8.39	<13	PASS
MCH		1	0	5.34	<13	PASS
		1	49	5.36	<13	PASS
		1	99	5.72	<13	PASS
		50	0	6.11	<13	PASS
		50	25	5.69	<13	PASS
		50	50	5.73	<13	PASS
		100	0	6.03	<13	PASS
	HCH		1	0	5.76	<13
		1	49	5.36	<13	PASS
		1	99	5.43	<13	PASS
		50	0	5.42	<13	PASS
		50	25	5.69	<13	PASS
		50	50	6.04	<13	PASS
		100	0	6.2	<13	PASS

The results shown in this test report refer only to the sample(s) tested unless otherwise stated and the sample(s) are retained for 30 days only. The document is issued by AGC, this document cannot be reproduced except in full with our prior written permission. The more details and the authenticity of the report will be confirmed at <http://www.agc-cert.com>.

7. SPURIOUS EMISSION

7.1 CONDUCTED SPURIOUS EMISSION

7.1.1 MEASUREMENT METHOD

The level of the carrier and the various conducted spurious and harmonic frequencies is measured by means of a calibrated spectrum analyzer. The spectrum is scanned from the lowest frequency generated in the equipment up to a frequency including its 10th harmonic. All out of band emissions are measured with a spectrum analyzer connected to the antenna terminal of the EUT while the EUT is operating at its maximum duty cycle, at maximum power, and at the appropriate frequencies. All data rates were investigated to determine the worst case configuration. All modes of operation were investigated and the worst case configuration results are reported in this section.

The minimum permissible attenuation level of any spurious emission is $43 + \log_{10}(P[\text{Watts}])$, where P is the transmitter power in Watts.

Test Procedure Used

KDB 971168 D01v03 – Section 6.0

Test Settings

1. Start frequency was set to 30MHz and stop frequency was set to at least $10 \times$ the fundamental frequency (separated into at least two plots per channel)
2. Detector = RMS
3. Trace mode = max hold
4. Sweep time = auto couple
5. The trace was allowed to stabilize
6. Please see test notes below for RBW and VBW settings

Test Setup

The EUT and measurement equipment were set up as shown in the diagram below.

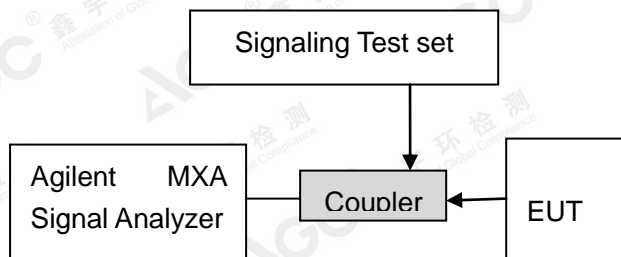

Test Instrument & Measurement Setup

shall be attenuated below the transmitter power (P, in Watts) by at least $43 + 10 \log_{10}(P)$ dB. For all power levels +30 dBm to 0 dBm, this becomes a constant specification limit of -13 dBm.

The results shown in this test report refer only to the sample(s) tested unless otherwise stated and the sample(s) are retained for 30 days only. The document is issued by AGC, this document cannot be reproduced except in full with our prior written permission. The more details and the authenticity of the report will be confirmed at <http://www.agc-cert.com>.

Test Note

Compliance with the applicable limits is based on the use of measurement instrumentation employing a resolution bandwidth of 100 kHz or greater for frequencies less than 1 GHz and 1 MHz or greater for frequencies greater than 1 GHz. However, in the 1 MHz bands immediately outside and adjacent to the frequency block a resolution bandwidth of at least one percent of the emission bandwidth of the fundamental emission of the transmitter may be employed. The emission bandwidth is defined as the width of the signal between two points, one below the carrier center frequency and one above the carrier center frequency, outside of which all emission are attenuated at least 26 dB below the transmitter power.

7.1.2 MEASUREMENT RESULT

PLEASE REFER TO: APPENDIX A TEST PLOTS FOR CONDUCTED SPURIOUS EMISSION

Note: 1. No emission found in standby or receive mode, no recording in this report.

The results shown in this test report refer only to the sample(s) tested unless otherwise stated and the sample(s) are retained for 30 days only. The document is issued by AGC, this document cannot be reproduced except in full with our prior written permission. The more details and the authenticity of the report will be confirmed at <http://www.agc-cert.com>.

7.2 RADIATED SPURIOUS EMISSION

7.2.1. MEASUREMENT PROCEDURE

1. The EUT was placed on the top of the turntable 0.8 or 1.5 meter above ground. The phase center of the receiving antenna mounted on the top of a height-variable antenna tower was placed 3 meters far away from the turntable.
2. Power on the EUT and all the supporting units. The turntable was rotated by 360 degrees to determine the position of the highest radiation.
3. The height of the broadband receiving antenna was varied between one meter and four meters above ground to find the maximum emissions field strength of both horizontal and vertical polarization.
4. For each suspected emissions, the antenna tower was scan (from 1 M to 4 M) and then the turntable was rotated (from 0 degree to 360 degrees) to find the maximum reading.
5. Set the test-receiver system to Peak or CISPR quasi-peak Detect Function with specified bandwidth under Maximum Hold Mode.
6. For emissions above 1GHz, use 1MHz VBW and RBW for peak reading. Then 1MHz RBW and 10Hz VBW for average reading in spectrum analyzer. Place the measurement antenna away from each area of the EUT determined to be a source of emissions at the specified measurement distance, while keeping the measurement antenna aimed at the source of emissions at each frequency of significant emissions, with polarization oriented for maximum response. The measurement antenna may have to be higher or lower than the EUT, depending on the radiation pattern of the emission and staying aimed at the emission source for receiving the maximum signal. The final measurement antenna elevation shall be that which maximizes the emissions. The measurement antenna elevation for maximum emissions shall be restricted to a range of heights of from 1 m to 4 m above the ground or reference ground plane.
7. When the radiated emissions limits are expressed in terms of the average value of the emissions, and pulsed operation is employed, the measurement field strength shall be determined by averaging over one complete pulse train, including blanking intervals, as long as the pulse train does not exceed 0.1 seconds. As an alternative (provided the transmitter operates for longer than 0.1 seconds) or in cases where the pulse train exceeds 0.1 seconds, the measured field strength shall be determined from the average absolute voltage during a 0.1 second interval during which the field strength is at its maximum values.
8. If the emissions level of the EUT in peak mode was 3 dB lower than the average limit specified, then testing will be stopped and peak values of EUT will be reported, otherwise, the emissions which do not have 3 dB margin will be repeated one by one using the quasi-peak method for below 1GHz.
9. For testing above 1GHz, the emissions level of the EUT in peak mode was lower than average limit (that means the emissions level in peak mode also complies with the limit in average mode), then testing will be stopped and peak values of EUT will be reported, otherwise, the emissions will be measured in average mode again and reported.
10. In case the emission is lower than 30MHz, loop antenna has to be used for measurement and the recorded data should be QP measured by receiver. High - Low scan is not required in this case.

The results shown in this test report refer only to the sample(s) tested unless otherwise stated and the sample(s) are retained for 30 days only. The document is issued by AGC, this document cannot be reproduced except in full with our prior written permission. The more details and the authenticity of the report will be confirmed at <http://www.agc-cert.com>.

7.2.2. TEST SETUP

Radiated Emission Test-Setup Frequency Below 30MHz

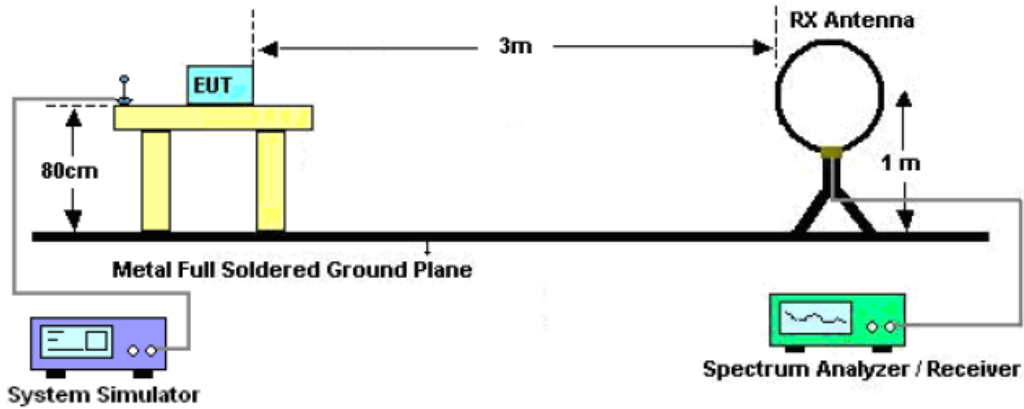

RADIATED EMISSION TEST SETUP 30MHz-1000MHz

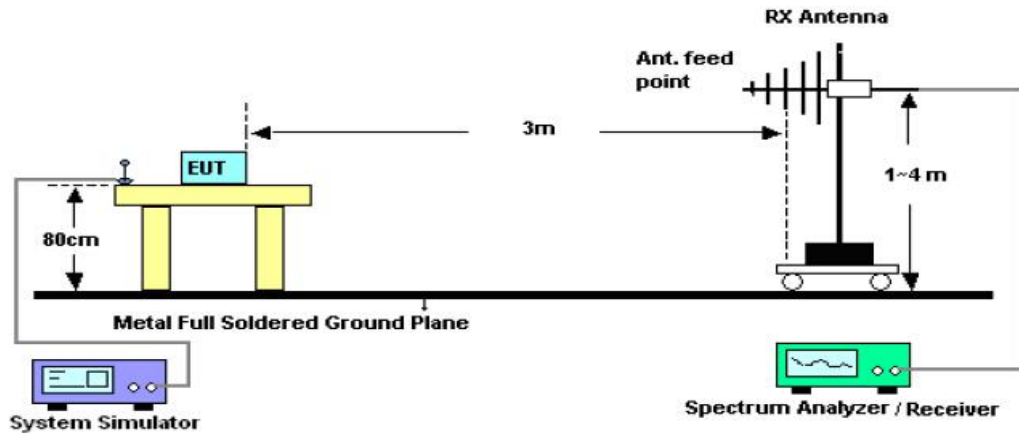

RADIATED EMISSION TEST SETUP ABOVE 1000MHz

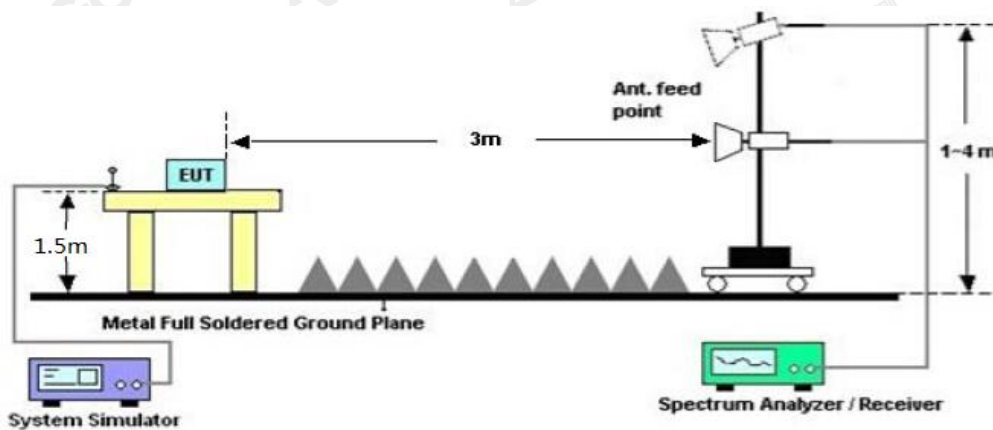

The results shown in this test report refer only to the sample(s) tested unless otherwise stated and the sample(s) are retained for 30 days only. The document is issued by AGC, this document cannot be reproduced except in full with our prior written permission. The more details and the authenticity of the report will be confirmed at <http://www.agc-cert.com>.

7.2.3 PROVISIONS APPLICABLE

(a) On any frequency outside a licensee's frequency block (e.g. A, D, B, etc.) within the USPCS spectrum, the power of any emission shall be attenuated below the transmitter power (P, in Watts) by at least $43+10\log(P)$ dB. The specification that emissions shall be attenuated below the transmitter power (P) by at least $43 + 10 \log (P)$ dB, translates in the relevant power range (1 to 0.001 W) to -13 dBm. At 1 W the specified minimum attenuation becomes 43 dB and relative to a 30 dBm (1 W) carrier becomes a limit of -13 dBm. At 0.001 W (0 dBm) the minimum attenuation is 13 dB, which again yields a limit of -13 dBm. In this way a translation of the specification from relative to absolute terms is carried out.

Note: Only record the worst condition of each test mode:

The results shown in this test report refer only to the sample(s) tested unless otherwise stated and the sample(s) are retained for 30 days only. The document is issued by AGC, this document cannot be reproduced except in full with our prior written permission. The more details and the authenticity of the report will be confirmed at <http://www.agc-cert.com>.

7.2.4 MEASUREMENT RESULT
**LTE Band 2
Low channel**

Frequency (MHz)	Polarity (H/V)	Emission Level (dBm)	Limit (dBm)	Margin (dB)
3720	V	-34.63	-13	-21.63
748.3	V	-38.87	-13	-25.87
257.2	V	-44.53	-13	-31.53
3720	H	-33.37	-13	-20.37
640.2	H	-40.49	-13	-27.49
221.4	H	-43.99	-13	-30.99

Middle channel

Frequency (MHz)	Polarity (H/V)	Emission Level (dBm)	Limit (dBm)	Margin (dB)
3760	V	-35.24	-13	-22.24
533.1	V	-40.90	-13	-27.90
256.5	V	-40.45	-13	-27.45
3760	H	-36.12	-13	-23.12
850.2	H	-42.30	-13	-29.30
451.4	H	-42.76	-13	-29.76

High channel

Frequency (MHz)	Polarity (H/V)	Emission Level (dBm)	Limit (dBm)	Margin (dB)
3800	V	-35.57	-13	-22.57
611.1	V	-40.87	-13	-27.87
256.5	V	-41.94	-13	-28.94
3800	H	-34.35	-13	-21.35
586.2	H	-40.22	-13	-27.22
351.4	H	-41.30	-13	-28.30

The results shown in this test report refer only to the sample(s) tested unless otherwise stated and the sample(s) are retained for 30 days only. The document is issued by AGC, this document cannot be reproduced except in full with our prior written permission. The more details and the authenticity of the report will be confirmed at <http://www.agc-cert.com>.

LTE Band 4
Low channel

Frequency (MHz)	Polarity (H/V)	Emission Level (dBm)	Limit (dBm)	Margin (dB)
3440	V	-34.68	-13	-21.68
896.6	V	-41.14	-13	-28.14
487.5	V	-41.88	-13	-28.88
3440	H	-35.25	-13	-22.25
789.3	H	-40.87	-13	-27.87
545.6	H	-40.64	-13	-27.64

Middle channel

Frequency (MHz)	Polarity (H/V)	Emission Level (dBm)	Limit (dBm)	Margin (dB)
3465	V	-34.70	-13	-21.70
859.4	V	-40.81	-13	-27.81
765.9	V	-42.18	-13	-29.18
3465	H	-34.54	-13	-21.54
564.5	H	-39.96	-13	-26.96
265.9	H	-40.86	-13	-27.86

High channel

Frequency (MHz)	Polarity (H/V)	Emission Level (dBm)	Limit (dBm)	Margin (dB)
3490	V	-34.12	-13	-21.12
687.4	V	-40.89	-13	-27.89
586.4	V	-41.77	-13	-28.77
3490	H	-34.91	-13	-21.91
489.5	H	-40.17	-13	-27.17
357.1	H	-41.14	-13	-28.14

The results shown in this test report refer only to the sample(s) tested unless otherwise stated and the sample(s) are retained for 30 days only. The document is issued by AGC, this document cannot be reproduced except in full with our prior written permission. The more details and the authenticity of the report will be confirmed at <http://www.agc-cert.com>.

LTE Band 5
Low channel

Frequency (MHz)	Polarity (H/V)	Emission Level (dBm)	Limit (dBm)	Margin (dB)
1658	V	-35.33	-13	-22.12
564.5	V	-40.88	-13	-27.58
364.3	V	-42.34	-13	-28.39
1658	H	-34.52	-13	-22.53
578.3	H	-40.12	-13	-26.76
354.1	H	-40.62	-13	-27.28

Middle channel

Frequency (MHz)	Polarity (H/V)	Emission Level (dBm)	Limit (dBm)	Margin (dB)
1673	V	-34.53	-13	-21.53
896.3	V	-41.09	-13	-28.09
784.1	V	-42.03	-13	-29.03
1673	H	-35.35	-13	-22.35
564.1	H	-39.56	-13	-26.56
285.6	H	-40.48	-13	-27.48

High channel

Frequency (MHz)	Polarity (H/V)	Emission Level (dBm)	Limit (dBm)	Margin (dB)
1688	V	-34.40	-13	-21.40
563.5	V	-41.19	-13	-28.19
345.1	V	-41.31	-13	-28.31
1688	H	-35.42	-13	-22.42
354.1	H	-40.67	-13	-27.67
253.6	H	-41.36	-13	-28.36

The results shown in this test report refer only to the sample(s) tested unless otherwise stated and the sample(s) are retained for 30 days only. The document is issued by AGC, this document cannot be reproduced except in full with our prior written permission. The more details and the authenticity of the report will be confirmed at <http://www.agc-cert.com>.

LTE Band 7
Low channel

Frequency (MHz)	Polarity (H/V)	Emission Level (dBm)	Limit (dBm)	Margin (dB)
3440	V	-36.61	-13	-23.61
874.61	V	-41.42	-13	-28.42
759.13	V	-43.39	-13	-30.39
3440	H	-35.16	-13	-22.16
549.66	H	-40.86	-13	-27.86
447.03	H	-41.53	-13	-28.53

Middle channel

Frequency (MHz)	Polarity (H/V)	Emission Level (dBm)	Limit (dBm)	Margin (dB)
3465	V	-35.86	-13	-22.86
561.33	V	-41.78	-13	-28.78
436.16	V	-42.28	-13	-29.28
3465	H	-35.57	-13	-22.57
343.66	H	-40.52	-13	-27.52
289.44	H	-41.95	-13	-28.95

High channel

Frequency (MHz)	Polarity (H/V)	Emission Level (dBm)	Limit (dBm)	Margin (dB)
3490	V	-35.75	-13	-22.75
536.33	V	-41.30	-13	-28.30
444.70	V	-42.20	-13	-29.20
3490	H	-35.72	-13	-22.72
318.59	H	-41.33	-13	-28.33
287.16	H	-42.43	-13	-29.43

The results shown in this test report refer only to the sample(s) tested unless otherwise stated and the sample(s) are retained for 30 days only. The document is issued by AGC, this document cannot be reproduced except in full with our prior written permission. The more details and the authenticity of the report will be confirmed at <http://www.agc-cert.com>.

LTE Band 25
Low channel

Frequency (MHz)	Polarity (H/V)	Emission Level (dBm)	Limit (dBm)	Margin (dB)
3720	V	-34.92	-13	-21.92
865.5	V	-41.39	-13	-28.39
765.3	V	-41.60	-13	-28.60
3720	H	-34.91	-13	-21.91
745.6	H	-40.40	-13	-27.40
658.2	H	-40.20	-13	-27.20

Middle channel

Frequency (MHz)	Polarity (H/V)	Emission Level (dBm)	Limit (dBm)	Margin (dB)
3765	V	-35.26	-13	-22.26
653.2	V	-41.22	-13	-28.22
532.5	V	-41.30	-13	-28.30
3765	H	-34.36	-13	-21.36
586.1	H	-39.87	-13	-26.87
483.2	H	-41.10	-13	-28.10

High channel

Frequency (MHz)	Polarity (H/V)	Emission Level (dBm)	Limit (dBm)	Margin (dB)
3810	V	-35.15	-13	-21.67
586.2	V	-40.76	-13	-27.50
486.1	V	-42.32	-13	-28.49
3810	H	-34.65	-13	-22.28
352.6	H	-39.52	-13	-27.47
258.6	H	-41.35	-13	-27.67

Note: 1. Margin = Emission Level -Limit

2. (30MHz-20GHz) Below 30MHZ no Spurious found and the QPSK modes is the worst condition.

The results shown in this test report refer only to the sample(s) tested unless otherwise stated and the sample(s) are retained for 30 days only. The document is issued by AGC, this document cannot be reproduced except in full with our prior written permission. The more details and the authenticity of the report will be confirmed at <http://www.agc-cert.com>.

8. FREQUENCY STABILITY

8.1 MEASUREMENT METHOD

In order to measure the carrier frequency under the condition of AFC lock, it is necessary to make measurements with the EUT in a "call mode". This is accomplished with the use of R&S CMW500 DIGITAL RADIO COMMUNICATION TESTER.

- 1 Measure the carrier frequency at room temperature.
- 2 Subject the EUT to overnight soak at -10°C. With the EUT, powered via nominal voltage, connected to the CMW500 and in a simulated call on channel 20175 for LTE band 4 measure the carrier frequency. These measurements should be made within 2 minutes of Powering up the EUT, to prevent significant self-warming.
- 3 Repeat the above measurements at 10°C increments from -10°C to +50°C. Allow at least 1 1/2 hours at each temperature, unpowered, before making measurements.
- 4 Re-measure carrier frequency at room temperature with nominal voltage. Vary supply voltage from minimum voltage to maximum voltage, in 0.1Volt increments re-measuring carrier frequency at each voltage. Pause at nominal voltage for 1 1/2 hours unpowered, to allow any self-heating to stabilize, before continuing.
- 5 Subject the EUT to overnight soak at +50°C.
- 6 With the EUT, powered via nominal voltage, connected to the CMW500 and in a simulated call on the centre channel, measure the carrier frequency. These measurements should be made within 2 minutes of Powering up the EUT, to prevent significant self-warming.
- 7 Repeat the above measurements at 10°C increments from +50°C to -10°C. Allow at least 1 1/2 hours at each temperature, unpowered, before making measurements.
- 8 At all temperature levels hold the temperature to +/- 0.5°C during the measurement procedure.

The results shown in this test report refer only to the sample(s) tested unless otherwise stated and the sample(s) are retained for 30 days only. The document is issued by AGC, this document cannot be reproduced except in full with our prior written permission. The more details and the authenticity of the report will be confirmed at <http://www.agc-cert.com>.

8.2 PROVISIONS APPLICABLE

8.2.1 For Hand carried battery powered equipment

Frequency stability testing is performed in accordance with the guidelines of ANSI/TIA-603-E-2016. The frequency stability of the transmitter is measured by:

- a.) Temperature: The temperature is varied from -30°C to +50°C in 10°C increments using an environmental chamber.
- b.) Primary Supply Voltage: The primary supply voltage is varied from 85% to 115% of the nominal value for non hand-carried battery and AC powered equipment. For hand-carried, battery-powered equipment, primary supply voltage is reduced to the battery operating end point which shall be specified by the manufacturer.

For Part 22, the frequency stability of the transmitter shall be maintained within $\pm 0.00025\%$ (± 2.5 ppm) of the center frequency. For Part 24 and Part 27, the frequency stability shall be sufficient to ensure that the fundamental emission stays within the authorized frequency block.

8.2.2 For equipment powered by primary supply voltage

1. The carrier frequency of the transmitter is measured at room temperature (20°C to provide a reference).
2. The equipment is turned on in a "standby" condition for fifteen minutes before applying power to the transmitter. Measurement of the carrier frequency of the transmitter is made within one minute after applying power to the transmitter.
3. Frequency measurements are made at 10°C intervals ranging from -30°C to +50°C. A period of at least one half-hour is provided to allow stabilization of the equipment at each temperature level.

The results shown in this test report refer only to the sample(s) tested unless otherwise stated and the sample(s) are retained for 30 days only. The document is issued by AGC, this document cannot be reproduced except in full with our prior written permission. The more details and the authenticity of the report will be confirmed at <http://www.agc-cert.com>.

8.3 MEASUREMENT RESULT (WORST)
LTE Band 2

Middle Channel, $f_0 = 1880$ MHz				
Temperature (°C)	Power Supplied (VDC)	Frequency Error (Hz)	Frequency Error (ppm)	Limit (ppm)
-10	3.7	-1.34	-0.000727	±2.5
0		-3.72	-0.001978	±2.5
10		-2.46	-0.001289	±2.5
20		-0.87	-0.000472	±2.5
30		-0.06	-0.001956	±2.5
40		-0.90	-0.000487	±2.5
50		-1.16	-0.000626	±2.5
55		-1.02	-0.000549	±2.5
25	4.2	-0.13	-0.000070	±2.5
	3.5	-3.91	-0.002077	±2.5

LTE Band 4

Middle Channel, $f_0 = 1732.5$ MHz				
Temperature (°C)	Power Supplied (VDC)	Frequency Error (Hz)	Frequency Error (ppm)	Limit (ppm)
-10	3.7	-0.23	-0.000134	±2.5
0		-2.50	-0.001445	±2.5
10		-4.71	-0.002683	±2.5
20		-0.34	-0.002683	±2.5
30		-2.73	-0.001557	±2.5
40		-2.26	-0.001305	±2.5
50		-4.29	-0.002477	±2.5
55		-3.02	-0.001742	±2.5
25	4.2	-2.83	-0.001635	±2.5
	3.5	-4.03	-0.002300	±2.5

The results shown in this test report refer only to the sample(s) tested unless otherwise stated and the sample(s) are retained for 30 days only. The document is issued by AGC, this document cannot be reproduced except in full with our prior written permission. The more details and the authenticity of the report will be confirmed at <http://www.agc-cert.com>.

LTE Band 5

Middle Channel, $f_0 = 836.5$ MHz				
Temperature (°C)	Power Supplied (VDC)	Frequency Error (Hz)	Frequency Error (ppm)	Limit (ppm)
-10	3.7	-2.10	-0.002550	±2.5
0		-1.07	-0.001283	±2.5
10		-1.53	-0.001856	±2.5
20		-0.46	-0.000547	±2.5
30		-1.27	-0.001544	±2.5
40		-1.67	-0.002029	±2.5
50		-2.47	-0.003001	±2.5
55		-2.05	-0.002480	±2.5
25	4.2	-0.20	-0.000239	±2.5
	3.5	-0.77	-0.000911	±2.5

LTE Band 7

Middle Channel, $f_0 = 2535$ MHz				
Temperature (°C)	Power Supplied (VDC)	Frequency Error (Hz)	Frequency Error (ppm)	Limit (ppm)
-10	3.7	1.19	0.000474	±2.5
0		-3.71	-0.001462	±2.5
10		2.29	0.000891	±2.5
20		1.00	0.000400	±2.5
30		-1.95	-0.000767	±2.5
40		-2.53	-0.000986	±2.5
50		2.93	0.001172	±2.5
55		2.98	0.001189	±2.5
25	4.2	4.19	0.001632	±2.5
	3.5	1.59	0.000635	±2.5

The results shown in this test report refer only to the sample(s) tested unless otherwise stated and the sample(s) are retained for 30 days only. The document is issued by AGC, this document cannot be reproduced except in full with our prior written permission. The more details and the authenticity of the report will be confirmed at <http://www.agc-cert.com>.