

TEST REPORT

Applicant Name: Telepower Communication Co., Ltd.
Address: 5 Bld, Zone A, Hantian Technology Town No.17 ShenHai RD,
Nanhai District Foshan China
Report Number: SZ1240308-11508E-RF-00D
FCC ID: 2AJ2B-T20C

Test Standard (s)

FCC PART 15.225

Sample Description

Product Type: Ticket Validator
Model No.: T20
Multiple Model(s) No.: T20B, T20C, T20D, T20P
Trade Mark: Telpo
Date Received: 2024/03/08
Issue Date: 2024/05/28

Test Result:	Pass▲
--------------	-------

▲ In the configuration tested, the EUT complied with the standards above.

Prepared and Checked By:

Gala Liu

Gala Liu
RF Engineer

Approved By:

Nancy Wang

Nancy Wang
RF Supervisor

Note: The information marked # is provided by the applicant, the laboratory is not responsible for its authenticity and this information can affect the validity of the result in the test report. Customer model name, addresses, names, trademarks etc. are included.

This report cannot be reproduced except in full, without prior written approval of the Company. Unless otherwise stated the results shown in this test report refer only to the sample(s) tested. This report is valid only with a valid digital signature. The digital signature may be available only under the Adobe software above version 7.0.

This report must not be used by the customer to claim product certification, approval, or endorsement by NVLAP or any agency of the U.S. Government.

This report may contain data that are not covered by the NVLAP accreditation and are marked with an asterisk "▼".

Bay Area Compliance Laboratories Corp. (Shenzhen)

5F(B-West), 6F, 7F, the 3rd Phase of Wan Li Industrial Building D, Shihua Rd, FuTian Free Trade Zone, Shenzhen, China

Tel: +86-755-33320018 Fax: +86-755-33320008 www.baclcorp.com.cn

TABLE OF CONTENTS

DOCUMENT REVISION HISTORY	4
GENERAL INFORMATION.....	5
PRODUCT DESCRIPTION FOR EQUIPMENT UNDER TEST (EUT)	5
OBJECTIVE	5
TEST METHODOLOGY	5
MEASUREMENT UNCERTAINTY	6
TEST FACILITY	6
SYSTEM TEST CONFIGURATION.....	7
DESCRIPTION OF TEST CONFIGURATION	7
EUT EXERCISE SOFTWARE	7
EQUIPMENT MODIFICATIONS	7
SUPPORT EQUIPMENT LIST AND DETAILS	7
EXTERNAL I/O CABLE.....	7
BLOCK DIAGRAM OF TEST SETUP	8
SUMMARY OF TEST RESULTS	9
TEST EQUIPMENT LIST	10
FCC§15.203 - ANTENNA REQUIREMENT.....	11
APPLICABLE STANDARD	11
ANTENNA CONNECTED CONSTRUCTION	11
FCC §1.1307 (B) & §2.1091- MPE-BASED EXEMPTION	12
APPLICABLE STANDARD	12
RESULT	13
FCC §15.207 – AC LINE CONDUCTED EMISSION	15
APPLICABLE STANDARD	15
EUT SETUP	15
EMI TEST RECEIVER SETUP.....	15
TEST PROCEDURE	16
FACTOR & OVER LIMIT CALCULATION.....	16
TEST DATA	16
FCC§15.225, §15.205& §15.209 - RADIATED EMISSIONS TEST	19
APPLICABLE STANDARD	19
EUT SETUP	19
EMI TEST RECEIVER SETUP.....	20
FACTOR & OVER LIMIT/MARGIN CALCULATION	21
TEST DATA	21
FCC§15.225(E) - FREQUENCY STABILITY.....	33
APPLICABLE STANDARD	33
TEST PROCEDURE	33
TEST DATA	33
FCC§15.215(C) - 20DBEMISSION BANDWIDTH	35
REQUIREMENT	35
TEST PROCEDURE	35
TEST DATA	36

EUT PHOTOGRAPHS.....37
TEST SETUP PHOTOGRAPHS.....38

DOCUMENT REVISION HISTORY

Revision Number	Report Number	Description of Revision	Date of Revision
0	SZ1240308-11508E-RF-00D	Original Report	2024/05/28

GENERAL INFORMATION

Product Description for Equipment under Test (EUT)

Product	Ticket Validator
Tested Model	T20
Multiple Model(s)	T20B, T20C, T20D, T20P
Frequency Range	13.56 MHz
E-field Strength	69.98dBuV/m@3m
Modulation Technique	ASK
Voltage Range	DC 9V-40V
Sample serial number	2LGK-4 (Assigned by BAACL, Shenzhen)
Sample/EUT Status	Good condition
Adapter Information	N/A
Note: The Multiple models are electrically identical with the test model except for model name. Please refer to the declaration letter [#] for more detail, which was provided by manufacturer.	

Objective

This Type approval report is in accordance with Part 2- Subpart J, and Part 15-Subparts A and C of the Federal Communication Commissions rules.

The objective is to determine the compliance of the EUT with FCC rules, section 15.203, 15.205, 15.207, 15.209 and 15.225.

Test Methodology

All measurements contained in this report were conducted with ANSI C63.10-2013, American National Standard of Procedures for Compliance Testing of Unlicensed Wireless Devices.

All emissions measurement was performed at Bay Area Compliance Laboratories Corp. (Shenzhen). The radiated testing was performed at an antenna-to-EUT distance of 3 meters.

Each test item follows test standards and with no deviation.

Measurement Uncertainty

Parameter		Uncertainty
Occupied Channel Bandwidth		±5%
RF Frequency		213.55 Hz(k=2, 95% level of confidence)
AC Power Lines Conducted Emissions	9kHz-150kHz	3.94dB(k=2, 95% level of confidence)
	150kHz-30MHz	3.84dB(k=2, 95% level of confidence)
Radiated Emissions	9kHz - 30MHz	3.30dB(k=2, 95% level of confidence)
	30MHz~200MHz (Horizontal)	4.48dB(k=2, 95% level of confidence)
	30MHz~200MHz (Vertical)	4.55dB(k=2, 95% level of confidence)
	200MHz~1000MHz (Horizontal)	4.85dB(k=2, 95% level of confidence)
	200MHz~1000MHz (Vertical)	5.05dB(k=2, 95% level of confidence)
Temperature		±1°C
Humidity		±1%
Supply voltages		±0.4%

Note: The extended uncertainty given in this report is obtained by combining the standard uncertainty times the coverage factor K with the 95% confidence interval. Otherwise required by the applicant or Product Regulations, Decision Rule in this report did not consider the uncertainty.

Test Facility

The Test site used by Bay Area Compliance Laboratories Corp. (Shenzhen) to collect test data is located on the 5F(B-West) , 6F, 7F, the 3rd Phase of Wan Li Industrial Building D, Shihua Rd, FuTian Free Trade Zone, Shenzhen, China.

The lab has been recognized as the FCC accredited lab under the KDB 974614 D01 and is listed in the FCC Public Access Link (PAL) database, FCC Registration No. : 715558, the FCC Designation No. : CN5045.

SYSTEM TEST CONFIGURATION

Description of Test Configuration

The system was configured for testing in a typical fashion (as normally used by a typical user).

EUT Exercise Software

No Exercise Software was used.

Equipment Modifications

No modification on the EUT.

Support Equipment List and Details

Manufacturer	Description	Model	Serial Number
Unknown	Adapter	Unknown	Unknown
Unknown	Socket	Unknown	Unknown
Unknown	Card	Unknown	Unknown

External I/O Cable

Cable Description	Length (m)	From Port	To
Un-shielding Un-Detachable DC Cable	1.0	EUT	Adapter
Un-shielded Detachable AC Cable	1.5	Adapter	LISN/Socket
Un-shielding Un-Detachable AC Cable	1.5	Socket	AC Mains

Block Diagram of Test Setup

For Conducted Emissions:

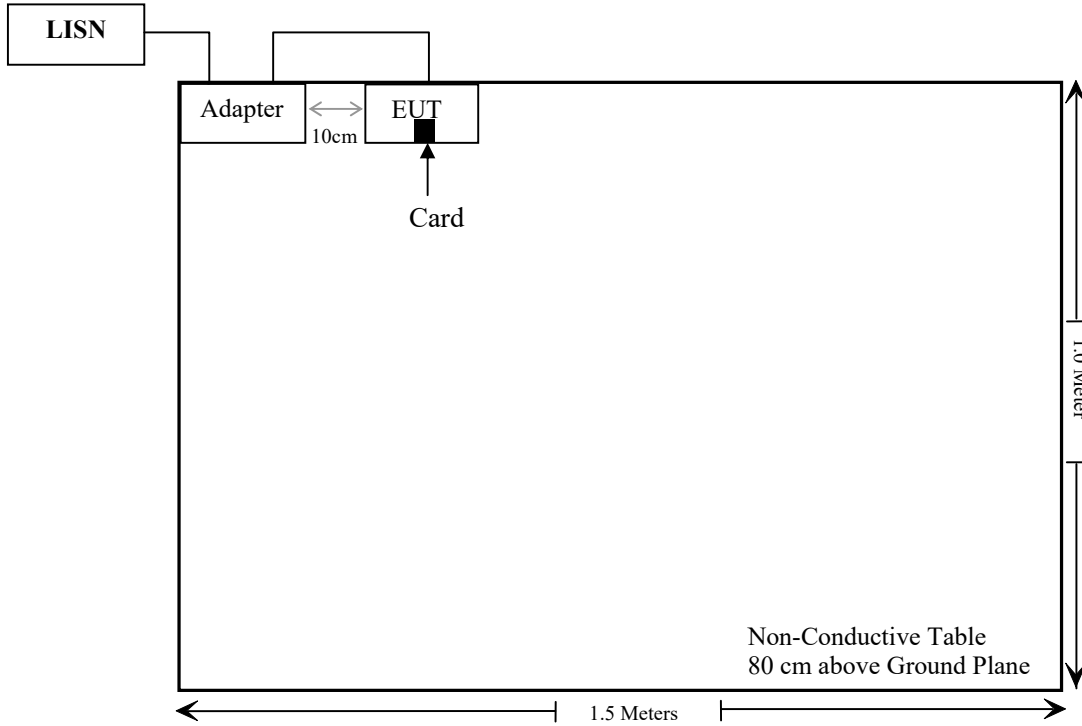

For Radiated Emissions:

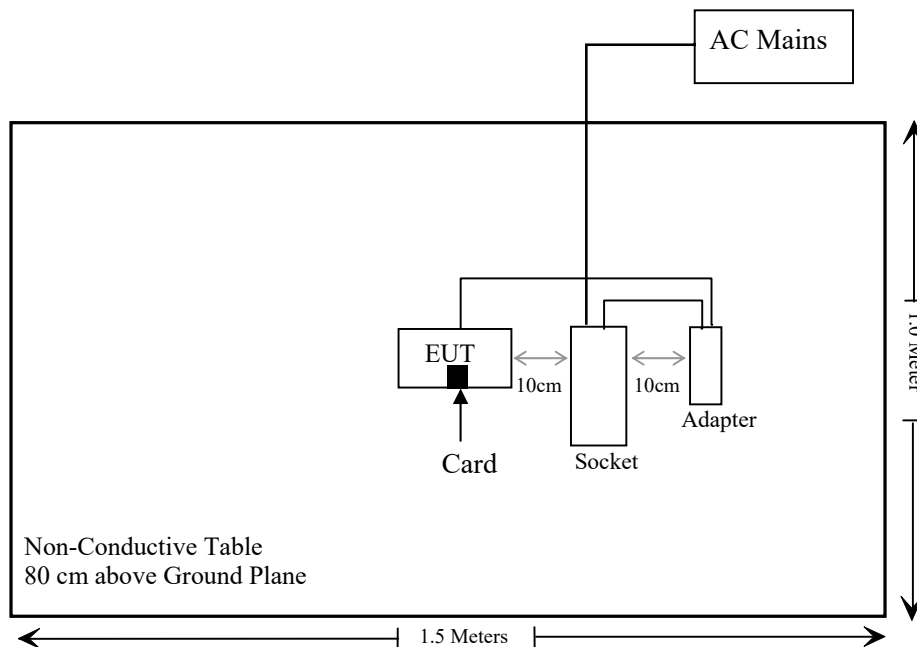

SUMMARY OF TEST RESULTS

FCC Rules	Description of Test	Result
§15.203	Antenna Requirement	Compliant
§1.1307 ,§2.1091	MPE-Based Exemption	Compliant
§15.207	AC Line Conducted Emission	Compliant
§15.225 §15.209§15.205	Radiated Emission Test	Compliant
§15.225(e)	Frequency Stability	Compliant
§15.215(c)	20dB Emission Bandwidth	Compliant

TEST EQUIPMENT LIST

Manufacturer	Description	Model	Serial Number	Calibration Date	Calibration Due Date
Conducted Emissions Test					
Rohde & Schwarz	EMI Test Receiver	ESCI	101120	2024/01/16	2025/01/15
Rohde & Schwarz	LISN	ENV216	101613	2024/01/16	2025/01/15
Rohde & Schwarz	Transient Limiter	ESH3Z2	DE25985	2023/08/03	2024/08/02
Unknown	CE Cable	CE Cable	UF A210B-1-0720-504504	2023/08/03	2024/08/02
Audix	EMI Test software	E3	191218(V9)	NCR	NCR
Radiated Emission Test					
R&S	EMI Test Receiver	ESR3	102455	2024/01/16	2025/01/15
Sonoma instrument	Pre-amplifier	310 N	186238	2023/06/08	2024/06/07
Sunol Sciences	Broadband Antenna	JB1	A040904-1	2023/07/20	2024/07/19
BACL	Active Loop Antenna	1313-1A	4031911	2024/03/21	2025/03/20
Unknown	Cable	Chamber Cable 1	F-03-EM236	2023/08/03	2024/08/02
Unknown	Cable	Chamber Cable 4	EC-007	2023/08/03	2024/08/02
Audix	EMI Test software	E3	19821b(V9)	NCR	NCR
Frequency Stability					
R&S	EMI Test Receiver	ESR3	102455	2024/01/16	2025/01/15
BACL	Temperature & Humidity Chamber	BTH-150-40	30145	2024/01/16	2025/01/15
instek	DC Power Supply	GPS-3030DD	EM832096	NCR	NCR
Fluke	Digital Multimeter	287	19000011	2023/06/08	2024/06/07

* **Statement of Traceability:** Bay Area Compliance Laboratories Corp. (Shenzhen) attests that all calibrations have been performed in accordance to requirements that traceable to National Primary Standards and International System of Units (SI).

FCC§15.203 - ANTENNA REQUIREMENT

Applicable Standard

An intentional radiator shall be designed to ensure that no antenna other than that furnished by the responsible party shall be used with the device. The use of a permanently attached antenna or of an antenna that uses a unique coupling to the intentional radiator shall be considered sufficient to comply with the provisions of this section.

Antenna Connected Construction

The EUT has one internal antenna arrangement for NFC which was permanently attached; fulfill the requirement of this section. Please refer to the EUT photos.

Result: Compliant.

FCC §1.1307 (B) & §2.1091- MPE-BASED EXEMPTION

Applicable Standard

According to subpart 2.1091 systems operating under the provisions of this section shall be operated in a manner that ensures the public is not exposed to RF energy level in excess of the communication guidelines.

According to KDB 447498 D04 Interim General RF Exposure Guidance

MPE-Based Exemption:

General frequency and separation-distance dependent MPE-based effective radiated power (ERP) thresholds are in Table B.1 [Table 1 of § 1.1307(b)(1)(i)(C)] to support an exemption from further evaluation from 300 kHz through 100 GHz.

Table 1 to § 1.1307(b)(3)(i)(C) - Single RF Sources Subject to Routine Environmental Evaluation

RF Source frequency (MHz)	Threshold ERP (watts)
0.3-1.34	1,920 R ² .
1.34-30	3,450 R ² /f ² .
30-300	3.83 R ² .
300-1,500	0.0128 R ² f.
1,500-100,000	19.2R ² .

For multiple RF sources: Multiple RF sources are exempt if:

in the case of fixed RF sources operating in the same time-averaging period, or of multiple mobile or portable RF sources within a device operating in the same time averaging period, if the sum of the fractional contributions to the applicable thresholds is less than or equal to 1 as indicated in the following equation:

$$\sum_{i=1}^a \frac{P_i}{P_{th,i}} + \sum_{j=1}^b \frac{ERP_j}{ERP_{th,j}} + \sum_{k=1}^c \frac{Evaluated_k}{Exposure Limit_k} \leq 1$$

Result

Mode	Frequency (MHz)	Tune up conducted power [#]	Antenna Gain [#]		ERP		Evaluation Distance (m)	ERP Limit (mW)
		(dBm)	(dBi)	(dBd)	(dBm)	(mW)		
BT	2402-2480	10.0	2.16	0.01	10.01	10.02	0.2	768
BLE	2402-2480	-2.5	2.16	0.01	-2.49	0.56	0.2	768
2.4G Wi-Fi	2412-2462	23.5	2.16	0.01	23.51	224.39	0.2	768
5.2G Wi-Fi	5180-5240	15.0	0	-2.15	12.85	19.28	0.2	768
GSM850*	824-849	25.98	-4.91	-7.06	18.92	77.98	0.2	422
PCS1900*	1850-1910	20.48	2.30	0.15	20.63	115.61	0.2	768
WCDMA B2	1850-1910	22.0	2.30	0.15	22.15	164.06	0.2	768
WCDMA B5	824-849	23.0	-4.91	-7.06	15.94	39.26	0.2	422
LTE B2	1850-1910	23.0	2.30	0.15	23.15	206.54	0.2	768
LTE B4	1710-1755	23.0	1.88	-0.27	22.73	187.50	0.2	768
LTE B7	2500-2570	22.0	2.95	0.8	22.8	190.55	0.2	768
LTE B38	2570-2620	22.5	3.34	1.19	23.69	233.88	0.2	768

Note: 1. The tune up conducted power and antenna gain was declared by the applicant.
 2. The BT, 2.4G Wi-Fi and 5G Wi-Fi cannot transmit at same time.
 3. 0dBd=2.15dBi

Note*: It was the time average power according to the duty cycle.

Mode		Tune-up Peak Output Power (dBm)			Tune-up Average Output Power (dBm)		
		Low	Middle	High	Low	Middle	High
GPRS850	1 slot	33.5	33.5	33.5	24.47	24.47	24.47
	2 slots	32.0	32.0	32.0	25.98	25.98	25.98
	3 slots	30.0	30.0	30.0	25.74	25.74	25.74
	4 slots	28.5	28.5	28.5	25.49	25.49	25.49
GPRS1900	1 slot	27.5	27.5	27.5	18.47	18.47	18.47
	2 slots	26.5	26.5	26.5	20.48	20.48	20.48
	3 slots	24.0	24.0	24.0	19.74	19.74	19.74
	4 slots	23.0	23.0	23.0	19.99	19.99	19.99

Note: the duty cycle for 1 slot is 1/8, 2 slots is 1/4, 3 slots is 3/8, 4 slots is 1/2
 The average power=Peak power+ duty cycle factor
 Duty cycle factor=10*log (duty cycle)

NFC:

Mode	Frequency (MHz)	Maximum E-Field (dBuV/m@3m)	Maximum EIRP (dBm)	ERP		Evaluation Distance (m)	ERP Limit (mW)
				(dBm)	(mW)		
NFC	13.56	69.98	-25.22	-27.37	0.002	0.2	751

Note: EIRP = E-Field – 95.2 @3m, ERP = EIRP-2.15

Simultaneous transmitting consideration (worst case):

The ratio= $ERP_{2.4G\ Wi-Fi}/limit + ERP_{LTE\ B38}/limit + ERP_{NFC}/limit = 224.39/768 + 233.88/768 + 0.002/751 = 0.597 < 1.0$

So simultaneous exposure is compliant.

To maintain compliance with the FCC’s RF exposure guidelines, place the equipment at least 20cm from nearby persons.

Result: Compliant

FCC §15.207 – AC LINE CONDUCTED EMISSION

Applicable Standard

FCC§15.207

EUT Setup

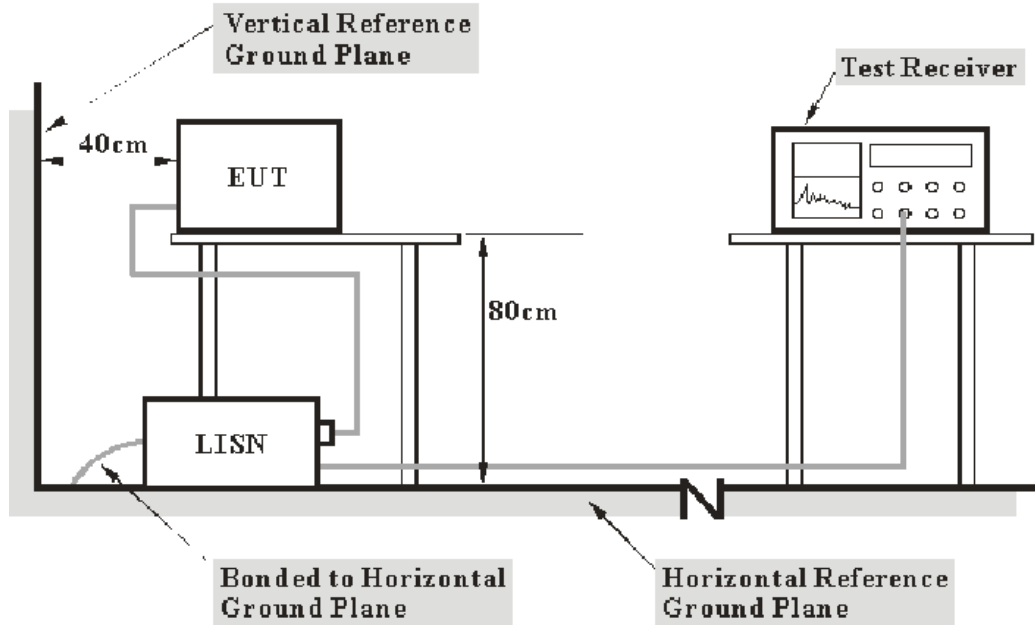

- Note: 1. Support units were connected to second LISN.
 2. Both of LISNs (AMN) 80 cm from EUT and at the least 80 cm from other units and other metal planes support units.

The setup of EUT is according with per ANSI C63.10-2013 measurement procedure. The specification used was with the FCC Part 15.207.

The external I/O cables were draped along the test table and formed a bundle 30 to 40 cm long in the middle.

The spacing between the peripherals was 10 cm.

EMI Test Receiver Setup

The EMI test receiver was set to investigate the spectrum from 150 kHz to 30MHz.

During the conducted emission test, the EMI test receiver was set with the following configurations:

Frequency Range	IF B/W
150 kHz – 30MHz	9 kHz

Test Procedure

Maximizing procedure was performed on the six (6) highest emissions of the EUT.

All final data was recorded in the Quasi-peak and average detection mode.

Factor & Over Limit Calculation

The factor is calculated by adding LISN VDF (Voltage Division Factor) and Cable Loss. The basic equation is as follows:

$$\text{Factor} = \text{LISN VDF} + \text{Cable Loss}$$

The “**Over limit**” column of the following data tables indicates the degree of compliance with the applicable limit. For example, an Over limit of -7 dB means the emission is 7 dB below the limit. The equation for calculation is as follows:

$$\begin{aligned}\text{Over Limit} &= \text{Level} - \text{Limit} \\ \text{Level} &= \text{Read Level} + \text{Factor}\end{aligned}$$

Note: The term "cable loss" refers to the combination of a cable and a 10dB transient limiter (attenuator).

Test Data

Environmental Conditions

Temperature:	26 °C
Relative Humidity:	54 %
ATM Pressure:	101 kPa

The testing was performed by Macy Shi on 2024-04-07.

Test mode: Transmitting

AC 120 V/60 Hz, Line

Date: 2024-04-07

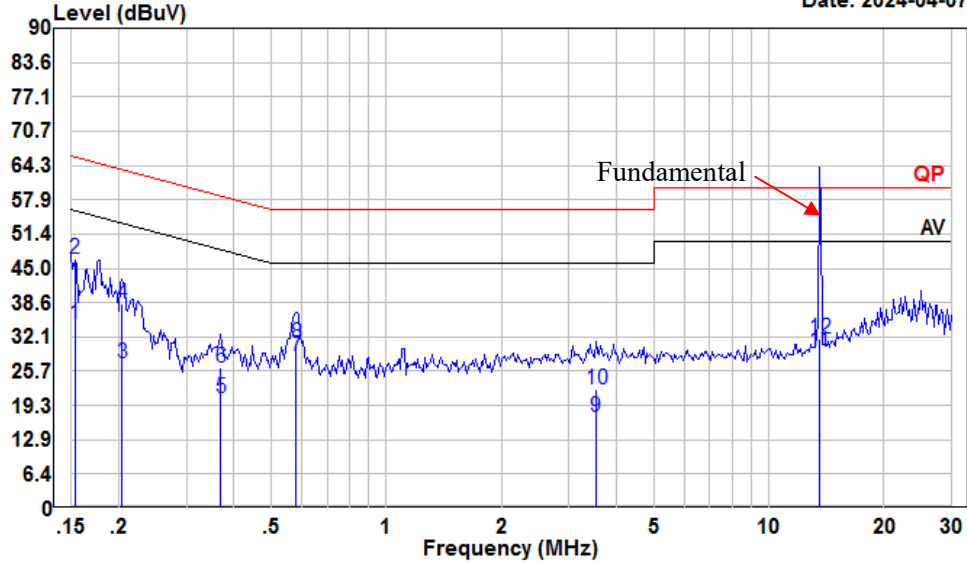

Condition: Line
 Project : SZ1240308-11508E-RF
 Tester : Macy shi
 Note : NFC Transmitting

	Read Freq	Read Level	LISN Level	LISN Factor	Cable Loss	Limit Line	Over Limit	Remark
	MHz	dBuV	dBuV	dB	dB	dBuV	dB	
1	0.15	14.02	34.57	10.40	10.15	55.82	-21.25	Average
2	0.15	26.15	46.70	10.40	10.15	65.82	-19.12	QP
3	0.20	6.83	27.33	10.40	10.10	53.45	-26.12	Average
4	0.20	17.72	38.22	10.40	10.10	63.45	-25.23	QP
5	0.37	0.27	20.72	10.27	10.18	48.52	-27.80	Average
6	0.37	5.88	26.33	10.27	10.18	58.52	-32.19	QP
7	0.58	8.15	28.65	10.29	10.21	46.00	-17.35	Average
8	0.58	10.54	31.04	10.29	10.21	56.00	-24.96	QP
9	3.53	-3.38	17.26	10.38	10.26	46.00	-28.74	Average
10	3.53	1.57	22.21	10.38	10.26	56.00	-33.79	QP
11	13.55	9.03	29.40	10.22	10.15	50.00	-20.60	Average
12	13.55	11.51	31.88	10.22	10.15	60.00	-28.12	QP

AC 120V/ 60 Hz, Neutral

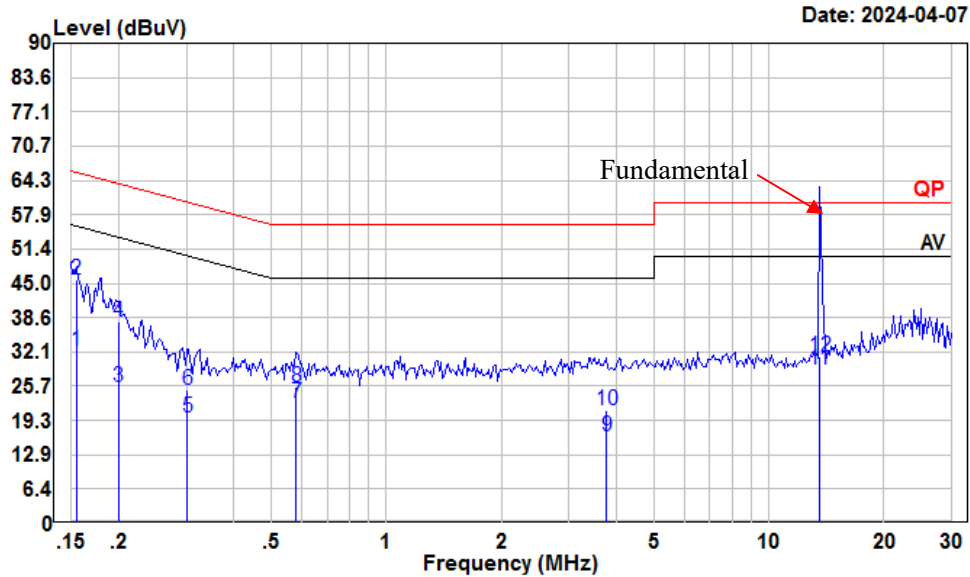

Condition: Neutral
 Project : SZ1240308-11508E-RF
 Tester : Macy shi
 Note : NFC Transmitting

	Freq	Read Level	LISN Level	LISN Factor	Cable Loss	Limit Line	Over Limit	Remark
	MHz	dBuV	dBuV	dB	dB	dBuV	dB	
1	0.15	12.10	32.49	10.24	10.15	55.74	-23.25	Average
2	0.15	25.30	45.69	10.24	10.15	65.74	-20.05	QP
3	0.20	4.95	25.64	10.60	10.09	53.62	-27.98	Average
4	0.20	17.03	37.72	10.60	10.09	63.62	-25.90	QP
5	0.30	-1.00	19.81	10.69	10.12	50.19	-30.38	Average
6	0.30	4.15	24.96	10.69	10.12	60.19	-35.23	QP
7	0.58	1.76	22.63	10.66	10.21	46.00	-23.37	Average
8	0.58	4.64	25.51	10.66	10.21	56.00	-30.49	QP
9	3.76	-4.19	16.44	10.37	10.26	46.00	-29.56	Average
10	3.76	0.62	21.25	10.37	10.26	56.00	-34.75	QP
11	13.55	8.13	28.73	10.45	10.15	50.00	-21.27	Average
12	13.55	10.63	31.23	10.45	10.15	60.00	-28.77	QP

FCC§15.225, §15.205& §15.209 - RADIATED EMISSIONS TEST

Applicable Standard

As per FCC Part 15.225

(a) The field strength of any emissions within the band 13.553–13.567 MHz shall not exceed 15,848 microvolts/meter at 30 meters.

(b) Within the bands 13.410–13.553 MHz and 13.567–13.710 MHz, the field strength of any emissions shall not exceed 334 microvolts/meter at 30 meters.

(c) Within the bands 13.110–13.410 MHz and 13.710–14.010 MHz the field strength of any emissions shall not exceed 106 microvolts/meter at 30 meters.

(d) The field strength of any emissions appearing outside of the 13.110–14.010 MHz band shall not exceed the general radiated emission limits in §15.209.

EUT Setup

9 kHz-30MHz:

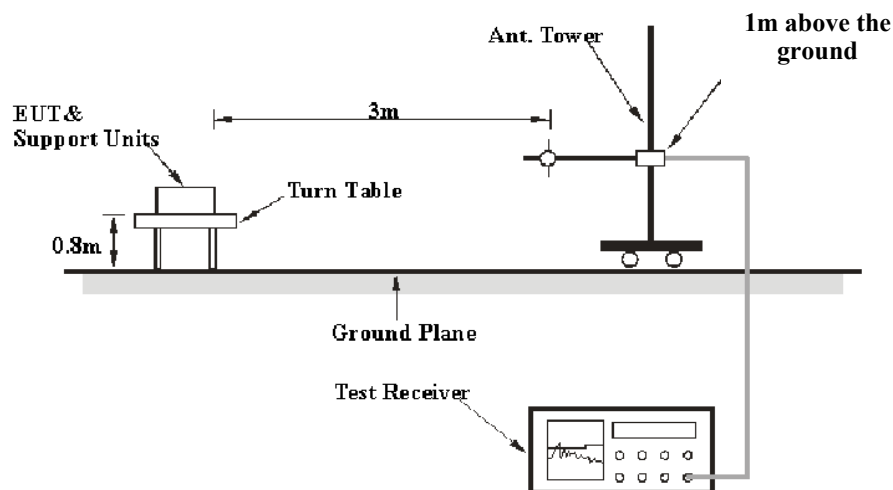

30MHz-1GHz:

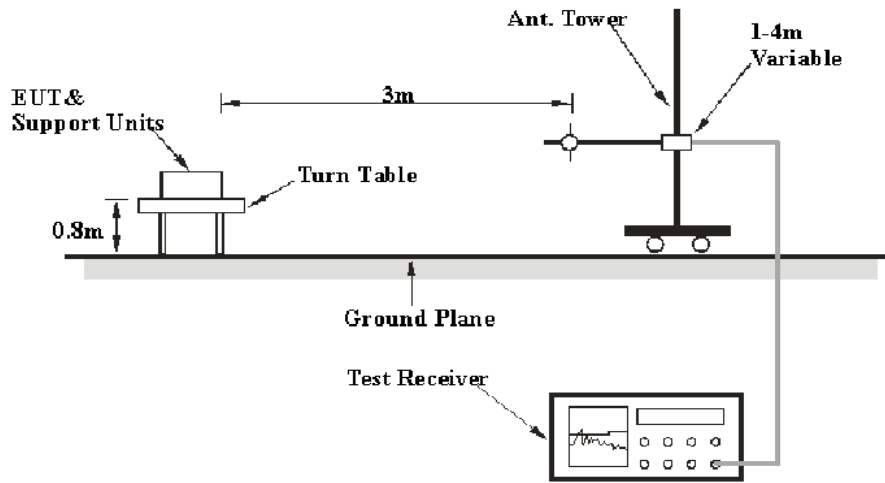

The radiated emission tests were performed in the 3-meter chamber test site, using the setup accordance with the ANSI C63.10-2013.

EMI Test Receiver Setup

According to FCC Rules, 47 CFR 15.33, the EUT emissions were investigated up to 1000 MHz.

During the radiated emission test, the EMI test Receiver was set with the following configurations:

Frequency Range	RBW	Video B/W	IF B/W	Measurement
9 kHz – 150 kHz	/	/	200 Hz	QP
	300 Hz	1 kHz	/	PK
150 kHz – 30 MHz	/	/	9 kHz	QP
	10 kHz	30 kHz	/	PK
30 MHz – 1000 MHz	/	/	120 kHz	QP
	100 kHz	300 kHz	/	PK

All final data was recorded in Quasi-peak detection mode except for the frequency bands 9–90 kHz, 110–490 kHz, average detection modes for frequency bands 9–90 kHz and 110–490 kHz.

If the maximized peak measured value complies with under the QP/Average limit more than 6dB, then it is unnecessary to perform QP/Average measurement.

Factor & Over Limit/Margin Calculation

The Level is calculated by adding the Antenna Factor and Cable Loss, and subtracting the Amplifier Gain from the Meter Reading. The basic equation is as follows:

$$\text{Factor} = \text{Antenna Factor} + \text{Cable Loss} - \text{Amplifier Gain}$$

$$\text{Level} = \text{Read Level} + \text{Factor}$$

The “**Over Limit**” column of the following data tables indicates the degree of compliance with the applicable limit. For example, an Over Limit/margin of -7dB means the emission is 7dB below the limit. The equation for calculation is as follows:

$$\text{Over Limit} = \text{Level} - \text{Limit}$$

Test Data

Environmental Conditions

Temperature:	24 °C
Relative Humidity:	56 %
ATM Pressure:	101 kPa

The testing was performed by Anson Su on 2024-04-18.

Test mode: Transmitting (Pre-scan in the X, Y and Z axes of orientation, the worst case of z-axis orientation were recorded)

1) Spurious Emissions (9 kHz~30 MHz):

Part 15 Section 15.31(f)(2) (9kHz-30MHz)
 Limit @ 3m=Limit @ 300m-40*log(3(m)/300(m))
 Limit @ 3m=Limit @ 30m-40*log(3(m)/30(m))

Ground-parallel

9 kHz~150 kHz

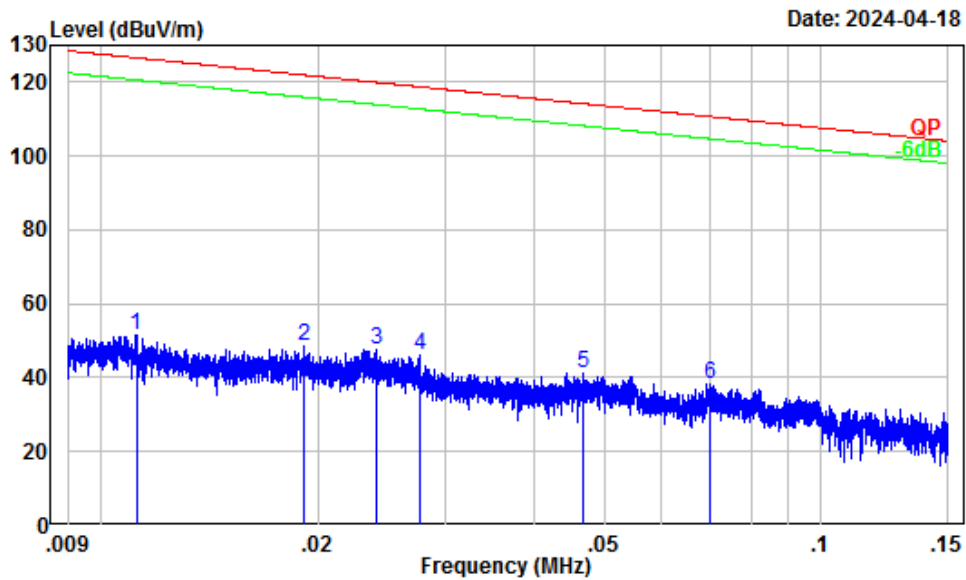

Site : Chamber A
 Condition : 3m
 Project Number: SZ1240308-11508E-RF
 Note : NFC Transmitting
 Note : Ground-parallel
 Tester : Anson Su

	Freq	Factor	Read		Limit	Over	Remark
			Level	Level	Line	Limit	
	MHz	dB/m	dBuV	dBuV/m	dBuV/m	dB	
1	0.01	37.08	14.46	51.54	126.62	-75.08	Peak
2	0.02	33.03	15.48	48.51	121.97	-73.46	Peak
3	0.02	30.49	16.99	47.48	119.96	-72.48	Peak
4	0.03	28.64	17.36	46.00	118.74	-72.74	Peak
5	0.05	23.82	17.59	41.41	114.23	-72.82	Peak
6	0.07	20.34	17.91	38.25	110.67	-72.42	Peak

150 kHz~30 MHz

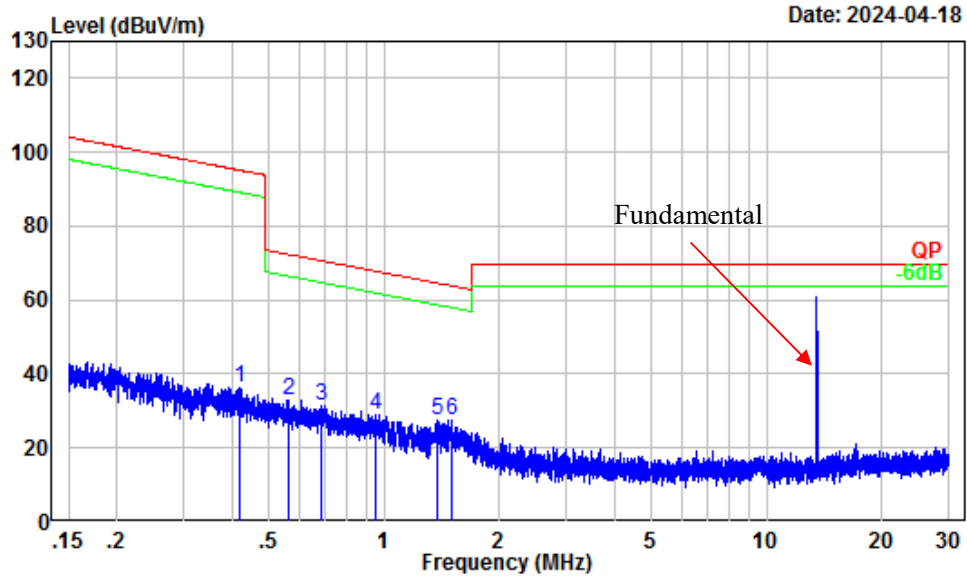

Site : Chamber A
 Condition : 3m
 Project Number: SZ1240308-11508E-RF
 Note : NFC Transmitting
 Note : Ground-parallel
 Tester : Anson Su

	Freq	Factor	Read		Limit	Over	Remark
			Level	Level	Line	Limit	
	MHz	dB/m	dBuV	dBuV/m	dBuV/m	dB	
1	0.42	5.16	31.32	36.48	95.12	-58.64	Peak
2	0.56	2.73	30.13	32.86	72.57	-39.71	Peak
3	0.69	1.22	30.38	31.60	70.78	-39.18	Peak
4	0.95	-1.24	29.99	28.75	67.90	-39.15	Peak
5	1.39	-2.93	30.61	27.68	64.58	-36.90	Peak
6	1.50	-3.34	30.78	27.44	63.86	-36.42	Peak

Perpendicular

9 kHz~150 kHz

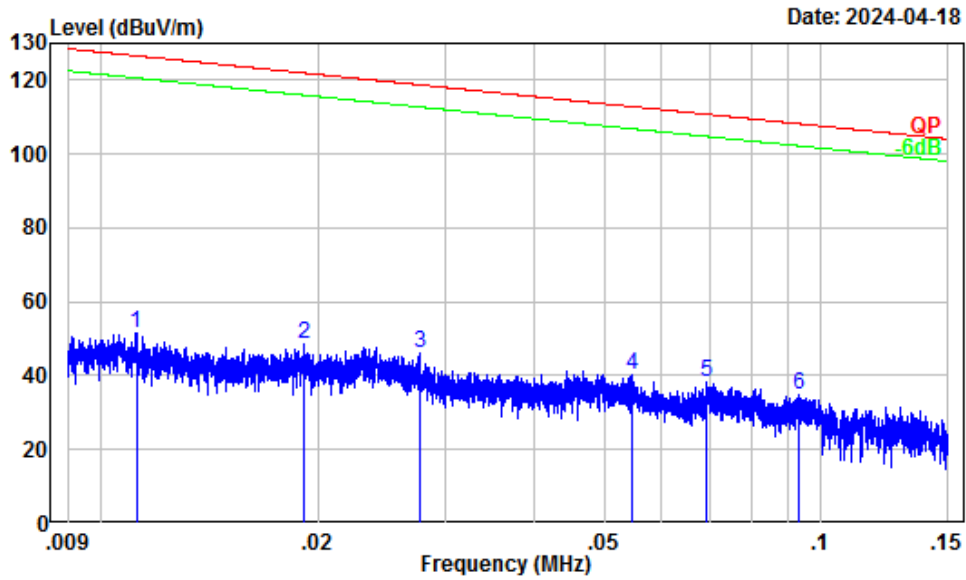

Site : Chamber A
 Condition : 3m
 Project Number: SZ1240308-11508E-RF
 Note : NFC Transmitting
 Note : Perpendicular
 Tester : Anson Su

	Freq	Factor	Read		Limit	Over	Remark
			Level	Level			
	MHz	dB/m	dBuV	dBuV/m	dBuV/m	dB	
1	0.01	37.08	14.46	51.54	126.62	-75.08	Peak
2	0.02	33.03	15.48	48.51	121.97	-73.46	Peak
3	0.03	28.64	17.36	46.00	118.74	-72.74	Peak
4	0.05	22.44	17.89	40.33	112.85	-72.52	Peak
5	0.07	20.46	17.75	38.21	110.78	-72.57	Peak
6	0.09	17.73	16.96	34.69	108.22	-73.53	Peak

150 kHz~30 MHz

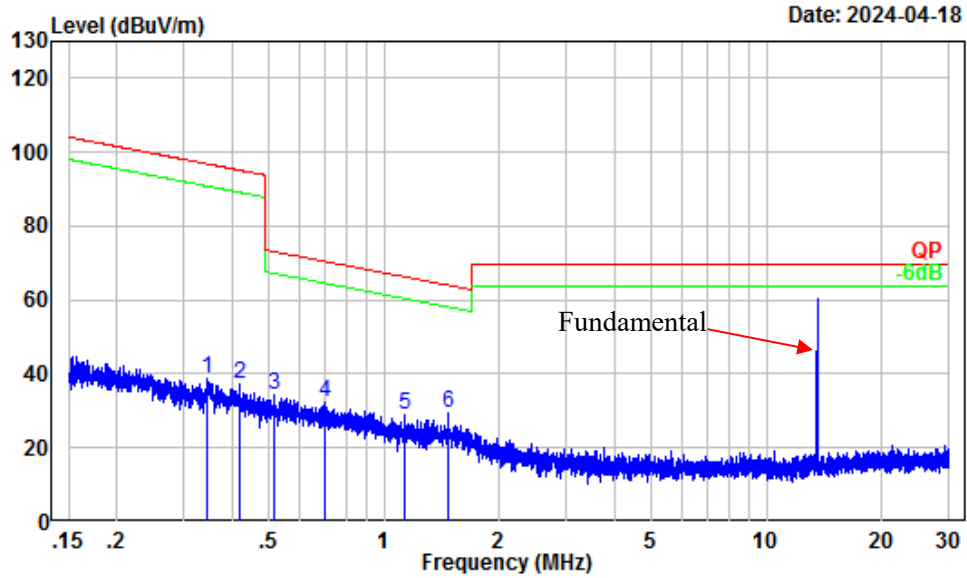

Site : Chamber A
 Condition : 3m
 Project Number: SZ1240308-11508E-RF
 Note : NFC Transmitting
 Note : Perpendicular
 Tester : Anson Su

	Freq	Factor	Read Level	Limit Level	Over Line	Over Limit	Remark
	MHz	dB/m	dBuV	dBuV/m	dBuV/m	dB	
1	0.34	6.77	32.19	38.96	96.86	-57.90	Peak
2	0.42	5.19	32.24	37.43	95.15	-57.72	Peak
3	0.51	3.30	31.06	34.36	73.36	-39.00	Peak
4	0.70	1.10	31.06	32.16	70.65	-38.49	Peak
5	1.14	-2.06	31.06	29.00	66.35	-37.35	Peak
6	1.47	-3.23	32.68	29.45	64.04	-34.59	Peak

Parallel

9 kHz~150 kHz

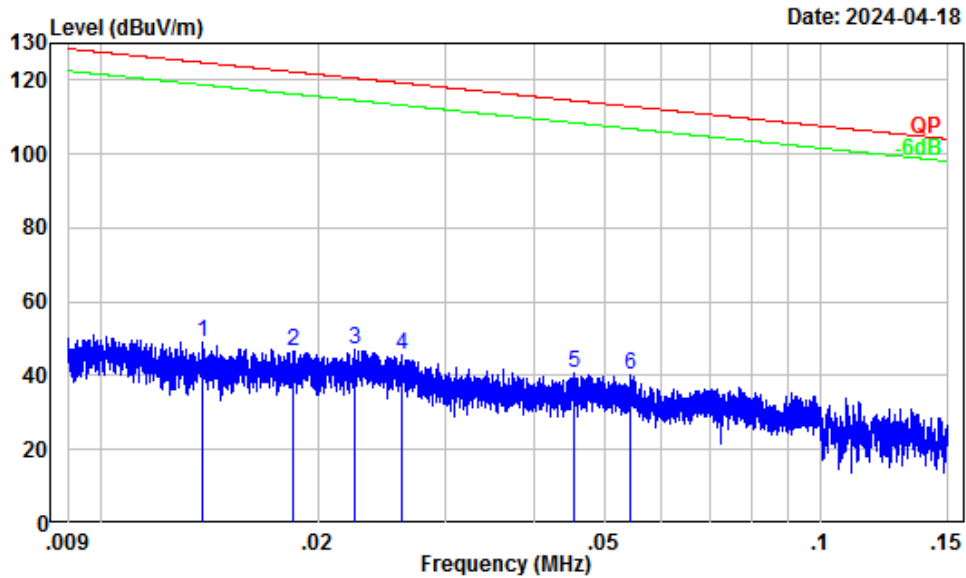

Site : Chamber A
 Condition : 3m
 Project Number: SZ1240308-11508E-RF
 Note : NFC Transmitting
 Note : Parallel
 Tester : Anson Su

	Freq	Factor	Read		Limit	Over	Remark
			Level	Level			
	MHz	dB/m	dBuV	dBuV/m	dBuV/m	dB	
1	0.01	35.72	13.27	48.99	124.77	-75.78	Peak
2	0.02	33.33	13.45	46.78	122.25	-75.47	Peak
3	0.02	31.31	15.56	46.87	120.56	-73.69	Peak
4	0.03	29.46	16.27	45.73	119.27	-73.54	Peak
5	0.05	24.07	16.55	40.62	114.45	-73.83	Peak
6	0.05	22.49	17.76	40.25	112.91	-72.66	Peak

150 kHz~30 MHz

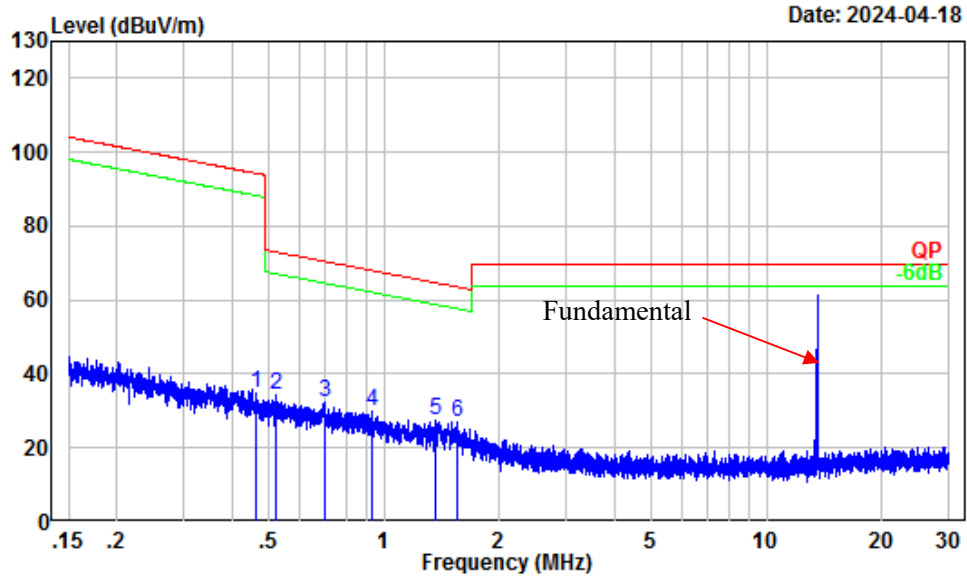

Site : Chamber A
 Condition : 3m
 Project Number: SZ1240308-11508E-RF
 Note : NFC Transmitting
 Note : Parallel
 Tester : Anson Su

	Freq	Factor	Read Level	Limit Level	Over Line	Over Limit	Remark
	MHz	dB/m	dBuV	dBuV/m	dBuV/m	dB	
1	0.46	4.26	30.74	35.00	94.29	-59.29	Peak
2	0.52	3.21	30.99	34.20	73.23	-39.03	Peak
3	0.70	1.06	31.10	32.16	70.61	-38.45	Peak
4	0.93	-1.10	31.21	30.11	68.08	-37.97	Peak
5	1.36	-2.86	30.24	27.38	64.72	-37.34	Peak
6	1.56	-3.54	30.48	26.94	63.52	-36.58	Peak

2) Emission Mask & Fundamental:

Ground-parallel

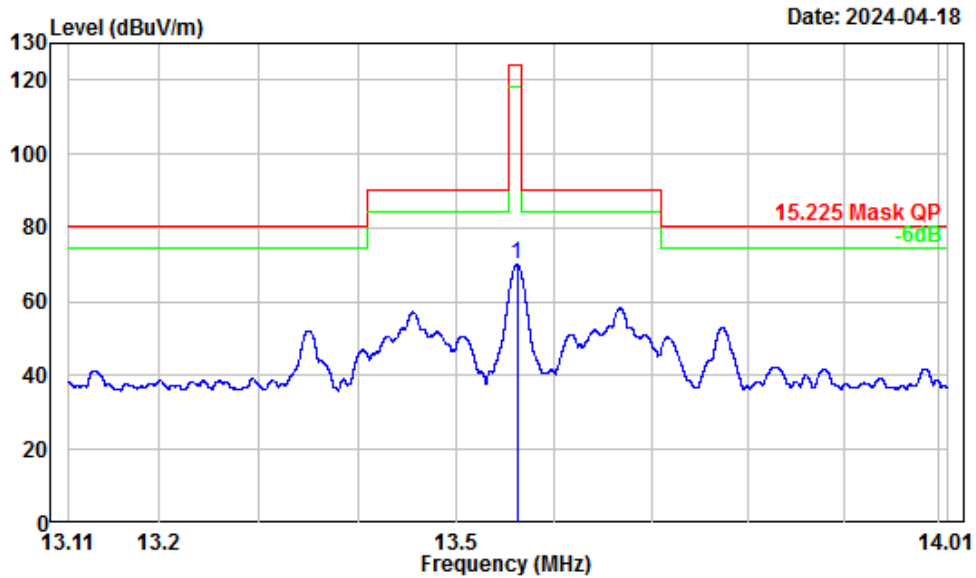

Site : Chamber A
 Condition : 3m
 Project Number: SZ1240308-11508E-RF
 Note : NFC Transmitting
 Note : Ground-parallel
 Tester : Anson Su

	Freq	Factor	Read		Limit	Over	Remark
			Level	Level	Line	Limit	
	MHz	dB/m	dBuV	dBuV/m	dBuV/m	dB	
1	13.56	-5.69	75.67	69.98	124.00	-54.02	Peak

Perpendicular

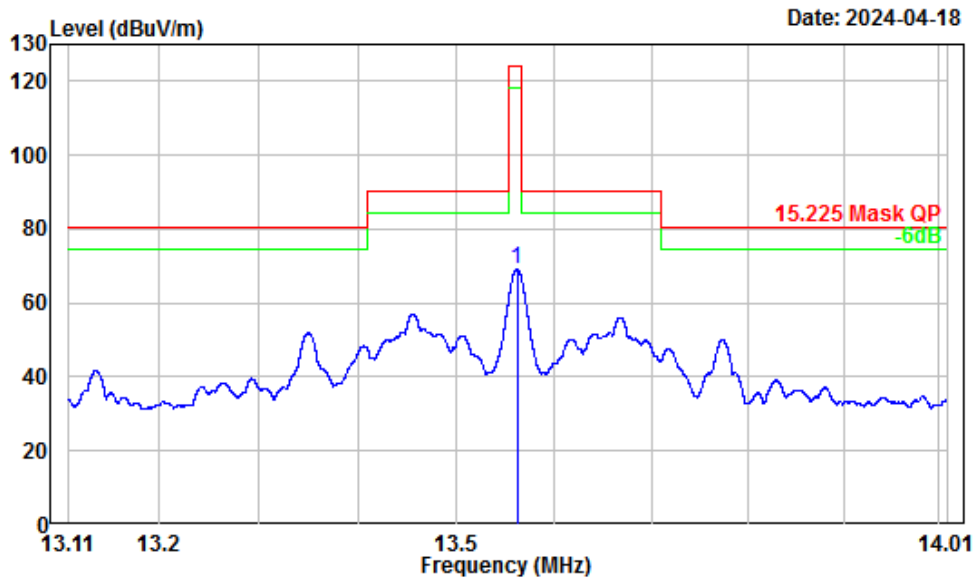

Site : Chamber A
 Condition : 3m
 Project Number: SZ1240308-11508E-RF
 Note : NFC Transmitting
 Note : Perpendicular
 Tester : Anson Su

	Read		Limit		Over	Remark
	Freq	Factor	Level	Level		
	MHz	dB/m	dBuV	dBUV/m	dBUV/m	dB
1	13.56	-5.69	74.83	69.14	124.00	-54.86 Peak

Parallel

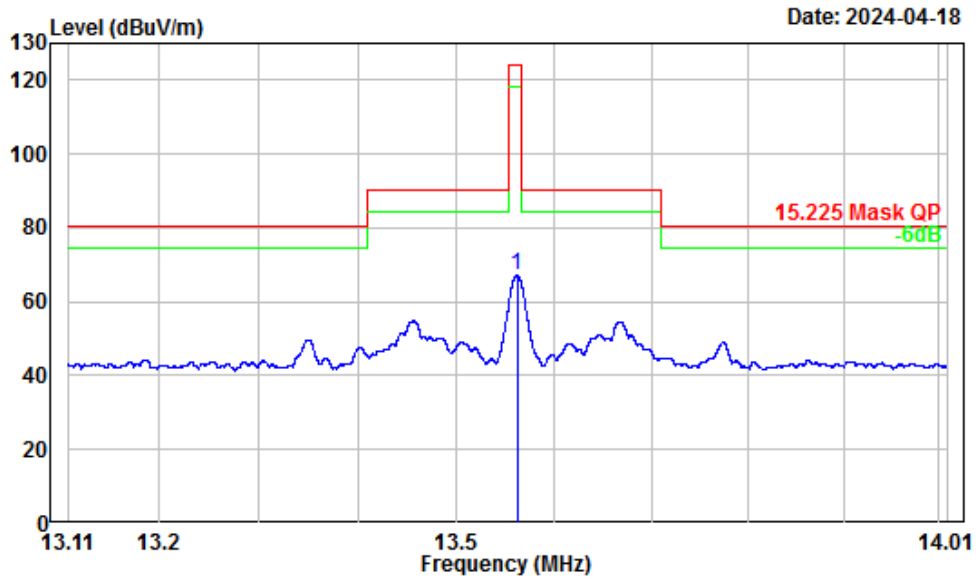

Site : Chamber A
 Condition : 3m
 Project Number: SZ1240308-11508E-RF
 Note : NFC Transmitting
 Note : Parallel
 Tester : Anson Su

	Freq	Factor	Read		Limit	Over	Remark
			Level	Level	Line	Limit	
	MHz	dB/m	dBuV	dBuV/m	dBuV/m	dB	
1	13.56	-5.69	72.81	67.12	124.00	-56.88	Peak

3) Spurious Emissions (30 MHz~1GHz):

Horizontal

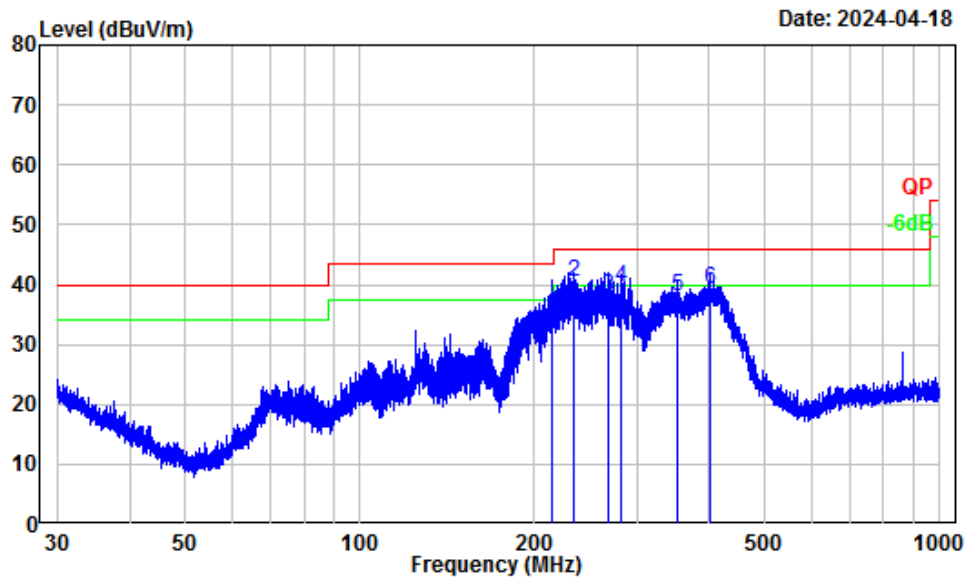

Site : Chamber A
 Condition : 3m Horizontal
 Project Number: SZ1240308-11508E-RF
 Note : NFC Transmitting
 Tester : Anson Su

	Freq	Factor	Read Level	Limit Level	Limit Line	Over Limit	Remark
	MHz	dB/m	dBuV	dBuV/m	dBuV/m	dB	
1	214.80	-13.79	48.71	34.92	43.50	-8.58	QP
2	234.07	-14.19	54.60	40.41	46.00	-5.59	QP
3	267.78	-13.91	51.80	37.89	46.00	-8.11	QP
4	282.61	-13.39	52.80	39.41	46.00	-6.59	QP
5	351.71	-11.95	50.01	38.06	46.00	-7.94	QP
6	402.72	-10.55	49.90	39.35	46.00	-6.65	QP

Vertical

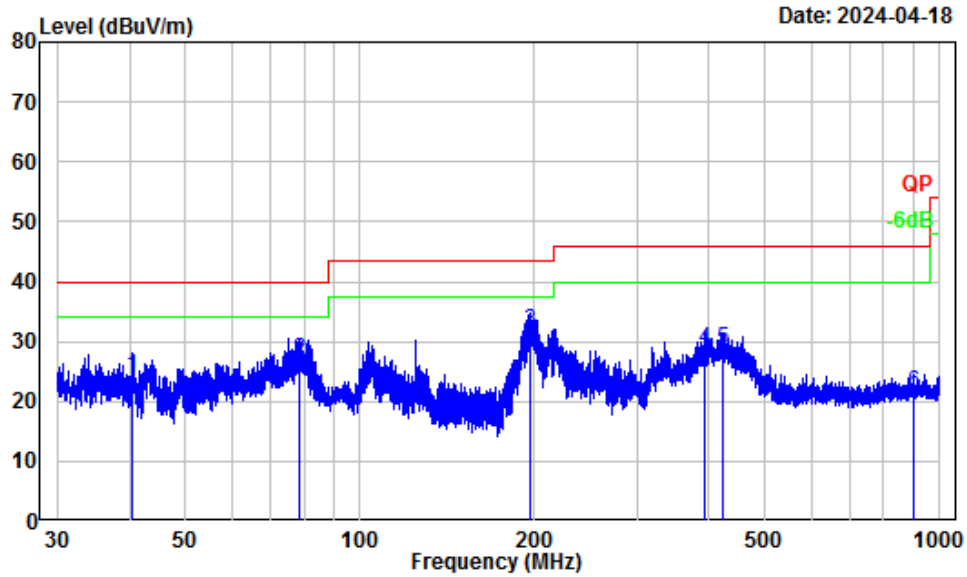

Site : Chamber A
 Condition : 3m Vertical
 Project Number: SZ1240308-11508E-RF
 Note : NFC Transmitting
 Tester : Anson Su

	Freq Factor		Read Level	Limit Level	Over Limit	Remark
	MHz	dB/m	dBuV	dBuV/m	dBuV/m	dB
1	40.52	-13.31	37.47	24.16	40.00	-15.84 QP
2	78.55	-18.73	45.75	27.02	40.00	-12.98 QP
3	196.25	-14.89	46.58	31.69	43.50	-11.81 QP
4	394.34	-10.97	39.55	28.58	46.00	-17.42 QP
5	421.50	-10.49	39.14	28.65	46.00	-17.35 QP
6	899.36	-4.85	26.21	21.36	46.00	-24.64 QP

FCC§15.225(e) - FREQUENCY STABILITY

Applicable Standard

The frequency tolerance of the carrier signal shall be maintained within $\pm 0.01\%$ of the operating frequency over a temperature variation of -20 degrees to $+50$ degrees C at normal supply voltage, and for a variation in the primary supply voltage from 85% to 115% of the rated supply voltage at a temperature of 20 degrees C. For battery operated equipment, the equipment tests shall be performed using a new battery.

Test Procedure

Frequency Stability vs. Temperature: The equipment under test was connected to an external DC power supply and inductive antenna was connected to a Spectrum Analyzer. The EUT was placed inside the temperature chamber.

After the temperature stabilized for approximately 20 minutes, the frequency output was recorded from the Spectrum Analyzer.

Frequency Stability vs. Voltage: An external DC power supply Source. The voltage was set to 115% of the nominal value and was then decreased until the transmitter light no longer illuminated; i.e., the end point. The output frequency was recorded for each voltage.

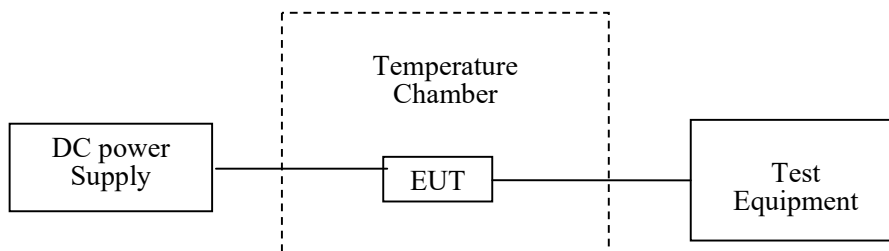

Test Data

Environmental Conditions

Temperature:	22 °C
Relative Humidity:	54 %
ATM Pressure:	101kPa

The testing was performed by Anson Su on 2024-05-21.

Test Mode: Transmitting

Test Result: Pass

Voltage Supply (V _{DC})	Temperature (°C)	Voltage (V _{DC})	Measured Frequency (MHz)	Frequency Error (%)	Part 15.225 Limit (%)
Frequency Stability vs. Temperature	-20	12	13.56121	0.0089	±0.01
	-10	12	13.56114	0.0084	±0.01
	0	12	13.56124	0.0091	±0.01
	10	12	13.56113	0.0083	±0.01
	20	12	13.56115	0.0085	±0.01
	30	12	13.56109	0.0080	±0.01
	40	12	13.56106	0.0078	±0.01
Frequency Stability vs. Voltage	50	12	13.56114	0.0084	±0.01
	20	9	13.56121	0.0089	±0.01
	20	40	13.56112	0.0083	±0.01

Note: the extreme voltage was declared by the applicant.

FCC§15.215(c) - 20dBEMISSION BANDWIDTH

Requirement

Per 15.215 (c) Intentional radiators operating under the alternative provisions to the general emission limits, as contained in §§ 15.217 through 15.257 and in Subpart E of this part, must be designed to ensure that the 20 dB bandwidth of the emission, or whatever bandwidth may otherwise be specified in the specific rule section under which the equipment operates, is contained within the frequency band designated in the rule section under which the equipment is operated. The requirement to contain the designated bandwidth of the emission within the specified frequency band includes the effects from frequency sweeping, frequency hopping and other modulation techniques that may be employed as well as the frequency stability of the transmitter over expected variations in temperature and supply voltage. If a frequency stability is not specified in the regulations, it is recommended that the fundamental emission be kept within at least the central 80% of the permitted band in order to minimize the possibility of out-of-band operation.

Test Procedure

Measure the frequency difference of two frequencies that were attenuated 20 dB from the reference level. Record the frequency difference as the emission bandwidth.

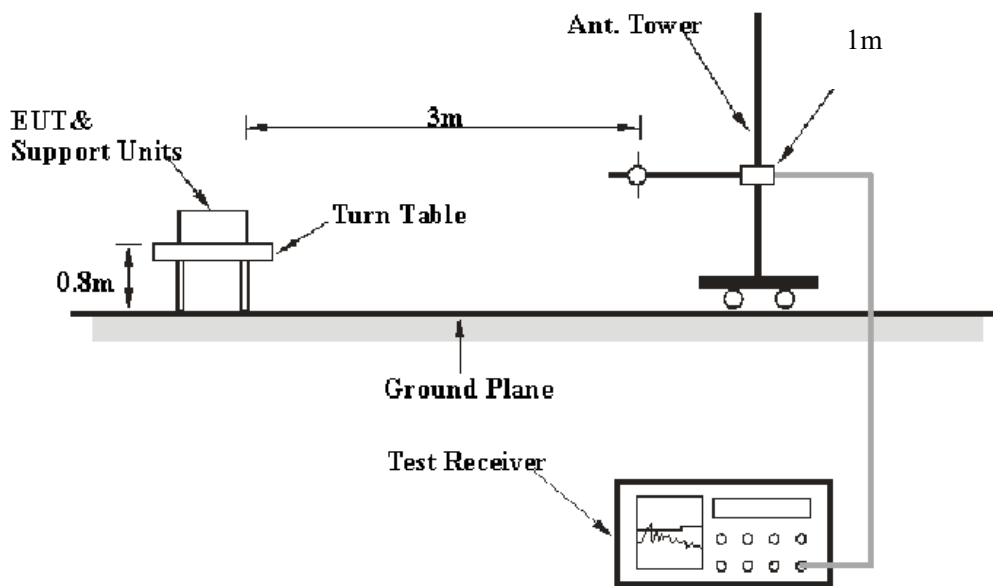

Test Data

Environmental Conditions

Temperature:	22 °C
Relative Humidity:	54 %
ATM Pressure:	101 kPa

The testing was performed by Anson Su on 2024-05-27.

Test Mode: Transmitting

Test Result: Pass

Test Frequency (MHz)	20dB Bandwidth (kHz)
13.56	0.741

20 dB Emission Bandwidth

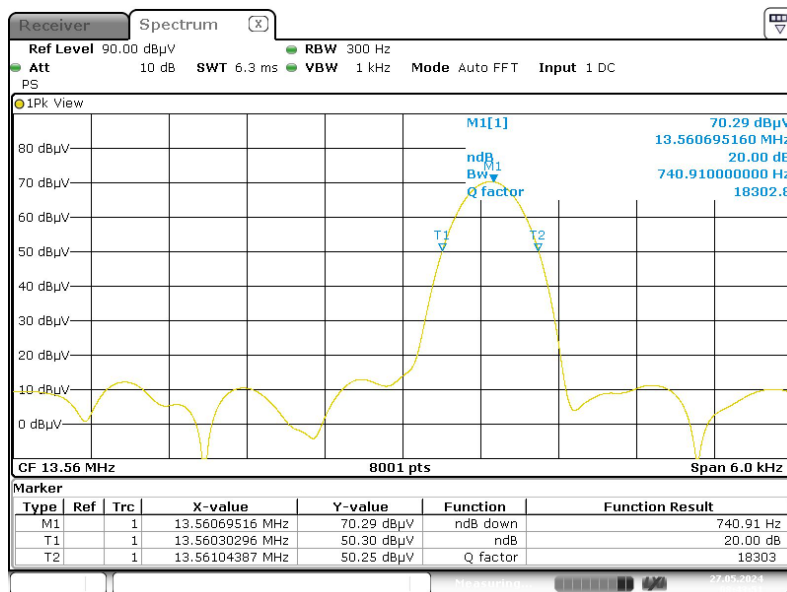

ProjectNo.:SZ1240308-11508E-RF Tester:Anson Su
 Date: 27.MAY.2024 08:43:51

EUT PHOTOGRAPHS

Please refer to the attachment SZ1240308-11508E-RF External photo and SZ1240308-11508E-RF Internal photo.

TEST SETUP PHOTOGRAPHS

Please refer to the attachment SZ1240308-11508E-RFC Test Setup photo.

******* END OF REPORT *******