



中认信通
CHINA CERTIFICATION ICT CO., LTD (DONGGUAN)



TEST REPORT

Applicant: Telepower Communication Co., Ltd.

Address: 5 Bld, Zone A, Hantian Technology Town No.17 ShenHai RD, Nanhai District
Foshan China

FCC ID: 2AJ2B-C8

Product Name: Smart Terminal

Standard(s): 47 CFR Part 15, Subpart C(15.247)
ANSI C63.10-2013
KDB 558074 D01 15.247 Meas Guidance v05r02

The above equipment has been tested and found compliant with the requirement of the relative standards by China Certification ICT Co., Ltd (Dongguan)

Report Number: CR230312413-00C

Date Of Issue: 2023/4/21

Reviewed By: Sun Zhong

Sun Zhong

Title: Manager

Test Laboratory: China Certification ICT Co., Ltd (Dongguan)
No. 113, Pingkang Road, Dalang Town, Dongguan,
Guangdong, China
Tel: +86-769-82016888

Test Facility

The Test site used by China Certification ICT Co., Ltd (Dongguan) to collect test data is located on the No. 113, Pingkang Road, Dalang Town, Dongguan, Guangdong, China.

The lab has been recognized as the FCC accredited lab under the KDB 974614 D01 and is listed in the FCC Public Access Link (PAL) database, FCC Registration No. : 442868, the FCC Designation No. : CN1314.

The lab has been recognized by Innovation, Science and Economic Development Canada to test to Canadian radio equipment requirements, the CAB identifier: CN0123.

Declarations

China Certification ICT Co., Ltd (Dongguan) is not responsible for the authenticity of any test data provided by the applicant. Data included from the applicant that may affect test results are marked with a triangle symbol “▲”. Customer model name, addresses, names, trademarks etc. are not considered data.

Unless otherwise stated the results shown in this test report refer only to the sample(s) tested.

This report cannot be reproduced except in full, without prior written approval of the Company.

This report is valid only with a valid digital signature. The digital signature may be available only under the Adobe software above version 7.0.

This report may contain data that are not covered by the accreditation scope and shall be marked with an asterisk “★”.

CONTENTS

TEST FACILITY	2
DECLARATIONS.....	2
DOCUMENT REVISION HISTORY	5
1. GENERAL INFORMATION.....	6
1.1 PRODUCT DESCRIPTION FOR EQUIPMENT UNDER TEST (EUT)	6
1.2 DESCRIPTION OF TEST CONFIGURATION.....	7
1.2.1 EUT Operation Condition:.....	7
1.2.2 Support Equipment List and Details	7
1.2.3 Support Cable List and Details	7
1.2.4 Block Diagram of Test Setup.....	8
1.3 MEASUREMENT UNCERTAINTY	9
2. SUMMARY OF TEST RESULTS.....	10
3. REQUIREMENTS AND TEST PROCEDURES	11
3.1 AC LINE CONDUCTED EMISSIONS.....	11
3.1.1 Applicable Standard.....	11
3.1.2 EUT Setup.....	12
3.1.3 EMI Test Receiver Setup	12
3.1.4 Test Procedure	13
3.1.5 Corrected Amplitude & Margin Calculation.....	13
3.2 RADIATED SPURIOUS EMISSIONS.....	14
3.2.1 Applicable Standard.....	14
3.2.2 EUT Setup.....	14
3.2.3 EMI Test Receiver & Spectrum Analyzer Setup	15
3.2.4 Test Procedure	15
3.2.5 Corrected Amplitude & Margin Calculation.....	15
3.3 20 DB EMISSION BANDWIDTH	16
3.3.1 Applicable Standard.....	16
3.3.2 EUT Setup.....	16
3.3.3 Test Procedure	16
3.4 CHANNEL SEPARATION	18
3.4.1 Applicable Standard.....	18
3.4.2 EUT Setup.....	18
3.4.3 Test Procedure	18
3.5 NUMBER OF HOPPING FREQUENCY	19
3.5.1 Applicable Standard.....	19
3.5.2 EUT Setup.....	19
3.5.3 Test Procedure	19
3.6 TIME OF OCCUPANCY(DWELL TIME).....	20
3.6.1 Applicable Standard.....	20
3.6.2 EUT Setup.....	20
3.6.3 Test Procedure	20

3.7 MAXIMUM CONDUCTED OUTPUT POWER.....21
3.7.1 Applicable Standard.....21
3.7.2 EUT Setup.....21
3.7.3 Test Procedure21
3.8 100 KHZ BANDWIDTH OF FREQUENCY BAND EDGE.....22
3.8.1 Applicable Standard.....22
3.8.2 EUT Setup.....22
3.8.3 Test Procedure22
3.9 ANTENNA REQUIREMENT.....23
3.9.1 Applicable Standard.....23
3.9.2 Judgment.....23
4. TEST DATA AND RESULTS 24
4.1 AC LINE CONDUCTED EMISSIONS.....24
4.2 RADIATED SPURIOUS EMISSIONS.....27
4.3 20 DB EMISSION BANDWIDTH:33
4.4 CHANNEL SEPARATION:37
4.5 NUMBER OF HOPPING FREQUENCY:41
4.6 TIME OF OCCUPANCY(DWELL TIME):.....43
4.7 MAXIMUM CONDUCTED OUTPUT POWER:47
4.8 100 KHZ BANDWIDTH OF FREQUENCY BAND EDGE:51
5. RF EXPOSURE EVALUATION 58
5.1 APPLICABLE STANDARD.....58
5.2 PROCEDURE.....58
5.3 MEASUREMENT RESULT58

DOCUMENT REVISION HISTORY

Revision Number	Report Number	Description of Revision	Date of Revision
1.0	CR230312413-00C	Original Report	2023/4/21

1. GENERAL INFORMATION

1.1 Product Description for Equipment under Test (EUT)

EUT Name:	Smart Terminal
EUT Model:	C8
Operation Frequency:	2402-2480 MHz
Maximum Peak Output Power (Conducted):	-0.38 dBm
Modulation Type:	GFSK, $\pi/4$ -DQPSK, 8DPSK
Rated Input Voltage:	12Vdc from Adapter
Serial Number:	237R-1
EUT Received Date:	2023/3/28
EUT Received Status:	Good

Operation Frequency Detail:

Channel	Frequency (MHz)	Channel	Frequency (MHz)
0	2402	40	2442
1	2404	41	2443
...
...
...	...	78	2480
39	2441	/	/

Per section 15.31(m), the below frequencies were performed the test as below:

Test Channel	Frequency (MHz)
Lowest	2402
Middle	2441
Highest	2480

Antenna Information Detail▲:

Antenna Type	input impedance (Ohm)	Frequency Range	Antenna Gain
FPC	50	2.4~2.5GHz	3.7 dBi

The Method of §15.203 Compliance:

- Antenna must be permanently attached to the unit.
- Antenna must use a unique type of connector to attach to the EUT.
- Unit must be professionally installed, and installer shall be responsible for verifying that the correct antenna is employed with the unit.

Accessory Information:

Accessory Description	Manufacturer	Model
Adapter	Dong Guan Royal Intelligent Co.,Ltd	BI36L-120300-AdU

1.2 Description of Test Configuration

1.2.1 EUT Operation Condition:

EUT Operation Mode:	The system was configured for testing in Engineering Mode, which was provided by the manufacturer.		
Equipment Modifications:	No		
EUT Exercise Software:	BlueTest3		
The software was provided by manufacturer. The maximum power was configured as below, that was provided by the manufacturer▲:			
Test Modes	Power Level Setting		
	Lowest	Middle	Highest
GFSK	0	0	0
$\pi/4$ -DQPSK	0	0	0
8DPSK	0	0	0

1.2.2 Support Equipment List and Details

Manufacturer	Description	Model	Serial Number
Lenovo	Laptop	T460S	60PDTEK8
IPRO	Earphone	Phonenix 5.0s	EP221126001
SanDisk	USB Disk	16 GB	BL201026210Z
Kingston	USB Disk	DTI/2GB	CH 031308
PHILIPS	Keyboard	SPT6234	K234210510746
PHILIPS	Mouse	SPT6234	C234210506222
Unknown	Load	Unknown	Unknown
Unknown	Cashbox	Unknown	Unknown
TP-LINK	Router	TP-5620	Unknown

1.2.3 Support Cable List and Details

Cable Description	Shielding Type	Ferrite Core	Length (m)	From Port	To
RJ11 Cable	NO	NO	0.8	EUT	Load
Radio Cable	NO	NO	1	EUT	Earphone
Mouse Line	NO	NO	1	EUT	Mouse
Keyboard Line	NO	NO	1	EUT	Keyboard
USB Cable	NO	NO	1	EUT	Laptop
RJ12 Cable	NO	NO	1.5	EUT	cashbox
RJ45 Cable	Yes	NO	10	EUT	Router

1.2.4 Block Diagram of Test Setup

AC line conducted emissions:

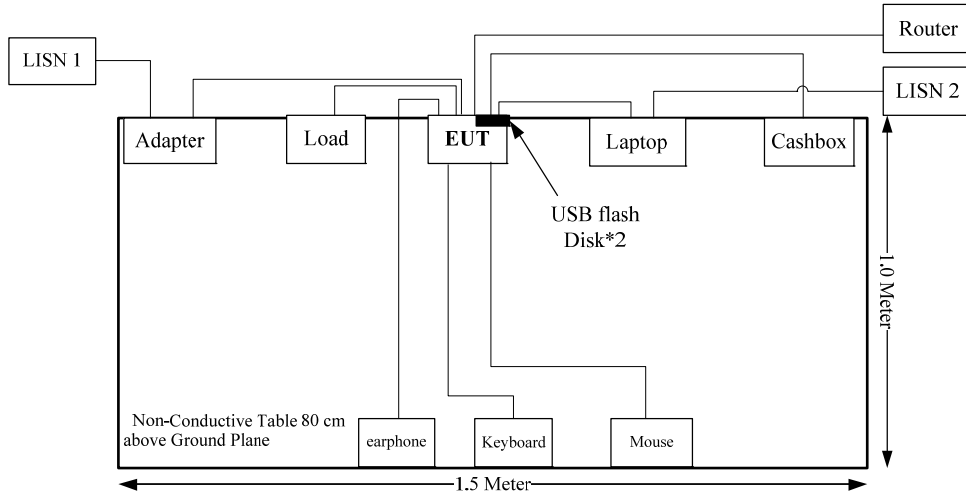

Spurious Emissions:

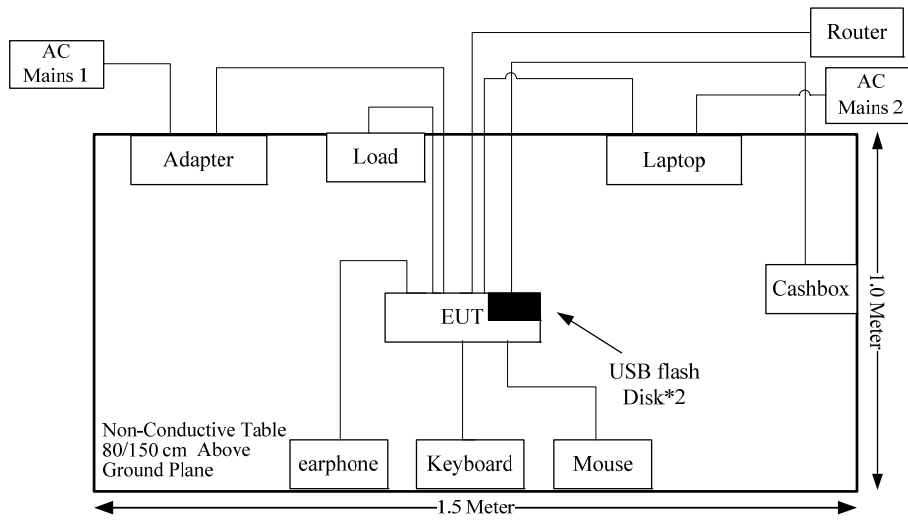

1.3 Measurement Uncertainty

Otherwise required by the applicant or Product Regulations, Decision Rule in this report did not consider the uncertainty. The extended uncertainty given in this report is obtained by combining the standard uncertainty times the coverage factor K with the 95% confidence interval.

Parameter	Measurement Uncertainty
Occupied Channel Bandwidth	±5 %
RF output power, conducted	±0.61dB
Power Spectral Density, conducted	±0.61 dB
Unwanted Emissions, radiated	30M~200MHz: 4.15 dB,200M~1GHz: 5.61 dB,1G~6GHz: 5.14 dB, 6G~18GHz: 5.93 dB,18G~26.5G:5.47 dB,26.5G~40G:5.63 dB
Unwanted Emissions, conducted	±1.26 dB
Temperature	±1 °C
Humidity	±5%
DC and low frequency voltages	±0.4%
Duty Cycle	1%
AC Power Lines Conducted Emission	2.8 dB (150 kHz to 30 MHz)

2. SUMMARY OF TEST RESULTS

FCC Rules	Description of Test	Result
FCC §15.207(a)	AC line conducted emissions	Compliant
FCC §15.205, §15.209, §15.247(d)	Radiated Spurious emissions	Compliant
FCC §15.247(a)(1)	20 dB Emission Bandwidth	Compliant
FCC §15.247(a)(1)	Channel separation	Compliant
FCC §15.247(a)(1)(iii)	Number of hopping Frequency	Compliant
FCC §15.247(a)(1)(iii)	Time of occupancy (dwell time)	Compliant
FCC §15.247(b)(1)	Maximum Conducted Output Power	Compliant
FCC §15.247(d)	100 kHz Bandwidth of Frequency Band Edge	Compliant
FCC §15.203	Antenna requirement	Compliant
FCC§15.247 (i) & §1.1307	RF Exposure Evaluation	Compliant

3. REQUIREMENTS AND TEST PROCEDURES

3.1 AC Line Conducted Emissions

3.1.1 Applicable Standard

FCC§15.207(a).

(a) Except as shown in paragraphs (b) and (c) of this section, for an intentional radiator that is designed to be connected to the public utility (AC) power line, the radio frequency voltage that is conducted back onto the AC power line on any frequency or frequencies, within the band 150 kHz to 30 MHz, shall not exceed the limits in the following table, as measured using a 50 μ H/50 ohms line impedance stabilization network (LISN). Compliance with the provisions of this paragraph shall be based on the measurement of the radio frequency voltage between each power line and ground at the power terminal. The lower limit applies at the boundary between the frequency ranges.

Frequency of emission (MHz)	Conducted limit (dB μ V)	
	Quasi-peak	Average
0.15-0.5	66 to 56*	56 to 46*
0.5-5	56	46
5-30	60	50

*Decreases with the logarithm of the frequency.

(b) The limit shown in paragraph (a) of this section shall not apply to carrier current systems operating as intentional radiators on frequencies below 30 MHz. In lieu thereof, these carrier current systems shall be subject to the following standards:

(1) For carrier current system containing their fundamental emission within the frequency band 535-1705 kHz and intended to be received using a standard AM broadcast receiver: no limit on conducted emissions.

(2) For all other carrier current systems: 1000 μ V within the frequency band 535-1705 kHz, as measured using a 50 μ H/50 ohms LISN.

(3) Carrier current systems operating below 30 MHz are also subject to the radiated emission limits in §15.205, §15.209, §15.221, §15.223, or §15.227, as appropriate.

(c) Measurements to demonstrate compliance with the conducted limits are not required for devices which only employ battery power for operation and which do not operate from the AC power lines or contain provisions for operation while connected to the AC power lines. Devices that include, or make provisions for, the use of battery chargers which permit operating while charging, AC adapters or battery eliminators or that connect to the AC power lines indirectly, obtaining their power through another device which is connected to the AC power lines, shall be tested to demonstrate compliance with the conducted limits.

3.1.2 EUT Setup



- Note: 1. Support units were connected to second LISN.
 2. Both of LISNs (AMN) 80 cm from EUT and at the least 80 cm from other units and other metal planes support units.

The setup of EUT is according with per ANSI C63.10-2013 measurement procedure. The specification used was with the FCC Part 15.207 limits.

The spacing between the peripherals was 10 cm.

The adapter or EUT was connected to the main LISN with a 120 V/60 Hz AC power source.

3.1.3 EMI Test Receiver Setup

The EMI test receiver was set to investigate the spectrum from 150 kHz to 30 MHz.

During the conducted emission test, the EMI test receiver was set with the following configurations:

Frequency Range	IF B/W
150 kHz – 30 MHz	9 kHz

3.1.4 Test Procedure

The frequency and amplitude of the six highest ac power-line conducted emissions relative to the limit, measured over all the current-carrying conductors of the EUT power cords, and the operating frequency or frequency to which the EUT is tuned (if appropriate), should be reported, unless such emissions are more than 20 dB below the limit. AC power-line conducted emissions measurements are to be separately carried out only on each of the phase (“hot”) line(s) and (if used) on the neutral line(s), but not on the ground [protective earth] line(s). If less than six emission frequencies are within 20 dB of the limit, then the noise level of the measuring instrument at representative frequencies should be reported. The specific conductor of the power-line cord for each of the reported emissions should be identified. Measure the six highest emissions with respect to the limit on each current-carrying conductor of each power cord associated with the EUT (but not the power cords of associated or peripheral equipment that are part of the test configuration). Then, report the six highest emissions with respect to the limit from among all the measurements identifying the frequency and specific current-carrying conductor identified with the emission. The six highest emissions should be reported for each of the current-carrying conductors, or the six highest emissions may be reported over all the current-carrying conductors.

3.1.5 Corrected Amplitude & Margin Calculation

The basic equation is as follows:

Result = Reading + Factor

Factor = attenuation caused by cable loss + voltage division factor of AMN

The “**Margin**” column of the following data tables indicates the degree of compliance within the applicable limit. The equation for margin calculation is as follows:

Margin = Limit – Result

3.2 Radiated Spurious Emissions

3.2.1 Applicable Standard

FCC §15.247 (d);

In any 100 kHz bandwidth outside the frequency band in which the spread spectrum or digitally modulated intentional radiator is operating, the radio frequency power that is produced by the intentional radiator shall be at least 20 dB below that in the 100 kHz bandwidth within the band that contains the highest level of the desired power, based on either an RF conducted or a radiated measurement, provided the transmitter demonstrates compliance with the peak conducted power limits. If the transmitter complies with the conducted power limits based on the use of RMS averaging over a time interval, as permitted under paragraph (b)(3) of this section, the attenuation required under this paragraph shall be 30 dB instead of 20 dB. Attenuation below the general limits specified in §15.209(a) is not required. In addition, radiated emissions which fall in the restricted bands, as defined in §15.205(a), must also comply with the radiated emission limits specified in §15.209(a) (see §15.205(c)).

3.2.2 EUT Setup

Below 1GHz:



Above 1GHz:

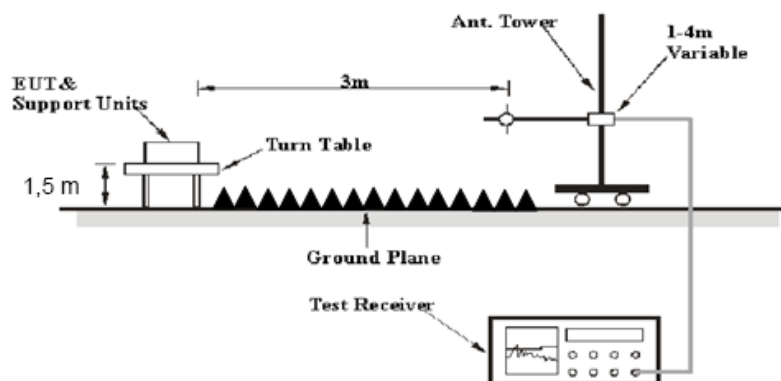

The radiated emissions were performed in the 3 meters distance, using the setup accordance with the ANSI C63.10-2013. The specification used was the FCC 15.209, and FCC 15.247 limits.

The external I/O cables were draped along the test table and formed a bundle 30 to 40 cm long in the middle.

The spacing between the peripherals was 10 cm.

3.2.3 EMI Test Receiver & Spectrum Analyzer Setup

During the radiated emission test, the EMI test receiver & Spectrum Analyzer Setup were set with the following configurations:

Frequency Range	RBW	Video B/W	IF B/W	Measurement
30 MHz – 1000 MHz	120 kHz	300 kHz	120 kHz	QP
Above 1 GHz	1MHz	3 MHz	/	PK
	1MHz	10 Hz	/	AV

If the maximized peak measured value complies with under the QP/Average limit more than 6dB, then it is unnecessary to perform an QP/Average measurement.

3.2.4 Test Procedure

Maximizing procedure was performed on the highest emissions to ensure that the EUT complied with all installation combinations.

Data was recorded in Quasi-peak detection mode for frequency range of 30 MHz-1 GHz, peak and Average detection modes for frequencies above 1 GHz.

3.2.5 Corrected Amplitude & Margin Calculation

The basic equation is as follows:

Result = Reading + Factor

Factor = Antenna Factor + Cable Loss- Amplifier Gain

The “**Margin**” column of the following data tables indicates the degree of compliance within the applicable limit. The equation for margin calculation is as follows:

Margin = Limit – Result

3.3 20 dB Emission Bandwidth

3.3.1 Applicable Standard

FCC §15.247 (a)(1)

Frequency hopping systems shall have hopping channel carrier frequencies separated by a minimum of 25 kHz or the 20 dB bandwidth of the hopping channel, whichever is greater. Alternatively, frequency hopping systems operating in the 2400-2483.5 MHz band may have hopping channel carrier frequencies that are separated by 25 kHz or two-thirds of the 20 dB bandwidth of the hopping channel, whichever is greater, provided the systems operate with an output power no greater than 125 mW. The system shall hop to channel frequencies that are selected at the system hopping rate from a pseudo randomly ordered list of hopping frequencies. Each frequency must be used equally on the average by each transmitter. The system receivers shall have input bandwidths that match the hopping channel bandwidths of their corresponding transmitters and shall shift frequencies in synchronization with the transmitted signals.

3.3.2 EUT Setup

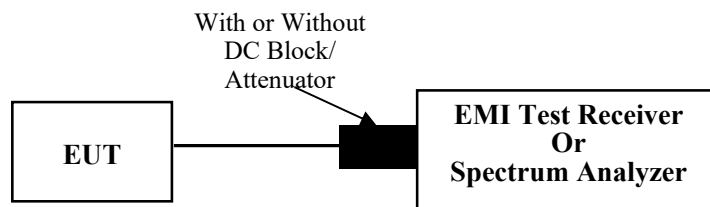

3.3.3 Test Procedure

According to ANSI C63.10-2013 Section 6.9.2

- a) The spectrum analyzer center frequency is set to the nominal EUT channel center frequency. The span range for the EMI receiver or spectrum analyzer shall be between two times and five times the OBW.
- b) The nominal IF filter bandwidth (3 dB RBW) shall be in the range of 1% to 5% of the OBW and video bandwidth (VBW) shall be approximately three times RBW, unless otherwise specified by the applicable requirement.
- c) Set the reference level of the instrument as required, keeping the signal from exceeding the maximum input mixer level for linear operation. In general, the peak of the spectral envelope shall be more than $[10 \log (\text{OBW}/\text{RBW})]$ below the reference level. Specific guidance is given in 4.1.5.2
- d) Steps a) through c) might require iteration to adjust within the specified tolerances.
- e) The dynamic range of the instrument at the selected RBW shall be more than 10 dB below the target “-xx dB down” requirement; that is, if the requirement calls for measuring the -20 dB OBW, the instrument noise floor at the selected RBW shall be at least 30 dB below the reference value.
- f) Set detection mode to peak and trace mode to max hold.
- g) Determine the reference value: Set the EUT to transmit an unmodulated carrier or modulated signal, as applicable. Allow the trace to stabilize. Set the spectrum analyzer marker to the highest level of the displayed trace (this is the reference value).
- h) Determine the “-xx dB down amplitude” using $[(\text{reference value}) - \text{xx}]$. Alternatively, this calculation may be made by using the marker-delta function of the instrument.
- i) If the reference value is determined by an unmodulated carrier, then turn the EUT modulation ON, and either clear the existing trace or start a new trace on the spectrum analyzer and allow the new trace to stabilize. Otherwise, the trace from step g) shall be used for step j).

- j) Place two markers, one at the lowest frequency and the other at the highest frequency of the envelope of the spectral display, such that each marker is at or slightly below the “-xx dB down amplitude” determined in step h). If a marker is below this “-xx dB down amplitude” value, then it shall be as close as possible to this value. The occupied bandwidth is the frequency difference between the two markers. Alternatively, set a marker at the lowest frequency of the envelope of the spectral display, such that the marker is at or slightly below the “-xx dB down amplitude” determined in step h). Reset the marker-delta function and move the marker to the other side of the emission until the delta marker amplitude is at the same level as the reference marker amplitude. The marker-delta frequency reading at this point is the specified emission bandwidth.
- k) The occupied bandwidth shall be reported by providing plot(s) of the measuring instrument display; the plot axes and the scale units per division shall be clearly labeled. Tabular data may be reported in addition to the plot(s).

3.4 Channel Separation

3.4.1 Applicable Standard

FCC §15.247 (a)(1)

Frequency hopping systems shall have hopping channel carrier frequencies separated by a minimum of 25 kHz or the 20 dB bandwidth of the hopping channel, whichever is greater. Alternatively, frequency hopping systems operating in the 2400-2483.5 MHz band may have hopping channel carrier frequencies that are separated by 25 kHz or two-thirds of the 20 dB bandwidth of the hopping channel, whichever is greater, provided the systems operate with an output power no greater than 125 mW. The system shall hop to channel frequencies that are selected at the system hopping rate from a pseudo randomly ordered list of hopping frequencies. Each frequency must be used equally on the average by each transmitter. The system receivers shall have input bandwidths that match the hopping channel bandwidths of their corresponding transmitters and shall shift frequencies in synchronization with the transmitted signals.

3.4.2 EUT Setup

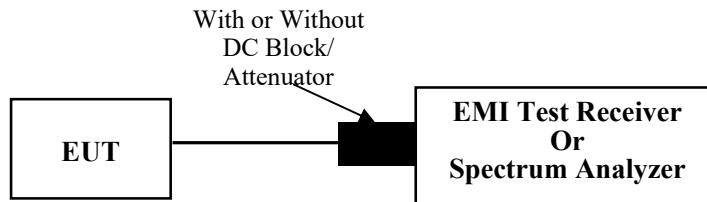

3.4.3 Test Procedure

According to ANSI C63.10-2013 Section 7.8.2

The EUT shall have its hopping function enabled. Use the following spectrum analyzer settings:

- Span: Wide enough to capture the peaks of two adjacent channels.
- RBW: Start with the RBW set to approximately 30% of the channel spacing; adjust as necessary to best identify the center of each individual channel.
- Video (or average) bandwidth (VBW) \geq RBW.
- Sweep: Auto.
- Detector function: Peak.
- Trace: Max hold.
- Allow the trace to stabilize.

Use the marker-delta function to determine the separation between the peaks of the adjacent channels. Compliance of an EUT with the appropriate regulatory limit shall be determined. A plot of the data shall be included in the test report.

3.5 Number Of Hopping Frequency

3.5.1 Applicable Standard

FCC §15.247 (a)(1)(iii)

Frequency hopping systems in the 2400–2483.5 MHz band shall use at least 15 channels. The average time of occupancy on any channel shall not be greater than 0.4 seconds within a period of 0.4 seconds multiplied by the number of hopping channels employed. Frequency hopping systems may avoid or suppress transmissions on a particular hopping frequency provided that a minimum of 15 channels are used.

3.5.2 EUT Setup

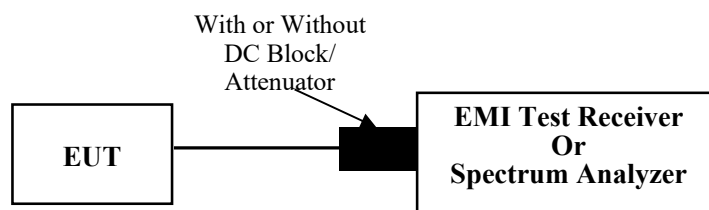

3.5.3 Test Procedure

According to ANSI C63.10-2013 Section 7.8.3

The EUT shall have its hopping function enabled. Use the following spectrum analyzer settings:

- a) Span: The frequency band of operation. Depending on the number of channels the device supports, it may be necessary to divide the frequency range of operation across multiple spans, to allow the individual channels to be clearly seen.
- b) RBW: To identify clearly the individual channels, set the RBW to less than 30% of the channel spacing or the 20 dB bandwidth, whichever is smaller.
- c) VBW \geq RBW.
- d) Sweep: Auto.
- e) Detector function: Peak.
- f) Trace: Max hold.
- g) Allow the trace to stabilize

It might prove necessary to break the span up into subranges to show clearly all of the hopping frequencies. Compliance of an EUT with the appropriate regulatory limit shall be determined for the number of hopping channels. A plot of the data shall be included in the test report.

3.6 Time Of Occupancy(Dwell Time)

3.6.1 Applicable Standard

Frequency hopping systems in the 2400-2483.5 MHz shall use at least 15 channels. The average time of occupancy on any channel shall not be greater than 0.4 seconds within a period of 0.4 seconds multiplied by the number of hopping channels employed. Frequency hopping systems may avoid or suppress transmissions on a particular hopping frequency provided that a minimum of 15 channels are used.

3.6.2 EUT Setup

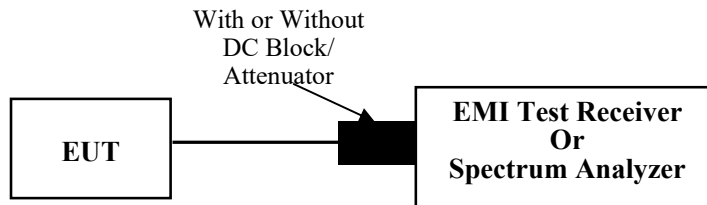

3.6.3 Test Procedure

According to ANSI C63.10-2013 Section 7.8.4

The EUT shall have its hopping function enabled. Use the following spectrum analyzer settings:

- a) Span: Zero span, centered on a hopping channel.
- b) RBW shall be \leq channel spacing and where possible RBW should be set $\gg 1 / T$, where T is the expected dwell time per channel.
- c) Sweep: As necessary to capture the entire dwell time per hopping channel; where possible use a video trigger and trigger delay so that the transmitted signal starts a little to the right of the start of the plot. The trigger level might need slight adjustment to prevent triggering when the system hops on an adjacent channel; a second plot might be needed with a longer sweep time to show two successive hops on a channel.
- d) Detector function: Peak.
- e) Trace: Max hold.

Use the marker-delta function to determine the transmit time per hop. If this value varies with different modes of operation (data rate, modulation format, number of hopping channels, etc.), then repeat this test for each variation in transmit time.

Repeat the measurement using a longer sweep time to determine the number of hops over the period specified in the requirements. The sweep time shall be equal to, or less than, the period specified in the requirements. Determine the number of hops over the sweep time and calculate the total number of hops in the period specified in the requirements, using the following equation:

$$\text{(Number of hops in the period specified in the requirements)} = \text{(number of hops on spectrum analyzer)} \times \text{(period specified in the requirements / analyzer sweep time)}$$

The average time of occupancy is calculated from the transmit time per hop multiplied by the number of hops in the period specified in the requirements. If the number of hops in a specific time varies with different modes of operation (data rate, modulation format, number of hopping channels, etc.), then repeat this test for each variation.

The measured transmit time and time between hops shall be consistent with the values described in the operational description for the EUT.

3.7 Maximum Conducted Output Power

3.7.1 Applicable Standard

FCC §15.247 (b)(1)

For frequency hopping systems operating in the 2400–2483.5 MHz band employing at least 75 non-overlapping hopping channels, and all frequency hopping systems in the 5725-5850 MHz band: 1 watt. For all other frequency hopping systems in the 2400–2483.5 MHz band: 0.125 watts

3.7.2 EUT Setup

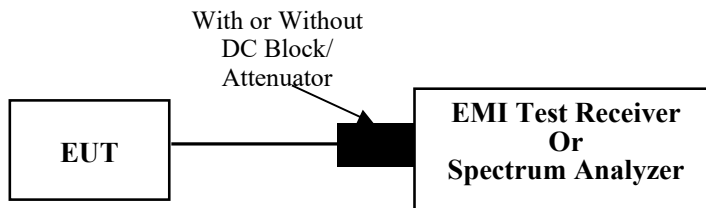

3.7.3 Test Procedure

According to ANSI C63.10-2013 Section 7.8.5

This is an RF-conducted test to evaluate maximum peak output power. Use a direct connection between the antenna port of the unlicensed wireless device and the spectrum analyzer, through suitable attenuation. Offset the Insertion loss of the RF cable, DC Block/ Attenuator into the spectrum analyzer. The hopping shall be disabled for this test:

- a) Use the following spectrum analyzer settings:
 - 1) Span: Approximately five times the 20 dB bandwidth, centered on a hopping channel.
 - 2) RBW > 20 dB bandwidth of the emission being measured.
 - 3) VBW ≥ RBW.
 - 4) Sweep: Auto.
 - 5) Detector function: Peak.
 - 6) Trace: Max hold.
- b) Allow trace to stabilize.
- c) Use the marker-to-peak function to set the marker to the peak of the emission.
- d) The indicated level is the peak output power, after any corrections for external attenuators and cables.
- e) A plot of the test results and setup description shall be included in the test report.

NOTE—A peak responding power meter may be used, where the power meter and sensor system video bandwidth is greater than the occupied bandwidth of the unlicensed wireless device, rather than a spectrum analyzer.

3.8 100 kHz Bandwidth of Frequency Band Edge

3.8.1 Applicable Standard

FCC §15.247 (d);

In any 100 kHz bandwidth outside the frequency band in which the spread spectrum or digitally modulated intentional radiator is operating, the radio frequency power that is produced by the intentional radiator shall be at least 20 dB below that in the 100 kHz bandwidth within the band that contains the highest level of the desired power, based on either an RF conducted or a radiated measurement, provided the transmitter demonstrates compliance with the peak conducted power limits. If the transmitter complies with the conducted power limits based on the use of RMS averaging over a time interval, as permitted under paragraph (b)(3) of this section, the attenuation required under this paragraph shall be 30 dB instead of 20 dB. Attenuation below the general limits specified in §15.209(a) is not required. In addition, radiated emissions which fall in the restricted bands, as defined in §15.205(a), must also comply with the radiated emission limits specified in §15.209(a) (see §15.205(c)).

3.8.2 EUT Setup

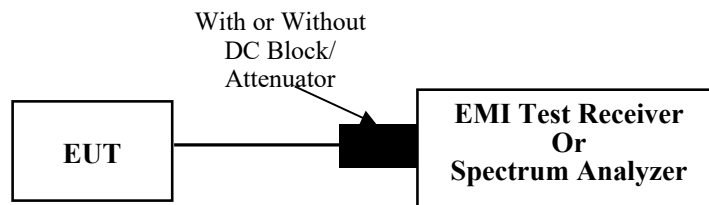

3.8.3 Test Procedure

According to ANSI C63.10-2013 Section 7.8.6

For band-edge measurements, use the band-edge procedure in 6.10. Band-edge measurements shall be tested both on single channels, and with the EUT hopping.

- a) Set the center frequency and span to encompass frequency range to be measured.
- b) Set the RBW = 100 kHz.
- c) Set the VBW $\geq [3 \times \text{RBW}]$.
- d) Detector = peak.
- e) Sweep time = auto couple.
- f) Trace mode = max hold.
- g) Allow trace to fully stabilize.
- h) Use the peak marker function to determine the maximum amplitude level.

Ensure that the amplitude of all unwanted emissions outside of the authorized frequency band (excluding restricted frequency bands) is attenuated by at least the minimum requirements. Report the three highest emissions relative to the limit.

3.9 Antenna Requirement

3.9.1 Applicable Standard

FCC §15.203

An intentional radiator shall be designed to ensure that no antenna other than that furnished by the responsible party shall be used with the device. The use of a permanently attached antenna or of an antenna that uses a unique coupling to the intentional radiator shall be considered sufficient to comply with the provisions of this section. The manufacturer may design the unit so that a broken antenna can be replaced by the user, but the use of a standard antenna jack or electrical connector is prohibited. This requirement does not apply to carrier current devices or to devices operated under the provisions of §§15.211, 15.213, 15.217, 15.219, 15.221, or §15.236. Further, this requirement does not apply to intentional radiators that must be professionally installed, such as perimeter protection systems and some field disturbance sensors, or to other intentional radiators which, in accordance with §15.31(d), must be measured at the installation site. However, the installer shall be responsible for ensuring that the proper antenna is employed so that the limits in this part are not exceeded.

3.9.2 Judgment

Compliant. Please refer to the Antenna Information detail in Section 1.

4. TEST DATA AND RESULTS

4.1 AC Line Conducted Emissions

Serial Number:	237R-1	Test Date:	2023/4/12
Test Site:	CE	Test Mode:	Transmitting(low channel was the worst)
Tester:	David	Test Result:	Pass

Environmental Conditions:					
Temperature: (°C)	24	Relative Humidity: (%)	65	ATM Pressure: (kPa)	101.3

Test Equipment List and Details:

Manufacturer	Description	Model	Serial Number	Calibration Date	Calibration Due Date
R&S	LISN	ENV216	101134	2023/03/31	2024/03/30
R&S	LISN	ENV216	101132	2023/03/31	2024/03/30
R&S	EMI Test Receiver	ESR3	102726	2022/07/15	2023/07/14
MICRO-COAX	Coaxial Cable	UTIFLEX	C-0200-01	2022/08/07	2023/08/06
Audix	Test Software	E3	190306 (V9)	N/A	N/A

* Statement of Traceability: China Certification ICT Co., Ltd (Dongguan) attests that all calibrations have been performed, traceable to National Primary Standards and International System of Units (SI).

Test Mode: Transmitting
 Port: Line
 Note:

Date: 2023-04-12

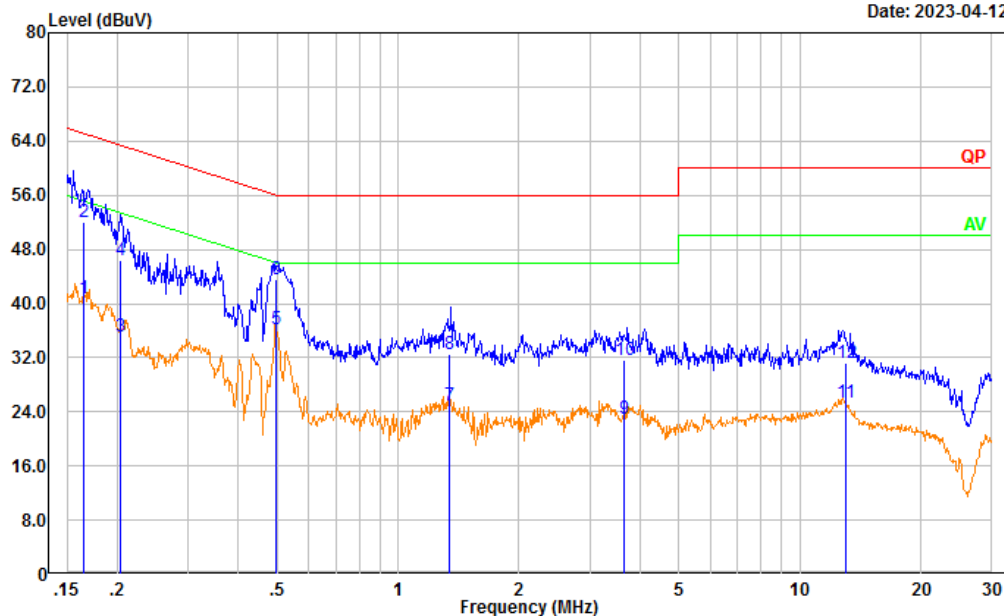

No.	Frequency (MHz)	Reading (dBμV)	Factor (dB)	Result (dBμV)	Limit (dBμV)	Margin (dB)	Detector
1	0.165	31.07	9.61	40.68	55.22	14.54	Average
2	0.165	42.34	9.61	51.95	65.22	13.27	QP
3	0.203	25.58	9.61	35.19	53.48	18.29	Average
4	0.203	36.76	9.61	46.37	63.48	17.11	QP
5	0.496	26.54	9.61	36.15	46.07	9.92	Average
6	0.496	33.90	9.61	43.51	56.07	12.56	QP
7	1.336	15.25	9.62	24.87	46.00	21.13	Average
8	1.336	22.80	9.62	32.42	56.00	23.58	QP
9	3.649	13.29	9.65	22.94	46.00	23.06	Average
10	3.649	21.97	9.65	31.62	56.00	24.38	QP
11	12.992	15.65	9.68	25.33	50.00	24.67	Average
12	12.992	21.63	9.68	31.31	60.00	28.69	QP

Test Mode: Transmitting
 Port: neutral
 Note:

Date: 2023-04-12

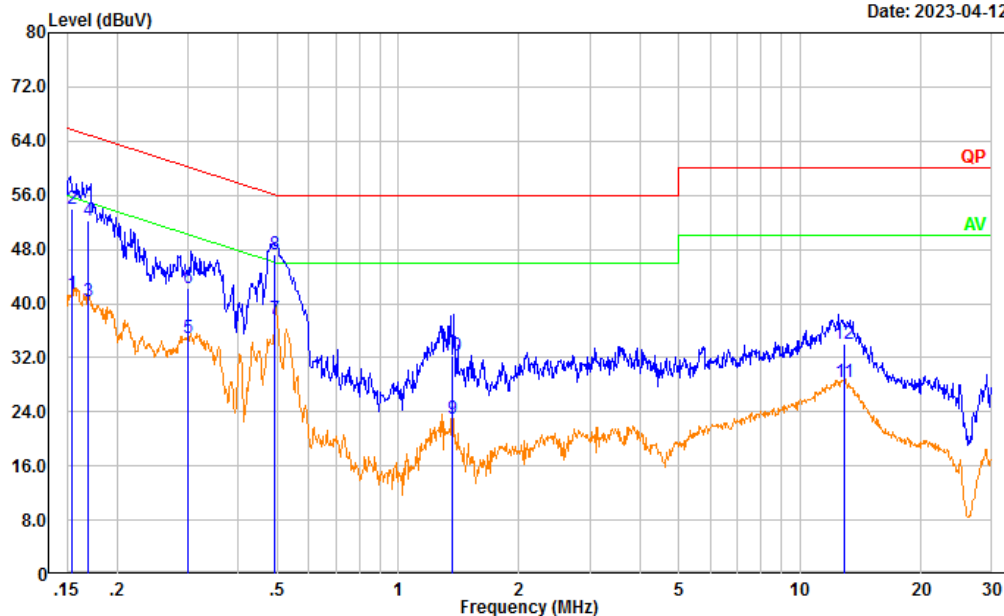

No.	Frequency (MHz)	Reading (dBμV)	Factor (dB)	Result (dBμV)	Limit (dBμV)	Margin (dB)	Detector
1	0.155	31.74	9.61	41.35	55.73	14.38	Average
2	0.155	44.41	9.61	54.02	65.73	11.71	QP
3	0.170	30.63	9.61	40.24	54.98	14.74	Average
4	0.170	42.71	9.61	52.32	64.98	12.66	QP
5	0.300	25.34	9.61	34.95	50.25	15.30	Average
6	0.300	32.66	9.61	42.27	60.25	17.98	QP
7	0.493	28.08	9.61	37.69	46.12	8.43	Average
8	0.493	37.54	9.61	47.15	56.12	8.97	QP
9	1.359	13.35	9.62	22.97	46.00	23.03	Average
10	1.359	22.67	9.62	32.29	56.00	23.71	QP
11	12.841	18.68	9.68	28.36	50.00	21.64	Average
12	12.841	24.36	9.68	34.04	60.00	25.96	QP

4.2 Radiated Spurious Emissions

Serial Number:	237R-1	Test Date:	2023/4/11~2023/4/12
Test Site:	966-2,966-1	Test Mode:	Transmitting
Tester:	Vic Du,Tao	Test Result:	Pass

Environmental Conditions:

Temperature: (°C)	25.5~26.1	Relative Humidity: (%)	53~55	ATM Pressure: (kPa)	100.6~100.7
----------------------	-----------	------------------------------	-------	------------------------	-------------

Test Equipment List and Details:

Manufacturer	Description	Model	Serial Number	Calibration Date	Calibration Due Date
Sunol Sciences	Antenna	JB6	A082520-5	2020/10/19	2023/10/18
R&S	EMI Test Receiver	ESR3	102724	2022/07/15	2023/07/14
TIMES MICROWAVE	Coaxial Cable	LMR-600-UltraFlex	C-0470-02	2022/07/17	2023/07/16
TIMES MICROWAVE	Coaxial Cable	LMR-600-UltraFlex	C-0780-01	2022/07/17	2023/07/16
Sonoma	Amplifier	310N	186165	2022/07/17	2023/07/16
Audix	Test Software	E3	201021 (V9)	N/A	N/A
ETS-Lindgren	Horn Antenna	3115	9912-5985	2020/10/13	2023/10/12
R&S	Spectrum Analyzer	FSV40	101591	2022/07/15	2023/07/14
MICRO-COAX	Coaxial Cable	UFA210A-1-1200-70U300	217423-008	2022/08/07	2023/08/06
MICRO-COAX	Coaxial Cable	UFA210A-1-2362-300300	235780-001	2022/08/07	2023/08/06
Mini	Pre-amplifier	ZVA-183-S+	5969001149	2022/11/09	2023/11/08
PASTERNAK	Horn Antenna	PE9852/2F-20	112002	2021/02/05	2024/02/04
Quinstar	Preamplifier	QLW-18405536-JO	15964001005	2022/9/16	2023/9/15
MICRO-COAX	Coaxial Cable	UFB142A-1-2362-200200	235772-001	2022/08/07	2023/08/06
E-Microwave	Band Rejection Filter	2400-2483.5MHz	OE01902424	2022/08/07	2023/08/06
Mini Circuits	High Pass Filter	VHF-6010+	31119	2022/08/07	2023/08/06

* Statement of Traceability: China Certification ICT Co., Ltd (Dongguan) attests that all calibrations have been performed, traceable to National Primary Standards and International System of Units (SI).

Test Data:

Please refer to the below table and plots.

1) 30MHz-1GHz(BDR Low channel was the worst)

Test Mode: Transmitting
 Polarization: vertical
 Note:

Date: 2023-04-12

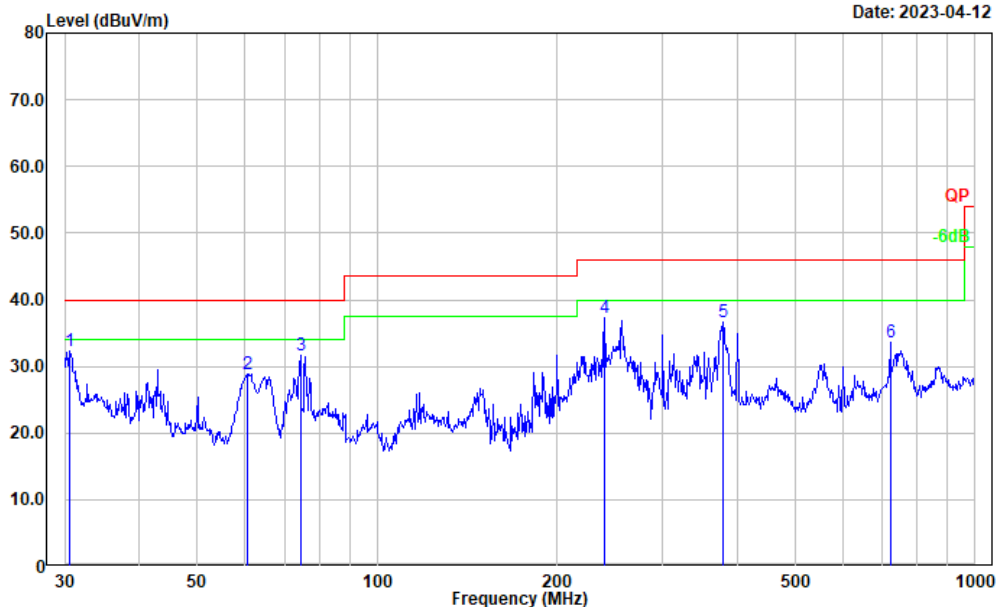

No.	Frequency (MHz)	Reading (dBμV)	Factor (dB/m)	Result (dBμV/m)	Limit (dBμV/m)	Margin (dB)	Detector
1	30.531	36.26	-4.00	32.26	40.00	7.74	Peak
2	60.704	46.25	-17.38	28.87	40.00	11.13	Peak
3	74.396	48.50	-16.92	31.58	40.00	8.42	Peak
4	239.987	50.34	-13.02	37.32	46.00	8.68	Peak
5	378.584	45.84	-9.17	36.67	46.00	9.33	Peak
6	721.726	36.86	-3.22	33.64	46.00	12.36	Peak

Test Mode: Transmitting
 Polarization: horizontal
 Note:

Date: 2023-04-12

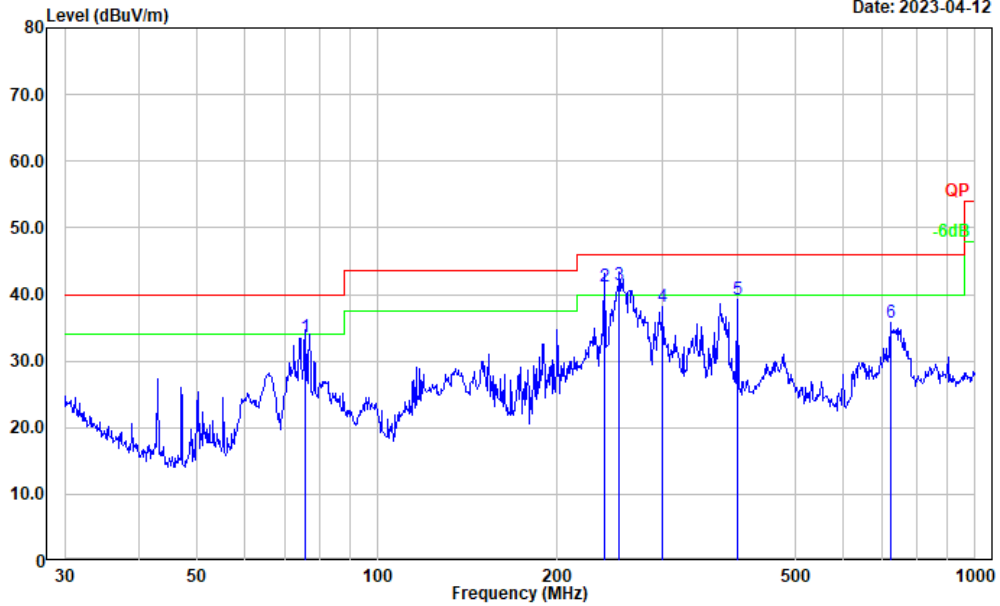

No.	Frequency (MHz)	Reading (dBμV)	Factor (dB/m)	Result (dBμV/m)	Limit (dBμV/m)	Margin (dB)	Detector
1	75.977	50.69	-17.02	33.67	40.00	6.33	QP
2	239.987	54.23	-13.02	41.21	46.00	4.79	QP
3	253.837	54.19	-12.88	41.31	46.00	4.69	QP
4	300.367	48.89	-10.63	38.26	46.00	7.74	Peak
5	400.432	48.06	-8.74	39.32	46.00	6.68	Peak
6	721.726	38.94	-3.22	35.72	46.00	10.28	Peak

2) 1-25GHz:*BDR Mode(GFSK) was the worst:*

Frequency (MHz)	Receiver		Polar (H/V)	Factor (dB/m)	Result (dB μ V/m)	Limit (dB μ V/m)	Margin (dB)
	Reading (dB μ V)	Detector					
Low Channel: 2402 MHz							
2402.000	60.53	PK	H	31.51	92.04	N/A	N/A
2402.000	45.15	AV	H	31.51	76.66	N/A	N/A
2402.000	56.91	PK	V	31.51	88.42	N/A	N/A
2402.000	41.77	AV	V	31.51	73.28	N/A	N/A
2390.000	26.53	PK	H	31.46	57.99	74.00	16.01
2390.000	13.79	AV	H	31.46	45.25	54.00	8.75
4804.000	35.67	PK	H	10.91	46.58	74.00	27.42
4804.000	22.63	AV	H	10.91	33.54	54.00	20.46
7206.000	35.44	PK	H	14.22	49.66	74.00	24.34
7206.000	22.72	AV	H	14.22	36.94	54.00	17.06
Middle Channel: 2441 MHz							
2441.000	57.53	PK	H	31.61	89.14	N/A	N/A
2441.000	42.33	AV	H	31.61	73.94	N/A	N/A
2441.000	55.63	PK	V	31.61	87.24	N/A	N/A
2441.000	40.71	AV	V	31.61	72.32	N/A	N/A
4882.000	35.72	PK	H	11.07	46.79	74.00	27.21
4882.000	22.61	AV	H	11.07	33.68	54.00	20.32
7323.000	35.68	PK	H	14.80	50.48	74.00	23.52
7323.000	22.53	AV	H	14.80	37.33	54.00	16.67
High Channel: 2480 MHz							
2480.000	59.51	PK	H	31.64	91.15	N/A	N/A
2480.000	44.68	AV	H	31.64	76.32	N/A	N/A
2480.000	57.66	PK	V	31.64	89.30	N/A	N/A
2480.000	42.35	AV	V	31.64	73.99	N/A	N/A
2483.500	27.13	PK	H	31.64	58.77	74.00	15.23
2483.500	14.18	AV	H	31.64	45.82	54.00	8.18
4960.000	35.82	PK	H	11.23	47.05	74.00	26.95
4960.000	22.57	AV	H	11.23	33.80	54.00	20.20
7440.000	35.62	PK	H	15.26	50.88	74.00	23.12
7440.000	22.48	AV	H	15.26	37.74	54.00	16.26

Worst Test plots(BDR High channel was the worst)

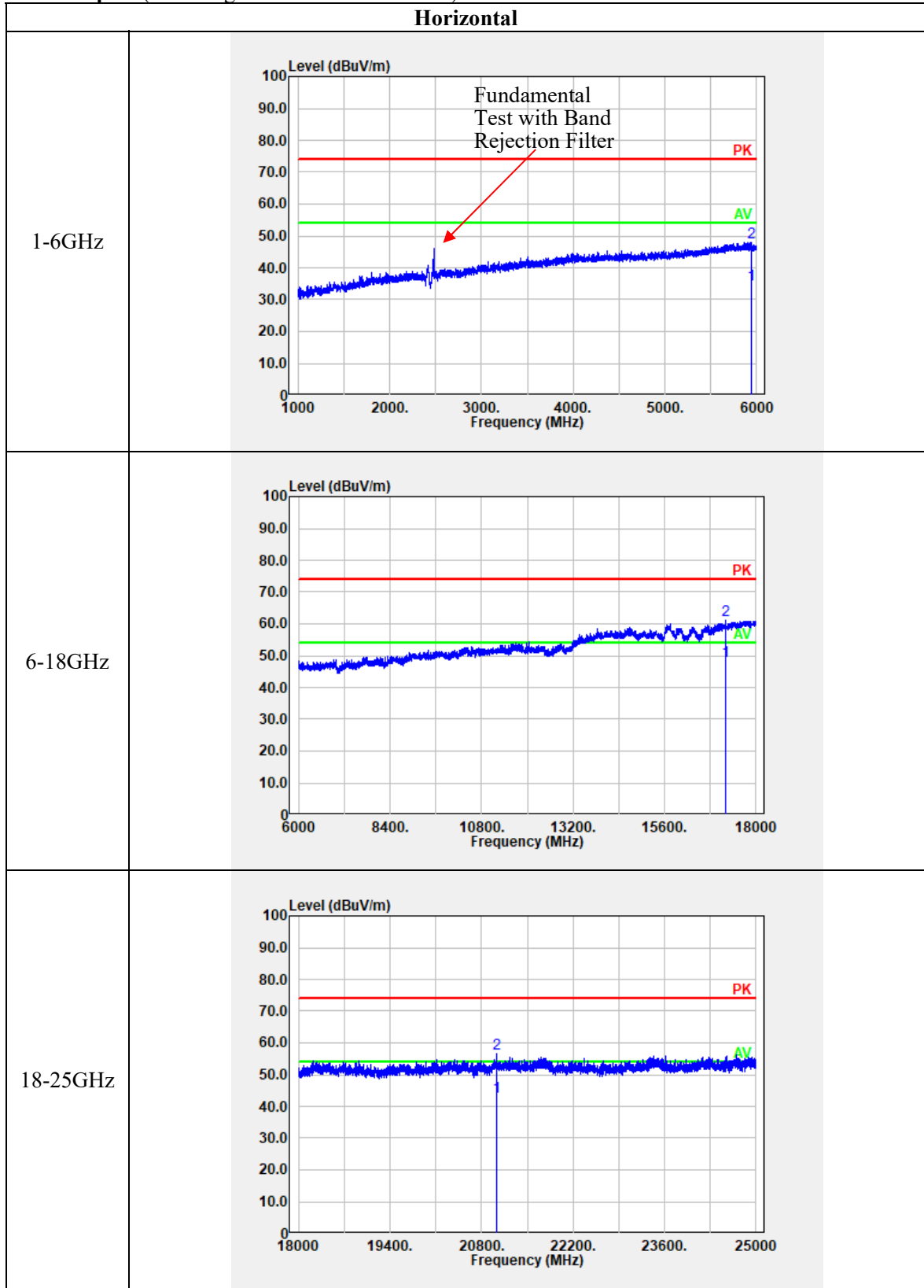

Vertical

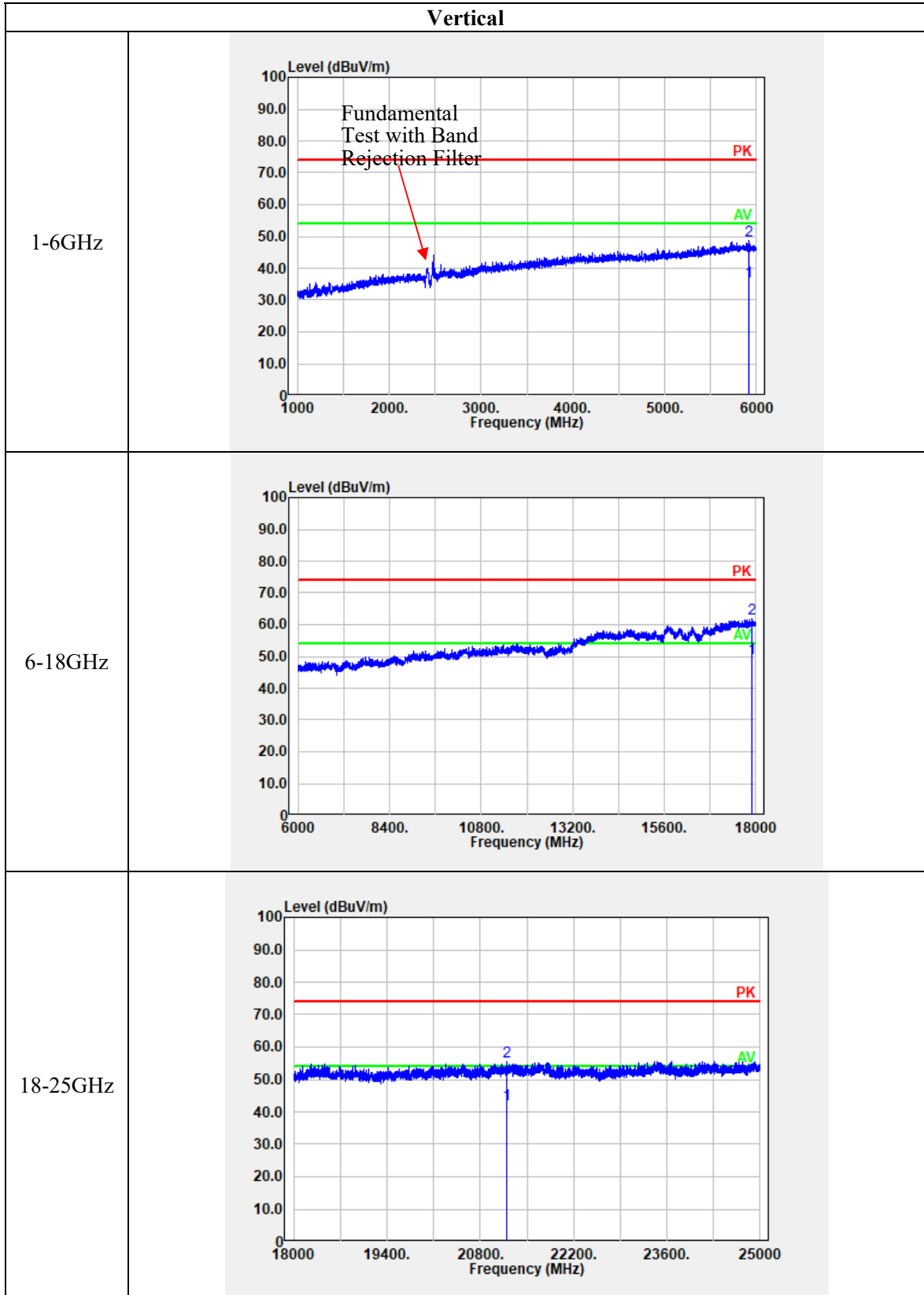

4.3 20 dB Emission Bandwidth:

Serial Number:	237R-1	Test Date:	2023/4/19
Test Site:	RF	Test Mode:	Transmitting
Tester:	Joe Liang	Test Result:	N/A

Environmental Conditions:

Temperature: (°C)	25.7	Relative Humidity: (%)	47	ATM Pressure: (kPa)	101
----------------------	------	------------------------------	----	------------------------	-----

Test Equipment List and Details:

Manufacturer	Description	Model	Serial Number	Calibration Date	Calibration Due Date
R&S	Spectrum Analyzer	FSU26	100147	2022/06/30	2023/06/22
Unknown	Coaxial Cable	C-SJ00-0010	C0010/01	Each time	N/A

* Statement of Traceability: China Certification ICT Co., Ltd (Dongguan) attests that all calibrations have been performed, traceable to National Primary Standards and International System of Units (SI).

Test Data:

Test Modes	Test Channel	Test Frequency (MHz)	20 dB Bandwidth (MHz)
BDR Mode (GFSK)	Lowest	2402	1.083
	Middle	2441	1.064
	Highest	2480	1.077
EDR Mode ($\pi/4$ -DQPSK)	Lowest	2402	1.343
	Middle	2441	1.343
	Highest	2480	1.343
EDR Mode (8DPSK)	Lowest	2402	1.304
	Middle	2441	1.321
	Highest	2480	1.314

BDR Mode (GFSK)

<p>Lowest Channel</p>	<p>Date: 19.APR.2023 21:32:50</p>
<p>Middle Channel</p>	<p>Date: 19.APR.2023 21:32:30</p>
<p>Highest Channel</p>	<p>Date: 19.APR.2023 21:40:36</p>

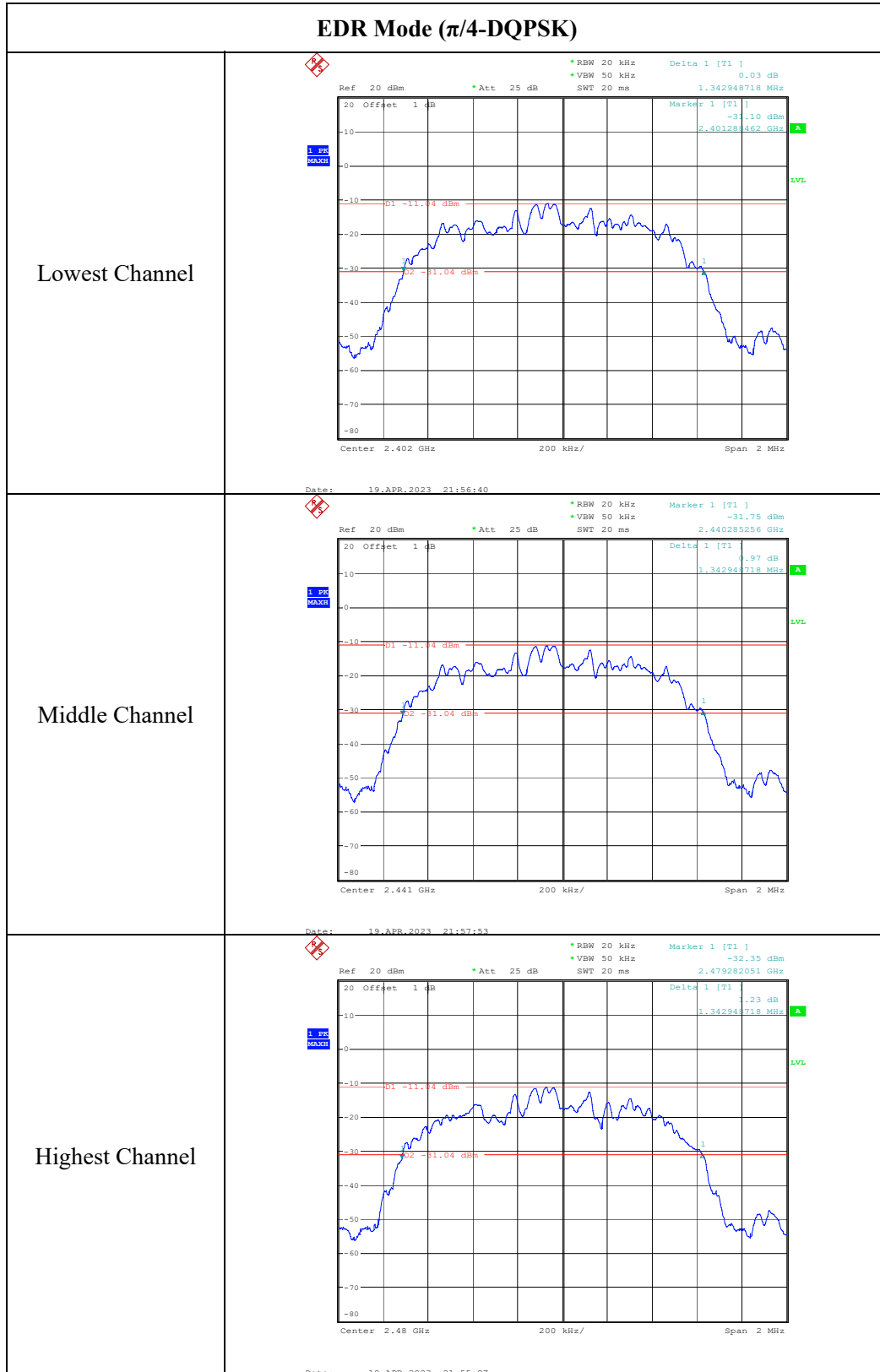

EDR Mode (8DPSK)

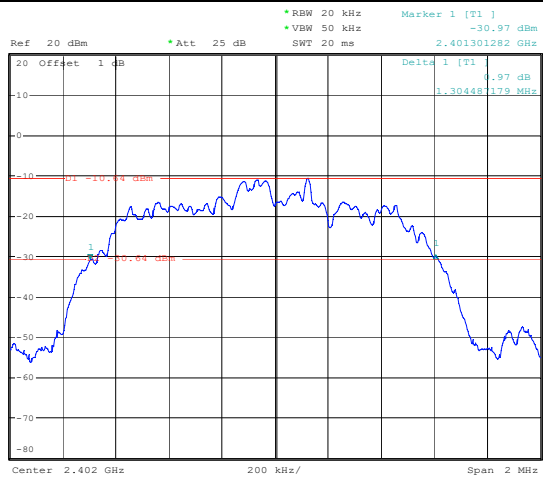
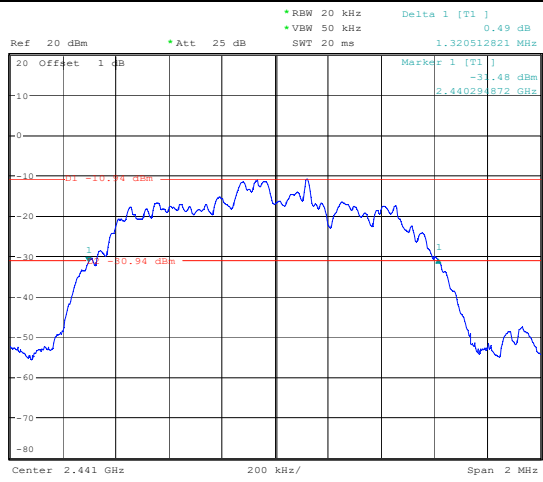
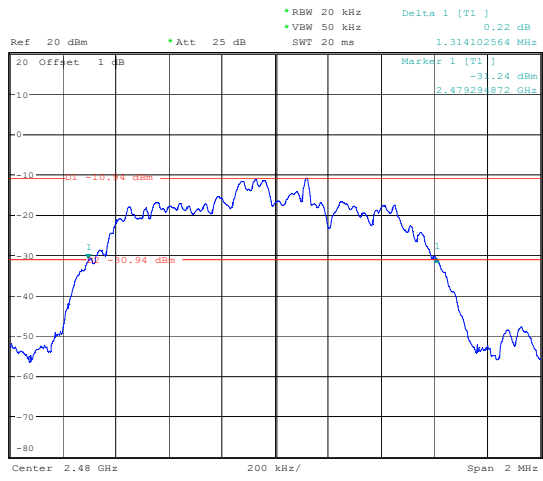
Lowest Channel	 <p>Ref 20 dBm *Att 25 dB RBW 20 kHz Marker 1 [T1] -30.97 dBm VBW 50 kHz 2.401391282 GHz SWT 20 ms Delta 1 [T1] 0.97 dB 1.304481179 MHz</p> <p>20 Offset 1 dB 1. PK MAXH EVL</p> <p>Center 2.402 GHz 200 kHz/ Span 2 MHz</p> <p>Date: 19.APR.2023 22:07:14</p>
Middle Channel	 <p>Ref 20 dBm *Att 25 dB RBW 20 kHz Delta 1 [T1] 0.49 dB VBW 50 kHz 1.320512821 MHz SWT 20 ms Marker 1 [T1] -31.48 dBm 2.440291872 GHz</p> <p>20 Offset 1 dB 1. PK MAXH EVL</p> <p>Center 2.441 GHz 200 kHz/ Span 2 MHz</p> <p>Date: 19.APR.2023 22:02:14</p>
Highest Channel	 <p>Ref 20 dBm *Att 25 dB RBW 20 kHz Delta 1 [T1] 0.22 dB VBW 50 kHz 1.314102564 MHz SWT 20 ms Marker 1 [T1] -31.24 dBm 2.479291872 GHz</p> <p>20 Offset 1 dB 1. PK MAXH EVL</p> <p>Center 2.48 GHz 200 kHz/ Span 2 MHz</p> <p>Date: 19.APR.2023 22:05:55</p>

4.4 Channel Separation:

Serial Number:	237R-1	Test Date:	2023/4/19
Test Site:	RF	Test Mode:	Transmitting
Tester:	Joe Liang	Test Result:	Pass

Environmental Conditions:

Temperature: (°C)	25.7	Relative Humidity: (%)	47	ATM Pressure: (kPa)	101
----------------------	------	---------------------------	----	------------------------	-----

Test Equipment List and Details:

Manufacturer	Description	Model	Serial Number	Calibration Date	Calibration Due Date
R&S	Spectrum Analyzer	FSU26	100147	2022/6/30	2023/6/22
Unknown	Coaxial Cable	C-SJ00-0010	C0010/01	Each time	N/A

* Statement of Traceability: China Certification ICT Co., Ltd (Dongguan) attests that all calibrations have been performed, traceable to National Primary Standards and International System of Units (SI).

Test Data:

Test Modes	Test Frequency (MHz)	Channel Separation (MHz)	Limits (MHz)
BDR Mode (GFSK)	2402	1.005	0.722
	2441	1	0.709
	2480	1.005	0.719
EDR Mode ($\pi/4$ -DQPSK)	2402	0.995	0.895
	2441	1	0.895
	2480	1.01	0.895
EDR Mode (8DPSK)	2402	1	0.869
	2441	1.005	0.881
	2480	0.995	0.876

BDR Mode (GFSK)

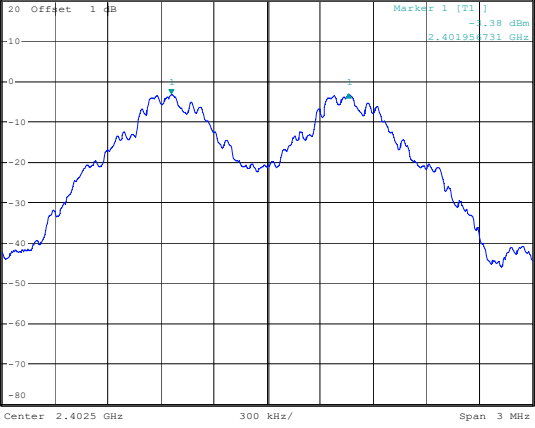
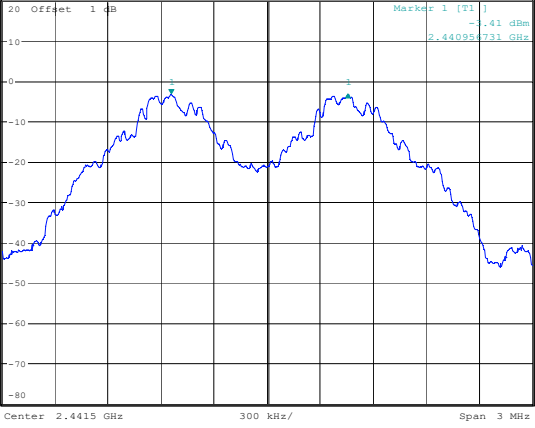
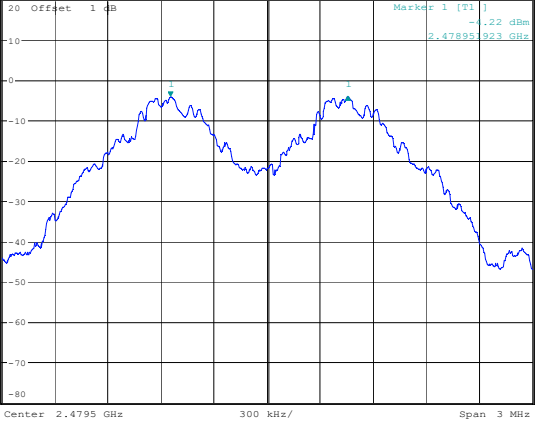
<p>Lowest Channel</p>	<p>1. PE MAX11</p>  <p>Ref 20 dBm *Att 25 dB RBW 30 kHz Delta 1 [T1] 0.05 dB VBW 100 kHz 1.004807692 MHz SWT 15 ms</p> <p>Marker 1 [T1] -1.38 dBm 2.40195731 GHz</p> <p>Center 2.4025 GHz 300 kHz/ Span 3 MHz</p> <p>Date: 19.APR.2023 22:47:02</p>
<p>Middle Channel</p>	<p>1. PE MAX11</p>  <p>Ref 20 dBm *Att 25 dB RBW 30 kHz Delta 1 [T1] 0.01 dB VBW 100 kHz 1.000000000 MHz SWT 15 ms</p> <p>Marker 1 [T1] -1.41 dBm 2.440954731 GHz</p> <p>Center 2.4415 GHz 300 kHz/ Span 3 MHz</p> <p>Date: 19.APR.2023 22:51:12</p>
<p>Highest Channel</p>	<p>1. PE MAX11</p>  <p>Ref 20 dBm *Att 25 dB RBW 30 kHz Delta 1 [T1] 0.04 dB VBW 100 kHz 1.004807692 MHz SWT 15 ms</p> <p>Marker 1 [T1] -1.22 dBm 2.478954923 GHz</p> <p>Center 2.4795 GHz 300 kHz/ Span 3 MHz</p> <p>Date: 19.APR.2023 22:54:14</p>

EDR Mode ($\pi/4$ -DQPSK)

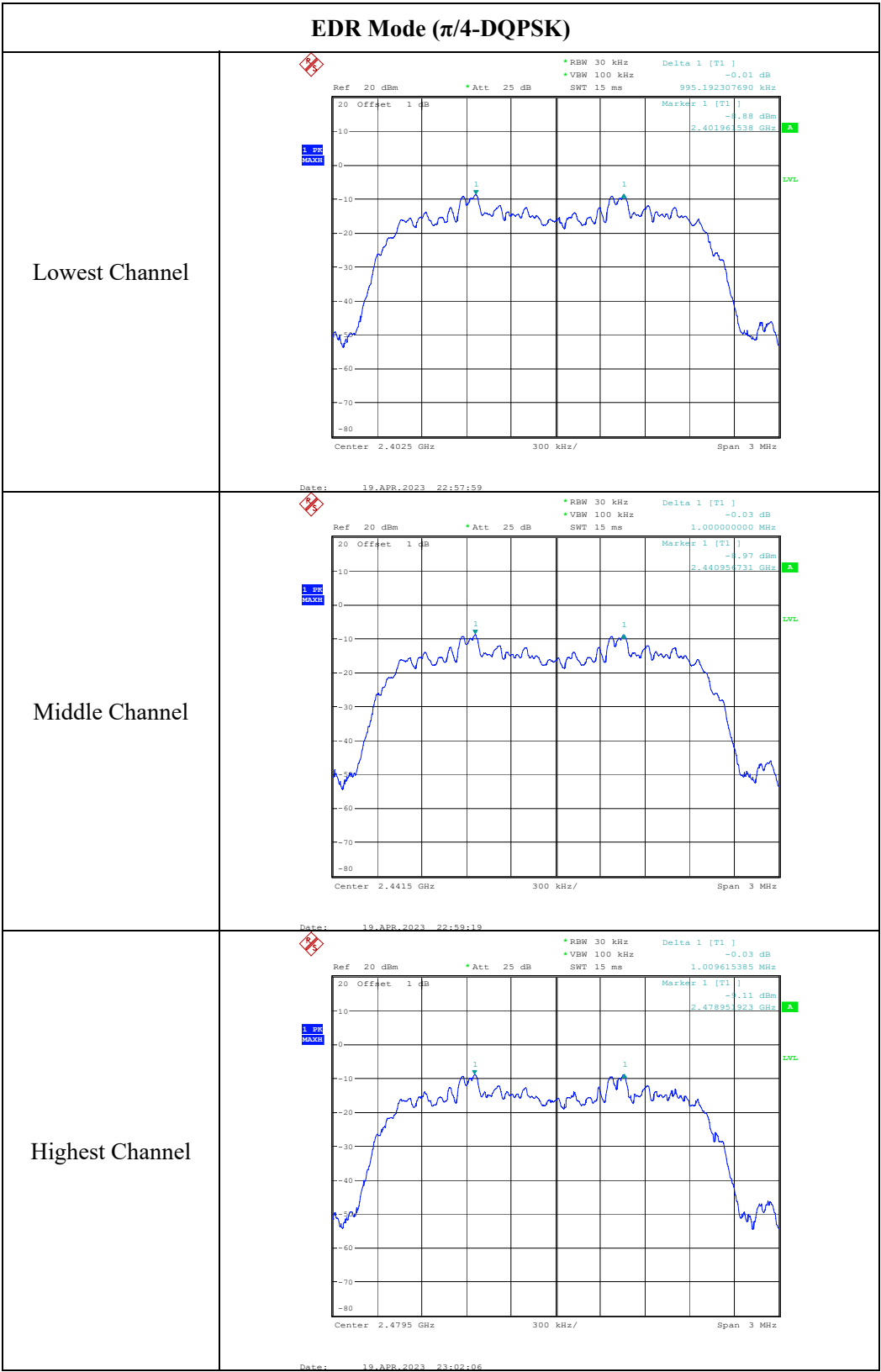

EDR Mode (8DPSK)

<p>Lowest Channel</p>	<p>Ref 20 dBm *Att 25 dB RBW 30 kHz Delta 1 [T1] 0.02 dB VBW 100 kHz 1.000000000 MHz SWT 15 ms</p> <p>20 Offset 1 dB Marker 1 [T1] -1.22 dBm 2.40212192 GHz</p> <p>Center 2.4025 GHz 300 kHz/ Span 3 MHz</p> <p>Date: 19.APR.2023 23:04:05</p>
<p>Middle Channel</p>	<p>Ref 20 dBm *Att 25 dB RBW 30 kHz Delta 1 [T1] -0.01 dB VBW 100 kHz 1.004807692 MHz SWT 15 ms</p> <p>20 Offset 1 dB Marker 1 [T1] -1.26 dBm 2.44111385 GHz</p> <p>Center 2.4415 GHz 300 kHz/ Span 3 MHz</p> <p>Date: 19.APR.2023 23:08:31</p>
<p>Highest Channel</p>	<p>Ref 20 dBm *Att 25 dB RBW 30 kHz Delta 1 [T1] -0.06 dB VBW 100 kHz 995.192307700 kHz SWT 15 ms</p> <p>20 Offset 1 dB Marker 1 [T1] -1.10 dBm 2.47911385 GHz</p> <p>Center 2.4795 GHz 300 kHz/ Span 3 MHz</p> <p>Date: 19.APR.2023 23:10:43</p>

4.5 Number Of Hopping Frequency:

Serial Number:	237R-1	Test Date:	2023/4/19
Test Site:	RF	Test Mode:	Transmitting
Tester:	Joe Liang	Test Result:	Pass

Environmental Conditions:

Temperature: (°C)	25.7	Relative Humidity: (%)	47	ATM Pressure: (kPa)	101
----------------------	------	------------------------------	----	------------------------	-----

Test Equipment List and Details:

Manufacturer	Description	Model	Serial Number	Calibration Date	Calibration Due Date
R&S	Spectrum Analyzer	FSU26	100147	2022/6/30	2023/6/22
Unknown	Coaxial Cable	C-SJ00-0010	C0010/01	Each time	N/A

* Statement of Traceability: China Certification ICT Co., Ltd (Dongguan) attests that all calibrations have been performed, traceable to National Primary Standards and International System of Units (SI).

Test Data:

Test Modes	Frequency Range (MHz)	Number of Hopping Channel	Limits
GFSK	2400-2483.5	79	≥15
$\pi/4$ -DQPSK	2400-2483.5	79	≥15
8DPSK	2400-2483.5	79	≥15

Number of Hopping Channel

**BDR Mode
(GFSK)**

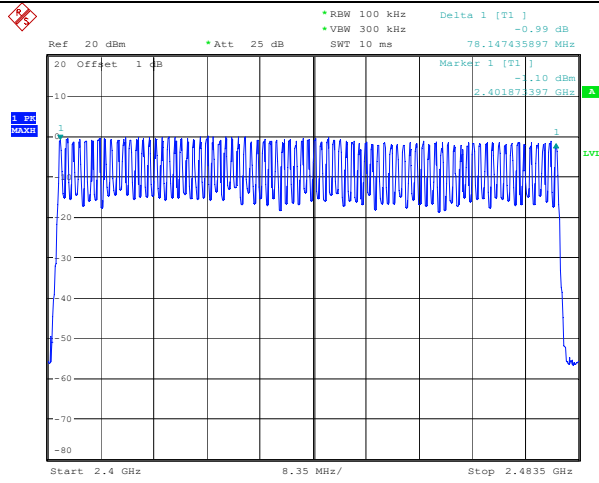

Date: 20.APR.2023 00:18:42

**EDR Mode
($\pi/4$ -DQPSK)**

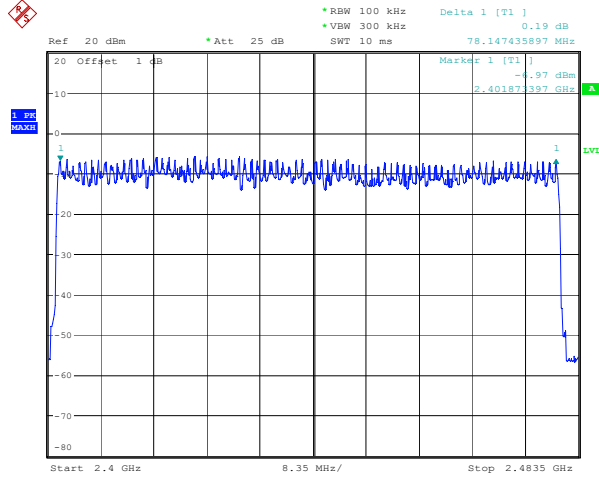

Date: 20.APR.2023 00:23:17

**EDR Mode
(8DPSK)**

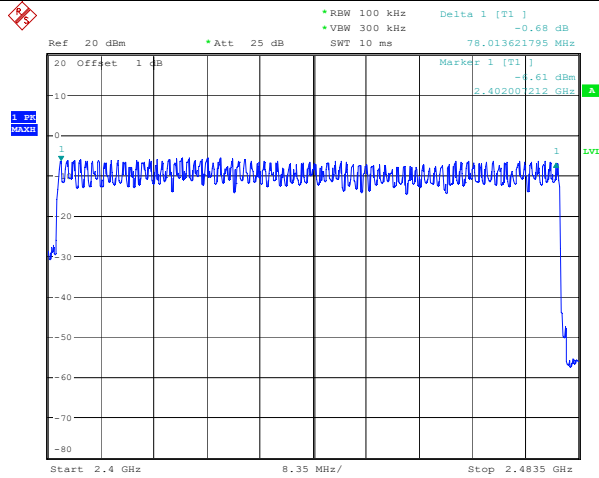

Date: 19.APR.2023 23:56:18

4.6 Time Of Occupancy(Dwell Time):

Serial Number:	237R-1	Test Date:	2023/4/19
Test Site:	RF	Test Mode:	Transmitting
Tester:	Joe Liang	Test Result:	Pass

Environmental Conditions:

Temperature: (°C)	25.7	Relative Humidity: (%)	47	ATM Pressure: (kPa)	101
----------------------	------	---------------------------	----	------------------------	-----

Test Equipment List and Details:

Manufacturer	Description	Model	Serial Number	Calibration Date	Calibration Due Date
R&S	Spectrum Analyzer	FSU26	100147	2022/6/30	2023/6/22
Unknown	Coaxial Cable	C-SJ00-0010	C0010/01	Each time	N/A

* Statement of Traceability: China Certification ICT Co., Ltd (Dongguan) attests that all calibrations have been performed, traceable to National Primary Standards and International System of Units (SI).

Test Data:

Test Modes	Packet Type	Test Frequency (MHz)	Pulse width (ms)	Result (s)	Limit (s)
BDR Mode (GFSK)	DH1	2441	0.426	0.136	0.400
	DH3	2441	1.692	0.271	0.400
	DH5	2441	2.949	0.315	0.400
EDR Mode ($\pi/4$ -DQPSK)	2DH1	2441	0.436	0.140	0.400
	2DH3	2441	1.712	0.274	0.400
	2DH5	2441	2.949	0.315	0.400
EDR Mode (8DPSK)	3DH1	2441	0.433	0.139	0.400
	3DH3	2441	1.702	0.272	0.400
	3DH5	2441	2.949	0.315	0.400

Note:

DH1:Dwell time=Pulse time (ms) \times (1600/2/79) \times 31.6 s

DH3:Dwell time=Pulse time (ms) \times (1600/4/79) \times 31.6 s

DH5:Dwell time=Pulse time (ms) \times (1600/6/79) \times 31.6 s

BDR Mode (GFSK)

DH1:

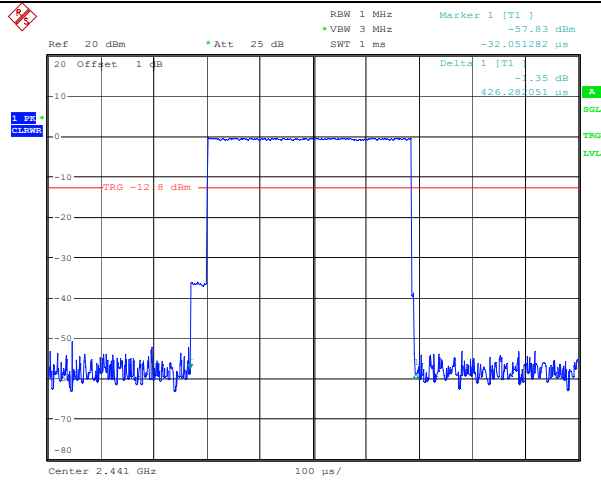

Date: 19.APR.2023 22:37:19

DH3:

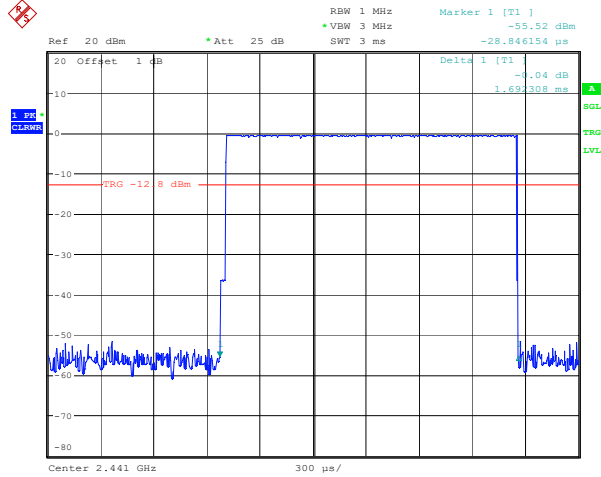

Date: 19.APR.2023 22:26:27

DH5:

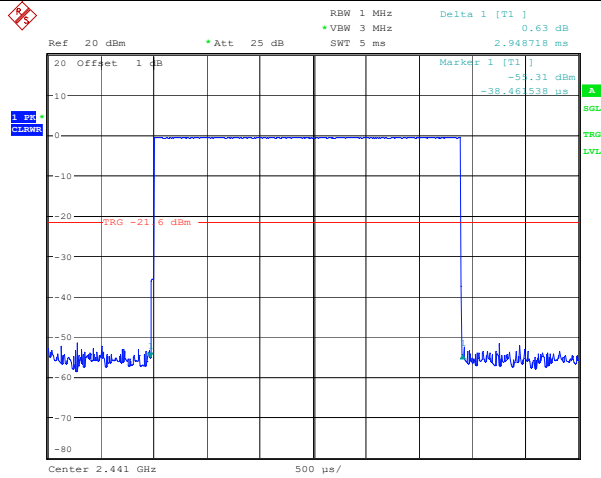

Date: 19.APR.2023 22:21:47

EDR Mode ($\pi/4$ -DQPSK)

2DH1:

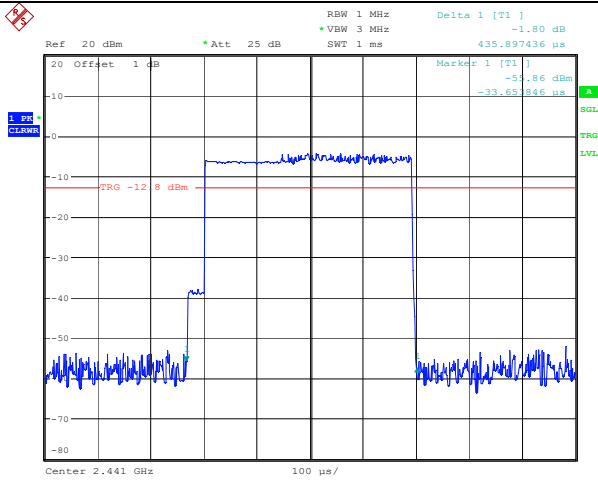

Date: 19.APR.2023 22:35:05

2DH3:

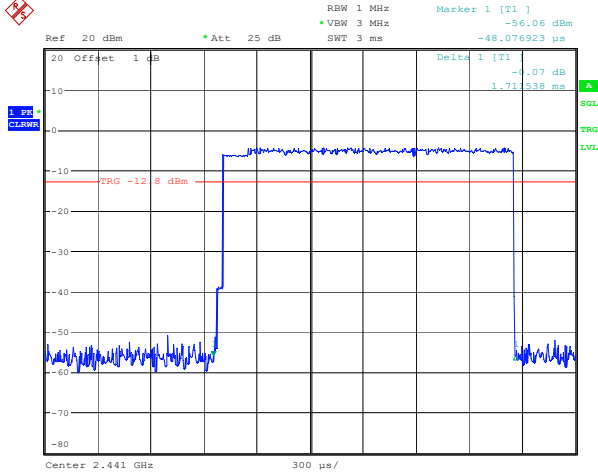

Date: 19.APR.2023 22:30:53

2DH5:

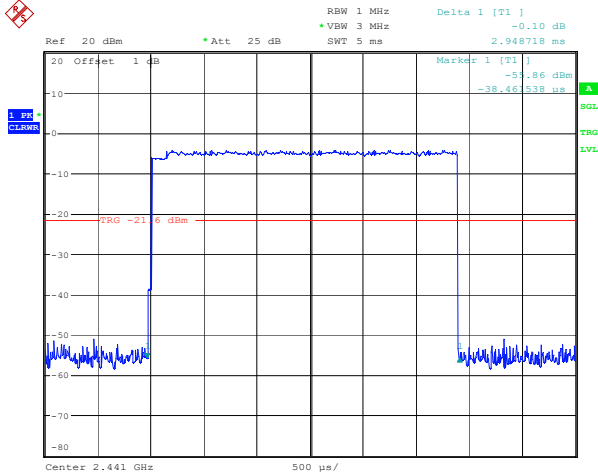

Date: 19.APR.2023 22:23:09

EDR Mode (8DPSK)	
3DH1:	<p>Ref 20 dBm *Att 25 dB RBW 1 MHz Delta 1 [T1] -1.01 dB *VBW 3 MHz SWT 1 ms 432.692308 μs</p> <p>20 Offset 1 dB Marker 1 [T1] -56.92 dBm -10 -32.052282 μs</p> <p>TRG -12.8 dBm</p> <p>Center 2.441 GHz 100 μs/</p> <p>Date: 19.APR.2023 22:41:10</p>
3DH3:	<p>Ref 20 dBm *Att 25 dB RBW 1 MHz Delta 1 [T1] 1.30 dB *VBW 3 MHz SWT 3 ms Marker 1 [T1] -56.80 dBm -38.461538 μs</p> <p>20 Offset 1 dB Marker 1 [T1] -56.80 dBm -10 1.701923 ms</p> <p>TRG -12.8 dBm</p> <p>Center 2.441 GHz 300 μs/</p> <p>Date: 19.APR.2023 22:29:37</p>
3DH5:	<p>Ref 20 dBm *Att 25 dB RBW 1 MHz Delta 1 [T1] 0.30 dB *VBW 3 MHz SWT 5 ms Marker 1 [T1] -53.86 dBm -38.461538 μs</p> <p>20 Offset 1 dB Marker 1 [T1] -53.86 dBm -10 2.943718 ms</p> <p>TRG -21.6 dBm</p> <p>Center 2.441 GHz 500 μs/</p> <p>Date: 19.APR.2023 22:12:56</p>

4.7 Maximum Conducted Output Power:

Serial Number:	237R-1	Test Date:	2023/4/19~2023/4/20
Test Site:	RF	Test Mode:	Transmitting
Tester:	Joe Liang	Test Result:	Pass

Environmental Conditions:

Temperature: (°C)	25.7-25.9	Relative Humidity: (%)	46-47	ATM Pressure: (kPa)	101-101.6
----------------------	-----------	------------------------------	-------	------------------------	-----------

Test Equipment List and Details:

Manufacturer	Description	Model	Serial Number	Calibration Date	Calibration Due Date
R&S	Spectrum Analyzer	FSU26	100147	2022/06/30	2023/06/22
Unknown	Coaxial Cable	C-SJ00-0010	C0010/01	Each time	N/A

* Statement of Traceability: China Certification ICT Co., Ltd (Dongguan) attests that all calibrations have been performed, traceable to National Primary Standards and International System of Units (SI).

Test Data:

Test Modes	Test Frequency (MHz)	Peak Conducted Output Power (dBm)	Limits (dBm)
BDR Mode (GFSK)	2402	-0.45	21
	2441	-0.38	21
	2480	-1.22	21
EDR Mode ($\pi/4$ -DQPSK)	2402	-3.76	21
	2441	-3.81	21
	2480	-3.9	21
EDR Mode (8DPSK)	2402	-3.56	21
	2441	-3.45	21
	2480	-1.16	21

BDR Mode (GFSK)

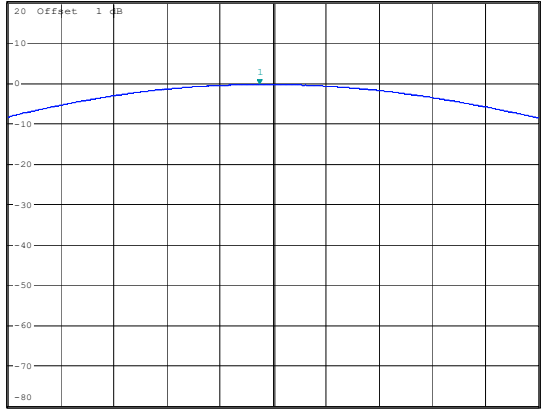
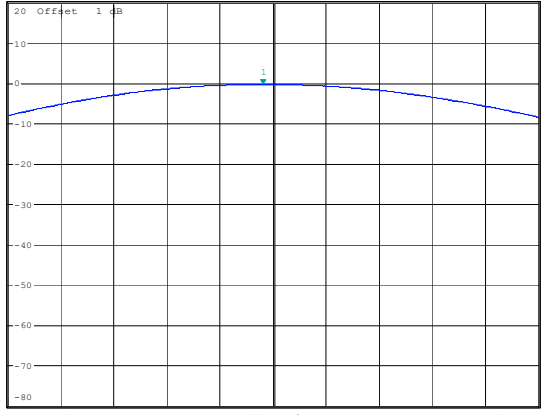
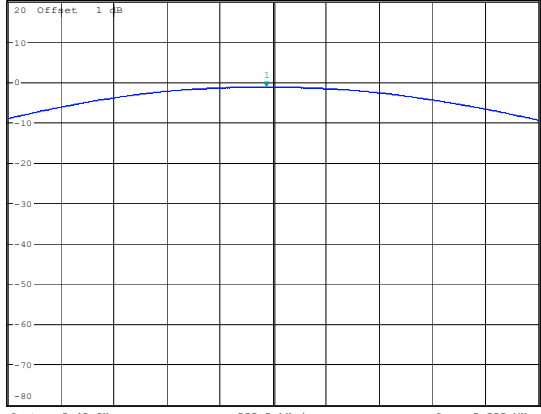
<p>Lowest Channel</p>	<p>Ref 20 dBm *Att 25 dB RBW 3 MHz Marker 1 [T1] -0.45 dBm VBW 10 MHz 2.401861154 GHz SWT 2.5 ms</p>  <p>Center 2.402 GHz 541.5 kHz/ Span 5.415 MHz</p> <p>Date: 19.APR.2023 22:46:02</p>
<p>Middle Channel</p>	<p>Ref 20 dBm *Att 25 dB RBW 3 MHz Marker 1 [T1] -0.38 dBm VBW 10 MHz 2.440897692 GHz SWT 2.5 ms</p>  <p>Center 2.441 GHz 532 kHz/ Span 5.32 MHz</p> <p>Date: 19.APR.2023 22:50:39</p>
<p>Highest Channel</p>	<p>Ref 20 dBm *Att 25 dB RBW 3 MHz Marker 1 [T1] -1.22 dBm VBW 10 MHz 2.479930962 GHz SWT 2.5 ms</p>  <p>Center 2.48 GHz 538.5 kHz/ Span 5.385 MHz</p> <p>Date: 19.APR.2023 22:53:14</p>

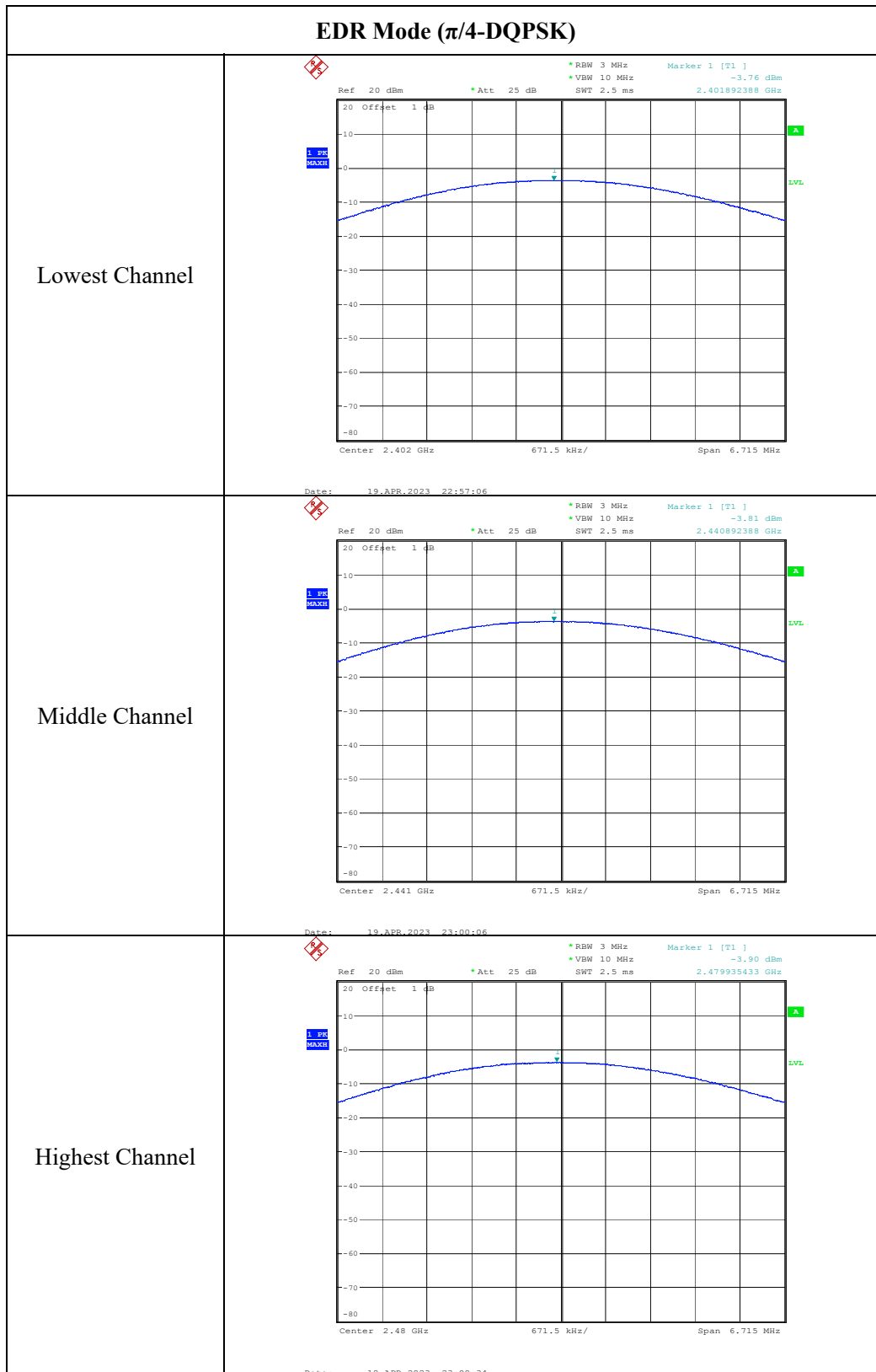

EDR Mode (8DPSK)

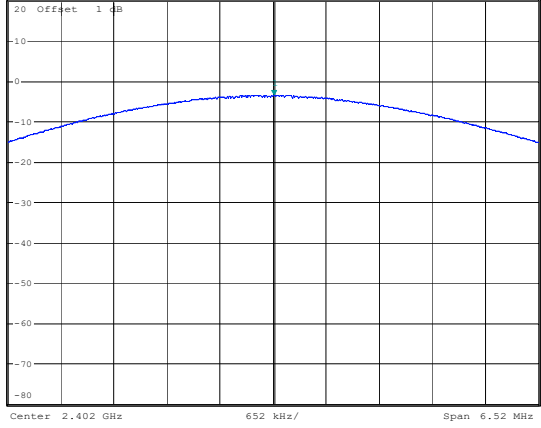
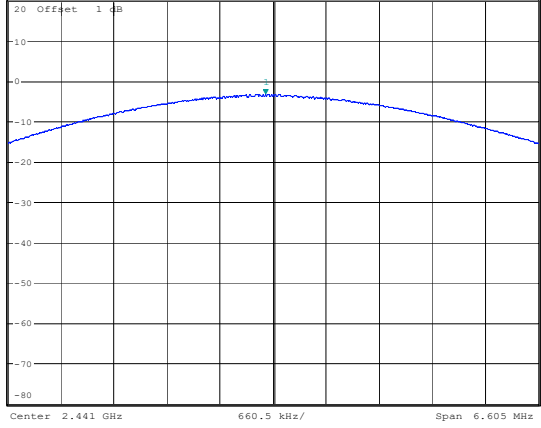
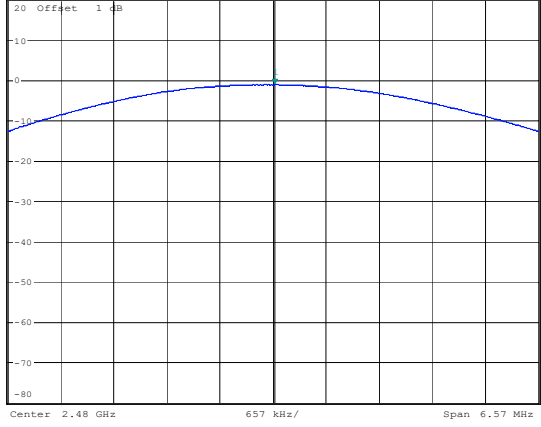
<p>Lowest Channel</p>	<p>Ref 20 dBm *Att 25 dB RBW 3 MHz Marker 1 [T1] -3.56 dBm VBW 10 MHz SWT 2.5 ms 2.402010449 GHz</p>  <p>Center 2.402 GHz 652 kHz/ Span 6.52 MHz</p> <p>Date: 20.APR.2023 19:20:19</p>
<p>Middle Channel</p>	<p>Ref 20 dBm *Att 25 dB RBW 3 MHz Marker 1 [T1] -3.45 dBm VBW 10 MHz SWT 2.5 ms 2.440904736 GHz</p>  <p>Center 2.441 GHz 660.5 kHz/ Span 6.605 MHz</p> <p>Date: 20.APR.2023 19:21:08</p>
<p>Highest Channel</p>	<p>Ref 20 dBm *Att 25 dB RBW 3 MHz Marker 1 [T1] -1.16 dBm VBW 10 MHz SWT 2.5 ms 2.480021058 GHz</p>  <p>Center 2.48 GHz 657 kHz/ Span 6.57 MHz</p> <p>Date: 19.APR.2023 23:09:38</p>

4.8 100 kHz Bandwidth of Frequency Band Edge:

Serial Number:	237R-1	Test Date:	2023/4/19
Test Site:	RF	Test Mode:	Transmitting
Tester:	Joe Liang	Test Result:	Pass

Environmental Conditions:

Temperature: (°C)	25.7	Relative Humidity: (%)	47	ATM Pressure: (kPa)	101
----------------------	------	------------------------------	----	------------------------	-----

Test Equipment List and Details:

Manufacturer	Description	Model	Serial Number	Calibration Date	Calibration Due Date
R&S	Spectrum Analyzer	FSU26	100147	2022/6/30	2023/6/22
Unknown	Coaxial Cable	C-SJ00-0010	C0010/01	Each time	N/A

* *Statement of Traceability: China Certification ICT Co., Ltd (Dongguan) attests that all calibrations have been performed, traceable to National Primary Standards and International System of Units (SI).*

Test Data:

Band Edge, Single Channel

**BDR Mode
(GFSK),
Left Side**

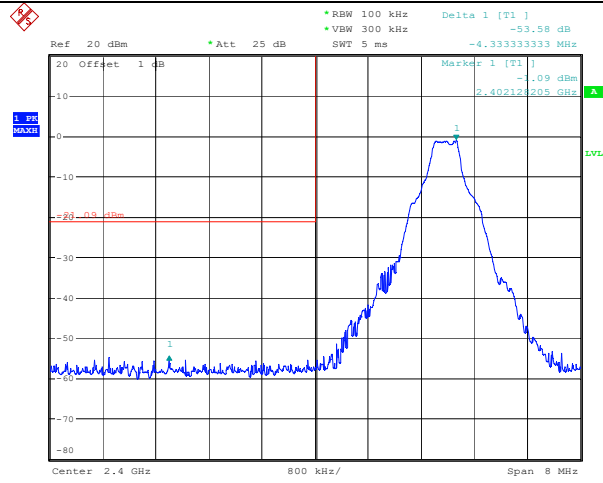

Date: 19.APR.2023 22:49:26

**BDR Mode
(GFSK),
Right Side**

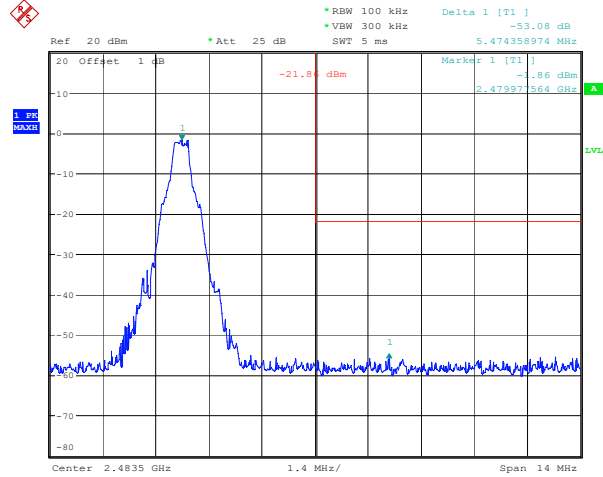

Date: 19.APR.2023 22:55:20

Band Edge, Single Channel

**EDR Mode
($\pi/4$ -DQPSK),
Left Side**

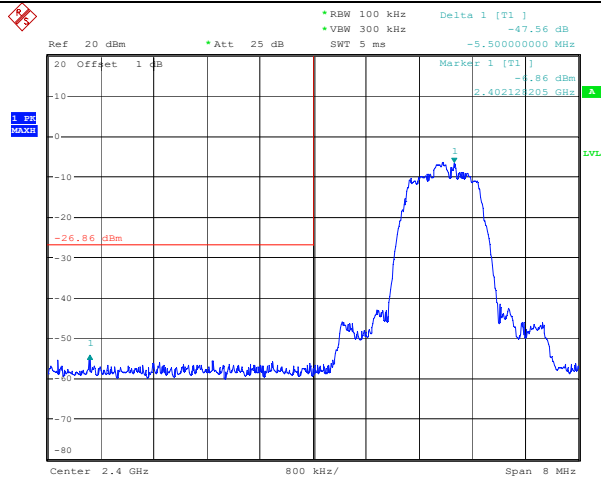

Date: 19.APR.2023 22:57:20

**EDR Mode
($\pi/4$ -DQPSK),
Right Side**

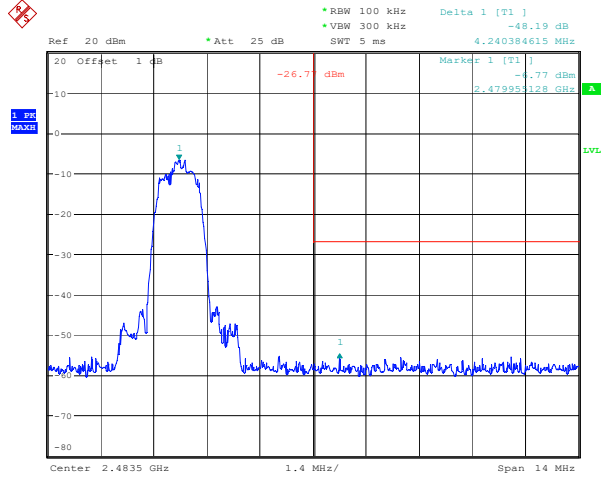

Date: 19.APR.2023 23:01:37

Band Edge, Single Channel

**EDR Mode
(8DPSK),
Left Side**

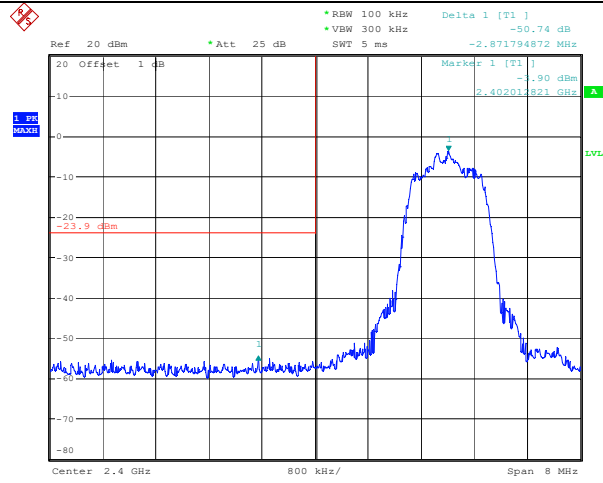

Date: 9 JUN 2023 19:27:22

**EDR Mode
(8DPSK),
Right Side**

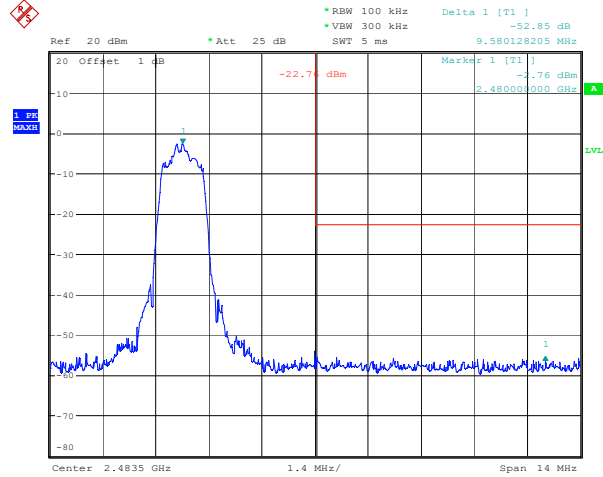

Date: 9 JUN 2023 19:28:07

Band Edge, Hopping Channel

**BDR Mode
(GFSK),
Left Side**

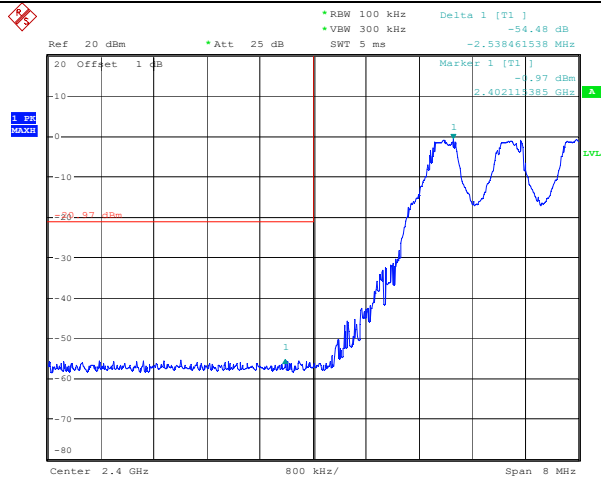

**BDR Mode
(GFSK),
Right Side**

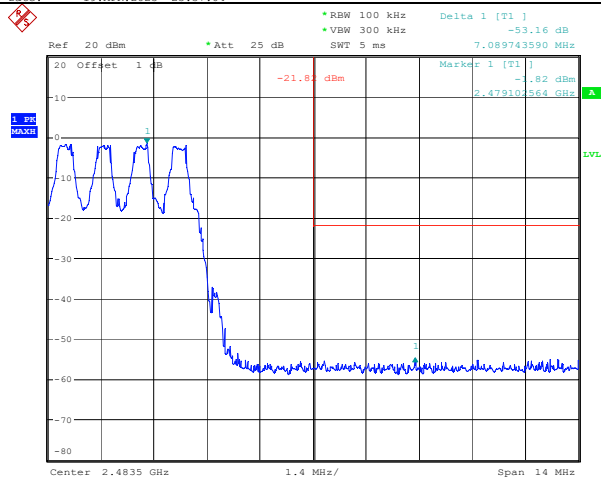

Band Edge, Hopping Channel

**EDR Mode
($\pi/4$ -DQPSK),
Left Side**

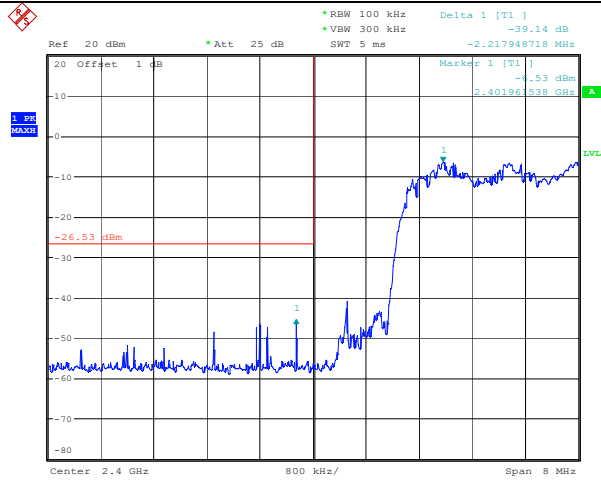

Date: 19.APR.2023 23:34:59

**EDR Mode
($\pi/4$ -DQPSK),
Right Side**

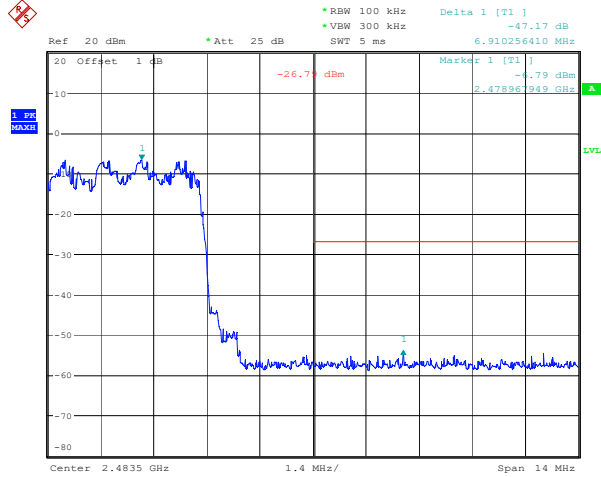

Date: 19.APR.2023 23:35:43

Band Edge, Hopping Channel

**EDR Mode
(8DPSK),
Left Side**

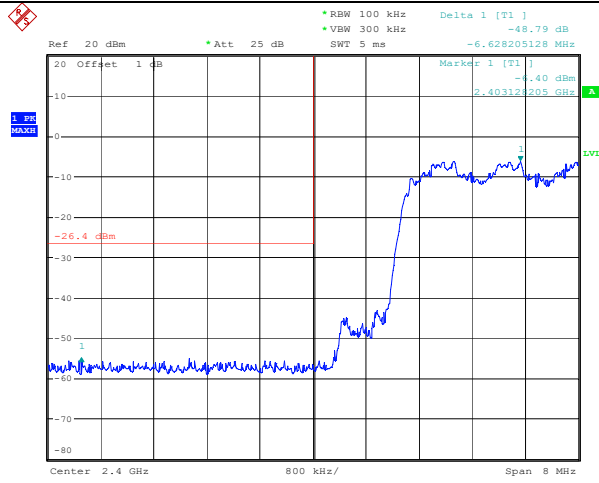

Date: 19.APR.2023 23:39:51

**EDR Mode
(8DPSK),
Right Side**

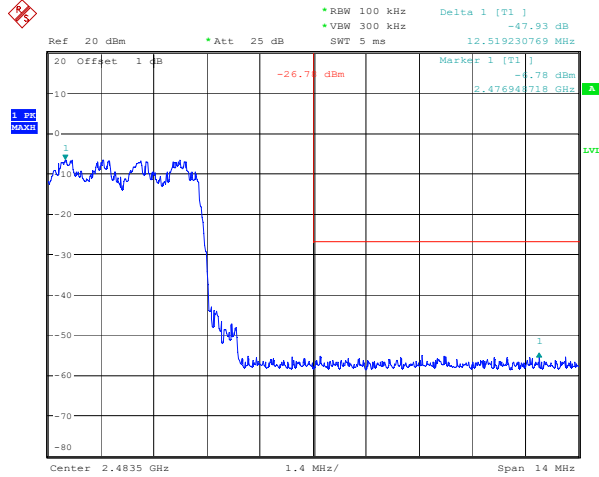

Date: 19.APR.2023 23:42:12

5. RF EXPOSURE EVALUATION

5.1 Applicable Standard

FCC §15.247 (i)

Systems operating under the provisions of this section shall be operated in a manner that ensures that the public is not exposed to radio frequency energy levels in excess of the Commission's guidelines. See §1.1307(b)(1) of this chapter.

5.2 Procedure

According to §1.1307(b)(3)(i)

(C) Or using Table 1 and the minimum separation distance (R in meters) from the body of a nearby person for the frequency (f in MHz) at which the source operates, the ERP (watts) is no more than the calculated value prescribed for that frequency. For the exemption in Table 1 to apply, R must be at least $\lambda/2\pi$, where λ is the free-space operating wavelength in meters. If the ERP of a single RF source is not easily obtained, then the available maximum time-averaged power may be used in lieu of ERP if the physical dimensions of the radiating structure(s) do not exceed the electrical length of $\lambda/4$ or if the antenna gain is less than that of a half-wave dipole (1.64 linear value).

Table 1 to § 1.1307(b)(3)(i)(C) - Single RF Sources Subject to Routine Environmental Evaluation

RF Source frequency (MHz)	Threshold ERP (watts)
0.3-1.34	$1,920 R^2$.
1.34-30	$3,450 R^2/f^2$.
30-300	$3.83 R^2$.
300-1,500	$0.0128 R^2f$.
1,500-100,000	$19.2R^2$.

5.3 Measurement Result

Radio	Frequency (MHz)	$\lambda / 2\pi$ (mm)	Distance (mm)	Exemption ERP (mW)	Maximum Conducted Power including Tune-up Tolerance (dBm)	Antenna Gain (dBi)	ERP		MPE-Based Exemption
							dBm	mW	
2.4G WLAN	2412-2472	19.80	200	768	7	3.70	8.55	7.16	Compliant
BLE	2402-2480	19.88	200	768	9	3.70	10.55	11.35	Compliant
BDR/EDR	2402-2480	19.88	200	768	0	3.70	1.55	1.43	Compliant

Note:

The Maximum Conducted Power including Tune-up Tolerance was declared by manufacturer.

Result: The device compliant the MPE-Based Exemption at 20cm distances.

===== END OF REPORT =====