

# TEST REPORT

**Product Name** : Pos Terminal  
**Model Number** : C1, C1A, C1B, C1P, C1Q, C1 Pro  
**FCC ID** : 2AJ2B-C1

**Prepared for** : Telepower Communication Co., Ltd.  
**Address** : 5 Bld, Zone A, Hantian Technology Town No.17 ShenHai RD,  
Nanhai District, Foshan, China

**Prepared by** : EMTEK (SHENZHEN) CO., LTD.  
**Address** : Building 69, Majialong Industry Zone, Nanshan District,  
Shenzhen, Guangdong, China

Tel: (0755) 26954280  
Fax: (0755) 26954282

**Report Number** : ENS2204290166W00204R  
**Date(s) of Tests** : April 29, 2022 to July 1, 2022  
**Date of issue** : July 1, 2022

# 1 TEST RESULT CERTIFICATION

Applicant : Telepower Communication Co., Ltd.  
 Address : 5 Bld, Zone A, Hantian Technology Town No.17 ShenHai RD, Nanhai District, Foshan, China  
 Manufacturer : Telepower Communication Co., Ltd.  
 Address : 5 Bld, Zone A, Hantian Technology Town No.17 ShenHai RD, Nanhai District, Foshan, China  
 EUT : Pos Terminal  
 Model Name : C1, C1A, C1B, C1P, C1Q, C1 Pro  
 Trademark : **Telpo**

Measurement Procedure Used:

APPLICABLE STANDARDS	
STANDARD	TEST RESULT
FCC 47 CFR Part 2, Subpart J FCC 47 CFR Part 15, Subpart E	PASS
IC RSS-GEN, Issue 5(04-2018)+A1(03-2019)+A2(02-2021) IC RSS-247 Issue 2(02-2017)	PASS

The above equipment was tested by EMTEK (SHENZHEN) CO., LTD. The test data, data evaluation, test procedures, and equipment configurations shown in this report were made in accordance with the procedures given in ANSI C63.10 (2013) and the energy emitted by the sample EUT tested as described in this report is in compliance with the requirements of FCC Rules Part 2, Part 15.407, IC RSS-247 Issue 2 and IC RSS-GEN, Issue 5.

The test results of this report relate only to the tested sample identified in this report.

Date of Test : April 29, 2022 to July 1, 2022

Prepared by : *Luo Pei Ye*  
 Luo peiye /Editor

Reviewer : *Joe Xia*  
 Joe Xia/Supervisor

Approve & Authorized Signer : *[Signature]*  
 Lisa Wang/Manager



## Modified History

Version	Report No.	Revision Date	Summary
V1.0	ENS2204290166W00204R	/	Original Report



**TABLE OF CONTENTS**

<b>1</b>	<b>TEST RESULT CERTIFICATION</b> .....	<b>2</b>
<b>2</b>	<b>EUT TECHNICAL DESCRIPTION</b> .....	<b>5</b>
<b>3</b>	<b>SUMMARY OF TEST RESULT</b> .....	<b>7</b>
<b>4</b>	<b>TEST METHODOLOGY</b> .....	<b>8</b>
4.1	GENERAL DESCRIPTION OF APPLIED STANDARDS .....	8
4.2	MEASUREMENT EQUIPMENT USED .....	8
4.3	DESCRIPTION OF TEST MODES .....	10
<b>5</b>	<b>FACILITIES AND ACCREDITATIONS</b> .....	<b>14</b>
5.1	FACILITIES .....	14
5.2	EQUIPMENT .....	14
5.3	LABORATORY ACCREDITATIONS AND LISTINGS .....	14
<b>6</b>	<b>TEST SYSTEM UNCERTAINTY</b> .....	<b>15</b>
<b>7</b>	<b>SETUP OF EQUIPMENT UNDER TEST</b> .....	<b>16</b>
7.1	RADIO FREQUENCY TEST SETUP .....	16
7.2	RADIO FREQUENCY TEST SETUP .....	16
7.3	CONDUCTED EMISSION TEST SETUP .....	18
7.4	BLOCK DIAGRAM CONFIGURATION OF TEST SYSTEM .....	19
7.5	SUPPORT EQUIPMENT .....	19
<b>8</b>	<b>TEST REQUIREMENTS</b> .....	<b>20</b>
8.1	BANDWIDTH MEASUREMENT .....	20
8.2	MAXIMUM CONDUCTED OUTPUT POWER .....	94
8.3	MAXIMUM PEAK POWER DENSITY .....	128
8.4	UNDESIRABLE RADIATED SPURIOUS EMISSION .....	162
8.5	POWER LINE CONDUCTED EMISSIONS .....	191
8.6	ANTENNA APPLICATION .....	194

## 2 EUT TECHNICAL DESCRIPTION

Characteristics	Description
<b>Product:</b>	Pos Terminal
<b>Model Number:</b>	C1, C1A, C1B, C1P, C1Q, C1 Pro (These models are identical in circuitry and electrical, mechanical and physical construction; Only indicates for different market purposes; We chose C1 as the final test prototype)
<b>Sample Number:</b>	2#
<b>Wifi Type:</b>	Wifi 5G with 5150MHz-5250MHz Band Wifi 5G with 5250MHz-5350MHz Band Wifi 5G with 5470MHz-5725MHz Band Wifi 5G with 5725MHz-5850MHz Band
<b>WLAN Supported:</b>	802.11a/n/ac
<b>Data Rate :</b>	802.11a: 54/48/36/24/18/12/9/6Mbps 802.11n: MCS0-MCS15 802.11ac: MCS0-MCS9
<b>Modulation:</b>	OFDM with BPSK/QPSK/16QAM/64QAM for 802.11a/n OFDM with BPSK/QPSK/16QAM/64QAM/256QAM for 802.11ac
<b>Frequency Range:</b>	UNII-1: 5150MHz-5250MHz Band  5180-5240MHz for 802.11a/n(HT20)/ac(VHT20); 5190-5230MHz for 802.11n(HT40)/ac(VHT40); 5210MHz for 802.11ac(VHT80);
	UNII-2A: 5250MHz-5350MHz Band  5260-5320MHz for 802.11a/n(HT20)/ac(VHT20); 5270-5310MHz for 802.11n(HT40)/ac(VHT40); 5290MHz for 802.11ac(VHT80);
	UNII-2C: 5470MHz-5725MHz Band  5500-5700MHz for 802.11a/n(HT20)/ac(VHT20); 5510-5670MHz for 802.11n(HT40)/ac(VHT40); 5530MHz for 802.11ac(VHT80);
	UNII-3 with 5725MHz-5850MHz Band  5745-5825MHz for 802.11a/n(HT20)/ac(VHT20); 5755-5795MHz for 802.11n(HT40)/ac(VHT40); 5775MHz for 802.11ac(VHT80);
<b>TPC Function:</b>	Not Applicable
<b>Antenna Type:</b>	FPC Antenna
<b>Antenna Gain:</b>	6.7 dBi

<b>Transmit Power:</b>	UNII-1 Band: 14.13 dBm UNII-2A Band: 13.87 dBm UNII-2C Band: 13.65 dBm UNII-3 Band: 11.91 dBm
<b>Power Supply:</b>	DC 24V from adapter
<b>Adapter:</b>	Model: ADS-65HI-19A-3 24060E Input: AC100-240, 50Hz/60Hz, 1.5A Output: DC24V, 2.5A, 64.0W
<b>Test Voltage:</b>	AC 120V/60Hz
<b>Date of Received:</b>	April 29, 2022
<b>Temperature Range:</b>	-5°C ~ +45°C

**Note:** For more details, please refer to the User's manual of the EUT.

### 3 SUMMARY OF TEST RESULT

FCC PartClause	IC Part Clause	Test Parameter	Verdict	Remark
15.407 (a) 15.407 (e) 2.1049	RSS-247, 6.2 RSS-Gen 6.7	99% , 6dB and 26dB Bandwidth	PASS	
15.407 (a)	RSS-247, 6.2	Maximum Conducted Output Power	PASS	
15.407 (a)	RSS-247, 6.2	PeakPower Spectral Density	PASS	
15.407 (b) 15.209 15.205	RSS-247, 6.2 RSS-Gen 8.9 RSS-Gen 8.10 RSS-Gen 6.13	RadiatedSpurious Emission	PASS	
15.207	RSS-Gen 8.8	Power Line Conducted Emission	PASS	
15.407(a) 15.203	RSS-Gen 6.8	Antenna Application	PASS	
NOTE1:N/A (Not Applicable)				
NOTE2:According to FCC OET KDB 789033, the report use radiated measurements in the restricted frequency bands. In addition, the radiated test is also performed to ensure the emissions emanating from the device cabinet also comply with the applicable limits.				

RELATED SUBMITTAL(S) / GRANT(S):

This submittal(s) (test report) is intended for **FCC ID: 2AJ2B-C1** filing to comply with Section 15.247 of the FCC Part 15, Subpart C Rules.

## 4 TEST METHODOLOGY

### 4.1 GENERAL DESCRIPTION OF APPLIED STANDARDS

According to its specifications, the EUT must comply with the requirements of the following standards:

FCC 47 CFR Part 2, Subpart J

FCC 47 CFR Part 15, Subpart E

IC RSS-GEN, Issue 5(04-2018)+A1(03-2019)+A2(02-2021)

IC RSS-247 Issue 2(02-2017)

FCC KDB 662911 D01 Multiple Transmitter Output v02r01

FCC KDB 789033 D2 General UNII Test Procedures New Rules v02r01

### 4.2 MEASUREMENT EQUIPMENT USED

#### Conducted Emission Test Equipment

Equipment	Manufacturer	Model No.	Serial No.	Last Cal.	Cal. Interval
EMI Test Receiver	Rohde & Schwarz	ESCI	101384	2022/5/14	1Year
AMN	Rohde & Schwarz	ENV216	101161	2022/5/14	1Year
AMN	Kyoritsu	KNW-407	8-1492-9	2022/5/15	1Year

#### For Spurious Emissions Test

Equipment	Manufacturer	Model No.	Serial No.	Last Cal.	Cal. Interval
Pre-Amplifier	HP	8447F	2944A07999	2022/5/14	1Year
EMI Test Receiver	Rohde & Schwarz	ESCI	101414	2022/5/14	1Year
Bilog Antenna	Schwarzbeck	VULB9163	712	2021/7/5	2 Year
Horn antenna	Schwarzbeck	BBHA9120D	9120D-1178	2020/7/4	2 Year
Pre-Amplifie	Lunar EM	LNA1G18-48	J101113101000 1	2022/5/15	1Year
Spectrum Analyzer	Rohde & Schwarz	FSV40	100967	2022/5/14	1Year
Horn antenna	Schwarzbeck	BBHA9170	9170-399	2021/6/12	2 Year
Cable	H+B	NmSm-05-C15052	N/A	2022/5/15	1 Year
Cable	H+B	NmSm-2-C15201	N/A	2022/5/15	1 Year
Cable	H+B	NmNm-7-C15702	N/A	2022/5/15	1 Year
Cable	H+B	SAC-40G-1	414	2022/5/15	1 Year
Cable	H+B	SUCOFLEX104	MY14871/4	2022/5/15	1 Year
Cable	H+B	BLU18A-NmSm-650 0	D8501	2022/5/15	1 Year
Band reject Filter(50dB)	WI/DE	WRCGV-2400(2400- 2485MHz)	2	2022/5/15	1 Year

#### For other test items:

Equipment	Manufacturer	Model No.	Serial No.	Last Cal.	Cal. Interval
Signal Analyzer	Agilent	N9010A	MY53470879	2022/5/14	1Year
Vector Signal Generater	Agilent	N5182B	MY53050878	2022/5/14	1Year
Analog Signal Generator	Agilent	N5171B	MY53050553	2022/5/14	1Year
Power Meter	Agilent	PS-X10-100	\	2022/5/15	1Year



Blocking Box	THEDA	AD211	TW5451140	2022/5/14	1Year
Switchgroup	THEDA	ETF-025(VASC6)	TW5451008	N/A	N/A
MIMO Matrix Switch	THEDA	4P5TM18	TW5451009	N/A	N/A
Temperature&Humidity Chamber	ESPEC	EL-02KA	12107166	2021/7/3	1 Year



### 4.3 DESCRIPTION OF TEST MODES

The EUT has been tested under its typical operating condition.

The EUT configuration for testing is installed on RF field strength measurement to meet the Commissions requirement and operating in a manner which intends to maximize its emission characteristics in a continuous normal application.

The Transmitter was operated in the normal operating mode. The TX frequency was fixed which was for the purpose of the measurements.

Test of channel included the lowest and middle and highest frequency to perform the test, then record on this report.

Those data rates (802.11a: 54 Mbps; 802.11n(HT20): MCS0; 802.11ac(VHT20): MCS0; 802.11n(HT40): MCS0; 802.11ac(VHT40): MCS0; 802.11ac(VHT80): MCS0;) were used for all test.

Pre-defined engineering program for regulatory testing used to control the EUT for staying in continuous transmitting and receiving mode is programmed.

#### Wifi 5G with U-NII - 1

Frequency and Channel list for 802.11a, 802.11n (HT20), 802.11ac (VHT20):

Channel	Frequency (MHz)	Channel	Frequency (MHz)	Channel	Frequency (MHz)
36	5180	44	5220		
40	5200	48	5240		

Frequency and Channel list for 802.11n (HT40), 802.11ac (VHT40):

Channel	Frequency (MHz)	Channel	Frequency (MHz)	Channel	Frequency (MHz)
38	5190	46	5230		

Frequency and Channel list for 802.11ac (VHT80):

Channel	Frequency (MHz)	Channel	Frequency (MHz)	Channel	Frequency (MHz)
42	5210				

Test Frequency and Channel for 802.11a, 802.11n (HT20), 802.11ac (VHT20):

Lowest Frequency		Middle Frequency		Highest Frequency	
Channel	Frequency (MHz)	Channel	Frequency (MHz)	Channel	Frequency (MHz)
36	5180	40	5200	48	5240

Test Frequency and channel for 802.11n (HT40), 802.11ac (VHT40):

Lowest Frequency		Middle Frequency		Highest Frequency	
Channel	Frequency (MHz)	Channel	Frequency (MHz)	Channel	Frequency (MHz)
38	5190	N/A	N/A	46	5230

Test Frequency and channel for 802.11ac (VHT80) :

Lowest Frequency		Middle Frequency		Highest Frequency	
Channel	Frequency (MHz)	Channel	Frequency (MHz)	Channel	Frequency (MHz)
42	5210	N/A	N/A	N/A	N/A

**Wifi 5G with U-NII -2A**

Frequency and Channel list 802.11a, 802.11n (HT20), 802.11ac (VHT20):

Channel	Frequency (MHz)	Channel	Frequency (MHz)	Channel	Frequency (MHz)
52	5260	60	5300		
56	5280	64	5320		

Frequency and Channel list for 802.11n (HT40), 802.11ac (VHT40):

Channel	Frequency (MHz)	Channel	Frequency (MHz)	Channel	Frequency (MHz)
54	5270				
62	5310				

Frequency and Channel list for 802.11ac (VHT80):

Channel	Frequency (MHz)	Channel	Frequency (MHz)	Channel	Frequency (MHz)
58	5290				

Test Frequency and Channel for 802.11a, 802.11n (HT20), 802.11ac (VHT20):

Lowest Frequency		Middle Frequency		Highest Frequency	
Channel	Frequency (MHz)	Channel	Frequency (MHz)	Channel	Frequency (MHz)
52	5260	56	5280	64	5320

Test Frequency and channel for 802.11n (HT40), 802.11ac (VHT40):

Lowest Frequency		Middle Frequency		Highest Frequency	
Channel	Frequency (MHz)	Channel	Frequency (MHz)	Channel	Frequency (MHz)
54	5270	N/A	N/A	62	5310

Test Frequency and channel for 802.11ac (VHT80):

Lowest Frequency		Middle Frequency		Highest Frequency	
Channel	Frequency (MHz)	Channel	Frequency (MHz)	Channel	Frequency (MHz)
58	5290				

**Wifi 5G with U-NII -2C**

Frequency and Channel list for 802.11a, 802.11n (HT20), 802.11ac (VHT20):

Channel	Frequency (MHz)	Channel	Frequency (MHz)	Channel	Frequency (MHz)
100	5500	116	5580	132	5660
104	5520	120	5600	136	5680
108	5540	124	5620	140	5700
112	5560	128	5640		

Frequency and Channel list for 802.11n (HT40), 802.11ac (VHT40):

Channel	Frequency (MHz)	Channel	Frequency (MHz)	Channel	Frequency (MHz)
102	5510	118	5590	134	5670
110	5550	126	5630		

Frequency and Channel list for 802.11ac (VHT80):

Channel	Frequency (MHz)	Channel	Frequency (MHz)	Channel	Frequency (MHz)
106	5530	122	5610		

**Test** Frequency and Channel for 802.11a, 802.11n (HT20), 802.11ac (VHT20):

Lowest Frequency		Middle Frequency		Highest Frequency	
Channel	Frequency (MHz)	Channel	Frequency (MHz)	Channel	Frequency (MHz)
100	5500	120	5600	140	5700

**Test** Frequency and channel for 802.11n (HT40), 802.11ac (VHT40):

Lowest Frequency		Middle Frequency		Highest Frequency	
Channel	Frequency (MHz)	Channel	Frequency (MHz)	Channel	Frequency (MHz)
102	5510			134	5670

**Test** Frequency and channel for 802.11ac (VHT80):

Lowest Frequency		Middle Frequency		Highest Frequency	
Channel	Frequency (MHz)	Channel	Frequency (MHz)	Channel	Frequency (MHz)
106	5530				

**Wifi 5G with U-NII -3**

Frequency and Channel list for 802.11a, 802.11n (HT20), 802.11ac (VHT20):

Channel	Frequency (MHz)	Channel	Frequency (MHz)	Channel	Frequency (MHz)
149	5745	157	5785	165	5825
153	5765	161	5805		

Frequency and Channel list for 802.11n (HT40), 802.11ac (VHT40):

Channel	Frequency (MHz)	Channel	Frequency (MHz)	Channel	Frequency (MHz)
151	5755	159	5795		

Frequency and Channel list for 802.11ac (VHT80):

Channel	Frequency (MHz)	Channel	Frequency (MHz)	Channel	Frequency (MHz)
155	5775				

**Test** Frequency and Channel for 802.11a, 802.11n (HT20), 802.11ac (VHT20):

Lowest Frequency		Middle Frequency		Highest Frequency	
Channel	Frequency (MHz)	Channel	Frequency (MHz)	Channel	Frequency (MHz)
149	5745	157	5785	165	5825

**Test** Frequency and channel for 802.11n (HT40), 802.11ac (VHT40):

Lowest Frequency		Middle Frequency		Highest Frequency	
Channel	Frequency (MHz)	Channel	Frequency (MHz)	Channel	Frequency (MHz)
151	5755	N/A	N/A	159	5795

**Test** Frequency and channel for 802.11ac (VHT80):

Lowest Frequency		Middle Frequency		Highest Frequency	
Channel	Frequency (MHz)	Channel	Frequency (MHz)	Channel	Frequency (MHz)
155	5775				

## 5 FACILITIES AND ACCREDITATIONS

### 5.1 FACILITIES

All measurement facilities used to collect the measurement data are located at:

EMTEK (Shenzhen) Co., Ltd.

Building 69, Majialong Industry Zone District, Nanshan District, Shenzhen, China

The sites are constructed in conformance with the requirements of ANSI C63.7, ANSI C63.4 and CISPR Publication 22.

### 5.2 EQUIPMENT

Radiated emissions are measured with one or more of the following types of linearly polarized antennas: tuned dipole, biconical, log periodic, bi-log, and/or ridged waveguide, horn. Spectrum analyzers with preselectors and quasi-peak detectors are used to perform radiated measurements.

Conducted emissions are measured with Line Impedance Stabilization Networks and EMI Test Receivers.

Calibrated wideband preamplifiers, coaxial cables, and coaxial attenuators are also used for making measurements.

All receiving equipment conforms to CISPR Publication 16-1, "Radio Interference Measuring Apparatus and Measurement Methods."

### 5.3 LABORATORY ACCREDITATIONS AND LISTINGS

#### Site Description

EMC Lab. : **Accredited by CNAS**  
 The Certificate Registration Number is L2291.  
 The Laboratory has been assessed and proved to be in compliance with CNAS-CL01 (identical to ISO/IEC 17025:2017)

**Accredited by FCC**  
 Designation Number: CN1204  
 Test Firm Registration Number: 882943

**Accredited by A2LA**  
 The Certificate Number is 4321.01.

Accredited by Industry Canada  
 The Conformity Assessment Body Identifier is CN0008

Name of Firm : EMTEK (SHENZHEN) CO., LTD.  
 Site Location : Building 69, Majialong Industry Zone,  
 Nanshan District, Shenzhen, Guangdong, China

## 6 TEST SYSTEM UNCERTAINTY

The following measurement uncertainty levels have been estimated for tests performed on the apparatus:

Test Parameter	Measurement Uncertainty
Radio Frequency	$\pm 1 \times 10^{-5}$
Maximum Peak Output Power Test	$\pm 1.0\text{dB}$
Conducted Emissions Test	$\pm 2.0\text{dB}$
Radiated Emission Test	$\pm 2.0\text{dB}$
Power Density	$\pm 2.0\text{dB}$
Occupied Bandwidth Test	$\pm 1.0\text{dB}$
Band Edge Test	$\pm 3\text{dB}$
All emission, radiated	$\pm 3\text{dB}$
Antenna Port Emission	$\pm 3\text{dB}$
Temperature	$\pm 0.5^\circ\text{C}$
Humidity	$\pm 3\%$

Measurement Uncertainty for a level of Confidence of 95%

## 7 SETUP OF EQUIPMENT UNDER TEST

### 7.1 RADIO FREQUENCY TEST SETUP

The WLAN component's antenna ports(s) of the EUT are connected to the measurement instrument per an appropriate attenuator. The EUT is controlled by PC/software to emit the specified signals for the purpose of measurements.

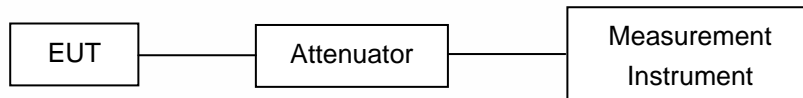

### 7.2 RADIO FREQUENCY TEST SETUP

The test site semi-anechoic chamber has met the requirement of NSA tolerance 4 dB according to the standards: ANSI C63.10. The test distance is 3m. The setup is according to the requirements in Section 13.1.4.1 of ANSI C63.10-2013 and CAN/CSA-CEI/IEC CISPR 22.

Below 30MHz:

The EUT is placed on a turntable 0.8 meters above the ground in the chamber, 3 meter away from the antenna (loop antenna). The Antenna should be positioned with its plane vertical at the specified distance from the EUT and rotated about its vertical axis for maximum response at each azimuth about the EUT. The center of the loop shall be 1 m above the ground. For certain applications, the loop antenna plane may also need to be positioned horizontally at the specified distance from the EUT.

Above 30MHz:

The EUT is placed on a turntable 0.8 meters above the ground in the chamber, 3 meter away from the antenna. The maximal emission value is acquired by adjusting the antenna height, polarisation and turntable azimuth. Normally, the height range of antenna is 1 m to 4 m, the azimuth range of turntable is 0° to 360°, and the receive antenna has two polarizations Vertical (V) and Horizontal (H).

Above 1GHz:

(Note: the FCC's permission to use 1.5m as an alternative per TCBC Conf call of Dec. 2, 2014.)

The EUT is placed on a turntable 1.5 meters above the ground in the chamber, 3 meter away from the antenna. The maximal emission value is acquired by adjusting the antenna height, polarisation and turntable azimuth. Normally, the height range of antenna is 1 m to 4 m, the azimuth range of turntable is 0° to 360°, and the receive antenna has two polarizations Vertical (V) and Horizontal (H).

(a) Radiated Emission Test Set-Up, Frequency Below 30MHz

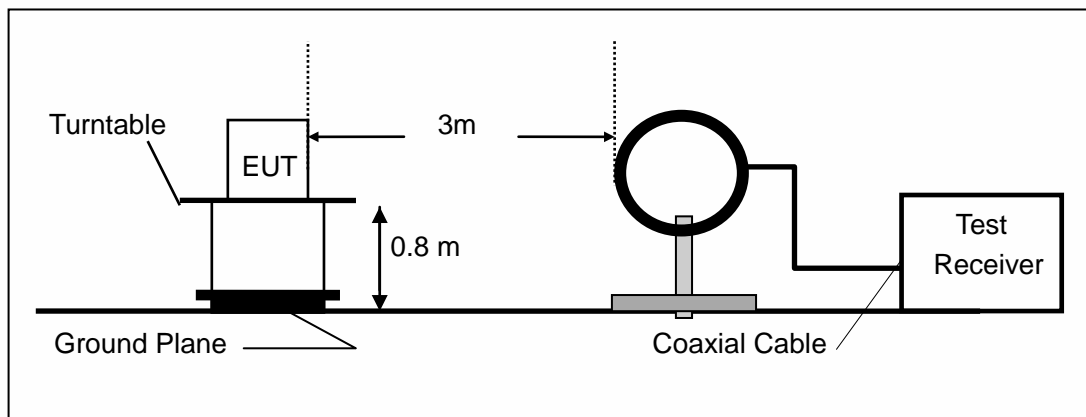



(b) Radiated Emission Test Set-Up, Frequency Below 1000MHz

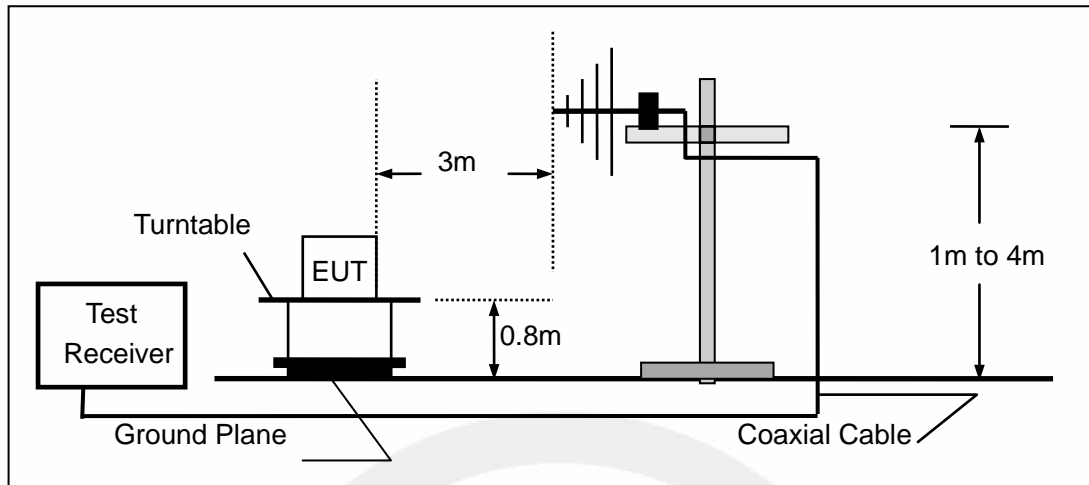

(c) Radiated Emission Test Set-Up, Frequency above 1000MHz

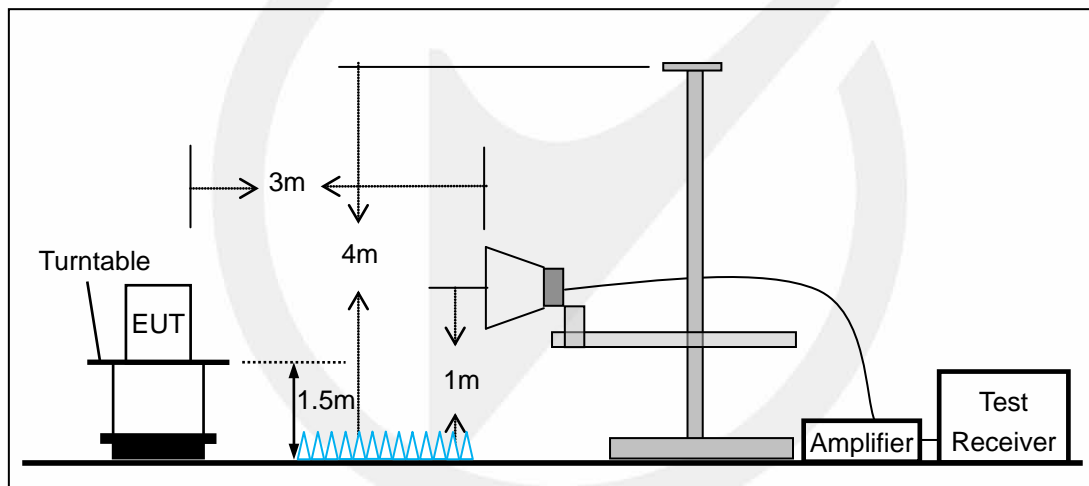

### 7.3 CONDUCTED EMISSION TEST SETUP

The mains cable of the EUT (maybe per AC/DC Adapter) must be connected to LISN. The LISN shall be placed 0.8 m from the boundary of EUT and bonded to a ground reference plane for LISN mounted on top of the ground reference plane. This distance is between the closest points of the LISN and the EUT. All other units of the EUT and associated equipment shall be at least 0.8m from the LISN.

Ground connections, where required for safety purposes, shall be connected to the reference ground point of the LISN and, where not otherwise provided or specified by the manufacturer, shall be of same length as the mains cable and run parallel to the mains connection at a separation distance of not more than 0.1 m.

According to the requirements in Section 13.1.4.1 of ANSI C63.10-2013 Conducted emissions from the EUT measured in the frequency range between 0.15 MHz and 30 MHz using CISPR Quasi-Peak and average detector mode.

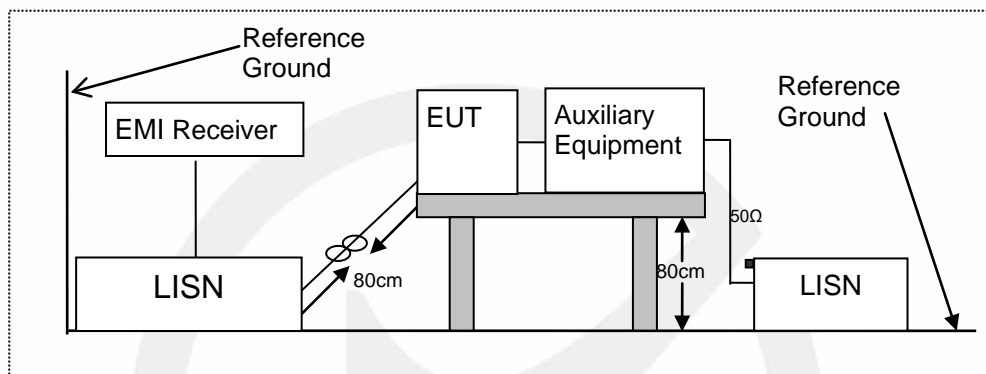

### 7.4 BLOCK DIAGRAM CONFIGURATION OF TEST SYSTEM

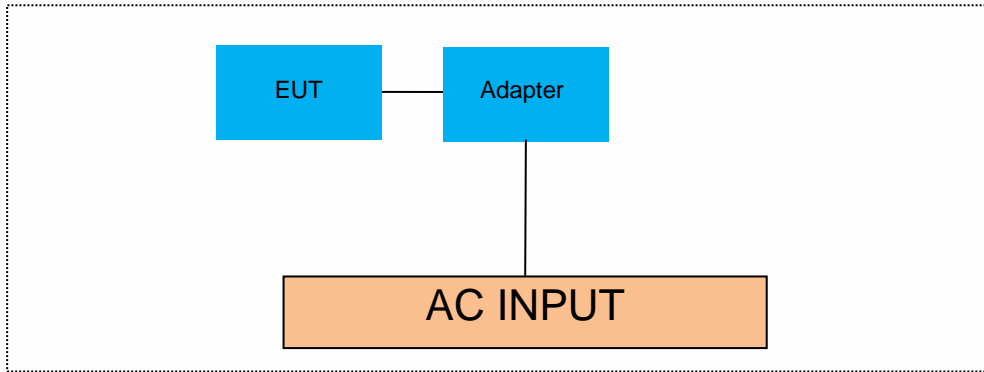

### 7.5 SUPPORT EQUIPMENT

EUT Cable List and Details			
Cable Description	Length (m)	Shielded/Unshielded	With / Without Ferrite
/	/	/	/

Auxiliary Cable List and Details			
Cable Description	Length (m)	Shielded/Unshielded	With / Without Ferrite
/	/	/	/

Auxiliary Equipment List and Details			
Description	Manufacturer	Model	Serial Number
/	/	/	/

**Notes:**

1. All the equipment/cables were placed in the worst-case configuration to maximize the emission during the test.
2. Grounding was established in accordance with the manufacturer’s requirements and conditions for the intended use.

## 8 TEST REQUIREMENTS

### 8.1 BANDWIDTH MEASUREMENT

#### 8.1.1 Applicable Standard

According to FCC Part 15.407(a)(1) for UNII Band I  
According to FCC Part 15.407(a)(2) for UNII Band II-A and UNII Band II-C  
According to FCC Part 15.407(a)(3) for UNII Band III  
According to FCC Part 15.407(e) for UNII Band III  
According to 789033 D02 Section II(C)  
According to 789033 D02 Section II(D)  
According to RSS-Gen6.6, RSS 247, 6.2

#### 8.1.2 Conformance Limit

The 26dB bandwidth is used to determine the conducted power limits.  
Within the 5.725-5.85 GHz band, the minimum 6 dB bandwidth of U-NII devices shall be at least 500 kHz.

#### 8.1.3 Test Configuration

Test according to clause 7.1 radio frequency test setup

#### 8.1.4 Test Procedure

According to 789033 D02 v02r01 section C&D, the following is the measurement procedure.

##### 1. Emission Bandwidth (EBW)

- a) Set RBW = approximately 1% of the emission bandwidth.
- b) Set the VBW > RBW.
- c) Detector = Peak.
- d) Trace mode = max hold.
- e) Measure the maximum width of the emission that is 26 dB down from the maximum of the emission. Compare this with the RBW setting of the analyzer. Readjust RBW and repeat measurement as needed until the RBW/EBW ratio is approximately 1%.

##### 2. Minimum Emission Bandwidth for the band 5.725-5.85 GHz

Section 15.407(e) specifies the minimum 6 dB emission bandwidth of at least 500 KHz for the band 5.715-5.85 GHz. The following procedure shall be used for measuring this bandwidth:

- a) Set RBW = 100 kHz.
- b) Set the video bandwidth (VBW)  $\geq 3 \times$  RBW.
- c) Detector = Peak.
- d) Trace mode = max hold.
- e) Sweep = auto couple.
- f) Allow the trace to stabilize.
- g) Measure the maximum width of the emission that is constrained by the frequencies associated with the two outermost amplitude points (upper and lower frequencies) that are attenuated by 6 dB relative to the maximum level measured in the fundamental emission.

Note: The automatic bandwidth measurement capability of a spectrum analyzer or EMI receiver may be employed if it implements the functionality described above.

##### D. 99 Percent Occupied Bandwidth

The 99-percent occupied bandwidth is the frequency bandwidth such that, below its lower and above its upper frequency limits, the mean powers are each equal to 0.5 % of the total mean power of the given emission. Measurement of the 99-percent occupied bandwidth is required only as a condition for using the optional band-edge measurement techniques described in section II.G.3.d). Measurements of 99-percent occupied bandwidth may also optionally be used in lieu of the EBW to 789033 D02 v01r02 General UNII Test Procedures New Rules v01 define the minimum frequency range over which the spectrum is integrated when measuring maximum conducted output power as described in section II.E.

However, the EBW must be measured to determine bandwidth dependent limits on maximum conducted output power in accordance with 15.407(a).

The following procedure shall be used for measuring (99 %) power bandwidth:

1. Set center frequency to the nominal EUT channel center frequency.
2. Set span = 1.5 times to 5.0 times the OBW.
3. Set RBW = 1 % to 5 % of the OBW
4. Set VBW  $\geq 3 \cdot$  RBW
5. Video averaging is not permitted. Where practical, a sample detection and single sweep mode shall be used. Otherwise, peak detection and max hold mode (until the trace stabilizes) shall be used.
6. Use the 99 % power bandwidth function of the instrument (if available).
7. If the instrument does not have a 99 % power bandwidth function, the trace data points are recovered and directly summed in power units. The recovered amplitude data points, beginning at the lowest frequency, are placed in a running sum until 0.5 % of the total is reached; that frequency is recorded as the lower frequency. The process is repeated until 99.5 % of the total is reached; that frequency is recorded as the upper frequency. The 99% occupied bandwidth is the difference between these two frequencies.



8.1.5 Test Results

Temperature:	25°C
Relative Humidity:	45%
ATM Pressure:	1011 mbar

Note: N/A

TestMode	Antenna	Frequency[MHz]	26db EBW [MHz]	FL[MHz]	FH[MHz]	Limit[MHz]	Verdict
11A	Ant1	5180	22.320	5168.640	5190.960	---	---
		5220	24.400	5208.080	5232.480	---	---
		5240	24.040	5228.240	5252.280	---	---
		5260	24.800	5247.160	5271.960	---	---
		5300	22.560	5288.720	5311.280	---	---
		5320	24.000	5308.360	5332.360	---	---
		5500	24.560	5488.040	5512.600	---	---
		5580	24.040	5568.160	5592.200	---	---
		5700	24.440	5688.080	5712.520	---	---
		5745	23.520	5733.040	5756.560	---	---
		5785	22.040	5773.640	5795.680	---	---
		5825	23.600	5813.720	5837.320	---	---
11N20SISO	Ant1	5180	27.840	5165.880	5193.720	---	---
		5220	24.000	5207.800	5231.800	---	---
		5240	24.240	5227.760	5252.000	---	---
		5260	24.320	5247.440	5271.760	---	---
		5300	25.160	5287.160	5312.320	---	---
		5320	22.560	5308.680	5331.240	---	---
		5500	23.800	5487.960	5511.760	---	---
		5580	22.520	5568.520	5591.040	---	---
		5700	23.680	5688.160	5711.840	---	---
		5745	22.720	5733.560	5756.280	---	---
		5785	23.640	5772.200	5795.840	---	---
		5825	23.800	5814.000	5837.800	---	---
11N40SISO	Ant1	5190	55.600	5162.480	5218.080	---	---
		5230	42.400	5208.800	5251.200	---	---
		5270	41.760	5248.880	5290.640	---	---
		5310	41.760	5288.960	5330.720	---	---
		5510	42.080	5488.880	5530.960	---	---
		5550	41.440	5529.520	5570.960	---	---
		5670	58.400	5632.560	5690.960	---	---
		5755	41.200	5734.680	5775.880	---	---
5795	49.120	5766.360	5815.480	---	---		
11AC20SISO	Ant1	5180	27.800	5166.240	5194.040	---	---
		5220	24.320	5207.880	5232.200	---	---
		5240	24.800	5227.480	5252.280	---	---

		5260	25.600	5247.480	5273.080	---	---
		5300	24.240	5287.400	5311.640	---	---
		5320	25.000	5307.280	5332.280	---	---
		5500	26.200	5486.680	5512.880	---	---
		5580	23.120	5567.720	5590.840	---	---
		5700	22.560	5688.960	5711.520	---	---
		5745	26.040	5731.880	5757.920	---	---
		5785	23.040	5773.720	5796.760	---	---
		5825	22.520	5813.920	5836.440	---	---
11AC40SISO	Ant1	5190	50.080	5165.840	5215.920	---	---
		5230	42.400	5208.720	5251.120	---	---
		5270	42.320	5248.720	5291.040	---	---
		5310	41.920	5288.880	5330.800	---	---
		5510	41.520	5489.040	5530.560	---	---
		5550	40.960	5529.600	5570.560	---	---
		5670	68.160	5638.800	5706.960	---	---
		5755	41.840	5734.360	5776.200	---	---
		5795	45.920	5769.960	5815.880	---	---
11AC80SISO	Ant1	5210	118.560	5145.200	5263.760	---	---
		5290	90.560	5242.320	5332.880	---	---
		5530	117.760	5455.920	5573.680	---	---
		5610	115.520	5541.200	5656.720	---	---
		5775	101.760	5715.000	5816.760	---	---

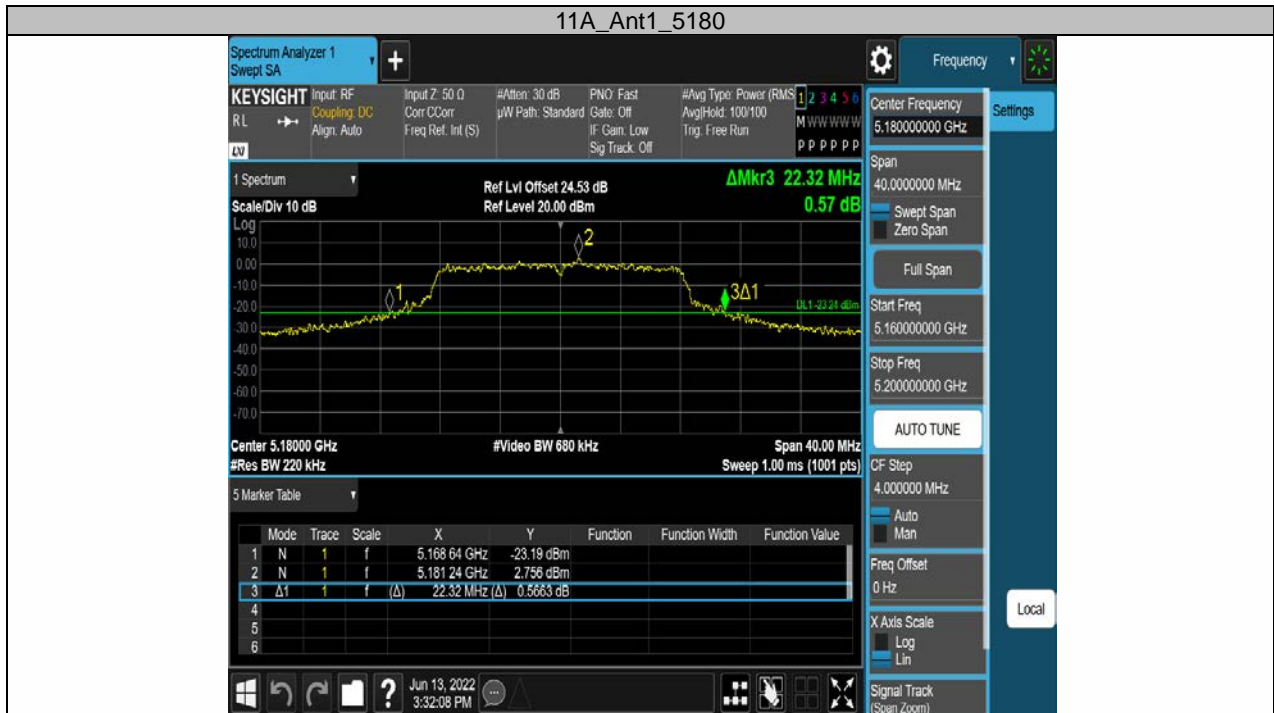



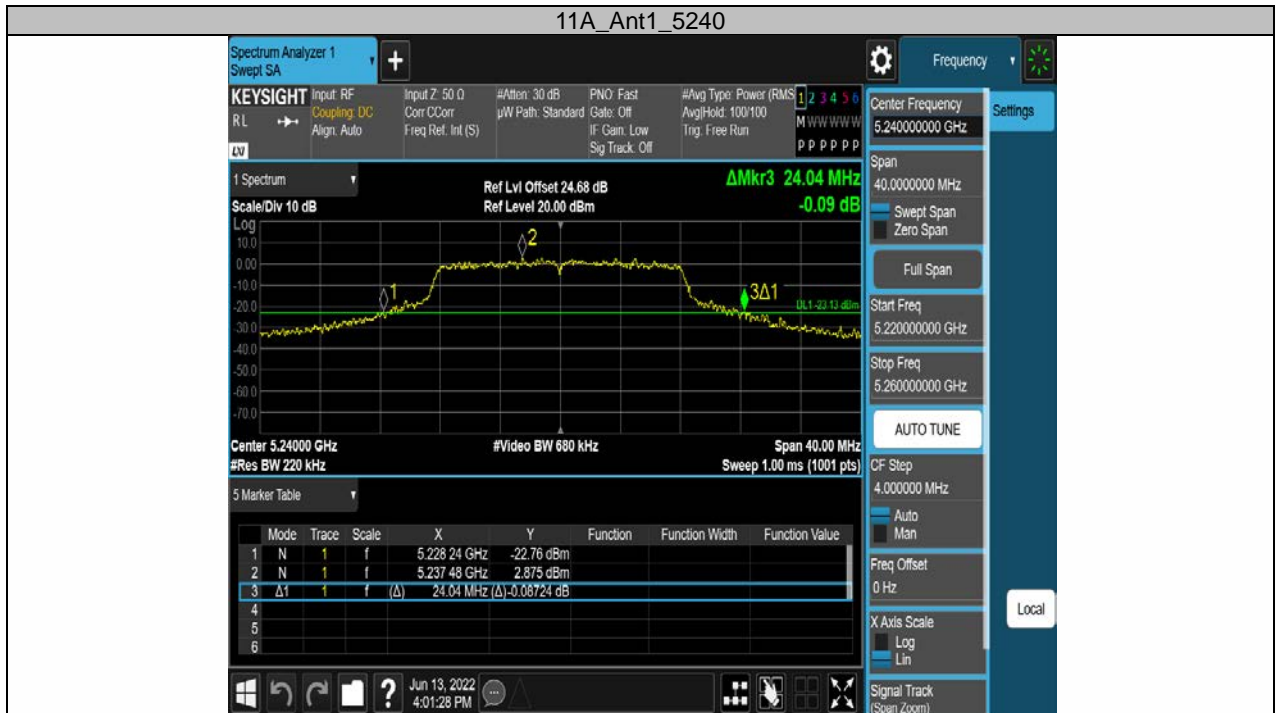

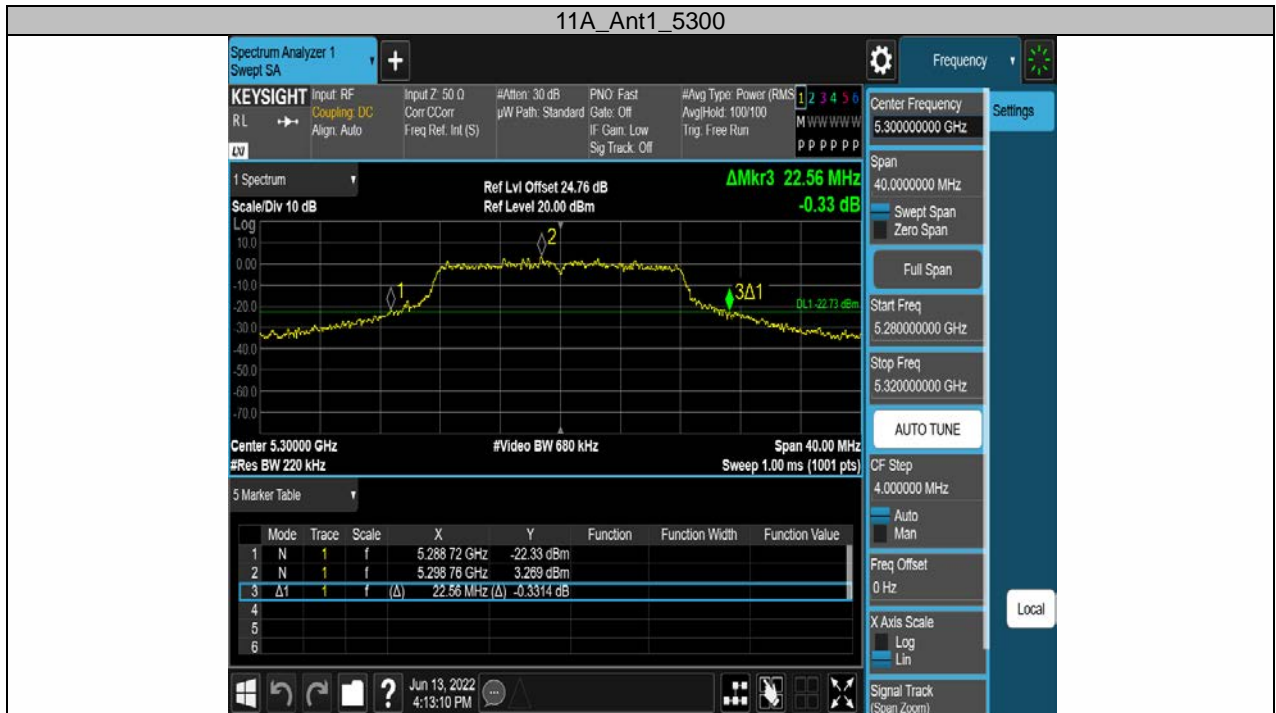





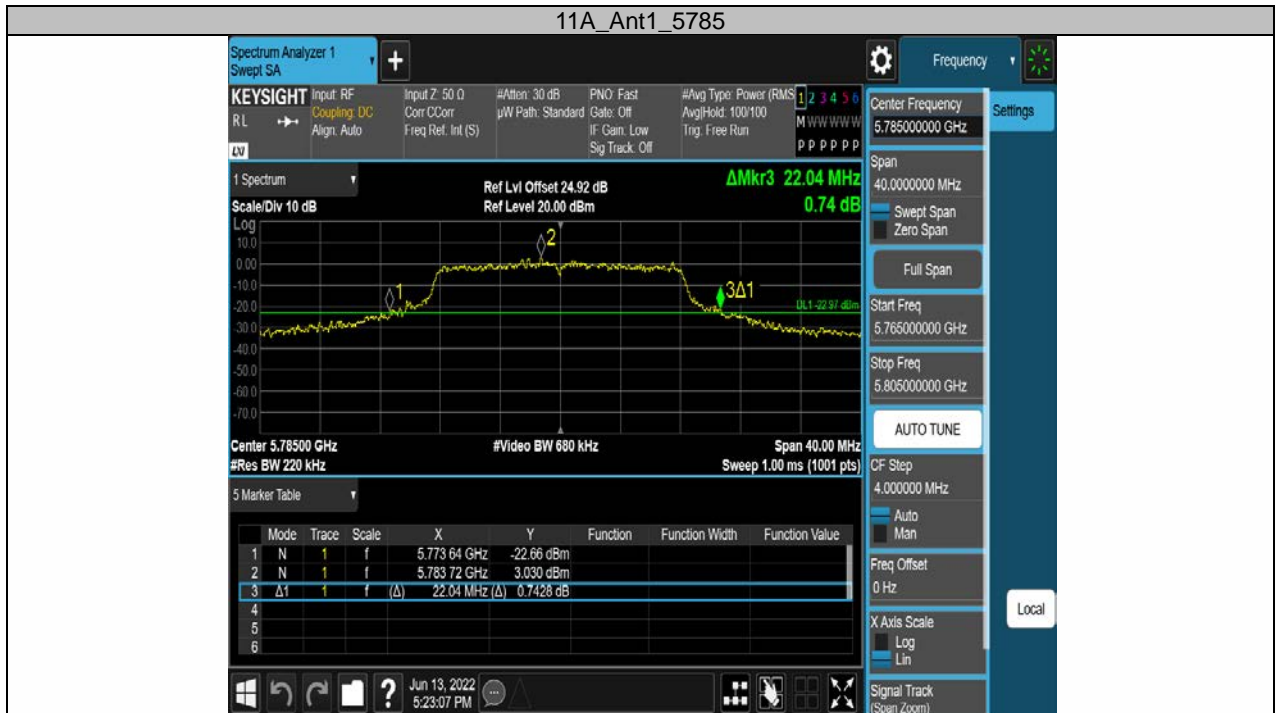



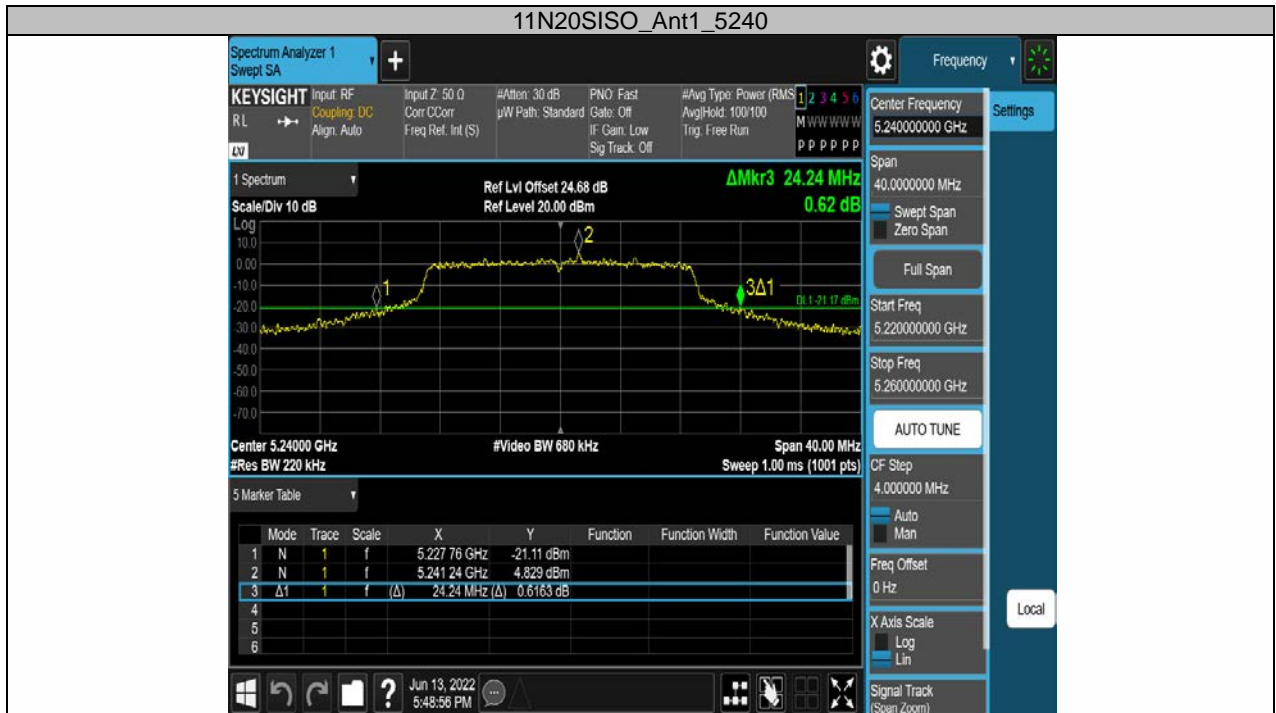







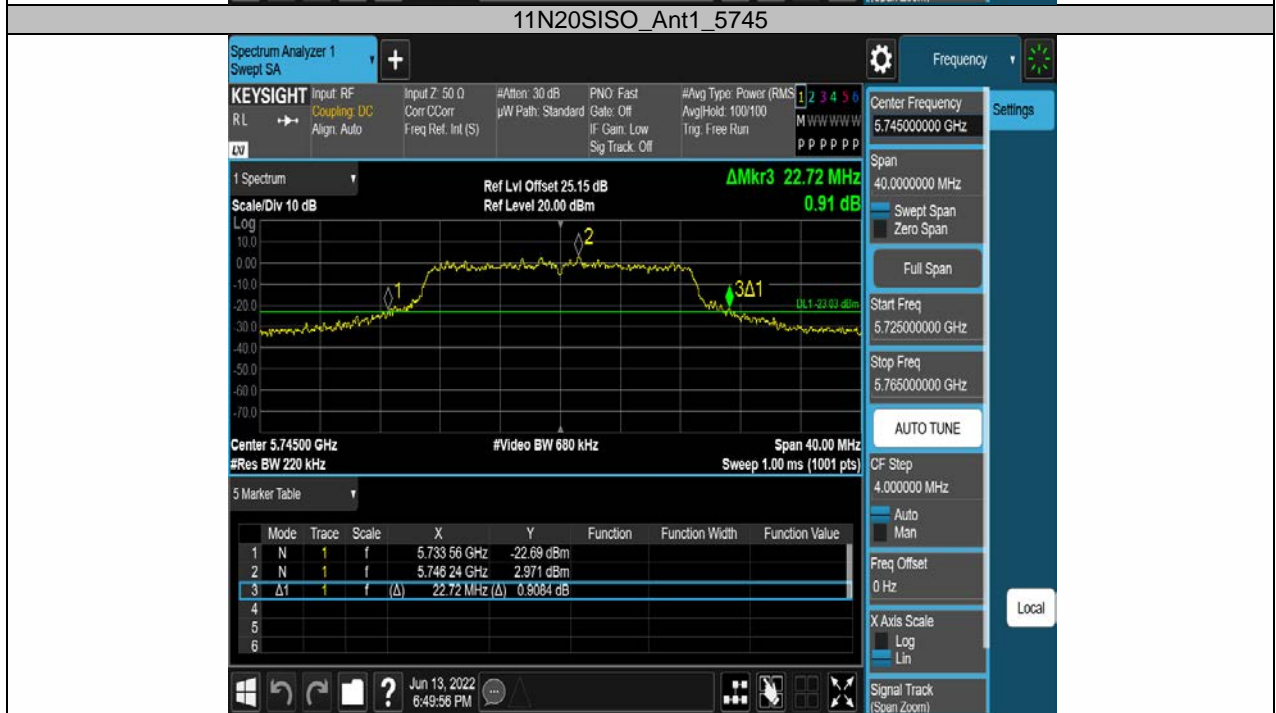

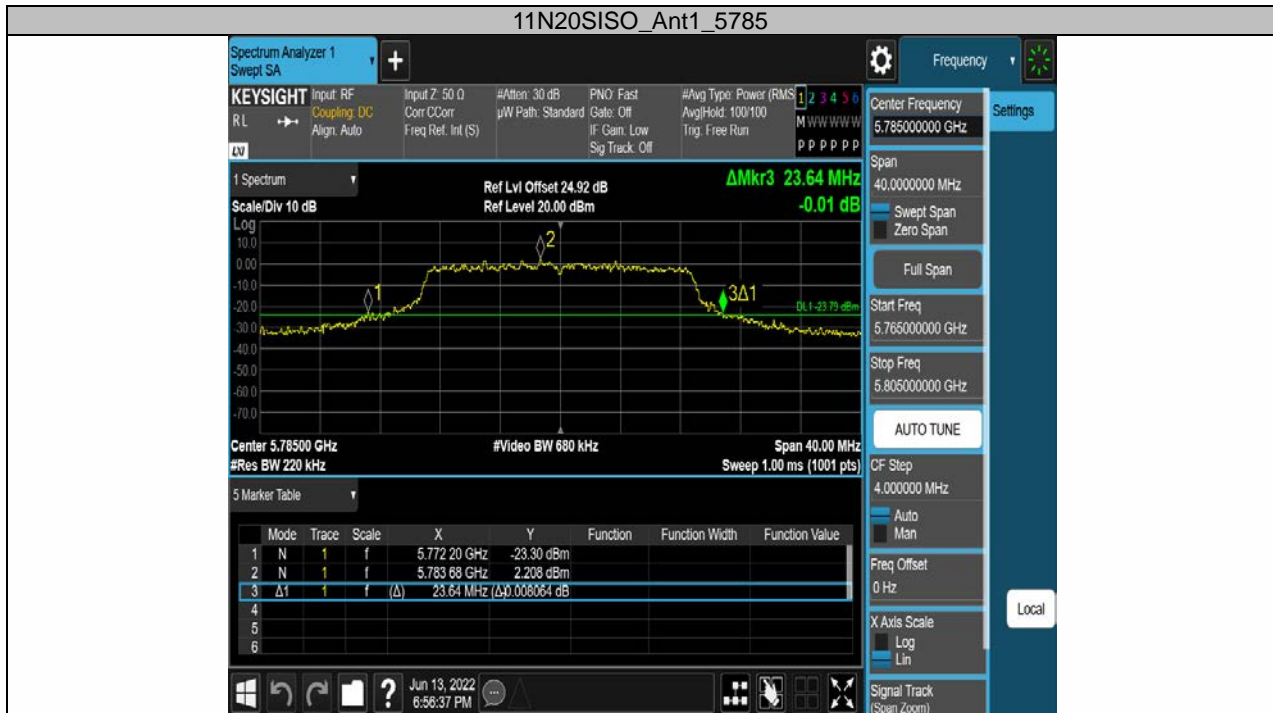





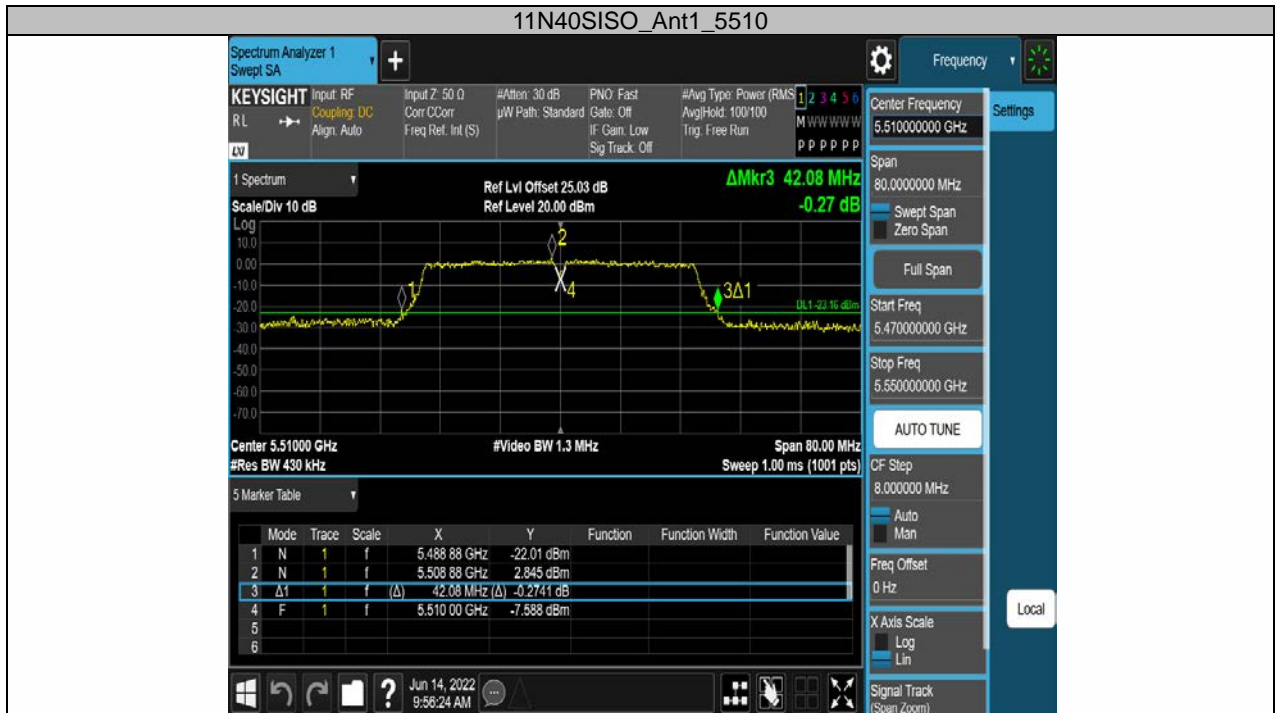

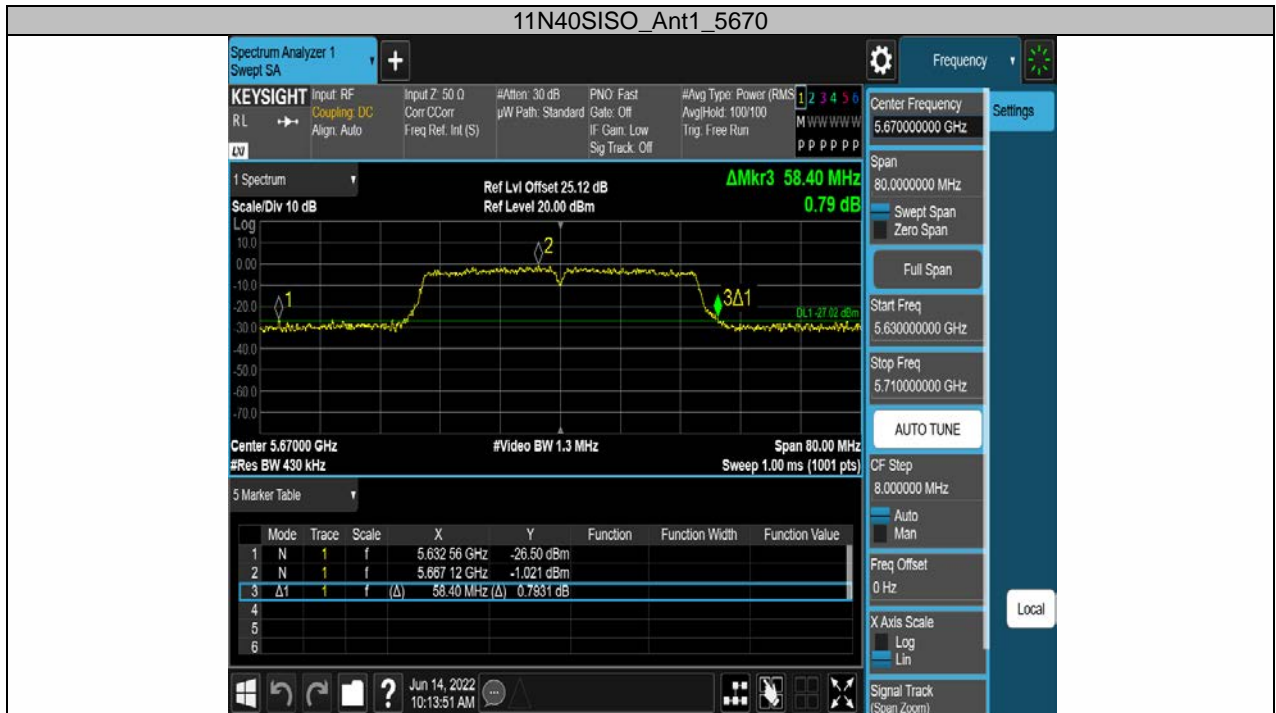





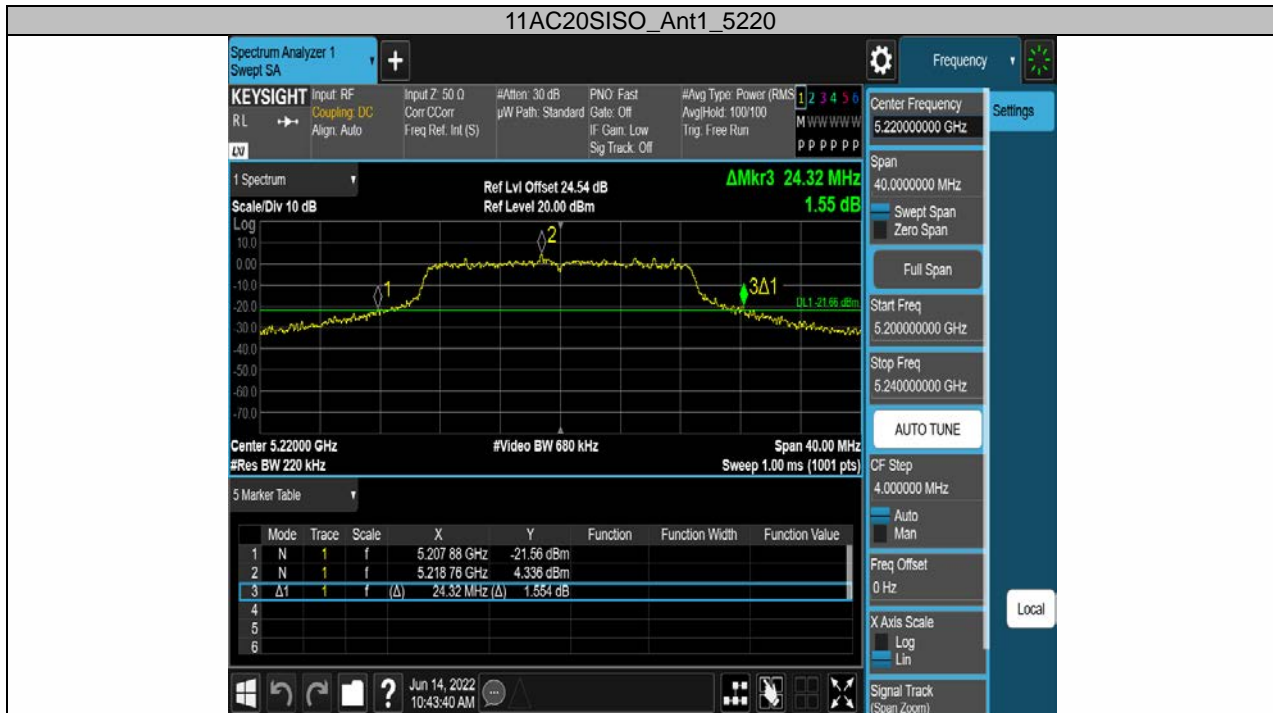



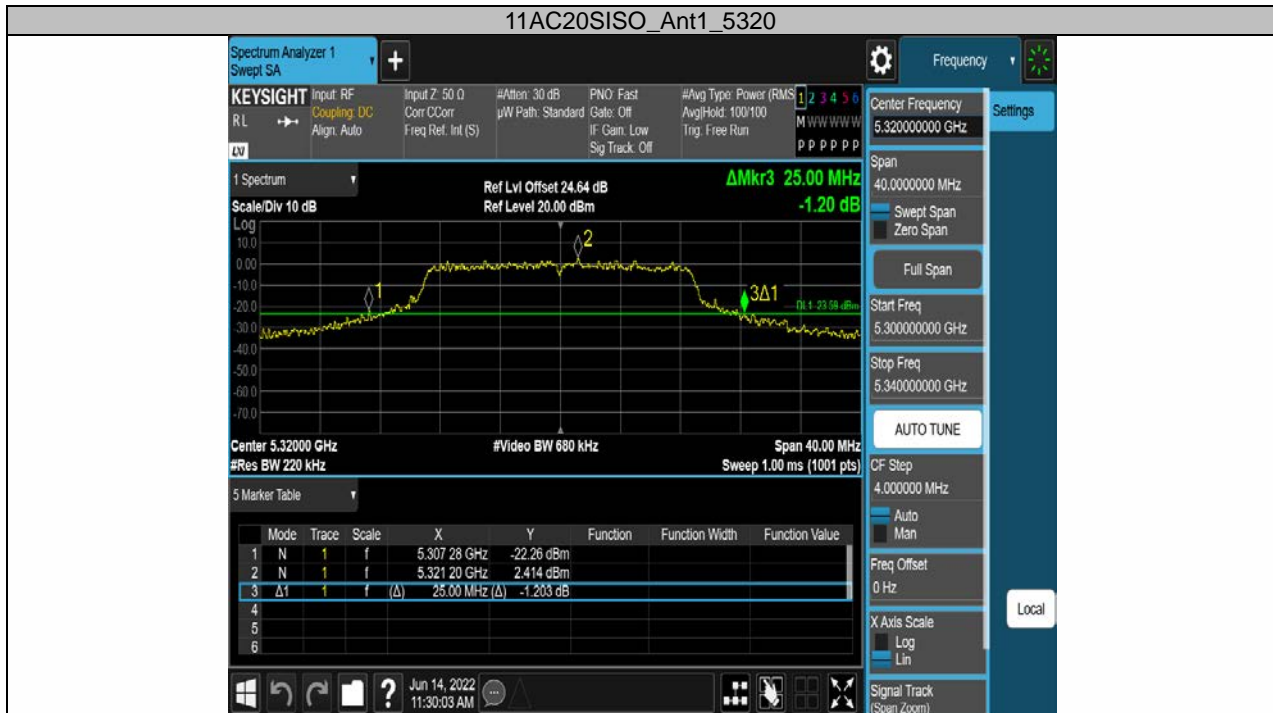

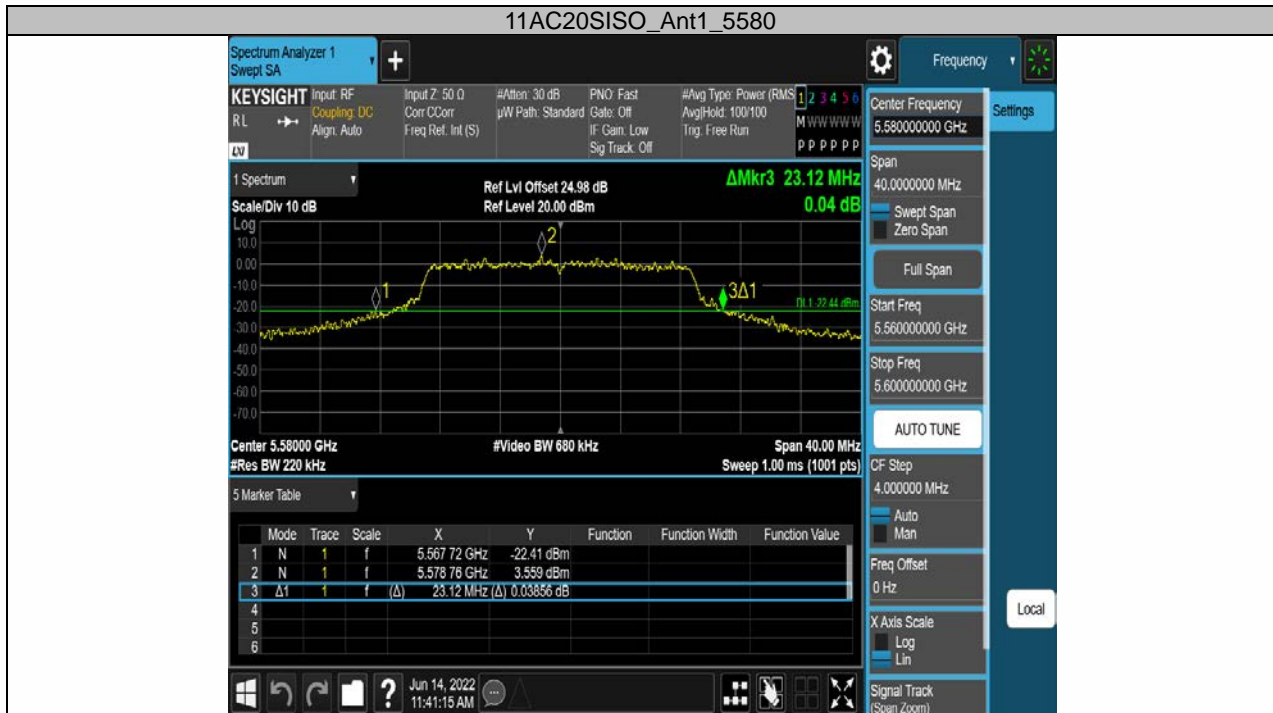

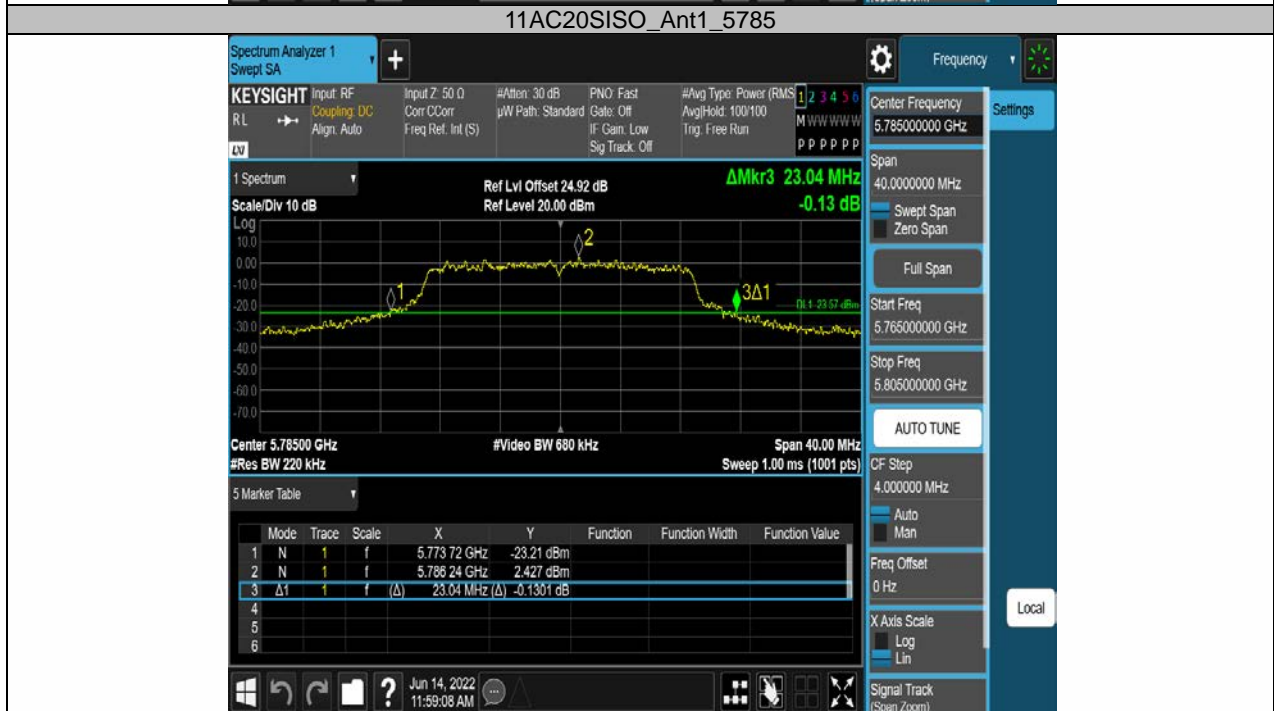
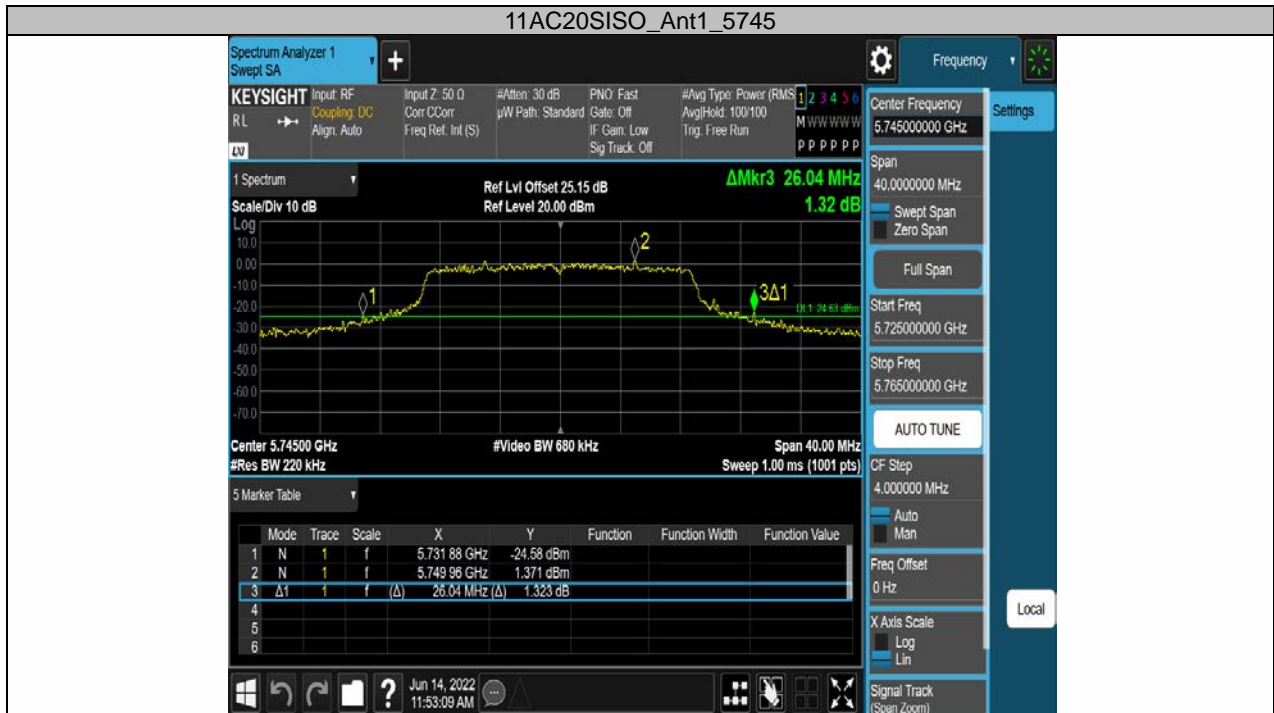

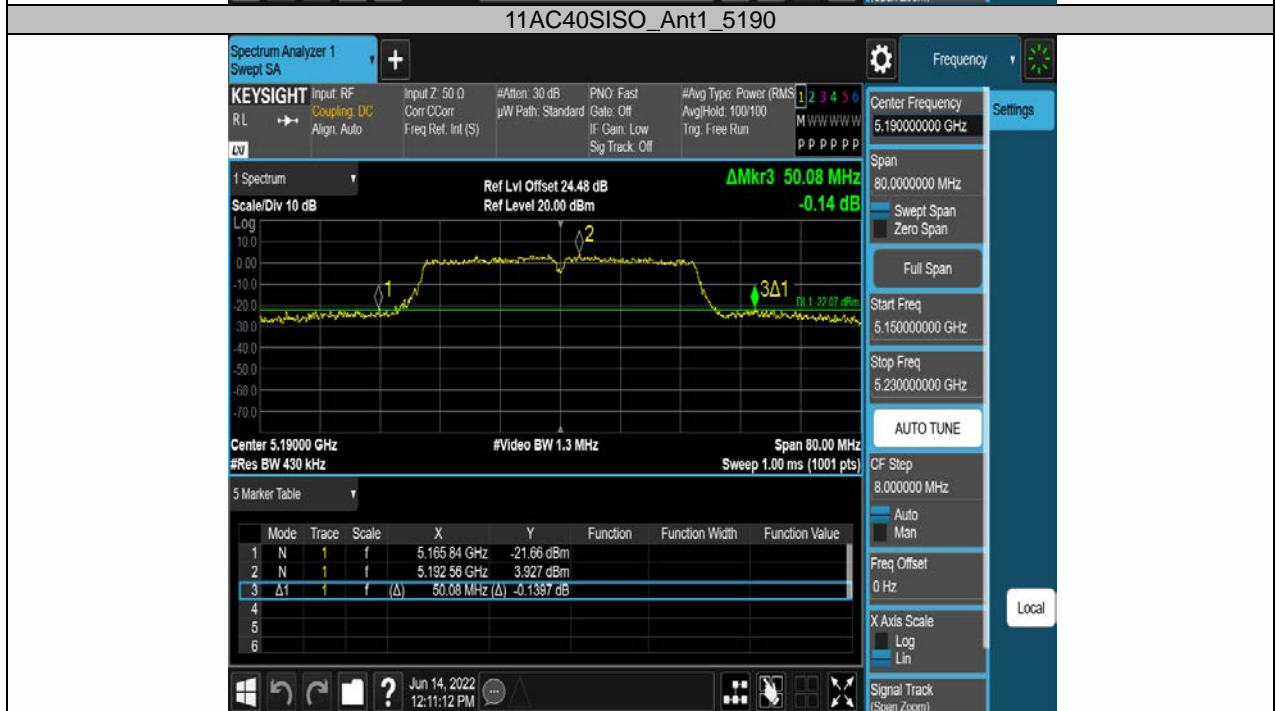
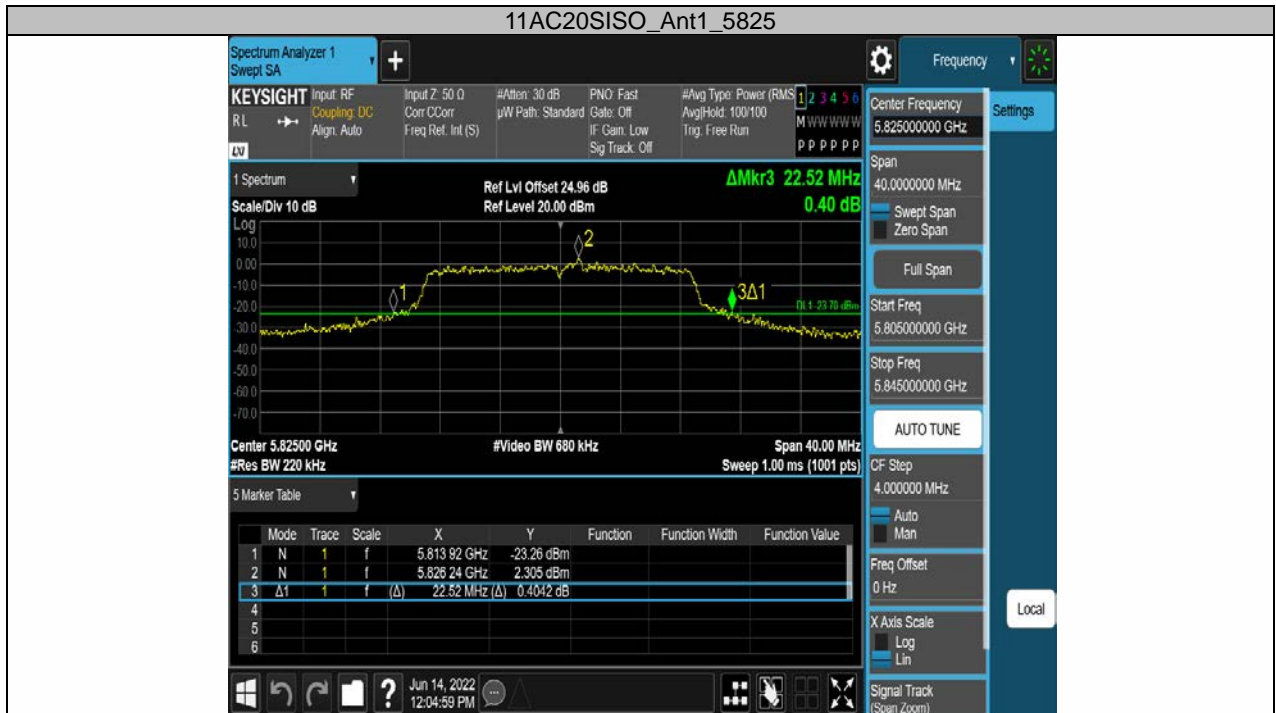

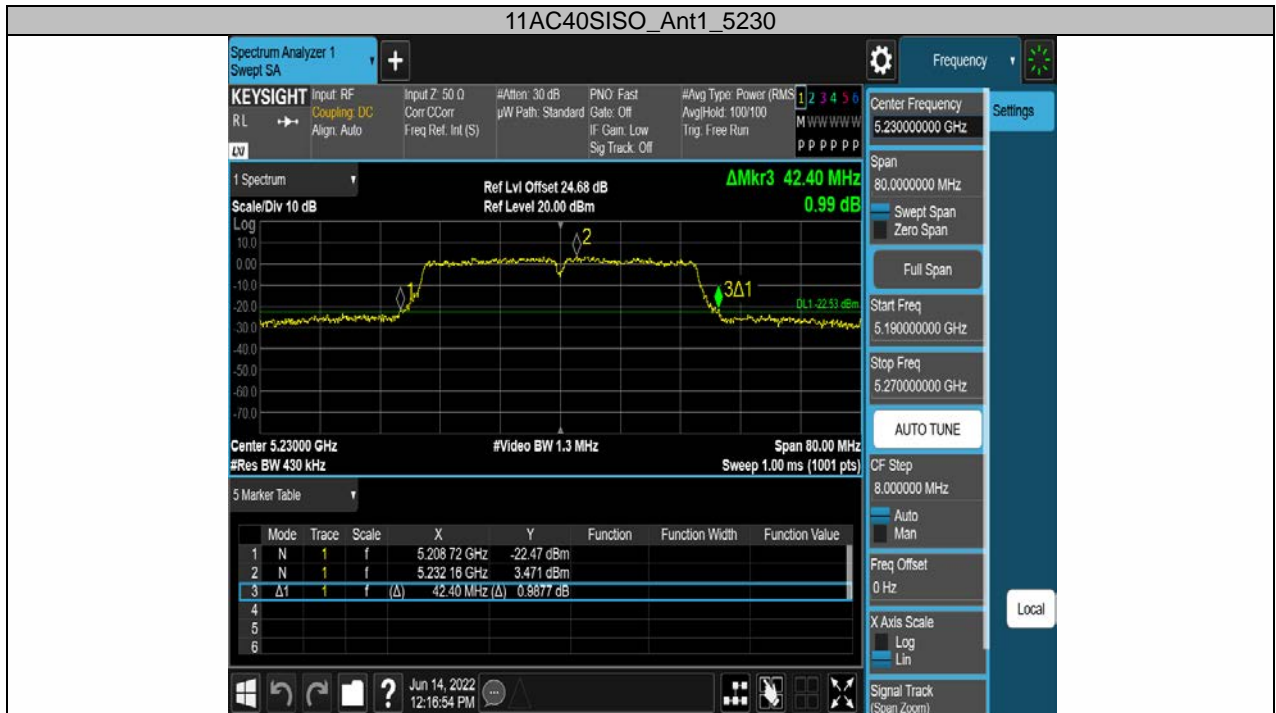

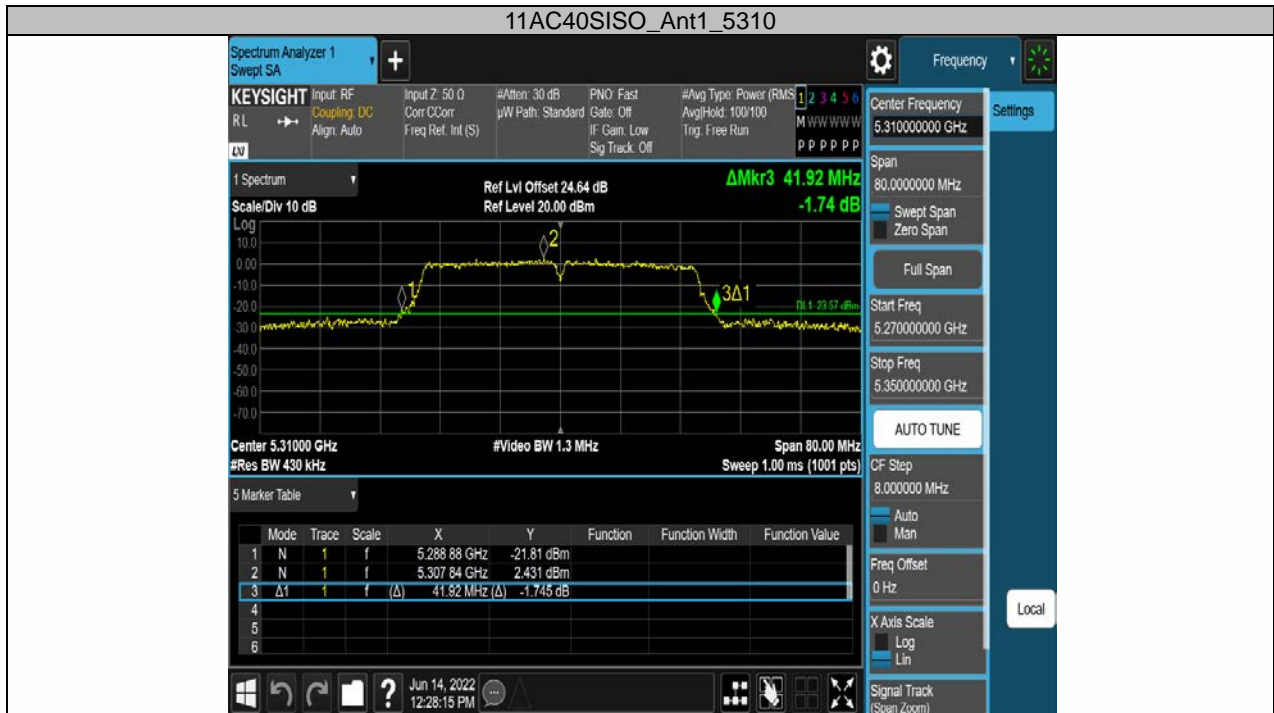



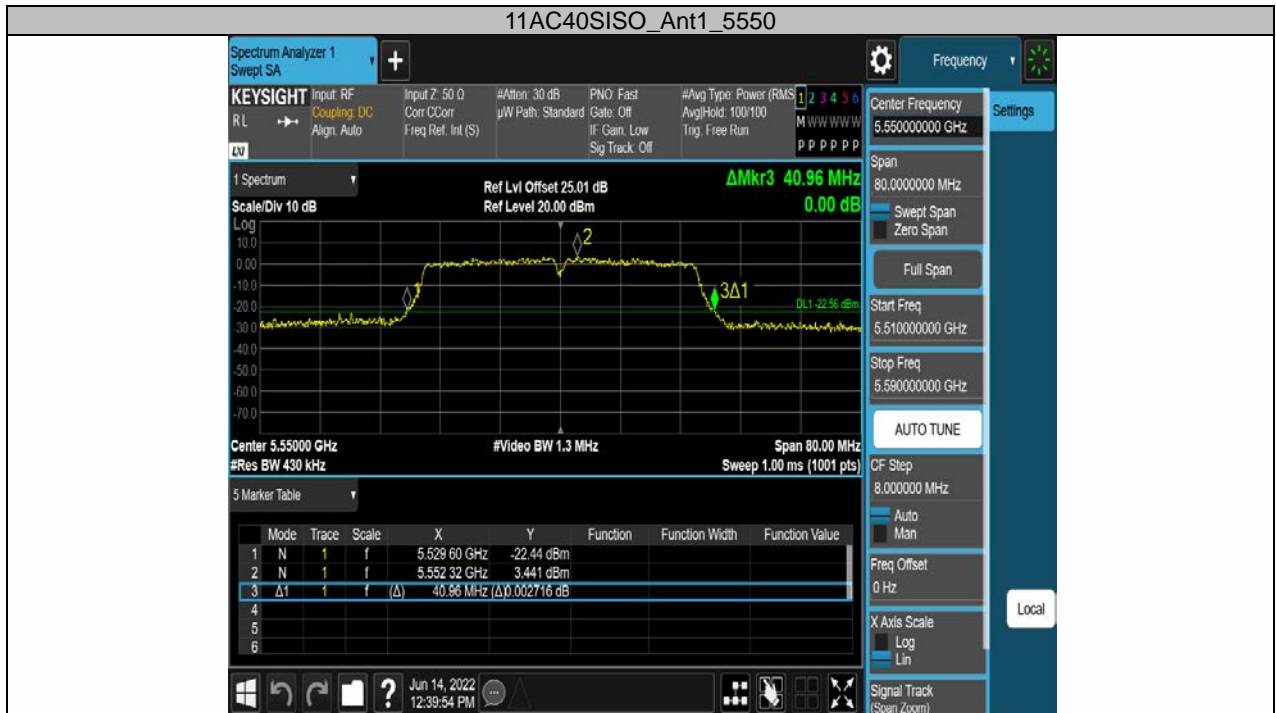

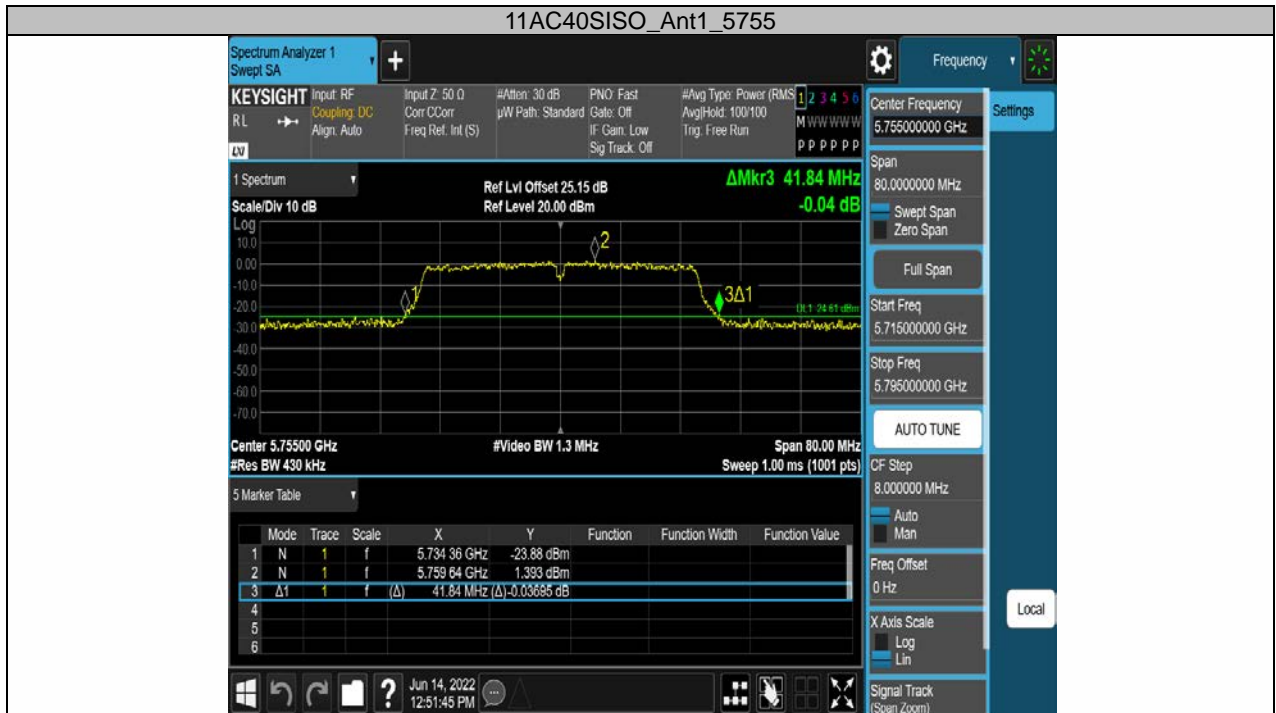

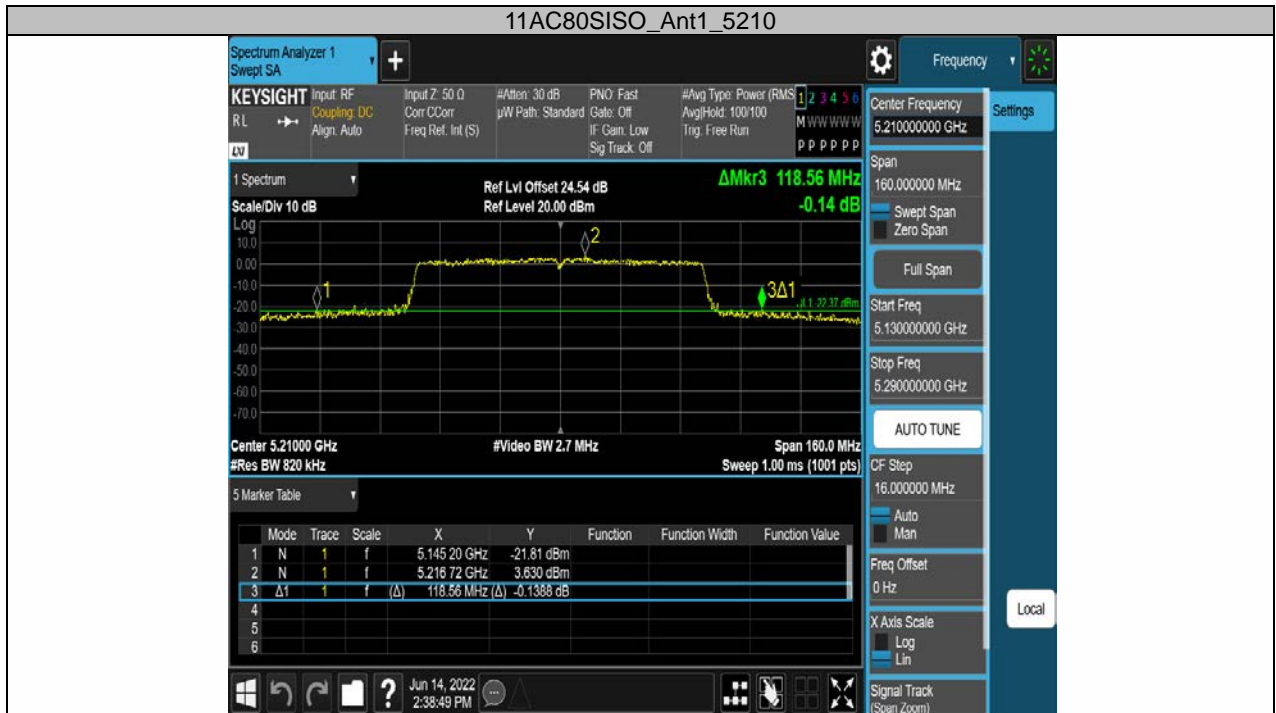

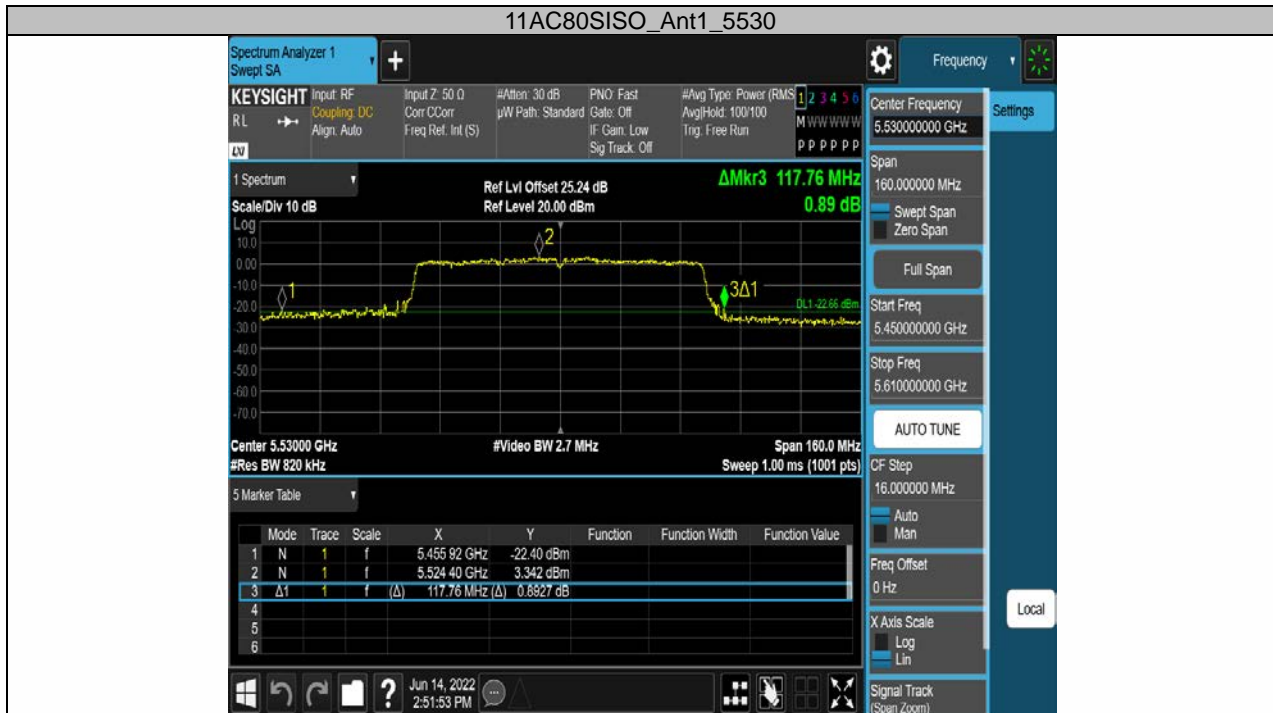

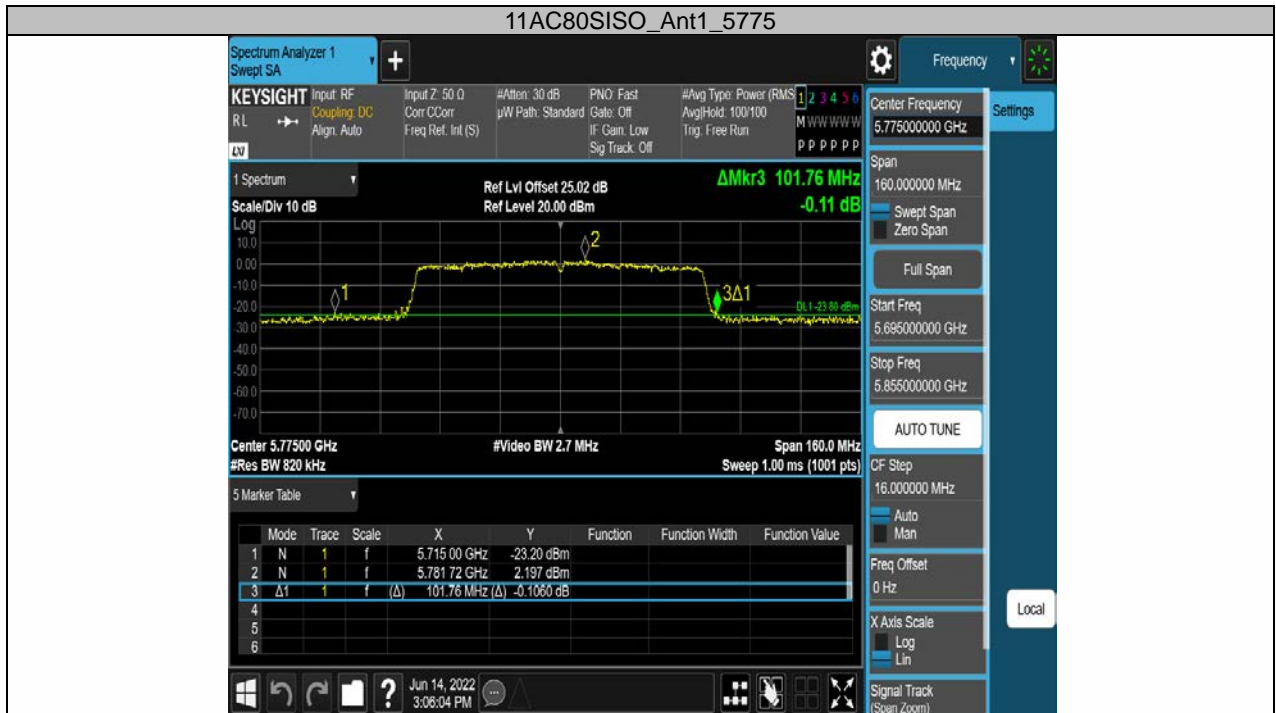

TestMode	Antenna	Frequency[MHz]	OCB [MHz]	FL[MHz]	FH[MHz]	Limit[MHz]	Verdict
11A	Ant1	5180	17.005	5171.451	5188.456	---	---
		5220	17.011	5211.491	5228.502	---	---
		5240	16.910	5231.541	5248.451	---	---
		5260	16.938	5251.508	5268.446	---	---
		5300	16.891	5291.534	5308.425	---	---
		5320	16.941	5311.481	5328.422	---	---
		5500	16.916	5491.505	5508.421	---	---
		5580	16.887	5571.479	5588.366	---	---
		5700	16.907	5691.594	5708.501	---	---
		5745	16.945	5736.512	5753.457	---	---
		5785	16.891	5776.504	5793.395	---	---
		5825	16.875	5816.537	5833.412	---	---
11N20SISO	Ant1	5180	18.322	5170.812	5189.134	---	---
		5220	18.159	5210.896	5229.055	---	---
		5240	18.152	5230.897	5249.049	---	---
		5260	18.119	5250.935	5269.054	---	---
		5300	18.102	5290.917	5309.019	---	---
		5320	18.064	5310.894	5328.958	---	---
		5500	18.108	5490.908	5509.016	---	---
		5580	18.070	5570.921	5588.991	---	---
		5700	18.171	5690.963	5709.134	---	---
		5745	18.084	5735.959	5754.043	---	---
		5785	18.103	5775.857	5793.960	---	---
		5825	18.046	5815.941	5833.987	---	---
11N40SISO	Ant1	5190	36.651	5171.647	5208.298	---	---
		5230	36.509	5211.746	5248.255	---	---
		5270	36.459	5251.722	5288.181	---	---
		5310	36.468	5291.675	5328.143	---	---
		5510	36.483	5491.761	5528.244	---	---
		5550	36.416	5531.752	5568.168	---	---
		5670	36.529	5651.725	5688.254	---	---
		5755	36.542	5736.747	5773.289	---	---
		5795	36.492	5776.690	5813.182	---	---
11AC20SISO	Ant1	5180	18.215	5170.890	5189.105	---	---
		5220	18.129	5210.911	5229.040	---	---
		5240	18.093	5230.935	5249.028	---	---
		5260	18.136	5250.911	5269.047	---	---
		5300	18.109	5290.879	5308.988	---	---
		5320	18.100	5310.902	5329.002	---	---
		5500	18.052	5490.921	5508.973	---	---
		5580	18.063	5570.899	5588.962	---	---
		5700	18.113	5690.953	5709.066	---	---
		5745	18.014	5735.987	5754.001	---	---

		5785	18.069	5775.939	5794.008	---	---
		5825	18.078	5815.934	5834.012	---	---
11AC40SISO	Ant1	5190	36.487	5171.698	5208.185	---	---
		5230	36.424	5211.796	5248.220	---	---
		5270	36.477	5251.706	5288.183	---	---
		5310	36.434	5291.724	5328.158	---	---
		5510	36.375	5491.794	5528.169	---	---
		5550	36.447	5531.743	5568.190	---	---
		5670	36.565	5651.694	5688.259	---	---
		5755	36.390	5736.795	5773.185	---	---
		5795	36.503	5776.686	5813.189	---	---
11AC80SISO	Ant1	5210	76.456	5171.678	5248.134	---	---
		5290	76.159	5251.710	5327.869	---	---
		5530	76.248	5491.743	5567.991	---	---
		5610	76.193	5571.493	5647.686	---	---
		5775	76.186	5736.774	5812.960	---	---









