

FCC TEST REPORT
for
iTon Technology Corp.

BW2570-PCIE
Model No.: BW2570-PCIE

Prepared for : iTon Technology Corp.
Address : 7 Floor East, Building C, No. 1006 Shennan Road, Shenzhen
International Innovation Center (Futian Technology Square),
Futian District, Shenzhen, China

Prepared By : Shenzhen Anbotek Compliance Laboratory Limited
Address : 1/F., Building 1, SEC Industrial Park, No.0409 Qianhai Road,
Nanshan District, Shenzhen, Guangdong, China
Tel: (86) 755-26066544
Fax: (86) 755-26014772

Report Number : R011609746W
Date of Test : Oct. 08~ 17, 2016
Date of Report : Oct. 17, 2016

TABLE OF CONTENTS

Description

Page

Test Report

1. GENERAL INFORMATION.....	5
1.1 Description of Device (EUT).....	5
1.2 Auxiliary Equipment Used during Test.....	6
1.3 Description of Test Facility.....	7
1.4 Measurement Uncertainty.....	7
2. TEST PROCEDURE.....	8
3. CONDUCTED EMISSION.....	9
3.1 Block Diagram of Test Setup.....	9
3.2 Power Line Conducted Emission Measurement Limits (15.207).....	9
3.3 Configuration of EUT on Measurement.....	9
3.4 Operating Condition of EUT.....	9
3.5 Test Procedure.....	10
3.6 Power Line Conducted Emission Measurement Results.....	10
4. RADIATION INTERFERENCE.....	15
4.1 Requirements (15.247, 15.209):.....	15
4.2 Test Procedure.....	15
4.3 Test Configuration.....	17
4.4 Test Results.....	18
5. CHANNEL SEPARATION TEST.....	27
5.1 Measurement Procedure.....	27
5.2 Test SET-UP.....	27
5.3 Test Equipment.....	27
5.4 Test Results.....	28
6. 20DB BANDWIDTH TEST.....	30
6.1 Measurement Procedure.....	30
6.2 Test SET-UP.....	30
6.3 Test Equipment.....	30
6.4 Test Results.....	30
7. QUANTITY OF HOPPING CHANNEL TEST.....	32
7.1 Measurement Procedure.....	32
7.2 Test SET-UP.....	32
7.3 Test Equipment.....	32
7.4 Test Results.....	32
8. DWELL TIME TEST.....	34

8.1 Measurement Procedure.....	34
8.2 Test SET-UP.....	34
8.3 Test Equipment.....	34
8.4 Test Results.....	34
9. MAXIMUM PEAK OUTPUT POWER TEST.....	36
9.1 Measurement Procedure.....	36
9.2 Test SET-UP.....	36
9.3 Test Equipment.....	36
9.4 Test Results.....	37
10. BAND EDGE TEST.....	39
10.1 Measurement Procedure.....	39
10.2 Test SET-UP.....	39
10.3 Test Equipment.....	40
10.4 Test Results.....	40
11. ANTENNA APPLICATION.....	44
11.1 Antenna requirement.....	44
11.2 Result.....	44
12. PHOTOGRAPH.....	45
12.1 Photo of Power Line Conducted Emission Measurement.....	45
12.2 Photo of Radiation Emission Test.....	45
12.3. Photo of EUT in the PC.....	46
APPENDIX I (EXTERNAL PHOTOS).....	48
APPENDIX II (INTERNAL PHOTOS).....	50

TEST REPORT

Applicant : iTon Technology Corp.
Manufacturer : iTon Technology Corp.
EUT : BW2570-PCIE
Model No. : BW2570-PCIE
Serial No. : N.A.
Trade Mark : N.A.
Rating : DC 3.3V, 680mA

Measurement Procedure Used:

FCC Part15 Subpart C 2016, Paragraph 15.207, 15.247 & 15.209

The device described above is tested by Shenzhen Anbotek Compliance Laboratory Limited to determine the maximum emission levels emanating from the device and the severe levels of the device can endure and its performance criterion. The measurement results are contained in this test report and Shenzhen Anbotek Compliance Laboratory Limited is assumed full of responsibility for the accuracy and completeness of these measurements. Also, this report shows that the EUT (Equipment Under Test) is technically compliant with the FCC Part 15 Subpart C requirements.

This report applies to above tested sample only and shall not be reproduced in part without written approval of Shenzhen Anbotek Compliance Laboratory Limited.

Date of Test : Oct. 08~ 17, 2016

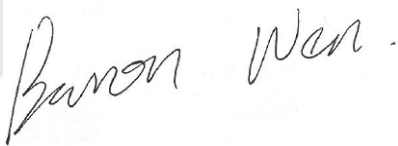
Prepared by : 
(Tested Engineer / Baron Wen)

Reviewer : 
(Project Manager / Amy Ding)

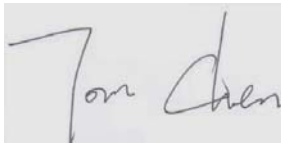
Approved & Authorized Signer : 
(Manager / Tom Chen)

1. GENERAL INFORMATION

1.1 Description of Device (EUT)

EUT : BW2570-PCIE

Model Number : BW2570-PCIE
(Note: During the test, the EUT is inserted into the PC)

Test Power Supply : DC 3.3V from the PC (AC 120V/60Hz for PC)

Frequency :

Types of module	Operating Frequency
BT 4.1+EDR	2402-2480MHz
WiFi 2.4G (802.11b/ g/ n(HT20))	2412-2462MHz
WiFi 2.4G (802.11n(HT40))	2422-2452MHz
WiFi 5G (802.11a/ n(HT20)/ ac(HT20))	5180-5240MHz & 5745-5825MHz
WiFi 5G (802.11n(HT40)/ ac(HT40))	5190MHz-MHz & 5755-5795MHz
WiFi 5G (802.11ac(HT80))	5210MHz & 5775MHz

Antenna Spec. : 5 dBi

Modulation : BT EDR: GFSK, $\pi/4$ DQPSK, 8DPSK
BT 4.1: GFSK
WiFi:
802.11a OFDM, 802.11b CCK; 802.11g OFDM, 802.11n MCS;
802.11ac MCS

Applicant : iTon Technology Corp.
Address : 7 Floor East, Building C, No. 1006 Shennan Road, Shenzhen
International Innovation Center (Futian Technology Square), Futian
District, Shenzhen, China

Manufacturer/ Factory : iTon Technology Corp.
Address : Room A1302, Building 4, Tianan Cyber Park, Huangge Rd.,
Longgang, Shenzhen, China

Date of receipt : Sept. 23, 2016

Date of Test : Oct. 08~ 17, 2016

Remark : This report is for BT EDR.

1.2 Auxiliary Equipment Used during Test

PC	: Manufacturer: DELL M/N: Optiplex 3020 MT S/N: CN-079V51-70163-4AD-089K-A00 Input Rating: AC 100-240V, 50-60Hz 5.4A CE , FCC DOC, CCC
MONITOR	: Manufacturer: DELL M/N: UZ2215Hf S/N: CN-035VN6-72872-45A-A3AB Input Rating: AC 100-240V, 50-60Hz, 1.5A Output Rating: DC 19.5V, 4.62A TUV-GS FCC CE KCC VCCI
KEYBOARD	: Manufacturer: DELL M/N: SK-8120 S/N: CN-0DJ365-71616-49J-0MVR-A00 Input Rating: DC 5V,0.05A CE FCC VCCI KCC TUV-GS Cable: 1.8m, unshielded
MOUSE	: Manufacturer: DELL M/N: MS111-T S/N: CN-0KW2YH-71616-488-1CBJ Input Rating: DC 5V,0.1A Cable: 1.8m, unshielded CE FCC VCCI KCC TUV-GS
Printer	: Manufacturer:Brother M/N: MFC-3360C S/N: N/A CE, FCC:DOC
Power Line	: Non-Shielded, 1.5m
VGA Cable	: Non-Shielded, 1.5m

1.3 Description of Test Facility

The test facility is recognized, certified, or accredited by the following organizations:

FCC-Registration No.: 752021

Shenzhen Anbotek Compliance Laboratory Limited, EMC Laboratory has been registered and fully described in a report filed with the (FCC) Federal Communications Commission. The acceptance letter from the FCC is maintained in our files. Registration 752021, July 06, 2016.

IC-Registration No.: 8058A-1

Shenzhen Anbotek Compliance Laboratory Limited., EMC Laboratory has been registered and fully described in a report filed with the (IC) Industry Canada. The acceptance letter from the IC is maintained in our files. Registration 8058A, June 13, 2016.

Test Location

All Emissions tests were performed at
Shenzhen Anbotek Compliance Laboratory Limited. at 1/F., Building 1, SEC Industrial Park, No.0409 Qianhai Road, Nanshan District, Shenzhen, Guangdong, China

1.4 Measurement Uncertainty

Radiation Uncertainty : Ur = 4.1 dB (Horizontal)
Ur = 4.3 dB (Vertical)

Conduction Uncertainty : Uc = 3.4dB

2. Test Procedure

GENERAL: This report shall NOT be reproduced except in full without the written approval of Shenzhen Anbotek Compliance Laboratory Limited. The EUT was transmitting a test signal during the testing.

RADIATION INTERFERENCE: The test procedure used was ANSI STANDARD C63.10-2013 using a spectrum analyzer with a pre-selector. The analyzer was calibrated in dB above a microvolt at the output of the antenna. The resolution bandwidth was 100KHz and the video bandwidth was 300KHz up to 1.0GHz and 1.0MHz with a video BW of 3.0MHz above 1.0GHz. The ambient temperature of the EUT was 74.3oF with a humidity of 69%.

FORMULA OF CONVERSION FACTORS: The Field Strength at 3m was established by adding the meter reading of the spectrum analyzer (which is set to read in units of dBuV) to the antenna correction factor supplied by the antenna manufacturer. The antenna correction factors are stated in terms of dB. The gain of the Preselector was accounted for in the Spectrum Analyzer Meter Reading.

Example:

Freq (MHz) METER READING + ACF = FS
20 dBuV + 10.36 dB = 30.36 dBuV/m @ 3m

ANSI STANDARD C63.10-2013 10.1.7 MEASUREMENT PROCEDURES: The EUT was placed on a table 80 cm high and with dimensions of 1m by 1.5m. The EUT was placed in the center of the table (1.5m side). The table used for radiated measurements is capable of continuous rotation.

When an emission was found, the table was rotated to produce the maximum signal strength. At this point, the antenna was raised and lowered from 1m to 4m. The antenna was placed in both the horizontal and vertical planes.

3. Conducted Emission

3.1 Block Diagram of Test Setup

3.1.1. Block diagram of connection between the EUT and simulators

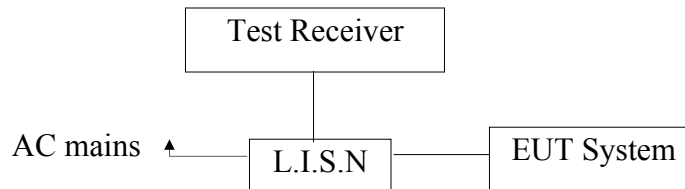

3.2 Power Line Conducted Emission Measurement Limits (15.207)

Frequency MHz	Limits dB(μ V)	
	Quasi-peak Level	Average Level
0.15 ~ 0.50	66 ~ 56*	56 ~ 46*
0.50 ~ 5.00	56	46
5.00 ~ 30.00	60	50

- Notes: 1. *Decreasing linearly with logarithm of frequency.
2. The lower limit shall apply at the transition frequencies.

3.3 Configuration of EUT on Measurement

The following equipments are installed on Power Line Conducted Emission Measurement to meet the commission requirement and operating regulations in a manner which tends to maximize its emission characteristics in a normal application.

3.4 Operating Condition of EUT

- 3.4.1. Setup the EUT and simulator as shown as Section 3.1.
- 3.4.2. Turn on the power of all equipment.
- 3.4.3. Let the EUT work in test mode (ON) and measure it.

3.5 Test Procedure

The EUT system is connected to the power mains through a line impedance stabilization network (L.I.S.N.). This provides a 50ohm coupling impedance for the EUT system. Please refer the block diagram of the test setup and photographs. Both sides of AC line are checked to find out the maximum conducted emission. In order to find the maximum emission levels, the relative positions of equipment and all of the interface cables shall be changed according to FCC ANSI C63.10-2013 on Conducted Emission Measurement.

The bandwidth of test receiver (ESCI) set at 9KHz.

The frequency range from 150KHz to 30MHz is checked.

The test results are reported on Section 3.6.

Test Equipment

Item	Equipment	Manufacturer	Model No.	Serial No.	Last Cal.	Cal. Interval
1.	Two-Line V-network	Rohde & Schwarz	ENV216	100055	Apr. 16, 2016	1 Year
2.	EMI Test Receiver	Rohde & Schwarz	ESCI	100627	Apr. 16, 2016	1 Year
3.	RF Switching Unit	Compliance Direction	RSU-M2	38303	Apr. 16, 2016	1 Year

3.6 Power Line Conducted Emission Measurement Results

PASS.

The frequency range from 150KHz to 30 MHz is investigated.

Please refer the following pages.

CONDUCTED EMISSION TEST DATA

Test Site: 1# Shielded Room
 Operating Condition: ON
 Test Specification: AC 120V, 60Hz for PC
 Comment: Live Line
 Tem.:25°C Hum.:50%

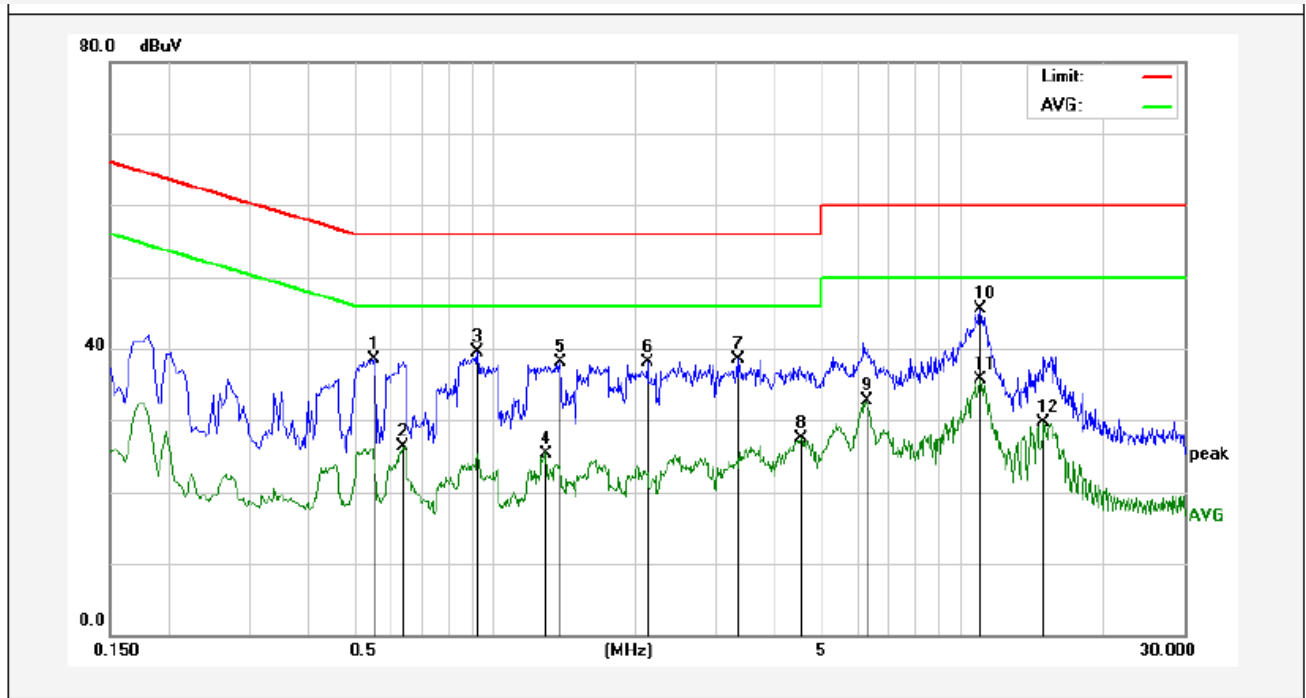

No.	Freq. (MHz)	Reading (dBuV)	Factor (dB)	Result (dBuV)	Limit (dBuV)	Over Limit (dB)	Detector	Remark
1	0.5540	18.60	19.98	38.58	56.00	-17.42	QP	
2	0.6380	6.40	20.01	26.41	46.00	-19.59	AVG	
3	0.9220	19.59	20.10	39.69	56.00	-16.31	QP	
4	1.2900	5.40	20.13	25.53	46.00	-20.47	AVG	
5	1.3820	18.13	20.13	38.26	56.00	-17.74	QP	
6	2.1220	18.04	20.15	38.19	56.00	-17.81	QP	
7	3.3220	18.55	20.16	38.71	56.00	-17.29	QP	
8	4.5380	7.54	20.18	27.72	46.00	-18.28	AVG	
9	6.2460	12.65	20.19	32.84	50.00	-17.16	AVG	
10	10.9819	25.48	20.34	45.82	60.00	-14.18	QP	
11	10.9819	15.73	20.34	36.07	50.00	-13.93	AVG	
12	15.0420	9.70	20.26	29.96	50.00	-20.04	AVG	

CONDUCTED EMISSION TEST DATA

Test Site: 1# Shielded Room
 Operating Condition: ON
 Test Specification: AC 120V, 60Hz for PC
 Comment: Neutral Line
 Tem.:25°C Hum.:50%

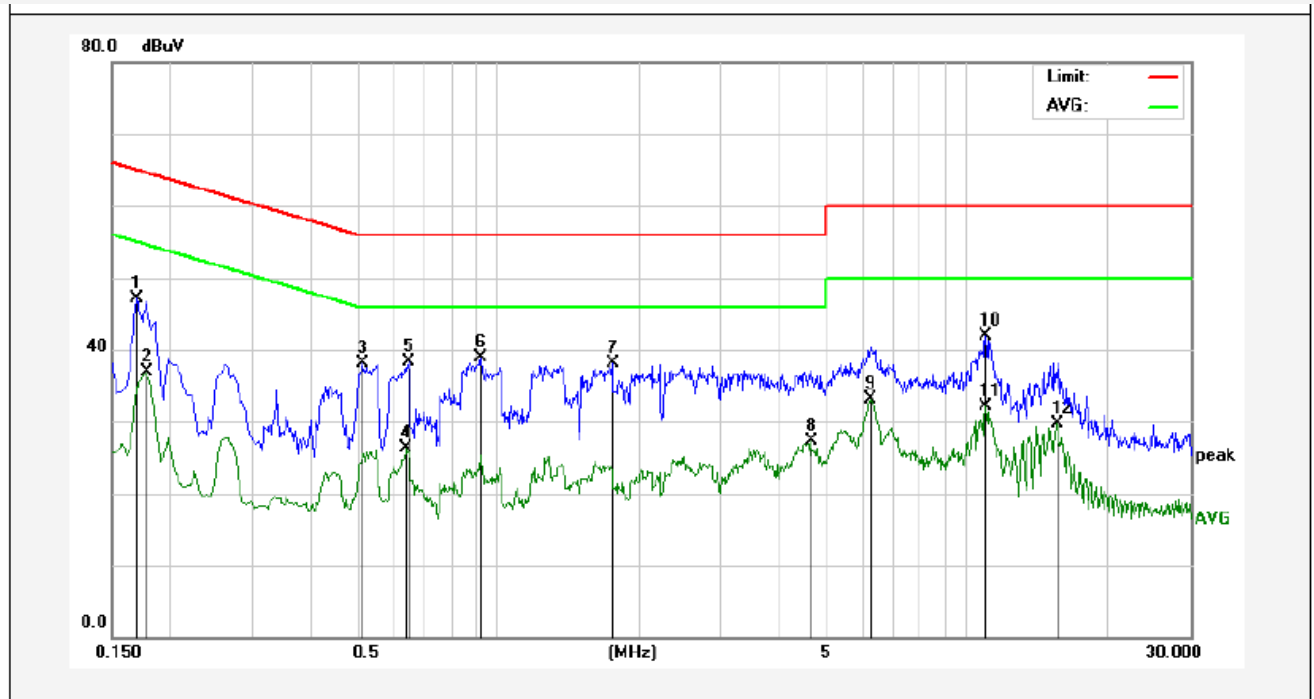

No.	Freq. (MHz)	Reading (dBuV)	Factor (dB)	Result (dBuV)	Limit (dBuV)	Over Limit (dB)	Detector	Remark
1	0.1700	27.11	19.90	47.01	64.96	-17.95	QP	
2	0.1780	16.92	19.90	36.82	54.57	-17.75	AVG	
3	0.5140	18.02	19.98	38.00	56.00	-18.00	QP	
4	0.6380	6.29	19.98	26.27	46.00	-19.73	AVG	
5	0.6460	18.31	19.99	38.30	56.00	-17.70	QP	
6	0.9220	18.81	20.10	38.91	56.00	-17.09	QP	
7	1.7450	18.08	20.13	38.21	56.00	-17.79	QP	
8	4.6500	7.27	20.18	27.45	46.00	-18.55	AVG	
9	6.2340	13.09	20.23	33.32	50.00	-16.68	AVG	
10	10.9740	21.94	20.34	42.28	60.00	-17.72	QP	
11	10.9740	12.19	20.34	32.53	50.00	-17.47	AVG	
12	15.5260	9.79	20.26	30.05	50.00	-19.95	AVG	

CONDUCTED EMISSION TEST DATA

Test Site: 1# Shielded Room
 Operating Condition: ON
 Test Specification: AC 240V, 60Hz for PC
 Comment: Live Line
 Tem.:25°C Hum.:50%

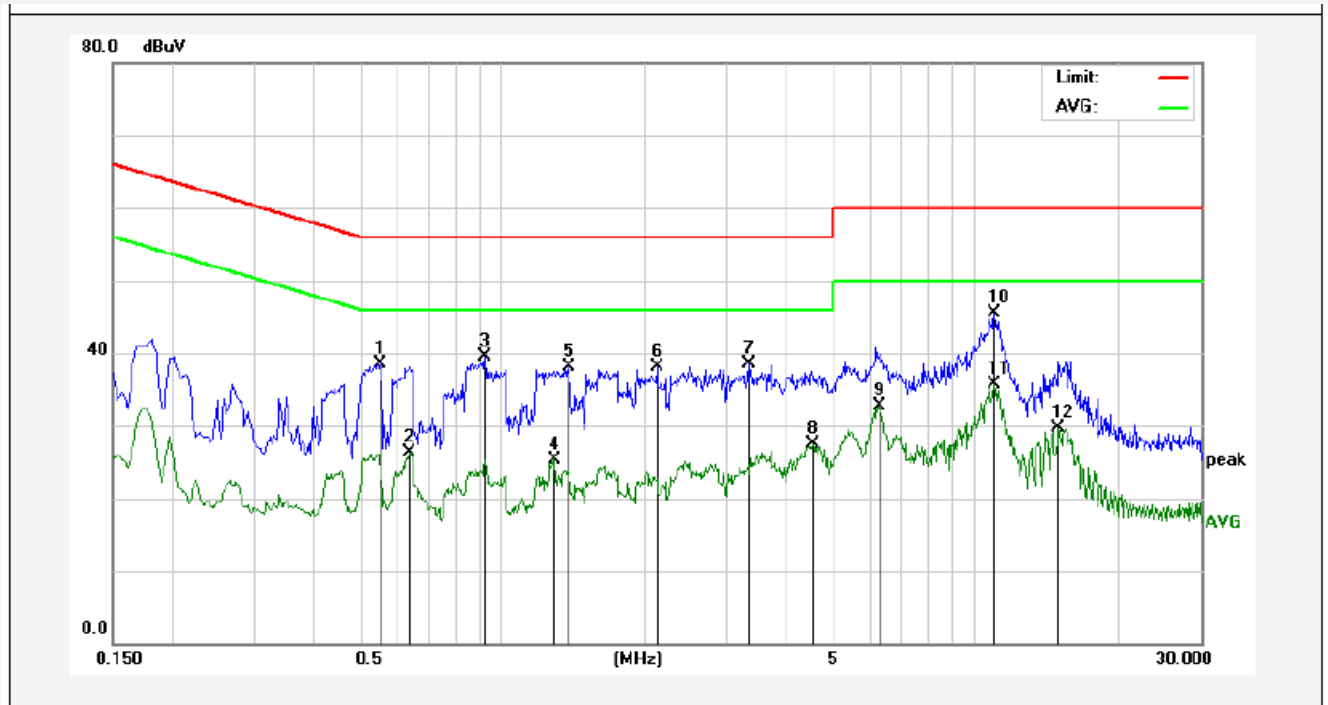

No.	Freq. (MHz)	Reading (dBuV)	Factor (dB)	Result (dBuV)	Limit (dBuV)	Over Limit (dB)	Detector	Remark
1	0.5540	18.60	19.90	38.50	56.00	-17.50	QP	
2	0.6380	6.40	20.00	26.40	46.00	-19.60	AVG	
3	0.9220	19.59	19.89	39.48	56.00	-16.52	QP	
4	1.2900	5.40	20.12	25.52	46.00	-20.48	AVG	
5	1.3820	18.13	20.12	38.25	56.00	-17.75	QP	
6	2.1220	18.04	20.13	38.17	56.00	-17.83	QP	
7	3.3220	18.55	20.15	38.70	56.00	-17.30	QP	
8	4.5380	7.54	20.18	27.72	46.00	-18.28	AVG	
9	6.2460	12.65	20.20	32.85	50.00	-17.15	AVG	
10	10.9819	25.48	20.34	45.82	60.00	-14.18	QP	
11	10.9819	15.73	20.34	36.07	50.00	-13.93	AVG	
12	15.0420	9.70	20.26	29.96	50.00	-20.04	AVG	

CONDUCTED EMISSION TEST DATA

Test Site: 1# Shielded Room
 Operating Condition: ON
 Test Specification: AC 240V, 60Hz for PC
 Comment: Neutral Line
 Tem.:25°C Hum.:50%

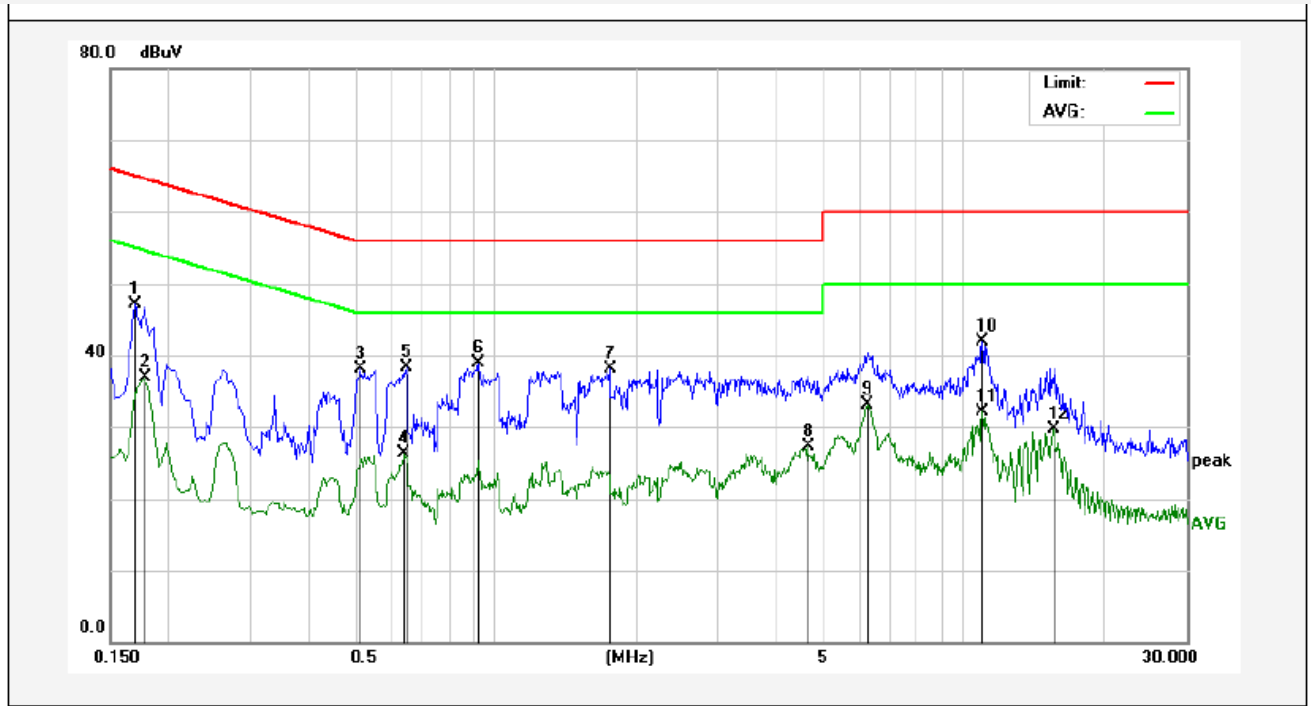

No.	Freq. (MHz)	Reading (dBuV)	Factor (dB)	Result (dBuV)	Limit (dBuV)	Over Limit (dB)	Detector	Remark
1	0.1700	27.11	19.90	47.01	47.11	-0.10	QP	
2	0.1780	16.92	19.90	36.82	36.92	-0.10	AVG	
3	0.5140	18.02	19.98	38.00	38.02	-0.02	QP	
4	0.6380	6.29	19.98	26.27	26.29	-0.02	AVG	
5	0.6460	18.31	20.00	38.31	38.31	0.00	QP	
6	0.9220	18.31	20.10	38.41	38.31	0.10	QP	
7	1.7540	18.08	20.14	38.22	38.08	0.14	QP	
8	4.6500	7.27	20.18	27.45	27.27	0.18	AVG	
9	6.2340	13.09	20.20	33.29	33.09	0.20	AVG	
10	10.9740	21.94	20.34	42.28	41.94	0.34	QP	
11	10.9740	12.19	20.34	32.53	32.19	0.34	AVG	
12	15.5260	9.79	20.26	30.05	29.79	0.26	AVG	

4. Radiation Interference

4.1 Requirements (15.247, 15.209):

4.1.1. Test Limits (< 30 MHz)

Frequency (MHz)	Field Strength (microvolts/meter)	Measurement Distance (meter)
0.009-0.490	2400/F(kHz)	300
0.490-1.705	24000/F(kHz)	30
1.705-30.0	30	30

4.1.2. Test Limits (≥ 30 MHz)

FIELD STRENGTH of Fundamental: @3M	FIELD STRENGTH of Harmonics	S15.209	
902-928 MHz		30 - 88 MHz	40 dBuV/m
2.4-2.4835 GHz		88 - 216 MHz	43.5
94 dBμV/m @3m	54 dBμV/m @3m	216 - 960 MHz	46
		ABOVE 960 MHz	54dBuV/m

For range 9KHz~30MHz, The measured value is really too low to be recorded.

Emissions radiated outside of the specified frequency bands, except for harmonics, shall be attenuated by at least 50 dB below the level of the fundamental or to the general radiated emission limits in 15.209, whichever is the lesser attenuation.

4.2 Test Procedure

For below 1GHz: The EUT is placed on a turntable, which is 0.8m above the ground plane.
 For above 1GHz: The EUT is placed on a turntable, which is 1.5m above the ground plane.
 The turn table can rotate 360 degrees to determine the position of the maximum emission level.
 The EUT is set 3 meters away from the receiving antenna which is mounted on a antenna tower.
 The antenna can be moved up and down from 1 to 4 meters to find out the maximum emission level. Rotated the EUT through three orthogonal axes to determine the maximum emissions, both horizontal and vertical polarization of the antenna are set on test. The EUT is tested in 9*6*6 Chamber. The device is evaluated in xyz orientation.

For 30MHz to 1000MHz:

Set the spectrum analyzer as:
 RBW = 100kHz, VBW =300kHz,
 Detector= Quasi-Peak
 Trace mode= Max hold.
 Sweep- auto couple.

For Above 1GHz:

Set the spectrum analyzer as:
 RBW = 1MHz, VBW =3MHz,
 Detector= Peak
 Trace mode= Max hold.
 Sweep- auto couple.

Set the spectrum analyzer as:
 RBW =1MHz, VBW =10Hz
 Detector= Average
 Trace mode= Max hold.
 Sweep- auto couple.

Test Equipment

Item	Equipment	Manufacturer	Model No.	Serial No.	Last Cal.	Cal. Interval
1.	Spectrum Analysis	Agilent	E4407B	US39390582	Apr. 16, 2016	1 Year
2.	Preamplifier	Instruments corporation	EMC011830	980100	Apr. 16, 2016	1 Year
3.	EMI Test Receiver	Rohde & Schwarz	ESPI	101604	Apr. 16, 2016	1 Year
4.	Double Ridged Horn Antenna	Instruments corporation	GTH-0118	351600	Apr. 19, 2016	1 Year
5.	Bilog Broadband Antenna	Schwarzbeck	VULB9163	VULB 9163-289	Apr. 19, 2016	1 Year
6.	Pre-amplifier	SONOMA	310N	186860	Apr. 16, 2016	1 Year
7.	EMI Test Software EZ-EMC	SHURPLE	N/A	N/A	N/A	N/A
8	Power Sensor	DAER	RPR3006W	15I00041SN046	Jun 30, 2016	1 Year
9	MXA Spectrum Analysis	Agilent	N9020A	MY51170037	Jun 30, 2016	1 Year
10	MXG RF Vector Signal Generator	Agilent	N5182A	MY48180656	Jun 30, 2016	1 Year
11	Signal Generator	Agilent	E4421B	MY41000743	Jun 30, 2016	1 Year
12	DC Power supply	IV	IV-8080	YQSB0096	Jun 30, 2016	1 Year
13	TEMP&HUMI PROGRAMMABLE CHAMBER	Bell Group	BE-THK-150M8	SE-0137	Mar 16, 2016	1 Year
14	Spectrum Analysis	Rohde & Schwarz	FSV40	132.1.3008K39-100965	Mar 17, 2016	1 Year
15	Pre-amplifier	Agilent	8449B	3008A00252	Mar 17, 2016	1 Year
16	Horn Antenna	SCHWARZBECK	BBHA9170	9170-068	Mar 17, 2016	1 Year

4.3 Test Configuration

4.3.1. 9k to 30MHz emissions:

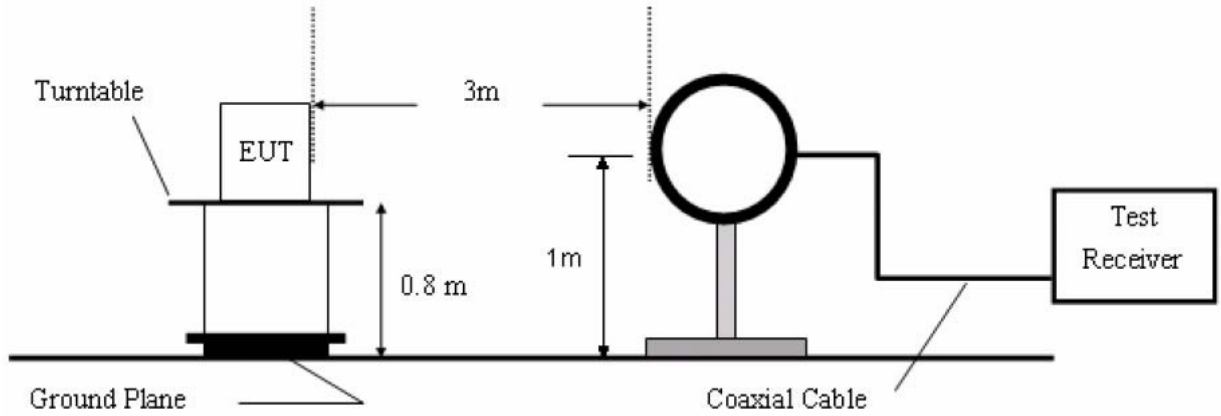

4.3.2. 30M to 1G emissions:

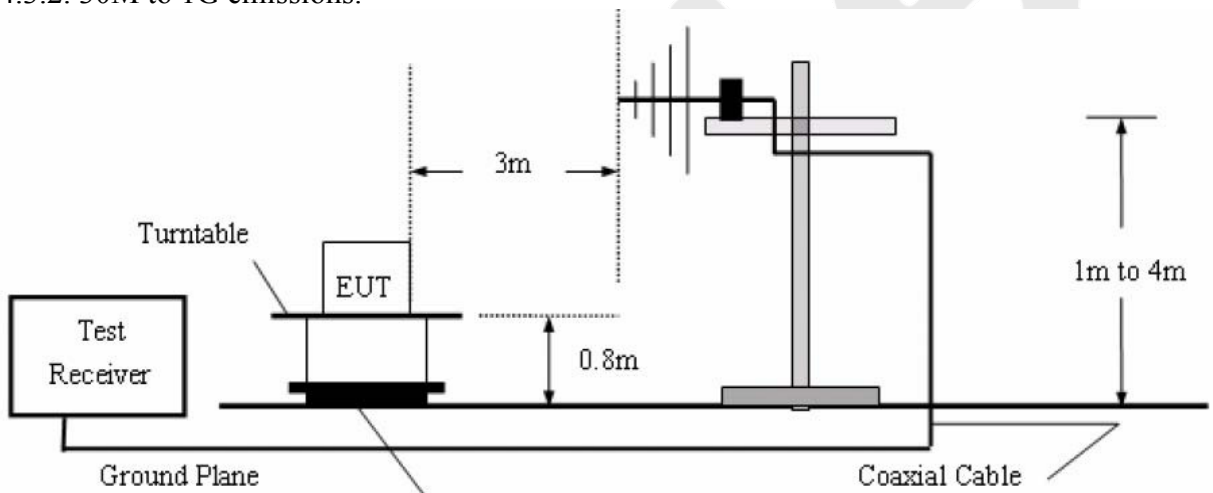

4.3.3. 1G to 40G emissions:

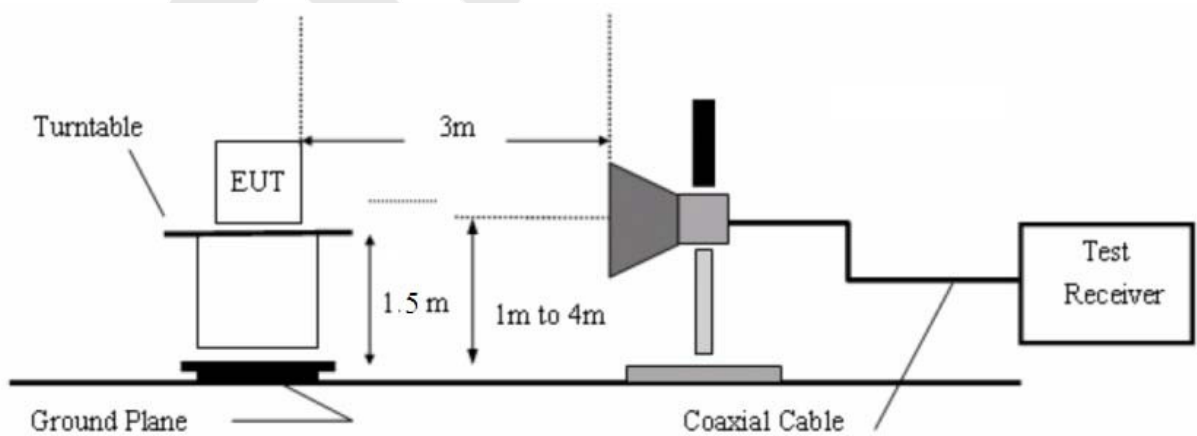

4.4 Test Results

PASS.

The EUT was tested on (BT Mode) modes, the data is attached in the following pages.
Only the worst case (x orientation).

The test results of above 18000MHz are attenuated more than 20dB below the permissible limits, so the results don't record in the report.

Anbotek

Job No.:	011609746I	Polarization:	Horizontal
Standard:	(RE)FCC PART 15C _3m	Power Source:	AC 120V, 60Hz for PC
Test item:	Radiation Test (30~1000MHz)	Temp.(C)/Hum.(%RH):	24.3(C)/55%RH
Test Mode:	BT Mode	Distance:	3m

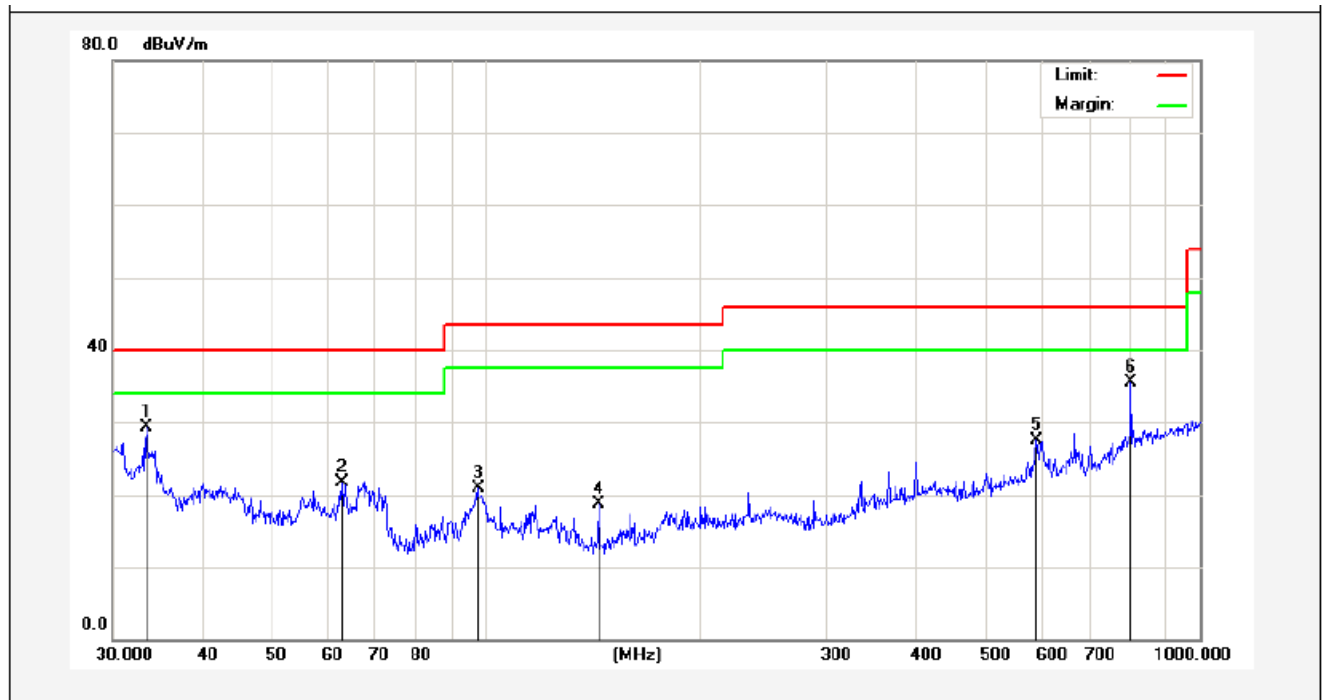

No.	Freq. (MHz)	Reading (dBuV/m)	Factor (dB/m)	Result (dBuV/m)	Limit (dBuV/)	Over Limit (dB)	Detector	Height (cm)	degree (deg)	Remark
1	33.4448	44.41	-15.12	29.29	40.00	-10.71	peak			
2	62.8708	38.23	-16.59	21.64	40.00	-18.36	peak			
3	97.4560	41.81	-20.89	20.92	43.50	-22.58	peak			
4	143.8294	42.20	-23.43	18.77	43.50	-24.73	peak			
5	590.9737	38.71	-11.21	27.50	46.00	-18.50	peak			
6	801.7862	42.12	-6.54	35.58	46.00	-10.42	peak			

Job No.:	011609746I	Polarization:	Vertical
Standard:	(RE)FCC PART 15C _3m	Power Source:	AC 120V, 60Hz for PC
Test item:	Radiation Test (30~1000MHz)	Temp.(C)/Hum.(%RH):	24.3(C)/55%RH
Test Mode:	BT Mode	Distance:	3m

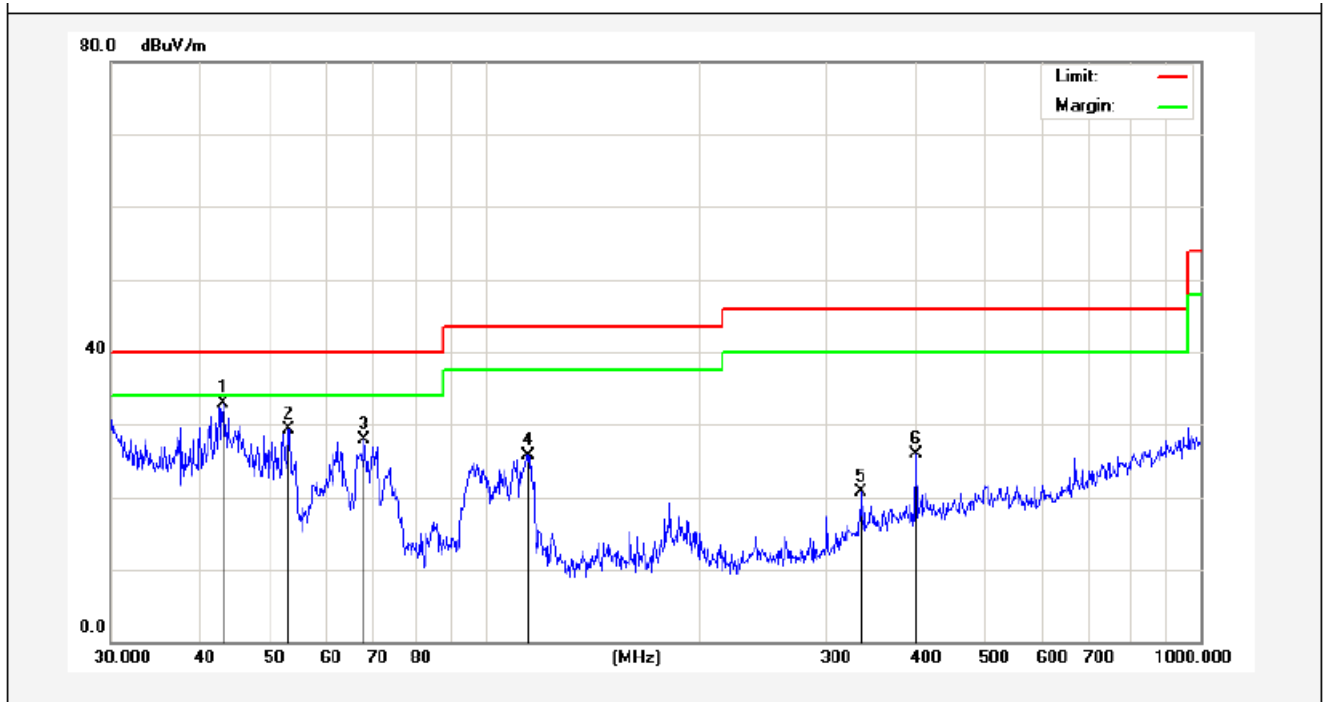

No.	Freq. (MHz)	Reading (dBuV/m)	Factor (dB/m)	Result (dBuV/m)	Limit (dBuV/)	Over Limit (dB)	Detector	Height (cm)	degree (deg)	Remark
1	43.0504	44.55	-11.57	32.98	40.00	-7.02	peak			
2	53.1313	44.11	-14.79	29.32	40.00	-10.68	peak			
3	67.9128	46.59	-18.73	27.86	40.00	-12.14	peak			
4	114.9167	41.70	-15.97	25.73	43.50	-17.77	peak			
5	336.0350	34.10	-13.49	20.61	46.00	-25.39	peak			
6	400.4318	37.78	-11.86	25.92	46.00	-20.08	peak			

Job No.:	011609746I	Polarization:	Horizontal
Standard:	(RE)FCC PART 15C_Class B_3m	Power Source:	AC 120V, 60Hz for PC
Test item:	Radiation Test (Above 1GHz)	Temp.(C)/Hum.(%RH):	24.3(C)/55%RH
Test Mode:	TX(2402 MHz)	Distance:	3m

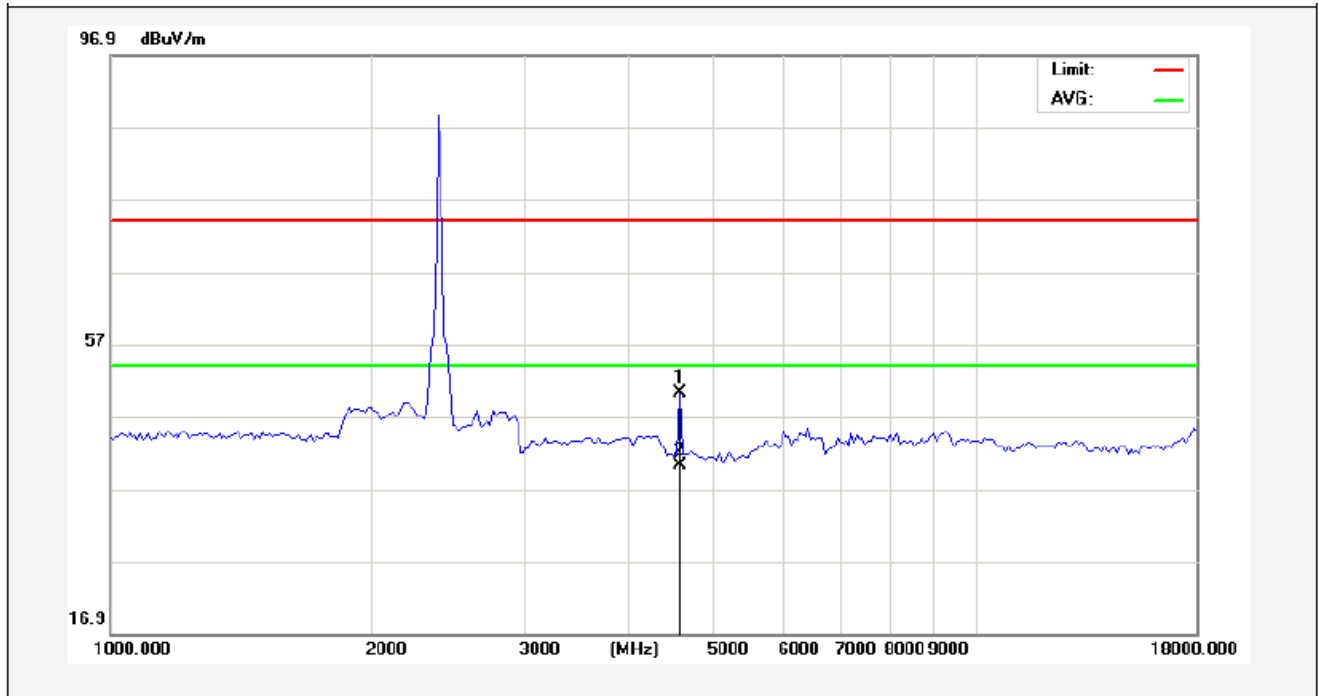

No.	Freq. (MHz)	Reading (dBuV/m)	Factor (dB/m)	Result (dBuV/m)	Limit (dBuV/)	Over Limit (dB)	Detector	Height (cm)	degree (deg)	Remark
1	4570.000	47.23	2.88	50.11	74.00	-23.89	peak			
2	4570.000	37.25	2.88	40.13	54.00	-13.87	AVG			



Job No.:	011609746I	Polarization:	Vertical
Standard:	(RE)FCC PART 15C_Class B_3m	Power Source:	AC 120V, 60Hz for PC
Test item:	Radiation Test (Above 1GHz)	Temp.(C)/Hum.(%RH):	24.3(C)/55%RH
Test Mode:	TX(2402 MHz)	Distance:	3m

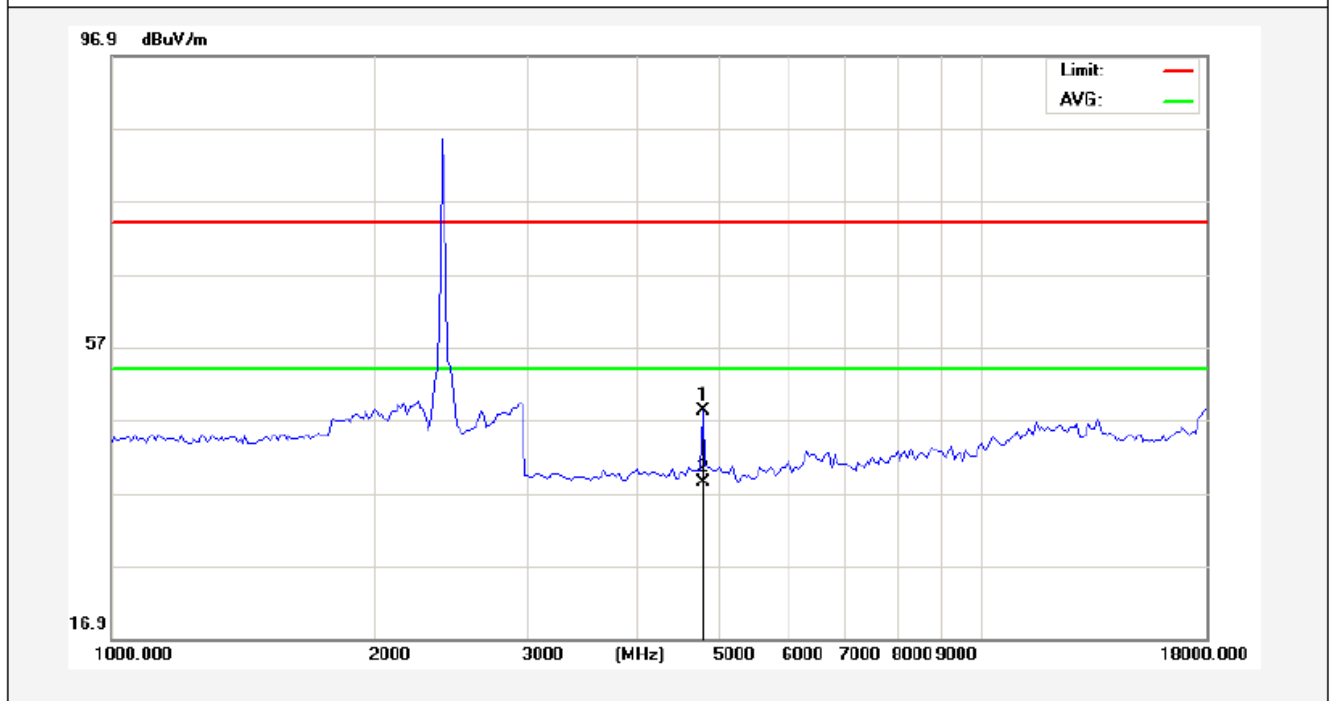

No.	Freq. (MHz)	Reading (dBuV/m)	Factor (dB/m)	Result (dBuV/m)	Limit (dBuV/)	Over Limit (dB)	Detector	Height (cm)	degree (deg)	Remark
1	4782.500	45.00	3.26	48.26	74.00	-25.74	peak			
2	4782.500	35.08	3.26	38.34	54.00	-15.66	AVG			

A M P

Job No.:	011609746I	Polarization:	Horizontal
Standard:	(RE)FCC PART 15C_Class B_3m	Power Source:	AC 120V, 60Hz for PC
Test item:	Radiation Test (Above 1GHz)	Temp.(C)/Hum.(%RH):	24.3(C)/55%RH
Test Mode:	TX(2441 MHz)	Distance:	3m

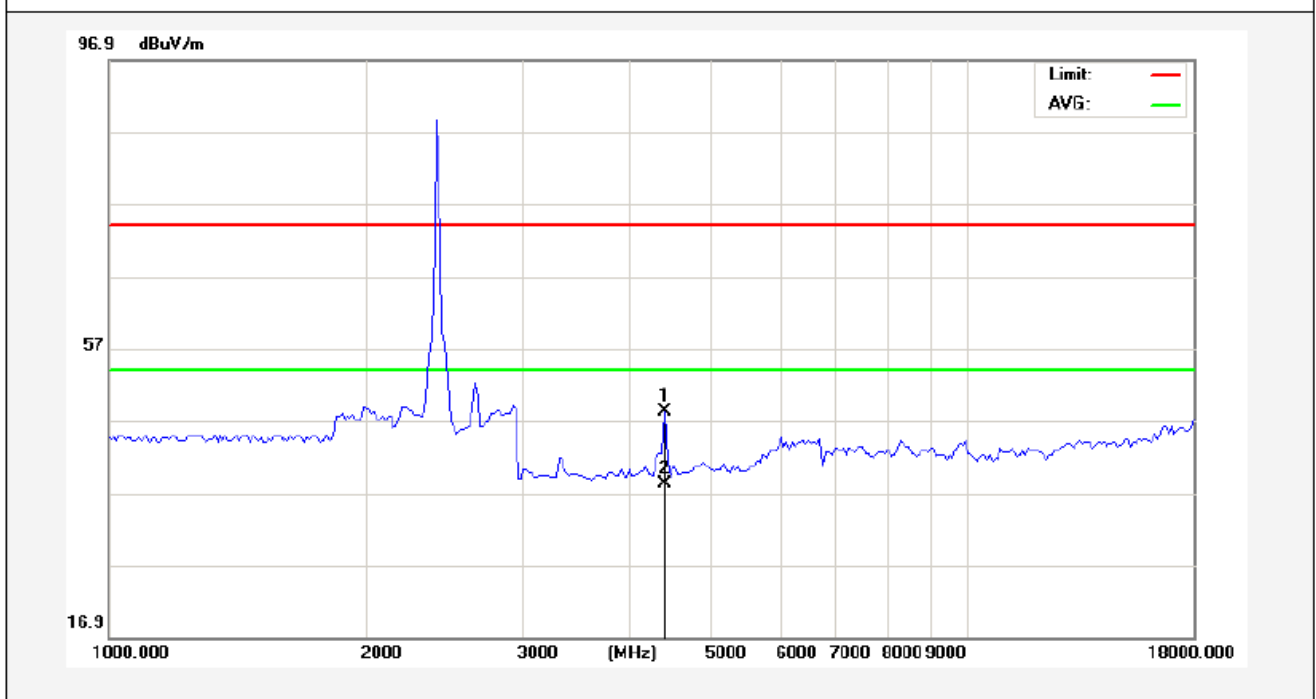

No.	Freq. (MHz)	Reading (dBuV/m)	Factor (dB/m)	Result (dBuV/m)	Limit (dBuV/)	Over Limit (dB)	Detector	Height (cm)	degree (deg)	Remark
1	4400.000	45.53	2.63	48.16	74.00	-25.84	peak			
2	4400.000	35.50	2.63	38.13	54.00	-15.87	AVG			

A M

Job No.:	011609746I	Polarization:	Vertical
Standard:	(RE)FCC PART 15C_Class B_3m	Power Source:	AC 120V, 60Hz for PC
Test item:	Radiation Test (Above 1GHz)	Temp.(C)/Hum.(%RH):	24.3(C)/55%RH
Test Mode:	TX(2441 MHz)	Distance:	3m

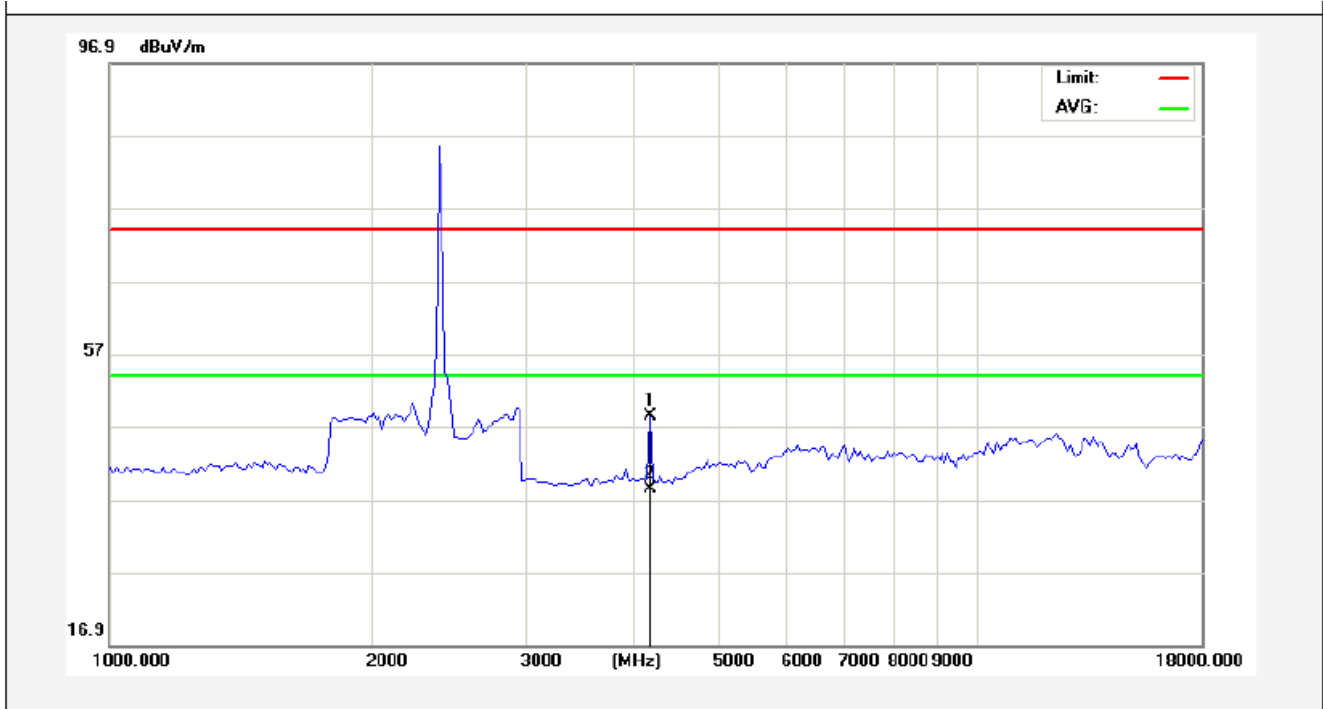

No.	Freq. (MHz)	Reading (dBuV/m)	Factor (dB/m)	Result (dBuV/m)	Limit (dBuV/)	Over Limit (dB)	Detector	Height (cm)	degree (deg)	Remark
1	4187.500	46.10	2.34	48.44	74.00	-25.56	peak			
2	4187.500	36.00	2.34	38.34	54.00	-15.66	AVG			

A M

Job No.:	011609746I	Polarization:	Horizontal
Standard:	(RE)FCC PART 15C_Class B_3m	Power Source:	AC 120V, 60Hz for PC
Test item:	Radiation Test (Above 1GHz)	Temp.(C)/Hum.(%RH):	24.3(C)/55%RH
Test Mode:	TX(2480 MHz)	Distance:	3m

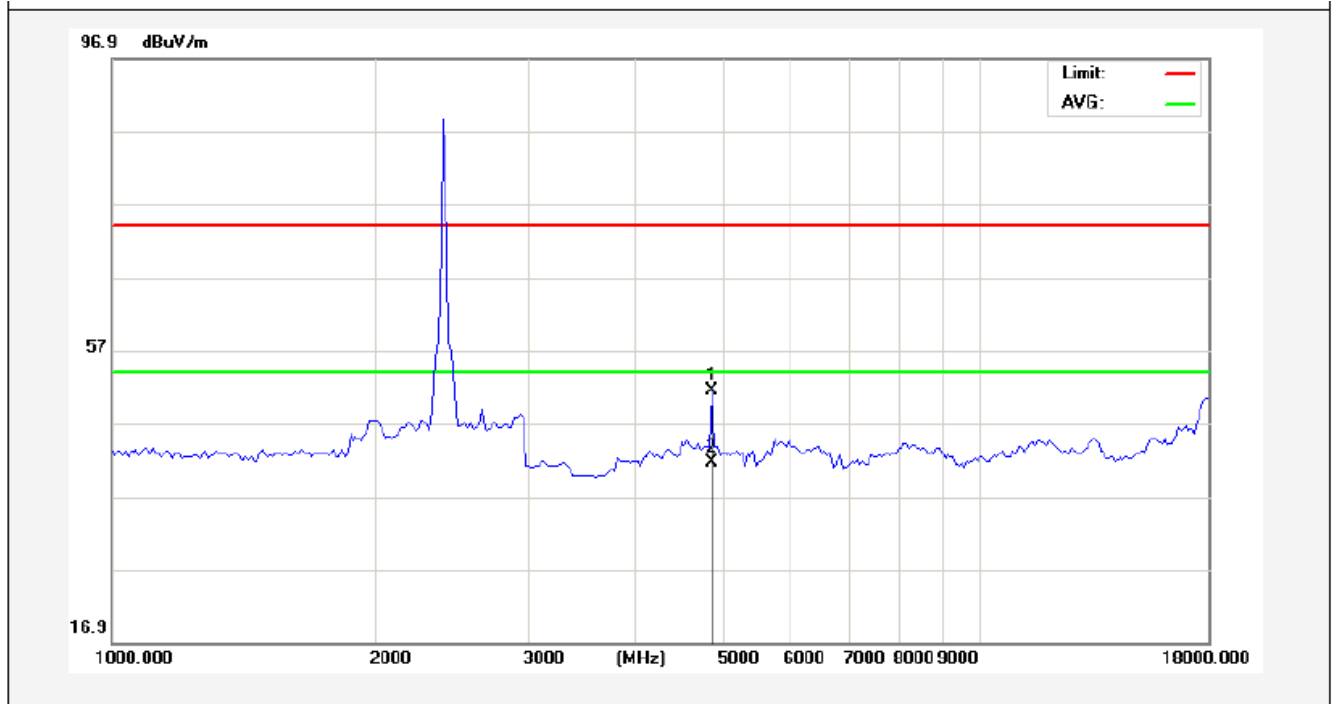

No.	Freq. (MHz)	Reading (dBuV/m)	Factor (dB/m)	Result (dBuV/m)	Limit (dBuV/)	Over Limit (dB)	Detector	Height (cm)	degree (deg)	Remark
1	4867.500	47.95	3.41	51.36	74.00	-22.64	peak			
2	4867.500	38.27	3.41	41.68	54.00	-12.32	AVG			

Job No.:	011609746I	Polarization:	Vertical
Standard:	(RE)FCC PART 15C_Class B_3m	Power Source:	AC 120V, 60Hz for PC
Test item:	Radiation Test (Above 1GHz)	Temp.(C)/Hum.(%RH):	24.3(C)/55%RH
Test Mode:	TX(2480 MHz)	Distance:	3m

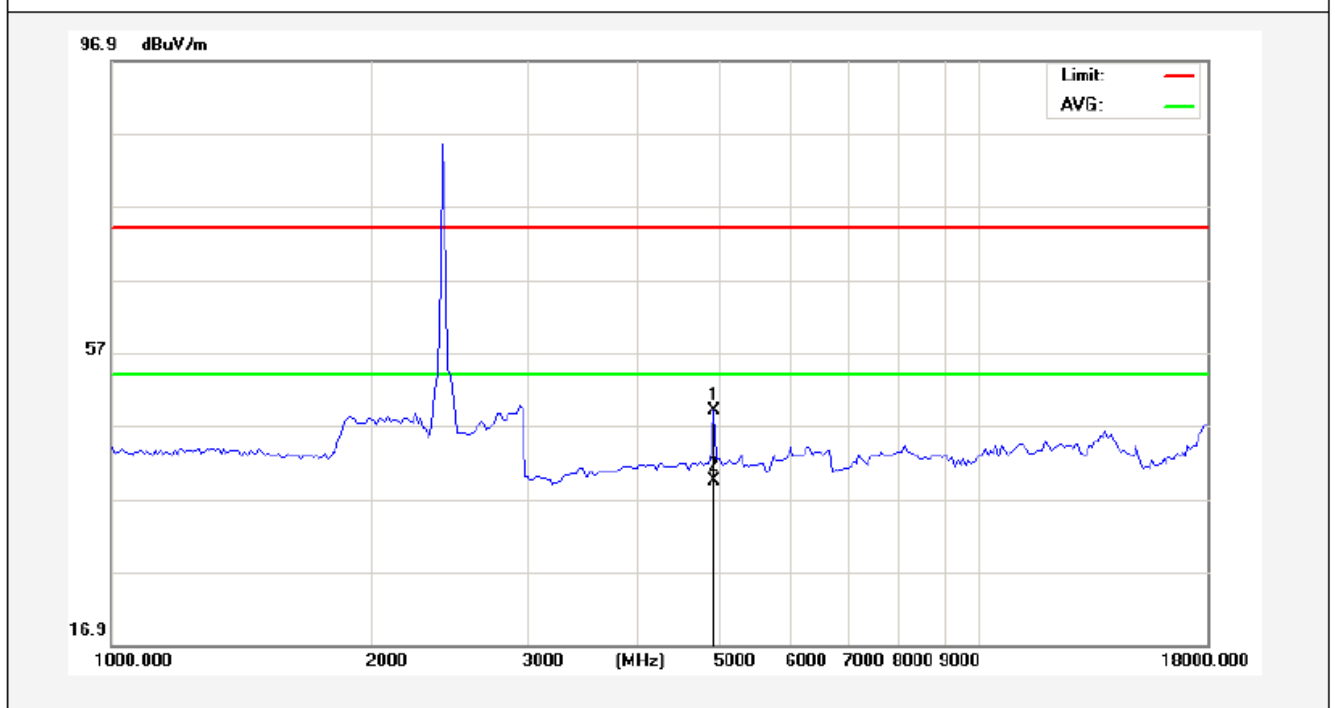

No.	Freq. (MHz)	Reading (dBuV/m)	Factor (dB/m)	Result (dBuV/m)	Limit (dBuV/)	Over Limit (dB)	Detector	Height (cm)	degree (deg)	Remark
1	4910.000	45.51	3.49	49.00	74.00	-25.00	peak			
2	4910.000	35.97	3.49	39.46	54.00	-14.54	AVG			

A M P

5. CHANNEL SEPARATION TEST

5.1 Measurement Procedure

The EUT must have its hopping function enabled. Using the following spectrum analyzer settings:

1. Span= Wide enough to capture the peaks of two adjacent channels
2. Set the RBW = 100 kHz.
3. Set the VBW = 100 kHz.
4. Sweep time = auto couple.
5. Detector function = peak.
6. Trace mode = max hold.
7. Allow trace to fully stabilize.

5.2 Test SET-UP

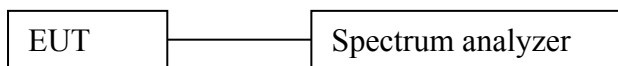

5.3 Test Equipment

Item	Equipment	Manufacturer	Model No.	Serial No.	Last Cal.	Cal. Interval
1.	Spectrum Analysis	Agilent	E4407B	US39390582	Apr. 16, 2016	1 Year
2.	Preamplifier	Instruments corporation	EMC011830	980100	Apr. 16, 2016	1 Year
3.	EMI Test Receiver	Rohde & Schwarz	ESPI	101604	Apr. 16, 2016	1 Year
4.	Double Ridged Horn Antenna	Instruments corporation	GTH-0118	351600	Apr. 19, 2016	1 Year
5.	Bilog Broadband Antenna	Schwarzbeck	VULB9163	VULB 9163-289	Apr. 19, 2016	1 Year
6.	Pre-amplifier	SONOMA	310N	186860	Apr. 16, 2016	1 Year
7.	EMI Test Software EZ-EMC	SHURPLE	N/A	N/A	N/A	N/A
8	Power Sensor	DAER	RPR3006W	15100041SN046	Jun 30, 2016	1 Year
9	MXA Spectrum Analysis	Agilent	N9020A	MY51170037	Jun 30, 2016	1 Year
10	MXG RF Vector Signal Generator	Agilent	N5182A	MY48180656	Jun 30, 2016	1 Year
11	Signal Generator	Agilent	E4421B	MY41000743	Jun 30, 2016	1 Year
12	DC Power supply	IV	IV-8080	YQSB0096	Jun 30, 2016	1 Year
13	TEMP&HUMI PROGRAMMABLE CHAMBER	Bell Group	BE-THK-15 0M8	SE-0137	Mar 16, 2016	1 Year
14	Spectrum Analysis	Rohde & Schwarz	FSV40	132.1.3008K39 -100965	Mar 17, 2016	1 Year
15	Pre-amplifier	Agilent	8449B	3008A00252	Mar 17, 2016	1 Year
16	Horn Antenna	SCHWARZBECK	BBHA9170	9170-068	Mar 17, 2016	1 Year

5.4 Test Results

Test Item	: Frequency Separation	Test Mode	: CH Low ~ CH High
Test Voltage	: AC 120V, 60Hz for PC	Temperature	: 24°C
Test Result	: PASS	Humidity	: 55%RH

Channel	Frequency (MHz)	Separation Read Value (kHz)	Limit (kHz)	Modulation Mode
Low	2402	1002	927.1	BDR
Mid	2441	1002	925.9	BDR
High	2480	1002	926.3	BDR
Low	2402	1002	843.3	EDR
Mid	2441	1002	841.3	EDR
High	2480	1002	842.0	EDR

Remark:

1. The limit of mode (EDR) is 2/3 of 20dB BW;
2. The EDR was tested on ($\pi/4$ DQPSK, 8DPSK) modes, only the worst data of ($\pi/4$ DQPSK) is attached in the following pages.

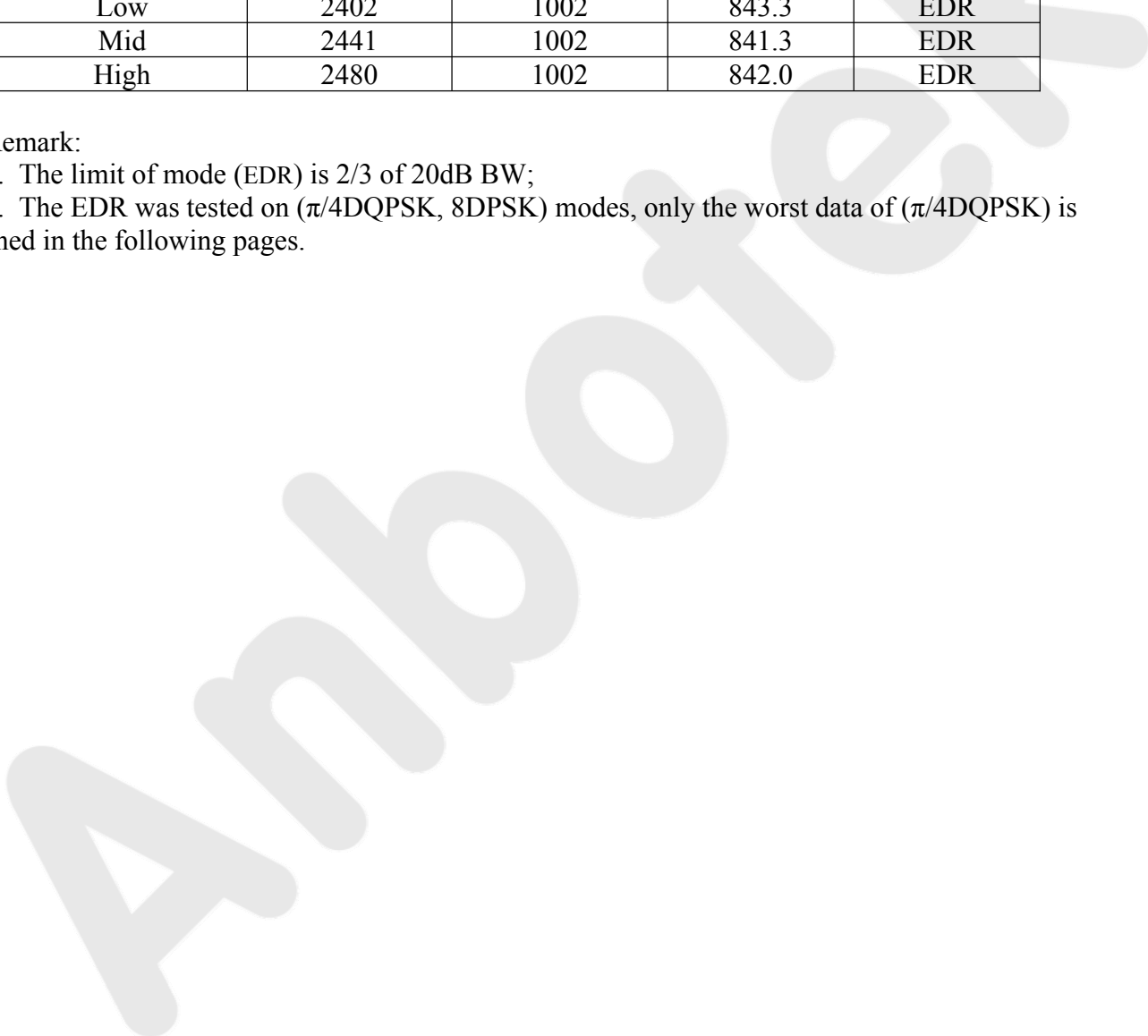



Test Mode: BDR---Low

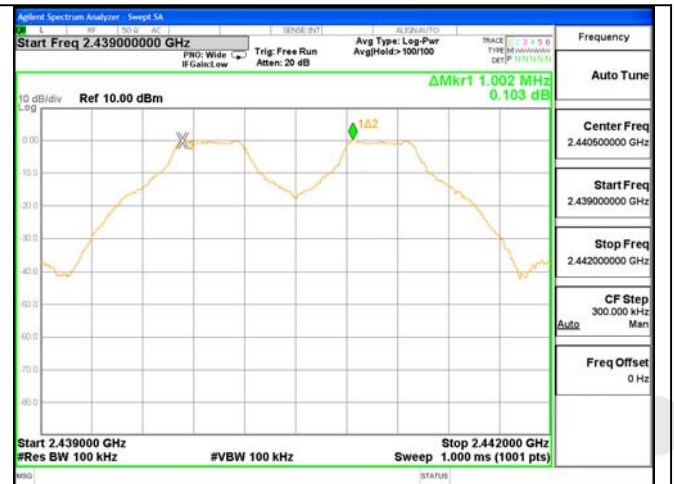

Test Mode: BDR---Mid



Test Mode: BDR---High



Test Mode: EDR---Low



Test Mode: EDR---Mid

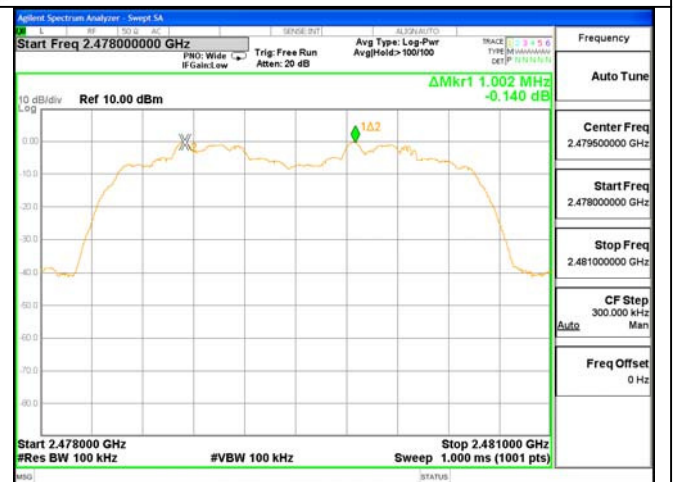

Test Mode: EDR---High

6. 20DB BANDWIDTH TEST

6.1 Measurement Procedure

Using the following spectrum analyzer settings:

1. Span= approximately 2 to 3 times the 20dB bandwidth, centered on a hopping channel.
2. Set the RBW = 30 kHz.
3. Set the VBW = 100 kHz.
4. Sweep time = auto couple.
5. Detector function = peak.
6. Trace mode = max hold.
7. Allow trace to fully stabilize.

6.2 Test SET-UP

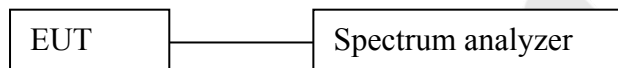

6.3 Test Equipment

Same as the equipment listed in 5.3.

6.4 Test Results

Test Item	: 20dB BW	Test Mode	: CH Low ~ CH High
Test Voltage	: AC 120V, 60Hz for PC	Temperature	: 24°C
Test Result	: PASS	Humidity	: 55%RH

Channel	Frequency (MHz)	20dB Down BW(kHz)	Modulation Mode
Low	2402	927.1	BDR
Mid	2441	925.9	BDR
High	2480	926.3	BDR
Low	2402	1265.0	EDR
Mid	2441	1262.0	EDR
High	2480	1263.0	EDR

Remark: The EDR was tested on ($\pi/4$ DQPSK, 8DPSK) modes, only the worst data of ($\pi/4$ DQPSK) is attached in the following pages.

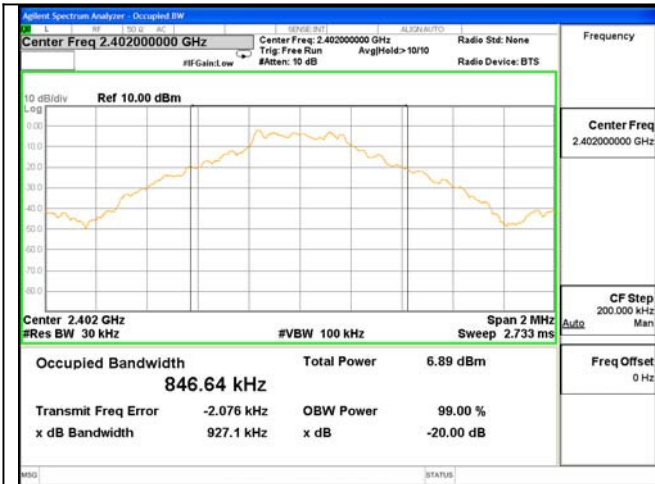

Test Mode: BDR---Low

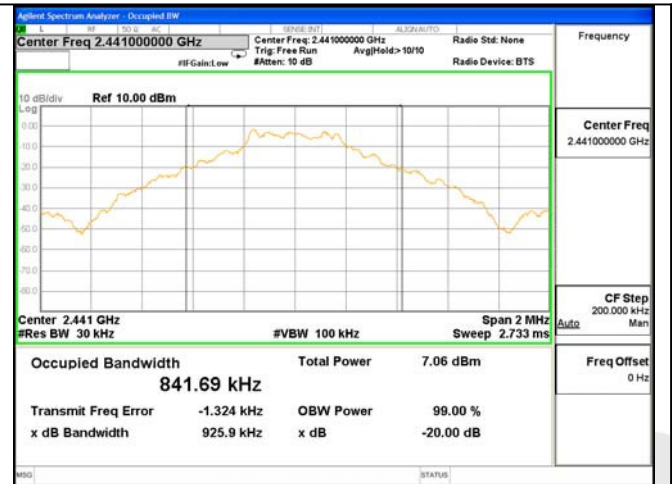

Test Mode: BDR---Mid

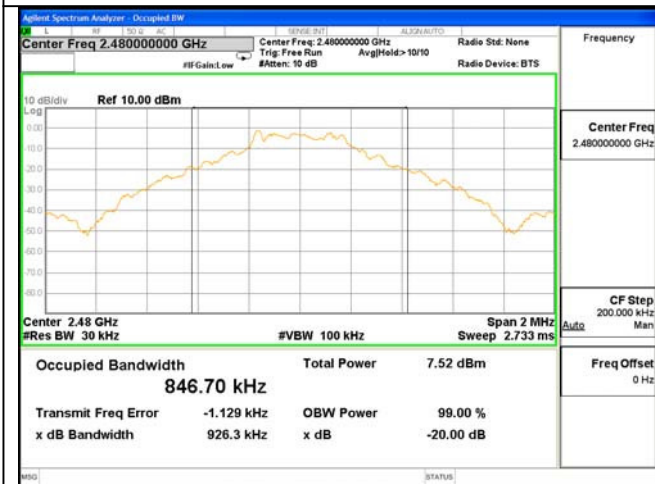

Test Mode: BDR---High

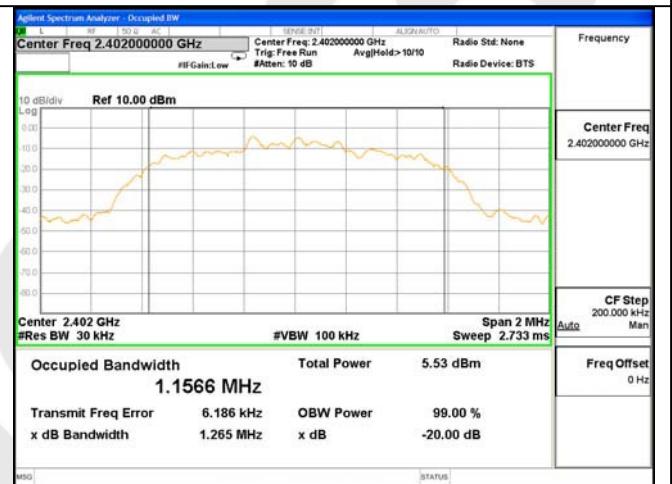

Test Mode: EDR---Low

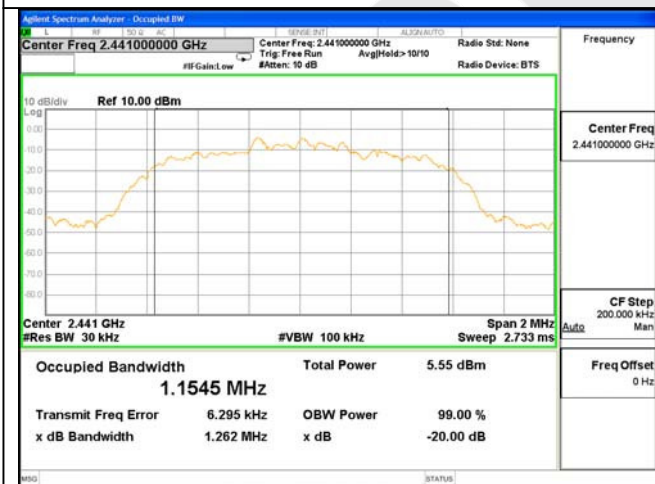

Test Mode: EDR---Mid

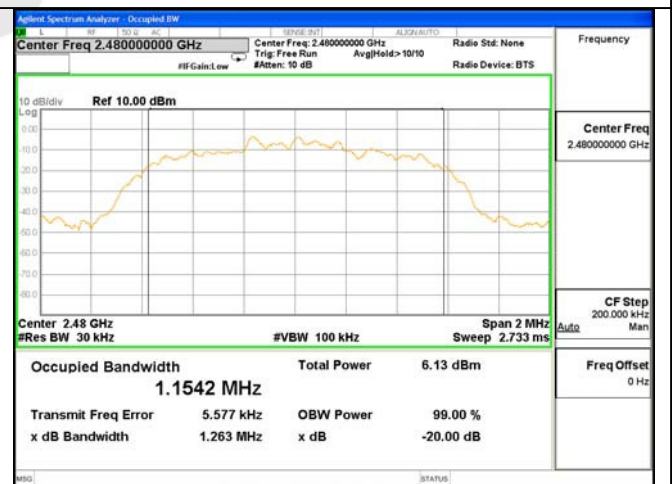

Test Mode: EDR---High

7. QUANTITY OF HOPPING CHANNEL TEST

7.1 Measurement Procedure

The EUT must have its hopping function enabled. Using the following spectrum analyzer setting:

1. Span= the frequency band of operation
2. Set the RBW = 1 MHz.
3. Set the VBW = 1 MHz.
4. Sweep time = auto couple.
5. Detector function = peak.
6. Trace mode = max hold.
7. Allow trace to fully stabilize.

7.2 Test SET-UP

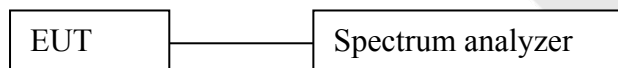

7.3 Test Equipment

Same as the equipment listed in 5.3.

7.4 Test Results

Test Item	: Number of Hopping Frequency	Test Mode	: CH Low ~ CH High
Test Voltage	: AC 120V, 60Hz for PC	Temperature	: 24°C
Test Result	: PASS	Humidity	: 55%RH

Hopping Channel Frequency Range	Quantity of Hopping Channel	Quantity of Hopping Channel
2402-2480	79	>15

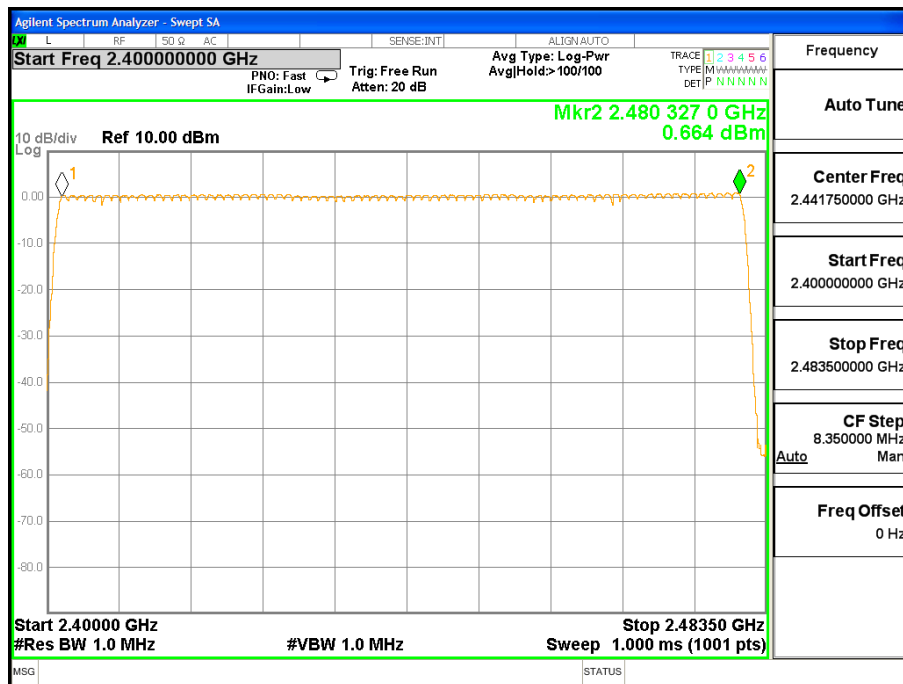

8. DWELL TIME TEST

8.1 Measurement Procedure

The EUT must have its hopping function enabled. Use the following spectrum analyzer settings:

1. Span= zero span, centered on a hopping channel
2. Set the RBW = 1 MHz.
3. Set the VBW = 1 MHz.
4. Sweep time = as necessary to capture the entire dwell time per hopping channel.
5. Detector function = peak.
6. Trace mode = max hold.
7. Allow trace to fully stabilize.

8.2 Test SET-UP

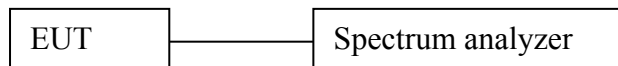

8.3 Test Equipment

Same as the equipment listed in 5.3.

8.4 Test Results

Test Item	:	Time of Occupancy	Test Mode	:	CH Low ~ CH High
Test Voltage	:	AC 120V, 60Hz for PC	Temperature	:	24°C
Test Result	:	PASS	Humidity	:	55%RH

Package Type	Pulse width (ms)	Time slot length(ms)	Dwell time (ms)	Limit (s)	Modulation
DH1	0.364	time slot length *1600/2 /79 * 31.6	116.48	0.4	BDR
DH3	1.615	time slot length *1600/4 /79 * 31.6	258.40	0.4	BDR
DH5	2.870	time slot length *1600/6 /79 * 31.6	306.13	0.4	BDR

Remark: The EDR was tested on ($\pi/4$ DQPSK, 8DPSK) modes, only the worst data of ($\pi/4$ DQPSK) is attached in the following pages.



DH1



DH3

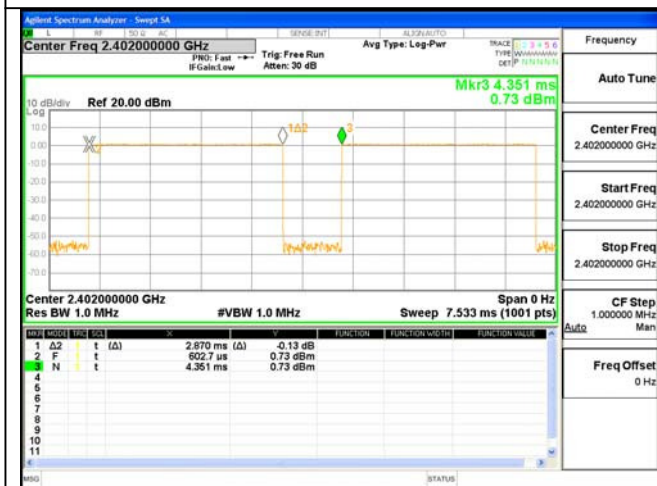

DH5

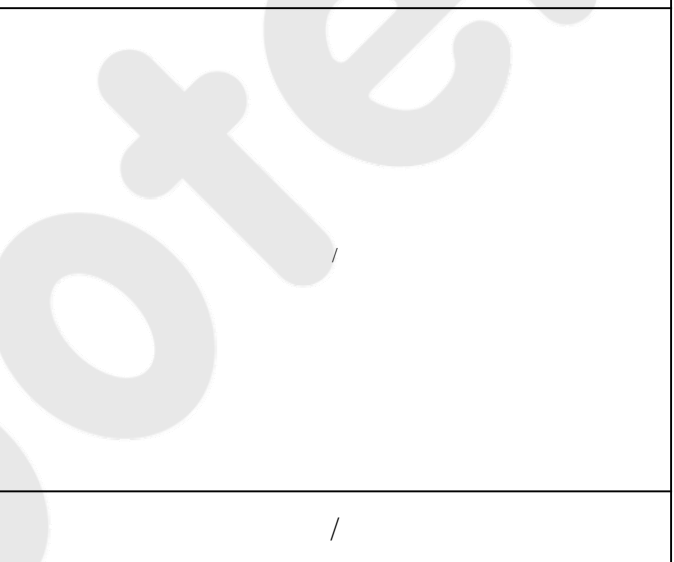

/

9. MAXIMUM PEAK OUTPUT POWER TEST

9.1 Measurement Procedure

- a. Check the calibration of the measuring instrument(SA) using either an internal calibrator or a known signal from an external generator.
- b. Turn on the EUT and connect it to measurement instrument. Then set it to any one convenient frequency within its operating range. Set a reference level on the measuring instrument equal to the highest peak value.
- c. The center frequency of the spectrum analyzer is set to the fundamental frequency and using proper RBW and VBW setting.
- d. Measure the captured power within the band and recording the plot.
- e. Repeat above procedures until all frequencies required were complete.

Using the following spectrum analyzer settings:

1. Span= approximately 5 times the 20dB bandwidth, centered on a hopping channel
2. Set the RBW = 3 MHz.
3. Set the VBW = 3 MHz.
4. Sweep time = auto couple.
5. Detector function = peak.
6. Trace mode = max hold.
7. Allow trace to fully stabilize.

9.2 Test SET-UP



9.3 Test Equipment

Same as the equipment listed in 5.3.

9.4 Test Results

Test Item	: Max. peak output power	Test Mode	: CH Low ~ CH High
Test Voltage	: AC 120V, 60Hz for PC	Temperature	: 24°C
Test Result	: PASS	Humidity	: 55%RH

Channel Frequency (MHz)	Peak Power output(mW)	Peak Power output(dBm)	Peak Power Limit(mW)	Results	Modulation
2402	1.762	2.459	1000	PASS	BDR
2441	2.203	3.431	1000	PASS	BDR
2480	2.485	3.954	1000	PASS	BDR
2402	1.690	2.280	125	PASS	EDR
2441	1.698	2.299	125	PASS	EDR
2480	1.944	2.886	125	PASS	EDR

Remark: The EDR was tested on ($\pi/4$ DQPSK, 8DPSK) modes, only the worst data of ($\pi/4$ DQPSK) is attached in the following pages.

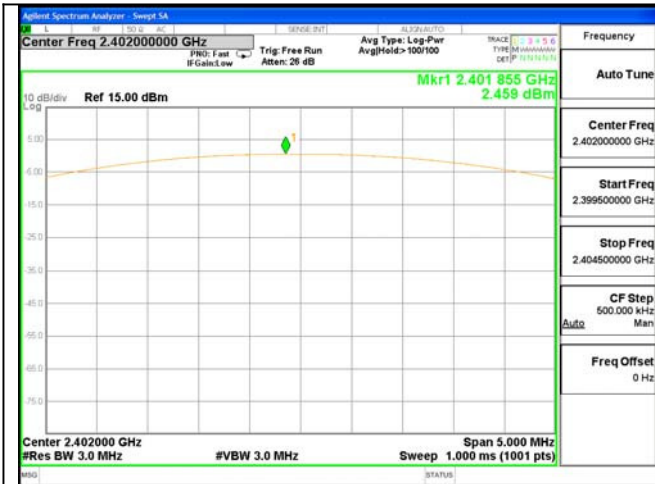

Test Mode: BDR---Low

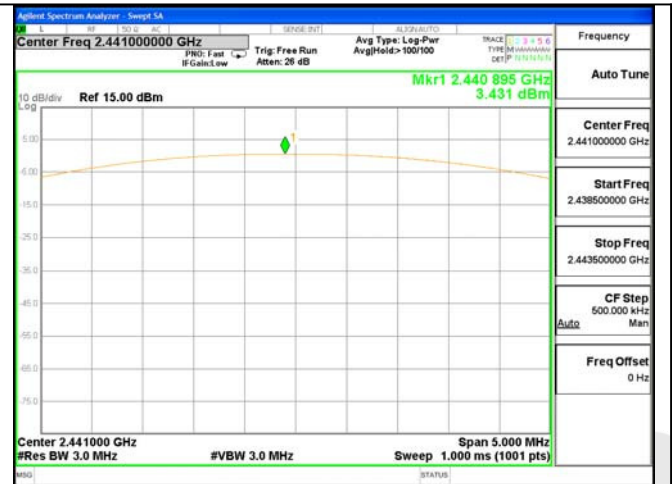

Test Mode: BDR---Mid

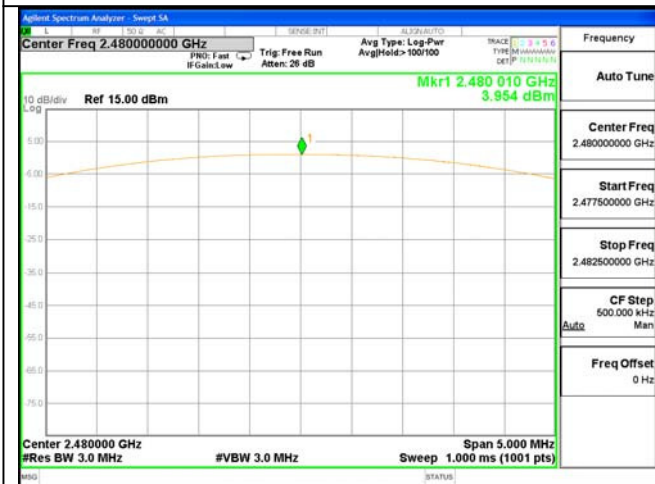

Test Mode: BDR---High

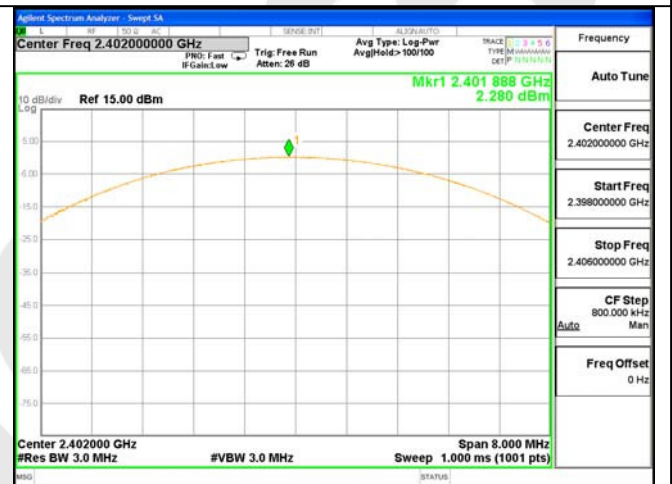

Test Mode: EDR---Low



Test Mode: EDR---Mid

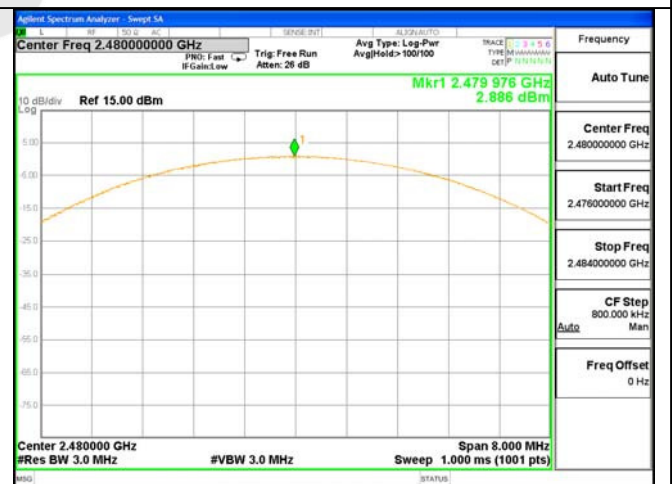

Test Mode: EDR---High

10. BAND EDGE TEST

10.1 Measurement Procedure

A) Conducted Emission method:

1. Check the calibration of the measuring instrument using either an internal calibrator or a known signal from an external generator.
2. Position the EUT without connection to measurement instrument. Put it on the Rotated table and turn on the EUT and make it operate in transmitting mode. Then set it to low Channel and High Channel within its operating range, and make sure the instrument is operated in its linear range.
3. Set both RBW and VBW of spectrum analyzer to 100kHz with a convenient frequency span including 100kHz bandwidth from band edge,
4. Measurement the highest amplitude appearing on spectral display and set it as a reference level. Plot the graph with marking the highest point and edge frequency.
5. Report above procedures until all measured frequencies were complete.

B) Radiated Emission method:

The EUT is placed on a turn table which is 1.5 meter high above the ground. The turn table can rotate 360 degrees to determine the position of the maximum emission level. The EUT is set 3 meters away from the receiving antenna which is mounted on a antenna tower. The antenna can be moved up and down from 1 to 4 meters to find out the maximum emission level. Rotated the EUT through three orthogonal axes to determine the maximum emissions, both horizontal and vertical polarization of the antenna are set on test. The EUT is tested in 9*6*6 Chamber. for Radiated emissions restricted band RBW= 1 MHz, VBW= 3 MHz.

10.2 Test SET-UP

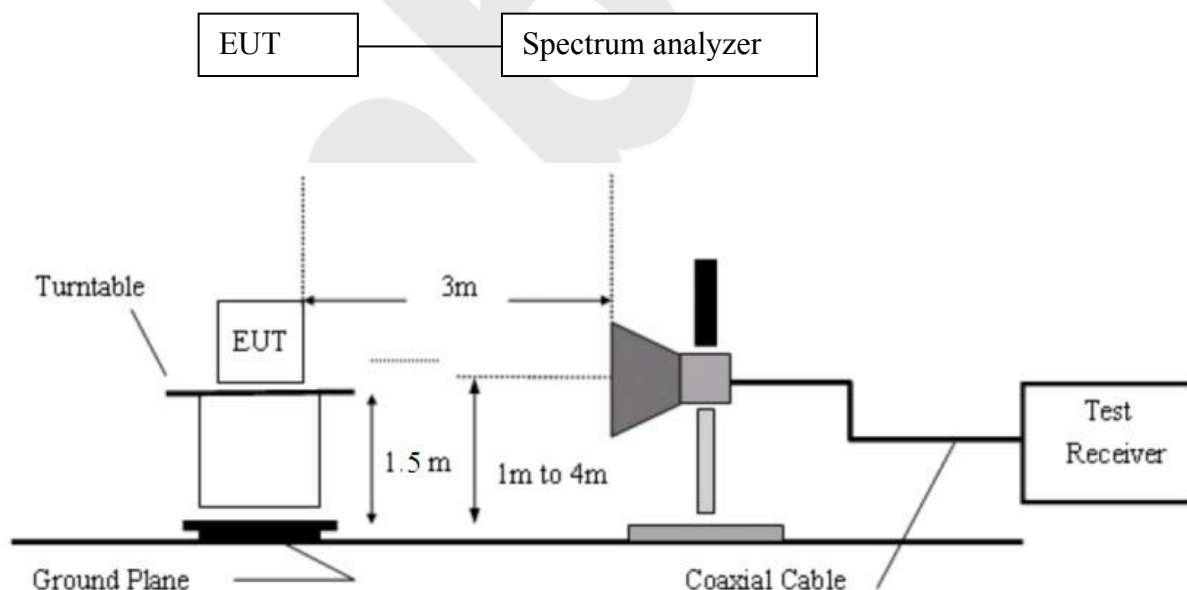

10.3 Test Equipment

Same as the equipment listed in 5.3.

10.4 Test Results

Pass.

Please refer the following data.

Test Item	: Band edge	Test Mode	: CH Low ~ CH High
Test Voltage	: AC 120V, 60Hz for PC	Temperature	: 24°C
Test Result	: PASS	Humidity	: 55%RH

For Hopping Mode:

Remark: The EDR was tested on ($\pi/4$ DQPSK, 8DPSK) modes, only the worst data of ($\pi/4$ DQPSK) is attached in the following pages.

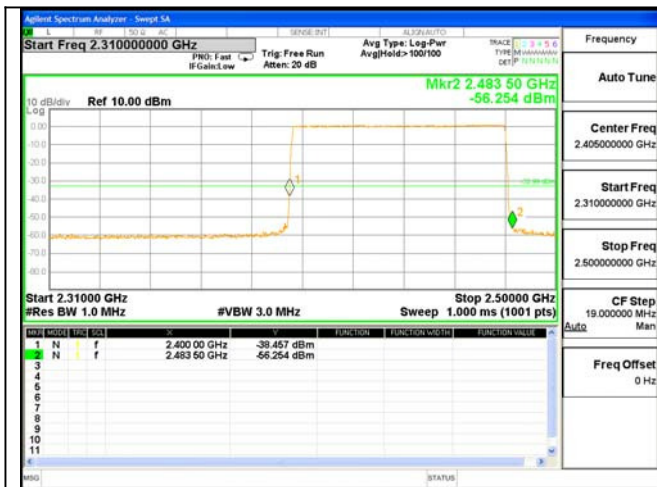

Test Mode: BDR

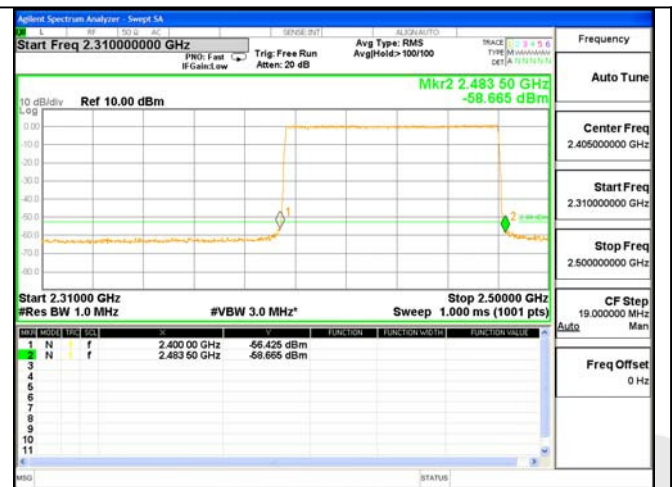

Test Mode: BDR

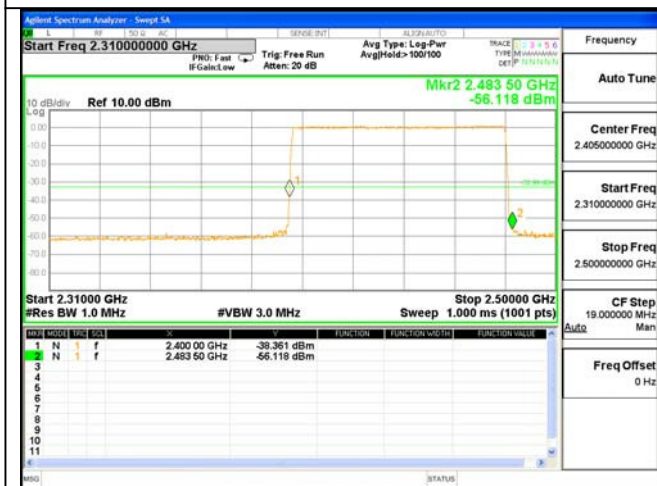

Test Mode: EDR

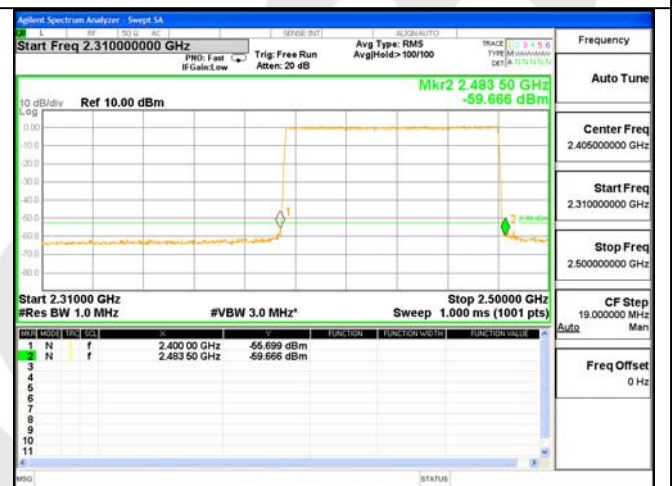

Test Mode: EDR

Test Item	: Band edge	Test Mode	: CH Low ~ CH High
Test Voltage	: AC 120V, 60Hz for PC	Temperature	: 24°C
Test Result	: PASS	Humidity	: 55%RH

For Non-Hopping Mode:

1. Conducted Test

Frequency (MHz)	Peak Power Output(dBm)	Emission read Value(dBm)	Result of Band edge(dBc)	Band edge Limit(dBc)	Modulation
<2400	0.433	-38.829	39.262	>20dBc	BDR
	0.968	-53.378	54.346	>20dBc	EDR
>2483.5	-0.108	-29.357	29.249	>20dBc	BDR
	0.487	-51.322	51.809	>20dBc	EDR

2. Radiated emission Test

Frequency (MHz)	Antenna polarization (H/V)	Emission (dBuV/m)		Band edge Limit (dBuV/m)		Modulation
		PK	AV	PK	AV	
<2400	V	48.45	38.72	74.00	54.00	BDR
	V	49.35	38.37	74.00	54.00	EDR
>2483.5	V	50.25	40.46	74.00	54.00	BDR
	V	51.77	41.67	74.00	54.00	EDR

Remark: The EDR was tested on ($\pi/4$ DQPSK, 8DPSK) modes, only the worst data of ($\pi/4$ DQPSK) is attached in the following pages.



Test Mode: BDR



Test Mode: BDR

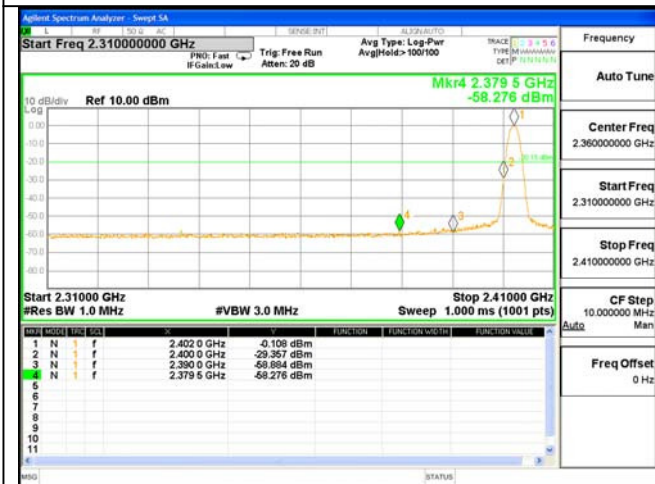

Test Mode: EDR



Test Mode: EDR

11. ANTENNA APPLICATION

11.1 Antenna requirement

The EUT'S antenna is met the requirement of FCC part 15C section 15.203 and 15.247.

FCC part 15C section 15.247 requirements:

Systems operating in the 2402-2480MHz band that are used exclusively for fixed, point-to-point operations may employ transmitting antennas with directional gain greater than 6dBi provided the maximum peak output power of the intentional radiator is reduced by 1dB for every 3dB that the directional gain of the antenna exceeds 6dBi.

11.2 Result

The EUT's antenna used a copper Antenna, which is permanently attached to the PCB with glue, The antenna's gain is 5dBi and meets the requirement.

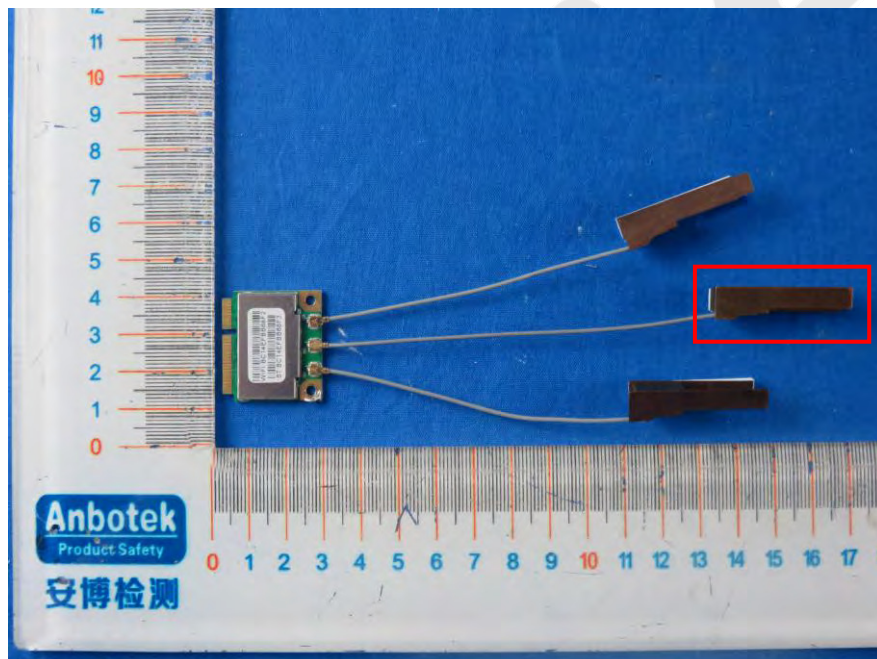

12. PHOTOGRAPH

12.1 Photo of Power Line Conducted Emission Measurement



12.2 Photo of Radiation Emission Test

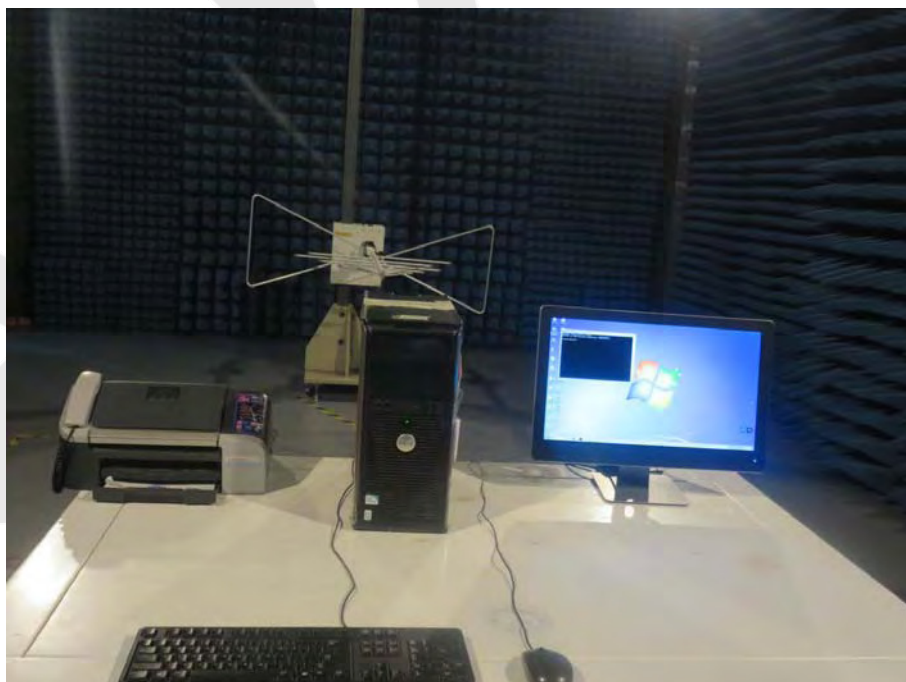

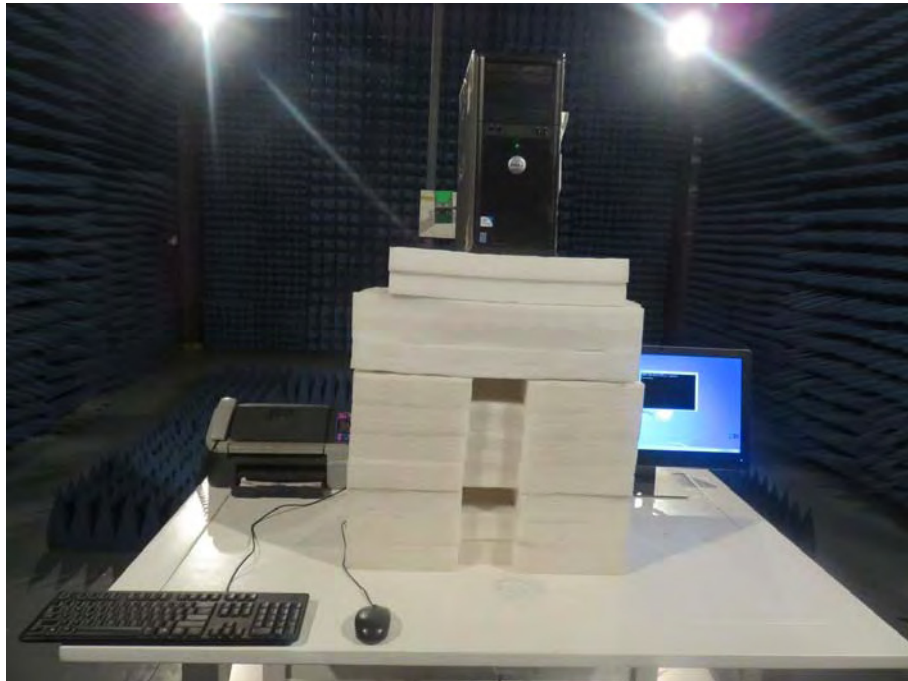

12.3. Photo of EUT in the PC

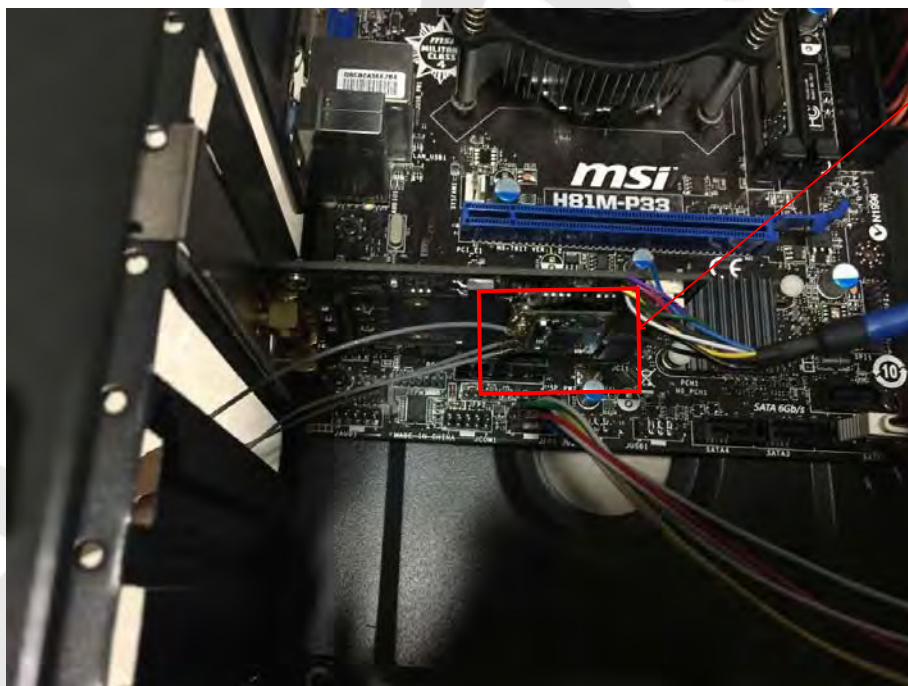

EUT



ANT

APPENDIX I (EXTERNAL PHOTOS)

1. Figure
The EUT-Overall View

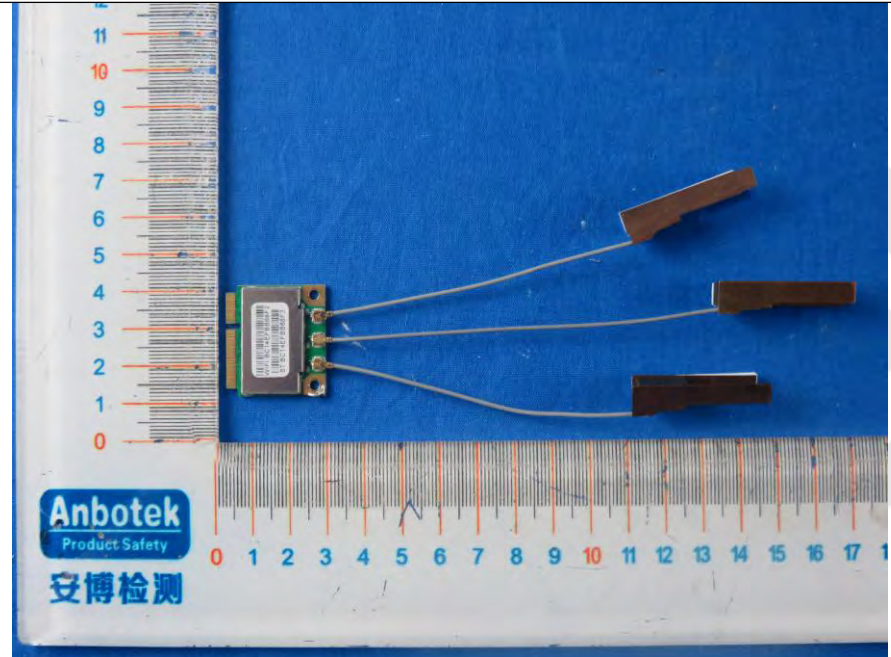

2. Figure
The EUT-Overall View

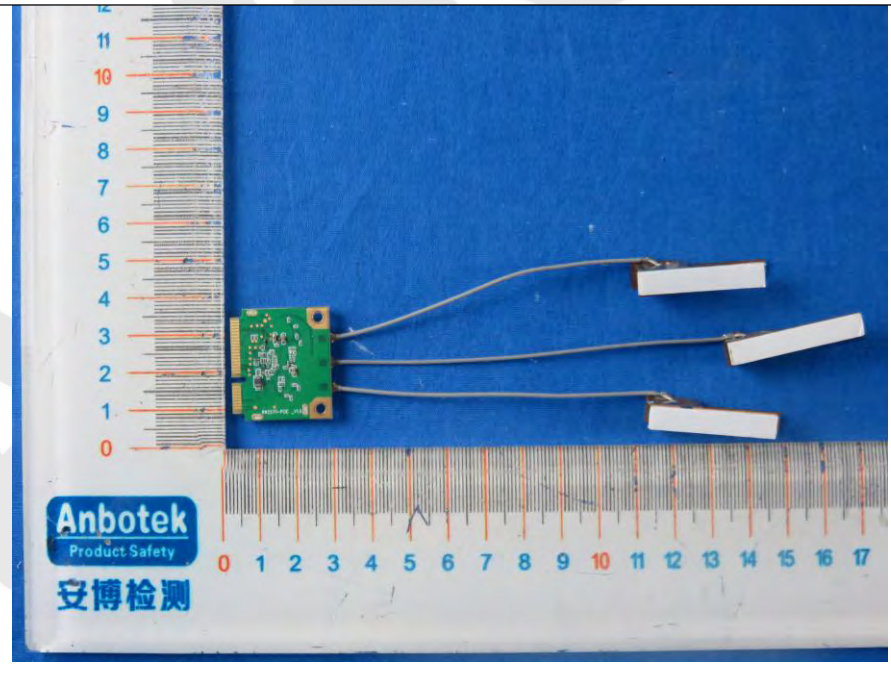

3. Figure
The EUT-Front View

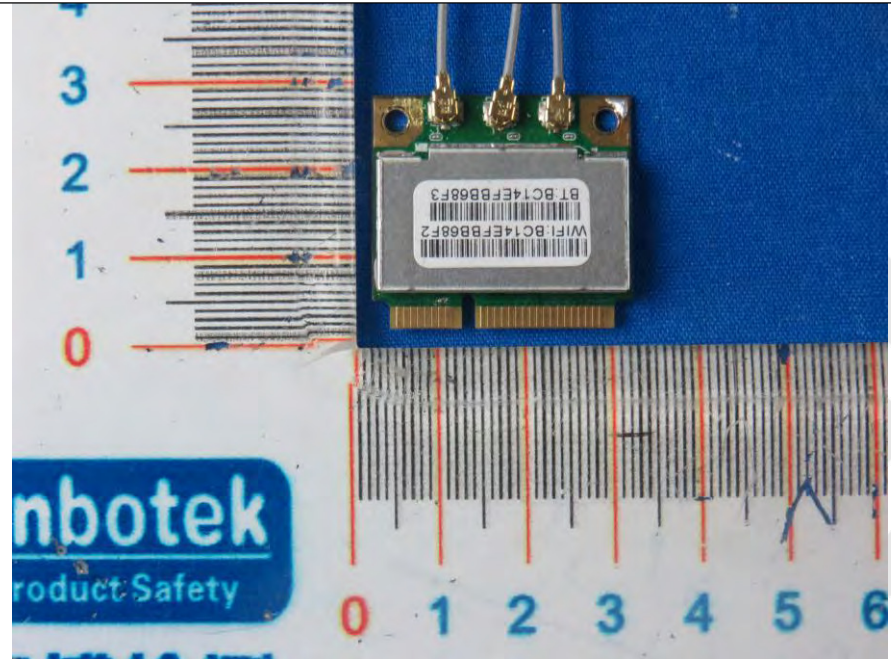

4. Figure
The EUT-Back View

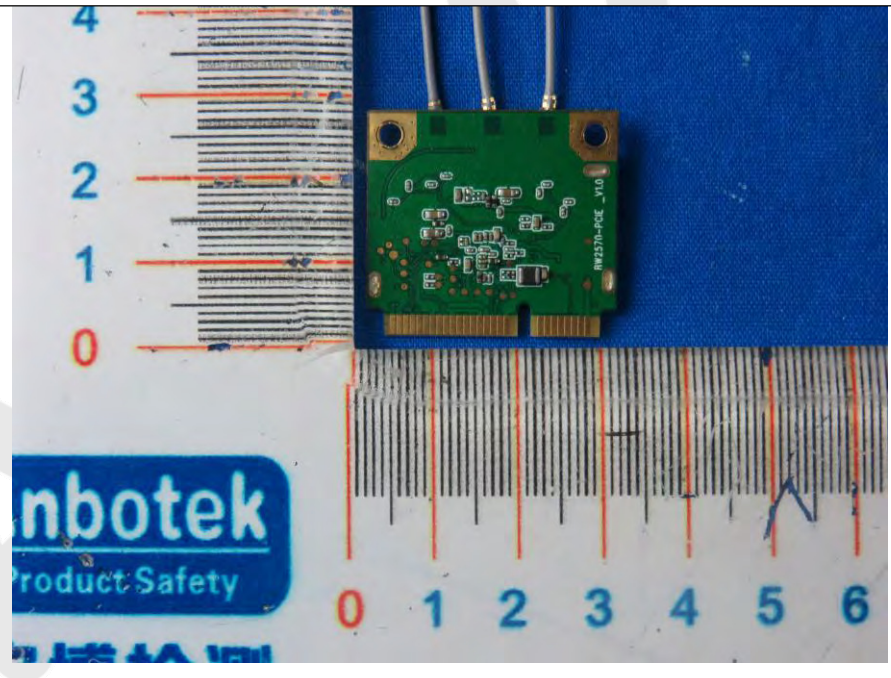

APPENDIX II (INTERNAL PHOTOS)

1. Figure
The EUT-Inside View

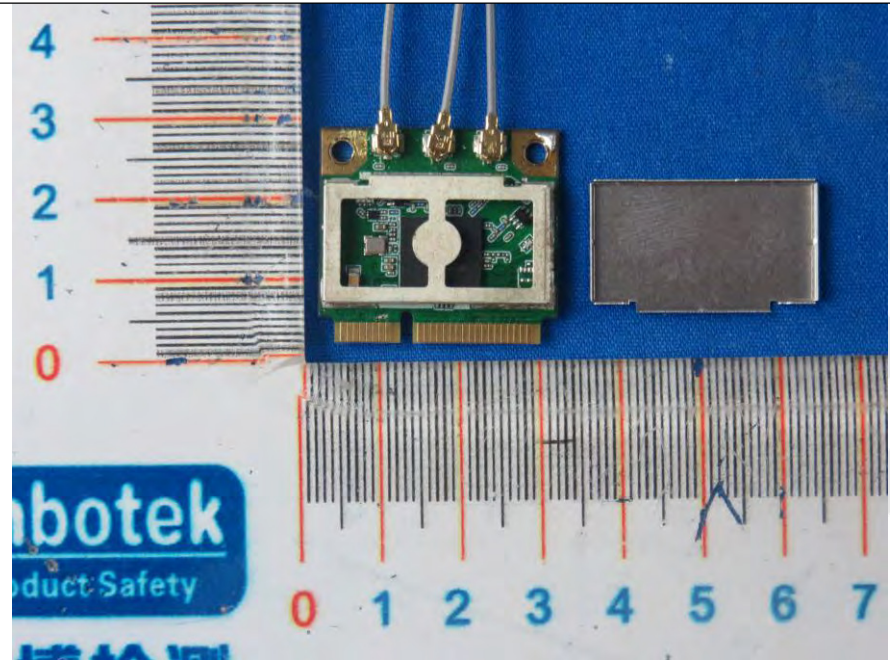

2. Figure
The EUT-Inside View

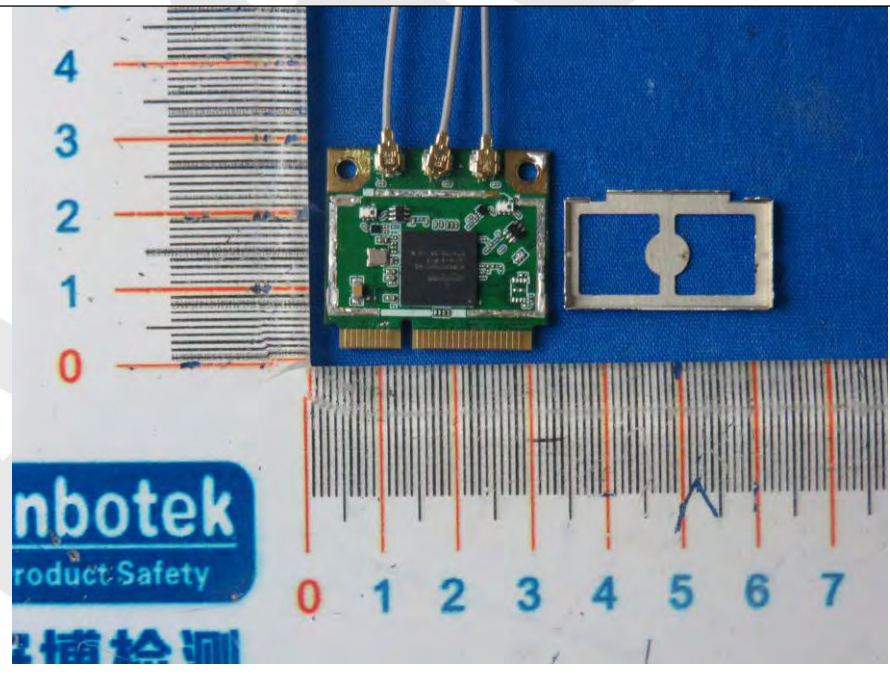

3. Figure
PCB of the EUT-Front View

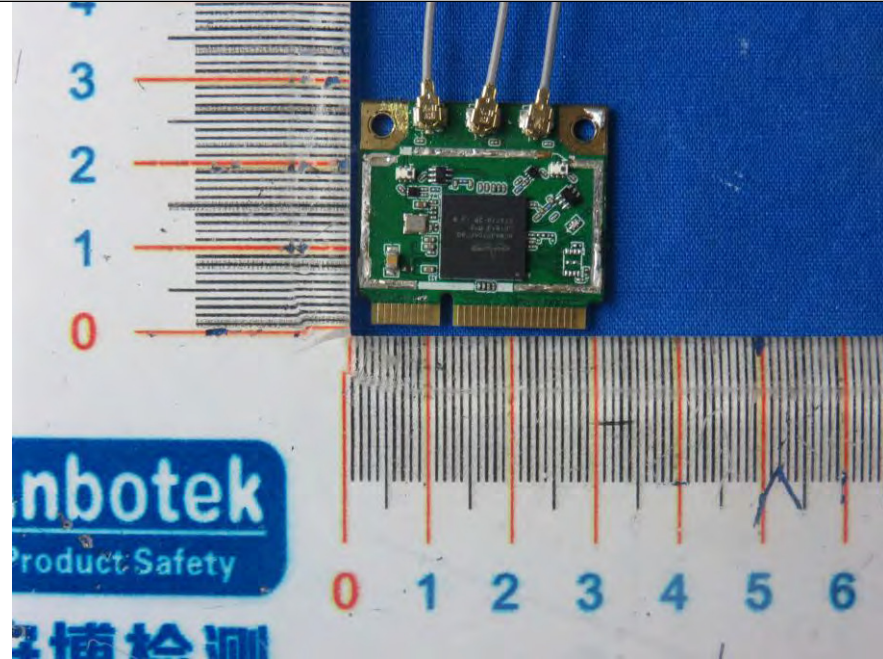

4. Figure
PCB of the EUT-Back View

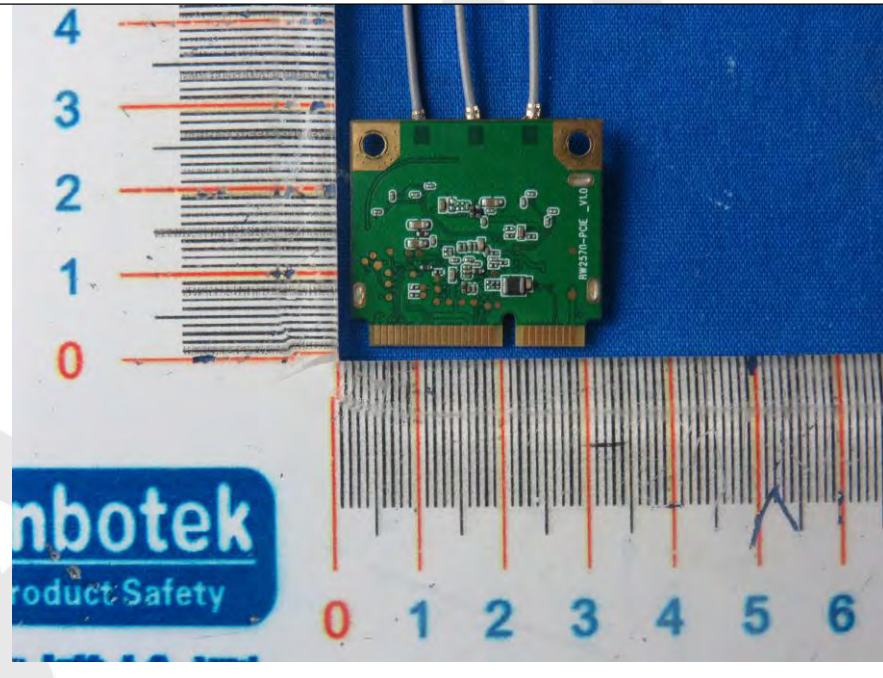

5. Figure
PCB of the EUT-Front View



6. Figure
PCB of the EUT-Back View

