

# iDeaPLAY

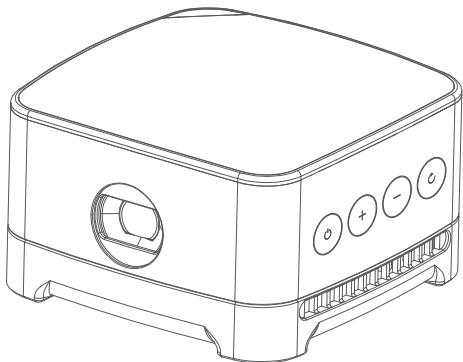

Model: P100B

Pico Projector

**USER GUIDE**

# Table of Contents

Customer Support .....	1
<b>1 Introduction .....</b>	<b>2</b>
1.1 Features .....	2
1.2 What's in the Box .....	3
1.3 Product Overview .....	4
1.4 Infrared Remote Control .....	5
<b>2 Getting started .....</b>	<b>5</b>
2.1 Using the Remote Control .....	5
2.2 Turning the Projector On/Off .....	6
2.3 Adjusting the Focus .....	6
2.4 Charging the Projector .....	7
<b>3 Home Screen Overview .....</b>	<b>7</b>
<b>4 General Settings .....</b>	<b>8</b>
4.1 Adjust the Brightness .....	9
4.2 Adjust Projection Mode .....	9
4.3 Bluetooth Control Pairing .....	9
4.4 Connecting to Wi-Fi .....	10
4.5 Keystone Correction .....	10
<b>5 All Apps .....</b>	<b>11</b>
5.1 Youtube .....	12
<b>6 Google Play .....</b>	<b>12</b>
<b>7 Files .....</b>	<b>12</b>
<b>8 Projection Sharing .....</b>	<b>12</b>
8.1 Airplay – iPhone .....	13
8.2 Airplay – Mac .....	13
8.3 Miracast – Android device .....	14
8.4 Wired Connection U Disk .....	14
<b>9 Specifications .....</b>	<b>15</b>
<b>FCC Statement .....</b>	<b>16</b>

## Friendly Tips

Congratulations on choosing to buy an iDea Pico projector. All products brought to you by iDeaPLAY are manufactured to the highest standards of performance and safety. As part of our philosophy of customer service and satisfaction, products are backed by our 1 Year Warranty. We hope you will enjoy using your purchase for many years to come.

## Customer Support

For any support or comments concerning our products, please send an email to: [Support@ideausa.com](mailto:Support@ideausa.com)  
Toll-Free NO: +1-866-886-6878

# 1 Introduction

## 1.1 Features

- **Home Entertainment**

Enjoy a home theater everywhere with the iDea Pico projector, the staggering immensity of the display screen and unrivaled picture clarity create a vivid environment.

- **Portable, Projector, Travelling-friendly**

Under 290g (12oz) and compact size that fits in the palm of your hand.

- **Remote Office**

The most cost-efficient high-resolution LED Projector with wireless connect function. Excellent display solution for showing PowerPoint, graphs, spreadsheets and general business data.

- **Wireless Display**

Miracast, Airplay Mirroring, and Wifi for sharing movies and ideas with ease.

## 1.2 What's in the Box

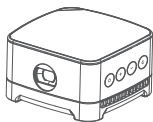

Projector

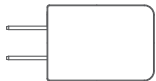

Adapter

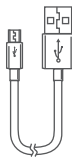

USB Cable

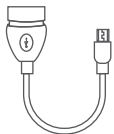

OTG Cable



Remote Control

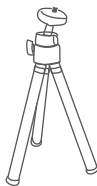

Tripod



Flannelette Bag



User Guide

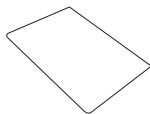

Warranty Card

## 1.3 Product Overview

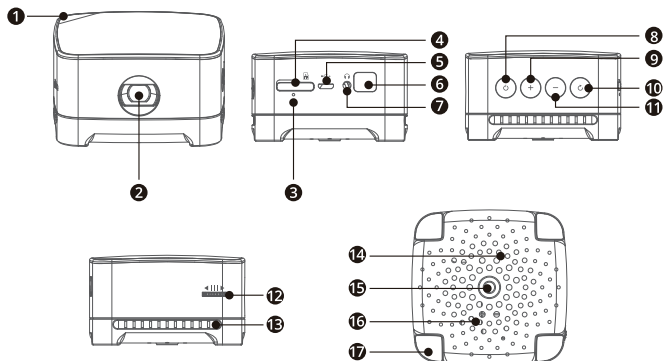

1. Battery Power Indicator

4. Micro SD Slot

7. Audio Out

10. Return Key

13. Air Outlet

16. Speaker

2. Lens

5. USB Charge Interface

8. Power Key

11. - Key

14. Air Inlet

17. Anti-slip Mat

3. Reset Key

6. IR Receiver

9. + Key

12. Focusing Gear

15. Tripod Mount

## 1.4 Infrared Remote Control

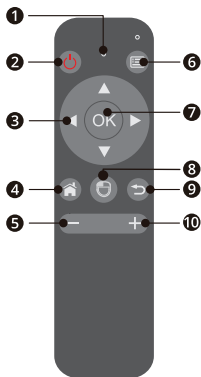

1. Indicator Light
2. Power Key
3. Navigation Keys
4. Homepage Key
5. - Volume Key
6. Menu Key
7. OK Key
8. Mouse
9. Return Key
10. + Volume Key

## 2. Getting started

### 2.1 Using the Remote Control

**Power Key:** Press and hold the power key for 3 seconds to turn on the projector, Press the power key for 3 seconds to turn off the projector.

**Menu Key:** Press the Menu key to open the menu options in supported apps and settings menus.

**Navigation Key:** The Navigation keys on the remote control let you select between the apps or menu options available.

**OK Key:** Press the OK key to select an option.

**Home Key:** Press the Home key to return to the Home Screen.

**Mouse Key:** Press the mouse key to enable the air mouse, a point will be displayed on the projected screen, by tilting the remote control you can move the mouse pointer. Press the mouse key when the pointer is over an option you want to select. Press the navigation key to turn off the air mouse.

**Return Key:** Press the return key to go to the previous page or menu.

**+ / - Key:** Use the + and – keys to adjust the volume.

## 2.2 Turning the Projector On/Off

### • Power On

Press and hold the power key on the projector for 3 seconds to power on the iDeaPlay P100B Pico Projector.

### • Power Off

Press and hold the power key on the projector for 3 seconds to power off the iDeaPlay P100B Pico Projector.

Alternatively, you can use the power key on the remote control to power on/off the iDeaPlay P100B Pico Projector.

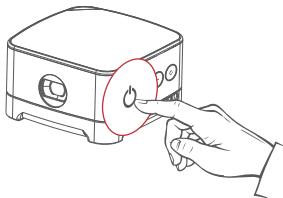

## 2.3 Adjusting the Focus

Rotate the manual focus gear (12) to adjust the focus of the projector.

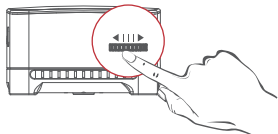



## 2.4 Charging the Projector

Plug the micro USB end of the USB cable into the micro USB port on the projector.

Plug the other end into the AC adapter; plug the AC adapter into an AC plug socket. When charging the Battery Power Indicator light will light up red.

When fully charged the light will turn blue.

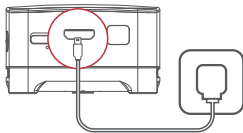

## 3. Home Screen Overview

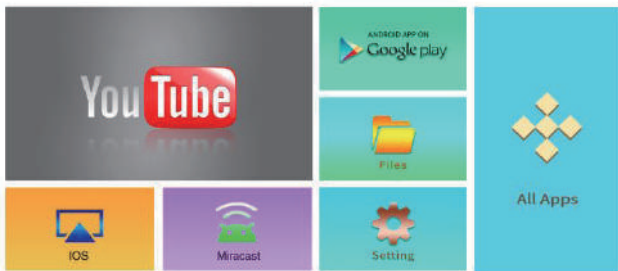

## 4 General Settings

### Language

Language settings can be adjusted from the general settings menu.

Use the navigation keys on the remote control to choose the language then confirm the choice by pressing the ok key on the remote.

**Home Screen > Settings > General Settings > Language**

### Date & Time

Date and Time can be set from the general settings menu.

Use the navigation keys on the remote control to choose the date and time settings then use the ok key to confirm.

**Home Screen > Settings > General Settings > Date & Time**

### Storage Management

The storage management option under the general settings lets you see the internal storage. **Home Screen > Settings > General Settings > Storage management**

### Application Management

You can access all the applications from the application management menu. Use the navigation keys on the remote control to choose the application then press the OK Key to launch the application.

**Home Screen > Settings > General Settings > Storage management**

### Online Upgrade

To check for a later version of the iDeaPlay projector's software open the online upgrade option from the general settings menu.

**Home Screen > Settings > General Settings > Online Upgrade**

### Factory Setting

To restore the iDeaPlay projector to the factory defaults open the Factory setting option from the general settings menu.

A pop up will ask you display. "Do you want to restore Factory Settings" Using the Navigation keys select Confirm and press ok to restore factory settings, To cancel the

option select cancel or press the return key to return to the general settings menu.

Home Screen > Settings > General Settings > Factory Setting

If the projector is turned on and will not respond you can press the Reset Key (3) for one second to perform a hard factory reset and restore the factory settings.

**Warning:**

If you restore the factory settings all data stored on the pico projector will be lost and the device will be returned to its factory default settings.

Be sure to back up any data needed before selecting this option.

## 4.1 Adjust the Brightness

The projector's brightness can be selected from the settings menu.

You can choose between Standard mode/Brightest mode.

Home Screen > Settings > Projector Settings > LED Brightness

## 4.2 Adjust Projection Mode

You can adjust the projection mode from the settings menu.

You can choose between the following projection modes: Standard Front Projection, Standard Rear Projection, Hoisting Front Projection, and Hoisting Rear Projection.

Home Screen > Settings > Projector Settings > Projection mode

## 4.3 Bluetooth Control Pairing

Bluetooth settings can be adjusted from the settings menu. You can pair the Bluetooth controller or other Bluetooth enabled devices.

Home Screen > Settings > Bluetooth Setting

To pair a device to the projector, select the "Scan For Devices" option and then select the device from the list Available Devices.

**Note:** If the remote controller can't be scanned press the "OK" key and "Volume -" key on the remote for 5 seconds to confirm the Bluetooth mode has been turned on then scan for devices on the projector.

## 4.4 Connecting to Wi-Fi

The iDeaPlay Pico projector has 2.4G and 5G Dual Band Wifi support.

To connect to a Wi-Fi network go to the Wi-Fi settings under the settings menu.

Ensure the Wi-Fi is turned on and then select the desired network from the available network list.

Follow the screen prompts to enter the Wi-Fi password and connect to the network.

Home Screen > Settings > Wi-Fi Setting



**Note:** After you enter the Wi-Fi password, click next on the on-screen keyboard to connect. Alternatively, click back on the remote control and then click the connect button on the screen.

## 4.5 Keystone Correction

The iDeaPlay P100B Pico Projector has manual Keystone correction. This can be adjusted from the settings menu. This lets you set the trapezoid correction.

You can adjust the coordinates of the four points (X,Y) of the rectangle through the navigation keys on the remote control.

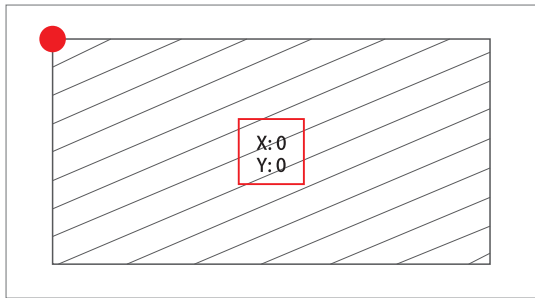

"OK" Check position; "UP / DOWN / LEFT / RIGHT" Adjust angle; "MENU" Reset status; Back Come back.

Use the Navigation keys on the remote control and follow the onscreen prompts to adjust or reset the keystone correction.

Home Screen > Settings > Keystone Correction

## 5. All Apps

To view all the **apps installed** on the iDeaPlay P100B Pico Projector projector open All Apps from the Home Screen.

The projector comes with Apotide TV app Store, Hulu, Netflix, and Amazon Prime Video apps pre-installed. These are listed in the All Apps folder accessible from the Home Screen.

**Note:** When using Netflix the navigation buttons on the remote control will not work. Please use the air mouse function on the remote control (see user manual 2.1) or connect a mouse via the USB OTG cable or with Bluetooth.

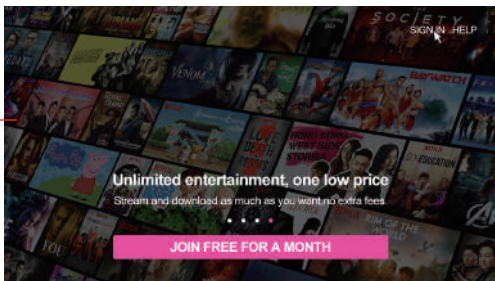
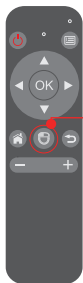

## 5.1 YouTube

The projector comes with the YouTube app pre-installed. You can open YouTube directly from the projector's home screen.

Home Screen > YouTube

## 6. Google Play

The iDeaPlay P100B Pico Projector comes with Google Play pre-installed, You can open this application from the home screen to download and install additional apps and software.

## 7. Files

You can use the Files option from the home screen to open the file manager where you can view and manage the files and apps on the projector, SD card, USB drive or local network connected to it.

## 8. Projection Sharing

Connecting your iDeaPlay P100B Pico Projector to another device.

## 8.1 Airplay – iPhone

### 1a. With Projector Connected to Wi-Fi

- Select the IOS screen sync option from the Home Screen.
- Select the iPhone option.
- Enter the iPhones Setting > Wi-Fi, then connect the iPhone to the same Wi-Fi network as the projector.

**Note:** on devices running iOS 11.0 or above the Airplay function is listed as Screen Mirroring.

### 1b. Without Projector connected to Wi-Fi, Using Mobile Hotspot

- Enter the iPhones Setting > Personal Hotspot > Open Hotspot
- Connect the projector to the hotspot.  
( See 4.4 Connecting to Wi-Fi)

2. From the Phone's settings click the Airplay option.

3. Choose “xxx-xxxxxx-xxx” then open “Mirroring”.

The projector will now be connected to the iPhone sharing the same screen display.

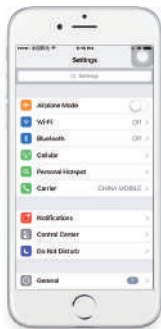

## 8.2 Airplay – Mac

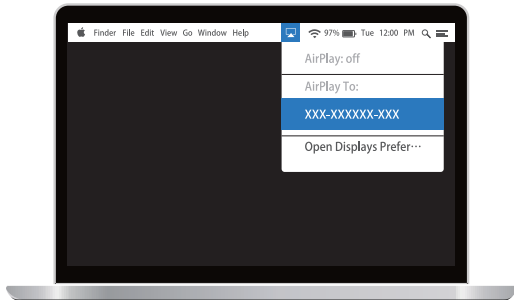

### 1a. With Projector Connected to Wi-Fi

On the Mac, click the Wi-Fi settings “”.

Connect the Mac to the same Wi-Fi network as the projector.

### 1b. Without Projector Connected to Wi-Fi

On the Mac, click the Wi-Fi settings “”. Choose “AndroidAP” and connect.

2. Click “”, choose “xxx-xxxxxx-xxx” and the projector will now be connected to the mac sharing the same screen display.

## 8.3 Miracast – Android device

**NOTE:** Ensure the Projector and your Android device are connected to the same Wi-Fi network.

1. Open the settings on your Android device. Click “more wireless settings”
2. Open “Cast Screen” Searching and connecting.
3. For some Android devices open the shortcuts menu,  
look for the “screen sharing/mirroring/screen projection display/ WLAN Display/ Wireless Display/ Multi-Screen/Smart View, search and connect to the device.  
If you can't find the miracast function please contact customer service.

## 8.4 Wired Connection U Disk/Micro SD Card

### 1a. How to read the U Disk

- Connect the USB OTG cable to the Micro USB interface of the Projector.
- Connect the U disk to the other end of the USB OTG interface.

### 1b. How to read the Micro SD Card

- Insert the micro SD card into the micro SD card reader on the Projector.

2. Click in the file option from the home screen. Navigate the data using the remote controller.



## 9. Specifications

Max Brightness	100 Lumen
Resolution	854x480
Display Ratio	16:9
Contrast	1000:1
Projection Distance	0.2 to 3 M
Throw Size	1M/37.8 Inch, 2M/75 Inch, 3M/110 Inch
Wi-Fi	IEEE 802.11a/b/g/n/ac, 2.4G / 5G Dual Band
Bluetooth	4.1
Battery	4200mAh Polymer Battery
Battery Life	130 Minutes
Micro SD Card	Supports up to 32GB Max
Power DC	5V 2A
Operating System	Android 7.1
Supported Wireless Protocols	Airplay / Miracast
Weight	290g (12oz)
Product Size	75x75x44mm ( 2.95x2.95x1.73inch)
Working Temperature	0°C to 30°C (32°F to 86°F)

## FCC Statement

This device complies with Part 15 of the FCC Rules. Operation is subject to the following two conditions: (1) this device may not cause harmful interference, and (2) this device must accept any interference received, including interference that may cause undesired operation.

**Warning:** changes or modifications to this unit not expressly approved by the party responsible for compliance could void the user's authority to operate the equipment.

**Note:** This equipment has been tested and found to comply with the limits for a Class B digital device, pursuant to Part 15 of the FCC Rules. These limits are designed to provide reasonable protection against harmful interference in a residential installation. This equipment generates, uses and can radiate radio frequency energy and, if not installed and used in accordance with the instructions, may cause harmful interference to radio communications.

However, there is no guarantee that interference will not occur in a particular installation. If this equipment does cause harmful interference to radio or television reception, which can be determined by turning the equipment off and on, the user is encouraged to try to correct the interference by one or more of the following measures:

Reorient or relocate the receiving antenna.

Increase the separation between the equipment and receiver.

Connect the equipment into an outlet on a circuit different from that to which the receiver is connected. Consult the dealer or an experienced radio/TV technician for help.

**This equipment complies with FCC radiation exposure limits set forth for an uncontrolled environment.**

**This equipment should be installed and operated with minimum distance 20cm between the radiator & your body**

**Pico Projector  
P100B**

[www.iDeaUSA.com](http://www.iDeaUSA.com)  
P100BI19UMEN-01