

TEST REPORT

Applicant/Manufacturer: INFINIX MOBILITY LIMITED
Address: FLAT N 16/F BLOCK B UNIVERSAL INDUSTRIAL CENTRE 19-25
SHAN MEI STREET FOTAN NT, Hong Kong
Report Number: SZ1231213-75213E-SA
FCC ID: 2AIZN-X6871

Test Standard (s)

FCC 47 CFR part 2.1093

Sample Description

Product Type: Mobile Phone
Model No.: X6871
Multiple Model(s) No.: N/A
Trade Mark: Infinix
Serial Number: 2F5K-1
Date Received: 2023/12/19
Date of Test: 2024/01/22~2024/03/13
Issue Date: 2024/03/15

Test Result:

Pass▲

▲ In the configuration tested, the EUT complied with the standards above.

Prepared and Checked By:

Sid Luo

Sid Luo
SAR Engineer

Approved By:

Luke Jiang

Luke Jiang
SAR Engineer

Note: The information marked "▲" is provided by the applicant, the laboratory is not responsible for its authenticity and this information can affect the validity of the result in the test report. Customer model name, addresses, names, trademarks etc. are included.

This report cannot be reproduced except in full, without prior written approval of the Company. Unless otherwise stated the results shown in this test report refer only to the sample(s) tested. This report is valid only with a valid digital signature. The digital signature may be available only under the Adobe software above version 7.0.

This report must not be used by the customer to claim product certification, approval, or endorsement by NVLAP or any agency of the U.S. Government.

This report may contain data that are not covered by the NVLAP accreditation and are marked with an asterisk "▲".

Bay Area Compliance Laboratories Corp. (Shenzhen)

5F(B-West), 6F, 7F, the 3rd Phase of Wan Li Industrial Building D, Shihua Rd, FuTian Free Trade Zone, Shenzhen, China
Tel: +86-755-33320018 Fax: +86-755-33320008 www.baclcorp.com.cn

Attestation of Test Results		
Frequency Band	Max. SAR Level(s) Reported(W/kg)	Limit(W/Kg)
GSM 850	0.13 W/kg 1g Head SAR 0.65 W/kg 1g Body SAR	1.6
PCS 1900	0.12 W/kg 1g Head SAR 0.65 W/kg 1g Body SAR	
WCDMA Band 2	0.16 W/kg 1g Head SAR 0.52 W/kg 1g Body SAR	
WCDMA Band 4	0.10 W/kg 1g Head SAR 0.68 W/kg 1g Body SAR	
WCDMA Band 5	0.26 W/kg 1g Head SAR 0.39 W/kg 1g Body SAR	
LTE Band 2	0.11 W/kg 1g Head SAR 0.58 W/kg 1g Body SAR	
LTE Band 5	0.28 W/kg 1g Head SAR 0.49 W/kg 1g Body SAR	
LTE Band 7	0.13 W/kg 1g Head SAR 0.53 W/kg 1g Body SAR	
LTE Band 12&17	0.11 W/kg 1g Head SAR 0.24 W/kg 1g Body SAR	
LTE Band 40	0.08 W/kg 1g Head SAR 0.38 W/kg 1g Body SAR	
LTE Band 41&38	0.13 W/kg 1g Head SAR 0.45 W/kg 1g Body SAR	
LTE Band 42	0.34 W/kg 1g Head SAR 0.09 W/kg 1g Body SAR	
LTE Band 66&4	0.17 W/kg 1g Head SAR 0.62 W/kg 1g Body SAR	
5G NR n5	0.13 W/kg 1g Head SAR 0.32 W/kg 1g Body SAR	
5G NR n7	0.11 W/kg 1g Head SAR 0.43 W/kg 1g Body SAR	
5G NR n12	0.09 W/kg 1g Head SAR 0.19 W/kg 1g Body SAR	
5G NR n38	0.08 W/kg 1g Head SAR 0.32 W/kg 1g Body SAR	
5G NR n40	0.09 W/kg 1g Head SAR 0.35 W/kg 1g Body SAR	
5G NR n41	0.13 W/kg 1g Head SAR 0.50 W/kg 1g Body SAR	
5G NR n66	0.04 W/kg 1g Head SAR 0.28 W/kg 1g Body SAR	
5G NR n77&78	0.73 W/kg 1g Head SAR 0.20 W/kg 1g Body SAR	

Attestation of Test Results		
Frequency Band	Max. SAR Level(s) Reported(W/kg)	Limit(W/Kg)
WLAN 2.4G	0.19 W/kg 1g Head SAR 0.06 W/kg 1g Body SAR	1.6
WLAN 5.2G	0.21 W/kg 1g Head SAR 0.14 W/kg 1g Body SAR	
WLAN 5.8G	0.24 W/kg 1g Head SAR 0.13 W/kg 1g Body SAR	
Simultaneous(tx)	1.43 W/kg 1g Head SAR 1.36 W/kg 1g Body SAR 1.36 W/kg 1g Hotspot SAR	
Applicable Standards	FCC 47 CFR part 2.1093 Radiofrequency radiation exposure evaluation: portable devices	
	RF Exposure Procedures: TCB Workshop April 2019	
	IEEE1528:2013 IEEE Recommended Practice for Determining the Peak Spatial-Average Specific Absorption Rate (SAR) in the Human Head from Wireless Communications Devices: Measurement Techniques	
	KDB procedures KDB 447498 D01 General RF Exposure Guidance v06 KDB 648474 D04 Handset SAR v01r03 KDB 865664 D01 SAR Measurement 100 MHz to 6 GHz v01r04 KDB 865664 D02 RF Exposure Reporting v01r02 KDB 941225 D01 3G SAR Procedures v03r01 KDB 941225 D05 SAR for LTE Devices v02r05 KDB 941225 D06 Hotspot Mode v02r01 KDB 248227 D01 802.11 Wi-Fi SAR v02r02	
<p>Note: This wireless device has been shown to be capable of compliance for localized specific absorption rate (SAR) for General Population/Uncontrolled Exposure limits specified in FCC 47 CFR part 2.1093 and has been tested in accordance with the measurement procedures specified in IEEE 1528-2013 and RF exposure KDB procedures.</p> <p>The results and statements contained in this report pertain only to the device(s) evaluated.</p>		

TABLE OF CONTENTS

DOCUMENT REVISION HISTORY..... 5

EUT DESCRIPTION 6
 TECHNICAL SPECIFICATION..... 7

REFERENCE, STANDARDS, AND GUIDELINES 8
 SAR LIMITS 8

FACILITIES 9

DESCRIPTION OF TEST SYSTEM..... 10

EQUIPMENT LIST AND CALIBRATION..... 17
 EQUIPMENT’S LIST & CALIBRATION INFORMATION 17

SAR MEASUREMENT SYSTEM VERIFICATION 18
 LIQUID VERIFICATION..... 18
 SYSTEM ACCURACY VERIFICATION 21
 SAR SYSTEM VALIDATION DATA 23

EUT TEST STRATEGY AND METHODOLOGY..... 40
 TEST POSITIONS FOR DEVICE OPERATING NEXT TO A PERSON’S EAR 40
 CHEEK/TOUCH POSITION 41
 EAR/TILT POSITION..... 41
 TEST POSITIONS FOR BODY-WORN AND OTHER CONFIGURATIONS 42
 TEST DISTANCE FOR SAR EVALUATION 42
 SAR EVALUATION PROCEDURE 43

CONDUCTED OUTPUT POWER MEASUREMENT 44
 TEST PROCEDURE..... 44
 DESCRIPTION OF TEST CONFIGURATION 45
 MAXIMUM TARGET OUTPUT POWER..... 52
 TEST RESULTS..... 55

STANDALONE SAR TEST EXCLUSION CONSIDERATIONS..... 89
 ANTENNAS LOCATION: 89
 ANTENNA DISTANCE TO EDGE (TRX) 90
 STANDALONE SAR TEST EXCLUSION CONSIDERATIONS 91
 NFC MEASUREMENT RESULT: 92
 STANDALONE SAR ESTIMATION: 92
 SAR TEST EXCLUSION FOR THE EUT EDGE CONSIDERATIONS RESULT..... 93

SAR MEASUREMENT RESULTS 94
 TEST RESULTS:..... 94

SAR MEASUREMENT VARIABILITY..... 128

SAR SIMULTANEOUS TRANSMISSION DESCRIPTION..... 129

SAR PLOTS 134

APPENDIX A MEASUREMENT UNCERTAINTY 135

APPENDIX B EUT TEST POSITION PHOTOS..... 136

APPENDIX C CALIBRATION CERTIFICATES..... 137

DOCUMENT REVISION HISTORY

Revision Number	Report Number	Description of Revision	Date of Revision
0	SZ1231213-75213E-SA	Original Report	2024/03/15

EUT DESCRIPTION

This report has been prepared on behalf of **INFINIX MOBILITY LIMITED** and their product **Mobile Phone**, Model: **X6871**, FCC ID: **2AIZN-X6871** or the EUT (Equipment under Test) as referred to in the rest of this report.

**All measurement and test data in this report was gathered from production sample serial number:2F5K-1(Assigned by BACL, Shenzhen).The EUT supplied by the applicant was received on 2023-12-19.*

Note:

1. This device supports 5G NR FR1 bands, including NSA mode and SA mode.
2. SAR test for NR bands and LTE anchor Bands were performed separately due to limitations in SAR probe calibration factors. And, due to test setup limitations, SAR testing for NR was performed using test mode software to establish the connection.
3. NSA and SA mode should perform SAR separately. Based on chip algorithms, for the maximum power of SA mode is the same as NSA total power level, so SA standalone total power level SAR can represent NSA mode SAR.
4. 5G NR SA mode, the power level is the more than as 5G NR NSA mode, so only 5G NR SA mode power table show in this report.
5. For 5G NR, the simultaneous transmission analysis is used standalone SAR at total power level to show compliance.
6. 5G NR supports CP-OFDM and DFT-s-OFDM modulation, for DFT-s-OFDM power is higher than CP-OFDM, so chose DFT-s-OFDM to perform SAR testing.

Technical Specification

Product Type:	Portable
Exposure Category:	Population / Uncontrolled
Antenna Type(s):	Internal Antenna
Body-Worn Accessories:	None
Proximity Sensor:	None
Carrier Aggregation:	None
Operation modes:	GSM Voice, GPRS/EDGE Data, WCDMA (R99 (Voice + Data), HSUPA/HSDPA/HSPA+), FDD-LTE, TDD-LTE, 5G NR, WLAN, Bluetooth, NFC
Frequency Band:	GSM 850: 824-849 MHz(TX); 869-894 MHz(RX) PCS 1900: 1850-1910 MHz(TX); 1930-1990 MHz(RX) WCDMA Band 2: 1850-1910 MHz(TX); 1930-1990 MHz(RX) WCDMA Band 4: 1710-1755MHz(TX) ; 2110-2155 MHz(RX) WCDMA Band 5: 824-849 MHz(TX); 869-894 MHz(RX) LTE Band 2: 1850-1910 MHz(TX); 1930-1990 MHz(RX) LTE Band 4: 1710-1755MHz(TX) ; 2110-2155 MHz(RX) LTE Band 5: 824-849 MHz(TX); 869-894 MHz(RX) LTE Band 7: 2500-2570 MHz(TX); 2620-2690 MHz(RX) LTE Band 12: 699-716 MHz(TX); 729-746 MHz(RX) LTE Band 17: 704-716 MHz(TX); 734-746 MHz(RX) LTE Band 38: 2570-2620 MHz(TX/RX) LTE Band 40: 2305-2315 MHz(TX); 2305-2315 MHz(RX) 2350-2360 MHz(TX); 2350-2360 MHz(RX) LTE Band 41: 2496-2690 MHz(TX/RX) LTE Band 42: 3450-3550 MHz(TX/RX) LTE Band 66: 1710-1780 MHz(TX) ; 2110-2180 MHz(RX) 5G NR n5: 824-849 MHz(TX); 869-894 MHz(RX) 5G NR n7: 2500-2570 MHz(TX); 2620-2690 MHz(RX) 5G NR n12: 699-716 MHz(TX); 729-746 MHz(RX) 5G NR n38: 2570-2620 MHz(TX/RX) 5G NR n40: 2305-2315 MHz(TX); 2305-2315 MHz(RX) 2350-2360 MHz(TX); 2350-2360 MHz(RX) 5G NR n41: 2496-2690 MHz(TX/RX) 5G NR n66: 1710-1780 MHz(TX) ; 2110-2180 MHz(RX) 5G NR n77: 3450-3550 MHz(TX/RX) 3700-3980 MHz(TX/RX) 5G NR n78: 3450-3550 MHz(TX/RX) 3700-3800 MHz(TX/RX) WLAN 2.4G: 2412-2462 MHz/2422MHz-2452 MHz(TX/RX) WLAN 5.2G: 5150 -5250 MHz(TX/RX) WLAN 5.8G: 5725-5850 MHz(TX/RX) Bluetooth: 2402-2480MHz(TX/RX) NFC: 13.56 MHz(TX/RX)
Dimensions (L*W*H):	164*74.5*7.6mm
Rated Input Voltage:	DC3.91V from Rechargeable Battery
Normal Operation:	Head and Body Worn

REFERENCE, STANDARDS, AND GUIDELINES

FCC:

The Report and Order requires routine SAR evaluation prior to equipment authorization of portable transmitter devices, including portable telephones. For consumer products, the applicable limit is 1.6 mW/g as recommended by the ANSI/IEEE standard C95.1-1992 [6] for an uncontrolled environment (Paragraph 65). According to the Supplement C of OET Bulletin 65 "Evaluating Compliance with FCC Guide-lines for Human Exposure to Radio frequency Electromagnetic Fields", released on Jun 29, 2001 by the FCC, the device should be evaluated at maximum output power (radiated from the antenna) under "worst-case" conditions for normal or intended use, incorporating normal antenna operating positions, device peak performance frequencies and positions for maximum RF energy coupling.

This report describes the methodology and results of experiments performed on wireless data terminal. The objective was to determine if there is RF radiation and if radiation is found, what is the extent of radiation with respect to safety limits. SAR (Specific Absorption Rate) is the measure of RF exposure determined by the amount of RF energy absorbed by human body (or its parts) – to determine how the RF energy couples to the body or head which is a primary health concern for body worn devices. The limit below which the exposure to RF is considered safe by regulatory bodies in North America is 1.6 mW/g average over 1 gram of tissue mass.

SAR Limits

FCC Limit(1g Tissue)

EXPOSURE LIMITS	SAR (W/kg)	
	(General Population / Uncontrolled Exposure Environment)	(Occupational / Controlled Exposure Environment)
Spatial Average (averaged over the whole body)	0.08	0.4
Spatial Peak (averaged over any 1 g of tissue)	1.6	8.0
Spatial Peak (hands/wrists/feet/ankles averaged over 10 g)	4.0	20.0

Population/Uncontrolled Environments are defined as locations where there is the exposure of individual who have no knowledge or control of their exposure.

Occupational/Controlled Environments are defined as locations where there is exposure that maybe incurred by people who are aware of the potential for exposure (i.e. as a result of employment or occupation).

General Population/Uncontrolled environments Spatial Peak limit 1.6W/kg for 1g SAR applied to the EUT.

FACILITIES

The test site used by Bay Area Compliance Laboratories Corp. (Shenzhen) to collect data is located at 5F(B-West) ,6F,7F,the 3rd Phase of Wan Li Industrial Building D,Shihua Rd, FuTian Free Trade Zone, Shenzhen, China

The lab has been recognized as the FCC accredited lab under the KDB 974614 D01 and is listed in the FCC Public Access Link (PAL) database, FCC Registration No.: 715558, the FCC Designation No.: CN5045.

Each test item follows test standards and with no deviation.

DESCRIPTION OF TEST SYSTEM

These measurements were performed with the automated near-field scanning system DASY6 from Schmid & Partner Engineering AG (SPEAG) which is the Fifth generation of the system shown in the figure hereinafter:

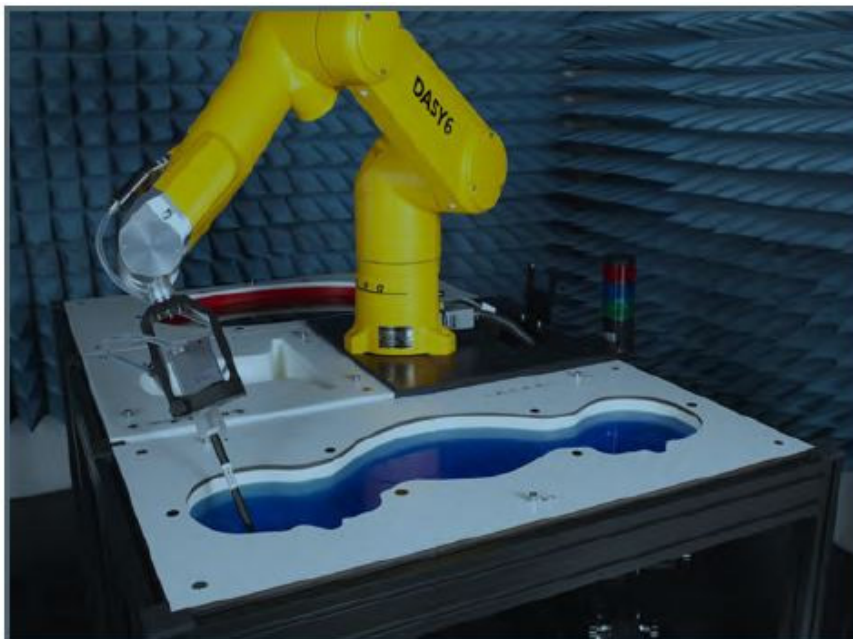

DASY6 System Description

The DASY6 system for performing compliance tests consists of the following items:

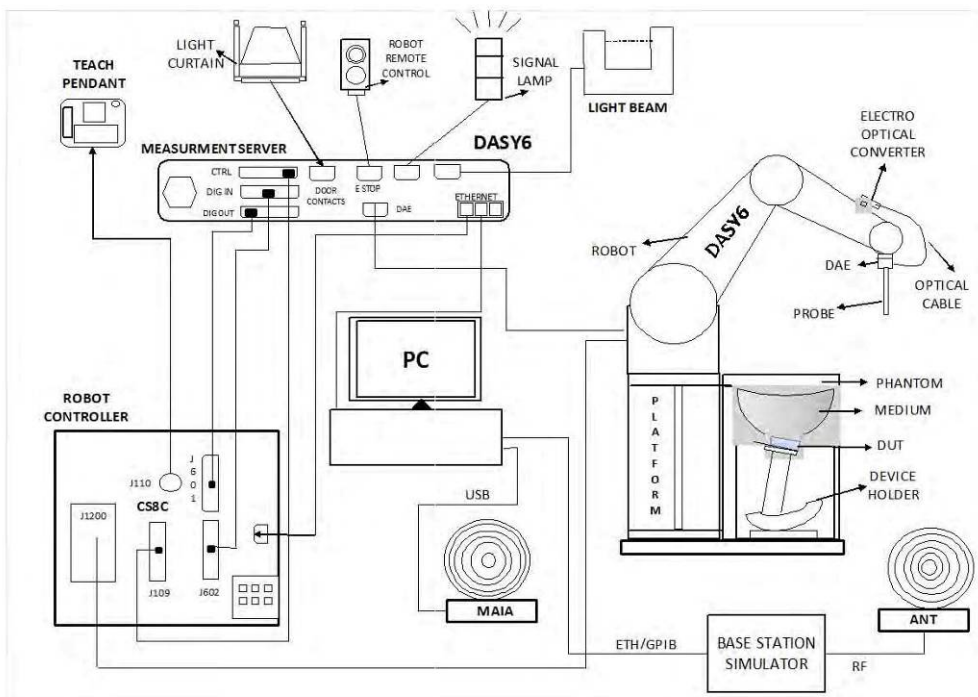

- A standard high precision 6-axis robot (Staubli TX=RX family) with controller, teach pendant and software. An arm extension for accommodating the data acquisition electronics (DAE).
- An isotropic field probe optimized and calibrated for the targeted measurement.
- A data acquisition electronics (DAE) which performs the signal application, signal multiplexing, AD-conversion, offset measurements, mechanical surface detection, collision detection, etc. The unit is battery powered with standard or rechargeable batteries. The signal is optically transmitted to the EOC.
- The Electro-optical converter (EOC) performs the conversion from optical to electrical signals for the digital communication to the DAE. To use optical surface detection, a special version of the EOC is required. The EOC signal is transmitted to the measurement server.
- The function of the measurement server is to perform the time critical tasks such as signal filtering, control of the robot operation and fast movement interrupts.
- The Light Beam used is for probe alignment. This improves the (absolute) accuracy of the probe positioning.
- A computer running Win7 professional operating system and the DASY52 software.
- Remote control and teach pendant as well as additional circuitry for robot safety such as warning lamps, etc.
- The phantom, the device holder and other accessories according to the targeted measurement.

DASY6 Measurement Server

The DASY6 measurement server is based on a PC/104 CPU board with a 400 MHz Intel ULV Celeron, 128 MB chip-disk and 128 MB RAM. The necessary circuits for communication with the DAE4 (or DAE3) electronics box, as well as the 16-bit AD converter system for optical detection and digital I/O interface are contained on the DASY6 I/O board, which is directly connected to the PC/104 bus of the CPU board.



The measurement server performs all real-time data evaluations of field measurements and surface detection, controls robot movements, and handles safety operations. The PC operating system cannot interfere with these time-critical processes. All connections are supervised by a watchdog, and disconnection of any of the cables to the measurement server will automatically disarm the robot and disable all program- controlled robot movements. Furthermore, the measurement server is equipped with an expansion port, which is reserved for future applications. Please note that this expansion port does not have a standardized pinout, and therefore only devices provided by SPEAG can be connected. Connection of devices from any other supplier could seriously damage the measurement server.

Data Acquisition Electronics

The data acquisition electronics (DAE4) consist of a highly sensitive electrometer-grade preamplifier with auto-zeroing, a channel and gain-switching multiplexer, a fast 16 bit AD-converter and a command decoder with a control logic unit. Transmission to the measurement server is accomplished through an optical downlink for data and status information, as well as an optical uplink for commands and the clock.

The mechanical probe mounting device includes two different sensor systems for frontal and sideways probe contacts. They are used for mechanical surface detection and probe collision detection.

The input impedance of both the DAE4 as well as of the DAE3 box is 200M Ω ; the inputs are symmetrical and floating. Common mode rejection is above 80 dB.

EX3DV4 E-Field Probes

Frequency	4 MHz to >10 GHz Linearity: ± 0.2 dB (30 MHz to 10 GHz)
Directivity	± 0.1 dB in TSL (rotation around probe axis) ± 0.3 dB in TSL (rotation normal to probe axis)
Dynamic Range	10 µW/g to > 100 mW/g Linearity: ± 0.2 dB (noise: typically < 1 µW/g)
Dimensions	Overall length: 337 mm (Tip: 20 mm) Tip diameter: 2.5 mm (Body: 12 mm) Typical distance from probe tip to dipole centers: 1 mm
Application	High precision dosimetric measurements in any exposure scenario (e.g., very strong gradient fields); the only probe that enables compliance testing for frequencies up to 6 GHz with precision of better 30%.
Compatibility	DASY3, DASY4, DASY52 SAR and higher, EASY6, EASY4/MRI

SAM Twin Phantom

The SAM Twin Phantom (shown in front of DASY6) is a fiberglass shell phantom with shell thickness 2 mm, except in the ear region where the thickness is increased to 6 mm. The phantom has three measurement areas: 1) Left Head, 2) Right Head, and 3) Flat Section. For larger devices, the use of the ELI-Phantom (shown behind DASY6) is required. For devices such as glasses with a wireless link, the Face Down Phantom is the most suitable (between the SAM Twin and ELI phantoms).

When the phantom is mounted inside allocated slot of the DASY6 platform, phantom reference points can be taught directly in the DASY5 V5.2 software. When the DASY6 platform is used to mount the

Phantom, some of the phantom teaching points cannot be reached by the robot in DASY5 V5.2. A special tool called P1a-P2aX-Former is provided to transform two of the three points, P1 and P2, to reachable locations. To use these new teaching points, a revised phantom configuration file is required.

In addition to our standard broadband liquids, the phantom can be used with the following tissue simulating liquids:

Sugar-water-based liquids can be left permanently in the phantom. Always cover the liquid when the system is not in use to prevent changes in liquid parameters due to water evaporation.

DGBE-based liquids should be used with care. As DGBE is a softener for most plastics, the liquid should be taken out of the phantom, and the phantom should be dried when the system is not in use (desirable at least once a week).

Do not use other organic solvents without previously testing the solvent resistivity of the phantom. Approximately 25 liters of liquid is required to fill the SAM Twin phantom.

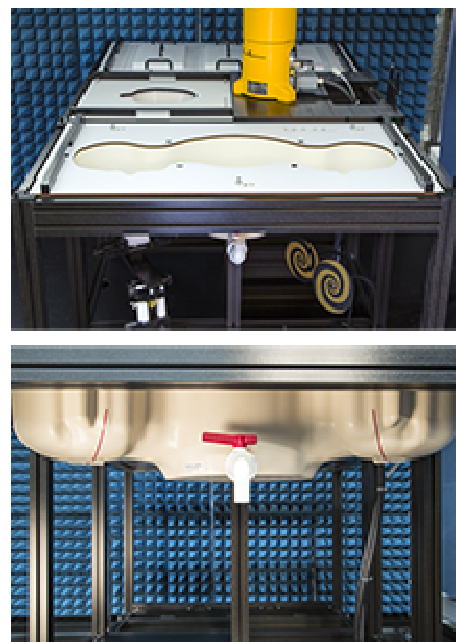

ELI Phantom

The ELI phantom is intended for compliance testing of handheld and body-mounted wireless devices in the frequency range of 300MHz to 6 GHz. ELI is fully compatible with the latest draft of the standard IEEE1528 and the use of all known tissue simulating liquids. ELI has been optimized for performance and can be integrated into a SPEAG standard phantom table. A cover is provided to prevent evaporation of water and changes in liquid parameters. Reference markings on the phantom allow installation of the complete setup, including all predefined phantom positions and measurement grids, by teaching three points.

The phantom can be used with the following tissue simulating liquids:

- Sugar-water-based liquids can be left permanently in the phantom. Always cover the liquid when the system is not in use to prevent changes in liquid parameters due to water evaporation.
- DGBE-based liquids should be used with care. As DGBE is a softener for most plastics, the liquid should be taken out of the phantom, and the phantom should be dried when the system is not in use (desirable at least once a week).
- Do not use other organic solvents without previously testing the solvent resistivity of the phantom.

Approximately 25 liters of liquid is required to fill the ELI phantom.

Robots

The DASY6 system uses the high-precision industrial robots TX60L, TX90XL, and RX160L from Staubli SA (France). The TX robot family - the successor of the well-known RX robot family - continues to offer the features important for DASY6 applications:

- High precision (repeatability 0.02mm)
- High reliability (industrial design)
- Low maintenance costs (virtually maintenance free due to direct drive gears; no belt drives)
- Jerk-free straight movements (brushless synchrony motors; no stepper motors)
- Low ELF interference (motor control fields shielded via the closed metallic construction shields)

The robots are controlled by the Staubli CS8c robot controllers. All information regarding the use and maintenance of the robot arm and the robot controller is provided

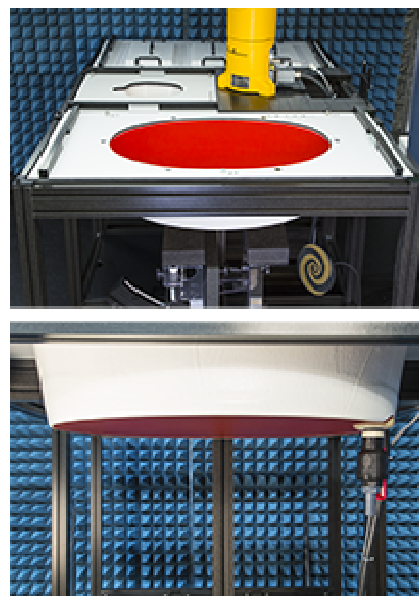

Calibration Frequency Points for EX3DV4 E-Field Probes SN: 7382 Calibrated: 2023/09/27

Calibration Frequency Point(MHz)	Frequency Range(MHz)		Conversion Factor		
	From	To	X	Y	Z
750 Head	650	850	10.65	10.65	10.65
900 Head	850	1000	10.19	10.19	10.19
1750 Head	1650	1850	8.60	8.60	8.60
1900 Head	1850	2000	8.30	8.30	8.30
2300 Head	2200	2400	8.16	8.16	8.16
2450 Head	2400	2550	7.89	7.89	7.89
2600 Head	2550	2700	7.65	7.65	7.65
3300 Head	3200	3400	7.39	7.39	7.39
3500 Head	3400	3600	7.24	7.24	7.24
3700 Head	3600	3800	7.10	7.10	7.10
3900 Head	3800	4000	6.98	6.98	6.98
5250 Head	5140	5360	5.62	5.62	5.62
5500 Head	5390	5610	5.10	5.10	5.10
5750 Head	5640	5860	5.08	5.08	5.08

SAR Scan Procedures

Step 1: Power Reference Measurement

The Power Reference Measurement and Power Drift Measurements are for monitoring the power drift of the device under test in the batch process. The minimum distance of probe sensors to surface determines the closest measurement point to phantom surface. The minimum distance of probe sensors to surface is 1.4 mm. This distance cannot be smaller than the distance of sensor calibration points to probe tip as defined in the probe properties.

Step 2: Area Scans

Area scans are defined prior to the measurement process being executed with a user defined variable spacing between each measurement point (integral) allowing low uncertainty measurements to be conducted. Scans defined for FCC applications utilize a 15mm² step integral, with 1.5mm interpolation used to locate the peak SAR area used for zoom scan assessments.

Where the system identifies multiple SAR peaks (which are within 25% of peak value) the system will provide the user with the option of assessing each peak location individually for zoom scan averaging.

Area Scan Parameters extracted from KDB 865664 D01 SAR Measurement 100 MHz to 6 GHz

	≤ 3 GHz	> 3 GHz
Maximum distance from closest measurement point (geometric center of probe sensors) to phantom surface	5 mm ± 1 mm	½·δ·ln(2) mm ± 0.5 mm
Maximum probe angle from probe axis to phantom surface normal at the measurement location	30° ± 1°	20° ± 1°
Maximum area scan spatial resolution: Δx _{Area} , Δy _{Area}	≤ 2 GHz: ≤ 15 mm 2 – 3 GHz: ≤ 12 mm	3 – 4 GHz: ≤ 12 mm 4 – 6 GHz: ≤ 10 mm
	When the x or y dimension of the test device, in the measurement plane orientation, is smaller than the above, the measurement resolution must be ≤ the corresponding x or y dimension of the test device with at least one measurement point on the test device.	

Step 3: Zoom Scan (Cube Scan Averaging)

The averaging zoom scan volume utilized in the DASY5 software is in the shape of a cube and the side dimension of a 1 g or 10 g mass is dependent on the density of the liquid representing the simulated tissue. A density of 1000 kg/m³ is used to represent the head and body tissue density and not the phantom liquid density, in order to be consistent with the definition of the liquid dielectric properties, i.e. the side length of the 1g cube is 5mm,with the side length of the 10g cube is 21.5mm.

Zoom Scan Parameters extracted from KDB 865664 D01 SAR Measurement 100 MHz to 6 GHz

Maximum zoom scan spatial resolution: $\Delta x_{Zoom}, \Delta y_{Zoom}$		≤ 2 GHz: ≤ 8 mm 2 – 3 GHz: ≤ 5 mm*	3 – 4 GHz: ≤ 5 mm* 4 – 6 GHz: ≤ 4 mm*
Maximum zoom scan spatial resolution, normal to phantom surface	uniform grid: $\Delta z_{Zoom}(n)$	≤ 5 mm	3 – 4 GHz: ≤ 4 mm 4 – 5 GHz: ≤ 3 mm 5 – 6 GHz: ≤ 2 mm
	graded grid	$\Delta z_{Zoom}(1)$: between 1 st two points closest to phantom surface	≤ 4 mm
		$\Delta z_{Zoom}(n>1)$: between subsequent points	$\leq 1.5 \cdot \Delta z_{Zoom}(n-1)$ mm
Minimum zoom scan volume	x, y, z	≥ 30 mm	3 – 4 GHz: ≥ 28 mm 4 – 5 GHz: ≥ 25 mm 5 – 6 GHz: ≥ 22 mm
<p>Note: δ is the penetration depth of a plane-wave at normal incidence to the tissue medium; see IEEE Std 1528-2013 for details.</p> <p>* When zoom scan is required and the <i>reported</i> SAR from the <i>area scan based 1-g SAR estimation</i> procedures of KDB Publication 447498 is ≤ 1.4 W/kg, ≤ 8 mm, ≤ 7 mm and ≤ 5 mm zoom scan resolution may be applied, respectively, for 2 GHz to 3 GHz, 3 GHz to 4 GHz and 4 GHz to 6 GHz.</p>			

Step 4: Power Drift Measurement

The Power Drift Measurement measures the field at the same location as the most recent power reference measurement within the same procedure, and with the same settings. The Power Drift Measurement gives the field difference in dB from the reading conducted within the last Power Reference Measurement. This allows a user to monitor the power drift of the device under test within a batch process. The measurement procedure is the same as Step 1.

When the cube intersects with the surface of the phantom, it is oriented so that 3 vertices touch the surface of the shell or the center of a face is tangent to the surface. The face of the cube closest to the surface is modified in order to conform to the tangent surface.

The zoom scan integer steps can be user defined so as to reduce uncertainty, but normal practice for typical test applications (including FCC) utilize a physical step of 7 x7 x 7 (5mmx5mmx5mm) providing a volume of 30 mm in the X & Y & Z axis.

Tissue Dielectric Parameters for Head and Body Phantoms

The head tissue dielectric parameters recommended by the IEEE1528:2013

Recommended Tissue Dielectric Parameters for Head liquid

Table A.3 – Dielectric properties of the head tissue-equivalent liquid

Frequency MHz	Relative permittivity ϵ_r	Conductivity (σ) S/m
300	45,3	0,87
450	43,5	0,87
<i>750</i>	<i>41,9</i>	<i>0,89</i>
835	41,5	0,90
900	41,5	0,97
1 450	40,5	1,20
<i>1 500</i>	<i>40,4</i>	<i>1,23</i>
<i>1 640</i>	<i>40,2</i>	<i>1,31</i>
<i>1 750</i>	<i>40,1</i>	<i>1,37</i>
1 800	40,0	1,40
1 900	40,0	1,40
2 000	40,0	1,40
<i>2 100</i>	<i>39,8</i>	<i>1,49</i>
<i>2 300</i>	<i>39,5</i>	<i>1,67</i>
2 450	39,2	1,80
<i>2 600</i>	<i>39,0</i>	<i>1,96</i>
3 000	38,5	2,40
<i>3 500</i>	<i>37,9</i>	<i>2,91</i>
<i>4 000</i>	<i>37,4</i>	<i>3,43</i>
<i>4 500</i>	<i>36,8</i>	<i>3,94</i>
<i>5 000</i>	<i>36,2</i>	<i>4,45</i>
<i>5 200</i>	<i>36,0</i>	<i>4,66</i>
<i>5 400</i>	<i>35,8</i>	<i>4,86</i>
<i>5 600</i>	<i>35,5</i>	<i>5,07</i>
<i>5 800</i>	<i>35,3</i>	<i>5,27</i>
<i>6 000</i>	<i>35,1</i>	<i>5,48</i>

NOTE For convenience, permittivity and conductivity values at those frequencies which are not part of the original data provided by Drossos et al. [33] or the extension to 5 800 MHz are provided (i.e. the values shown *in italics*). These values were linearly interpolated between the values in this table that are immediately above and below these values, except the values at 6 000 MHz that were linearly extrapolated from the values at 3 000 MHz and 5 800 MHz.

EQUIPMENT LIST AND CALIBRATION

Equipment's List & Calibration Information

Equipment	Model	S/N	Calibration Date	Calibration Due Date
DASY5 Test Software	DASY52 52.10.2	N/A	NCR	NCR
DASY6 Measurement Server	DASY6 6.0.31	N/A	NCR	NCR
Data Acquisition Electronics	DAE4	1325	2023/09/27	2024/09/26
E-Field Probe	EX3DV4	7382	2023/09/27	2024/09/26
Mounting Device	MD4HHTV5	SD 000 H01 KA	NCR	NCR
SAM Twin Phantom	SAM-Twin V8.0	1962	NCR	NCR
Dipole, 750MHz	D750V3	1229	2023/03/24	2026/03/23
Dipole, 1750MHz	D1750V2	1199	2023/03/27	2026/03/26
Dipole, 1900MHz	D1900V2	5d231	2023/02/17	2026/02/16
Dipole, 2300MHz	D2300V2	1136	2023/03/27	2026/03/26
Dipole, 2450MHz	D2450V2	1103	2023/03/27	2026/03/26
Dipole, 2600MHz	D2600V2	1207	2023/03/27	2026/03/26
Dipole, 3500MHz	D3500V2	1113	2023/10/18	2026/10/17
Dipole, 3900MHz	D3900V2	1058	2023/09/26	2026/09/25
Dipole,5GHz	D5GHzV2	1374	2023/03/27	2026/03/26
Simulated Tissue Liquid Head	HBBL600-10000V6	2200808-2	Each Time	/
Network Analyzer	E5071C	SER MY46519680	2023/06/08	2024/06/07
Dielectric Assessment Kit	DAK-3.5	1248	NCR	NCR
MXG Analog Signal Generator	N5181A	MY48180408	2024/01/16	2025/01/15
USB wideband power sensor	U2021XA	MY52350001	2023/06/08	2024/06/07
Directional Coupler	855673	3307	NCR	NCR
20dB Attenuator	2	BH9879	NCR	NCR
RF Power Amplifier	5205FE	1014	NCR	NCR
Amplifier	ZVE-8G+	558401902	NCR	NCR
Radio Communication Test Station	MT8000A	6262309799	2023/04/15	2024/04/14
Wideband Radio Communication Tester	CMW500	146520	2023/06/08	2024/06/07
Temperature & Humidity Meter	DTM3000	N/A	2024/01/16	2025/01/15

NCR: No Calibration Required.

SAR MEASUREMENT SYSTEM VERIFICATION

Liquid Verification

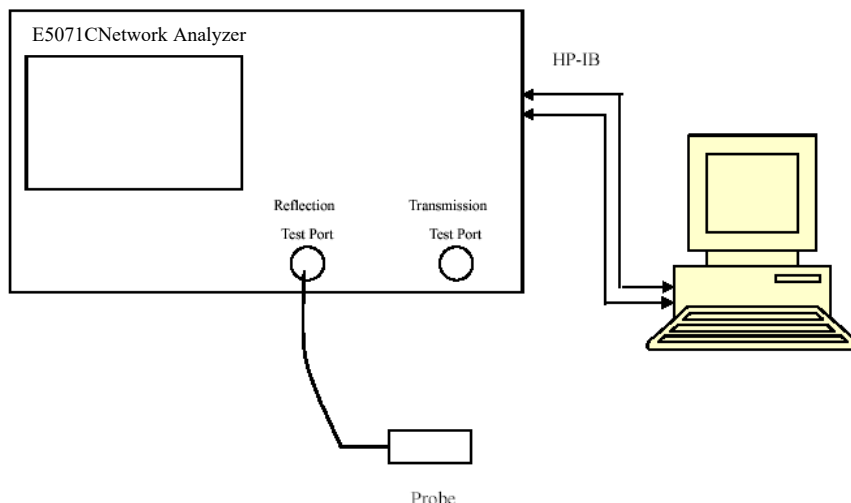

Liquid Verification Setup Block Diagram

Liquid Verification Results

Frequency (MHz)	Liquid Type	Liquid Parameter		Target Value		Delta (%)		Tolerance (%)
		ϵ_r	σ (S/m)	ϵ_r	σ (S/m)	$\Delta\epsilon_r$	$\Delta\sigma$ (S/m)	
707.5	Simulated Tissue Liquid Head	40.821	0.913	42.13	0.89	-3.11	2.58	± 5
750	Simulated Tissue Liquid Head	40.653	0.924	41.90	0.89	-2.98	3.82	± 5
836.6	Simulated Tissue Liquid Head	40.311	0.947	41.54	0.91	-2.96	4.07	± 5

*Liquid Verification above was performed on 2024/01/22.

Frequency (MHz)	Liquid Type	Liquid Parameter		Target Value		Delta (%)		Tolerance (%)
		ϵ_r	σ (S/m)	ϵ_r	σ (S/m)	$\Delta\epsilon_r$	$\Delta\sigma$ (S/m)	
750	Simulated Tissue Liquid Head	41.964	0.892	41.90	0.89	0.15	0.22	± 5
836.5	Simulated Tissue Liquid Head	41.465	0.913	41.54	0.91	-0.18	0.33	± 5
836.6	Simulated Tissue Liquid Head	41.465	0.913	41.54	0.91	-0.18	0.33	± 5

*Liquid Verification above was performed on 2024/01/23.

Frequency (MHz)	Liquid Type	Liquid Parameter		Target Value		Delta (%)		Tolerance (%)
		ϵ_r	σ (S/m)	ϵ_r	σ (S/m)	$\Delta\epsilon_r$	$\Delta\sigma$ (S/m)	
1732.6	Simulated Tissue Liquid Head	38.831	1.359	40.12	1.36	-3.21	-0.07	± 5
1745	Simulated Tissue Liquid Head	38.830	1.362	40.11	1.37	-3.19	-0.58	± 5
1750	Simulated Tissue Liquid Head	38.829	1.364	40.10	1.37	-3.17	-0.44	± 5

*Liquid Verification above was performed on 2024/01/24.

Frequency (MHz)	Liquid Type	Liquid Parameter		Target Value		Delta (%)		Tolerance (%)
		ϵ_r	σ (S/m)	ϵ_r	σ (S/m)	$\Delta\epsilon_r$	$\Delta\sigma$ (S/m)	
1880	Simulated Tissue Liquid Head	39.860	1.357	40.00	1.40	-0.35	-3.07	± 5
1900	Simulated Tissue Liquid Head	39.642	1.357	40.00	1.40	-0.89	-3.07	± 5

*Liquid Verification above was performed on 2024/01/25.

Frequency (MHz)	Liquid Type	Liquid Parameter		Target Value		Delta (%)		Tolerance (%)
		ϵ_r	σ (S/m)	ϵ_r	σ (S/m)	$\Delta\epsilon_r$	$\Delta\sigma$ (S/m)	
2300	Simulated Tissue Liquid Head	38.898	1.661	39.50	1.67	-1.52	-0.54	± 5
2310	Simulated Tissue Liquid Head	38.856	1.668	39.48	1.68	-1.58	-0.71	± 5
2437	Simulated Tissue Liquid Head	38.423	1.798	39.23	1.79	-2.06	0.45	± 5
2450	Simulated Tissue Liquid Head	38.406	1.816	39.20	1.80	-2.03	0.89	± 5

*Liquid Verification above was performed on 2024/03/09.

Frequency (MHz)	Liquid Type	Liquid Parameter		Target Value		Delta (%)		Tolerance (%)
		ϵ_r	σ (S/m)	ϵ_r	σ (S/m)	$\Delta\epsilon_r$	$\Delta\sigma$ (S/m)	
2300	Simulated Tissue Liquid Head	38.180	1.719	39.50	1.67	-3.34	2.93	± 5
2355	Simulated Tissue Liquid Head	38.023	1.774	39.39	1.72	-3.47	3.14	± 5
2437	Simulated Tissue Liquid Head	38.436	1.773	39.23	1.79	-2.02	-0.95	± 5
2450	Simulated Tissue Liquid Head	38.406	1.788	39.20	1.80	-2.03	-0.67	± 5

*Liquid Verification above was performed on 2024/03/10.

Frequency (MHz)	Liquid Type	Liquid Parameter		Target Value		Delta (%)		Tolerance (%)
		ϵ_r	σ (S/m)	ϵ_r	σ (S/m)	$\Delta\epsilon_r$	$\Delta\sigma$ (S/m)	
2450	Simulated Tissue Liquid Head	40.230	1.802	39.20	1.80	2.63	0.11	±5
2535	Simulated Tissue Liquid Head	39.352	1.916	39.09	1.89	0.67	1.38	±5
5200	Simulated Tissue Liquid Head	36.017	4.605	36.00	4.66	0.05	-1.18	±5
5250	Simulated Tissue Liquid Head	35.923	4.622	35.95	4.71	-0.08	-1.87	±5

*Liquid Verification above was performed on 2024/03/12.

Frequency (MHz)	Liquid Type	Liquid Parameter		Target Value		Delta (%)		Tolerance (%)
		ϵ_r	σ (S/m)	ϵ_r	σ (S/m)	$\Delta\epsilon_r$	$\Delta\sigma$ (S/m)	
2593	Simulated Tissue Liquid Head	37.526	1.983	39.01	1.95	-3.80	1.69	±5
2600	Simulated Tissue Liquid Head	37.514	1.988	39.00	1.96	-3.81	1.43	±5
5200	Simulated Tissue Liquid Head	35.251	4.786	36.00	4.66	-2.08	2.70	±5
5250	Simulated Tissue Liquid Head	35.235	4.813	35.95	4.71	-1.99	2.19	±5

*Liquid Verification above was performed on 2024/03/13.

Frequency (MHz)	Liquid Type	Liquid Parameter		Target Value		Delta (%)		Tolerance (%)
		ϵ_r	σ (S/m)	ϵ_r	σ (S/m)	$\Delta\epsilon_r$	$\Delta\sigma$ (S/m)	
3500	Simulated Tissue Liquid Head	36.558	2.913	37.90	2.91	-3.54	0.10	±5
5785	Simulated Tissue Liquid Head	34.054	5.303	35.32	5.26	-3.58	0.82	±5
5800	Simulated Tissue Liquid Head	34.050	5.305	35.30	5.27	-3.54	0.66	±5

*Liquid Verification above was performed on 2024/03/04.

Frequency (MHz)	Liquid Type	Liquid Parameter		Target Value		Delta (%)		Tolerance (%)
		ϵ_r	σ (S/m)	ϵ_r	σ (S/m)	$\Delta\epsilon_r$	$\Delta\sigma$ (S/m)	
2595	Simulated Tissue Liquid Head	37.963	1.944	39.01	1.95	-2.68	-0.31	±5
2600	Simulated Tissue Liquid Head	37.945	1.947	39.00	1.96	-2.71	-0.66	±5
3840	Simulated Tissue Liquid Head	37.077	3.178	37.56	3.27	-1.29	-2.81	±5
3900	Simulated Tissue Liquid Head	36.986	3.253	37.50	3.33	-1.37	-2.31	±5
5775	Simulated Tissue Liquid Head	35.069	5.154	35.33	5.25	-0.74	-1.83	±5
5800	Simulated Tissue Liquid Head	35.034	5.160	35.30	5.27	-0.75	-2.09	±5

*Liquid Verification above was performed on 2024/03/08.

System Accuracy Verification

Prior to the assessment, the system validation kit was used to test whether the system was operating within its specifications of $\pm 10\%$. The validation results are tabulated below. And also the corresponding SAR plot is attached as well in the SAR plots files.

The spacing distances in the **System Verification Setup Block Diagram** is given by the following:

- a) $s = 15 \text{ mm} \pm 0,2 \text{ mm}$ for $300 \text{ MHz} \leq f \leq 1 \text{ 000 MHz}$;
- b) $s = 10 \text{ mm} \pm 0,2 \text{ mm}$ for $1 \text{ 000 MHz} < f \leq 3 \text{ 000 MHz}$;
- c) $s = 10 \text{ mm} \pm 0,2 \text{ mm}$ for $3 \text{ 000 MHz} < f \leq 6 \text{ 000 MHz}$.

System Verification Setup Block Diagram

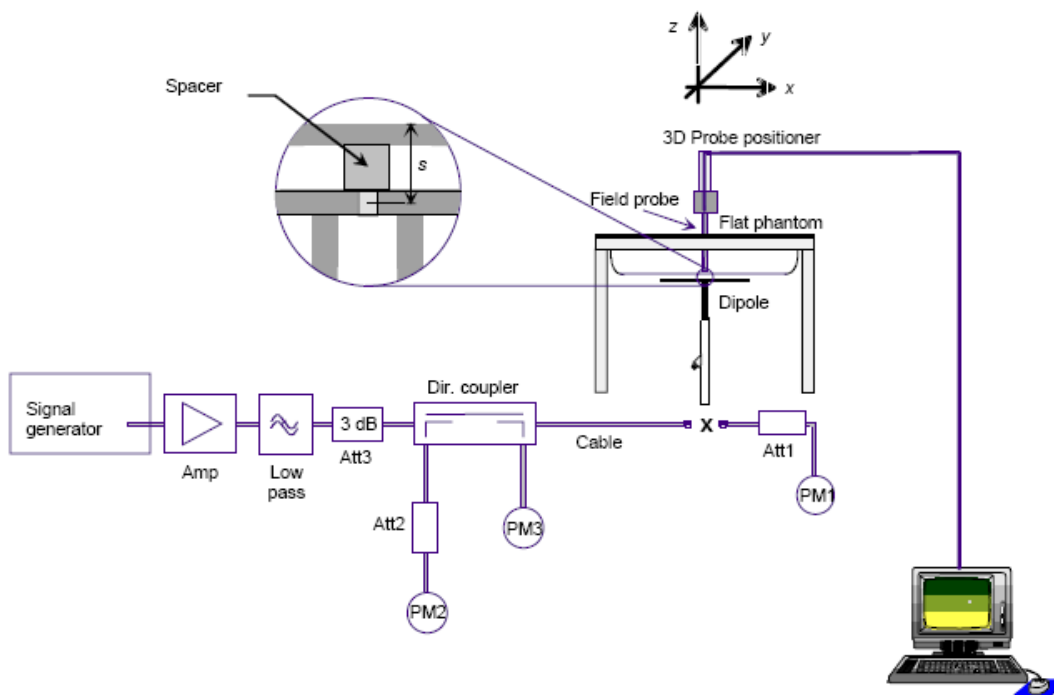

System Accuracy Check Results

Date	Frequency Band (MHz)	Liquid Type	Input Power (mW)	Measured SAR (W/kg)		Normalized to 1W (W/kg)	Target Value (W/Kg)	Delta (%)	Tolerance (%)
2024/01/22	750	Head	100	1g	0.866	8.66	8.41	2.973	±10
2024/01/23	750	Head	100	1g	0.837	8.37	8.41	-0.476	±10
2024/01/24	1750	Head	100	1g	3.62	36.2	36.0	0.556	±10
2024/01/25	1900	Head	100	1g	3.98	39.8	39.9	-0.251	±10
2024/03/09	2300	Head	100	1g	5.16	51.6	48.2	7.054	±10
2024/03/10	2300	Head	100	1g	5.01	50.1	48.2	3.942	±10
2024/03/09	2450	Head	100	1g	5.49	54.9	51.7	6.190	±10
2024/03/10	2450	Head	100	1g	5.38	53.8	51.7	4.062	±10
2024/03/12	2450	Head	100	1g	5.31	53.1	51.7	2.708	±10
2024/03/13	2600	Head	100	1g	5.81	58.1	55.2	5.254	±10
2024/03/08	2600	Head	100	1g	5.69	56.9	55.2	3.080	±10
2024/03/04	3500	Head	100	1g	6.67	66.7	66.4	0.452	±10
2024/03/08	3900	Head	100	1g	6.70	67.0	68.6	-2.332	±10
2024/03/12	5250	Head	100	1g	7.79	77.9	80.1	-2.747	±10
2024/03/13	5250	Head	100	1g	7.72	77.2	80.1	-3.620	±10
2024/03/04	5800	Head	100	1g	7.73	77.3	81.4	-5.037	±10
2024/03/08	5800	Head	100	1g	7.62	76.2	81.4	-6.388	±10

Note:

All the SAR values are normalized to 1Watt forward power.

SAR SYSTEM VALIDATION DATA

System Performance 750 MHz Head (Date 2024/01/22)

DUT: Dipole 750 MHz; Type: D750V3; Serial: 1229

Communication System: UID 0, CW (0); Frequency: 750 MHz;Duty Cycle: 1:1

Medium parameters used: $f = 750 \text{ MHz}$; $\sigma = 0.924 \text{ S/m}$; $\epsilon_r = 40.653$; $\rho = 1000 \text{ kg/m}^3$

Phantom section: Flat Section

DASY5 Configuration:

- Probe: EX3DV4 – SN7382; ConvF(10.65, 10.65, 10.65) @ 750 MHz;
- Sensor-Surface: 1.4mm (Mechanical Surface Detection)
- Electronics: DAE4 Sn1325; Calibrated: 9/27/2023
- Phantom: SAM-Twin V8.0 P1aP2a; Type: QD 000 P41 AA ; Serial: 1962
- Measurement SW: DASY52, Version 52.10 (2);

Head 750MHz Pin=100mW/Area Scan (11x19x1): Measurement grid: dx=10 mm, dy=10 mm

Maximum value of SAR (measured) = 1.21 W/kg

Head 750MHz Pin=100mW/Zoom Scan (7x7x7)/Cube 0: Measurement grid: dx=5mm, dy=5mm, dz=5mm

Reference Value = 33.87 V/m; Power Drift = -0.05 dB

Peak SAR (extrapolated) = 1.29 W/kg

SAR(1 g) = 0.866 W/kg; SAR(10 g) = 0.573 W/kg

Maximum value of SAR (measured) = 0.932 W/kg

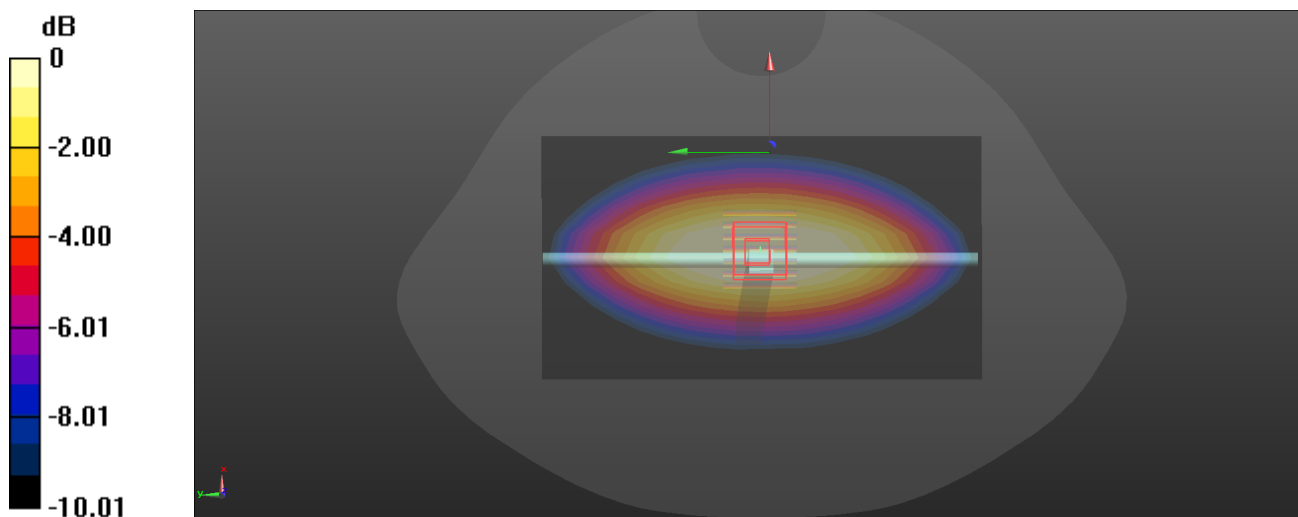

0 dB = 0.932 W/kg = -0.31 dBW/kg

System Performance 750 MHz Head (Date 2024/01/23)

DUT: Dipole 750 MHz; Type: D750V3; Serial: 1229

Communication System: UID 0, CW (0); Frequency: 750 MHz;Duty Cycle: 1:1
 Medium parameters used: $f = 750 \text{ MHz}$; $\sigma = 0.892 \text{ S/m}$; $\epsilon_r = 41.964$; $\rho = 1000 \text{ kg/m}^3$
 Phantom section: Flat Section

DASY5 Configuration:

- Probe: EX3DV4 – SN7382; ConvF(10.65, 10.65, 10.65) @ 750 MHz;
- Sensor-Surface: 1.4mm (Mechanical Surface Detection)
- Electronics: DAE4 Sn1325; Calibrated: 9/27/2023
- Phantom: SAM-Twin V8.0 P1aP2a; Type: QD 000 P41 AA ; Serial: 1962
- Measurement SW: DASY52, Version 52.10 (2);

Head 750MHz Pin=100mW/Area Scan (11x19x1): Measurement grid: dx=10 mm, dy=10 mm
 Maximum value of SAR (measured) = 1.17 W/kg

Head 750MHz Pin=100mW/Zoom Scan (7x7x7)/Cube 0: Measurement grid: dx=5mm, dy=5mm, dz=5mm
 Reference Value = 33.87 V/m; Power Drift = -0.05 dB
 Peak SAR (extrapolated) = 1.24 W/kg
SAR(1 g) = 0.837 W/kg; SAR(10 g) = 0.554 W/kg
 Maximum value of SAR (measured) = 0.899 W/kg

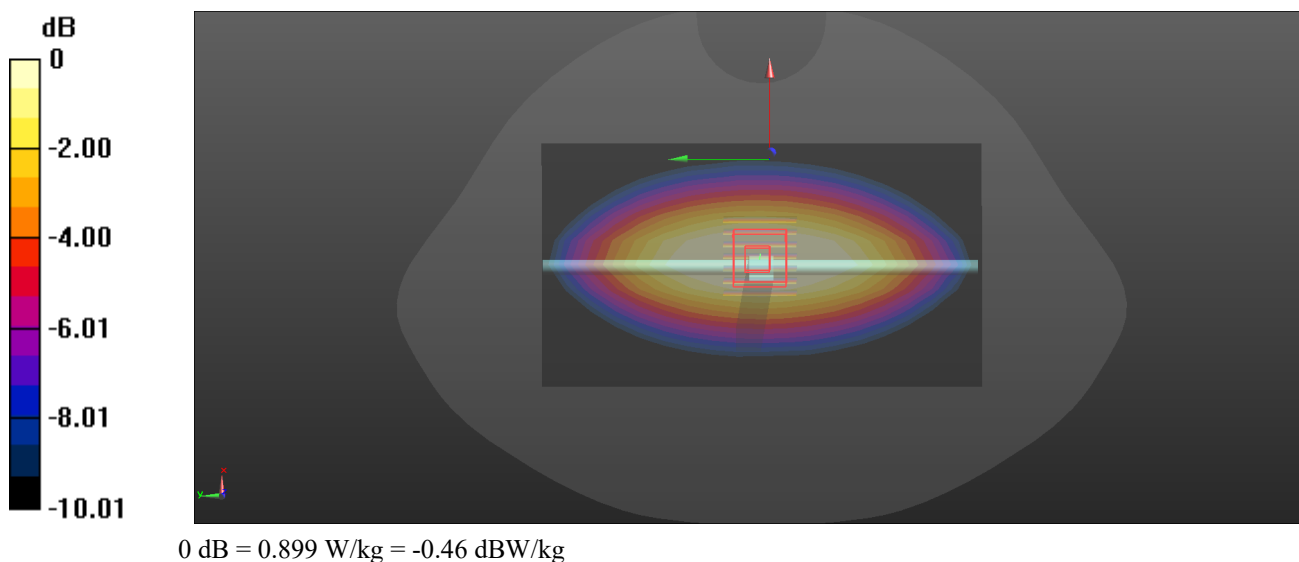

System Performance 1750 MHz Head (Date 2024/01/24)

DUT: Dipole 1750 MHz; Type: D1750V2; Serial: 1199

Communication System: UID 0, CW (0); Frequency: 1750 MHz;Duty Cycle: 1:1
 Medium parameters used: $f = 1750 \text{ MHz}$; $\sigma = 1.364 \text{ S/m}$; $\epsilon_r = 38.829$; $\rho = 1000 \text{ kg/m}^3$
 Phantom section: Flat Section

DASY5 Configuration:

- Probe: EX3DV4 – SN7382; ConvF(8.6, 8.6, 8.6) @ 1750 MHz;
- Sensor-Surface: 1.4mm (Mechanical Surface Detection)
- Electronics: DAE4 Sn1325; Calibrated: 9/27/2023
- Phantom: SAM-Twin V8.0 P1aP2a; Type: QD 000 P41 AA ; Serial: 1962
- Measurement SW: DASY52, Version 52.10 (2);

Head 1750MHz Pin=100mW/Area Scan (7x8x1): Measurement grid: dx=15 mm, dy=15 mm

Maximum value of SAR (measured) = 5.43 W/kg

Head 1750MHz Pin=100mW/Zoom Scan (7x7x7)/Cube 0: Measurement grid: dx=5mm, dy=5mm, dz=5mm

Reference Value = 56.19 V/m; Power Drift = -0.02 dB

Peak SAR (extrapolated) = 6.64 W/kg

SAR(1 g) = 3.62 W/kg; SAR(10 g) = 1.95 W/kg

Maximum value of SAR (measured) = 5.51 W/kg

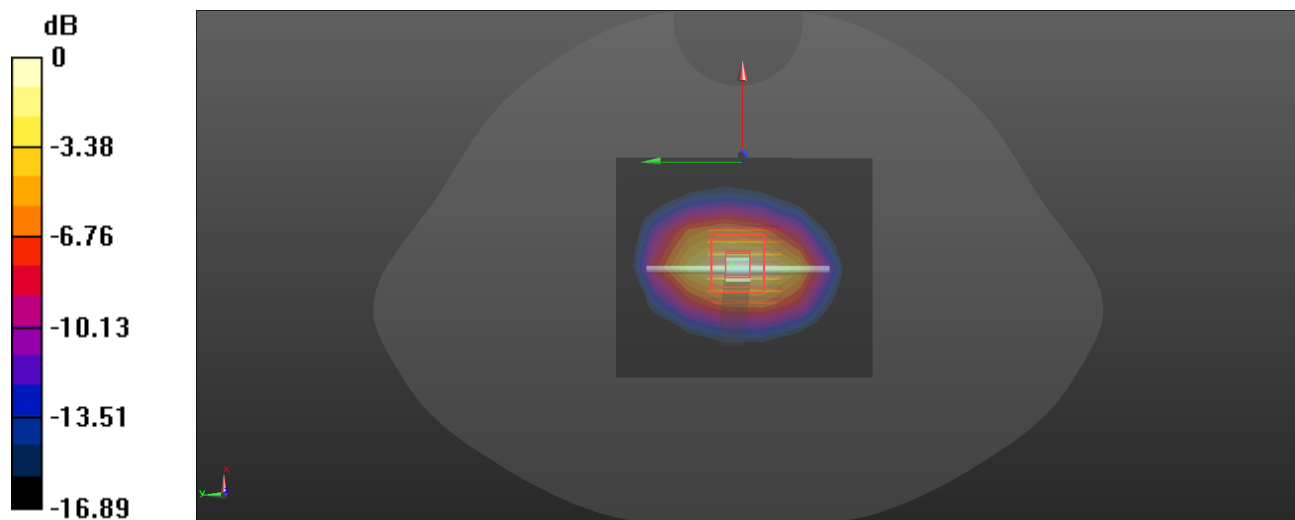

System Performance 1900 MHz Head (Date 2024/01/25)

DUT: Dipole 1900 MHz; Type: D1900V2; Serial: 5d231

Communication System: UID 0, CW (0); Frequency: 1900 MHz;Duty Cycle: 1:1
 Medium parameters used: $f = 1900 \text{ MHz}$; $\sigma = 1.357 \text{ S/m}$; $\epsilon_r = 39.642$; $\rho = 1000 \text{ kg/m}^3$
 Phantom section: Flat Section

DASY5 Configuration:

- Probe: EX3DV4 – SN7382; ConvF(8.3, 8.3, 8.3) @ 1900 MHz;
- Sensor-Surface: 1.4mm (Mechanical Surface Detection)
- Electronics: DAE4 Sn1325; Calibrated: 9/27/2023
- Phantom: SAM-Twin V8.0 P1aP2a; Type: QD 000 P41 AA ; Serial: 1962
- Measurement SW: DASY52, Version 52.10 (2);

Head 1900MHz Pin=100mW/Area Scan (9x13x1): Measurement grid: $dx=10 \text{ mm}$, $dy=10 \text{ mm}$

Maximum value of SAR (measured) = 6.03 W/kg

Head 1900MHz Pin=100mW/Zoom Scan (7x7x7)/Cube 0: Measurement grid: $dx=5\text{mm}$, $dy=5\text{mm}$, $dz=5\text{mm}$

Reference Value = 57.42 V/m; Power Drift = -0.18 dB

Peak SAR (extrapolated) = 7.22 W/kg

SAR(1 g) = 3.98 W/kg; SAR(10 g) = 2.09 W/kg

Maximum value of SAR (measured) = 4.40 W/kg

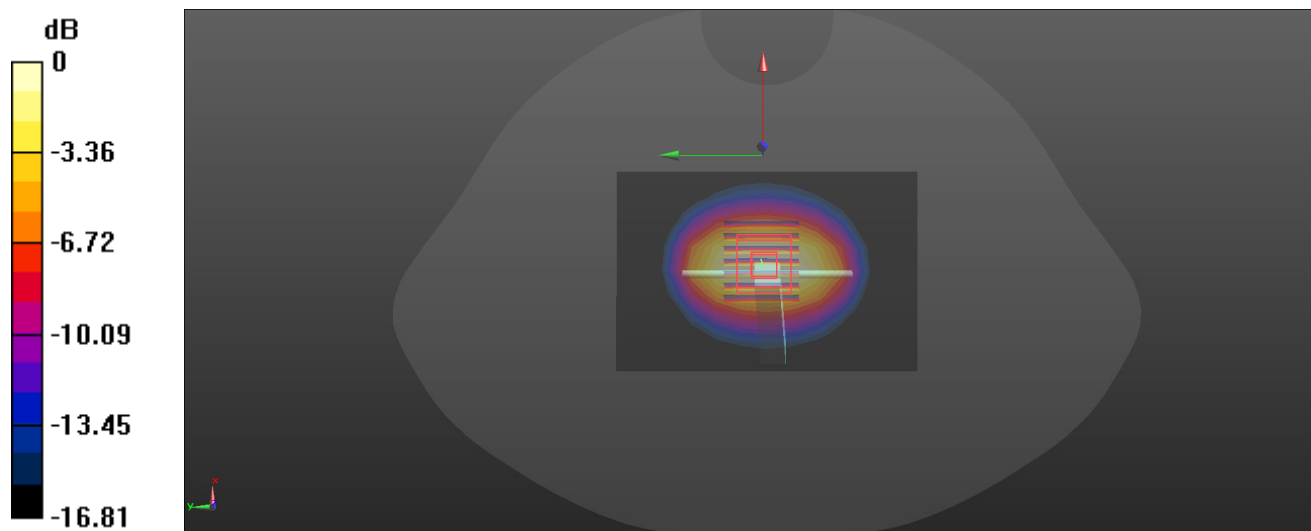

0 dB = 4.40 W/kg = 6.43 dBW/kg

System Performance 2300 MHz Head (Date 2024/03/09)**DUT: Dipole 2300 MHz; Type: D2300V2; Serial: 1136**

Communication System: UID 0, CW (0); Frequency: 2300 MHz; Duty Cycle: 1:1

Medium parameters used: $f = 2300$ MHz; $\sigma = 1.661$ S/m; $\epsilon_r = 38.898$; $\rho = 1000$ kg/m³

Phantom section: Flat Section

DASY5 Configuration:

- Probe: EX3DV4 – SN7382; ConvF(8.16, 8.16, 8.16) @ 2300 MHz;
- Sensor-Surface: 1.4mm (Mechanical Surface Detection)
- Electronics: DAE4 Sn1325; Calibrated: 9/27/2023
- Phantom: SAM-Twin V8.0 P1aP2a; Type: QD 000 P41 AA ; Serial: 1962
- Measurement SW: DASY52, Version 52.10 (2);

Head 2300MHz Pin=100mW/Area Scan (9x10x1): Measurement grid: dx=10 mm, dy=10 mm

Maximum value of SAR (measured) = 7.93 W/kg

Head 2300MHz Pin=100mW/Zoom Scan (7x7x7)/Cube 0: Measurement grid: dx=5mm, dy=5mm, dz=5mm

Reference Value = 61.31 V/m; Power Drift = -0.11 dB

Peak SAR (extrapolated) = 10.1 W/kg

SAR(1 g) = 5.16 W/kg; SAR(10 g) = 2.52 W/kg

Maximum value of SAR (measured) = 8.36 W/kg

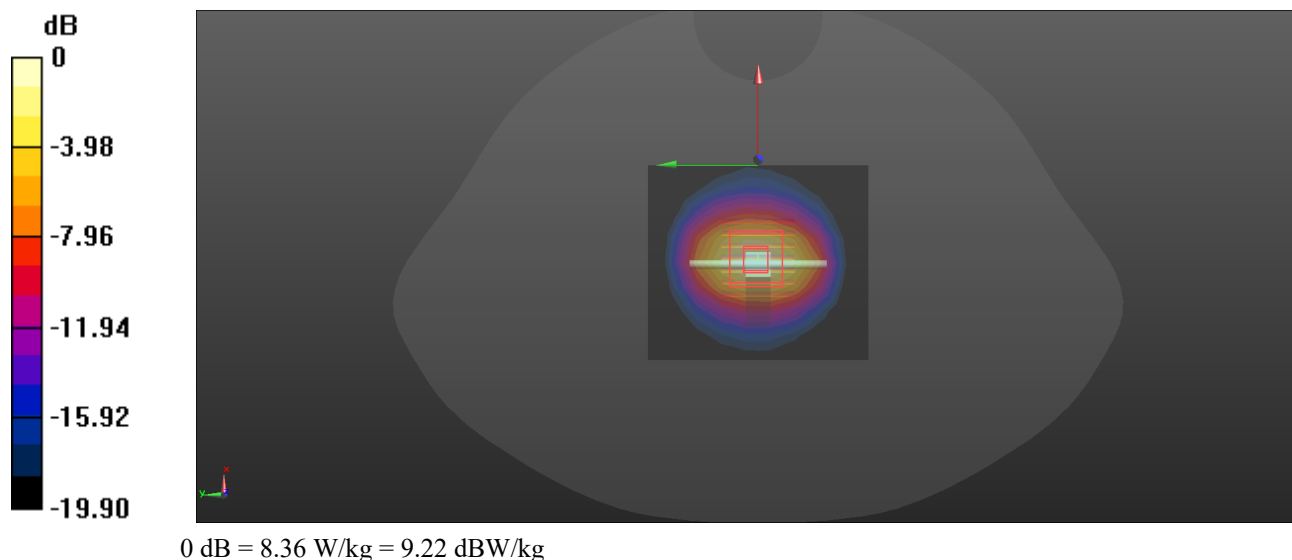

System Performance 2300 MHz Head (Date 2024/03/10)

DUT: Dipole 2300 MHz; Type: D2300V2; Serial: 1136

Communication System: UID 0, CW (0); Frequency: 2300 MHz; Duty Cycle: 1:1
 Medium parameters used: $f = 2300 \text{ MHz}$; $\sigma = 1.719 \text{ S/m}$; $\epsilon_r = 38.18$; $\rho = 1000 \text{ kg/m}^3$
 Phantom section: Flat Section

DASY5 Configuration:

- Probe: EX3DV4 – SN7382; ConvF(8.16, 8.16, 8.16) @ 2300 MHz;
- Sensor-Surface: 1.4mm (Mechanical Surface Detection)
- Electronics: DAE4 Sn1325; Calibrated: 9/27/2023
- Phantom: SAM-Twin V8.0 P1aP2a; Type: QD 000 P41 AA ; Serial: 1962
- Measurement SW: DASY52, Version 52.10 (2);

Head 2300MHz Pin=100mW/Area Scan (9x10x1): Measurement grid: dx=10 mm, dy=10 mm

Maximum value of SAR (measured) = 8.00 W/kg

Head 2300MHz Pin=100mW/Zoom Scan (7x7x7)/Cube 0: Measurement grid: dx=5mm, dy=5mm, dz=5mm

Reference Value = 59.78 V/m; Power Drift = -0.04 dB

Peak SAR (extrapolated) = 9.79 W/kg

SAR(1 g) = 5.01 W/kg; SAR(10 g) = 2.44 W/kg

Maximum value of SAR (measured) = 8.12 W/kg

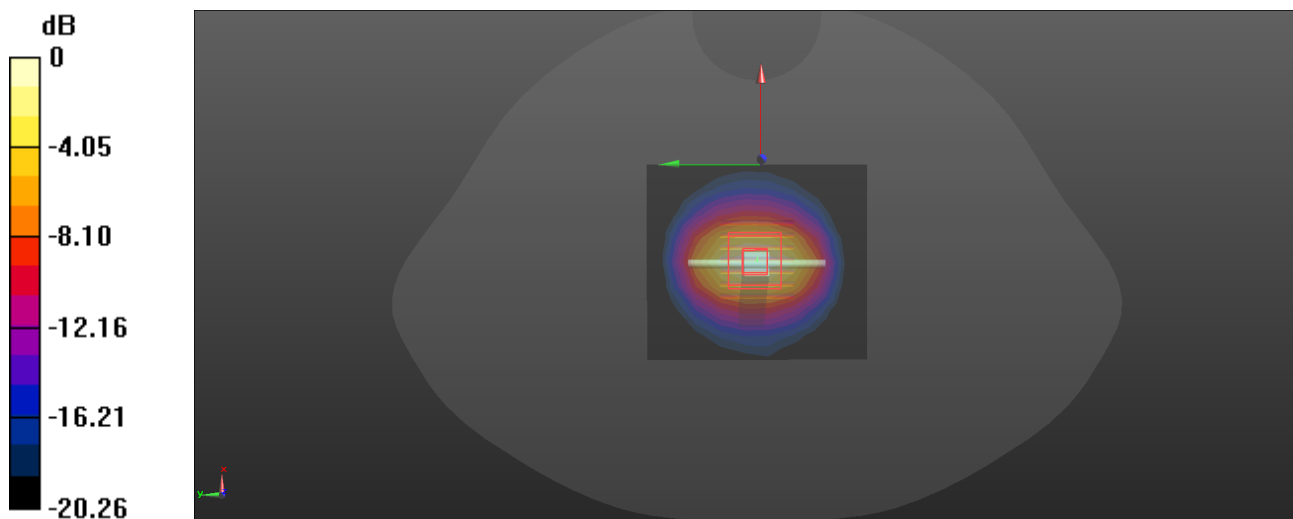

0 dB = 8.12 W/kg = 9.10 dBW/kg

System Performance 2450 MHz Head (Date 2024/03/09)

DUT: Dipole 2450 MHz; Type: 2450V2; Serial: 1103

Communication System: UID 0, CW (0); Frequency: 2450 MHz;Duty Cycle: 1:1
Medium parameters used: $f = 2450$ MHz; $\sigma = 1.816$ S/m; $\epsilon_r = 38.406$; $\rho = 1000$ kg/m³
Phantom section: Flat Section

DASY5 Configuration:

- Probe: EX3DV4 – SN7382; ConvF(7.89, 7.89, 7.89) @ 2450 MHz;
- Sensor-Surface: 1.4mm (Mechanical Surface Detection)
- Electronics: DAE4 Sn1325; Calibrated: 9/27/2023
- Phantom: SAM-Twin V8.0 P1aP2a; Type: QD 000 P41 AA ; Serial: 1962
- Measurement SW: DASY52, Version 52.10 (2);

Head 2450MHz Pin=100mW/Area Scan (9x10x1): Measurement grid: dx=10 mm, dy=10 mm

Maximum value of SAR (measured) = 9.05 W/kg

Head 2450MHz Pin=100mW/Zoom Scan (7x7x7)/Cube 0: Measurement grid: dx=5mm, dy=5mm, dz=5mm

Reference Value = 59.55 V/m; Power Drift = -0.07 dB

Peak SAR (extrapolated) = 10.8 W/kg

SAR(1 g) = 5.49 W/kg; SAR(10 g) = 2.62 W/kg

Maximum value of SAR (measured) = 8.93 W/kg

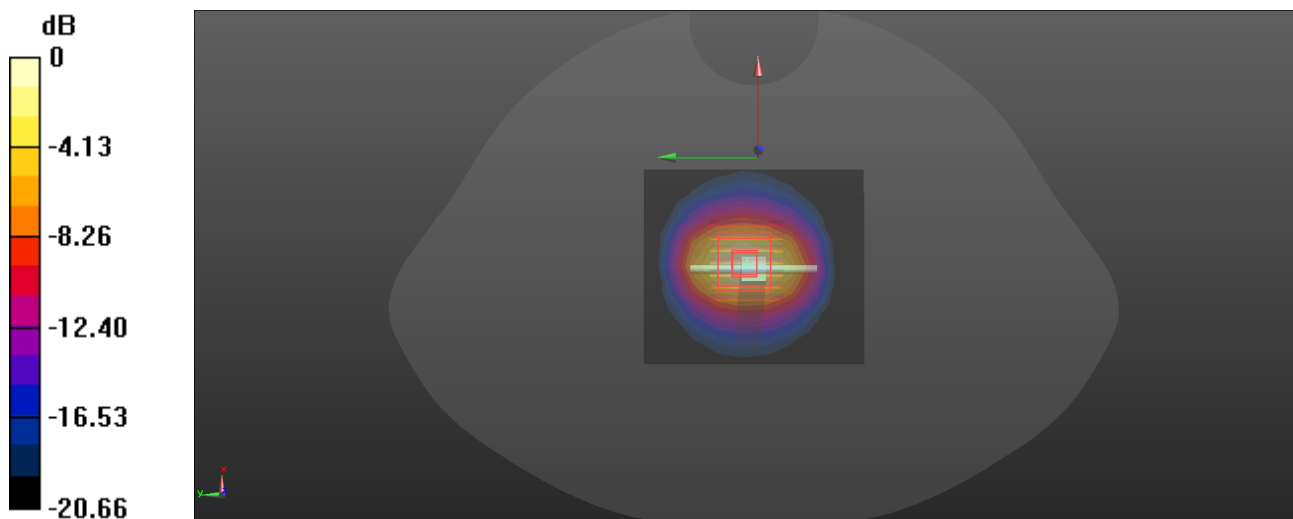

0 dB = 8.93 W/kg = 9.51 dBW/kg

System Performance 2450 MHz Head (Date 2024/03/10)

DUT: Dipole 2450 MHz; Type: 2450V2; Serial: 1103

Communication System: UID 0, CW (0); Frequency: 2450 MHz;Duty Cycle: 1:1
Medium parameters used: $f = 2450$ MHz; $\sigma = 1.788$ S/m; $\epsilon_r = 38.406$; $\rho = 1000$ kg/m³
Phantom section: Flat Section

DASY5 Configuration:

- Probe: EX3DV4 – SN7382; ConvF(7.89, 7.89, 7.89) @ 2450 MHz;
- Sensor-Surface: 1.4mm (Mechanical Surface Detection)
- Electronics: DAE4 Sn1325; Calibrated: 9/27/2023
- Phantom: SAM-Twin V8.0 P1aP2a; Type: QD 000 P41 AA ; Serial: 1962
- Measurement SW: DASY52, Version 52.10 (2);

Head 2450MHz Pin=100mW/Area Scan (9x10x1): Measurement grid: dx=10 mm, dy=10 mm

Maximum value of SAR (measured) = 8.30 W/kg

Head 2450MHz Pin=100mW/Zoom Scan (7x7x7)/Cube 0: Measurement grid: dx=5mm, dy=5mm, dz=5mm

Reference Value = 59.44 V/m; Power Drift = -0.15 dB

Peak SAR (extrapolated) = 10.7 W/kg

SAR(1 g) = 5.38 W/kg; SAR(10 g) = 2.55 W/kg

Maximum value of SAR (measured) = 8.85 W/kg

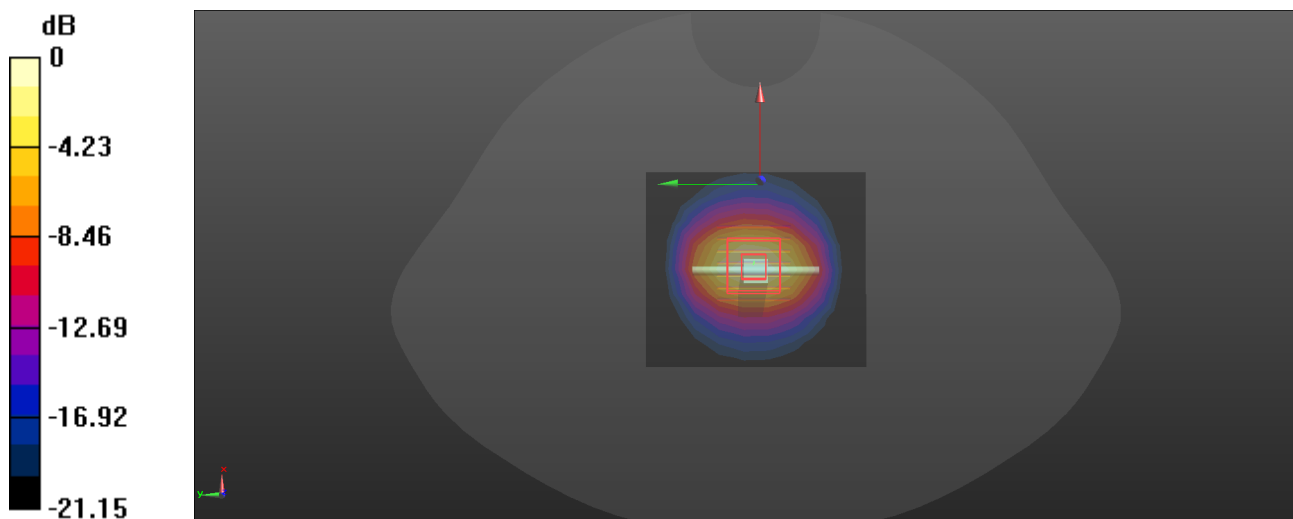

0 dB = 8.85 W/kg = 9.47 dBW/kg

System Performance 2450 MHz Head (Date 2024/03/12)

DUT: Dipole 2450 MHz; Type: 2450V2; Serial: 1103

Communication System: UID 0, CW (0); Frequency: 2450 MHz;Duty Cycle: 1:1
 Medium parameters used: $f = 2450 \text{ MHz}$; $\sigma = 1.802 \text{ S/m}$; $\epsilon_r = 40.23$; $\rho = 1000 \text{ kg/m}^3$
 Phantom section: Flat Section

DASY5 Configuration:

- Probe: EX3DV4 – SN7382; ConvF(7.89, 7.89, 7.89) @ 2450 MHz;
- Sensor-Surface: 1.4mm (Mechanical Surface Detection)
- Electronics: DAE4 Sn1325; Calibrated: 9/27/2023
- Phantom: SAM-Twin V8.0 P1aP2a; Type: QD 000 P41 AA ; Serial: 1962
- Measurement SW: DASY52, Version 52.10 (2);

Head 2450MHz Pin=100mW/Area Scan (9x10x1): Measurement grid: dx=10 mm, dy=10 mm

Maximum value of SAR (measured) = 8.17 W/kg

Head 2450MHz Pin=100mW/Zoom Scan (7x7x7)/Cube 0: Measurement grid: dx=5mm, dy=5mm, dz=5mm

Reference Value = 59.30 V/m; Power Drift = -0.09 dB

Peak SAR (extrapolated) = 10.3 W/kg

SAR(1 g) = 5.31 W/kg; SAR(10 g) = 2.53 W/kg

Maximum value of SAR (measured) = 8.57 W/kg

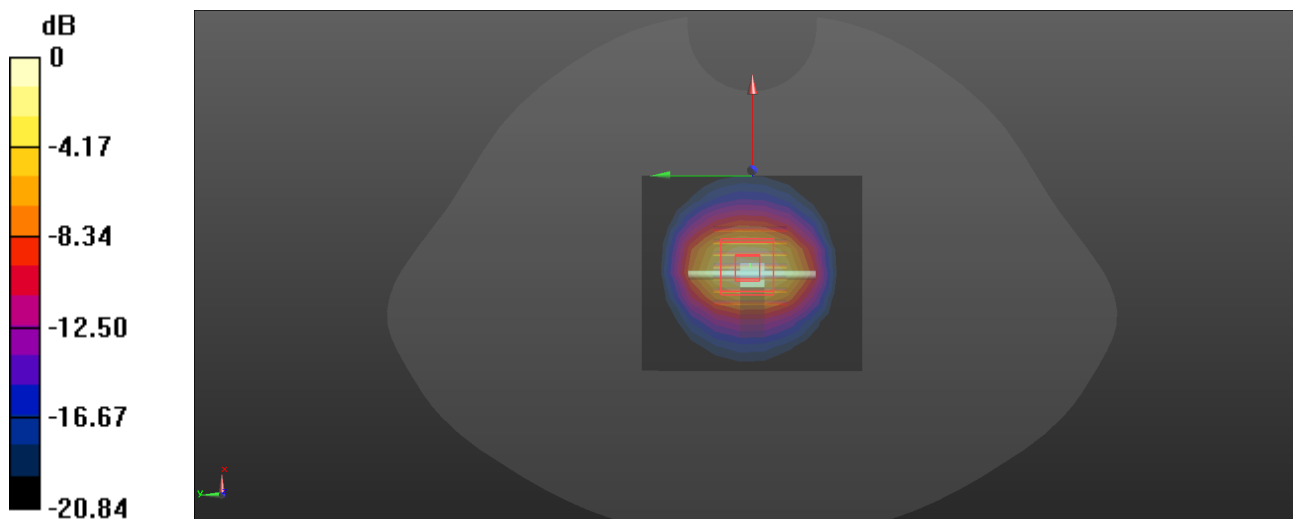

0 dB = 8.57 W/kg = 9.33 dBW/kg

System Performance 2600 MHz Head (Date 2024/03/13)

DUT: Dipole 2600 MHz; Type: D2600V2; Serial: 1207

Communication System: UID 0, CW (0); Frequency: 2600 MHz;Duty Cycle: 1:1
 Medium parameters used: $f = 2600 \text{ MHz}$; $\sigma = 1.988 \text{ S/m}$; $\epsilon_r = 37.514$; $\rho = 1000 \text{ kg/m}^3$
 Phantom section: Flat Section

DASY5 Configuration:

- Probe: EX3DV4 – SN7382; ConvF(7.65, 7.65, 7.65) @ 2600 MHz;
- Sensor-Surface: 1.4mm (Mechanical Surface Detection)
- Electronics: DAE4 Sn1325; Calibrated: 9/27/2023
- Phantom: SAM-Twin V8.0 P1aP2a; Type: QD 000 P41 AA ; Serial: 1962
- Measurement SW: DASY52, Version 52.10 (2);

Head 2600MHz Pin=100mW/Area Scan (9x10x1): Measurement grid: dx=10 mm, dy=10 mm

Maximum value of SAR (measured) = 8.86 W/kg

Head 2600MHz Pin=100mW/Zoom Scan (7x7x7)/Cube 0: Measurement grid: dx=5mm, dy=5mm, dz=5mm

Reference Value = 59.57 V/m; Power Drift = -0.04 dB

Peak SAR (extrapolated) = 11.8 W/kg

SAR(1 g) = 5.81 W/kg; SAR(10 g) = 2.7 W/kg

Maximum value of SAR (measured) = 9.68 W/kg

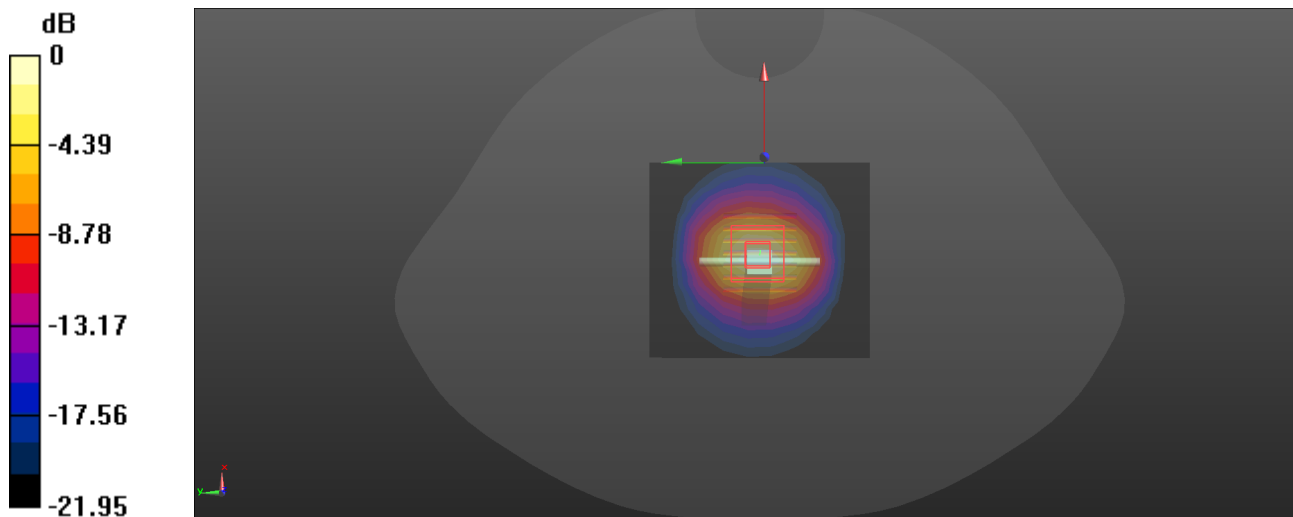

0 dB = 9.68 W/kg = 9.86 dBW/kg

System Performance 2600 MHz Head (Date 2024/03/08)

DUT: Dipole 2600 MHz; Type: D2600V2; Serial: 1207

Communication System: UID 0, CW (0); Frequency: 2600 MHz;Duty Cycle: 1:1
 Medium parameters used: $f = 2600 \text{ MHz}$; $\sigma = 1.947 \text{ S/m}$; $\epsilon_r = 37.945$; $\rho = 1000 \text{ kg/m}^3$
 Phantom section: Flat Section

DASY5 Configuration:

- Probe: EX3DV4 – SN7382; ConvF(7.65, 7.65, 7.65) @ 2600 MHz;
- Sensor-Surface: 1.4mm (Mechanical Surface Detection)
- Electronics: DAE4 Sn1325; Calibrated: 9/27/2023
- Phantom: SAM-Twin V8.0 P1aP2a; Type: QD 000 P41 AA ; Serial: 1962
- Measurement SW: DASY52, Version 52.10 (2);

Head 2600MHz Pin=100mW/Area Scan (9x10x1): Measurement grid: dx=10 mm, dy=10 mm

Maximum value of SAR (measured) = 8.67 W/kg

Head 2600MHz Pin=100mW/Zoom Scan (7x7x7)/Cube 0: Measurement grid: dx=5mm, dy=5mm, dz=5mm

Reference Value = 59.57 V/m; Power Drift = -0.04 dB

Peak SAR (extrapolated) = 11.5 W/kg

SAR(1 g) = 5.69 W/kg; SAR(10 g) = 2.64 W/kg

Maximum value of SAR (measured) = 9.48 W/kg

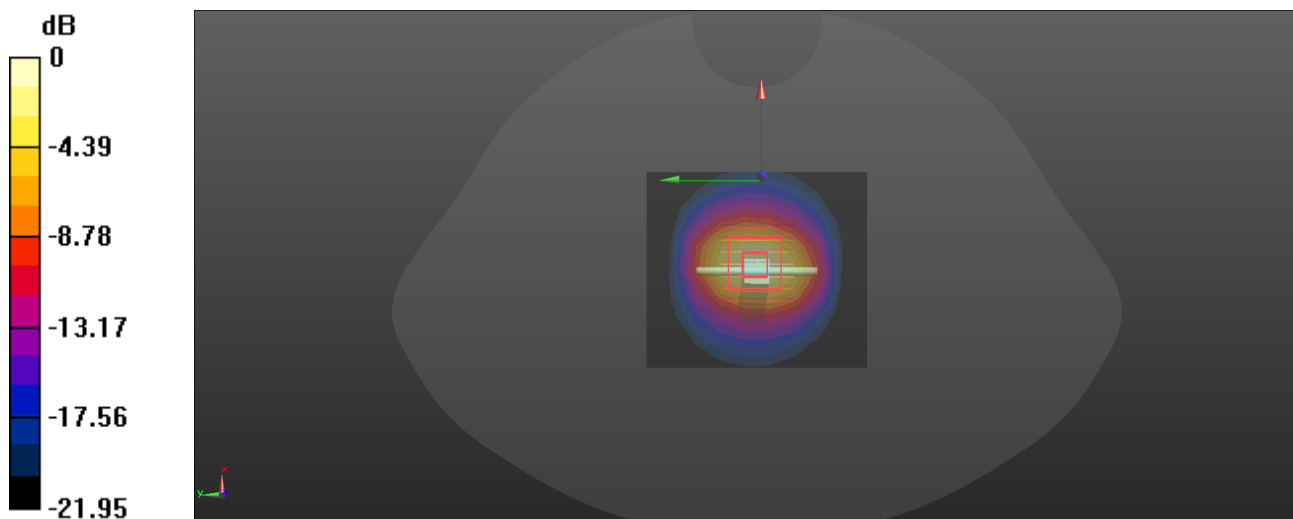

0 dB = 9.48 W/kg = 9.77 dBW/kg

System Performance 3500 MHz Head (Date 2024/03/04)

DUT: Dipole 3500 MHz Type: D3500 MHzV2; Serial: 1113

Communication System: UID 0, CW (0); Frequency: 3500 MHz;Duty Cycle: 1:1

Medium parameters used: $f = 3500 \text{ MHz}$; $\sigma = 2.913 \text{ S/m}$; $\epsilon_r = 36.558$; $\rho = 1000 \text{ kg/m}^3$

Phantom section: Flat Section

DASY5 Configuration:

- Probe: EX3DV4 – SN7382; ConvF(7.24, 7.24, 7.24) @ 3500 MHz;
- Sensor-Surface: 1.4mm (Mechanical Surface Detection)
- Electronics: DAE4 Sn1325; Calibrated: 9/27/2023
- Phantom: SAM-Twin V8.0 P1aP2a; Type: QD 000 P41 AA ; Serial: 1962
- Measurement SW: DASY52, Version 52.10 (2);

Head 3500MHz Pin=100mW/Area Scan (9x11x1): Measurement grid: dx=10 mm, dy=10 mm

Maximum value of SAR (measured) = 12.5 W/kg

Head 3500MHz Pin=100mW/Zoom Scan (8x8x15)/Cube 0: Measurement grid: dx=4mm, dy=4mm, dz=2mm

Reference Value = 51.80 V/m; Power Drift = -0.06 dB

Peak SAR (extrapolated) = 15.9 W/kg

SAR(1 g) = 6.67 W/kg; SAR(10 g) = 2.68 W/kg

Maximum value of SAR (measured) = 12.2 W/kg

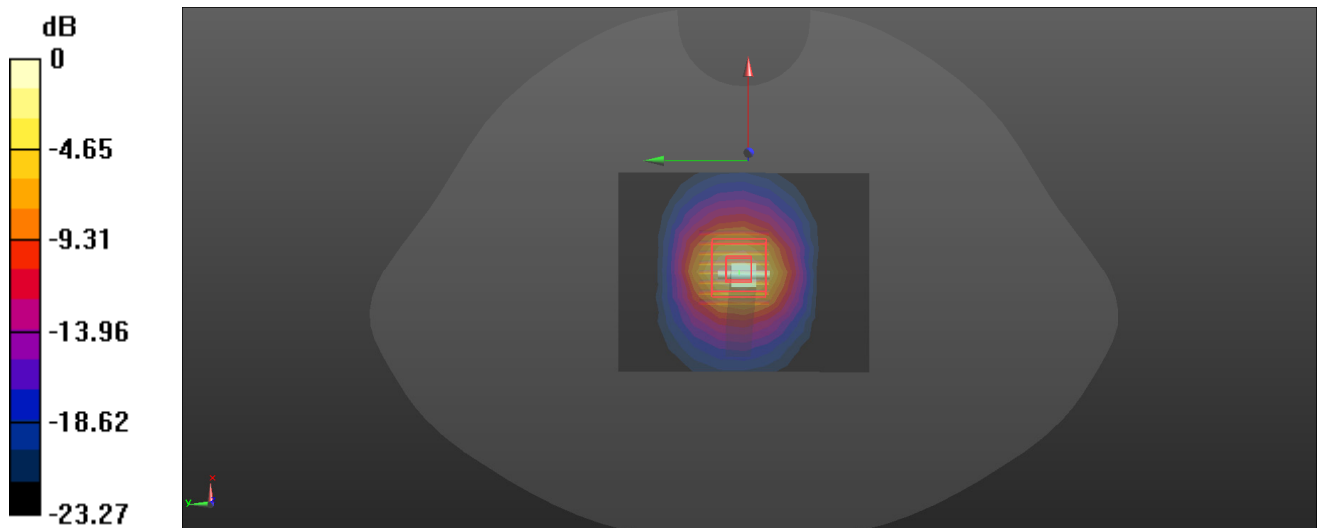

0 dB = 12.2 W/kg = 10.86 dBW/kg

System Performance 3900 MHz Head (Date 2024/03/08)

DUT: Dipole 3900 MHz Type: D3900 MHzV2; Serial: 1058

Communication System: UID 0, CW (0); Frequency: 3900 MHz;Duty Cycle: 1:1
 Medium parameters used: $f = 3900 \text{ MHz}$; $\sigma = 3.253 \text{ S/m}$; $\epsilon_r = 36.986$; $\rho = 1000 \text{ kg/m}^3$
 Phantom section: Flat Section

DASY5 Configuration:

- Probe: EX3DV4 – SN7382; ConvF(6.98, 6.98, 6.98) @ 3900 MHz;
- Sensor-Surface: 1.4mm (Mechanical Surface Detection)
- Electronics: DAE4 Sn1325; Calibrated: 9/27/2023
- Phantom: SAM-Twin V8.0 P1aP2a; Type: QD 000 P41 AA ; Serial: 1962
- Measurement SW: DASY52, Version 52.10 (2);

Head 3900MHz Pin=100mW/Area Scan (9x11x1): Measurement grid: dx=10 mm, dy=10 mm

Maximum value of SAR (measured) = 12.2 W/kg

Head 3900MHz Pin=100mW/Zoom Scan (8x8x15)/Cube 0: Measurement grid: dx=4mm, dy=4mm, dz=2mm

Reference Value = 48.01 V/m; Power Drift = -0.09 dB

Peak SAR (extrapolated) = 17.6 W/kg

SAR(1 g) = 6.7 W/kg; SAR(10 g) = 2.4 W/kg

Maximum value of SAR (measured) = 12.8 W/kg

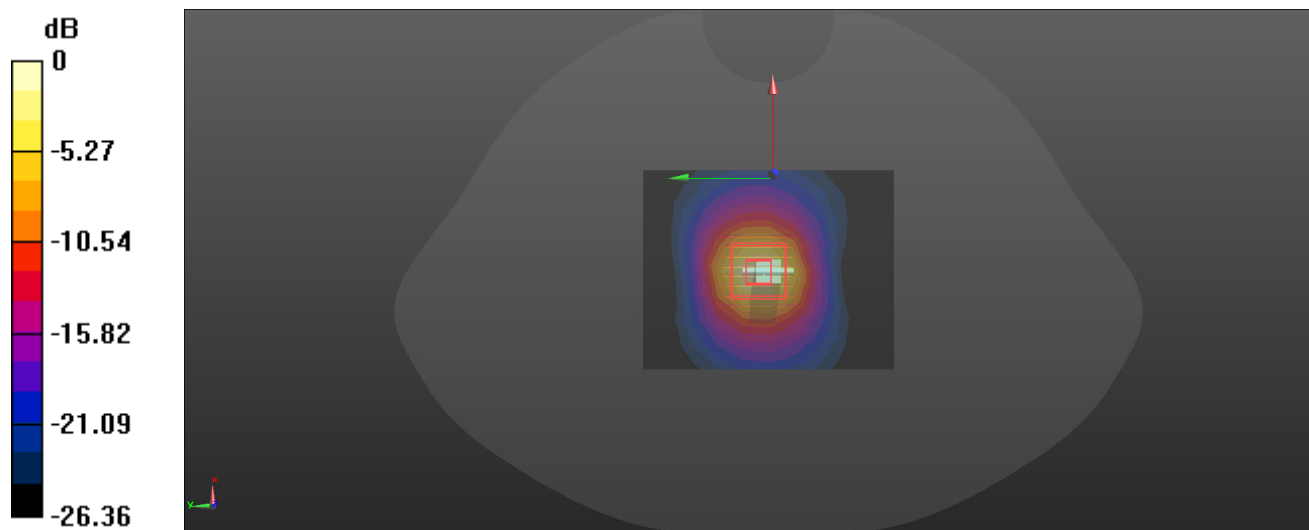

0 dB = 12.8 W/kg = 11.07 dBW/kg

System Performance 5250 MHz Head (Date 2024/03/12)

DUT: Dipole 5GHz Type: D5GHzV2; Serial: 1374

Communication System: UID 0, CW (0); Frequency: 5250 MHz;Duty Cycle: 1:1
Medium parameters used: $f = 5250 \text{ MHz}$; $\sigma = 4.622 \text{ S/m}$; $\epsilon_r = 35.923$; $\rho = 1000 \text{ kg/m}^3$
Phantom section: Flat Section

DASY5 Configuration:

- Probe: EX3DV4 – SN7382; ConvF(5.62, 5.62, 5.62) @ 5250 MHz;
- Sensor-Surface: 1.4mm (Mechanical Surface Detection)
- Electronics: DAE4 Sn1325; Calibrated: 9/27/2023
- Phantom: SAM-Twin V8.0 P1aP2a; Type: QD 000 P41 AA ; Serial: 1962
- Measurement SW: DASY52, Version 52.10 (2);

Head 5250MHz Pin=100mW/Area Scan (7x9x1): Measurement grid: dx=10 mm, dy=10 mm

Maximum value of SAR (measured) = 17.6 W/kg

Head 5250MHz Pin=100mW/Zoom Scan (8x8x15)/Cube 0: Measurement grid: dx=4mm, dy=4mm, dz=2mm

Reference Value = 44.17 V/m; Power Drift = -0.08 dB

Peak SAR (extrapolated) = 26.6 W/kg

SAR(1 g) = 7.79 W/kg; SAR(10 g) = 2.3 W/kg

Maximum value of SAR (measured) = 17.6 W/kg

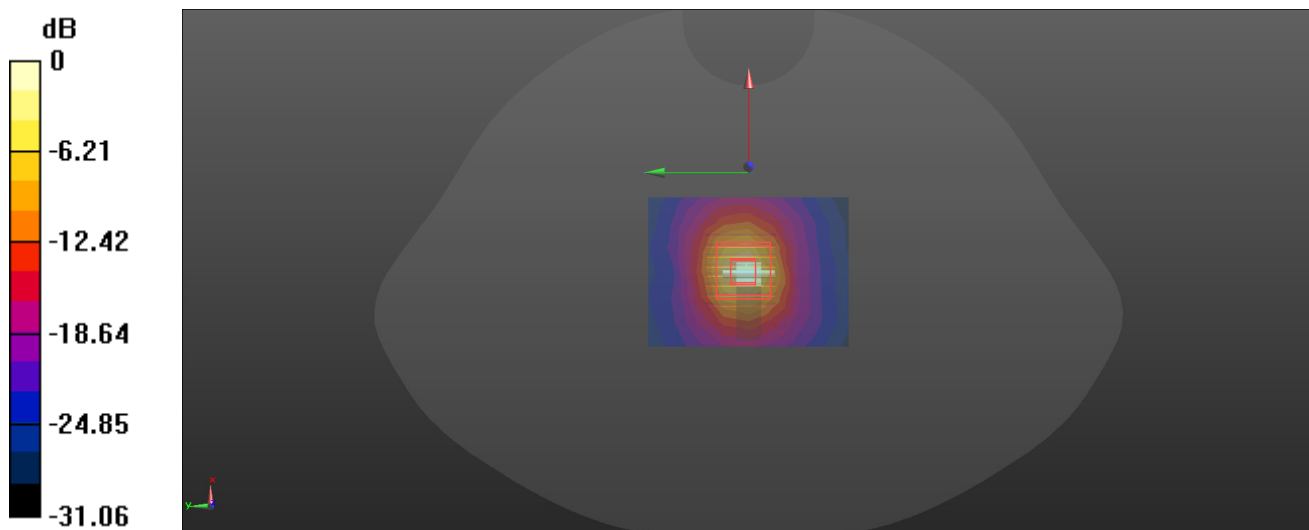

0 dB = 17.6 W/kg = 12.46 dBW/kg

System Performance 5250 MHz Head (Date 2024/03/13)

DUT: Dipole 5GHz Type: D5GHzV2; Serial: 1374

Communication System: UID 0, CW (0); Frequency: 5250 MHz;Duty Cycle: 1:1
Medium parameters used: $f = 5250 \text{ MHz}$; $\sigma = 4.813 \text{ S/m}$; $\epsilon_r = 35.235$; $\rho = 1000 \text{ kg/m}^3$
Phantom section: Flat Section

DASY5 Configuration:

- Probe: EX3DV4 – SN7382; ConvF(5.62, 5.62, 5.62) @ 5250 MHz;
- Sensor-Surface: 1.4mm (Mechanical Surface Detection)
- Electronics: DAE4 Sn1325; Calibrated: 9/27/2023
- Phantom: SAM-Twin V8.0 P1aP2a; Type: QD 000 P41 AA ; Serial: 1962
- Measurement SW: DASY52, Version 52.10 (2);

Head 5250MHz Pin=100mW/Area Scan (7x9x1): Measurement grid: dx=10 mm, dy=10 mm

Maximum value of SAR (measured) = 18.4 W/kg

Head 5250MHz Pin=100mW/Zoom Scan (8x8x15)/Cube 0: Measurement grid: dx=4mm, dy=4mm, dz=2mm

Reference Value = 44.66 V/m; Power Drift = -0.12 dB

Peak SAR (extrapolated) = 26.0 W/kg

SAR(1 g) = 7.72 W/kg; SAR(10 g) = 2.27 W/kg

Maximum value of SAR (measured) = 17.1 W/kg

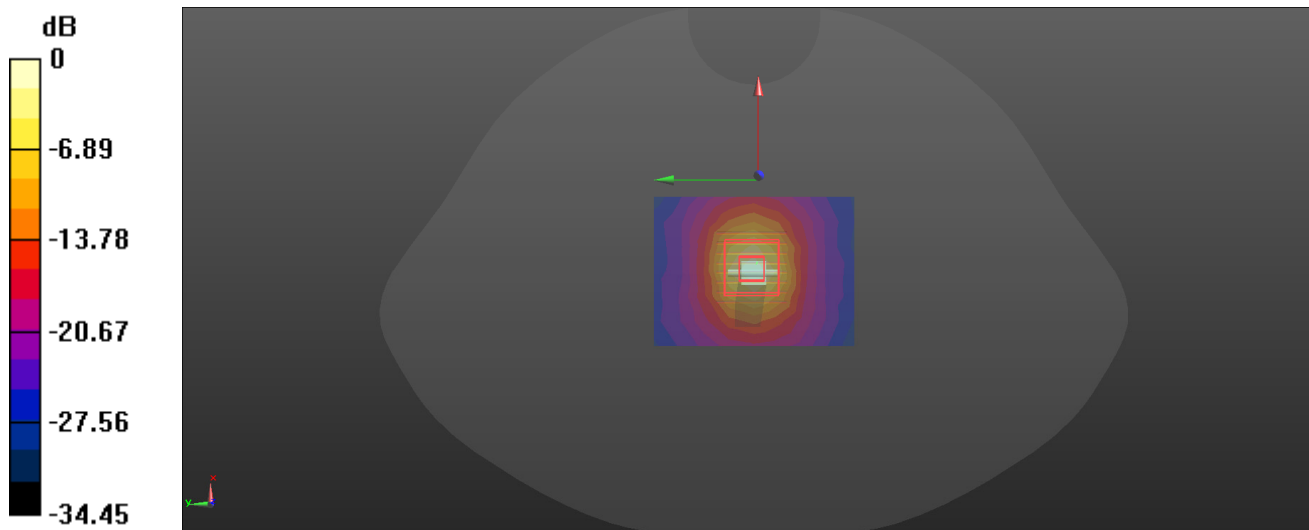

0 dB = 17.1 W/kg = 12.33dBW/kg

System Performance 5800 MHz Head (Date 2024/03/04)

DUT: Dipole 5GHz Type: D5GHzV2; Serial: 1374

Communication System: UID 0, CW (0); Frequency: 5800 MHz;Duty Cycle: 1:1
Medium parameters used: $f = 5800 \text{ MHz}$; $\sigma = 5.305 \text{ S/m}$; $\epsilon_r = 34.05$; $\rho = 1000 \text{ kg/m}^3$
Phantom section: Flat Section

DASY5 Configuration:

- Probe: EX3DV4 – SN7382; ConvF(5.08, 5.08, 5.08) @ 5800 MHz;
- Sensor-Surface: 1.4mm (Mechanical Surface Detection)
- Electronics: DAE4 Sn1325; Calibrated: 9/27/2023
- Phantom: SAM-Twin V8.0 P1aP2a; Type: QD 000 P41 AA ; Serial: 1962
- Measurement SW: DASY52, Version 52.10 (2);

Head 5800MHz Pin=100mW/Area Scan (7x7x1): Measurement grid: dx=10mm, dy=10mm

Maximum value of SAR (measured) = 17.1 W/kg

Head 5800MHz Pin=100mW/Zoom Scan (8x8x15)/Cube 0: Measurement grid: dx=4mm, dy=4mm, dz=2mm

Reference Value = 38.04 V/m; Power Drift = 0.01 dB

Peak SAR (extrapolated) = 32.4 W/kg

SAR(1 g) = 7.73 W/kg; SAR(10 g) = 2.22 W/kg

Maximum value of SAR (measured) = 19.1 W/kg

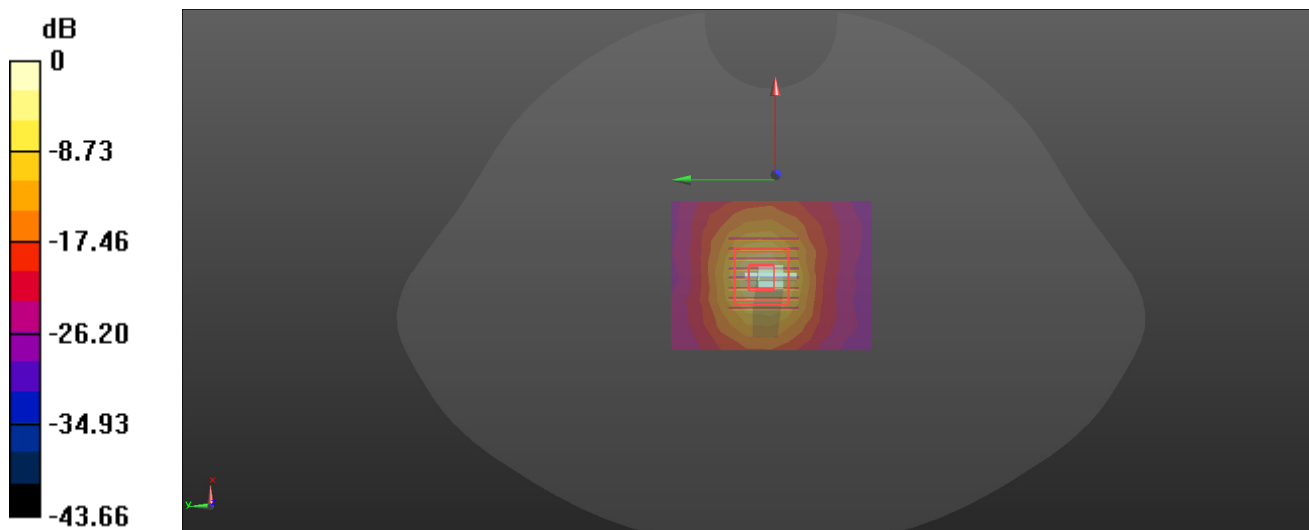

0 dB = 19.1 W/kg = 12.81 dBW/kg

System Performance 5800 MHz Head (Date 2024/03/08)

DUT: Dipole 5GHz Type: D5GHzV2; Serial: 1374

Communication System: UID 0, CW (0); Frequency: 5800 MHz;Duty Cycle: 1:1
Medium parameters used: $f = 5800 \text{ MHz}$; $\sigma = 5.16 \text{ S/m}$; $\epsilon_r = 35.034$; $\rho = 1000 \text{ kg/m}^3$
Phantom section: Flat Section

DASY5 Configuration:

- Probe: EX3DV4 – SN7382; ConvF(5.08, 5.08, 5.08) @ 5800 MHz;
- Sensor-Surface: 1.4mm (Mechanical Surface Detection)
- Electronics: DAE4 Sn1325; Calibrated: 9/27/2023
- Phantom: SAM-Twin V8.0 P1aP2a; Type: QD 000 P41 AA ; Serial: 1962
- Measurement SW: DASY52, Version 52.10 (2);

Head 5800MHz Pin=100mW/Area Scan (7x7x1): Measurement grid: dx=10mm, dy=10mm

Maximum value of SAR (measured) = 18.5 W/kg

Head 5800MHz Pin=100mW/Zoom Scan (8x8x12)/Cube 0: Measurement grid: dx=4mm, dy=4mm, dz=2mm

Reference Value = 41.53 V/m; Power Drift = -0.04 dB

Peak SAR (extrapolated) = 28.9 W/kg

SAR(1 g) = 7.62 W/kg; SAR(10 g) = 2.23 W/kg

Maximum value of SAR (measured) = 17.8 W/kg

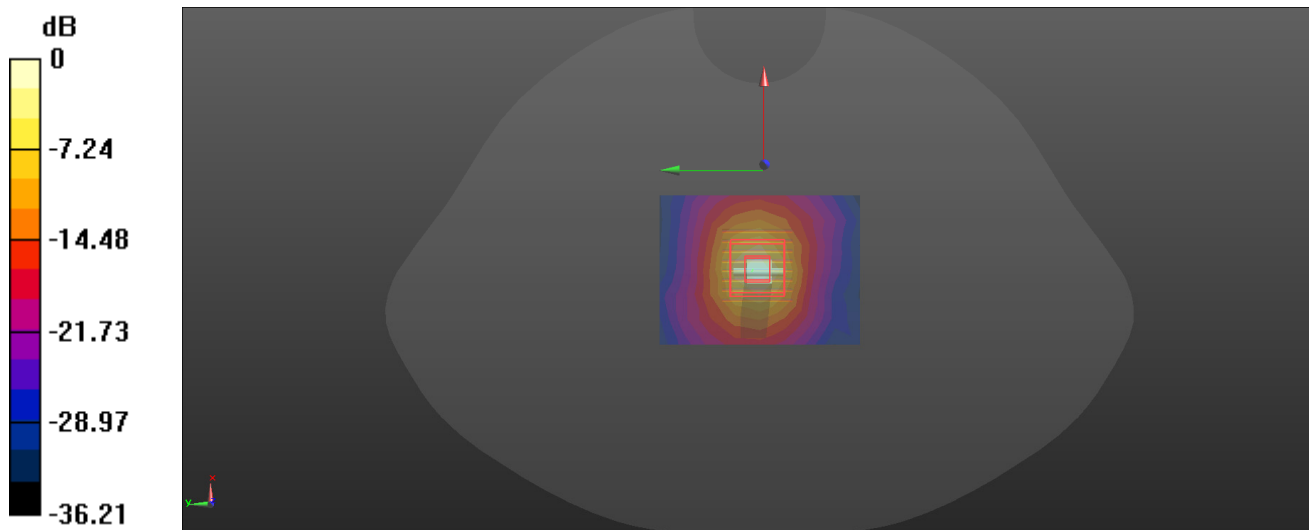

0 dB = 17.8 W/kg = 12.50 dBW/kg

EUT TEST STRATEGY AND METHODOLOGY

Test Positions for Device Operating Next to a Person’s Ear

This category includes most wireless handsets with fixed, retractable or internal antennas located toward the top half of the device, with or without a foldout, sliding or similar keypad cover. The handset should have its earpiece located within the upper ¼ of the device, either along the centerline or off-centered, as perceived by its users. This type of handset should be positioned in a normal operating position with the “test device reference point” located along the “vertical centerline” on the front of the device aligned to the “ear reference point”. The “test device reference point” should be located at the same level as the center of the earpiece region. The “vertical centerline” should bisect the front surface of the handset at its top and bottom edges. A “ear reference point” is located on the outer surface of the head phantom on each ear spacer. It is located 1.5 cm above the center of the ear canal entrance in the “phantom reference plane” defined by the three lines joining the center of each “ear reference point” (left and right) and the tip of the mouth.

A handset should be initially positioned with the earpiece region pressed against the ear spacer of a head phantom. For the SCC-34/SC-2 head phantom, the device should be positioned parallel to the “N-F” line defined along the base of the ear spacer that contains the “ear reference point”. For interim head phantoms, the device should be positioned parallel to the cheek for maximum RF energy coupling. The “test device reference point” is aligned to the “ear reference point” on the head phantom and the “vertical centerline” is aligned to the “phantom reference plane”. This is called the “initial ear position”. While maintaining these three alignments, the body of the handset is gradually adjusted to each of the following positions for evaluating SAR:

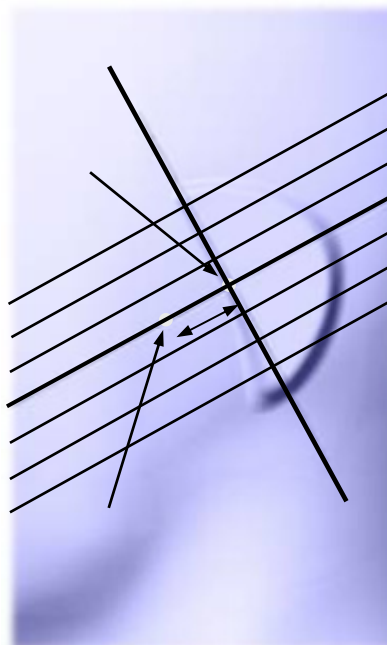
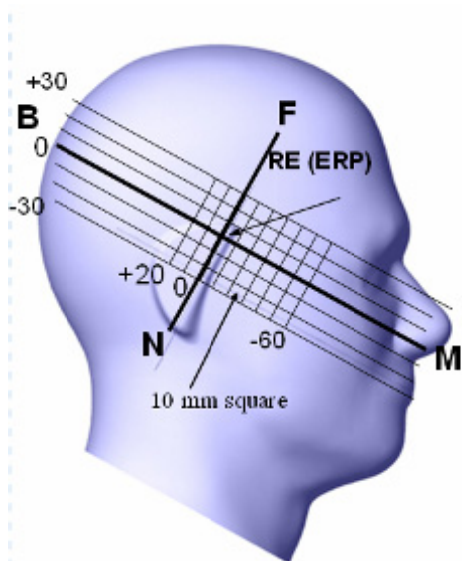

Cheek/Touch Position

The device is brought toward the mouth of the head phantom by pivoting against the “ear reference point” or along the “N-F” line for the SCC-34/SC-2 head phantom.

This test position is established:

When any point on the display, keypad or mouthpiece portions of the handset is in contact with the phantom.

(or) When any portion of a foldout, sliding or similar keypad cover opened to its intended self-adjusting normal use position is in contact with the cheek or mouth of the phantom.

For existing head phantoms – when the handset loses contact with the phantom at the pivoting point, rotation should continue until the device touches the cheek of the phantom or breaks its last contact from the ear spacer.

Cheek /Touch Position

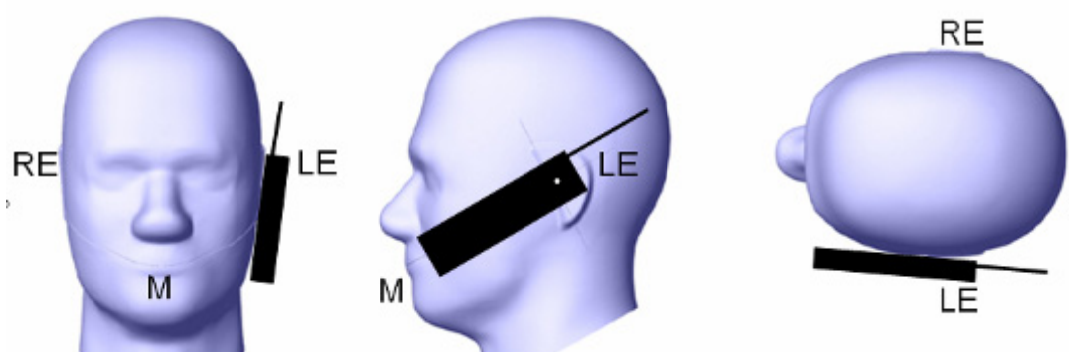

Ear/Tilt Position

With the handset aligned in the “Cheek/Touch Position”:

1) If the earpiece of the handset is not in full contact with the phantom’s ear spacer (in the “Cheek/Touch position”) and the peak SAR location for the “Cheek/Touch” position is located at the ear spacer region or corresponds to the earpiece region of the handset, the device should be returned to the “initial ear position” by rotating it away from the mouth until the earpiece is in full contact with the ear spacer.

2) (otherwise) The handset should be moved (translated) away from the cheek perpendicular to the line passes through both “ear reference points” (note: one of these ear reference points may not physically exist on a split head model) for approximate 2-3 cm. While it is in this position, the device handset is tilted away from the mouth with respect to the “test device reference point” until the inside angle between the vertical centerline on the front surface of the phone and the horizontal line passing through the ear reference point is by 15 80°. After the tilt, it is then moved (translated) back toward the head perpendicular to the line passes through both “ear reference points” until the device touches the phantom or the ear spacer. If the antenna touches the head first, the positioning process should be repeated with a tilt angle less than 15° so that the device and its antenna would touch the phantom simultaneously. This test position may require a device holder or positioner to achieve the translation and tilting with acceptable positioning repeatability.

If a device is also designed to transmit with its keypad cover closed for operating in the head position, such positions should also be considered in the SAR evaluation. The device should be tested on the left and right side of the head phantom in the “Cheek/Touch” and “Ear/Tilt” positions. When applicable, each configuration should be tested with the antenna in its fully extended and fully retracted positions. These test configurations should be tested at the high, middle and low frequency channels of each operating mode; for example, AMPS, CDMA, and TDMA. If the SAR measured at the middle channel for each test configuration (left, right, Cheek/Touch, Tilt/Ear, extended and retracted) is at least 2.0 dB lower than the SAR limit, testing at the high and low channels is optional for such test configuration(s). If the transmission band of the test device is less than 10 MHz, testing at the high and low frequency channels is optional.

Ear /Tilt 15° Position

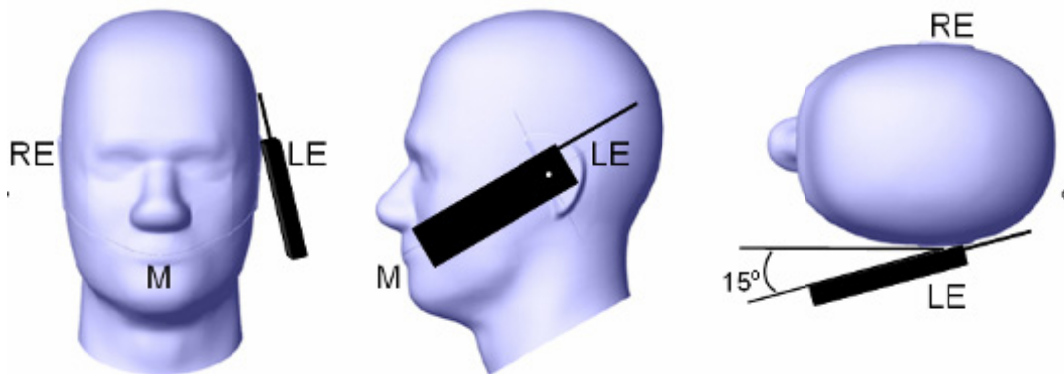

Test positions for body-worn and other configurations

Body-worn operating configurations should be tested with the belt-clips and holsters attached to the device and positioned against a flat phantom in normal use configurations. Devices with a headset output should be tested with a headset connected to the device. When multiple accessories that do not contain metallic components are supplied with the device, the device may be tested with only the accessory that dictates the closest spacing to the body. When multiple accessories that contain metallic components are supplied with the device, the device must be tested with each accessory that contains a unique metallic component. If multiple accessories share an identical metallic component (e.g., the same metallic belt-clip used with different holsters with no other metallic components), only the accessory that dictates the closest spacing to the body must be tested.

Body-worn accessories may not always be supplied or available as options for some devices that are intended to be authorized for body-worn use. A separation distance of 1.5 cm between the back of the device and a flat phantom is recommended for testing body-worn SAR compliance under such circumstances. Other separation distances may be used, but they should not exceed 2.5 cm. In these cases, the device may use body-worn accessories that provide a separation distance greater than that tested for the device provided however that the accessory contains no metallic components.

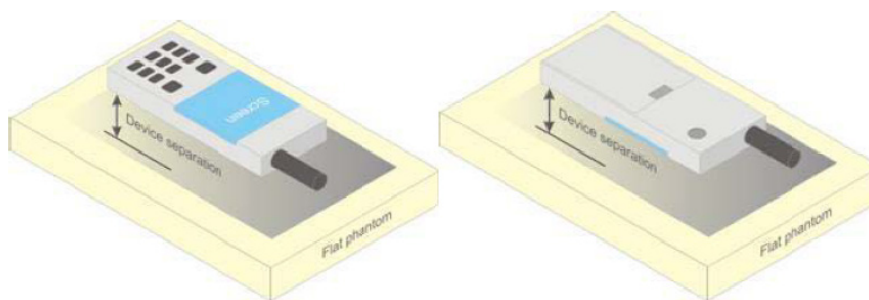

Figure 5 – Test positions for body-worn devices

Test Distance for SAR Evaluation

In this case the EUT (Equipment Under Test) is set 10mm away from the phantom, the test distance is 10mm.

SAR Evaluation Procedure

The evaluation was performed with the following procedure:

Step 1: Measurement of the SAR value at a fixed location above the ear point or central position was used as a reference value for assessing the power drop. The SAR at this point is measured at the start of the test and then again at the end of the testing.

Step 2: The SAR distribution at the exposed side of the head was measured at a distance of 4 mm from the inner surface of the shell. The area covered the entire dimension of the head or radiating structures of the EUT, the horizontal grid spacing was 15 mm x 15 mm, and the SAR distribution was determined by integrated grid of 1.5mm x 1.5mm. Based on these data, the area of the maximum absorption was determined by spline interpolation. The first Area Scan covers the entire dimension of the EUT to ensure that the hotspot was correctly identified.

Step 3: Around this point, a volume of 30 mm x 30 mm x 30 mm was assessed by measuring 7x 7 x 7 points. On the basis of this data set, the spatial peak SAR value was evaluated under the following procedure:

- 1) The data at the surface were extrapolated, since the center of the dipoles is 1.2 mm away from the tip of the probe and the distance between the surface and the lowest measuring point is 1.3 mm. The extrapolation was based on a least square algorithm. A polynomial of the fourth order was calculated through the points in z-axes. This polynomial was then used to evaluate the points between the surface and the probe tip.

- 2) The maximum Measured value was searched with a straightforward algorithm. Around this maximum the SAR values averaged over the spatial volumes (1 g or 10 g) were computed by the 3D-Spline interpolation algorithm. The 3D-Spline is composed of three one dimensional splines with the "Not a knot"-condition (in x, y and z-directions). The volume was integrated with the trapezoidal-algorithm. One thousand points (10 x 10 x 10) were Measured to calculate the averages.

All neighboring volumes were evaluated until no neighboring volume with a higher average value was found.

Step 4: Re-measurement of the SAR value at the same location as in Step 1. If the value changed by more than 5%, the evaluation was repeated.

CONDUCTED OUTPUT POWER MEASUREMENT

Test Procedure

The RF output of the transmitter was connected to the input of the Wireless Communication Test Set through Connector.

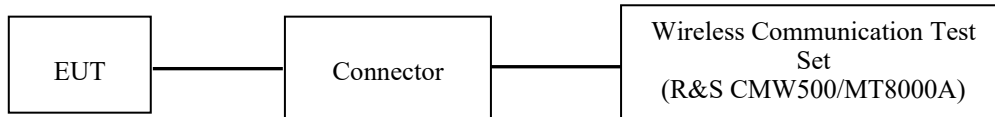

GSM/WCDMA/LTE/5G NR

The RF output of the transmitter was connected to the input port of the Pulse Power Sensor through Connector.

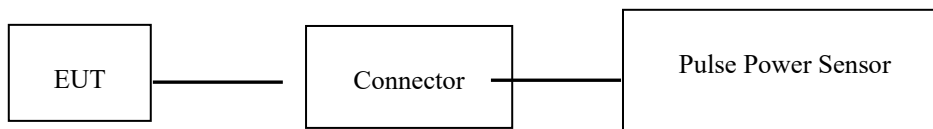

BT/WLAN

Description of Test Configuration

EUT Operation Condition:

EUT Operation Mode:	The system was configured for testing in each operation mode.
Equipment Modifications:	No
EUT Exercise Software:	No
<p>The maximum power was configured per 3GPP Standard for each operation modes as below setting:</p> <p>GSM/GPRS/EGPRS</p> <p>Function: Menu select > GSM Mobile Station > GSM 850/1900 Press Connection control to choose the different menus Press RESET > choose all the reset all settings Connection Press Signal Off to turn off the signal and change settings Network Support > GSM + GPRS or GSM + EGSM Main Service > Packet Data Service selection > Test Mode A – Auto Slot Config. off MS Signal Press Slot Config Bottom on the right twice to select and change the number of time slots and power setting > Slot configuration > Uplink/Gamma > 33 dBm for GPRS 850 > 30 dBm for GPRS 1900 > 27 dBm for EGPRS 850 > 26 dBm for EGPRS 1900 BS Signal channel Enter the same channel number for TCH channel (test channel) and BCCH Frequency Offset > + 0 Hz Mode > BCCH and TCH</p> <p>BCCH Level > -85 dBm (May need to adjust if link is not stable) BCCH Channel > choose desire test channel [Enter the same channel number for TCH channel (test channel) and BCCH channel]</p> <p>Channel Type > Off P0 > 4 dB Slot Config> Unchanged (if already set under MS signal) TCH > choose desired test channel Hopping > Off Main Timeslot > 3 Network Coding Scheme > CS4 (GPRS) and MCS5 (EGPRS)</p> <p>Bit Stream > 2E9-1 PSR Bit Stream AF/RF Enter appropriate offsets for Ext. Att. Output and Ext. Att. Input Connection Press Sign</p>	

WCDMA-Release 99

The following tests were conducted according to the test requirements outlines in section 5.2 of the 3GPP TS34.121-1 specification. The EUT has a nominal maximum output power of 24dBm (+1.7/-3.7).

WCDMA General Settings	Loopback Mode	Test Mode 1
	Rel99 RMC	12.2kbps RMC
	Power Control Algorithm	Algorithm2
	β / βd	8/15

WCDMA HSDPA

The following tests were conducted according to the test requirements outlines in section 5.2 of the 3GPP TS34.121-1 specification.

	Mode	HSDPA	HSDPA	HSDPA	HSDPA
	Subset	1	2	3	4
WCDMA General Set ings	Loopback Mode	Test Mode 1			
	Rel99 RMC	12.2kbps RMC			
	HSDPA FRC	H-Set1			
	Power Control Algorithm	Algorithm2			
	βc	2/15	12/15	15/15	15/15
	βd	1 /15	15/15	8/15	4/15
	βd (SF)	64			
	$\beta c/\beta d$	2/15	12/15	15/8	15/4
	βhs	4/15	24/15	30/15	30/15
MPR(dB)	0	0	0.5	0.5	
HSDPA Specific Settings	DACK	8			
	DNAK	8			
	DCQI	8			
	Ack-Nack repetition factor	3			
	CQI Feedback	4ms			
	CQI Repetition Factor	2			
	Ahs= $\beta hs/ \beta c$	30/15			

WCDMA HSUPA

The following tests were conducted according to the test requirements outlines in section 5.2 of the 3GPP TS34.121-1 specification.

	Mode	HSUPA	HSUPA	HSUPA	HSUPA	HSUPA
	Subset	1	2	4	5	
WCDMA General Settings	Loopback Mode	Test Mode 1				
	Rel99 RMC	12.2kbps RMC				
	HSDPA FRC	H-Set1				
	HSUPA Test	HSUPA Loopback				
	Power Control Algorithm	Algorithm2				
	β_c	11/15	6/15	15/15	2/15	15/15
	β_d	15/15	15/15	9/15	15/15	0
	β_{ec}	209/225	12/15	30 15	2/15	5/15
	β_c/β_d	11/15	6/15	15/9	2/15	-
	β_{hs}	22/15	12/15	30/15	4/15	5/15
	CM(dB)	1.0	3.0	2.0	3.0	1.0
MPR(dB)	0	2	1	2	0	
HSDPA Specific Settings	DACK	8				
	DNAK	8				
	DCQI	8				
	Ack-Nack repetition factor	3				
	CQI Feedback	4ms				
	CQI Repetition Factor	2				
	$A_{hs}=\beta_{hs}/\beta_c$	30/15				
HSUPA Specific Settings	DE-DPCCH	6	8	8	5	7
	DHARQ	0	0	0	0	0
	AG Index	20	12	15	17	21
	ETFCI	75	67	92	71	81
	Associated Max UL Data Rate k ps	242.1	174.9	482.8	205.8	308.9
	Reference E_FCIs	E-TFCI 11 E E-TFCI PO 4 E-TFCI 67 E-TFCI PO 18 E-TFCI 71 E-TFCI PO23 E-TFCI 75 E-TFCI PO26 E-TFCI 81 E-TFCI PO 27	E-TFCI 11 E-TFCI PO4 E-TFCI 92 E-TFCI PO 18	E-TFCI 11 E E-TFCI PO 4 E-TFCI 67 E-TFCI PO 18 E-TFCI 71 E-TFCI PO23 E-TFCI 75 E-TFCI PO26 E-TFCI 81 E-TFCI PO 27		

HSPA+

The following tests were conducted according to the test requirements in Table C.11.1.4 of 3GPP TS 34.121-1

Sub-test	β_c (Note3)	β_d	β_{HS} (Note1)	β_{ec}	β_{ed} (2xSF2) (Note 4)	β_{ed} (2xSF4) (Note 4)	CM (dB) (Note 2)	MPR (dB) (Note 2)	AG Index (Note 4)	E-TFCI (Note 5)	E-TFCI (boost)
1	1	0	30/15	30/15	β_{ed1} : 30/15 β_{ed2} : 30/15	β_{ed3} : 24/15 β_{ed4} : 24/15	3.5	2.5	14	105	105

- Note 1: $\Delta_{ACK}, \Delta_{NACK}$ and $\Delta_{CQI} = 30/15$ with $\beta_{hs} = 30/15 * \beta_c$.
- Note 2: CM = 3.5 and the MPR is based on the relative CM difference, MPR = MAX(CM-1,0).
- Note 3: DPDCH is not configured, therefore the β_c is set to 1 and $\beta_d = 0$ by default.
- Note 4: β_{ed} can not be set directly; it is set by Absolute Grant Value
- Note 5: All the sub-tests require the UE to transmit 2SF2+2SF4 16QAM EDCH and they apply for UE using E-DPDCH category 7. E-DCH TTI is set to 2ms TTI and E-DCH table index = 2. To support these E-DCH configurations DPDCH is not allocated. The UE is signalled to use the extrapolation algorithm.

LTE (FDD):

The following tests were conducted according to the test requirements in 3GPP TS36.101

The following tests were conducted according to the test requirements outlined in section 6.2 of the 3GPP TS36.101 specification.

UE Power Class: 3 (23 +/- 2dBm). The allowed Maximum Power Reduction (MPR) for the maximum output power due to higher order modulation and transmit bandwidth configuration (resource blocks) is specified in Table 6.2.3-1 of the 3GPP TS36.101.

Table 6.2.3-1: Maximum Power Reduction (MPR) for Power Class 3

Modulation	Channel bandwidth / Transmission bandwidth (RB)						MPR (dB)
	1.4 MHz	3.0 MHz	5 MHz	10 MHz	15 MHz	20 MHz	
QPSK	> 5	> 4	> 8	> 12	> 16	> 18	≤ 1
16 QAM	≤ 5	≤ 4	≤ 8	≤ 12	≤ 16	≤ 18	≤ 1
16 QAM	> 5	> 4	> 8	> 12	> 16	> 18	≤ 2

The allowed A-MPR values specified below in Table 6.2.4.-1 of 3GPP TS36.101 are in addition to the allowed MPR requirements. All the measurements below were performed with A-MPR disabled, by using Network Signaling Value of "NS_01".

Table 6.2.4-1: Additional Maximum Power Reduction (A-MPR)

Network Signalling value	Requirements (sub-clause)	E-UTRA Band	Channel bandwidth (MHz)	Resources Blocks (N _{RB})	A-MPR (dB)
NS_01	6.6.2.1.1	Table 5.5-1	1.4, 3, 5, 10, 15, 20	Table 5.6-1	NA
NS_03	6.6.2.2.1	2, 4, 10, 23, 25, 35, 36	3	>5	≤ 1
			5	>6	≤ 1
			10	>6	≤ 1
			15	>8	≤ 1
NS_04	6.6.2.2.2	41	20	>10	≤ 1
			5	>6	≤ 1
NS_05	6.6.3.3.1	1	10, 15, 20	≥ 50	≤ 1
NS_06	6.6.2.2.3	12, 13, 14, 17	1.4, 3, 5, 10	Table 5.6-1	n/a
NS_07	6.6.2.2.3	13	10	Table 6.2.4-2	Table 6.2.4-2
	6.6.3.3.2				
NS_08	6.6.3.3.3	19	10, 15	> 44	≤ 3
NS_09	6.6.3.3.4	21	10, 15	> 40	≤ 1
				> 55	≤ 2
NS_10		20	15, 20	Table 6.2.4-3	Table 6.2.4-3
NS_11	6.6.2.2.1	23 ¹	1.4, 3, 5, 10	Table 6.2.4-5	Table 6.2.4-5
..					
NS_32	-	-	-	-	-

Note 1: Applies to the lower block of Band 23, i.e. a carrier placed in the 2000-2010 MHz region.

TDD-LTE

P TS 36.211 section 4.2 for Type 2 Frame Structure and Table 4.2-2 for uplink-downlink configurations and Table 4.2-1 for Special subframe configurations.

Table 4.2-1: Configuration of special subframe (lengths of DwPTS/GP/UpPTS).

Special subframe configuration	Normal cyclic prefix in downlink			Extended cyclic prefix in downlink		
	DwPTS	UpPTS		DwPTS	UpPTS	
		Normal cyclic prefix in uplink	Extended cyclic prefix in uplink		Normal cyclic prefix in uplink	Extended cyclic prefix in uplink
0	$6592 \cdot T_s$	$2192 \cdot T_s$	$2560 \cdot T_s$	$7680 \cdot T_s$	$2192 \cdot T_s$	$2560 \cdot T_s$
1	$19760 \cdot T_s$			$20480 \cdot T_s$		
2	$21952 \cdot T_s$			$23040 \cdot T_s$		
3	$24144 \cdot T_s$			$25600 \cdot T_s$		
4	$26336 \cdot T_s$			$7680 \cdot T_s$		
5	$6592 \cdot T_s$	$4384 \cdot T_s$	$5120 \cdot T_s$	$20480 \cdot T_s$	$4384 \cdot T_s$	$5120 \cdot T_s$
6	$19760 \cdot T_s$			$23040 \cdot T_s$		
7	$21952 \cdot T_s$			$12800 \cdot T_s$		
8	$24144 \cdot T_s$			-		
9	$13168 \cdot T_s$			-		

Table 4.2-2: Uplink-downlink configurations.

Uplink-downlink configuration	Downlink-to-Uplink Switch-point periodicity	Subframe number									
		0	1	2	3	4	5	6	7	8	9
0	5 ms	D	S	U	U	U	D	S	U	U	U
1	5 ms	D	S	U	U	D	D	S	U	U	D
2	5 ms	D	S	U	D	D	D	S	U	D	D
3	10 ms	D	S	U	U	U	D	D	D	D	D
4	10 ms	D	S	U	U	D	D	D	D	D	D
5	10 ms	D	S	U	D	D	D	D	D	D	D
6	5 ms	D	S	U	U	U	D	S	U	U	D

Calculated Duty Cycle

Uplink-Downlink Configuration	Downlink-to-Uplink Switch-point Periodicity	Subframe Number										Calculated Duty Cycle (%)
		0	1	2	3	4	5	6	7	8	9	
0	5 ms	D	S	U	U	U	D	S	U	U	U	63.33
1	5 ms	D	S	U	U	D	D	S	U	U	D	43.33
2	5 ms	D	S	U	D	D	D	S	U	D	D	23.33
3	10 ms	D	S	U	U	U	D	D	D	D	D	31.67
4	10 ms	D	S	U	U	D	D	D	D	D	D	21.67
5	10 ms	D	S	U	D	D	D	D	D	D	D	11.67
6	5 ms	D	S	U	U	U	D	S	U	U	D	53.33

We used configuration 0 for LTE Band 38/41/42 SAR test, that is 63.33%(1:1.58)for duty cycle.
 We used configuration 3 for LTE Band 40 Lower SAR test, refer to the RF report for the duty cycle(29.99%).
 We used configuration 3 for LTE Band 40 Upper SAR test, refer to the RF report for the duty cycle(29.99%).

5G NR

The general information supported by the NR band is as following table:

Band		TDD	FDD
NR mode	SA	Yes	Yes
	NSA	Yes	Yes
Modulation	DFT-s-OFDM	PI/2 BPSK	Yes
		QPSK	Yes
		16QAM	Yes
		64QAM	Yes
		256QAM	Yes
	CP-OFDM	QPSK	Yes
		16QAM	Yes
		64QAM	Yes
		256QAM	Yes
	Duty Cycle		63.33%

For 5G NR test procedure was following step similar FCC KDB 941225 D05:

- a. For DFT-OFDM and CP-OFDM output power measurement reduction, according to 3GPP 38.101 maximum power reduction for power class 3, the CP-OFDM mode will not higher than DFT-OFDM mode, therefore, similar FCC KDB 941225 D05 procedure for other modulation output power for each RB allocation configuration is > not ½ dB higher than the same configuration in DFT-QPSK and the reported SAR for the DFT-QPSK configuration is ≤ 1.45 W/kg; CP-OFDM testing is not required.
- b. For DFT-OFDM output power measurement reduction, according to 38.101 maximum power reduction for power class 3, for PI/2 BPSK/16QAM/64QMA/256QAM and smaller bandwidth output power will spot check largest channel bandwidth worst RB configuration to ensure the PI/2 BPSK/16QAM/64QMA/256QAM and smaller bandwidth output power will not ½ dB higher than the same configuration in the largest supported bandwidth.
- c. SAR testing start with the largest SCS and largest channel bandwidth and measure SAR for QPSK with 1 RB allocation, using the RB offset and required test channel combination with the highest maximum output power for RB offsets at the upper edge, middle and lower edge of each required test channel.
- d. 50% RB allocation for QPSK SAR testing follows 1RB QPSK allocation procedure e. QPSK with 100% RB allocation, SAR is not required when the highest maximum output power for 100 % RB allocation is less than the highest maximum output power in 50% and 1 RB allocations and the highest reported SAR for 1 RB and 50% RB allocation are ≤ 0.8 W/kg. Otherwise, SAR is measured for the highest output power channel; and if the reported SAR is > 1.45 W/kg, the remaining required test channels must also be tested.
- e. QPSK with 100% RB allocation, SAR is not required when the highest maximum output power for 100 % RB allocation is less than the highest maximum output power in 50% and 1 RB allocations and the highest reported SAR for 1 RB and 50% RB allocation are ≤ 0.8 W/kg. Otherwise, SAR is measured for the highest output power channel; and if the reported SAR is > 1.45 W/kg, the remaining required test channels must also be tested.
- f. PI/2 BPSK/16QAM/64QAM/256QAM output powers according to 3GPP MPR will not ½ dB higher than the same configuration in QPSK, also reported SAR for the QPSK configuration is less than 1.45 W/kg, PI/2 BPSK/16QAM/64QAM/256QAM SAR testing are not required.
- g. Smaller SCS/bandwidth output power for each RB allocation configuration for this device will not ½ dB higher than the same configuration in the largest supported bandwidth, and the reported SAR for the largest supported bandwidth is ≤ 1.45 W/kg, smaller bandwidth SAR testing is not required for this device
- h. For 5G FR1 n77/n78 the maximum bandwidth does not support three non-overlapping channels, when a device supports overlapping channel assignment in a channel bandwidth configuration, the middle channel of the group of overlapping channels should be selected for testing.

Maximum Target Output Power

Max Target Power(dBm)			
Mode/Band	Channel		
	Low	Middle	High
GSM 850	33.4	33.4	33.4
GPRS 1 TX Slot	33.3	33.3	33.3
GPRS 2 TX Slot	32.7	32.7	32.7
GPRS 3 TX Slot	31.1	31.1	31.1
GPRS 4 TX Slot	29.9	29.9	29.9
EDGE 1 TX Slot	27.7	27.7	27.7
EDGE 2 TX Slot	26.7	26.7	26.7
EDGE 3 TX Slot	24.6	24.6	24.6
EDGE 4 TX Slot	23.6	23.6	23.6
PCS 1900	29.8	29.8	29.8
GPRS 1 TX Slot	29.8	29.8	29.8
GPRS 2 TX Slot	29.0	29.0	29.0
GPRS 3 TX Slot	27.2	27.2	27.2
GPRS 4 TX Slot	26.1	26.1	26.1
EDGE 1 TX Slot	26.0	26.0	26.0
EDGE 2 TX Slot	25.0	25.0	25.0
EDGE 3 TX Slot	22.8	22.8	22.8
EDGE 4 TX Slot	22.0	22.0	22.0
WCDMA Band 2	22.9	22.9	22.9
HSDPA	21.5	21.5	21.5
HSUPA	21.4	21.4	21.4
HSPA+	21.4	21.4	21.4
WCDMA Band 4	23.3	23.3	23.3
HSDPA	22.0	22.0	22.0
HSUPA	21.9	21.9	21.9
HSPA+	21.9	21.9	21.9
WCDMA Band 5	24.1	24.1	24.1
HSDPA	22.7	22.7	22.7
HSUPA	22.6	22.6	22.6
HSPA+	22.6	22.6	22.6
LTE Band 2	20.3	20.6	20.7
LTE Band 4	18.4	18.9	18.7
LTE Band 5	24.6	24.3	24.3
LTE Band 7	23.1	22.8	22.8
LTE Band 12	24.3	24.5	24.5
LTE Band 17	24.3	24.2	24.4
LTE Band 38	23.5	23.3	23.2
LTE Band 40 Lower	23.4	23.5	23.6
LTE Band 40 Upper	23.2	23.1	23.1
LTE Band 41	23.6	23.3	23.2
LTE Band 42	12.2	12.2	12.2
LTE Band 66	19.2	19.1	19.0

Max Target Power(dBm)			
Mode/Band	Channel		
	Low	Middle	High
5G NR n5	25.2	25.2	25.2
5G NR n7	23.2	23.2	23.2
5G NR n12	24.2	24.2	24.2
5G NR n38	24.0	24.0	24.0
5G NR n40 Lower	24.4	24.4	24.4
5G NR n40 Upper	23.4	23.4	23.4
5G NR n41	24.0	24.0	24.0
5G NR n66	21.4	21.4	21.4
5G NR n77 Lower	24.5	24.5	24.5
5G NR n77 Upper	24.2	24.2	24.2
5G NR n78 Lower	24.5	24.5	24.5
5G NR n78 Upper	24.2	24.2	24.2
Ant 12 WLAN 2.4G(802.11b)	8.9	7.5	9.8
Ant 12 WLAN 2.4G(802.11g)	10.1	9.0	11.6
Ant 12 WLAN 2.4G(802.11n20)	10.7	8.8	10.7
Ant 12 WLAN 2.4G(802.11n40)	10.9	9.6	9.9
Ant 12 WLAN 2.4G(802.11ax20)	11.6	10.8	12.7
Ant 12 WLAN 2.4G(802.11ax40)	10.2	10.8	11.1
Ant 13 WLAN 2.4G(802.11b)	11.3	11.8	11.1
Ant 13 WLAN 2.4G(802.11g)	12.4	12.8	13.0
Ant 13 WLAN 2.4G(802.11n20)	12.5	12.7	12.8
Ant 13 WLAN 2.4G(802.11n40)	13.0	13.2	12.5
Ant 13 WLAN 2.4G(802.11ax20)	12.9	14.2	14.4
Ant 13 WLAN 2.4G(802.11ax40)	12.9	13.2	12.6
Ant 13 WLAN 5.2G(802.11a)	13.5	12.9	12.8
Ant 13 WLAN 5.2G(802.11ac20)	11.1	11.0	10.7
Ant 13 WLAN 5.2G(802.11ac40)	10.7	/	10.6
Ant 13 WLAN 5.2G(802.11ac80)	/	10.5	/
Ant 13 WLAN 5.2G(802.11ax20)	11.9	11.2	11.1
Ant 13 WLAN 5.2G(802.11ax40)	11.3	/	11.3
Ant 13 WLAN 5.2G(802.11ax80)	/	11.0	/
Ant 15 WLAN 5.2G(802.11a)	14.2	14.2	14.3
Ant 15 WLAN 5.2G(802.11ac20)	11.7	11.8	11.9
Ant 15 WLAN 5.2G(802.11ac40)	11.6	/	11.8
Ant 15 WLAN 5.2G(802.11ac80)	/	11.5	/
Ant 15 WLAN 5.2G(802.11ax20)	12.4	11.8	11.5
Ant 15 WLAN 5.2G(802.11ax40)	11.6	/	11.4
Ant 15 WLAN 5.2G(802.11ax80)	/	11.0	/

Max Target Power(dBm)			
Mode/Band	Channel		
	Low	Middle	High
Ant 13 WLAN 5.8G(802.11a)	7.2	7.8	7.6
Ant 13 WLAN 5.8G(802.11ac20)	7.7	7.7	7.6
Ant 13 WLAN 5.8G(802.11ac40)	8.6	/	8.9
Ant 13 WLAN 5.8G(802.11ac80)	/	8.6	/
Ant 13 WLAN 5.8G(802.11ax20)	8.2	8.3	6.4
Ant 13 WLAN 5.8G(802.11ax40)	8.1	/	7.8
Ant 13 WLAN 5.8G(802.11ax80)	/	9.1	/
Ant 15 WLAN 5.8G(802.11a)	16.1	16.5	17.0
Ant 15 WLAN 5.8G(802.11ac20)	7.9	8.4	9.1
Ant 15 WLAN 5.8G(802.11ac40)	8.9	/	9.4
Ant 15 WLAN 5.8G(802.11ac80)	/	8.6	/
Ant 15 WLAN 5.8G(802.11ax20)	8.8	8.8	7.6
Ant 15 WLAN 5.8G(802.11ax40)	8.4	/	8.3
Ant 15 WLAN 5.8G(802.11ax80)	/	9.2	/
Bluetooth BDR/EDR	9.7	9.7	9.7
BLE	0.2	0.3	0.2

Note: The Maximum Target Power for LTE and 5G NR bands corresponds to their maximum power in QPSK modes with maximum bandwidth. Specifically for 5G NR, this refers to the DFT-s-OFDM QPSK mode.

Test Results

GSM:

Band	Channel No.	Frequency (MHz)	RF Output Power (dBm)
GSM 850	128	824.2	33.26
	190	836.6	32.93
	251	848.8	32.94
PCS 1900	512	1850.2	29.60
	661	1880	29.68
	810	1909.8	29.28

GPRS:

Band	Channel No.	Frequency (MHz)	RF Output Power (dBm)			
			1 slot	2 slots	3 slots	4 slots
GSM 850	128	824.2	33.16	32.55	30.89	29.76
	190	836.6	32.84	32.17	30.62	29.58
	251	848.8	32.83	32.47	30.92	29.58
PCS 1900	512	1850.2	29.58	28.80	26.96	25.80
	661	1880	29.56	28.84	27.03	25.95
	810	1909.8	29.25	28.49	26.79	25.75

EGPRS:

Band	Channel No.	Frequency (MHz)	RF Output Power (dBm)			
			1 slot	2 slots	3 slots	4 slots
GSM 850	128	824.2	27.54	26.33	24.48	23.46
	190	836.6	27.57	26.46	24.50	23.52
	251	848.8	27.61	26.50	24.35	23.35
PCS 1900	512	1850.2	25.65	24.58	22.55	21.54
	661	1880	25.51	24.45	22.40	21.33
	810	1909.8	25.88	24.89	22.71	21.81

For SAR, the time based average power is relevant, the difference in between depends on the duty cycle of the TDMA signal.

Number of Time slot	1	2	3	4
Duty Cycle	1:8	1:4	1:2.66	1:2
Time based Ave. power compared to slotted Ave. power	-9 dB	-6 dB	-4.25 dB	-3 dB
Crest Factor	8	4	2.66	2

The time based average power for GPRS

Band	Channel No.	Frequency (MHz)	Time based average Power (dBm)			
			1 slot	2 slot	3 slots	4 slots
GSM 850	128	824.2	24.16	26.55	26.64	26.76
	190	836.6	23.84	26.17	26.37	26.58
	251	848.8	23.83	26.47	26.67	26.58
PCS 1900	512	1850.2	20.58	22.80	22.71	22.80
	661	1880	20.56	22.84	22.78	22.95
	810	1909.8	20.25	22.49	22.54	22.75

The time based average power for EGPRS

Band	Channel No.	Frequency (MHz)	Time based average Power (dBm)			
			1 slot	2 slot	3 slots	4 slots
GSM 850	128	824.2	18.54	20.33	20.23	20.46
	190	836.6	18.57	20.46	20.25	20.52
	251	848.8	18.61	20.50	20.10	20.35
PCS 1900	512	1850.2	16.65	18.58	18.30	18.54
	661	1880	16.51	18.45	18.15	18.33
	810	1909.8	16.88	18.89	18.46	18.81

Note:

1. Rohde & Schwarz Radio Communication Tester (CMW500) was used for the measurement of GSM peak and average output power for active timeslots.
2. For GSM voice, 1 timeslot has been activated with power level 5 (850 MHz band) and 0 (1900 MHz band).
3. For GPRS, 1, 2, 3 and 4timeslots has been activated separately with power level 3(850 MHz band) and 3(1900 MHz band).

WCDMA:

Results (12.2kbps RMC)

Band	Frequency (MHz)	RF Output Power (dBm)
WCDMA Band 2	1852.4	22.47
	1880	22.59
	1907.6	22.77
WCDMA Band 4	1712.4	23.16
	1732.6	23.25
	1752.6	22.80
WCDMA Band 5	826.4	23.93
	836.6	23.91
	846.6	23.94

Results (HSDPA)

Band	Frequency (MHz)	RF Output Power (dBm)			
		Subset 1	Subset 2	Subset 3	Subset 4
WCDMA Band 2	1852.4	20.68	20.78	20.86	20.81
	1880	20.93	21.00	20.98	21.09
	1907.6	21.15	21.19	21.23	21.27
WCDMA Band 4	1712.4	21.41	21.40	21.51	21.56
	1732.6	21.68	21.72	21.80	21.80
	1752.6	21.22	21.26	21.27	21.35
WCDMA Band 5	826.4	22.31	22.40	22.44	22.47
	836.6	22.30	22.35	22.39	22.52
	846.6	22.27	22.26	22.33	22.35

Results (HSUPA)

Band	Frequency (MHz)	RF Output Power (dBm)				
		Subset 1	Subset 2	Subset 3	Subset 4	Subset 5
WCDMA Band 2	1852.4	20.61	20.71	20.75	20.74	20.79
	1880	20.55	20.66	20.62	20.77	20.77
	1907.6	21.03	21.07	21.07	21.20	21.25
WCDMA Band 4	1712.4	21.42	21.49	21.53	21.58	21.65
	1732.6	21.45	21.49	21.56	21.60	21.71
	1752.6	21.02	21.06	21.15	21.09	21.11
WCDMA Band 5	826.4	22.11	22.19	22.25	22.35	22.35
	836.6	22.10	22.10	22.19	22.26	22.33
	846.6	22.24	22.30	22.35	22.47	22.41

Results (HSPA+)

Band	Frequency (MHz)	RF Output Power (dBm)
WCDMA Band 2	1852.4	20.82
	1880	20.78
	1907.6	21.21
WCDMA Band 4	1712.4	21.79
	1732.6	21.73
	1752.6	21.25
WCDMA Band 5	826.4	22.39
	836.6	22.29
	846.6	22.53

Note:

1. The default test configuration is to measure SAR with an established radio link between the EUT and a communication test set using a 12.2 kbps RMC (reference measurement Channel) Configured in Test Loop Model 1.
2. KDB 941225 D01-Body SAR is not required for HSDPA/HSUPA /HSPA+ when the maximum average output of each RF channel is less than ¼ dB higher than measured 12.2kbps RMC or the maximum SAR for 12.2kbps RMC is < 75% of SAR limit.

LTE Band 2:

Test Bandwidth	Test Modulation	Resource Block & RB offset	Low Channel (dBm)	Middle Channel (dBm)	High Channel (dBm)
20M	QPSK	RB1#0	20.01	20.36	20.55
		RB1#50	20.07	20.43	20.51
		RB1#99	20.15	20.45	20.54
		RB50#0	19.22	19.61	19.57
		RB50#50	19.65	19.90	19.86
		RB100#0	19.10	19.36	19.36
	16-QAM	RB1#0	19.63	19.69	19.79
		RB1#50	19.61	19.74	19.80
		RB1#99	19.77	19.67	19.74
		RB50#0	17.87	18.32	18.41
		RB50#50	18.10	18.38	18.31
		RB100#0	18.03	18.33	18.35
	64-QAM	RB1#0	16.80	17.32	16.99
		RB1#50	16.97	17.41	17.24
		RB1#99	16.97	17.32	17.14
		RB50#0	16.91	17.32	17.22
		RB50#50	17.10	17.24	17.11
		RB100#0	16.99	17.23	17.15
	256-QAM	RB1#0	14.48	15.37	15.11
		RB1#50	14.71	15.30	15.13
		RB1#99	14.51	14.93	14.91
		RB50#0	14.43	15.06	15.18
		RB50#50	14.46	15.24	15.15
		RB100#0	14.56	15.10	15.03

LTE Band 4:

Test Bandwidth	Test Modulation	Resource Block & RB offset	Low Channel (dBm)	Middle Channel (dBm)	High Channel (dBm)
20M	QPSK	RB1#0	17.97	18.09	17.99
		RB1#50	17.99	18.03	17.68
		RB1#99	18.02	17.72	17.56
		RB50#0	17.10	17.13	16.83
		RB50#50	16.91	16.94	16.80
		RB100#0	17.03	17.01	16.77
	16-QAM	RB1#0	17.72	17.73	18.02
		RB1#50	17.72	17.68	17.84
		RB1#99	17.70	17.49	17.66
		RB50#0	16.43	16.50	17.38
		RB50#50	16.34	16.33	17.36
		RB100#0	16.47	16.38	17.38
	64-QAM	RB1#0	16.81	16.95	17.24
		RB1#50	16.91	17.18	16.89
		RB1#99	16.79	16.89	16.88
		RB50#0	15.73	15.79	15.65
		RB50#50	15.70	15.68	15.69
		RB100#0	15.74	15.86	15.76
	256-QAM	RB1#0	14.89	14.78	14.91
		RB1#50	14.64	14.61	14.54
		RB1#99	15.08	14.76	14.72
		RB50#0	14.54	14.50	14.54
		RB50#50	14.48	14.57	14.39
		RB100#0	14.50	14.62	14.47

LTE Band 5:

Test Bandwidth	Test Modulation	Resource Block & RB offset	Low Channel (dBm)	Middle Channel (dBm)	High Channel (dBm)
10M	QPSK	RB1#0	24.18	24.10	24.17
		RB1#25	24.07	24.03	24.01
		RB1#49	24.00	23.98	23.97
		RB25#0	23.52	23.46	23.46
		RB25#25	23.36	23.24	23.27
		RB50#0	23.11	23.14	22.98
	16-QAM	RB1#0	23.27	23.04	23.54
		RB1#25	23.26	23.07	23.46
		RB1#49	23.19	23.04	23.45
		RB25#0	22.08	22.20	22.10
		RB25#25	22.06	22.12	22.01
		RB50#0	22.08	22.06	21.94
	64-QAM	RB1#0	22.26	22.36	22.41
		RB1#25	22.67	22.48	22.02
		RB1#49	22.07	22.10	21.97
		RB25#0	21.44	21.43	21.29
		RB25#25	21.54	21.26	21.23
		RB50#0	21.41	21.36	21.33
	256-QAM	RB1#0	19.41	19.65	19.22
		RB1#25	19.80	19.27	19.47
		RB1#49	19.81	19.69	19.47
		RB25#0	19.32	19.41	19.19
		RB25#25	19.54	19.22	19.29
		RB50#0	19.40	19.41	19.31

LTE Band 7:

Test Bandwidth	Test Modulation	Resource Block & RB offset	Low Channel (dBm)	Middle Channel (dBm)	High Channel (dBm)
20M	QPSK	RB1#0	22.68	22.59	22.56
		RB1#50	22.79	22.59	22.44
		RB1#99	22.62	22.49	22.44
		RB50#0	22.26	22.15	22.10
		RB50#50	22.30	22.10	22.09
		RB100#0	21.74	21.61	21.66
	16-QAM	RB1#0	21.98	22.34	21.84
		RB1#50	22.02	22.27	21.80
		RB1#99	21.96	22.18	21.73
		RB50#0	20.70	20.69	20.59
		RB50#50	20.81	20.57	20.63
		RB100#0	20.72	20.56	20.60
	64-QAM	RB1#0	20.78	20.89	20.69
		RB1#50	20.45	20.61	20.65
		RB1#99	20.64	20.58	20.44
		RB50#0	19.49	19.03	19.44
		RB50#50	19.60	19.44	19.29
		RB100#0	19.43	19.41	19.40
	256-QAM	RB1#0	17.70	17.70	17.78
		RB1#50	17.57	17.64	17.61
		RB1#99	17.45	17.39	17.35
		RB50#0	17.31	17.41	17.30
		RB50#50	17.35	17.33	17.32
		RB100#0	17.42	17.42	17.29

LTE Band 12:

Test Bandwidth	Test Modulation	Resource Block & RB offset	Low Channel (dBm)	Middle Channel (dBm)	High Channel (dBm)
10M	QPSK	RB1#0	24.09	24.15	24.07
		RB1#25	24.17	24.09	24.06
		RB1#49	24.00	24.23	24.09
		RB25#0	23.47	23.55	23.56
		RB25#25	23.47	23.61	23.48
		RB50#0	23.43	23.50	23.45
	16-QAM	RB1#0	23.15	23.58	23.17
		RB1#25	23.14	23.53	23.17
		RB1#49	23.13	23.60	23.26
		RB25#0	22.54	22.55	22.55
		RB25#25	22.47	22.59	22.49
		RB50#0	22.44	22.45	22.43
	64-QAM	RB1#0	22.81	22.59	22.59
		RB1#25	22.71	22.41	22.26
		RB1#49	22.40	22.31	22.44
		RB25#0	21.21	21.27	21.16
		RB25#25	21.16	21.19	21.13
		RB50#0	21.20	21.24	21.22
	256-QAM	RB1#0	19.59	19.27	19.82
		RB1#25	19.63	19.39	19.24
		RB1#49	19.22	19.63	19.55
		RB25#0	19.16	19.22	19.12
		RB25#25	19.15	19.08	19.11
		RB50#0	19.21	19.21	19.15

LTE Band 17:

Test Bandwidth	Test Modulation	Resource Block & RB offset	Low Channel (dBm)	Middle Channel (dBm)	High Channel (dBm)
10M	QPSK	RB1#0	24.11	23.95	24.07
		RB1#25	23.97	24.00	24.16
		RB1#49	23.99	23.98	24.10
		RB25#0	22.98	23.06	23.00
		RB25#25	22.98	23.01	22.95
		RB50#0	23.09	23.03	23.01
	16-QAM	RB1#0	23.16	23.05	23.46
		RB1#25	23.10	23.09	23.50
		RB1#49	23.13	23.01	23.51
		RB25#0	22.54	22.62	22.54
		RB25#25	22.48	22.65	22.51
		RB50#0	22.53	22.54	22.49
	64-QAM	RB1#0	22.95	22.83	22.67
		RB1#25	22.45	22.73	22.73
		RB1#49	22.54	22.73	22.69
		RB25#0	21.64	21.67	21.62
		RB25#25	21.57	21.53	21.43
		RB50#0	21.58	21.59	21.57
	256-QAM	RB1#0	19.69	19.43	20.07
		RB1#25	19.88	19.86	19.79
		RB1#49	19.50	19.55	19.64
		RB25#0	19.55	19.54	19.45
		RB25#25	19.51	19.49	19.46
		RB50#0	19.54	19.46	19.56

LTE Band 38:

Test Bandwidth	Test Modulation	Resource Block & RB offset	Low Channel (dBm)	Middle Channel (dBm)	High Channel (dBm)
20M	QPSK	RB1#0	23.25	23.07	22.96
		RB1#50	23.19	22.99	22.86
		RB1#99	23.05	22.89	22.79
		RB50#0	22.13	22.07	21.93
		RB50#50	22.17	22.05	21.86
		RB100#0	22.20	21.96	21.93
	16-QAM	RB1#0	22.57	22.19	21.94
		RB1#50	22.54	22.06	21.94
		RB1#99	22.44	21.96	21.78
		RB50#0	21.19	20.96	20.97
		RB50#50	21.15	21.00	20.85
		RB100#0	21.14	20.97	20.91
	64-QAM	RB1#0	20.81	20.88	20.39
		RB1#50	20.73	20.48	20.32
		RB1#99	20.50	20.41	20.28
		RB50#0	19.78	19.57	19.46
		RB50#50	19.76	19.45	19.36
		RB100#0	19.72	19.47	19.35
	256-QAM	RB1#0	17.75	17.64	17.55
		RB1#50	17.73	17.39	17.28
		RB1#99	17.58	17.29	17.38
		RB50#0	17.71	17.52	17.40
		RB50#50	17.75	17.47	17.41
		RB100#0	17.63	17.44	17.28

LTE Band 40 Lower:

Test Bandwidth	Test Modulation	Resource Block & RB offset	Low Channel (dBm)	Middle Channel (dBm)	High Channel (dBm)
10M	QPSK	RB1#0	/	23.29	/
		RB1#25	/	23.26	/
		RB1#49	/	23.29	/
		RB25#0	/	22.67	/
		RB25#25	/	22.78	/
		RB50#0	/	22.59	/
	16-QAM	RB1#0	/	22.18	/
		RB1#25	/	22.14	/
		RB1#49	/	22.19	/
		RB25#0	/	21.23	/
		RB25#25	/	21.36	/
		RB50#0	/	21.28	/
	64-QAM	RB1#0	/	20.66	/
		RB1#25	/	20.58	/
		RB1#49	/	20.58	/
		RB25#0	/	19.59	/
		RB25#25	/	19.63	/
		RB50#0	/	19.70	/
	256-QAM	RB1#0	/	17.61	/
		RB1#25	/	17.57	/
		RB1#49	/	17.64	/
		RB25#0	/	17.69	/
		RB25#25	/	17.51	/
		RB50#0	/	17.63	/

LTE Band 40 Upper:

Test Bandwidth	Test Modulation	Resource Block & RB offset	Low Channel (dBm)	Middle Channel (dBm)	High Channel (dBm)
10M	QPSK	RB1#0	/	22.91	/
		RB1#25	/	22.92	/
		RB1#49	/	22.95	/
		RB25#0	/	22.45	/
		RB25#25	/	22.34	/
		RB50#0	/	22.20	/
	16-QAM	RB1#0	/	21.77	/
		RB1#25	/	21.77	/
		RB1#49	/	21.81	/
		RB25#0	/	20.94	/
		RB25#25	/	20.95	/
		RB50#0	/	20.80	/
	64-QAM	RB1#0	/	20.66	/
		RB1#25	/	20.63	/
		RB1#49	/	20.65	/
		RB25#0	/	19.68	/
		RB25#25	/	19.69	/
		RB50#0	/	19.74	/
	256-QAM	RB1#0	/	17.67	/
		RB1#25	/	17.51	/
		RB1#49	/	17.78	/
RB25#0		/	17.68	/	
RB25#25		/	17.66	/	
RB50#0		/	17.72	/	

Duty Cycle:

Operation Band	Modulation	Bandwidth	Ton (ms)	Ton+off (ms)	Duty Cycle (%)	Limit (%)
LTE Band 40 Lower	QPSK	10M	3	10.005	29.99	38
	16QAM	10M	3	10.005	29.99	38
LTE Band 40 Upper	QPSK	10M	3	10.005	29.99	38
	16QAM	10M	3	10.005	29.99	38

Note: The duty cycle is quoted from the RF report.

LTE Band 41:

Test Bandwidth	Test Modulation	Resource Block & RB offset	Low Channel (dBm)	2549.5 MHz (dBm)	Middle Channel (dBm)	2636.5 MHz (dBm)	High Channel (dBm)
20M	QPSK	RB1#0	23.30	23.24	23.10	23.00	22.86
		RB1#50	23.28	23.12	23.03	22.93	22.83
		RB1#99	23.23	23.09	22.99	22.91	22.79
		RB50#0	22.77	22.68	22.53	22.42	22.22
		RB50#50	22.79	22.70	22.59	22.44	22.23
		RB100#0	22.74	22.58	22.51	22.33	22.08
	16-QAM	RB1#0	22.36	22.30	22.17	22.12	22.06
		RB1#50	22.42	22.28	22.13	22.02	22.00
		RB1#99	22.31	22.15	21.93	22.01	22.06
		RB50#0	21.26	21.21	21.09	20.96	20.72
		RB50#50	21.38	21.19	21.06	20.88	20.67
		RB100#0	21.28	21.17	21.03	20.88	20.69
	64-QAM	RB1#0	21.09	20.76	20.53	20.62	20.62
		RB1#50	21.06	20.68	20.32	20.43	20.48
		RB1#99	20.99	20.61	20.28	20.39	20.45
		RB50#0	20.06	19.82	19.48	19.62	19.67
		RB50#50	20.16	19.79	19.48	19.59	19.74
		RB100#0	20.11	19.78	19.46	19.53	19.53
	256-QAM	RB1#0	18.27	17.91	17.54	17.55	17.56
		RB1#50	17.97	17.65	17.38	17.42	17.50
		RB1#99	17.93	17.57	17.26	17.40	17.51
		RB50#0	18.00	17.69	17.40	17.59	17.72
		RB50#50	18.12	17.74	17.43	17.44	17.50
		RB100#0	17.88	17.66	17.44	17.45	17.56

LTE Band 42:

Test Bandwidth	Test Modulation	Resource Block & RB offset	Low Channel (dBm)	Middle Channel (dBm)	High Channel (dBm)
20M	QPSK	RB1#0	11.97	11.85	11.73
		RB1#50	11.82	11.73	11.65
		RB1#99	11.79	11.80	11.78
		RB50#0	11.41	11.12	11.13
		RB50#50	11.27	11.19	11.26
		RB100#0	11.25	11.06	11.12
	16-QAM	RB1#0	10.99	10.98	10.88
		RB1#50	10.70	10.90	10.71
		RB1#99	10.79	10.99	10.91
		RB50#0	9.84	9.58	9.64
		RB50#50	9.85	9.64	9.63
		RB100#0	9.71	9.62	9.66
	64-QAM	RB1#0	9.38	9.80	9.53
		RB1#50	9.54	9.58	9.40
		RB1#99	9.31	9.80	9.56
		RB50#0	9.28	9.49	9.43
		RB50#50	9.46	9.89	9.60
		RB100#0	9.40	9.71	9.53
	256-QAM	RB1#0	7.49	7.51	7.47
		RB1#50	7.20	7.83	7.70
		RB1#99	7.34	7.49	7.75
		RB50#0	7.26	7.75	7.60
		RB50#50	7.45	7.42	7.43
		RB100#0	7.42	7.63	7.57

LTE Band 66:

Test Bandwidth	Test Modulation	Resource Block & RB offset	Low Channel (dBm)	Middle Channel (dBm)	High Channel (dBm)
20M	QPSK	RB1#0	18.98	18.95	18.84
		RB1#50	18.97	18.81	18.72
		RB1#99	18.84	18.69	18.71
		RB50#0	18.50	18.22	18.19
		RB50#50	18.29	18.18	18.17
		RB100#0	18.27	18.14	18.09
	16-QAM	RB1#0	18.55	18.28	18.08
		RB1#50	18.43	18.08	17.90
		RB1#99	18.42	18.10	17.89
		RB50#0	16.91	16.70	16.68
		RB50#50	16.76	16.67	16.55
		RB100#0	16.84	16.67	16.60
	64-QAM	RB1#0	17.01	17.07	17.27
		RB1#50	16.96	17.24	17.28
		RB1#99	17.06	17.19	17.28
		RB50#0	17.11	16.92	17.34
		RB50#50	17.27	16.97	17.23
		RB100#0	17.25	17.17	17.11
	256-QAM	RB1#0	15.16	15.24	15.18
		RB1#50	15.33	15.11	15.20
		RB1#99	15.05	14.96	15.23
		RB50#0	15.31	15.15	15.28
		RB50#50	15.28	15.15	15.03
		RB100#0	15.13	15.14	15.15

5G NR n5:

Mode	Conducted Average Power(dBm)
20MHz_15kHz_834MHz_CP-OFDM 16 QAM_RB106@0	22.41
20MHz_15kHz_834MHz_CP-OFDM 256 QAM_RB106@0	18.87
20MHz_15kHz_834MHz_CP-OFDM 64 QAM_RB106@0	21.88
20MHz_15kHz_834MHz_CP-OFDM QPSK_RB1@1	23.64
20MHz_15kHz_834MHz_CP-OFDM QPSK_RB1@104	23.23
20MHz_15kHz_834MHz_CP-OFDM QPSK_RB106@0	22.41
20MHz_15kHz_834MHz_CP-OFDM QPSK_RB53@26	23.38
20MHz_15kHz_834MHz_DFT-s- OFDM 16 QAM_RB100@0	22.91
20MHz_15kHz_834MHz_DFT-s- OFDM 256 QAM_RB100@0	20.99
20MHz_15kHz_834MHz_DFT-s- OFDM 64 QAM_RB100@0	22.36
20MHz_15kHz_834MHz_DFT-s- OFDM PI/2 BPSK_RB1@1	25.00
20MHz_15kHz_834MHz_DFT-s- OFDM PI/2 BPSK_RB1@104	24.82
20MHz_15kHz_834MHz_DFT-s- OFDM PI/2 BPSK_RB100@0	24.43
20MHz_15kHz_834MHz_DFT-s- OFDM PI/2 BPSK_RB50@25	24.93
20MHz_15kHz_834MHz_DFT-s- OFDM QPSK_RB1@1	24.91
20MHz_15kHz_834MHz_DFT-s- OFDM QPSK_RB1@104	24.82
20MHz_15kHz_834MHz_DFT-s- OFDM QPSK_RB100@0	23.99
20MHz_15kHz_834MHz_DFT-s- OFDM QPSK_RB50@25	24.96
20MHz_15kHz_836.5MHz_CP- OFDM 16 QAM_RB106@0	22.33
20MHz_15kHz_836.5MHz_CP- OFDM 256 QAM_RB106@0	18.76
20MHz_15kHz_836.5MHz_CP- OFDM 64 QAM_RB106@0	21.83
20MHz_15kHz_836.5MHz_CP- OFDM QPSK_RB1@1	23.61
20MHz_15kHz_836.5MHz_CP- OFDM QPSK_RB1@104	23.27
20MHz_15kHz_836.5MHz_CP- OFDM QPSK_RB106@0	22.35
20MHz_15kHz_836.5MHz_CP- OFDM QPSK_RB53@26	23.37
20MHz_15kHz_836.5MHz_DFT-s- OFDM 16 QAM_RB100@0	22.89
20MHz_15kHz_836.5MHz_DFT-s- OFDM 256 QAM_RB100@0	20.84
20MHz_15kHz_836.5MHz_DFT-s- OFDM 64 QAM_RB100@0	22.42
20MHz_15kHz_836.5MHz_DFT-s- OFDM PI/2 BPSK_RB1@1	24.98
20MHz_15kHz_836.5MHz_DFT-s- OFDM PI/2 BPSK_RB1@104	24.72
20MHz_15kHz_836.5MHz_DFT-s- OFDM PI/2 BPSK_RB100@0	24.37
20MHz_15kHz_836.5MHz_DFT-s- OFDM PI/2 BPSK_RB50@25	24.88
20MHz_15kHz_836.5MHz_DFT-s- OFDM QPSK_RB1@1	25.04
20MHz_15kHz_836.5MHz_DFT-s- OFDM QPSK_RB1@104	24.75
20MHz_15kHz_836.5MHz_DFT-s- OFDM QPSK_RB100@0	23.93
20MHz_15kHz_836.5MHz_DFT-s- OFDM QPSK_RB50@25	24.98
20MHz_15kHz_839MHz_CP-OFDM 16 QAM_RB106@0	22.38
20MHz_15kHz_839MHz_CP-OFDM 256 QAM_RB106@0	18.81
20MHz_15kHz_839MHz_CP-OFDM 64 QAM_RB106@0	21.81
20MHz_15kHz_839MHz_CP-OFDM QPSK_RB1@1	23.52

Mode	Conducted Average Power(dBm)
20MHz_15kHz_839MHz_CP-OFDM QPSK_RB1@104	23.77
20MHz_15kHz_839MHz_CP-OFDM QPSK_RB106@0	22.37
20MHz_15kHz_839MHz_CP-OFDM QPSK_RB53@26	23.34
20MHz_15kHz_839MHz_DFT-s- OFDM 16 QAM_RB100@0	22.90
20MHz_15kHz_839MHz_DFT-s- OFDM 256 QAM_RB100@0	20.87
20MHz_15kHz_839MHz_DFT-s- OFDM 64 QAM_RB100@0	22.37
20MHz_15kHz_839MHz_DFT-s- OFDM PI/2 BPSK_RB1@1	24.86
20MHz_15kHz_839MHz_DFT-s- OFDM PI/2 BPSK_RB1@104	24.72
20MHz_15kHz_839MHz_DFT-s- OFDM PI/2 BPSK_RB100@0	24.40
20MHz_15kHz_839MHz_DFT-s- OFDM PI/2 BPSK_RB50@25	24.92
20MHz_15kHz_839MHz_DFT-s- OFDM QPSK_RB1@1	24.83
20MHz_15kHz_839MHz_DFT-s- OFDM QPSK_RB1@104	24.67
20MHz_15kHz_839MHz_DFT-s- OFDM QPSK_RB100@0	23.95
20MHz_15kHz_839MHz_DFT-s- OFDM QPSK_RB50@25	24.97

5G NR n7:

Mode	Conducted Average Power(dBm)
20MHz_15kHz_2510MHz_CP-OFDM 16 QAM_RB106@0	20.06
20MHz_15kHz_2510MHz_CP-OFDM 256 QAM_RB106@0	16.49
20MHz_15kHz_2510MHz_CP-OFDM 64 QAM_RB106@0	19.55
20MHz_15kHz_2510MHz_CP-OFDM QPSK_RB1@1	21.61
20MHz_15kHz_2510MHz_CP-OFDM QPSK_RB1@104	21.53
20MHz_15kHz_2510MHz_CP-OFDM QPSK_RB106@0	20.05
20MHz_15kHz_2510MHz_CP-OFDM QPSK_RB53@26	21.65
20MHz_15kHz_2510MHz_DFT-s- OFDM 16 QAM_RB100@0	21.06
20MHz_15kHz_2510MHz_DFT-s- OFDM 256 QAM_RB100@0	18.54
20MHz_15kHz_2510MHz_DFT-s- OFDM 64 QAM_RB100@0	20.63
20MHz_15kHz_2510MHz_DFT-s- OFDM PI/2 BPSK_RB1@1	23.00
20MHz_15kHz_2510MHz_DFT-s- OFDM PI/2 BPSK_RB1@104	22.93
20MHz_15kHz_2510MHz_DFT-s- OFDM PI/2 BPSK_RB100@0	22.56
20MHz_15kHz_2510MHz_DFT-s- OFDM PI/2 BPSK_RB50@25	23.06
20MHz_15kHz_2510MHz_DFT-s- OFDM QPSK_RB1@1	23.10
20MHz_15kHz_2510MHz_DFT-s- OFDM QPSK_RB1@104	22.88
20MHz_15kHz_2510MHz_DFT-s- OFDM QPSK_RB100@0	22.17
20MHz_15kHz_2510MHz_DFT-s- OFDM QPSK_RB50@25	23.11
20MHz_15kHz_2535MHz_CP-OFDM 16 QAM_RB106@0	19.93
20MHz_15kHz_2535MHz_CP-OFDM 256 QAM_RB106@0	16.25
20MHz_15kHz_2535MHz_CP-OFDM 64 QAM_RB106@0	19.38
20MHz_15kHz_2535MHz_CP-OFDM QPSK_RB1@1	21.42
20MHz_15kHz_2535MHz_CP-OFDM QPSK_RB1@104	21.47
20MHz_15kHz_2535MHz_CP-OFDM QPSK_RB106@0	19.90

20MHz_15kHz_2535MHz_CP-OFDM QPSK_RB53@26	21.37
20MHz_15kHz_2535MHz_DFT-s- OFDM 16 QAM_RB100@0	20.90
20MHz_15kHz_2535MHz_DFT-s- OFDM 256 QAM_RB100@0	18.33
20MHz_15kHz_2535MHz_DFT-s- OFDM 64 QAM_RB100@0	20.34
20MHz_15kHz_2535MHz_DFT-s- OFDM PI/2 BPSK_RB1@1	22.81
20MHz_15kHz_2535MHz_DFT-s- OFDM PI/2 BPSK_RB1@104	22.81
20MHz_15kHz_2535MHz_DFT-s- OFDM PI/2 BPSK_RB100@0	22.40
20MHz_15kHz_2535MHz_DFT-s- OFDM PI/2 BPSK_RB50@25	22.87
20MHz_15kHz_2535MHz_DFT-s- OFDM QPSK_RB1@1	22.83
20MHz_15kHz_2535MHz_DFT-s- OFDM QPSK_RB1@104	22.84
20MHz_15kHz_2535MHz_DFT-s- OFDM QPSK_RB100@0	21.94
20MHz_15kHz_2535MHz_DFT-s- OFDM QPSK_RB50@25	22.98
20MHz_15kHz_2560MHz_CP-OFDM 16 QAM_RB106@0	20.02
20MHz_15kHz_2560MHz_CP-OFDM 256 QAM_RB106@0	16.40
20MHz_15kHz_2560MHz_CP-OFDM 64 QAM_RB106@0	19.46
20MHz_15kHz_2560MHz_CP-OFDM QPSK_RB1@1	21.33
20MHz_15kHz_2560MHz_CP-OFDM QPSK_RB1@104	21.59
20MHz_15kHz_2560MHz_CP-OFDM QPSK_RB106@0	19.92
20MHz_15kHz_2560MHz_CP-OFDM QPSK_RB53@26	21.36
20MHz_15kHz_2560MHz_DFT-s- OFDM 16 QAM_RB100@0	20.93
20MHz_15kHz_2560MHz_DFT-s- OFDM 256 QAM_RB100@0	18.37
20MHz_15kHz_2560MHz_DFT-s- OFDM 64 QAM_RB100@0	20.48
20MHz_15kHz_2560MHz_DFT-s- OFDM PI/2 BPSK_RB1@1	22.79
20MHz_15kHz_2560MHz_DFT-s- OFDM PI/2 BPSK_RB1@104	22.91
20MHz_15kHz_2560MHz_DFT-s- OFDM PI/2 BPSK_RB100@0	22.46
20MHz_15kHz_2560MHz_DFT-s- OFDM PI/2 BPSK_RB50@25	22.90
20MHz_15kHz_2560MHz_DFT-s- OFDM QPSK_RB1@1	22.71
20MHz_15kHz_2560MHz_DFT-s- OFDM QPSK_RB1@104	22.83
20MHz_15kHz_2560MHz_DFT-s- OFDM QPSK_RB100@0	21.93
20MHz_15kHz_2560MHz_DFT-s- OFDM QPSK_RB50@25	22.96

5G NR n12:

Mode	Conducted Average Power(dBm)
15MHz_15kHz_706.5MHz_CP- OFDM 16 QAM_RB79@0	21.44
15MHz_15kHz_706.5MHz_CP- OFDM 256 QAM_RB79@0	17.92
15MHz_15kHz_706.5MHz_CP- OFDM 64 QAM_RB79@0	21.01
15MHz_15kHz_706.5MHz_CP- OFDM QPSK_RB1@1	23.32
15MHz_15kHz_706.5MHz_CP- OFDM QPSK_RB1@77	23.17
15MHz_15kHz_706.5MHz_CP- OFDM QPSK_RB39@19	23.05
15MHz_15kHz_706.5MHz_CP- OFDM QPSK_RB79@0	21.47
15MHz_15kHz_706.5MHz_DFT-s- OFDM 16 QAM_RB75@0	22.57
15MHz_15kHz_706.5MHz_DFT-s- OFDM 256 QAM_RB75@0	20.06
15MHz_15kHz_706.5MHz_DFT-s- OFDM 64 QAM_RB75@0	22.08
15MHz_15kHz_706.5MHz_DFT-s- OFDM PI/2 BPSK_RB1@1	24.09
15MHz_15kHz_706.5MHz_DFT-s- OFDM PI/2 BPSK_RB1@77	23.94
15MHz_15kHz_706.5MHz_DFT-s- OFDM PI/2 BPSK_RB36@18	24.06
15MHz_15kHz_706.5MHz_DFT-s- OFDM PI/2 BPSK_RB75@0	23.49
15MHz_15kHz_706.5MHz_DFT-s- OFDM QPSK_RB1@1	24.11
15MHz_15kHz_706.5MHz_DFT-s- OFDM QPSK_RB1@77	23.97
15MHz_15kHz_706.5MHz_DFT-s- OFDM QPSK_RB36@18	24.10
15MHz_15kHz_706.5MHz_DFT-s- OFDM QPSK_RB75@0	23.05
15MHz_15kHz_707.5MHz_CP- OFDM 16 QAM_RB79@0	21.55
15MHz_15kHz_707.5MHz_CP- OFDM 256 QAM_RB79@0	17.95
15MHz_15kHz_707.5MHz_CP- OFDM 64 QAM_RB79@0	20.98
15MHz_15kHz_707.5MHz_CP- OFDM QPSK_RB1@1	23.19
15MHz_15kHz_707.5MHz_CP- OFDM QPSK_RB1@77	22.96
15MHz_15kHz_707.5MHz_CP- OFDM QPSK_RB39@19	23.03
15MHz_15kHz_707.5MHz_CP- OFDM QPSK_RB79@0	21.43
15MHz_15kHz_707.5MHz_DFT-s- OFDM 16 QAM_RB75@0	22.47
15MHz_15kHz_707.5MHz_DFT-s- OFDM 256 QAM_RB75@0	20.01
15MHz_15kHz_707.5MHz_DFT-s- OFDM 64 QAM_RB75@0	22.05
15MHz_15kHz_707.5MHz_DFT-s- OFDM PI/2 BPSK_RB1@1	23.97
15MHz_15kHz_707.5MHz_DFT-s- OFDM PI/2 BPSK_RB1@77	23.98
15MHz_15kHz_707.5MHz_DFT-s- OFDM PI/2 BPSK_RB36@18	24.11
15MHz_15kHz_707.5MHz_DFT-s- OFDM PI/2 BPSK_RB75@0	23.54
15MHz_15kHz_707.5MHz_DFT-s- OFDM QPSK_RB1@1	24.00
15MHz_15kHz_707.5MHz_DFT-s- OFDM QPSK_RB1@77	23.93

Mode	Conducted Average Power(dBm)
15MHz_15kHz_707.5MHz_DFT-s- OFDM QPSK_RB36@18	24.09
15MHz_15kHz_707.5MHz_DFT-s- OFDM QPSK_RB75@0	23.07
15MHz_15kHz_708.5MHz_CP- OFDM 16 QAM_RB79@0	21.52
15MHz_15kHz_708.5MHz_CP- OFDM 256 QAM_RB79@0	17.97
15MHz_15kHz_708.5MHz_CP- OFDM 64 QAM_RB79@0	21.05
15MHz_15kHz_708.5MHz_CP- OFDM QPSK_RB1@1	23.20
15MHz_15kHz_708.5MHz_CP- OFDM QPSK_RB1@77	22.99
15MHz_15kHz_708.5MHz_CP- OFDM QPSK_RB39@19	23.11
15MHz_15kHz_708.5MHz_CP- OFDM QPSK_RB79@0	21.53
15MHz_15kHz_708.5MHz_DFT-s- OFDM 16 QAM_RB75@0	22.50
15MHz_15kHz_708.5MHz_DFT-s- OFDM 256 QAM_RB75@0	19.96
15MHz_15kHz_708.5MHz_DFT-s- OFDM 64 QAM_RB75@0	22.00
15MHz_15kHz_708.5MHz_DFT-s- OFDM PI/2 BPSK_RB1@1	24.06
15MHz_15kHz_708.5MHz_DFT-s- OFDM PI/2 BPSK_RB1@77	23.90
15MHz_15kHz_708.5MHz_DFT-s- OFDM PI/2 BPSK_RB36@18	24.10
15MHz_15kHz_708.5MHz_DFT-s- OFDM PI/2 BPSK_RB75@0	23.58
15MHz_15kHz_708.5MHz_DFT-s- OFDM QPSK_RB1@1	23.95
15MHz_15kHz_708.5MHz_DFT-s- OFDM QPSK_RB1@77	23.83
15MHz_15kHz_708.5MHz_DFT-s- OFDM QPSK_RB36@18	24.05
15MHz_15kHz_708.5MHz_DFT-s- OFDM QPSK_RB75@0	23.06

5G NR n38:

Mode	Conducted Average Power(dBm)
40MHz_30kHz_2590MHz_CP- OFDM 16 QAM_RB106@0	20.59
40MHz_30kHz_2590MHz_CP- OFDM 256 QAM_RB106@0	16.99
40MHz_30kHz_2590MHz_CP- OFDM 64 QAM_RB106@0	19.92
40MHz_30kHz_2590MHz_CP- OFDM QPSK_RB1@1	22.04
40MHz_30kHz_2590MHz_CP- OFDM QPSK_RB1@104	21.90
40MHz_30kHz_2590MHz_CP- OFDM QPSK_RB106@0	20.45
40MHz_30kHz_2590MHz_CP- OFDM QPSK_RB53@26	22.03
40MHz_30kHz_2590MHz_DFT-s- OFDM 16 QAM_RB100@0	21.48
40MHz_30kHz_2590MHz_DFT-s- OFDM 256 QAM_RB100@0	18.91
40MHz_30kHz_2590MHz_DFT-s- OFDM 64 QAM_RB100@0	21.06
40MHz_30kHz_2590MHz_DFT-s- OFDM PI/2 BPSK_RB1@1	23.39
40MHz_30kHz_2590MHz_DFT-s- OFDM PI/2 BPSK_RB1@104	23.46
40MHz_30kHz_2590MHz_DFT-s- OFDM PI/2 BPSK_RB100@0	23.03
40MHz_30kHz_2590MHz_DFT-s- OFDM PI/2 BPSK_RB50@25	23.58
40MHz_30kHz_2590MHz_DFT-s- OFDM QPSK_RB1@1	23.41
40MHz_30kHz_2590MHz_DFT-s- OFDM QPSK_RB1@104	23.48
40MHz_30kHz_2590MHz_DFT-s- OFDM QPSK_RB100@0	22.43
40MHz_30kHz_2590MHz_DFT-s- OFDM QPSK_RB50@25	23.55
40MHz_30kHz_2595MHz_CP- OFDM 16 QAM_RB106@0	20.49
40MHz_30kHz_2595MHz_CP- OFDM 256 QAM_RB106@0	16.85
40MHz_30kHz_2595MHz_CP- OFDM 64 QAM_RB106@0	20.01
40MHz_30kHz_2595MHz_CP- OFDM QPSK_RB1@1	21.87
40MHz_30kHz_2595MHz_CP- OFDM QPSK_RB1@104	22.02
40MHz_30kHz_2595MHz_CP- OFDM QPSK_RB106@0	20.44
40MHz_30kHz_2595MHz_CP- OFDM QPSK_RB53@26	22.03
40MHz_30kHz_2595MHz_DFT-s- OFDM 16 QAM_RB100@0	21.49
40MHz_30kHz_2595MHz_DFT-s- OFDM 256 QAM_RB100@0	18.96
40MHz_30kHz_2595MHz_DFT-s- OFDM 64 QAM_RB100@0	21.08
40MHz_30kHz_2595MHz_DFT-s- OFDM PI/2 BPSK_RB1@1	23.38
40MHz_30kHz_2595MHz_DFT-s- OFDM PI/2 BPSK_RB1@104	23.49
40MHz_30kHz_2595MHz_DFT-s- OFDM PI/2 BPSK_RB100@0	23.01
40MHz_30kHz_2595MHz_DFT-s- OFDM PI/2 BPSK_RB50@25	23.61
40MHz_30kHz_2595MHz_DFT-s- OFDM QPSK_RB1@1	23.71
40MHz_30kHz_2595MHz_DFT-s- OFDM QPSK_RB1@104	23.52
40MHz_30kHz_2595MHz_DFT-s- OFDM QPSK_RB100@0	22.46
40MHz_30kHz_2595MHz_DFT-s- OFDM QPSK_RB50@25	23.59
40MHz_30kHz_2600MHz_CP- OFDM 16 QAM_RB106@0	20.51
40MHz_30kHz_2600MHz_CP- OFDM 256 QAM_RB106@0	16.97
40MHz_30kHz_2600MHz_CP- OFDM 64 QAM_RB106@0	20.05
40MHz_30kHz_2600MHz_CP- OFDM QPSK_RB1@1	21.94
40MHz_30kHz_2600MHz_CP- OFDM QPSK_RB1@104	22.19
40MHz_30kHz_2600MHz_CP- OFDM QPSK_RB106@0	20.55
40MHz_30kHz_2600MHz_CP- OFDM QPSK_RB53@26	22.08

40MHz_30kHz_2600MHz_DFT-s- OFDM 16 QAM_RB100@0	21.55
40MHz_30kHz_2600MHz_DFT-s- OFDM 256 QAM_RB100@0	19.00
40MHz_30kHz_2600MHz_DFT-s- OFDM 64 QAM_RB100@0	20.99
40MHz_30kHz_2600MHz_DFT-s- OFDM PI/2 BPSK_RB1@1	23.44
40MHz_30kHz_2600MHz_DFT-s- OFDM PI/2 BPSK_RB1@104	23.60
40MHz_30kHz_2600MHz_DFT-s- OFDM PI/2 BPSK_RB100@0	23.01
40MHz_30kHz_2600MHz_DFT-s- OFDM PI/2 BPSK_RB50@25	23.59
40MHz_30kHz_2600MHz_DFT-s- OFDM QPSK_RB1@1	23.47
40MHz_30kHz_2600MHz_DFT-s- OFDM QPSK_RB1@104	23.62
40MHz_30kHz_2600MHz_DFT-s- OFDM QPSK_RB100@0	22.51
40MHz_30kHz_2600MHz_DFT-s- OFDM QPSK_RB50@25	23.60

5G NR n40 Lower:

Mode	Conducted Average Power(dBm)
10MHz_30kHz_2310MHz_CP-OFDM 16 QAM_RB24@0	20.97
10MHz_30kHz_2310MHz_CP-OFDM 256 QAM_RB24@0	17.47
10MHz_30kHz_2310MHz_CP-OFDM 64 QAM_RB24@0	20.43
10MHz_30kHz_2310MHz_CP-OFDM QPSK_RB1@1	22.34
10MHz_30kHz_2310MHz_CP-OFDM QPSK_RB1@22	22.58
10MHz_30kHz_2310MHz_CP-OFDM QPSK_RB12@6	22.42
10MHz_30kHz_2310MHz_CP-OFDM QPSK_RB24@0	20.96
10MHz_30kHz_2310MHz_DFT-s- OFDM 16 QAM_RB24@0	21.99
10MHz_30kHz_2310MHz_DFT-s- OFDM 256 QAM_RB24@0	19.42
10MHz_30kHz_2310MHz_DFT-s- OFDM 64 QAM_RB24@0	21.56
10MHz_30kHz_2310MHz_DFT-s- OFDM PI/2 BPSK_RB1@1	23.89
10MHz_30kHz_2310MHz_DFT-s- OFDM PI/2 BPSK_RB1@22	23.97
10MHz_30kHz_2310MHz_DFT-s- OFDM PI/2 BPSK_RB12@6	24.01
10MHz_30kHz_2310MHz_DFT-s- OFDM PI/2 BPSK_RB24@0	23.48
10MHz_30kHz_2310MHz_DFT-s- OFDM QPSK_RB1@1	24.28
10MHz_30kHz_2310MHz_DFT-s- OFDM QPSK_RB1@22	24.12
10MHz_30kHz_2310MHz_DFT-s- OFDM QPSK_RB12@6	24.16
10MHz_30kHz_2310MHz_DFT-s- OFDM QPSK_RB24@0	23.00

5G NR n40 Upper:

Mode	Conducted Average Power(dBm)
10MHz_30kHz_2355MHz_CP-OFDM 16 QAM_RB24@0	20.15
10MHz_30kHz_2355MHz_CP-OFDM 256 QAM_RB24@0	16.61
10MHz_30kHz_2355MHz_CP-OFDM 64 QAM_RB24@0	19.55
10MHz_30kHz_2355MHz_CP-OFDM QPSK_RB1@1	21.71
10MHz_30kHz_2355MHz_CP-OFDM QPSK_RB1@22	21.35
10MHz_30kHz_2355MHz_CP-OFDM QPSK_RB12@6	21.65
10MHz_30kHz_2355MHz_CP-OFDM QPSK_RB24@0	20.12
10MHz_30kHz_2355MHz_DFT-s- OFDM 16 QAM_RB24@0	21.16
10MHz_30kHz_2355MHz_DFT-s- OFDM 256 QAM_RB24@0	18.51
10MHz_30kHz_2355MHz_DFT-s- OFDM 64 QAM_RB24@0	20.53
10MHz_30kHz_2355MHz_DFT-s- OFDM PI/2 BPSK_RB1@1	23.11
10MHz_30kHz_2355MHz_DFT-s- OFDM PI/2 BPSK_RB1@22	22.97
10MHz_30kHz_2355MHz_DFT-s- OFDM PI/2 BPSK_RB12@6	23.11
10MHz_30kHz_2355MHz_DFT-s- OFDM PI/2 BPSK_RB24@0	22.61
10MHz_30kHz_2355MHz_DFT-s- OFDM QPSK_RB1@1	23.07
10MHz_30kHz_2355MHz_DFT-s- OFDM QPSK_RB1@22	23.17
10MHz_30kHz_2355MHz_DFT-s- OFDM QPSK_RB12@6	23.11
10MHz_30kHz_2355MHz_DFT-s- OFDM QPSK_RB24@0	22.06

Duty Cycle:

Operation Band	Bandwidth	Ton (ms)	Ton + off (ms)	Duty Cycle (%)
5G NR n40 Lower	10M	1	5.005	19.98
5G NR n40 Upper	10M	1	5.005	19.98

Note: The duty cycle is quoted from the RF report.

5G NR n41:

Mode	Conducted Average Power(dBm)
100MHz_30kHz_2546.01MHz_CP- OFDM 16 QAM_RB273@0	20.18
100MHz_30kHz_2546.01MHz_CP- OFDM 256 QAM_RB273@0	16.57
100MHz_30kHz_2546.01MHz_CP- OFDM 64 QAM_RB273@0	19.62
100MHz_30kHz_2546.01MHz_CP- OFDM QPSK_RB1@1	21.72
100MHz_30kHz_2546.01MHz_CP- OFDM QPSK_RB1@271	21.62
100MHz_30kHz_2546.01MHz_CP- OFDM QPSK_RB137@68	21.57
100MHz_30kHz_2546.01MHz_CP- OFDM QPSK_RB273@0	20.21
100MHz_30kHz_2546.01MHz_DFT-s- OFDM 16 QAM_RB270@0	21.17
100MHz_30kHz_2546.01MHz_DFT-s- OFDM 256 QAM_RB270@0	18.57
100MHz_30kHz_2546.01MHz_DFT-s- OFDM 64 QAM_RB270@0	20.63
100MHz_30kHz_2546.01MHz_DFT-s- OFDM PI/2 BPSK_RB1@1	23.30
100MHz_30kHz_2546.01MHz_DFT-s- OFDM PI/2 BPSK_RB1@271	23.24
100MHz_30kHz_2546.01MHz_DFT-s- OFDM PI/2 BPSK_RB135@67	23.09
100MHz_30kHz_2546.01MHz_DFT-s- OFDM PI/2 BPSK_RB270@0	22.71
100MHz_30kHz_2546.01MHz_DFT-s- OFDM QPSK_RB1@1	23.23
100MHz_30kHz_2546.01MHz_DFT-s- OFDM QPSK_RB1@271	23.17
100MHz_30kHz_2546.01MHz_DFT-s- OFDM QPSK_RB135@67	23.04
100MHz_30kHz_2546.01MHz_DFT-s- OFDM QPSK_RB270@0	22.25
100MHz_30kHz_2592.99MHz_CP- OFDM 16 QAM_RB273@0	20.07
100MHz_30kHz_2592.99MHz_CP- OFDM 256 QAM_RB273@0	16.42
100MHz_30kHz_2592.99MHz_CP- OFDM 64 QAM_RB273@0	19.45
100MHz_30kHz_2592.99MHz_CP- OFDM QPSK_RB1@1	21.18
100MHz_30kHz_2592.99MHz_CP- OFDM QPSK_RB1@271	22.04
100MHz_30kHz_2592.99MHz_CP- OFDM QPSK_RB137@68	21.69
100MHz_30kHz_2592.99MHz_CP- OFDM QPSK_RB273@0	20.05
100MHz_30kHz_2592.99MHz_DFT-s- OFDM 16 QAM_RB270@0	21.03
100MHz_30kHz_2592.99MHz_DFT-s- OFDM 256 QAM_RB270@0	18.44
100MHz_30kHz_2592.99MHz_DFT-s- OFDM 64 QAM_RB270@0	20.49
100MHz_30kHz_2592.99MHz_DFT-s- OFDM PI/2 BPSK_RB1@1	22.69
100MHz_30kHz_2592.99MHz_DFT-s- OFDM PI/2 BPSK_RB1@271	23.45
100MHz_30kHz_2592.99MHz_DFT-s- OFDM PI/2 BPSK_RB135@67	23.18
100MHz_30kHz_2592.99MHz_DFT-s- OFDM PI/2 BPSK_RB270@0	22.55
100MHz_30kHz_2592.99MHz_DFT-s- OFDM QPSK_RB1@1	22.76
100MHz_30kHz_2592.99MHz_DFT-s- OFDM QPSK_RB1@271	23.79
100MHz_30kHz_2592.99MHz_DFT-s- OFDM QPSK_RB135@67	23.56
100MHz_30kHz_2592.99MHz_DFT-s- OFDM QPSK_RB270@0	22.04
100MHz_30kHz_2640MHz_CP- OFDM 16 QAM_RB273@0	20.34
100MHz_30kHz_2640MHz_CP- OFDM 256 QAM_RB273@0	16.66
100MHz_30kHz_2640MHz_CP- OFDM 64 QAM_RB273@0	19.70
100MHz_30kHz_2640MHz_CP- OFDM QPSK_RB1@1	21.36
100MHz_30kHz_2640MHz_CP- OFDM QPSK_RB1@271	22.41
100MHz_30kHz_2640MHz_CP- OFDM QPSK_RB137@68	21.84

100MHz_30kHz_2640MHz_CP- OFDM QPSK_RB273@0	20.19
100MHz_30kHz_2640MHz_DFT-s- OFDM 16 QAM_RB270@0	21.25
100MHz_30kHz_2640MHz_DFT-s- OFDM 256 QAM_RB270@0	18.79
100MHz_30kHz_2640MHz_DFT-s- OFDM 64 QAM_RB270@0	20.76
100MHz_30kHz_2640MHz_DFT-s- OFDM PI/2 BPSK_RB1@1	22.87
100MHz_30kHz_2640MHz_DFT-s- OFDM PI/2 BPSK_RB1@271	23.81
100MHz_30kHz_2640MHz_DFT-s- OFDM PI/2 BPSK_RB135@67	23.42
100MHz_30kHz_2640MHz_DFT-s- OFDM PI/2 BPSK_RB270@0	22.79
100MHz_30kHz_2640MHz_DFT-s- OFDM QPSK_RB1@1	22.83
100MHz_30kHz_2640MHz_DFT-s- OFDM QPSK_RB1@271	23.84
100MHz_30kHz_2640MHz_DFT-s- OFDM QPSK_RB135@67	23.32
100MHz_30kHz_2640MHz_DFT-s- OFDM QPSK_RB270@0	22.27

5G NR n66:

Mode	Conducted Average Power(dBm)
40MHz_15kHz_1730MHz_CP- OFDM 16 QAM_RB216@0	18.12
40MHz_15kHz_1730MHz_CP- OFDM 256 QAM_RB216@0	14.53
40MHz_15kHz_1730MHz_CP- OFDM 64 QAM_RB216@0	17.62
40MHz_15kHz_1730MHz_CP- OFDM QPSK_RB1@1	19.42
40MHz_15kHz_1730MHz_CP- OFDM QPSK_RB1@214	19.73
40MHz_15kHz_1730MHz_CP- OFDM QPSK_RB108@54	19.60
40MHz_15kHz_1730MHz_CP- OFDM QPSK_RB216@0	18.12
40MHz_15kHz_1730MHz_DFT-s- OFDM 16 QAM_RB216@0	19.23
40MHz_15kHz_1730MHz_DFT-s- OFDM 256 QAM_RB216@0	16.60
40MHz_15kHz_1730MHz_DFT-s- OFDM 64 QAM_RB216@0	18.60
40MHz_15kHz_1730MHz_DFT-s- OFDM PI/2 BPSK_RB1@1	20.93
40MHz_15kHz_1730MHz_DFT-s- OFDM PI/2 BPSK_RB1@214	21.31
40MHz_15kHz_1730MHz_DFT-s- OFDM PI/2 BPSK_RB108@54	21.16
40MHz_15kHz_1730MHz_DFT-s- OFDM PI/2 BPSK_RB216@0	20.71
40MHz_15kHz_1730MHz_DFT-s- OFDM QPSK_RB1@1	20.91
40MHz_15kHz_1730MHz_DFT-s- OFDM QPSK_RB1@214	21.30
40MHz_15kHz_1730MHz_DFT-s- OFDM QPSK_RB108@54	21.11
40MHz_15kHz_1730MHz_DFT-s- OFDM QPSK_RB216@0	20.19
40MHz_15kHz_1745MHz_CP- OFDM 16 QAM_RB216@0	18.01
40MHz_15kHz_1745MHz_CP- OFDM 256 QAM_RB216@0	14.51
40MHz_15kHz_1745MHz_CP- OFDM 64 QAM_RB216@0	17.50
40MHz_15kHz_1745MHz_CP- OFDM QPSK_RB1@1	19.56
40MHz_15kHz_1745MHz_CP- OFDM QPSK_RB1@214	19.77
40MHz_15kHz_1745MHz_CP- OFDM QPSK_RB108@54	19.70
40MHz_15kHz_1745MHz_CP- OFDM QPSK_RB216@0	17.96
40MHz_15kHz_1745MHz_DFT-s- OFDM 16 QAM_RB216@0	19.02
40MHz_15kHz_1745MHz_DFT-s- OFDM 256 QAM_RB216@0	16.51
40MHz_15kHz_1745MHz_DFT-s- OFDM 64 QAM_RB216@0	18.50
40MHz_15kHz_1745MHz_DFT-s- OFDM PI/2 BPSK_RB1@1	21.04
40MHz_15kHz_1745MHz_DFT-s- OFDM PI/2 BPSK_RB1@214	21.19
40MHz_15kHz_1745MHz_DFT-s- OFDM PI/2 BPSK_RB108@54	21.16
40MHz_15kHz_1745MHz_DFT-s- OFDM PI/2 BPSK_RB216@0	20.51
40MHz_15kHz_1745MHz_DFT-s- OFDM QPSK_RB1@1	20.94
40MHz_15kHz_1745MHz_DFT-s- OFDM QPSK_RB1@214	21.09
40MHz_15kHz_1745MHz_DFT-s- OFDM QPSK_RB108@54	21.13
40MHz_15kHz_1745MHz_DFT-s- OFDM QPSK_RB216@0	20.02
40MHz_15kHz_1760MHz_CP- OFDM 16 QAM_RB216@0	18.18
40MHz_15kHz_1760MHz_CP- OFDM 256 QAM_RB216@0	14.59
40MHz_15kHz_1760MHz_CP- OFDM 64 QAM_RB216@0	17.69
40MHz_15kHz_1760MHz_CP- OFDM QPSK_RB1@1	19.48
40MHz_15kHz_1760MHz_CP- OFDM QPSK_RB1@214	19.84
40MHz_15kHz_1760MHz_CP- OFDM QPSK_RB108@54	19.69
40MHz_15kHz_1760MHz_CP- OFDM QPSK_RB216@0	18.17

40MHz_15kHz_1760MHz_DFT-s- OFDM 16 QAM_RB216@0	19.15
40MHz_15kHz_1760MHz_DFT-s- OFDM 256 QAM_RB216@0	16.72
40MHz_15kHz_1760MHz_DFT-s- OFDM 64 QAM_RB216@0	18.76
40MHz_15kHz_1760MHz_DFT-s- OFDM PI/2 BPSK_RB1@1	21.09
40MHz_15kHz_1760MHz_DFT-s- OFDM PI/2 BPSK_RB1@214	21.24
40MHz_15kHz_1760MHz_DFT-s- OFDM PI/2 BPSK_RB108@54	21.20
40MHz_15kHz_1760MHz_DFT-s- OFDM PI/2 BPSK_RB216@0	20.76
40MHz_15kHz_1760MHz_DFT-s- OFDM QPSK_RB1@1	21.09
40MHz_15kHz_1760MHz_DFT-s- OFDM QPSK_RB1@214	21.31
40MHz_15kHz_1760MHz_DFT-s- OFDM QPSK_RB108@54	21.22
40MHz_15kHz_1760MHz_DFT-s- OFDM QPSK_RB216@0	20.19

5G NR n77 Lower:

Mode	Conducted Average Power(dBm)
100MHz_30kHz_3500MHz_CP- OFDM 16 QAM_RB273@0	19.94
100MHz_30kHz_3500MHz_CP- OFDM 256 QAM_RB273@0	16.43
100MHz_30kHz_3500MHz_CP- OFDM 64 QAM_RB273@0	19.44
100MHz_30kHz_3500MHz_CP- OFDM QPSK_RB1@1	21.40
100MHz_30kHz_3500MHz_CP- OFDM QPSK_RB1@271	21.41
100MHz_30kHz_3500MHz_CP- OFDM QPSK_RB137@68	21.58
100MHz_30kHz_3500MHz_CP- OFDM QPSK_RB273@0	19.99
100MHz_30kHz_3500MHz_DFT-s- OFDM 16 QAM_RB270@0	21.06
100MHz_30kHz_3500MHz_DFT-s- OFDM 256 QAM_RB270@0	18.44
100MHz_30kHz_3500MHz_DFT-s- OFDM 64 QAM_RB270@0	20.50
100MHz_30kHz_3500MHz_DFT-s- OFDM PI/2 BPSK_RB1@1	23.03
100MHz_30kHz_3500MHz_DFT-s- OFDM PI/2 BPSK_RB1@271	22.97
100MHz_30kHz_3500MHz_DFT-s- OFDM PI/2 BPSK_RB135@67	23.09
100MHz_30kHz_3500MHz_DFT-s- OFDM PI/2 BPSK_RB270@0	22.61
100MHz_30kHz_3500MHz_DFT-s- OFDM QPSK_RB1@1	24.11
100MHz_30kHz_3500MHz_DFT-s- OFDM QPSK_RB1@271	24.01
100MHz_30kHz_3500MHz_DFT-s- OFDM QPSK_RB135@67	24.30
100MHz_30kHz_3500MHz_DFT-s- OFDM QPSK_RB270@0	23.04

5G NR n77 Upper:

Mode	Conducted Average Power(dBm)
100MHz_30kHz_3750MHz_CP- OFDM 16 QAM_RB273@0	20.68
100MHz_30kHz_3750MHz_CP- OFDM 256 QAM_RB273@0	17.10
100MHz_30kHz_3750MHz_CP- OFDM 64 QAM_RB273@0	20.20
100MHz_30kHz_3750MHz_CP- OFDM QPSK_RB1@1	22.27
100MHz_30kHz_3750MHz_CP- OFDM QPSK_RB1@271	22.24
100MHz_30kHz_3750MHz_CP- OFDM QPSK_RB137@68	22.23
100MHz_30kHz_3750MHz_CP- OFDM QPSK_RB273@0	20.68
100MHz_30kHz_3750MHz_DFT-s- OFDM 16 QAM_RB270@0	21.69
100MHz_30kHz_3750MHz_DFT-s- OFDM 256 QAM_RB270@0	19.20
100MHz_30kHz_3750MHz_DFT-s- OFDM 64 QAM_RB270@0	21.22
100MHz_30kHz_3750MHz_DFT-s- OFDM PI2 BPSK_RB1@1	23.63
100MHz_30kHz_3750MHz_DFT-s- OFDM PI2 BPSK_RB1@271	23.74
100MHz_30kHz_3750MHz_DFT-s- OFDM PI2 BPSK_RB135@67	23.73
100MHz_30kHz_3750MHz_DFT-s- OFDM PI2 BPSK_RB270@0	23.20
100MHz_30kHz_3750MHz_DFT-s- OFDM QPSK_RB1@1	23.63
100MHz_30kHz_3750MHz_DFT-s- OFDM QPSK_RB1@271	23.68
100MHz_30kHz_3750MHz_DFT-s- OFDM QPSK_RB135@67	23.74
100MHz_30kHz_3750MHz_DFT-s- OFDM QPSK_RB270@0	22.72
100MHz_30kHz_3840MHz_CP- OFDM 16 QAM_RB273@0	20.70
100MHz_30kHz_3840MHz_CP- OFDM 256 QAM_RB273@0	17.17
100MHz_30kHz_3840MHz_CP- OFDM 64 QAM_RB273@0	20.24
100MHz_30kHz_3840MHz_CP- OFDM QPSK_RB1@1	22.21
100MHz_30kHz_3840MHz_CP- OFDM QPSK_RB1@271	22.27
100MHz_30kHz_3840MHz_CP- OFDM QPSK_RB137@68	22.16
100MHz_30kHz_3840MHz_CP- OFDM QPSK_RB273@0	20.65
100MHz_30kHz_3840MHz_DFT-s- OFDM 16 QAM_RB270@0	21.74
100MHz_30kHz_3840MHz_DFT-s- OFDM 256 QAM_RB270@0	19.13
100MHz_30kHz_3840MHz_DFT-s- OFDM 64 QAM_RB270@0	21.25
100MHz_30kHz_3840MHz_DFT-s- OFDM PI2 BPSK_RB1@1	23.62
100MHz_30kHz_3840MHz_DFT-s- OFDM PI2 BPSK_RB1@271	23.66
100MHz_30kHz_3840MHz_DFT-s- OFDM PI2 BPSK_RB135@67	23.70
100MHz_30kHz_3840MHz_DFT-s- OFDM PI2 BPSK_RB270@0	23.30
100MHz_30kHz_3840MHz_DFT-s- OFDM QPSK_RB1@1	23.59
100MHz_30kHz_3840MHz_DFT-s- OFDM QPSK_RB1@271	23.71
100MHz_30kHz_3840MHz_DFT-s- OFDM QPSK_RB135@67	23.70
100MHz_30kHz_3840MHz_DFT-s- OFDM QPSK_RB270@0	22.77
100MHz_30kHz_3930MHz_CP- OFDM 16 QAM_RB273@0	20.54
100MHz_30kHz_3930MHz_CP- OFDM 256 QAM_RB273@0	16.88
100MHz_30kHz_3930MHz_CP- OFDM 64 QAM_RB273@0	20.03

Mode	Conducted Average Power(dBm)
100MHz_30kHz_3930MHz_CP- OFDM QPSK_RB1@1	21.99
100MHz_30kHz_3930MHz_CP- OFDM QPSK_RB1@271	22.30
100MHz_30kHz_3930MHz_CP- OFDM QPSK_RB137@68	22.00
100MHz_30kHz_3930MHz_CP- OFDM QPSK_RB273@0	20.41
100MHz_30kHz_3930MHz_DFT-s- OFDM 16 QAM_RB270@0	21.49
100MHz_30kHz_3930MHz_DFT-s- OFDM 256 QAM_RB270@0	19.03
100MHz_30kHz_3930MHz_DFT-s- OFDM 64 QAM_RB270@0	20.99
100MHz_30kHz_3930MHz_DFT-s- OFDM PI2 BPSK_RB1@1	23.32
100MHz_30kHz_3930MHz_DFT-s- OFDM PI2 BPSK_RB1@271	23.60
100MHz_30kHz_3930MHz_DFT-s- OFDM PI2 BPSK_RB135@67	23.54
100MHz_30kHz_3930MHz_DFT-s- OFDM PI2 BPSK_RB270@0	22.99
100MHz_30kHz_3930MHz_DFT-s- OFDM QPSK_RB1@1	23.31
100MHz_30kHz_3930MHz_DFT-s- OFDM QPSK_RB1@271	23.46
100MHz_30kHz_3930MHz_DFT-s- OFDM QPSK_RB135@67	23.48
100MHz_30kHz_3930MHz_DFT-s- OFDM QPSK_RB270@0	22.53

5G NR n78 Lower:

Mode	Conducted Average Power(dBm)
100MHz_30kHz_3500MHz_CP- OFDM 16 QAM_RB273@0	20.62
100MHz_30kHz_3500MHz_CP- OFDM 256 QAM_RB273@0	17.13
100MHz_30kHz_3500MHz_CP- OFDM 64 QAM_RB273@0	20.13
100MHz_30kHz_3500MHz_CP- OFDM QPSK_RB1@1	20.49
100MHz_30kHz_3500MHz_CP- OFDM QPSK_RB1@271	21.97
100MHz_30kHz_3500MHz_CP- OFDM QPSK_RB137@68	22.25
100MHz_30kHz_3500MHz_CP- OFDM QPSK_RB273@0	20.68
100MHz_30kHz_3500MHz_DFT-s- OFDM 16 QAM_RB270@0	21.56
100MHz_30kHz_3500MHz_DFT-s- OFDM 256 QAM_RB270@0	19.05
100MHz_30kHz_3500MHz_DFT-s- OFDM 64 QAM_RB270@0	21.11
100MHz_30kHz_3500MHz_DFT-s- OFDM PI2 BPSK_RB1@1	23.41
100MHz_30kHz_3500MHz_DFT-s- OFDM PI2 BPSK_RB1@271	23.38
100MHz_30kHz_3500MHz_DFT-s- OFDM PI2 BPSK_RB135@67	23.57
100MHz_30kHz_3500MHz_DFT-s- OFDM PI2 BPSK_RB270@0	23.11
100MHz_30kHz_3500MHz_DFT-s- OFDM QPSK_RB1@1	23.51
100MHz_30kHz_3500MHz_DFT-s- OFDM QPSK_RB1@271	23.42
100MHz_30kHz_3500MHz_DFT-s- OFDM QPSK_RB135@67	23.71
100MHz_30kHz_3500MHz_DFT-s- OFDM QPSK_RB270@0	22.61

5G NR n78 Upper:

Mode	Conducted Average Power(dBm)
100MHz_30kHz_3750MHz_CP- OFDM 16 QAM_RB273@0	20.92
100MHz_30kHz_3750MHz_CP- OFDM 256 QAM_RB273@0	17.30
100MHz_30kHz_3750MHz_CP- OFDM 64 QAM_RB273@0	20.39
100MHz_30kHz_3750MHz_CP- OFDM QPSK_RB1@1	22.47
100MHz_30kHz_3750MHz_CP- OFDM QPSK_RB1@271	22.43
100MHz_30kHz_3750MHz_CP- OFDM QPSK_RB137@68	22.45
100MHz_30kHz_3750MHz_CP- OFDM QPSK_RB273@0	20.84
100MHz_30kHz_3750MHz_DFT-s- OFDM 16 QAM_RB270@0	21.92
100MHz_30kHz_3750MHz_DFT-s- OFDM 256 QAM_RB270@0	19.36
100MHz_30kHz_3750MHz_DFT-s- OFDM 64 QAM_RB270@0	21.36
100MHz_30kHz_3750MHz_DFT-s- OFDM PI2 BPSK_RB1@1	23.95
100MHz_30kHz_3750MHz_DFT-s- OFDM PI2 BPSK_RB1@271	23.92
100MHz_30kHz_3750MHz_DFT-s- OFDM PI2 BPSK_RB135@67	23.90
100MHz_30kHz_3750MHz_DFT-s- OFDM PI2 BPSK_RB270@0	23.41
100MHz_30kHz_3750MHz_DFT-s- OFDM QPSK_RB1@1	23.77
100MHz_30kHz_3750MHz_DFT-s- OFDM QPSK_RB1@271	23.82
100MHz_30kHz_3750MHz_DFT-s- OFDM QPSK_RB135@67	23.90
100MHz_30kHz_3750MHz_DFT-s- OFDM QPSK_RB270@0	22.98

WLAN 2.4G:

Mode	Channel frequency (MHz)	Data Rate	Duty Cycle [%]	Ant 12 RF Peak Output Power (dBm)	Ant 13 RF Peak Output Power (dBm)	Total RF Peak Output Power (dBm)
802.11b	2412	1Mbps	100	8.78	11.12	/
	2437			7.30	11.64	/
	2462			9.63	10.93	/
802.11g	2412	6Mbps		9.92	12.25	/
	2437			8.81	12.62	/
	2462			11.40	12.83	/
802.11 n20	2412	MCS0		10.54	12.32	14.53
	2437			8.62	12.54	14.02
	2462			10.49	12.59	14.68
802.11 n40	2412	MCS0		10.70	12.84	14.91
	2437			9.41	12.98	14.56
	2452			9.74	12.27	14.20
802.11 ax20	2412	MCS0	11.39	12.76	15.14	
	2437		10.67	14.02	15.67	
	2462		12.56	14.18	16.46	
802.11 ax40	2422	MCS0	10.02	12.72	14.59	
	2437		10.62	13.04	15.01	
	2452		10.95	12.48	14.79	

WLAN 5.2G:

Mode	Channel frequency (MHz)	Data Rate	Duty Cycle [%]	Ant 13 RF Average Output Power	Ant 15 RF Average Output Power	Total RF Average Output Power
802.11a	5180	6Mbps	100	13.36	14.00	/
	5200			12.73	14.04	/
	5240			12.65	14.09	/
802.11 ac20	5180	MCS8		10.94	11.51	14.24
	5200			10.86	11.65	14.28
	5240			10.53	11.78	14.21
802.11 ac40	5190	MCS8		10.53	11.38	13.99
	5230			10.38	11.62	14.05
802.11 ac80	5210	MCS8		10.31	11.35	13.87
802.11 ax20	5180	MCS8		11.73	12.22	14.99
	5200			11.08	11.65	14.38
	5240			11.02	11.35	14.20
802.11 ax40	5190	MCS8	11.11	11.40	14.27	
	5230		11.11	11.23	14.18	
802.11 ax80	5210	MCS8	10.87	10.84	13.87	

WLAN 5.8G:

Mode	Channel frequency (MHz)	Data Rate	Duty Cycle [%]	Ant 13 RF Average Output Power (dBm)	Ant 15 RF Average Output Power (dBm)	Total RF Average Output Power (dBm)
802.11a	5745	6Mbps	100	7.07	16.00	/
	5785			7.64	16.37	/
	5825			7.39	16.83	/
802.11 ac20	5745	MCS8		7.57	7.78	10.69
	5785			7.51	8.23	10.90
	5825			7.48	8.88	11.25
802.11 ac40	5755	MCS8		8.42	8.74	11.59
	5795			8.69	9.29	12.01
802.11 ac80	5775	MCS8		8.48	8.40	11.45
802.11 ax20	5745	MCS8		8.01	8.62	11.34
	5785			8.08	8.74	11.43
	5825			6.25	7.41	9.88
802.11 ax40	5755	MCS8		7.93	8.28	11.12
	5795			7.67	8.11	10.91
802.11 ax80	5775	MCS8		8.96	9.00	11.98

Bluetooth:

Mode	Channel frequency (MHz)	Duty cycle (%)	RF Output Power (dBm)	
BDR(GFSK)	2402	/	8.99	
	2441		9.56	
	2480		8.99	
EDR($\pi/4$ -DQPSK)	2402		8.64	
	2441		9.51	
	2480		8.44	
EDR(8DPSK)	2402		8.84	
	2441		9.33	
	2480		8.97	
BLE 1M	2402		60.94	-0.62
	2440			0.24
	2480			-0.86
BLE 2M	2404		31.75	-0.54
	2440			0.05
	2478			-0.57

STANDALONE SAR TEST EXCLUSION CONSIDERATIONS

Antennas Location:

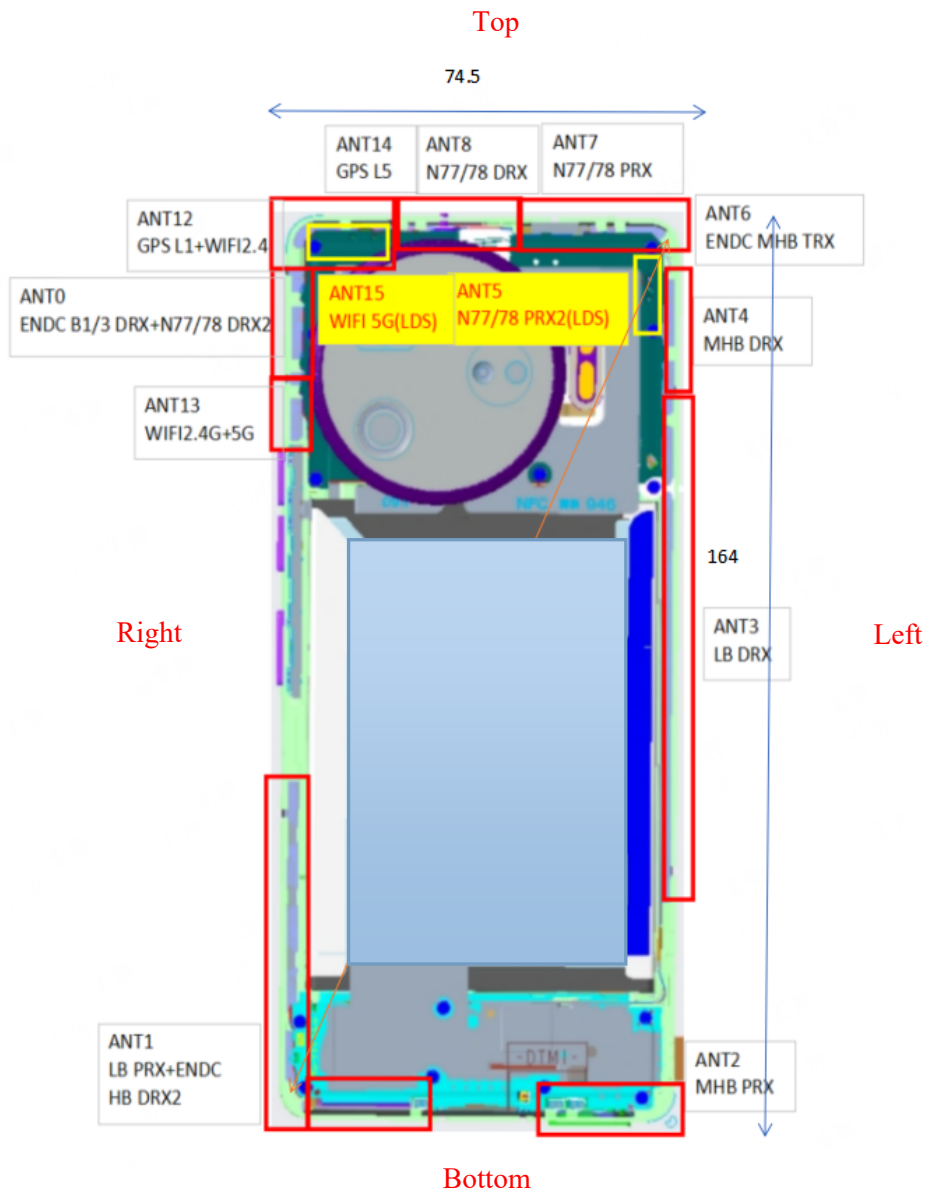

EUT Back View

Antenna	Description
Ant 0	DRX: LTE Band 42, 5G NR n77/78
Ant 1	TRX: GSM 850 WCDMA Band 5 LTE Band 5/12/17, 5G NR n5/12
Ant 2	TRX: GSM 1900 WCDMA Band 2/4 LTE Band 2/4/7/38/40/41/66, 5G NR n7/38/40/41/66
Ant 3	DRX: GSM 850 WCDMA Band 5 LTE Band 5/7/12/17/38/40/41, 5G NR n5/7/12/38/40/41
Ant 4	DRX: GSM 1900 WCDMA Band 2/4 LTE Band 2/4/7/38/40/41/66, 5G NR n7/38/40/41/66
Ant 5	DRX: LTE Band 42, 5G NR n77/78
Ant 6	DRX: LTE Band 7/38/40/41, 5G NR n7/38/40/41
Ant 7	TRX: LTE Band 42, 5G NR n77/78
Ant 8	DRX: LTE Band 42, 5G NR n77/78
Ant 12	TRX: WIFI 2.4G, Bluetooth, GPS L1
Ant 13	TRX: WIFI 2.4/5G
Ant 14	GPS L5
Ant 15	TRX: WIFI 5G

Antenna Distance To Edge (TRX)

Antenna Distance To Edge(mm)						
Antenna	Back	Front	Left	Right	Top	Bottom
Ant 1	< 5	< 5	45	< 5	100	< 5
Ant 2	< 5	< 5	< 5	47	160	< 5
Ant 7	< 5	< 5	< 5	43	< 5	153
Ant 12	< 5	< 5	52	< 5	< 5	148
Ant 13	< 5	< 5	70	< 5	32	118
Ant 15	< 5	< 5	52	< 5	< 5	148

Standalone SAR test exclusion considerations

Mode	Frequency (MHz)	Output Power (dBm)	Output Power (mW)	Distance (mm)	Calculated value	Threshold (1-g)	SAR Test Exclusion
ANT12 WLAN 2.4G	2462	12.7	18.62	0	5.8	3.0	NO
ANT13 WLAN 2.4G	2462	14.4	27.54	0	8.6	3.0	NO
ANT13 WLAN 5.2G	5240	13.5	22.39	0	10.2	3.0	NO
ANT15 WLAN 5.2G	5240	14.3	26.92	0	12.3	3.0	NO
ANT13 WLAN 5.8G	5825	9.1	8.13	0	3.9	3.0	NO
ANT15 WLAN 5.8G	5825	17.0	50.12	0	24.2	3.0	NO
Bluetooth	2480	9.7	9.33	0	2.9	3.0	YES

Note: The 5G Wi-Fi based average power for calculation, The 2.4G Wi-Fi and Bluetooth based peak power for calculation.

NOTE:

The 1-g and 10-g SAR test exclusion thresholds for 100 MHz to 6 GHz at test separation distances ≤ 50 mm are determined by:

$[(\text{max. power of channel, including tune-up tolerance, mW}) / (\text{min. test separation distance, mm})] \cdot$

$[\sqrt{f(\text{GHz})}] \leq 3.0$ for 1-g SAR and ≤ 7.5 for 10-g extremity SAR, where

1. $f(\text{GHz})$ is the RF channel transmit frequency in GHz.

2. Power and distance are rounded to the nearest mW and mm before calculation.

3. The result is rounded to one decimal place for comparison.

4. When the minimum test separation distance is < 5 mm, a distance of 5 mm is applied to determine SAR test Exclusion.

According to KDB 447498 D01 General RF Exposure Guidance v06, clause 4.3. General SAR test exclusion guidance:

c) For frequencies below 100 MHz, the following may be considered for SAR test exclusion (also illustrated in Appendix C):

1) For test separation distances > 50 mm and < 200 mm, the power threshold at the corresponding test separation distance at 100 MHz in step b) is multiplied by $[1 + \log(100/f(\text{MHz}))]$

2) For test separation distances ≤ 50 mm, the power threshold determined by the equation in c) 1) for 50 mm and 100 MHz is multiplied by $\frac{1}{2}$

3) SAR measurement procedures are not established below 100 MHz.

NFC Measurement Result:

For NFC, the power of EUT: E Field@3m is 76.54dBuV/m = -18.66 dBm(0.014mW)

Note: E[dBμV/m] = EIRP[dBm] + 95.2 for d = 3 m.

SAR test exclusion threshold for NFC(13.56MHz) separation distance < 50mm

$$=[474*(1 + \log(100/f_{(MHz)}))]/2$$

$$= 443mW$$

$$>0.001mW$$

Conclusion:

The NFC SAR evaluation can be exempted.

Standalone SAR estimation:

Mode	Frequency (MHz)	Output Power (dBm)	Output Power (mW)	Distance (mm)	Estimated 1-g (W/kg)
BT Head	2480	9.7	9.33	0	0.39
BT Body	2480	9.7	9.33	10	0.20

Note: The Bluetooth based peak power for calculation.

When standalone SAR test exclusion applies to an antenna that transmits simultaneously with other antennas, the standalone SAR must be estimated according to following to determine simultaneous transmission SAR test exclusion:

$$[(\text{max. power of channel, including tune-up tolerance, mW}) / (\text{min. test separation distance, mm})] \cdot [\sqrt{f(\text{GHz})} / x]$$

W/kg for test separation distances ≤50 mm;

where x = 7.5 for 1-g SAR.

When the minimum test separation distance is < 5 mm, a distance of 5 mm is applied to determine SAR test Exclusion.

SAR test exclusion for the EUT edge considerations Result

Mode	Back	Front	Left	Right	Top	Bottom
Bluetooth (Ant 12)	Exclusion*	Exclusion*	Exclusion*	Exclusion*	Exclusion*	Exclusion*
2.4G WLAN (Ant 12)	Required	Required	Exclusion	Required	Required	Exclusion
2.4G WLAN (Ant 13)	Required	Required	Exclusion	Required	Exclusion	Exclusion
5G WLAN (Ant 13)	Required	Required	Exclusion	Required	Exclusion	Exclusion
5G WLAN (Ant 15)	Required	Required	Exclusion	Required	Required	Exclusion
WWAN (Ant 1)	Required	Required	Exclusion	Required	Exclusion	Required
WWAN (Ant 2)	Required	Required	Required	Exclusion	Exclusion	Required
WWAN (Ant 7)	Required	Required	Required	Exclusion	Required	Exclusion

Note:

Required : The distance to Edge is less than 25mm, testing is required.

Exclusion* : SAR test exclusion evaluation has been done above.

Exclusion: The distance to Edge is more than 25 mm, testing is not required.

Extremity Exposure Considerations

Per KDB 648474 D04 D04v01r03, this device is considered a “Phablet” since the diagonal dimension is >160mm and < 200mm, when hotspot mode applies, extremity SAR is required only for the surfaces and edges with hotspot mode scaled to the maximum output power (with tolerance is 1g SAR > 1.2W/kg)

Extremity Exposure Condition		
Worst Mode	Hotspot SAR value	Extremity Condition Test
WCDMA Band 4	0.68 W/kg@1g	Exclusion

SAR MEASUREMENT RESULTS

This page summarizes the results of the performed dosimetric evaluation.

Test Results:

Environmental Conditions:

Temperature:	23.7~24.6°C	22.4~23.3°C	23.3~24.2°C	23.8~24.5°C	23.4~24.3°C
Relative Humidity:	35~44 %	45~57 %	42~51 %	42~51 %	31~42 %
ATM Pressure:	101.3 kPa	101.3 kPa	101.3 kPa	101.3 kPa	101.3 kPa
Test Date:	2024/01/22	2024/01/23	2024/01/24	2024/01/25	2024/03/04

Temperature:	23.0~23.9°C	22.5~23.4°C	22.5~23.1°C	22.3~23.1°C	22.8~23.4°C
Relative Humidity:	33~44 %	42~51 %	39~49 %	48~60 %	34~46 %
ATM Pressure:	101.3 kPa	101.3 kPa	101.3 kPa	101.3 kPa	101.3 kPa
Test Date:	2024/03/08	2024/03/09	2024/03/10	2024/03/12	2024/03/13

* Testing was performed by Bob Lu, Calvin Li and Sid Luo.

GSM 850 :

EUT Position	Frequency (MHz)	Test Mode	Max. Meas. Power (dBm)	Max. Rated Power (dBm)	1g SAR (W/kg)			
					Scaled Factor	Meas. SAR	Scaled SAR	Plot
Head Left Cheek	824.2	GSM	/	/	/	/	/	/
	836.6	GSM	32.93	33.4	1.114	0.116	0.13	1#
	848.8	GSM	/	/	/	/	/	/
Head Left Tilt	824.2	GSM	/	/	/	/	/	/
	836.6	GSM	32.93	33.4	1.114	0.067	0.08	2#
	848.8	GSM	/	/	/	/	/	/
Head Right Cheek	824.2	GSM	/	/	/	/	/	/
	836.6	GSM	32.93	33.4	1.114	0.114	0.13	3#
	848.8	GSM	/	/	/	/	/	/
Head Right Tilt	824.2	GSM	/	/	/	/	/	/
	836.6	GSM	32.93	33.4	1.114	0.067	0.08	4#
	848.8	GSM	/	/	/	/	/	/
Body Worn Front (10mm)	824.2	GSM	/	/	/	/	/	/
	836.6	GSM	32.93	33.4	1.114	0.319	0.36	5#
	848.8	GSM	/	/	/	/	/	/
Body Worn Back (10mm)	824.2	GSM	/	/	/	/	/	/
	836.6	GSM	32.93	33.4	1.114	0.329	0.37	6#
	848.8	GSM	/	/	/	/	/	/
Body Front (10mm)	824.2	GPRS	/	/	/	/	/	/
	836.6	GPRS	29.58	29.9	1.076	0.434	0.47	7#
	848.8	GPRS	/	/	/	/	/	/
Body Back (10mm)	824.2	GPRS	/	/	/	/	/	/
	836.6	GPRS	29.58	29.9	1.076	0.599	0.65	8#
	848.8	GPRS	/	/	/	/	/	/
Body Right (10mm)	824.2	GPRS	/	/	/	/	/	/
	836.6	GPRS	29.58	29.9	1.076	0.366	0.40	9#
	848.8	GPRS	/	/	/	/	/	/
Body Bottom (10mm)	824.2	GPRS	/	/	/	/	/	/
	836.6	GPRS	29.58	29.9	1.076	0.301	0.33	10#
	848.8	GPRS	/	/	/	/	/	/

The data above was performed on 2024/01/23.

Note:

1. When the 1-g SAR is $\leq 0.8W/Kg$, testing for other channels are optional.
2. The EUT transmit and receive through the same GSM antenna while testing SAR.
3. When SAR or MPE is not measured at the maximum power level allowed for production units, the results must be scaled to the maximum tune-up tolerance limit according to the power applied to the individual channels tested to determine compliance.
4. When the maximum output power variation across the required test channels is > 0.5 dB, instead of the middle channel, the highest output power channel must be used.
5. The Multi-slot Classes of EUT is Class 12 which has maximum 4 Downlink slots and 4 Uplink slots, the maximum active slots is 5, when perform the multiple slots scan, 1DL+4UL is the worst case.

PCS 1900 :

EUT Position	Frequency (MHz)	Test Mode	Max. Meas. Power (dBm)	Max. Rated Power (dBm)	1g SAR (W/kg)			
					Scaled Factor	Meas. SAR	Scaled SAR	Plot
Head Left Cheek	1850.2	GSM	/	/	/	/	/	/
	1880	GSM	29.68	29.8	1.028	0.110	0.12	11#
	1909.8	GSM	/	/	/	/	/	/
Head Left Tilt	1850.2	GSM	/	/	/	/	/	/
	1880	GSM	29.68	29.8	1.028	0.034	0.04	12#
	1909.8	GSM	/	/	/	/	/	/
Head Right Cheek	1850.2	GSM	/	/	/	/	/	/
	1880	GSM	29.68	29.8	1.028	0.075	0.08	13#
	1909.8	GSM	/	/	/	/	/	/
Head Right Tilt	1850.2	GSM	/	/	/	/	/	/
	1880	GSM	29.68	29.8	1.028	0.025	0.03	14#
	1909.8	GSM	/	/	/	/	/	/
Body Worn Front (10mm)	1850.2	GSM	/	/	/	/	/	/
	1880	GSM	29.68	29.8	1.028	0.237	0.25	15#
	1909.8	GSM	/	/	/	/	/	/
Body Worn Back (10mm)	1850.2	GSM	/	/	/	/	/	/
	1880	GSM	29.68	29.8	1.028	0.282	0.29	16#
	1909.8	GSM	/	/	/	/	/	/
Body Front (10mm)	1850.2	GPRS	/	/	/	/	/	/
	1880	GPRS	25.95	26.1	1.035	0.365	0.38	17#
	1909.8	GPRS	/	/	/	/	/	/
Body Back (10mm)	1850.2	GPRS	/	/	/	/	/	/
	1880	GPRS	25.95	26.1	1.035	0.426	0.45	18#
	1909.8	GPRS	/	/	/	/	/	/
Body Left (10mm)	1850.2	GPRS	/	/	/	/	/	/
	1880	GPRS	25.95	26.1	1.035	0.186	0.20	19#
	1909.8	GPRS	/	/	/	/	/	/
Body Bottom (10mm)	1850.2	GPRS	/	/	/	/	/	/
	1880	GPRS	25.95	26.1	1.035	0.621	0.65	20#
	1909.8	GPRS	/	/	/	/	/	/

The data above was performed on 2024/01/25.

Note:

1. When the 1-g SAR is $\leq 0.8W/Kg$, testing for other channels are optional.
2. The EUT transmit and receive through the same GSM antenna while testing SAR.
3. When SAR or MPE is not measured at the maximum power level allowed for production units, the results must be scaled to the maximum tune-up tolerance limit according to the power applied to the individual channels tested to determine compliance.
4. When the maximum output power variation across the required test channels is > 0.5 dB, instead of the middle channel, the highest output power channel must be used.
5. The Multi-slot Classes of EUT is Class 12 which has maximum 4 Downlink slots and 4 Uplink slots, the maximum active slots is 5, when perform the multiple slots scan, 1DL+4UL is the worst case.

WCDMA Band 2 :

EUT Position	Frequency (MHz)	Test Mode	Max. Meas. Power (dBm)	Max. Rated Power (dBm)	1g SAR (W/kg)			
					Scaled Factor	Meas. SAR	Scaled SAR	Plot
Head Left Cheek	1852.4	RMC	/	/	/	/	/	/
	1880	RMC	22.59	22.9	1.074	0.145	0.16	21#
	1907.6	RMC	/	/	/	/	/	/
Head Left Tilt	1852.4	RMC	/	/	/	/	/	/
	1880	RMC	22.59	22.9	1.074	0.049	0.06	22#
	1907.6	RMC	/	/	/	/	/	/
Head Right Cheek	1852.4	RMC	/	/	/	/	/	/
	1880	RMC	22.59	22.9	1.074	0.071	0.08	23#
	1907.6	RMC	/	/	/	/	/	/
Head Right Tilt	1852.4	RMC	/	/	/	/	/	/
	1880	RMC	22.59	22.9	1.074	0.047	0.06	24#
	1907.6	RMC	/	/	/	/	/	/
Body Front (10mm)	1852.4	RMC	/	/	/	/	/	/
	1880	RMC	22.59	22.9	1.074	0.400	0.43	25#
	1907.6	RMC	/	/	/	/	/	/
Body Back (10mm)	1852.4	RMC	/	/	/	/	/	/
	1880	RMC	22.59	22.9	1.074	0.448	0.49	26#
	1907.6	RMC	/	/	/	/	/	/
Body Left (10mm)	1852.4	RMC	/	/	/	/	/	/
	1880	RMC	22.59	22.9	1.074	0.164	0.18	27#
	1907.6	RMC	/	/	/	/	/	/
Body Bottom (10mm)	1852.4	RMC	/	/	/	/	/	/
	1880	RMC	22.59	22.9	1.074	0.479	0.52	28#
	1907.6	RMC	/	/	/	/	/	/

The data above was performed on 2024/01/25.

WCDMA Band 4 :

EUT Position	Frequency (MHz)	Test Mode	Max. Meas. Power (dBm)	Max. Rated Power (dBm)	1g SAR (W/kg)			
					Scaled Factor	Meas. SAR	Scaled SAR	Plot
Head Left Cheek	1712.4	RMC	/	/	/	/	/	/
	1732.6	RMC	23.25	23.3	1.012	0.061	0.07	29#
	1752.6	RMC	/	/	/	/	/	/
Head Left Tilt	1712.4	RMC	/	/	/	/	/	/
	1732.6	RMC	23.25	23.3	1.012	0.038	0.04	30#
	1752.6	RMC	/	/	/	/	/	/
Head Right Cheek	1712.4	RMC	/	/	/	/	/	/
	1732.6	RMC	23.25	23.3	1.012	0.095	0.10	31#
	1752.6	RMC	/	/	/	/	/	/
Head Right Tilt	1712.4	RMC	/	/	/	/	/	/
	1732.6	RMC	23.25	23.3	1.012	0.069	0.07	32#
	1752.6	RMC	/	/	/	/	/	/
Body Front (10mm)	1712.4	RMC	/	/	/	/	/	/
	1732.6	RMC	23.25	23.3	1.012	0.327	0.34	33#
	1752.6	RMC	/	/	/	/	/	/
Body Back (10mm)	1712.4	RMC	/	/	/	/	/	/
	1732.6	RMC	23.25	23.3	1.012	0.493	0.50	34#
	1752.6	RMC	/	/	/	/	/	/
Body Left (10mm)	1712.4	RMC	/	/	/	/	/	/
	1732.6	RMC	23.25	23.3	1.012	0.139	0.15	35#
	1752.6	RMC	/	/	/	/	/	/
Body Bottom (10mm)	1712.4	RMC	/	/	/	/	/	/
	1732.6	RMC	23.25	23.3	1.012	0.671	0.68	36#
	1752.6	RMC	/	/	/	/	/	/

The data above was performed on 2024/01/24.

WCDMA Band 5 :

EUT Position	Frequency (MHz)	Test Mode	Max. Meas. Power (dBm)	Max. Rated Power (dBm)	1g SAR (W/kg)			
					Scaled Factor	Meas. SAR	Scaled SAR	Plot
Head Left Cheek	826.4	RMC	/	/	/	/	/	/
	836.6	RMC	23.91	24.1	1.045	0.167	0.18	37#
	846.6	RMC	/	/	/	/	/	/
Head Left Tilt	826.4	RMC	/	/	/	/	/	/
	836.6	RMC	23.91	24.1	1.045	0.097	0.11	38#
	846.6	RMC	/	/	/	/	/	/
Head Right Cheek	826.4	RMC	/	/	/	/	/	/
	836.6	RMC	23.91	24.1	1.045	0.241	0.26	39#
	846.6	RMC	/	/	/	/	/	/
Head Right Tilt	826.4	RMC	/	/	/	/	/	/
	836.6	RMC	23.91	24.1	1.045	0.133	0.14	40#
	846.6	RMC	/	/	/	/	/	/
Body Front (10mm)	826.4	RMC	/	/	/	/	/	/
	836.6	RMC	23.91	24.1	1.045	0.339	0.36	41#
	846.6	RMC	/	/	/	/	/	/
Body Back (10mm)	826.4	RMC	/	/	/	/	/	/
	836.6	RMC	23.91	24.1	1.045	0.371	0.39	42#
	846.6	RMC	/	/	/	/	/	/
Body Right (10mm)	826.4	RMC	/	/	/	/	/	/
	836.6	RMC	23.91	24.1	1.045	0.224	0.24	43#
	846.6	RMC	/	/	/	/	/	/
Body Bottom (10mm)	826.4	RMC	/	/	/	/	/	/
	836.6	RMC	23.91	24.1	1.045	0.225	0.24	44#
	846.6	RMC	/	/	/	/	/	/

The data above was performed on 2024/01/22.

Note:

1. When the 1-g SAR is ≤ 0.8W/Kg, testing for other channels are optional.
2. The EUT transmit and receive through the same antenna while testing SAR.
3. The default test configuration is to measure SAR with an established radio link between the EUT and a communication test set using a 12.2 kbps RMC (reference measurement Channel) Configured in Test Loop Model.
4. KDB 941225 D01-Body SAR is not required for HSDPA/HSUPA /HSPA+ when the maximum average output of each RF channel is less than ¼ dB higher than measured 12.2kbps RMC or the maximum SAR for 12.2kbps RMC is < 75% of SAR limit.
5. When SAR or MPE is not measured at the maximum power level allowed for production units, the results must be scaled to the maximum tune-up tolerance limit according to the power applied to the individual channels tested to determine compliance.

LTE Band 2 :

EUT Position	Frequency (MHz)	Bandwidth (MHz)	Test Mode	Max. Meas. Power (dBm)	Max. Rated Power (dBm)	1g SAR (W/kg)			
						Scaled Factor	Meas. SAR	Scaled SAR	Plot
Head Left Cheek	1860	20	1RB	/	/	/	/	/	/
	1880	20	1RB	20.45	20.6	1.035	0.100	0.11	45#
	1900	20	1RB	/	/	/	/	/	/
	1880	20	50%RB	19.90	20.6	1.175	0.088	0.11	46#
Head Left Tilt	1860	20	1RB	/	/	/	/	/	/
	1880	20	1RB	20.45	20.6	1.035	0.045	0.05	47#
	1900	20	1RB	/	/	/	/	/	/
	1880	20	50%RB	19.90	20.6	1.175	0.036	0.05	48#
Head Right Cheek	1860	20	1RB	/	/	/	/	/	/
	1880	20	1RB	20.45	20.6	1.035	0.083	0.09	49#
	1900	20	1RB	/	/	/	/	/	/
	1880	20	50%RB	19.90	20.6	1.175	0.072	0.09	50#
Head Right Tilt	1860	20	1RB	/	/	/	/	/	/
	1880	20	1RB	20.45	20.6	1.035	0.042	0.05	51#
	1900	20	1RB	/	/	/	/	/	/
	1880	20	50%RB	19.90	20.6	1.175	0.034	0.04	52#
Body Front (10mm)	1860	20	1RB	/	/	/	/	/	/
	1880	20	1RB	20.45	20.6	1.035	0.360	0.38	53#
	1900	20	1RB	/	/	/	/	/	/
	1880	20	50%RB	19.90	20.6	1.175	0.350	0.42	54#
Body Back (10mm)	1860	20	1RB	/	/	/	/	/	/
	1880	20	1RB	20.45	20.6	1.035	0.464	0.49	55#
	1900	20	1RB	/	/	/	/	/	/
	1880	20	50%RB	19.90	20.6	1.175	0.450	0.53	56#
Body Left (10mm)	1860	20	1RB	/	/	/	/	/	/
	1880	20	1RB	20.45	20.6	1.035	0.181	0.19	57#
	1900	20	1RB	/	/	/	/	/	/
	1880	20	50%RB	19.90	20.6	1.175	0.150	0.18	58#
Body Bottom (10mm)	1860	20	1RB	/	/	/	/	/	/
	1880	20	1RB	20.45	20.6	1.035	0.552	0.58	59#
	1900	20	1RB	/	/	/	/	/	/
	1880	20	50%RB	19.90	20.6	1.175	0.445	0.53	60#

The data above was performed on 2024/01/25.

LTE Band 5 :

EUT Position	Frequency (MHz)	Bandwidth (MHz)	Test Mode	Max. Meas. Power (dBm)	Max. Rated Power (dBm)	1g SAR (W/kg)			
						Scaled Factor	Meas. SAR	Scaled SAR	Plot
Head Left Cheek	829	15	1RB	/	/	/	/	/	/
	836.5	15	1RB	24.10	24.3	1.047	0.263	0.28	61#
	844	15	1RB	/	/	/	/	/	/
	836.5	15	50%RB	23.46	24.3	1.213	0.212	0.26	62#
Head Left Tilt	829	15	1RB	/	/	/	/	/	/
	836.5	15	1RB	24.10	24.3	1.047	0.108	0.12	63#
	844	15	1RB	/	/	/	/	/	/
	836.5	15	50%RB	23.46	24.3	1.213	0.085	0.11	64#
Head Right Cheek	829	15	1RB	/	/	/	/	/	/
	836.5	15	1RB	24.10	24.3	1.047	0.265	0.28	65#
	844	15	1RB	/	/	/	/	/	/
	836.5	15	50%RB	23.46	24.3	1.213	0.207	0.26	66#
Head Right Tilt	829	15	1RB	/	/	/	/	/	/
	836.5	15	1RB	24.10	24.3	1.047	0.140	0.15	67#
	844	15	1RB	/	/	/	/	/	/
	836.5	15	50%RB	23.46	24.3	1.213	0.109	0.14	68#
Body Front (10mm)	829	15	1RB	/	/	/	/	/	/
	836.5	15	1RB	24.10	24.3	1.047	0.368	0.39	69#
	844	15	1RB	/	/	/	/	/	/
	836.5	15	50%RB	23.46	24.3	1.213	0.291	0.36	70#
Body Back (10mm)	829	15	1RB	/	/	/	/	/	/
	836.5	15	1RB	24.10	24.3	1.047	0.419	0.44	71#
	844	15	1RB	/	/	/	/	/	/
	836.5	15	50%RB	23.46	24.3	1.213	0.399	0.49	72#
Body Right (10mm)	829	15	1RB	/	/	/	/	/	/
	836.5	15	1RB	24.10	24.3	1.047	0.244	0.26	73#
	844	15	1RB	/	/	/	/	/	/
	836.5	15	50%RB	23.46	24.3	1.213	0.194	0.24	74#
Body Bottom (10mm)	829	15	1RB	/	/	/	/	/	/
	836.5	15	1RB	24.10	24.3	1.047	0.246	0.26	75#
	844	15	1RB	/	/	/	/	/	/
	836.5	15	50%RB	23.46	24.3	1.213	0.197	0.24	76#

The data above was performed on 2024/01/23.

LTE Band 7 :

EUT Position	Frequency (MHz)	Bandwidth (MHz)	Test Mode	Max. Meas. Power (dBm)	Max. Rated Power (dBm)	1g SAR (W/kg)			
						Scaled Factor	Meas. SAR	Scaled SAR	Plot
Head Left Cheek	2510	20	1RB	/	/	/	/	/	/
	2535	20	1RB	22.59	22.8	1.050	0.121	0.13	77#
	2560	20	1RB	/	/	/	/	/	/
	2535	20	50%RB	22.15	22.8	1.161	0.092	0.11	78#
Head Left Tilt	2510	20	1RB	/	/	/	/	/	/
	2535	20	1RB	22.59	22.8	1.050	0.050	0.06	79#
	2560	20	1RB	/	/	/	/	/	/
	2535	20	50%RB	22.15	22.8	1.161	0.040	0.05	80#
Head Right Cheek	2510	20	1RB	/	/	/	/	/	/
	2535	20	1RB	22.59	22.8	1.050	0.099	0.11	81#
	2560	20	1RB	/	/	/	/	/	/
	2535	20	50%RB	22.15	22.8	1.161	0.082	0.10	82#
Head Right Tilt	2510	20	1RB	/	/	/	/	/	/
	2535	20	1RB	22.59	22.8	1.050	0.084	0.09	83#
	2560	20	1RB	/	/	/	/	/	/
	2535	20	50%RB	22.15	22.8	1.161	0.070	0.09	84#
Body Front (10mm)	2510	20	1RB	/	/	/	/	/	/
	2535	20	1RB	22.59	22.8	1.050	0.464	0.49	85#
	2560	20	1RB	/	/	/	/	/	/
	2535	20	50%RB	22.15	22.8	1.161	0.255	0.30	86#
Body Back (10mm)	2510	20	1RB	/	/	/	/	/	/
	2535	20	1RB	22.59	22.8	1.050	0.504	0.53	87#
	2560	20	1RB	/	/	/	/	/	/
	2535	20	50%RB	22.15	22.8	1.161	0.390	0.46	88#
Body Left (10mm)	2510	20	1RB	/	/	/	/	/	/
	2535	20	1RB	22.59	22.8	1.050	0.112	0.12	89#
	2560	20	1RB	/	/	/	/	/	/
	2535	20	50%RB	22.15	22.8	1.161	0.095	0.12	90#
Body Bottom (10mm)	2510	20	1RB	/	/	/	/	/	/
	2535	20	1RB	22.59	22.8	1.050	0.477	0.51	91#
	2560	20	1RB	/	/	/	/	/	/
	2535	20	50%RB	22.15	22.8	1.161	0.390	0.46	92#

The data above was performed on 2024/03/12.

LTE Band 12&17 :

EUT Position	Frequency (MHz)	Bandwidth (MHz)	Test Mode	Max. Meas. Power (dBm)	Max. Rated Power (dBm)	1g SAR (W/kg)			
						Scaled Factor	Meas. SAR	Scaled SAR	Plot
Head Left Cheek	704	10	1RB	/	/	/	/	/	/
	707.5	10	1RB	24.23	24.5	1.064	0.097	0.11	93#
	711	10	1RB	/	/	/	/	/	/
	707.5	10	50%RB	23.61	24.5	1.227	0.078	0.10	94#
Head Left Tilt	704	10	1RB	/	/	/	/	/	/
	707.5	10	1RB	24.23	24.5	1.064	0.039	0.05	95#
	711	10	1RB	/	/	/	/	/	/
	707.5	10	50%RB	23.61	24.5	1.227	0.032	0.04	96#
Head Right Cheek	704	10	1RB	/	/	/	/	/	/
	707.5	10	1RB	24.23	24.5	1.064	0.100	0.11	97#
	711	10	1RB	/	/	/	/	/	/
	707.5	10	50%RB	23.61	24.5	1.227	0.076	0.10	98#
Head Right Tilt	704	10	1RB	/	/	/	/	/	/
	707.5	10	1RB	24.23	24.5	1.064	0.054	0.06	99#
	711	10	1RB	/	/	/	/	/	/
	707.5	10	50%RB	23.61	24.5	1.227	0.042	0.06	100#
Body Front (10mm)	704	10	1RB	/	/	/	/	/	/
	707.5	10	1RB	24.23	24.5	1.064	0.200	0.22	101#
	711	10	1RB	/	/	/	/	/	/
	707.5	10	50%RB	23.61	24.5	1.227	0.159	0.20	102#
Body Back (10mm)	704	10	1RB	/	/	/	/	/	/
	707.5	10	1RB	24.23	24.5	1.064	0.224	0.24	103#
	711	10	1RB	/	/	/	/	/	/
	707.5	10	50%RB	23.61	24.5	1.227	0.180	0.23	104#
Body Right (10mm)	704	10	1RB	/	/	/	/	/	/
	707.5	10	1RB	24.23	24.5	1.064	0.165	0.18	105#
	711	10	1RB	/	/	/	/	/	/
	707.5	10	50%RB	23.61	24.5	1.227	0.129	0.16	106#
Body Bottom (10mm)	704	10	1RB	/	/	/	/	/	/
	707.5	10	1RB	24.23	24.5	1.064	0.085	0.10	107#
	711	10	1RB	/	/	/	/	/	/
	707.5	10	50%RB	23.61	24.5	1.227	0.067	0.09	108#

The data above was performed on 2024/01/22.

Note: The E-UTRA Operating Band 17 is a subset of band 12, and they are same in modulation type and rated output power, therefore, they were considered as one frequency band during SAR measurement.

LTE Band 40 Lower :

EUT Position	Frequency (MHz)	Bandwidth (MHz)	Test Mode	Max. Meas. Power (dBm)	Max. Rated Power (dBm)	1g SAR (W/kg)			
						Scaled Factor	Meas. SAR	Scaled SAR	Plot
Head Left Cheek	2310	10	1RB	23.29	23.5	1.050	0.075	0.08	109#
	2310	10	50%RB	22.78	23.5	1.180	0.055	0.07	110#
Head Left Tilt	2310	10	1RB	23.29	23.5	1.050	0.028	0.03	111#
	2310	10	50%RB	22.78	23.5	1.180	0.023	0.03	112#
Head Right Cheek	2310	10	1RB	23.29	23.5	1.050	0.056	0.06	113#
	2310	10	50%RB	22.78	23.5	1.180	0.045	0.06	114#
Head Right Tilt	2310	10	1RB	23.29	23.5	1.050	0.025	0.03	115#
	2310	10	50%RB	22.78	23.5	1.180	0.020	0.03	116#
Body Front (10mm)	2310	10	1RB	23.29	23.5	1.050	0.301	0.32	117#
	2310	10	50%RB	22.78	23.5	1.180	0.238	0.29	118#
Body Back (10mm)	2310	10	1RB	23.29	23.5	1.050	0.328	0.35	119#
	2310	10	50%RB	22.78	23.5	1.180	0.270	0.32	120#
Body Left (10mm)	2310	10	1RB	23.29	23.5	1.050	0.120	0.13	121#
	2310	10	50%RB	22.78	23.5	1.180	0.098	0.12	122#
Body Bottom (10mm)	2310	10	1RB	23.29	23.5	1.050	0.323	0.34	123#
	2310	10	50%RB	22.78	23.5	1.180	0.267	0.32	124#

The data above was performed on 2024/03/09.

LTE Band 40 Upper :

EUT Position	Frequency (MHz)	Bandwidth (MHz)	Test Mode	Max. Meas. Power (dBm)	Max. Rated Power (dBm)	1g SAR (W/kg)			
						Scaled Factor	Meas. SAR	Scaled SAR	Plot
Head Left Cheek	2355	10	1RB	22.95	23.1	1.035	0.063	0.07	125#
	2355	10	50%RB	22.45	23.1	1.161	0.046	0.06	126#
Head Left Tilt	2355	10	1RB	22.95	23.1	1.035	0.026	0.03	127#
	2355	10	50%RB	22.45	23.1	1.161	0.020	0.03	128#
Head Right Cheek	2355	10	1RB	22.95	23.1	1.035	0.052	0.06	129#
	2355	10	50%RB	22.45	23.1	1.161	0.040	0.05	130#
Head Right Tilt	2355	10	1RB	22.95	23.1	1.035	0.041	0.05	131#
	2355	10	50%RB	22.45	23.1	1.161	0.030	0.04	132#
Body Front (10mm)	2355	10	1RB	22.95	23.1	1.035	0.279	0.29	133#
	2355	10	50%RB	22.45	23.1	1.161	0.219	0.26	134#
Body Back (10mm)	2355	10	1RB	22.95	23.1	1.035	0.346	0.36	135#
	2355	10	50%RB	22.45	23.1	1.161	0.272	0.32	136#
Body Left (10mm)	2355	10	1RB	22.95	23.1	1.035	0.104	0.11	137#
	2355	10	50%RB	22.45	23.1	1.161	0.085	0.10	138#
Body Bottom (10mm)	2355	10	1RB	22.95	23.1	1.035	0.363	0.38	139#
	2355	10	50%RB	22.45	23.1	1.161	0.288	0.34	140#

The data above was performed on 2024/03/10.

Note: The power class 3 used for LTE Band 40 SAR testing.

LTE Band 41&38 :

EUT Position	Frequency (MHz)	Bandwidth (MHz)	Test Mode	Max. Meas. Power (dBm)	Max. Rated Power (dBm)	1g SAR (W/kg)			
						Scaled Factor	Meas. SAR	Scaled SAR	Plot
Head Left Cheek	2506	20	1RB	/	/	/	/	/	/
	2549.5	20	1RB	/	/	/	/	/	/
	2593	20	1RB	23.10	23.3	1.047	0.115	0.13	141#
	2636.5	20	1RB	/	/	/	/	/	/
	2680	20	1RB	/	/	/	/	/	/
	2593	20	50%RB	22.59	23.3	1.178	0.094	0.12	142#
Head Left Tilt	2506	20	1RB	/	/	/	/	/	/
	2549.5	20	1RB	/	/	/	/	/	/
	2593	20	1RB	23.10	23.3	1.047	0.041	0.05	143#
	2636.5	20	1RB	/	/	/	/	/	/
	2680	20	1RB	/	/	/	/	/	/
	2593	20	50%RB	22.59	23.3	1.178	0.031	0.04	144#
Head Right Cheek	2506	20	1RB	/	/	/	/	/	/
	2549.5	20	1RB	/	/	/	/	/	/
	2593	20	1RB	23.10	23.3	1.047	0.067	0.07	145#
	2636.5	20	1RB	/	/	/	/	/	/
	2680	20	1RB	/	/	/	/	/	/
	2593	20	50%RB	22.59	23.3	1.178	0.050	0.06	146#
Head Right Tilt	2506	20	1RB	/	/	/	/	/	/
	2549.5	20	1RB	/	/	/	/	/	/
	2593	20	1RB	23.10	23.3	1.047	0.060	0.07	147#
	2636.5	20	1RB	/	/	/	/	/	/
	2680	20	1RB	/	/	/	/	/	/
	2593	20	50%RB	22.59	23.3	1.178	0.050	0.06	148#
Body Front (10mm)	2506	20	1RB	/	/	/	/	/	/
	2549.5	20	1RB	/	/	/	/	/	/
	2593	20	1RB	23.10	23.3	1.047	0.404	0.43	149#
	2636.5	20	1RB	/	/	/	/	/	/
	2680	20	1RB	/	/	/	/	/	/
	2593	20	50%RB	22.59	23.3	1.178	0.322	0.38	150#
Body Back (10mm)	2506	20	1RB	/	/	/	/	/	/
	2549.5	20	1RB	/	/	/	/	/	/
	2593	20	1RB	23.10	23.3	1.047	0.423	0.45	151#
	2636.5	20	1RB	/	/	/	/	/	/
	2680	20	1RB	/	/	/	/	/	/
	2593	20	50%RB	22.59	23.3	1.178	0.338	0.40	152#

Body Left (10mm)	2506	20	1RB	/	/	/	/	/	/
	2549.5	20	1RB	/	/	/	/	/	/
	2593	20	1RB	23.10	23.3	1.047	0.132	0.14	153#
	2636.5	20	1RB	/	/	/	/	/	/
	2680	20	1RB	/	/	/	/	/	/
	2593	20	50%RB	22.59	23.3	1.178	0.107	0.13	154#
Body Bottom (10mm)	2506	20	1RB	/	/	/	/	/	/
	2549.5	20	1RB	/	/	/	/	/	/
	2593	20	1RB	23.10	23.3	1.047	0.301	0.32	155#
	2636.5	20	1RB	/	/	/	/	/	/
	2680	20	1RB	/	/	/	/	/	/
	2593	20	50%RB	22.59	23.3	1.178	0.245	0.29	156#

The data above was performed on 2024/03/13.

Note: 1.The E-UTRA Operating Band 38 is a subset of band 41, and they are same in modulation type and rated output power, therefore, they were considered as one frequency band during SAR measurement.

2.The frequency range of LTE Band 41 is 2496~ 2690MHz. Per KDB 447498 D01, according to the following formula calculate N_c is 5.

KDB procedures, the following should be applied to determine the number of required test channels. The test channels should be evenly spread across the transmission frequency band of each wireless mode.¹⁴

$$N_c = Round \left\{ \left[100 \left(\frac{f_{high} - f_{low}}{f_c} \right) \right]^{0.5} \times \left(\frac{f_c}{100} \right)^{0.2} \right\},$$

where

- N_c is the number of test channels, rounded to the nearest integer,
- f_{high} and f_{low} are the highest and lowest channel frequencies within the transmission band,
- f_c is the mid-band channel frequency,
- all frequencies are in MHz.

3. The power class 3 used for LTE Band 41 SAR testing.

LTE Band 42 :

EUT Position	Frequency (MHz)	Bandwidth (MHz)	Test Mode	Max. Meas. Power (dBm)	Max. Rated Power (dBm)	1g SAR (W/kg)			
						Scaled Factor	Meas. SAR	Scaled SAR	Plot
Head Left Cheek	3460	20	1RB	/	/	/	/	/	/
	3500	20	1RB	11.85	12.2	1.084	0.156	0.17	157#
	3540	20	1RB	/	/	/	/	/	/
	3500	20	50%RB	11.19	12.2	1.262	0.119	0.16	158#
Head Left Tilt	3460	20	1RB	/	/	/	/	/	/
	3500	20	1RB	11.85	12.2	1.084	0.174	0.19	159#
	3540	20	1RB	/	/	/	/	/	/
	3500	20	50%RB	11.19	12.2	1.262	0.171	0.22	160#
Head Right Cheek	3460	20	1RB	/	/	/	/	/	/
	3500	20	1RB	11.85	12.2	1.084	0.252	0.28	161#
	3540	20	1RB	/	/	/	/	/	/
	3500	20	50%RB	11.19	12.2	1.262	0.191	0.25	162#
Head Right Tilt	3460	20	1RB	/	/	/	/	/	/
	3500	20	1RB	11.85	12.2	1.084	0.310	0.34	163#
	3540	20	1RB	/	/	/	/	/	/
	3500	20	50%RB	11.19	12.2	1.262	0.241	0.31	164#
Body Front (10mm)	3460	20	1RB	/	/	/	/	/	/
	3500	20	1RB	11.85	12.2	1.084	0.039	0.05	165#
	3540	20	1RB	/	/	/	/	/	/
	3500	20	50%RB	11.19	12.2	1.262	0.027	0.04	166#
Body Back (10mm)	3460	20	1RB	/	/	/	/	/	/
	3500	20	1RB	11.85	12.2	1.084	0.072	0.08	167#
	3540	20	1RB	/	/	/	/	/	/
	3500	20	50%RB	11.19	12.2	1.262	0.052	0.07	168#
Body Left (10mm)	3460	20	1RB	/	/	/	/	/	/
	3500	20	1RB	11.85	12.2	1.084	0.022	0.03	169#
	3540	20	1RB	/	/	/	/	/	/
	3500	20	50%RB	11.19	12.2	1.262	0.018	0.03	170#
Body Top (10mm)	3460	20	1RB	/	/	/	/	/	/
	3500	20	1RB	11.85	12.2	1.084	0.079	0.09	171#
	3540	20	1RB	/	/	/	/	/	/
	3500	20	50%RB	11.19	12.2	1.262	0.038	0.05	172#

The data above was performed on 2024/03/04.

LTE Band 66&4 :

EUT Position	Frequency (MHz)	Bandwidth (MHz)	Test Mode	Max. Meas. Power (dBm)	Max. Rated Power (dBm)	1g SAR (W/kg)			
						Scaled Factor	Meas. SAR	Scaled SAR	Plot
Head Left Cheek	1720	20	1RB	/	/	/	/	/	/
	1745	20	1RB	18.95	19.1	1.035	0.159	0.17	173#
	1770	20	1RB	/	/	/	/	/	/
	1745	20	50%RB	18.22	19.1	1.225	0.134	0.17	174#
Head Left Tilt	1720	20	1RB	/	/	/	/	/	/
	1745	20	1RB	18.95	19.1	1.035	0.063	0.07	175#
	1770	20	1RB	/	/	/	/	/	/
	1745	20	50%RB	18.22	19.1	1.225	0.046	0.06	176#
Head Right Cheek	1720	20	1RB	/	/	/	/	/	/
	1745	20	1RB	18.95	19.1	1.035	0.081	0.09	177#
	1770	20	1RB	/	/	/	/	/	/
	1745	20	50%RB	18.22	19.1	1.225	0.063	0.08	178#
Head Right Tilt	1720	20	1RB	/	/	/	/	/	/
	1745	20	1RB	18.95	19.1	1.035	0.063	0.07	179#
	1770	20	1RB	/	/	/	/	/	/
	1745	20	50%RB	18.22	19.1	1.225	0.043	0.06	180#
Body Front (10mm)	1720	20	1RB	/	/	/	/	/	/
	1745	20	1RB	18.95	19.1	1.035	0.422	0.44	181#
	1770	20	1RB	/	/	/	/	/	/
	1745	20	50%RB	18.22	19.1	1.225	0.354	0.44	182#
Body Back (10mm)	1720	20	1RB	/	/	/	/	/	/
	1745	20	1RB	18.95	19.1	1.035	0.561	0.59	183#
	1770	20	1RB	/	/	/	/	/	/
	1745	20	50%RB	18.22	19.1	1.225	0.457	0.56	184#
Body Left (10mm)	1720	20	1RB	/	/	/	/	/	/
	1745	20	1RB	18.95	19.1	1.035	0.202	0.21	185#
	1770	20	1RB	/	/	/	/	/	/
	1745	20	50%RB	18.22	19.1	1.225	0.161	0.20	186#
Body Bottom (10mm)	1720	20	1RB	/	/	/	/	/	/
	1745	20	1RB	18.95	19.1	1.035	0.597	0.62	187#
	1770	20	1RB	/	/	/	/	/	/
	1745	20	50%RB	18.22	19.1	1.225	0.471	0.58	188#

The data above was performed on 2024/01/24.

Note: The E-UTRA Operating Band 4 is a subset of band 66, and they are same in modulation type and rated output power, therefore, they were considered as one frequency band during SAR measurement.

Note:

1. When the 1-g SAR is $\leq 0.8\text{W/Kg}$, testing for other channels are optional.
2. SAR for LTE band exposure configurations is measured according to the procedures of KDB 941225 D05 SAR for LTE Devices v02.
3. KDB941225D05-SAR for higher order modulation is required only when the highest maximum output power for the configuration in the higher order modulation is $> 0.5\text{ dB}$ higher than the same configuration in QPSK or when the reported SAR for the QPSK configuration is $> 1.45\text{ W/kg}$
4. KDB941225D05-For QPSK with 100% RB allocation, when the reported SAR measured for the Highest output power channel is $< 1.45\text{ W/kg}$, tests for the remaining required test channels are optional.
5. KDB941225D05- For QPSK with 100% RB allocation, SAR is not required when the highest maximum output power for 100 % RB allocation is less than the highest maximum output power in 50% and 1 RB allocations and the highest reported SAR for 1 RB and 50% RB allocation are $\leq 0.8\text{ W/kg}$.
6. KDB941225D05- Start with the largest channel bandwidth and measure SAR for QPSK with 1 RB allocation, using the RB offset and required test channel combination with the highest maximum output power among RB offset the upper edge, middle and lower edge of each required test channel.
7. KDB941225D05- other channel bandwidths SAR test is required when the highest maximum output power of a configuration requiring testing in the smaller channel bandwidth is $> 0.5\text{ dB}$ higher than the equivalent channel configurations in the largest channel bandwidth configuration or the reported SAR of a configuration for the largest channel bandwidth is $> 1.45\text{ W/kg}$.
8. Worst case SAR for 50% RB allocation is selected to be tested.

5G NR n5:

EUT Position	Frequency (MHz)	Bandwidth (MHz)	Test Mode	Max. Meas. Power (dBm)	Max. Rated Power (dBm)	1g SAR (W/kg)			
						Scaled Factor	Meas. SAR	Scaled SAR	Plot
Head Left Cheek	834	20	1RB	/	/	/	/	/	/
	836.5	20	1RB	25.04	25.2	1.038	0.099	0.11	189#
	839	20	1RB	/	/	/	/	/	/
	836.5	20	50%RB	24.98	25.2	1.052	0.123	0.13	190#
Head Left Tilt	834	20	1RB	/	/	/	/	/	/
	836.5	20	1RB	25.04	25.2	1.038	0.055	0.06	191#
	839	20	1RB	/	/	/	/	/	/
	836.5	20	50%RB	24.98	25.2	1.052	0.065	0.07	192#
Head Right Cheek	834	20	1RB	/	/	/	/	/	/
	836.5	20	1RB	25.04	25.2	1.038	0.109	0.12	193#
	839	20	1RB	/	/	/	/	/	/
	836.5	20	50%RB	24.98	25.2	1.052	0.122	0.13	194#
Head Right Tilt	834	20	1RB	/	/	/	/	/	/
	836.5	20	1RB	25.04	25.2	1.038	0.052	0.06	195#
	839	20	1RB	/	/	/	/	/	/
	836.5	20	50%RB	24.98	25.2	1.052	0.068	0.08	196#
Body Front (10mm)	834	20	1RB	/	/	/	/	/	/
	836.5	20	1RB	25.04	25.2	1.038	0.098	0.11	197#
	839	20	1RB	/	/	/	/	/	/
	836.5	20	50%RB	24.98	25.2	1.052	0.110	0.12	198#
Body Back (10mm)	834	20	1RB	/	/	/	/	/	/
	836.5	20	1RB	25.04	25.2	1.038	0.305	0.32	199#
	839	20	1RB	/	/	/	/	/	/
	836.5	20	50%RB	24.98	25.2	1.052	0.189	0.20	200#
Body Right (10mm)	834	20	1RB	/	/	/	/	/	/
	836.5	20	1RB	25.04	25.2	1.038	0.180	0.19	201#
	839	20	1RB	/	/	/	/	/	/
	836.5	20	50%RB	24.98	25.2	1.052	0.195	0.21	202#
Body Bottom (10mm)	834	20	1RB	/	/	/	/	/	/
	836.5	20	1RB	25.04	25.2	1.038	0.089	0.10	203#
	839	20	1RB	/	/	/	/	/	/
	836.5	20	50%RB	24.98	25.2	1.052	0.106	0.12	204#

The data above was performed on 2024/01/23.

5G NR n7:

EUT Position	Frequency (MHz)	Bandwidth (MHz)	Test Mode	Max. Meas. Power (dBm)	Max. Rated Power (dBm)	1g SAR (W/kg)			
						Scaled Factor	Meas. SAR	Scaled SAR	Plot
Head Left Cheek	2510	20	1RB	/	/	/	/	/	/
	2535	20	1RB	22.84	23.2	1.086	0.086	0.10	205#
	2560	20	1RB	/	/	/	/	/	/
	2535	20	50%RB	22.98	23.2	1.052	0.090	0.10	206#
Head Left Tilt	2510	20	1RB	/	/	/	/	/	/
	2535	20	1RB	22.84	23.2	1.086	0.098	0.11	207#
	2560	20	1RB	/	/	/	/	/	/
	2535	20	50%RB	22.98	23.2	1.052	0.022	0.03	208#
Head Right Cheek	2510	20	1RB	/	/	/	/	/	/
	2535	20	1RB	22.84	23.2	1.086	0.059	0.07	209#
	2560	20	1RB	/	/	/	/	/	/
	2535	20	50%RB	22.98	23.2	1.052	0.059	0.07	210#
Head Right Tilt	2510	20	1RB	/	/	/	/	/	/
	2535	20	1RB	22.84	23.2	1.086	0.030	0.04	211#
	2560	20	1RB	/	/	/	/	/	/
	2535	20	50%RB	22.98	23.2	1.052	0.030	0.04	212#
Body Front (10mm)	2510	20	1RB	/	/	/	/	/	/
	2535	20	1RB	22.84	23.2	1.086	0.271	0.30	213#
	2560	20	1RB	/	/	/	/	/	/
	2535	20	50%RB	22.98	23.2	1.052	0.280	0.30	214#
Body Back (10mm)	2510	20	1RB	/	/	/	/	/	/
	2535	20	1RB	22.84	23.2	1.086	0.389	0.43	215#
	2560	20	1RB	/	/	/	/	/	/
	2535	20	50%RB	22.98	23.2	1.052	0.402	0.43	216#
Body Left (10mm)	2510	20	1RB	/	/	/	/	/	/
	2535	20	1RB	22.84	23.2	1.086	0.114	0.13	217#
	2560	20	1RB	/	/	/	/	/	/
	2535	20	50%RB	22.98	23.2	1.052	0.114	0.12	218#
Body Bottom (10mm)	2510	20	1RB	/	/	/	/	/	/
	2535	20	1RB	22.84	23.2	1.086	0.372	0.41	219#
	2560	20	1RB	/	/	/	/	/	/
	2535	20	50%RB	22.98	23.2	1.052	0.389	0.41	220#

The data above was performed on 2024/03/12.

5G NR n12:

EUT Position	Frequency (MHz)	Bandwidth (MHz)	Test Mode	Max. Meas. Power (dBm)	Max. Rated Power (dBm)	1g SAR (W/kg)			
						Scaled Factor	Meas. SAR	Scaled SAR	Plot
Head Left Cheek	706.5	15	1RB	/	/	/	/	/	/
	707.5	15	1RB	24.00	24.2	1.047	0.084	0.09	221#
	708.5	15	1RB	/	/	/	/	/	/
	707.5	15	50%RB	24.09	24.2	1.026	0.085	0.09	222#
Head Left Tilt	706.5	15	1RB	/	/	/	/	/	/
	707.5	15	1RB	24.00	24.2	1.047	0.036	0.04	223#
	708.5	15	1RB	/	/	/	/	/	/
	707.5	15	50%RB	24.09	24.2	1.026	0.036	0.04	224#
Head Right Cheek	706.5	15	1RB	/	/	/	/	/	/
	707.5	15	1RB	24.00	24.2	1.047	0.082	0.09	225#
	708.5	15	1RB	/	/	/	/	/	/
	707.5	15	50%RB	24.09	24.2	1.026	0.082	0.09	226#
Head Right Tilt	706.5	15	1RB	/	/	/	/	/	/
	707.5	15	1RB	24.00	24.2	1.047	0.046	0.05	227#
	708.5	15	1RB	/	/	/	/	/	/
	707.5	15	50%RB	24.09	24.2	1.026	0.046	0.05	228#
Body Front (10mm)	706.5	15	1RB	/	/	/	/	/	/
	707.5	15	1RB	24.00	24.2	1.047	0.145	0.16	229#
	708.5	15	1RB	/	/	/	/	/	/
	707.5	15	50%RB	24.09	24.2	1.026	0.148	0.16	230#
Body Back (10mm)	706.5	15	1RB	/	/	/	/	/	/
	707.5	15	1RB	24.00	24.2	1.047	0.177	0.19	231#
	708.5	15	1RB	/	/	/	/	/	/
	707.5	15	50%RB	24.09	24.2	1.026	0.182	0.19	232#
Body Right (10mm)	706.5	15	1RB	/	/	/	/	/	/
	707.5	15	1RB	24.00	24.2	1.047	0.155	0.17	233#
	708.5	15	1RB	/	/	/	/	/	/
	707.5	15	50%RB	24.09	24.2	1.026	0.155	0.16	234#
Body Bottom (10mm)	706.5	15	1RB	/	/	/	/	/	/
	707.5	15	1RB	24.00	24.2	1.047	0.063	0.07	235#
	708.5	15	1RB	/	/	/	/	/	/
	707.5	15	50%RB	24.09	24.2	1.026	0.064	0.07	236#

The data above was performed on 2024/01/22.

5G NR n38:

EUT Position	Frequency (MHz)	Bandwidth (MHz)	Test Mode	Max. Meas. Power (dBm)	Max. Rated Power (dBm)	1g SAR (W/kg)			
						Scaled Factor	Meas. SAR	Scaled SAR	Plot
Head Left Cheek	2590	40	1RB	/	/	/	/	/	/
	2595	40	1RB	23.71	24.0	1.069	0.070	0.08	237#
	2600	40	1RB	/	/	/	/	/	/
	2595	40	50%RB	23.59	24.0	1.099	0.072	0.08	238#
Head Left Tilt	2590	40	1RB	/	/	/	/	/	/
	2595	40	1RB	23.71	24.0	1.069	0.018	0.02	239#
	2600	40	1RB	/	/	/	/	/	/
	2595	40	50%RB	23.59	24.0	1.099	0.022	0.03	240#
Head Right Cheek	2590	40	1RB	/	/	/	/	/	/
	2595	40	1RB	23.71	24.0	1.069	0.045	0.05	241#
	2600	40	1RB	/	/	/	/	/	/
	2595	40	50%RB	23.59	24.0	1.099	0.035	0.04	242#
Head Right Tilt	2590	40	1RB	/	/	/	/	/	/
	2595	40	1RB	23.71	24.0	1.069	0.036	0.04	243#
	2600	40	1RB	/	/	/	/	/	/
	2595	40	50%RB	23.59	24.0	1.099	0.038	0.05	244#
Body Front (10mm)	2590	40	1RB	/	/	/	/	/	/
	2595	40	1RB	23.71	24.0	1.069	0.222	0.24	245#
	2600	40	1RB	/	/	/	/	/	/
	2595	40	50%RB	23.59	24.0	1.099	0.256	0.29	246#
Body Back (10mm)	2590	40	1RB	/	/	/	/	/	/
	2595	40	1RB	23.71	24.0	1.069	0.279	0.30	247#
	2600	40	1RB	/	/	/	/	/	/
	2595	40	50%RB	23.59	24.0	1.099	0.289	0.32	248#
Body Left (10mm)	2590	40	1RB	/	/	/	/	/	/
	2595	40	1RB	23.71	24.0	1.069	0.067	0.08	249#
	2600	40	1RB	/	/	/	/	/	/
	2595	40	50%RB	23.59	24.0	1.099	0.069	0.08	250#
Body Bottom (10mm)	2590	40	1RB	/	/	/	/	/	/
	2595	40	1RB	23.71	24.0	1.069	0.270	0.29	251#
	2600	40	1RB	/	/	/	/	/	/
	2595	40	50%RB	23.59	24.0	1.099	0.282	0.31	252#

The data above was performed on 2024/03/08.

5G NR n40 Lower:

EUT Position	Frequency (MHz)	Bandwidth (MHz)	Test Mode	Max. Meas. Power (dBm)	Max. Rated Power (dBm)	1g SAR (W/kg)			
						Scaled Factor	Meas. SAR	Scaled SAR	Plot
Head Left Cheek	2310	10	1RB	24.28	24.4	1.028	0.053	0.06	253#
	2310	10	50%RB	24.16	24.4	1.057	0.056	0.06	254#
Head Left Tilt	2310	10	1RB	24.28	24.4	1.028	0.013	0.02	255#
	2310	10	50%RB	24.16	24.4	1.057	0.011	0.02	256#
Head Right Cheek	2310	10	1RB	24.28	24.4	1.028	0.049	0.06	257#
	2310	10	50%RB	24.16	24.4	1.057	0.043	0.05	258#
Head Right Tilt	2310	10	1RB	24.28	24.4	1.028	0.026	0.03	259#
	2310	10	50%RB	24.16	24.4	1.057	0.026	0.03	260#
Body Front (10mm)	2310	10	1RB	24.28	24.4	1.028	0.272	0.28	261#
	2310	10	50%RB	24.16	24.4	1.057	0.274	0.29	262#
Body Back (10mm)	2310	10	1RB	24.28	24.4	1.028	0.319	0.33	263#
	2310	10	50%RB	24.16	24.4	1.057	0.324	0.35	264#
Body Left (10mm)	2310	10	1RB	24.28	24.4	1.028	0.199	0.21	265#
	2310	10	50%RB	24.16	24.4	1.057	0.194	0.21	266#
Body Bottom (10mm)	2310	10	1RB	24.28	24.4	1.028	0.318	0.33	267#
	2310	10	50%RB	24.16	24.4	1.057	0.328	0.35	268#

The data above was performed on 2024/03/09.

5G NR n40 Upper:

EUT Position	Frequency (MHz)	Bandwidth (MHz)	Test Mode	Max. Meas. Power (dBm)	Max. Rated Power (dBm)	1g SAR (W/kg)			
						Scaled Factor	Meas. SAR	Scaled SAR	Plot
Head Left Cheek	2355	10	1RB	23.17	23.4	1.054	0.075	0.08	269#
	2355	10	50%RB	23.11	23.4	1.069	0.075	0.09	270#
Head Left Tilt	2355	10	1RB	23.17	23.4	1.054	0.027	0.03	271#
	2355	10	50%RB	23.11	23.4	1.069	0.023	0.03	272#
Head Right Cheek	2355	10	1RB	23.17	23.4	1.054	0.043	0.05	273#
	2355	10	50%RB	23.11	23.4	1.069	0.039	0.05	274#
Head Right Tilt	2355	10	1RB	23.17	23.4	1.054	0.027	0.03	275#
	2355	10	50%RB	23.11	23.4	1.069	0.025	0.03	276#
Body Front (10mm)	2355	10	1RB	23.17	23.4	1.054	0.188	0.20	277#
	2355	10	50%RB	23.11	23.4	1.069	0.186	0.20	278#
Body Back (10mm)	2355	10	1RB	23.17	23.4	1.054	0.249	0.27	279#
	2355	10	50%RB	23.11	23.4	1.069	0.249	0.27	280#
Body Left (10mm)	2355	10	1RB	23.17	23.4	1.054	0.095	0.11	281#
	2355	10	50%RB	23.11	23.4	1.069	0.096	0.11	282#
Body Bottom (10mm)	2355	10	1RB	23.17	23.4	1.054	0.293	0.31	283#
	2355	10	50%RB	23.11	23.4	1.069	0.290	0.32	284#

The data above was performed on 2024/03/10.

5G NR n41:

EUT Position	Frequency (MHz)	Bandwidth (MHz)	Test Mode	Max. Meas. Power (dBm)	Max. Rated Power (dBm)	1g SAR (W/kg)			
						Scaled Factor	Meas. SAR	Scaled SAR	Plot
Head Left Cheek	2546	100	1RB	/	/	/	/	/	/
	2593	100	1RB	23.79	24.0	1.050	0.045	0.05	285#
	2640	100	1RB	/	/	/	/	/	/
	2593	100	50%RB	23.56	24.0	1.107	0.113	0.13	286#
Head Left Tilt	2546	100	1RB	/	/	/	/	/	/
	2593	100	1RB	23.79	24.0	1.050	0.012	0.02	287#
	2640	100	1RB	/	/	/	/	/	/
	2593	100	50%RB	23.56	24.0	1.107	0.032	0.04	288#
Head Right Cheek	2546	100	1RB	/	/	/	/	/	/
	2593	100	1RB	23.79	24.0	1.050	0.023	0.03	289#
	2640	100	1RB	/	/	/	/	/	/
	2593	100	50%RB	23.56	24.0	1.107	0.060	0.07	290#
Head Right Tilt	2546	100	1RB	/	/	/	/	/	/
	2593	100	1RB	23.79	24.0	1.050	0.018	0.02	291#
	2640	100	1RB	/	/	/	/	/	/
	2593	100	50%RB	23.56	24.0	1.107	0.049	0.06	292#
Body Front (10mm)	2546	100	1RB	/	/	/	/	/	/
	2593	100	1RB	23.79	24.0	1.050	0.131	0.14	293#
	2640	100	1RB	/	/	/	/	/	/
	2593	100	50%RB	23.56	24.0	1.107	0.252	0.28	294#
Body Back (10mm)	2546	100	1RB	/	/	/	/	/	/
	2593	100	1RB	23.79	24.0	1.050	0.193	0.21	295#
	2640	100	1RB	/	/	/	/	/	/
	2593	100	50%RB	23.56	24.0	1.107	0.446	0.50	296#
Body Left (10mm)	2546	100	1RB	/	/	/	/	/	/
	2593	100	1RB	23.79	24.0	1.050	0.048	0.06	297#
	2640	100	1RB	/	/	/	/	/	/
	2593	100	50%RB	23.56	24.0	1.107	0.086	0.10	298#
Body Bottom (10mm)	2546	100	1RB	/	/	/	/	/	/
	2593	100	1RB	23.79	24.0	1.050	0.187	0.20	299#
	2640	100	1RB	/	/	/	/	/	/
	2593	100	50%RB	23.56	24.0	1.107	0.424	0.47	300#

The data above was performed on 2024/03/13.

5G NR n66:

EUT Position	Frequency (MHz)	Bandwidth (MHz)	Test Mode	Max. Meas. Power (dBm)	Max. Rated Power (dBm)	1g SAR (W/kg)			
						Scaled Factor	Meas. SAR	Scaled SAR	Plot
Head Left Cheek	1730	40	1RB	/	/	/	/	/	/
	1745	40	1RB	21.09	21.4	1.074	0.030	0.04	301#
	1760	40	1RB	/	/	/	/	/	/
	1745	40	50%RB	21.13	21.4	1.064	0.029	0.04	302#
Head Left Tilt	1730	40	1RB	/	/	/	/	/	/
	1745	40	1RB	21.09	21.4	1.074	0.020	0.03	303#
	1760	40	1RB	/	/	/	/	/	/
	1745	40	50%RB	21.13	21.4	1.064	0.020	0.03	304#
Head Right Cheek	1730	40	1RB	/	/	/	/	/	/
	1745	40	1RB	21.09	21.4	1.074	0.034	0.04	305#
	1760	40	1RB	/	/	/	/	/	/
	1745	40	50%RB	21.13	21.4	1.064	0.033	0.04	306#
Head Right Tilt	1730	40	1RB	/	/	/	/	/	/
	1745	40	1RB	21.09	21.4	1.074	0.014	0.02	307#
	1760	40	1RB	/	/	/	/	/	/
	1745	40	50%RB	21.13	21.4	1.064	0.011	0.02	308#
Body Front (10mm)	1730	40	1RB	/	/	/	/	/	/
	1745	40	1RB	21.09	21.4	1.074	0.134	0.15	309#
	1760	40	1RB	/	/	/	/	/	/
	1745	40	50%RB	21.13	21.4	1.064	0.129	0.14	310#
Body Back (10mm)	1730	40	1RB	/	/	/	/	/	/
	1745	40	1RB	21.09	21.4	1.074	0.183	0.20	311#
	1760	40	1RB	/	/	/	/	/	/
	1745	40	50%RB	21.13	21.4	1.064	0.180	0.20	312#
Body Left (10mm)	1730	40	1RB	/	/	/	/	/	/
	1745	40	1RB	21.09	21.4	1.074	0.049	0.06	313#
	1760	40	1RB	/	/	/	/	/	/
	1745	40	50%RB	21.13	21.4	1.064	0.047	0.05	314#
Body Bottom (10mm)	1730	40	1RB	/	/	/	/	/	/
	1745	40	1RB	21.09	21.4	1.074	0.225	0.25	315#
	1760	40	1RB	/	/	/	/	/	/
	1745	40	50%RB	21.13	21.4	1.064	0.255	0.28	316#

The data above was performed on 2024/01/24.

5G NR n77&78 Lower:

EUT Position	Frequency (MHz)	Bandwidth (MHz)	Test Mode	Max. Meas. Power (dBm)	Max. Rated Power (dBm)	1g SAR (W/kg)			
						Scaled Factor	Meas. SAR	Scaled SAR	Plot
Head Left Cheek	3500	100	1RB	24.11	24.5	1.094	0.300	0.33	317#
	3500	100	50%RB	24.30	24.5	1.047	0.274	0.29	318#
Head Left Tilt	3500	100	1RB	24.11	24.5	1.094	0.382	0.42	319#
	3500	100	50%RB	24.30	24.5	1.047	0.344	0.37	320#
Head Right Cheek	3500	100	1RB	24.11	24.5	1.094	0.460	0.51	321#
	3500	100	50%RB	24.30	24.5	1.047	0.523	0.55	322#
Head Right Tilt	3500	100	1RB	24.11	24.5	1.094	0.603	0.66	323#
	3500	100	50%RB	24.30	24.5	1.047	0.690	0.73	324#
Body Front (10mm)	3500	100	1RB	24.11	24.5	1.094	0.083	0.10	325#
	3500	100	50%RB	24.30	24.5	1.047	0.081	0.09	326#
Body Back (10mm)	3500	100	1RB	24.11	24.5	1.094	0.116	0.13	327#
	3500	100	50%RB	24.30	24.5	1.047	0.113	0.12	328#
Body Left (10mm)	3500	100	1RB	24.11	24.5	1.094	0.033	0.04	329#
	3500	100	50%RB	24.30	24.5	1.047	0.032	0.04	330#
Body Top (10mm)	3500	100	1RB	24.11	24.5	1.094	0.174	0.20	331#
	3500	100	50%RB	24.30	24.5	1.047	0.144	0.16	332#

The data above was performed on 2024/03/04.

Note: The 5G NR n78 Lower is a subset of n77 Lower, and they are same in modulation type and rated output power, therefore, they were considered as one frequency band during SAR measurement.

5G NR n77/78 Upper:

EUT Position	Frequency (MHz)	Bandwidth (MHz)	Test Mode	Max. Meas. Power (dBm)	Max. Rated Power (dBm)	1g SAR (W/kg)			
						Scaled Factor	Meas. SAR	Scaled SAR	Plot
Head Left Cheek	3750	100	1RB	/	/	/	/	/	/
	3840	100	1RB	23.71	24.2	1.119	0.172	0.20	333#
	3930	100	1RB	/	/	/	/	/	/
	3840	100	50%RB	23.70	24.2	1.122	0.183	0.21	334#
Head Left Tilt	3750	100	1RB	/	/	/	/	/	/
	3840	100	1RB	23.71	24.2	1.119	0.209	0.24	335#
	3930	100	1RB	/	/	/	/	/	/
	3840	100	50%RB	23.70	24.2	1.122	0.215	0.25	336#
Head Right Cheek	3750	100	1RB	/	/	/	/	/	/
	3840	100	1RB	23.71	24.2	1.119	0.341	0.39	337#
	3930	100	1RB	/	/	/	/	/	/
	3840	100	50%RB	23.70	24.2	1.122	0.372	0.42	338#
Head Right Tilt	3750	100	1RB	/	/	/	/	/	/
	3840	100	1RB	23.71	24.2	1.119	0.427	0.48	339#
	3930	100	1RB	/	/	/	/	/	/
	3840	100	50%RB	23.70	24.2	1.122	0.444	0.50	340#
Body Front (10mm)	3750	100	1RB	/	/	/	/	/	/
	3840	100	1RB	23.71	24.2	1.119	0.048	0.06	341#
	3930	100	1RB	/	/	/	/	/	/
	3840	100	50%RB	23.70	24.2	1.122	0.053	0.06	342#
Body Back (10mm)	3750	100	1RB	/	/	/	/	/	/
	3840	100	1RB	23.71	24.2	1.119	0.053	0.06	343#
	3930	100	1RB	/	/	/	/	/	/
	3840	100	50%RB	23.70	24.2	1.122	0.057	0.07	344#
Body Left (10mm)	3750	100	1RB	/	/	/	/	/	/
	3840	100	1RB	23.71	24.2	1.119	0.006	0.01	345#
	3930	100	1RB	/	/	/	/	/	/
	3840	100	50%RB	23.70	24.2	1.122	0.007	0.01	346#
Body Top (10mm)	3750	100	1RB	/	/	/	/	/	/
	3840	100	1RB	23.71	24.2	1.119	0.100	0.12	347#
	3930	100	1RB	/	/	/	/	/	/
	3840	100	50%RB	23.70	24.2	1.122	0.084	0.10	348#

The data above was performed on 2024/03/08.

Note: The 5G NR n78 Upper is a subset of n77 Upper, and they are same in modulation type and rated output power, therefore, they were considered as one frequency band during SAR measurement.

Note:

1. SAR test for NR bands and LTE anchor Bands were performed separately due to limitations in SAR probe calibration factors. And, due to test setup limitations, SAR testing for NR was performed using test mode software to establish the connection.
2. FR1 supported standalone.
3. KDB941225D05-SAR for higher order modulation is required only when the highest maximum output power for the configuration in the higher order modulation is > 0.5 dB higher than the same configuration in QPSK or when the reported SAR for the QPSK configuration is > 1.45 W/kg
4. KDB941225D05-For QPSK with 100% RB allocation, when the reported SAR measured for the Highest output power channel is < 1.45 W/kg, tests for the remaining required test channels are optional.
5. KDB941225D05- For QPSK with 100% RB allocation, SAR is not required when the highest maximum output power for 100 % RB allocation is less than the highest maximum output power in 50% and 1 RB allocations and the highest reported SAR for 1 RB and 50% RB allocation are ≤ 0.8 W/kg.
6. KDB941225D05- Start with the largest channel bandwidth and measure SAR for QPSK with 1 RB allocation, using the RB offset and required test channel combination with the highest maximum output power among RB offset the upper edge, middle and lower edge of each required test channel.
7. KDB941225D05- other channel bandwidths SAR test is required when the highest maximum output power of a configuration requiring testing in the smaller channel bandwidth is > 0.5 dB higher than the equivalent channel configurations in the largest channel bandwidth configuration or the reported SAR of a configuration for the largest channel bandwidth is > 1.45 W/kg.

WLAN 2.4G Ant 12:

EUT Position	Frequency (MHz)	Test Mode	Max. Meas. Power (dBm)	Max. Rated Power (dBm)	1g SAR (W/kg)				
					Scaled Factor	Duty cycle Factor	Meas. SAR	Scaled SAR	Plot
Head Left Cheek	2412	802.11b	/	/	/	/	/	/	/
	2437	802.11b	7.30	7.5	1.047	1.000	0.142	0.15	349#
	2462	802.11b	/	/	/	/	/	/	/
Head Left Tilt	2412	802.11b	/	/	/	/	/	/	/
	2437	802.11b	7.30	7.5	1.047	1.000	0.163	0.18	350#
	2462	802.11b	/	/	/	/	/	/	/
Head Right Cheek	2412	802.11b	/	/	/	/	/	/	/
	2437	802.11b	7.30	7.5	1.047	1.000	0.084	0.09	351#
	2462	802.11b	/	/	/	/	/	/	/
Head Right Tilt	2412	802.11b	/	/	/	/	/	/	/
	2437	802.11b	7.30	7.5	1.047	1.000	0.101	0.11	352#
	2462	802.11b	/	/	/	/	/	/	/
Body Front (10mm)	2412	802.11b	/	/	/	/	/	/	/
	2437	802.11b	7.30	7.5	1.047	1.000	0.019	0.02	353#
	2462	802.11b	/	/	/	/	/	/	/
Body Back (10mm)	2412	802.11b	/	/	/	/	/	/	/
	2437	802.11b	7.30	7.5	1.047	1.000	0.026	0.03	354#
	2462	802.11b	/	/	/	/	/	/	/
Body Right (10mm)	2412	802.11b	/	/	/	/	/	/	/
	2437	802.11b	7.30	7.5	1.047	1.000	0.010	0.02	355#
	2462	802.11b	/	/	/	/	/	/	/
Body Top (10mm)	2412	802.11b	/	/	/	/	/	/	/
	2437	802.11b	7.30	7.5	1.047	1.000	0.013	0.02	356#
	2462	802.11b	/	/	/	/	/	/	/

The data above was performed on 2024/03/09.

Modulation Mode	Power (dBm)	Power (mW)	Measured SAR (W/kg)	Adjusted SAR (W/kg)	Limit(W/kg)	SAR Test Exclusion
802.11b(DSSS)	7.5	5.62	0.163	/	/	/
802.11g(OFDM)	11.6	14.45	/	0.419	1.2	Yes
802.11n HT20(OFDM)	10.7	11.75	/	0.341	1.2	Yes
802.11n HT40(OFDM)	10.9	12.30	/	0.357	1.2	Yes
802.11ax hew20(OFDM)	12.7	18.62	/	0.540	1.2	Yes
802.11ax hew40(OFDM)	11.1	12.88	/	0.373	1.2	Yes

Note:

1. When the 1-g SAR is ≤ 0.8W/kg, testing for other channels are optional.
2. When SAR or MPE is not measured at the maximum power level allowed for production units, the results must be scaled to the maximum tune-up tolerance limit according to the power applied to the individual channels tested to determine compliance.

WLAN 2.4G Ant 13:

EUT Position	Frequency (MHz)	Test Mode	Max. Meas. Power (dBm)	Max. Rated Power (dBm)	1g SAR (W/kg)				
					Scaled Factor	Duty cycle Factor	Meas. SAR	Scaled SAR	Plot
Head Left Cheek	2412	802.11b	/	/	/	/	/	/	/
	2437	802.11b	11.64	11.8	1.038	1.000	0.175	0.19	357#
	2462	802.11b	/	/	/	/	/	/	/
Head Left Tilt	2412	802.11b	/	/	/	/	/	/	/
	2437	802.11b	11.64	11.8	1.038	1.000	0.029	0.04	358#
	2462	802.11b	/	/	/	/	/	/	/
Head Right Cheek	2412	802.11b	/	/	/	/	/	/	/
	2437	802.11b	11.64	11.8	1.038	1.000	0.082	0.09	359#
	2462	802.11b	/	/	/	/	/	/	/
Head Right Tilt	2412	802.11b	/	/	/	/	/	/	/
	2437	802.11b	11.64	11.8	1.038	1.000	0.012	0.02	360#
	2462	802.11b	/	/	/	/	/	/	/
Body Front (10mm)	2412	802.11b	/	/	/	/	/	/	/
	2437	802.11b	11.64	11.8	1.038	1.000	0.028	0.03	361#
	2462	802.11b	/	/	/	/	/	/	/
Body Back (10mm)	2412	802.11b	/	/	/	/	/	/	/
	2437	802.11b	11.64	11.8	1.038	1.000	0.025	0.03	362#
	2462	802.11b	/	/	/	/	/	/	/
Body Right (10mm)	2412	802.11b	/	/	/	/	/	/	/
	2437	802.11b	11.64	11.8	1.038	1.000	0.052	0.06	363#
	2462	802.11b	/	/	/	/	/	/	/

The data above was performed on 2024/03/10.

Modulation Mode	Power (dBm)	Power (mW)	Measured SAR (W/kg)	Adjusted SAR (W/kg)	Limit(W/kg)	SAR Test Exclusion
802.11b(DSSS)	11.8	15.14	0.175	/	/	/
802.11g(OFDM)	13.0	19.95	/	0.231	1.2	Yes
802.11n HT20(OFDM)	12.8	19.05	/	0.220	1.2	Yes
802.11n HT40(OFDM)	13.2	20.89	/	0.242	1.2	Yes
802.11ax hew20(OFDM)	14.4	27.54	/	0.318	1.2	Yes
802.11ax hew40(OFDM)	13.2	20.89	/	0.242	1.2	Yes

Note:

1. When the 1-g SAR is ≤ 0.8W/kg, testing for other channels are optional.
2. When SAR or MPE is not measured at the maximum power level allowed for production units, the results must be scaled to the maximum tune-up tolerance limit according to the power applied to the individual channels tested to determine compliance.

WLAN 5.2G Ant 13:

EUT Position	Frequency (MHz)	Test Mode	Max. Meas. Power (dBm)	Max. Rated Power (dBm)	1g SAR (W/kg)				
					Scaled Factor	Duty cycle Factor	Meas. SAR	Scaled SAR	Plot
Head Left Cheek	5180	802.11 a	/	/	/	/	/	/	/
	5200	802.11 a	12.73	12.9	1.040	1.000	0.195	0.21	364#
	5240	802.11 a	/	/	/	/	/	/	/
Head Left Tilt	5180	802.11 a	/	/	/	/	/	/	/
	5200	802.11 a	12.73	12.9	1.040	1.000	0.072	0.08	365#
	5240	802.11 a	/	/	/	/	/	/	/
Head Right Cheek	5180	802.11 a	/	/	/	/	/	/	/
	5200	802.11 a	12.73	12.9	1.040	1.000	0.067	0.07	366#
	5240	802.11 a	/	/	/	/	/	/	/
Head Right Tilt	5180	802.11 a	/	/	/	/	/	/	/
	5200	802.11 a	12.73	12.9	1.040	1.000	0.040	0.05	367#
	5240	802.11 a	/	/	/	/	/	/	/
Body Front (10mm)	5180	802.11 a	/	/	/	/	/	/	/
	5200	802.11 a	12.73	12.9	1.040	1.000	0.021	0.03	368#
	5240	802.11 a	/	/	/	/	/	/	/
Body Back (10mm)	5180	802.11 a	/	/	/	/	/	/	/
	5200	802.11 a	12.73	12.9	1.040	1.000	0.021	0.03	369#
	5240	802.11 a	/	/	/	/	/	/	/
Body Right (10mm)	5180	802.11 a	/	/	/	/	/	/	/
	5200	802.11 a	12.73	12.9	1.040	1.000	0.034	0.04	370#
	5240	802.11 a	/	/	/	/	/	/	/

The data above was performed on 2024/03/12.

Note:

1. When the 1-g SAR is ≤ 0.8W/kg, testing for other channels are optional.
2. When SAR or MPE is not measured at the maximum power level allowed for production units, the results must be scaled to the maximum tune-up tolerance limit according to the power applied to the individual channels tested to determine compliance.
3. For 802.11ax40 mode power is the largest among 802.11a/n20/n40/ac80/ax20/ax40/ax80, 802.11 ax40 mode as initial test configuration is selected to test.

WLAN 5.2G Ant 15:

EUT Position	Frequency (MHz)	Test Mode	Max. Meas. Power (dBm)	Max. Rated Power (dBm)	1g SAR (W/kg)				
					Scaled Factor	Duty cycle Factor	Meas. SAR	Scaled SAR	Plot
Head Left Cheek	5180	802.11 a	/	/	/	/	/	/	/
	5200	802.11 a	14.04	14.2	1.038	1.000	0.134	0.14	371#
	5240	802.11 a	/	/	/	/	/	/	/
Head Left Tilt	5180	802.11 a	/	/	/	/	/	/	/
	5200	802.11 a	14.04	14.2	1.038	1.000	0.149	0.16	372#
	5240	802.11 a	/	/	/	/	/	/	/
Head Right Cheek	5180	802.11 a	/	/	/	/	/	/	/
	5200	802.11 a	14.04	14.2	1.038	1.000	0.169	0.18	373#
	5240	802.11 a	/	/	/	/	/	/	/
Head Right Tilt	5180	802.11 a	/	/	/	/	/	/	/
	5200	802.11 a	14.04	14.2	1.038	1.000	0.116	0.13	374#
	5240	802.11 a	/	/	/	/	/	/	/
Body Front (10mm)	5180	802.11 a	/	/	/	/	/	/	/
	5200	802.11 a	14.04	14.2	1.038	1.000	0.009	0.01	375#
	5240	802.11 a	/	/	/	/	/	/	/
Body Back (10mm)	5180	802.11 a	/	/	/	/	/	/	/
	5200	802.11 a	14.04	14.2	1.038	1.000	0.029	0.04	376#
	5240	802.11 a	/	/	/	/	/	/	/
Body Right (10mm)	5180	802.11 a	/	/	/	/	/	/	/
	5200	802.11 a	14.04	14.2	1.038	1.000	0.062	0.07	377#
	5240	802.11 a	/	/	/	/	/	/	/
Body Top (10mm)	5180	802.11 a	/	/	/	/	/	/	/
	5200	802.11 a	14.04	14.2	1.038	1.000	0.129	0.14	378#
	5240	802.11 a	/	/	/	/	/	/	/

The data above was performed on 2024/03/13.

Note:

1. When the 1-g SAR is $\leq 0.8W/kg$, testing for other channels are optional.
2. When SAR or MPE is not measured at the maximum power level allowed for production units, the results must be scaled to the maximum tune-up tolerance limit according to the power applied to the individual channels tested to determine compliance.
3. For 802.11a mode power is the largest among 802.11a/n20/n40/ac80/ax20/ax40/ax80, 802.11a mode as initial test configuration is selected to test.

WLAN 5.8G Ant 13:

EUT Position	Frequency (MHz)	Test Mode	Max. Meas. Power (dBm)	Max. Rated Power (dBm)	1g SAR (W/kg)				
					Scaled Factor	Duty cycle Factor	Meas. SAR	Scaled SAR	Plot
Head Left Cheek	/	802.11ax80	/	/	/	/	/	/	/
	5775	802.11ax80	8.94	9.1	1.038	1.000	0.172	0.18	379#
	/	802.11ax80	/	/	/	/	/	/	/
Head Left Tilt	/	802.11ax80	/	/	/	/	/	/	/
	5775	802.11ax80	8.94	9.1	1.038	1.000	0.044	0.05	380#
	/	802.11ax80	/	/	/	/	/	/	/
Head Right Cheek	/	802.11ax80	/	/	/	/	/	/	/
	5775	802.11ax80	8.94	9.1	1.038	1.000	0.084	0.09	381#
	/	802.11ax80	/	/	/	/	/	/	/
Head Right Tilt	/	802.11ax80	/	/	/	/	/	/	/
	5775	802.11ax80	8.94	9.1	1.038	1.000	0.034	0.04	382#
	/	802.11ax80	/	/	/	/	/	/	/
Body Front (10mm)	/	802.11ax80	/	/	/	/	/	/	/
	5775	802.11ax80	8.94	9.1	1.038	1.000	0.030	0.04	383#
	/	802.11ax80	/	/	/	/	/	/	/
Body Back (10mm)	/	802.11ax80	/	/	/	/	/	/	/
	5775	802.11ax80	8.94	9.1	1.038	1.000	0.102	0.11	384#
	/	802.11ax80	/	/	/	/	/	/	/
Body Right (10mm)	/	802.11ax80	/	/	/	/	/	/	/
	5775	802.11ax80	8.94	9.1	1.038	1.000	0.077	0.09	385#
	/	802.11ax80	/	/	/	/	/	/	/

The data above was performed on 2024/03/08.

Note:

1. When the 1-g SAR is ≤ 0.8W/kg, testing for other channels are optional.
2. When SAR or MPE is not measured at the maximum power level allowed for production units, the results must be scaled to the maximum tune-up tolerance limit according to the power applied to the individual channels tested to determine compliance.
3. For 802.11ax80 mode power is the largest among 802.11a/n20/n40/ac80/ax20/ax40/ax80, 802.11ax80 mode as initial test configuration is selected to test.

WLAN 5.8G Ant 15:

EUT Position	Frequency (MHz)	Test Mode	Max. Meas. Power (dBm)	Max. Rated Power (dBm)	1g SAR (W/kg)				
					Scaled Factor	Duty cycle Factor	Meas. SAR	Scaled SAR	Plot
Head Left Cheek	5745	802.11 a	/	/	/	/	/	/	/
	5785	802.11 a	16.37	16.5	1.030	1.000	0.228	0.24	386#
	5825	802.11 a	/	/	/	/	/	/	/
Head Left Tilt	5745	802.11 a	/	/	/	/	/	/	/
	5785	802.11 a	16.37	16.5	1.030	1.000	0.227	0.24	387#
	5825	802.11 a	/	/	/	/	/	/	/
Head Right Cheek	5745	802.11 a	/	/	/	/	/	/	/
	5785	802.11 a	16.37	16.5	1.030	1.000	0.163	0.17	388#
	5825	802.11 a	/	/	/	/	/	/	/
Head Right Tilt	5745	802.11 a	/	/	/	/	/	/	/
	5785	802.11 a	16.37	16.5	1.030	1.000	0.194	0.20	389#
	5825	802.11 a	/	/	/	/	/	/	/
Body Front (10mm)	5745	802.11 a	/	/	/	/	/	/	/
	5785	802.11 a	16.37	16.5	1.030	1.000	0.047	0.05	390#
	5825	802.11 a	/	/	/	/	/	/	/
Body Back (10mm)	5745	802.11 a	/	/	/	/	/	/	/
	5785	802.11 a	16.37	16.5	1.030	1.000	0.119	0.13	391#
	5825	802.11 a	/	/	/	/	/	/	/
Body Right (10mm)	5745	802.11 a	/	/	/	/	/	/	/
	5785	802.11 a	16.37	16.5	1.030	1.000	0.054	0.06	392#
	5825	802.11 a	/	/	/	/	/	/	/
Body Top (10mm)	5745	802.11 a	/	/	/	/	/	/	/
	5785	802.11 a	16.37	16.5	1.030	1.000	0.059	0.07	393#
	5825	802.11 a	/	/	/	/	/	/	/

The data above was performed on 2024/03/04.

Note:

1. When the 1-g SAR is $\leq 0.8W/kg$, testing for other channels are optional.
2. When SAR or MPE is not measured at the maximum power level allowed for production units, the results must be scaled to the maximum tune-up tolerance limit according to the power applied to the individual channels tested to determine compliance.
3. For 802.11a mode power is the largest among 802.11 a/n20/n40/ac80/ax20/ax40/ax80, 802.11 a mode as initial test configuration is selected to test.

SAR Measurement Variability

In accordance with published RF Exposure KDB procedure 865664 D01 SAR measurement 100 MHz to 6 GHz v01. These additional measurements are repeated after the completion of all measurements requiring the same head or body tissue-equivalent medium in a frequency band. The test device should be returned to ambient conditions (normal room temperature) with the battery fully charged before it is re-mounted on the device holder for the repeated measurement(s) to minimize any unexpected variations in the repeated results:

- 1) Repeated measurement is not required when the original highest measured SAR is < 0.80 W/kg; steps 2) through 4) do not apply.
- 2) When the original highest measured SAR is ≥ 0.80 W/kg, repeat that measurement once.
- 3) Perform a second repeated measurement only if the ratio of largest to smallest SAR for the original and first repeated measurements is > 1.20 or when the original or repeated measurement is ≥ 1.45 W/kg (~ 10% from the 1-g SAR limit).
- 4) Perform a third repeated measurement only if the original, first or second repeated measurement is ≥ 1.5 W/kg and the ratio of largest to smallest SAR for the original, first and second repeated measurements is > 1.20.

The Highest Measured SAR Configuration in Each Frequency Band

Head

SAR probe calibration point	Frequency Band	Freq.(MHz)	EUT Position	Meas. SAR (W/kg)		Largest to Smallest SAR Ratio
				Original	Repeated	
/	/	/	/	/	/	/

Body

SAR probe calibration point	Frequency Band	Freq.(MHz)	EUT Position	Meas. SAR (W/kg)		Largest to Smallest SAR Ratio
				Original	Repeated	
/	/	/	/	/	/	/

Note:

1. Second Repeated Measurement is not required since the ratio of the largest to smallest SAR for the original and first repeated measurement is not > 1.20.
2. The measured SAR results **do not** have to be scaled to the maximum tune-up tolerance to determine if repeated measurements are required.
3. SAR measurement variability must be assessed for each frequency band, which is determined by the **SAR probe calibration point and tissue-equivalent medium** used for the device measurements.

SAR SIMULTANEOUS TRANSMISSION DESCRIPTION

Simultaneous Transmission:

Description of Simultaneous Transmit Capabilities		
Transmitter Combination	Simultaneous?	Hotspot?
WWAN(GSM/WCDMA/LTE/5G NR) Antenna + WLAN 2.4G	√	√
WWAN(GSM/WCDMA/LTE/5G NR) Antenna + WLAN 5G	√	√
WWAN(GSM/WCDMA/LTE/5G NR) Antenna + Bluetooth	√	×
WLAN2.4G+Bluetooth	×	×
WLAN 5G + Bluetooth	×	×
WLAN2.4G +WLAN 5G	×	×

EN-DC Carrier Aggregation Possible Combinations	
LTE Anchor Bands for NR band n7	LTE Band 2/5/7/66
LTE Anchor Bands for NR band n38	LTE Band 4/5/66
LTE Anchor Bands for NR band n40	LTE Band 5/7/40
LTE Anchor Bands for NR band n41	LTE Band 4/5/40/41/66
LTE Anchor Bands for NR band n66	LTE Band 5/7/66
LTE Anchor Bands for NR band n77	LTE Band 5/7/40/41/66
LTE Anchor Bands for NR band n78	LTE Band 2/4/5/7/38/40/41/66

Remark:

5G NR bands supports SA Band 5/7/12/38/40/41/66/77/78 and NSA DC_2A_n7A/DC_5A_n7A/DC_7A_n7A/DC_66A_n7A/DC_4A_n38A/DC_5A_n38A/DC_66A_n38A/DC_5A_n40A/DC_7A_n40A/DC_40A_n40A/DC_4A_n41A/DC_5A_n41A/DC_40A_n41A/DC_41A_n41A/DC_66A_n41A/DC_2A_n66A/DC_5A_n66A/DC_7A_n66A/DC_66A_n66A/DC_5A_n77A/DC_7A_n77A/DC_40A_n77A/DC_41A_n77A/DC_66A_n77A/DC_2A_n78A/DC_4A_n78A/DC_5A_n78A/DC_7A_n78A/DC_38A_n78A/DC_40A_n78A/DC_41A_n78A/DC_66A_n78A mode.

Simultaneous SAR test exclusion considerations:

Mode (SAR1+SAR2)	Position	Reported SAR(W/kg)		ΣSAR < 1.6W/kg
		SAR1	SAR2	
MAX.WWAN(GSM/WCDMA/LTE/5G NR) + Bluetooth	Head	1.01	0.39	1.40
	Body	1.12	0.20	1.32

Mode (SAR1+SAR2)	Position	Reported SAR(W/kg)			ΣSAR < 1.6W/kg
		SAR1	SAR2	SAR3	
MAX.WWAN(GSM/WCDMA/LTE/5G NR) + WLAN 2.4G Ant 12+ WLAN 2.4G Ant 13	Head	1.01	0.18	0.19	1.38
MAX.WWAN(GSM/WCDMA/LTE/5G NR) + WLAN 2.4G Ant 12+ WLAN 2.4G Ant 13	Body	1.12	0.03	0.06	1.21
MAX.WWAN(GSM/WCDMA/LTE/5G NR) + WLAN 2.4G Ant 12+ WLAN 2.4G Ant 13	Body (Hotspot)	1.12	0.03	0.06	1.21

Mode (SAR1+SAR2)	Position	Reported SAR(W/kg)			ΣSAR < 1.6W/kg
		SAR1	SAR2	SAR3	
MAX.WWAN(GSM/WCDMA/LTE/5G NR) + WLAN 5.2G Ant 13+ WLAN 5.2G Ant 15	Head	1.01	0.21	0.18	1.40
MAX.WWAN(GSM/WCDMA/LTE/5G NR) + WLAN 5.2G Ant 13+ WLAN 5.2G Ant 15	Body	1.12	0.04	0.14	1.30
MAX.WWAN(GSM/WCDMA/LTE/5G NR) + WLAN 5.2G Ant 13+ WLAN 5.2G Ant 15	Body (Hotspot)	1.12	0.04	0.14	1.30

Mode (SAR1+SAR2)	Position	Reported SAR(W/kg)			ΣSAR < 1.6W/kg
		SAR1	SAR2	SAR3	
MAX.WWAN(GSM/WCDMA/LTE/5G NR) + WLAN 5.8G Ant 13+ WLAN 5.8G Ant 15	Head	1.01	0.18	0.24	1.43
MAX.WWAN(GSM/WCDMA/LTE/5G NR) + WLAN 5.8G Ant 13+ WLAN 5.8G Ant 15	Body	1.12	0.11	0.13	1.36
MAX.WWAN(GSM/WCDMA/LTE/5G NR) + WLAN 5.8G Ant 13+ WLAN 5.8G Ant 15	Body (Hotspot)	1.12	0.11	0.13	1.36

Mode(LTE+5G NR)	Position	Reported SAR(W/kg)		ΣSAR < 2.0W/kg
		LTE	5G NR	
DC_2A_n7A	Head	0.11	0.11	0.22
	Body	0.58	0.43	1.01
	Body (Hotspot)	0.58	0.43	1.01
DC_5A_n7A	Head	0.28	0.11	0.39
	Body	0.49	0.43	0.92
	Body (Hotspot)	0.49	0.43	0.92
DC_7A_n7A	Head	0.13	0.11	0.24
	Body	0.53	0.43	0.96
	Body (Hotspot)	0.53	0.43	0.96
DC_66A_n7A	Head	0.17	0.11	0.28
	Body	0.62	0.43	1.05
	Body (Hotspot)	0.62	0.43	1.05
DC_4A_n38A	Head	0.17	0.08	0.25
	Body	0.62	0.32	0.94
	Body (Hotspot)	0.62	0.32	0.94
DC_5A_n38A	Head	0.28	0.08	0.36
	Body	0.49	0.32	0.81
	Body (Hotspot)	0.49	0.32	0.81
DC_66A_n38A	Head	0.17	0.08	0.25
	Body	0.62	0.32	0.94
	Body (Hotspot)	0.62	0.32	0.94
DC_5A_n40A	Head	0.28	0.09	0.37
	Body	0.49	0.35	0.84
	Body (Hotspot)	0.49	0.35	0.84
DC_7A_n40A	Head	0.13	0.09	0.22
	Body	0.53	0.35	0.88
	Body (Hotspot)	0.53	0.35	0.88
DC_40A_n40A	Head	0.08	0.09	0.17
	Body	0.38	0.35	0.73
	Body (Hotspot)	0.38	0.35	0.73
DC_4A_n41A	Head	0.17	0.13	0.30
	Body	0.62	0.50	1.12
	Body (Hotspot)	0.62	0.50	1.12

Mode(LTE+5G NR)	Position	Reported SAR(W/kg)		ΣSAR < 2.0W/kg
		LTE	5G NR	
DC_5A_n41A	Head	0.28	0.13	0.41
	Body	0.49	0.50	0.99
	Body (Hotspot)	0.49	0.50	0.99
DC_40A_n41A	Head	0.08	0.13	0.21
	Body	0.38	0.50	0.88
	Body (Hotspot)	0.38	0.50	0.88
DC_41A_n41A	Head	0.13	0.13	0.26
	Body	0.45	0.50	0.95
	Body (Hotspot)	0.45	0.50	0.95
DC_66A_n41A	Head	0.17	0.13	0.30
	Body	0.62	0.50	1.12
	Body (Hotspot)	0.62	0.50	1.12
DC_2A_n66A	Head	0.11	0.04	0.15
	Body	0.58	0.25	0.83
	Body (Hotspot)	0.58	0.28	0.86
DC_5A_n66A	Head	0.28	0.04	0.32
	Body	0.49	0.25	0.74
	Body (Hotspot)	0.49	0.28	0.77
DC_7A_n66A	Head	0.13	0.04	0.17
	Body	0.53	0.25	0.78
	Body (Hotspot)	0.53	0.28	0.81
DC_66A_n66A	Head	0.17	0.04	0.21
	Body	0.62	0.25	0.87
	Body (Hotspot)	0.62	0.28	0.90
DC_5A_n77A	Head	0.28	0.73	1.01
	Body	0.49	0.20	0.69
	Body (Hotspot)	0.49	0.20	0.69
DC_7A_n77A	Head	0.13	0.73	0.86
	Body	0.53	0.20	0.73
	Body (Hotspot)	0.53	0.20	0.73
DC_40A_n77A	Head	0.08	0.73	0.81
	Body	0.38	0.20	0.58
	Body (Hotspot)	0.38	0.20	0.58
DC_41A_n77A	Head	0.13	0.73	0.86
	Body	0.45	0.20	0.65
	Body (Hotspot)	0.45	0.20	0.65

Mode(LTE+5G NR)	Position	Reported SAR(W/kg)		ΣSAR < 2.0W/kg
		LTE	5G NR	
DC_66A_n77A	Head	0.17	0.73	0.90
	Body	0.62	0.20	0.82
	Body (Hotspot)	0.62	0.20	0.82
DC_2A_n78A	Head	0.11	0.73	0.84
	Body	0.58	0.20	0.78
	Body (Hotspot)	0.58	0.20	0.78
DC_4A_n78A	Head	0.17	0.73	0.90
	Body	0.62	0.20	0.82
	Body (Hotspot)	0.62	0.20	0.82
DC_5A_n78A	Head	0.28	0.73	1.01
	Body	0.49	0.20	0.69
	Body (Hotspot)	0.49	0.20	0.69
DC_7A_n78A	Head	0.13	0.73	0.86
	Body	0.53	0.20	0.73
	Body (Hotspot)	0.53	0.20	0.73
DC_38A_n78A	Head	0.13	0.73	0.86
	Body	0.45	0.20	0.65
	Body (Hotspot)	0.45	0.20	0.65
DC_40A_n78A	Head	0.08	0.73	0.81
	Body	0.38	0.20	0.58
	Body (Hotspot)	0.38	0.20	0.58
DC_41A_n78A	Head	0.13	0.73	0.86
	Body	0.45	0.20	0.65
	Body (Hotspot)	0.45	0.20	0.65
DC_66A_n78A	Head	0.17	0.73	0.90
	Body	0.62	0.20	0.82
	Body (Hotspot)	0.62	0.20	0.82

Note:

For the EIRP of NFC is 0.001mW, per KDB447498 D01 clause 4.3, the estimated SAR is so lower, so the NFC almost have no influence on the results of simultaneous transmission.

Conclusion:

Sum of SAR: ΣSAR ≤1.6 W/kg therefore simultaneous transmission SAR with Volume Scans is **not required**.

SAR Plots

Please Refer to the Attachment.

APPENDIX A MEASUREMENT UNCERTAINTY

The uncertainty budget has been determined for the measurement system and is given in the following Table.

Measurement uncertainty evaluation for IEEE1528-2013 SAR test

Source of uncertainty	Tolerance/ uncertainty ± %	Probability distribution	Divisor	ci (1 g)	ci (10 g)	Standard uncertainty ± %, (1 g)	Standard uncertainty ± %, (10 g)
Measurement system							
Probe calibration	13.9	N	1	1	1	13.9	13.9
Axial Isotropy	4.7	R	√3	1	1	2.7	2.7
Hemispherical Isotropy	9.6	R	√3	0	0	0.0	0.0
Boundary effect	1.0	R	√3	1	1	0.6	0.6
Linearity	4.7	R	√3	1	1	2.7	2.7
Detection limits	1.0	R	√3	1	1	0.6	0.6
Modulation response	4.0	R	√3	1	1	2.3	2.3
Readout electronics	0.3	N	1	1	1	0.3	0.3
Response time	0.0	R	√3	1	1	0.0	0.0
Integration time	0.0	R	√3	1	1	0.0	0.0
RF ambient conditions – noise	1.0	R	√3	1	1	0.6	0.6
RF ambient conditions–reflections	1.0	R	√3	1	1	0.6	0.6
Probe positioner mech. Restrictions	0.8	R	√3	1	1	0.5	0.5
Probe positioning with respect to phantom shell	6.7	R	√3	1	1	3.9	3.9
Extrapolation, interpolation, and integrations algorithms for max. SAR evaluation	3.9	R	√3	1	1	2.3	2.3
Test sample related							
Test sample positioning	2.8	N	1	1	1	2.8	2.8
Device holder uncertainty	6.3	N	1	1	1	6.3	6.3
Drift of output power	5.0	R	√3	1	1	2.9	2.9
SAR scaling	2.0	R	√3	1	1	1.2	1.2
Phantom and tissue parameters							
Phantom uncertainty (shape and thickness tolerances)	4.0	R	√3	1	1	2.3	2.3
Uncertainty in SAR correction for deviations in permittivity and conductivity	1.9	N	1	1	0.84	1.9	1.6
Liquid conductivity measurement	5.5	N	1	0.78	0.71	4.3	3.9
Liquid permittivity measurement	2.9	N	1	0.23	0.26	0.7	0.8
Liquid conductivity—temperature uncertainty	1.7	R	√3	0.78	0.71	0.8	0.7
Liquid permittivity—temperature uncertainty	2.7	R	√3	0.23	0.26	0.4	0.4
Combined standard uncertainty		RSS				12.2	12.0
Expanded uncertainty 95 % confidence interval)						24.3	23.9

APPENDIX B EUT TEST POSITION PHOTOS

Please Refer to the Attachment.

APPENDIX C CALIBRATION CERTIFICATES

Please Refer to the Attachment.

******* END OF REPORT *******