



For Question,
Please Contact with WSCT
www.wsct-cert.com

TEST REPORT

FCC ID: 2AIZN-X609B

Product: Mobile Phone

Model No.: X609B

Additional Model No.: N/A

Trade Mark: Infinix

Report No.: FCC18080068A-BT

Issued Date: Oct. 16, 2018

Issued for:

**INFINIX MOBILITY LIMITED
RMS 05-15, 13A/F SOUTH TOWER WORLD FINANCE CTR HARBOUR CITY 17
CANTON RD TST KLN HONG KONG**

Issued By:

**World Standardization Certification & Testing Group Co., Ltd.
Building A-B, Baoshi Science & Technology Park, Baoshi Road,
Bao'an District, Shenzhen, Guangdong, China**

TEL: +86-755-26996192

FAX: +86-755-86376605



Note: The results contained in this report pertain only to the tested sample. This report shall not be reproduced, except in full, without written approval of World Standardization Certification & Testing Group Co., Ltd. This report must not be used by the client to claim product certification, approval, or endorsement by NVLAP, NIST, or any agency of the U.S. Government.





Table of Contents

1. GENERAL INFORMATION	3
1.1 GENERAL DESCRIPTION OF EUT	4
1.2 FACILITIES AND ACCREDITATIONS	5
1.3 DESCRIPTION OF TEST MODES	6
1.4 TABLE OF PARAMETERS OF TEXT SOFTWARE SETTING	7
1.5 DESCRIPTION OF SUPPORT UNITS(CONDUCTED MODE)	8
2. SUMMARY OF TEST RESULTS	9
3. MEASUREMENT INSTRUMENTS	10
4. EMC EMISSION TEST	11
4.1 CONDUCTED EMISSION MEASUREMENT	11
4.2 RADIATED EMISSION MEASUREMENT	15
5. NUMBER OF HOPPING CHANNEL	32
5.1 APPLIED PROCEDURES / LIMIT	32
5.2 TEST RESULTS	33
6. AVERAGE TIME OF OCCUPANCY	34
6.1 APPLIED PROCEDURES / LIMIT	34
6.2 TEST RESULTS	36
6. HOPPING CHANNEL SEPARATION MEASUREMENT	42
6.1 APPLIED PROCEDURES / LIMIT	42
6.2 TEST RESULTS	43
7. BANDWIDTH TEST	52
7.1 APPLIED PROCEDURES / LIMIT	52
7.2 TEST RESULTS	53
8. PEAK OUTPUT POWER TEST	62
8.1 APPLIED PROCEDURES / LIMIT	62
8.2 TEST RESULTS	63
9. 100KHZ BAND EDGES MEASUREMENT	68
9.1 APPLIED PROCEDURES / LIMIT	68
10. ANTENNA APPLICATION	79
10.1 ANTENNA REQUIREMENT	79



 For Question,
 Please Contact with WSCT
 www.wsct-cert.com

1. GENERAL INFORMATION

Product:	Mobile phone
Model No.:	X609B
Additional Model:	N/A
Applicant:	INFINIX MOBILITY LIMITED
Address:	RMS 05-15, 13A/F SOUTH TOWER WORLD FINANCE CTR HARBOUR CITY 17 CANTON RD TST KLN HONG KONG
Manufacturer:	SHENZHEN TECNO TECHNOLOGY CO.,LTD.
Address:	1/F-4/F,7/F, BUILDING 3, TAIPINGYANG INDUSTRIAL ZONE, NO.2088, SHENYAN ROAD, YANTIAN DISTRICT, SHENZHEN CITY, GUANGDONG PROVINCE, P.R.C
Data of receipt:	Sep. 26, 2018
Date of Test:	Sep. 26, 2018 to Oct. 15, 2018
Applicable Standards:	FCC CFR Title 47 Part 15 Subpart C Section 15.247

The above equipment has been tested by World Standardization Certification & Testing Group Co., Ltd. and found compliance with the requirements set forth in the technical standards mentioned above. The results of testing in this report apply only to the product/system, which was tested. Other similar equipment will not necessarily produce the same results due to production tolerance and measurement uncertainties.

Tested By: Pu Shixi
 (Pu Shixi)

Date: Oct. 16, 2018

Check By: Qin Shuiquan
 (Qin Shuiquan)

Date: Oct. 16, 2018

Approved By: Wang Fengbing
 (Wang Fengbing)

Date: Oct. 16, 2018



1.1 GENERAL DESCRIPTION OF EUT

Equipment Type:	Mobile Phone
Test Model:	X609B
Additional Model:	N/A
Trade Mark:	Infinix
Applicant:	INFINIX MOBILITY LIMITED
Address:	RMS 05-15, 13A/F SOUTH TOWER WORLD FINANCE CTR HARBOUR CITY 17 CANTON RD TST KLN HONG KONG
Manufacturer:	SHENZHEN TECNO TECHNOLOGY CO.,LTD.
Address:	1/F-4/F,7/F, BUILDING 3, TAIPINGYANG INDUSTRIAL ZONE, NO.2088, SHENYAN ROAD, YANTIAN DISTRICT, SHENZHEN CITY, GUANGDONG PROVINCE, P.R.C
Hardware version:	V1.1
Software version:	X609B-H8025C-GO-180911V46
Extreme Temp. Tolerance:	-10°C to +65°C
Battery information:	Li-Polymer Battery : BL-34BX Voltage: 3.8V Rated Capacity: 3400mAh/12.92Wh Typical Capacity: 3500mAh/13.30Wh Limited Charge Voltage: 4.35V
Adapter Information:	Adapter: CU-52JT Input: AC 100-240V 50/60Hz 200mA Output: DC 5V 1.2A
Operating Frequency	2402-2480MHZ
Channels	79
Channel Spacing	1MHz
Modulation Type	GFSK, $\pi/4$ -DQPSK, 8-DPSK
Version	3.0
Antenna Type:	Integral Antenna
Antenna gain:	1.26dBi





1.2 FACILITIES AND ACCREDITATIONS

All measurement facilities used to collect the measurement data are located at **Building A-B, Baoshi Science & Technology Park, Baoshi Road, Bao'an District, Shenzhen, Guangdong, China of the World Standardization Certification & Testing Group Co., Ltd.**

The sites are constructed in conformance with the requirements of ANSI C63.4 and CISPR Publication 22. All receiving equipment conforms to CISPR Publication 16-1, "Radio Interference Measuring Apparatus and Measurement Methods."

Registration Number: 366353

1.2.1 ACCREDITATIONS

Our laboratories are accredited and approved by the following approval agencies according to ISO/IEC 17025.

- USA** NVLAP (The certificate registration number is NVLAP LAB CODE:600142-0)
- Japan** VCCI (The certificate registration number is C-4790, R-3684, G-837)
- Canada** INDUSTRY CANADA (The certificated registration number is 7700A-1)
- China** CNAS (The certificated registration number is L3732)

Copies of granted accreditation certificates are available for downloading from our web site, <http://www.wsct-cert.com>

1.2.2 TEST DESCRIPTION

1.2.2.1 MEASUREMENT UNCERTAINTY

The reported uncertainty of measurement $y \pm U$, where expanded uncertainty U is based on a standard uncertainty multiplied by a coverage factor of $k=2$, providing a level of confidence of approximately **95 %**.

No.	Item	Uncertainty
1	Conducted Emission Test	$\pm 3.2\text{dB}$
2	RF power,conducted	$\pm 0.16\text{dB}$
3	Spurious emissions,conducted	$\pm 0.21\text{dB}$
4	All emissions,radiated(<1G)	$\pm 4.7\text{dB}$
5	All emissions,radiated(>1G)	$\pm 4.7\text{dB}$
6	Temperature	$\pm 0.5^{\circ}\text{C}$
7	Humidity	$\pm 2\%$





1.3 DESCRIPTION OF TEST MODES

To investigate the maximum EMI emission characteristics generates from EUT, the test system was pre-scanning tested base on the consideration of following EUT operation mode or test configuration mode which possible have effect on EMI emission level. Each of these EUT operation mode(s) or test configuration mode(s) mentioned above was evaluated respectively.

Modulation type	Mode
1Mbps	Mode 1 、 Mode 2 、 Mode 3 、 Mode 4
2Mbps	
3Mbps	

Pretest Mode	Description
Mode 1	CH00
Mode 2	CH39
Mode 3	CH78
Mode 4	Normal Hopping

For Conducted Emission	
Final Test Mode	Description
Mode 4	Normal Hopping

For Radiated Emission	
Final Test Mode	Description
Mode 1	CH00
Mode 2	CH39
Mode 3	CH78
Mode 4	Normal Hopping

Note:

- (1) The measurements are performed at the highest, middle, lowest available channels.
- (2) The data rate was set in 1Mbps,2 Mbps,3 Mbps for radiated emission due to the highest RF output power.
- (3) Record the worst case of each test item in this report.





1.4 TABLE OF PARAMETERS OF TEXT SOFTWARE SETTING

During testing channel & power controlling software provided by the customer was used to control the operating channel as well as the output power level. The RF output power selection is for the setting of RF output power expected by the customer and is going to be fixed on the firmware of the final end product power parameters of FHSS

Test software Version	N/A		
Frequency	2402 MHz	2441 MHz	2480 MHz
Parameters(1Mbps)	DEF	DEF	DEF
Parameters(2Mbps)	DEF	DEF	DEF
Parameters(3Mbps)	DEF	DEF	DEF

1.4.1 CONFIGURATION OF SYSTEM UNDER TEST



(EUT: Mobile Phone)





1.5 DESCRIPTION OF SUPPORT UNITS(CONDUCTED MODE)

The EUT has been tested as an independent unit together with other necessary accessories or support units. The following support units or accessories were used to form a representative test configuration during the tests.

Item	Equipment	Mfr/Brand	Model/Type No.	Series No.	Note
1	Adapter	/	CU-52JT	/	/
2	Earphone	/	N/A	/	/

Note:

- (1) The support equipment was authorized by Declaration of Confirmation.
- (2) For detachable type I/O cable should be specified the length in cm in 『Length』 column.
- (3) “YES” is means “shielded” “with core”; “NO” is means “unshielded” “without core”.





2. SUMMARY OF TEST RESULTS

Test procedures according to the technical standards:

FCC Part15 (15.247) , Subpart C			
Standard Section	Test Item	Judgment	Remark
15.207	Conducted Emission	PASS	
15.247(a)(1)	Hopping Channel Separation	PASS	
15.247(b)(1)	Peak Output Power	PASS	
15.247(c)	Radiated Spurious Emission	PASS	
15.247(a)(iii)	Number of Hopping Frequency	PASS	
15.247(a)(iii)	Dwell Time	PASS	
15.247(a)(1)	Bandwidth	PASS	
15.247(d)	100kHz Band Edges	PASS	
15.205	Band Edge Emission	PASS	
15.203	Antenna Requirement	PASS	

NOTE:

(1) "N/A" denotes test is not applicable in this test report.





3. MEASUREMENT INSTRUMENTS

NAME OF EQUIPMENT	MANUFACTURER	MODEL	SERIAL NUMBER	Calibration Date	Calibration Due.
EMI Test Receiver	R&S	ESCI	100005	08/19/2018	08/18/2019
LISN	AFJ	LS16	16010222119	08/19/2018	08/18/2019
LISN(EUT)	Mestec	AN3016	04/10040	08/19/2018	08/18/2019
Universal Radio Communication Tester	R&S	CMU 200	1100.0008.02	08/19/2018	08/18/2019
Coaxial cable	Megalon	LMR400	N/A	08/12/2018	08/11/2019
GPIB cable	Megalon	GPIB	N/A	08/12/2018	08/11/2019
Spectrum Analyzer	R&S	FSU	100114	08/19/2018	08/18/2019
Pre Amplifier	H.P.	HP8447E	2945A02715	10/13/2018	10/12/2019
Pre-Amplifier	CDSI	PAP-1G18-38	--	10/13/2018	10/12/2019
Bi-log Antenna	SUNOL Sciences	JB3	A021907	09/13/2018	09/12/2019
9*6*6 Anechoic	--	--	--	08/21/2018	08/20/2019
Horn Antenna	COMPLIANCE ENGINEERING	CE18000	--	09/13/2018	09/12/2019
Horn Antenna	SCHWARZBECK	BBHA9120D	9120D-631	08/23/2018	08/22/2019
Cable	TIME MICROWAVE	LMR-400	N-TYPE04	04/25/2018	04/24/2019
System-Controller	CCS	N/A	N/A	N.C.R	N.C.R
Turn Table	CCS	N/A	N/A	N.C.R	N.C.R
Antenna Tower	CCS	N/A	N/A	N.C.R	N.C.R
RF cable	Murata	MXHQ87WA3000	-	08/21/2018	08/20/2019
Loop Antenna	EMCO	6502	00042960	08/22/2018	08/21/2019
Horn Antenna	SCHWARZBECK	BBHA 9170	1123	08/19/2018	08/18/2019
Power meter	Anritsu	ML2487A	6K00003613	08/23/2018	08/22/2019
Power sensor	Anritsu	MX248XD	--	08/19/2018	08/18/2019





4. EMC EMISSION TEST

4.1 CONDUCTED EMISSION MEASUREMENT

4.1.1 POWER LINE CONDUCTED EMISSION Limits (Frequency Range 150KHz-30MHz)

FREQUENCY (MHz)	Conducted limit (dB μ V)		Conducted limit (dB μ V)
	Quasi-peak	Quasi-peak	
0.15 -0.5	66 - 56 *	56 - 46 *	FCC
0.50 -5.0	56.00	46.00	FCC
5.0 -30.0	60.00	50.00	FCC

Note:

- (1) The tighter limit applies at the band edges.
- (2) The limit of " * " marked band means the limitation decreases linearly with the logarithm of the frequency in the range.

The following table is the setting of the receiver

Receiver Parameters	Setting
Attenuation	10 dB
Start Frequency	0.15 MHz
Stop Frequency	30 MHz
IF Bandwidth	9 kHz



4.1.2 TEST PROCEDURE

- a. The EUT was placed 0.4 meters from the horizontal ground plane with EUT being connected to the power mains through a line impedance stabilization network (LISN). All other support equipments powered from additional LISN(s). The LISN provide 50 Ohm/ 50uH of coupling impedance for the measuring instrument.
- b. Interconnecting cables that hang closer than 40 cm to the ground plane shall be folded back and forth in the center forming a bundle 30 to 40 cm long.
- c. I/O cables that are not connected to a peripheral shall be bundled in the center. The end of the cable may be terminated, if required, using the correct terminating impedance. The overall length shall not exceed 1 m.
- d. LISN at least 80 cm from nearest part of EUT chassis.
- e. For the actual test configuration, please refer to the related Item –EUT Test Photos.

4.1.3 DEVIATION FROM TEST STANDARD

No deviation

4.1.4 TEST SETUP

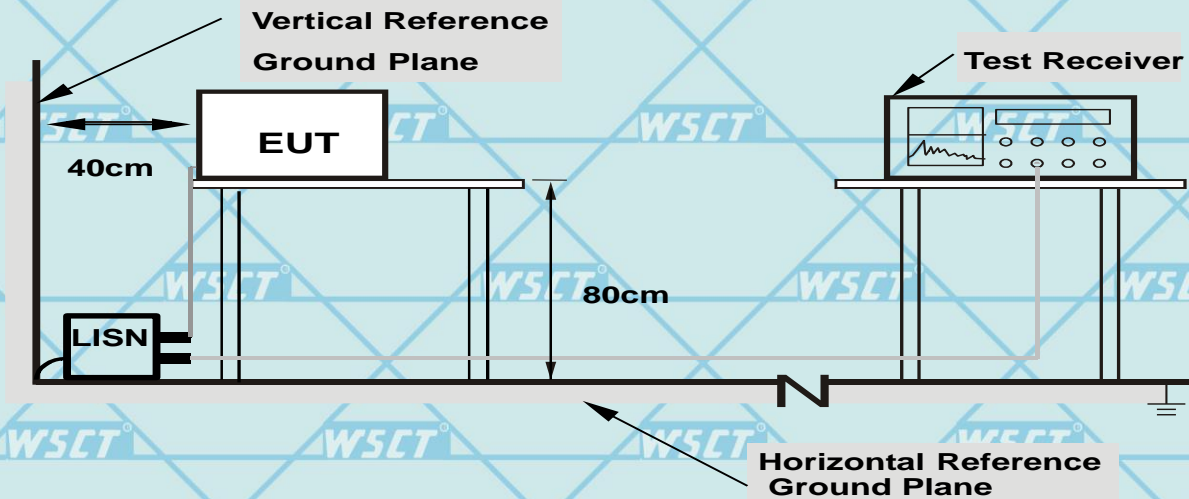

- Note:**
- 1.Support units were connected to second LISN.
 - 2.Both of LISNs (AMN) are 80 cm from EUT and at least 80 from other units and other metal planes

4.1.5 EUT OPERATING CONDITIONS

The EUT was configured for testing in a typical fashion (as a customer would normally use it). The EUT has been programmed to continuously transmit during test. This operating condition was tested and used to collect the included data.





For Question,
Please Contact with WSCT
www.wsct-cert.com

4.1.6 TEST RESULTS

Temperature	26 °C	Relative Humidity	54%
Pressure	1010hPa	Phase	L
Test Mode	Mode 4	Voltage	120V/60Hz

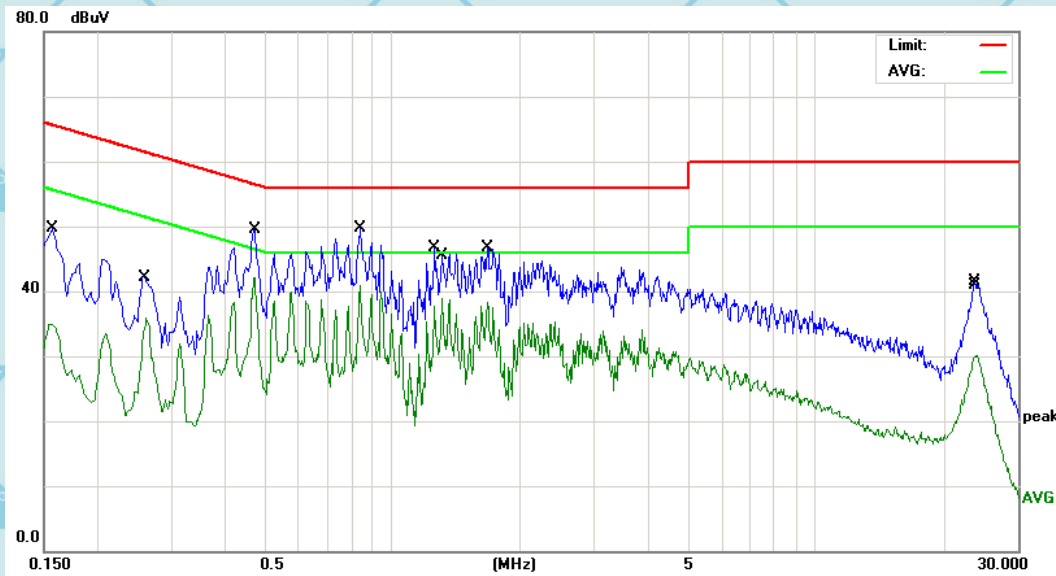

No.	Mk.	Freq. MHz	Reading Level dBuV	Correct Factor dB	Measure- ment dBuV	Limit dBuV	Over dB	Detector
1		0.1580	43.24	10.44	53.68	65.56	-11.88	QP
2		0.2620	25.48	10.43	35.91	51.36	-15.45	AVG
3	*	0.4700	31.76	10.40	42.16	46.51	-4.35	AVG
4		0.4740	36.74	10.40	47.14	56.44	-9.30	QP
5		0.8380	37.06	10.36	47.42	56.00	-8.58	QP
6		0.8380	30.54	10.36	40.90	46.00	-5.10	AVG
7		1.2579	33.73	10.33	44.06	56.00	-11.94	QP
8		1.3099	28.62	10.32	38.94	46.00	-7.06	AVG
9		1.6740	32.14	10.31	42.45	56.00	-13.55	QP
10		1.6740	27.96	10.31	38.27	46.00	-7.73	AVG
11		23.7540	25.27	10.10	35.37	60.00	-24.63	QP
12		24.0500	19.95	10.10	30.05	50.00	-19.95	AVG

Remark: All the modes have been investigated, and only worst mode is presented in this report.





For Question,
Please Contact with WSCT
www.wsct-cert.com

Temperature	26 °C	Relative Humidity	54%
Pressure	1010hPa	Phase	N
Test Mode	Mode 4	Voltage	120V/60Hz

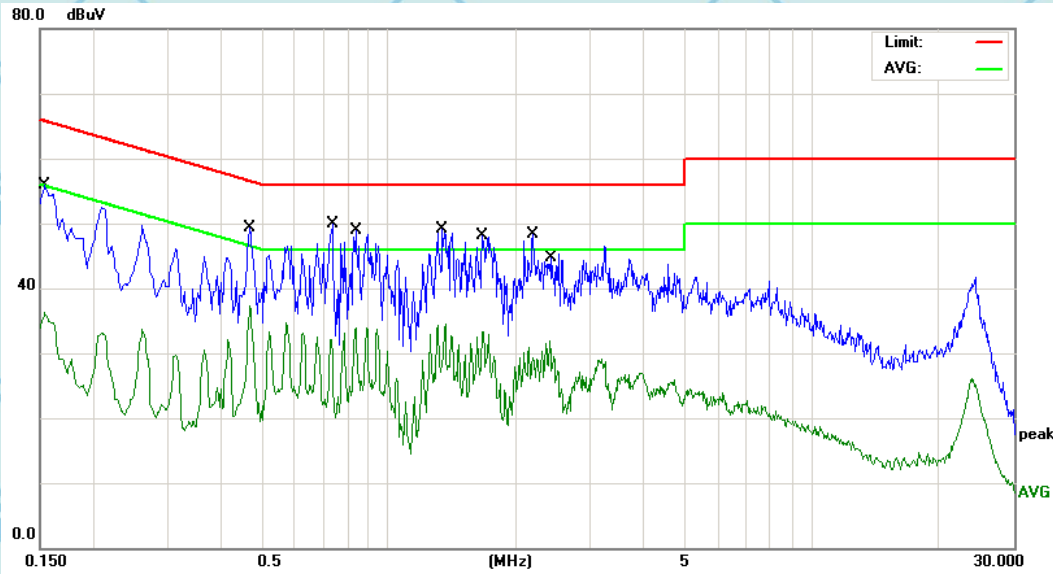

No.	Mk.	Freq. MHz	Reading Level dBuV	Correct Factor dB	Measure- ment dBuV	Limit dBuV	Over dB	Detector
1		0.1539	36.10	10.44	46.54	65.78	-19.24	QP
2		0.1539	25.84	10.44	36.28	55.78	-19.50	AVG
3		0.4700	33.73	10.40	44.13	56.51	-12.38	QP
4	*	0.4700	26.84	10.40	37.24	46.51	-9.27	AVG
5		0.7380	31.77	10.37	42.14	56.00	-13.86	QP
6		0.8380	23.62	10.36	33.98	46.00	-12.02	AVG
7		1.3420	29.23	10.32	39.55	56.00	-16.45	QP
8		1.3619	24.11	10.32	34.43	46.00	-11.57	AVG
9		1.6700	31.26	10.31	41.57	56.00	-14.43	QP
10		1.6740	22.99	10.31	33.30	46.00	-12.70	AVG
11		2.1980	27.65	10.29	37.94	56.00	-18.06	QP
12		2.4060	21.55	10.28	31.83	46.00	-14.17	AVG

Remark: All the modes have been investigated, and only worst mode is presented in this report.





4.2 RADIATED EMISSION MEASUREMENT

4.2.1 Radiated Emission Limits (Frequency Range 9kHz-1000MHz)

20dBc in any 100 kHz bandwidth outside the operating frequency band. In case the emission fall within the restricted band specified on 15.205(a), then the 15.209(a) limit in the table below has to be followed.

Frequencies (MHz)	Field Strength (micorvolts/meter)	Measurement Distance (meters)
0.009~0.490	2400/F(KHz)	300
0.490~1.705	24000/F(KHz)	30
1.705~30.0	30	30
30~88	100	3
88~216	150	3
216~960	200	3
Above 960	500	3

LIMITS OF RADIATED EMISSION MEASUREMENT (Above 1000MHz)

FREQUENCY (MHz)	Limit (dBuV/m) (at 3M)	
	PEAK	AVERAGE
Above 1000	74	54

Notes:

- (1) The limit for radiated test was performed according to FCC PART 15C.
- (2) The tighter limit applies at the band edges.
- (3) Emission level (dBuV/m)=20log Emission level (uV/m).

Spectrum Parameter	Setting
Attenuation	Auto
Start Frequency	1000 MHz
Stop Frequency	10th carrier harmonic
RB / VB (emission in restricted band)	1MHz / 1MHz for Peak, 1 MHz / 1Hz for Average

Receiver Parameter	Setting
Attenuation	Auto
Start ~ Stop Frequency	9kHz~150kHz / RB 200Hz for QP
Start ~ Stop Frequency	150kHz~30MHz / RB 9kHz for QP
Start ~ Stop Frequency	30MHz~1000MHz / RB 120kHz for QP



4.2.2 TEST PROCEDURE

- a. The measuring distance of at 3 m shall be used for measurements at frequency up to 1GHz. For frequencies above 1GHz, any suitable measuring distance may be used.
- b. The EUT was placed on the top of a rotating table 0.8 meters above the ground at a 3 meter open area test site. The table was rotated 360 degrees to determine the position of the highest radiation.
- c. The height of the equipment or of the substitution antenna shall be 0.8 m; the height of the test antenna shall vary between 1 m to 4 m. Both horizontal and vertical polarizations of the antenna are set to make the measurement.
- d. The initial step in collecting conducted emission data is a spectrum analyzer peak detector mode pre-scanning the measurement frequency range. Significant peaks are then marked and then Quasi Peak detector mode re-measured.
- e. If the Peak Mode measured value compliance with and lower than Quasi Peak Mode Limit, the EUT shall be deemed to meet QP Limits and then no additional QP Mode measurement performed.
- f. For the actual test configuration, please refer to the related Item –EUT Test Photos.

Note:

Both horizontal and vertical antenna polarities were tested and performed pretest to three orthogonal axis. The worst case emissions were reported

4.2.3 DEVIATION FROM TEST STANDARD

No deviation





4.2.4 TEST SETUP

(A) Radiated Emission Test-Up Frequency Below 30MHz

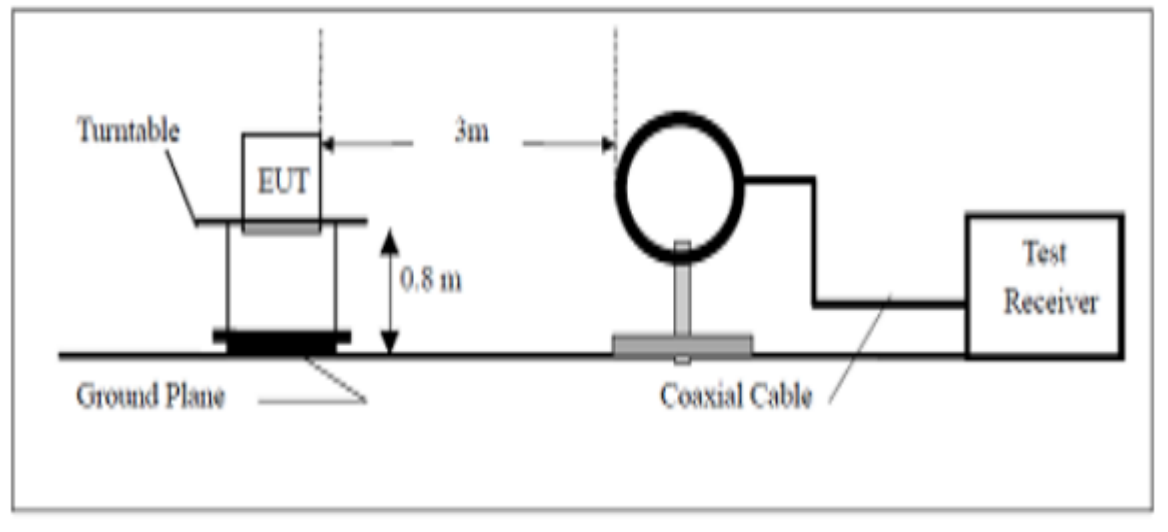

(B) Radiated Emission Test-Up Frequency 30MHz~1GHz

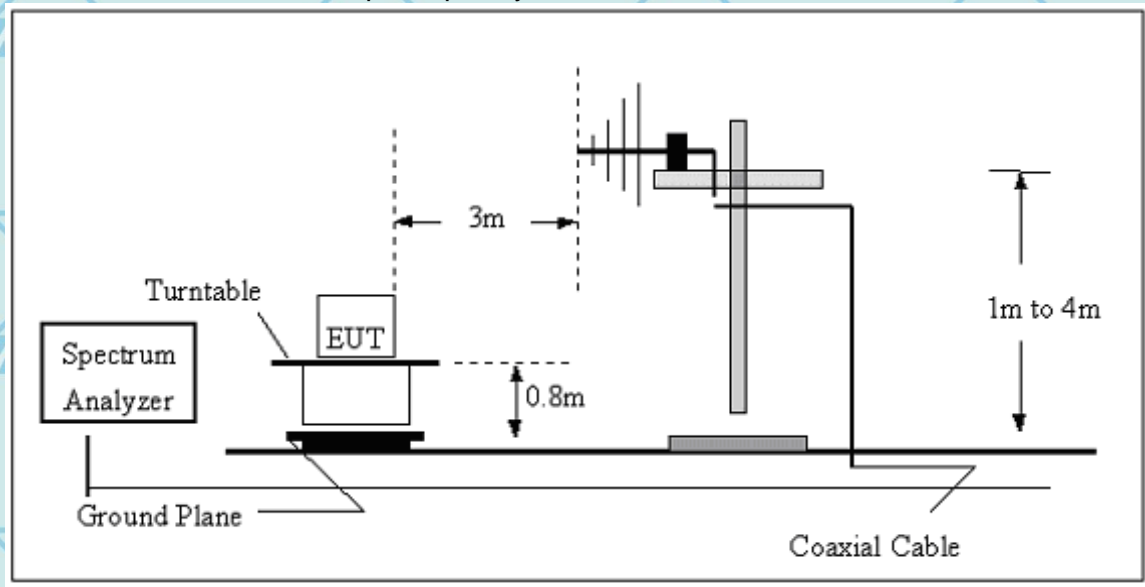



(C) Radiated Emission Test-Up Frequency Above 1GHz

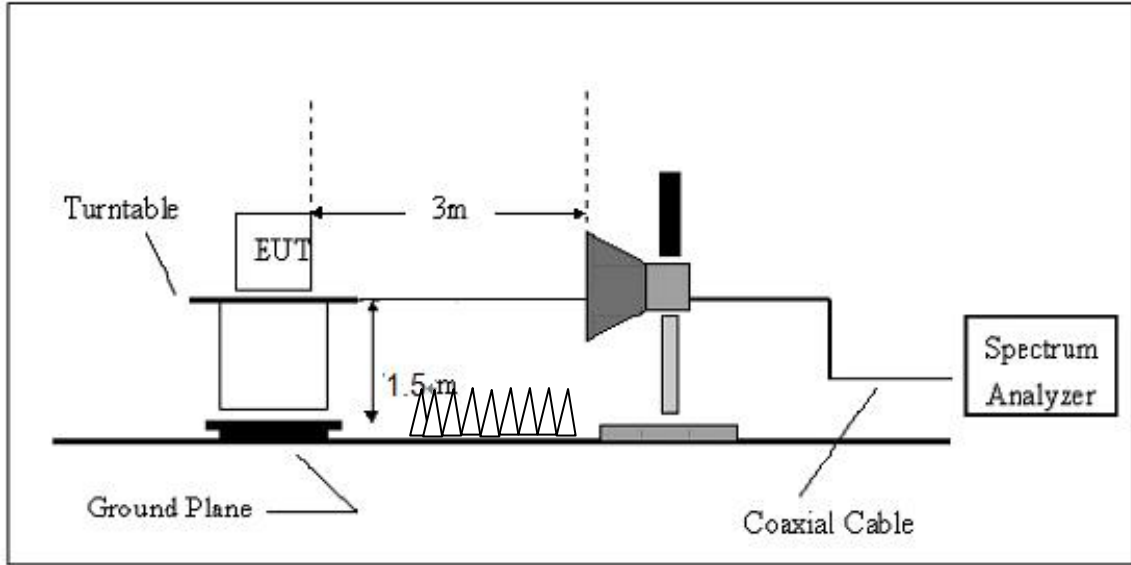

4.2.5 EUT OPERATING CONDITIONS

The EUT tested system was configured as the statements of 2.4 Unless otherwise a special operating condition is specified in the follows during the testing.





For Question,
Please Contact with WSCT
www.wsct-cert.com

4.2.5.1 RESULTS (Below 30 MHz)

Test Mode	Mode 1/ Mode 2/ Mode 3	Polarization	Horizontal / Vertical
Temperature	20 °C	Relative Humidity	48%
Pressure	1010 hPa		

Freq. (MHz)	Reading (dBuV/m)	Limit (dBuV/m)	Margin (dB)	State P/F
--	--	--	--	P
--	--	--	--	P

NOTE:

No result in this part for margin above 20dB.
 Distance extrapolation factor =40 log (specific distance/test distance)(dB);
 Limit line = specific limits (dBuV) + distance extrapolation factor.
 All the x/y/z orientation has been investigated, and only worst case is presented in this report.





For Question,
Please Contact with WSCT
www.wsct-cert.com

4.2.5.2 TEST RESULTS (Between 30M – 1000 MHz)

Test Mode	Mode 1 with GFSK modulation	Polarization :	Horizontal
Temperature	20 °C	Relative Humidity	48%
Pressure	1010 hPa		

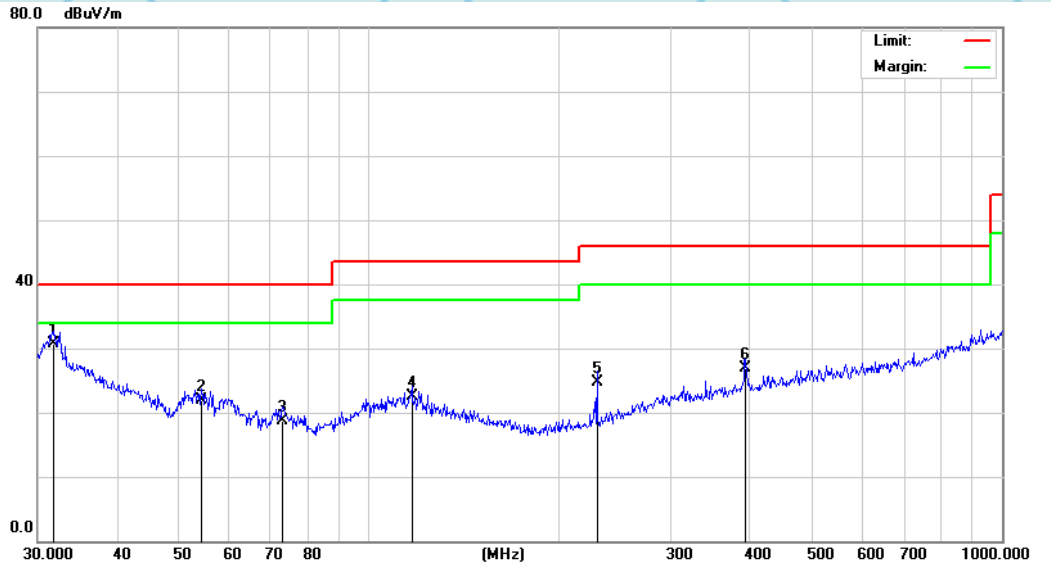

No.	Mk.	Freq. MHz	Reading Level dBuV	Correct Factor dB	Measure- ment dBuV/m	Limit dBuV/m	Over dB	Detector
1	*	31.8427	26.70	4.08	30.78	40.00	-9.22	QP
2		54.4516	27.44	-5.55	21.89	40.00	-18.11	QP
3		73.1025	25.82	-7.06	18.76	40.00	-21.24	QP
4		116.9495	25.07	-2.54	22.53	43.50	-20.97	QP
5		229.2931	30.42	-5.67	24.75	46.00	-21.25	QP
6		393.4723	28.41	-1.56	26.85	46.00	-19.15	QP

Remark: All the modes have been investigated, and only worst mode is presented in this report.





For Question,
Please Contact with WSCT
www.wsct-cert.com

Test Mode	Mode 1 with GFSK modulation	Polarization :	Vertical
Temperature	20 °C	Relative Humidity	48%
Pressure	1010 hPa		



No.	Mk.	Freq. MHz	Reading Level dBuV	Correct Factor dB	Measure- ment dBuV/m	Limit dBuV/m	Over dB	Detector
1	*	31.3992	27.69	4.26	31.95	40.00	-8.05	QP
2		54.4516	34.31	-5.55	28.76	40.00	-11.24	QP
3		104.1701	25.49	-3.01	22.48	43.50	-21.02	QP
4		159.7844	23.60	-5.77	17.83	43.50	-25.67	QP
5		315.4808	23.89	-2.06	21.83	46.00	-24.17	QP
6		522.7180	25.16	0.68	25.84	46.00	-20.16	QP

Remark: All the modes have been investigated, and only worst mode is presented in this report.





For Question,
Please Contact with WSCT
www.wsct-cert.com

4.2.5.3 TEST RESULTS(1GHz to 25GHz)

Pressure	1010 hPa	Test Mode	Mode 1 TX(1Mbps)
Temperature	20 °C	Relative Humidity	48%

Freq. (MHz)	Ant.Pol.	Emission Level(dBuV)		Limit 3m(dBuV/m)		Over(dB)	
		PK	AV	PK	AV	PK	AV
4804	V	59.69	40.71	74	54	-14.31	-13.29
7206	V	58.73	40.53	74	54	-15.27	-13.47
4804	H	59.73	39.67	74	54	-14.27	-14.33
7206	H	59.53	40.53	74	54	-14.47	-13.47

Remark:

All emissions not reported were more than 20dB below the specified limit or in the noise floor.





Pressure	1010 hPa	Test Mode	Mode 2 TX(2Mbps)
Temperature	20 °C	Relative Humidity	48%

Freq. (MHz)	Ant.Pol.	Emission Level(dBuV)		Limit 3m(dBuV/m)		Over(dB)	
		PK	AV	PK	AV	PK	AV
4882	V	58.57	41.46	74	54	-15.43	-12.54
7323	V	59.34	40.31	74	54	-14.66	-13.69
4882	H	58.09	39.53	74	54	-15.91	-14.47
7323	H	59.83	40.83	74	54	-14.17	-13.17

Remark:

All emissions not reported were more than 20dB below the specified limit or in the noise floor.

Pressure	1010 hPa	Test Mode	Mode 3 TX(3Mbps)
Temperature	20 °C	Relative Humidity	48%

Freq. (MHz)	Ant.Pol.	Emission Level(dBuV)		Limit 3m(dBuV/m)		Over(dB)	
		PK	AV	PK	AV	PK	AV
4960	V	59.34	40.86	74	54	-14.66	-13.14
7440	V	58.37	39.89	74	54	-15.63	-14.11
4960	H	59.95	39.73	74	54	-14.05	-14.27
7440	H	58.29	39.29	74	54	-15.71	-14.71

Remark:

All emissions not reported were more than 20dB below the specified limit or in the noise floor.





4.2.5.4 TEST RESULTS (Restricted Bands Requirements)

Test result for 1Mbps Mode:

Polarization	Vertical	Test Mode	TX /Mode1-1Mbps(CH0)
Temperature	20 °C	Relative Humidity	48%
Pressure	1010 hPa		

Frequency (MHz)	Meter Reading (dBμV)	Factor (dB)	Emission Level (dBμV/m)	Limits (dBμV/m)	Margin (dB)	Detector Type
2387	63.22	-8.76	54.46	74	19.54	peak
2387	54.57	-8.76	45.81	54	8.19	AVG
2390	63.65	-8.73	54.92	74	19.08	peak
2390	54.05	-8.73	45.32	54	8.68	AVG

Remark:
 Factor = Antenna Factor + Cable Loss – Pre-amplifier.
 All the x/y/z orientation has been investigated, and only worst case is presented in this report.

Polarization	Horizontal	Test Mode	TX /Mode1-1Mbps(CH0)
Temperature	20 °C	Relative Humidity	48%
Pressure	1010 hPa		

Frequency (MHz)	Meter Reading (dBμV)	Factor (dB)	Emission Level (dBμV/m)	Limits (dBμV/m)	Margin (dB)	Detector Type
2384	60.61	-8.76	51.85	74	22.15	peak
2384	55.93	-8.76	47.17	54	6.83	AVG
2390	63.03	-8.73	54.30	74	19.70	peak
2390	57.52	-8.73	48.79	54	5.21	AVG

Remark:
 Factor = Antenna Factor + Cable Loss – Pre-amplifier.
 All the x/y/z orientation has been investigated, and only worst case is presented in this report.





Polarization	Vertical	Test Mode	TX /Mode 3-1Mbps(CH78)
Temperature	20 °C	Relative Humidity	48%
Pressure	1010 hPa		

Frequency (MHz)	Meter Reading (dBμV)	Factor (dB)	Emission Level (dBμV/m)	Limits (dBμV/m)	Margin (dB)	Detector Type
2483.5	61.57	-8.17	53.40	74	20.60	peak
2483.5	53.41	-8.17	45.24	54	8.76	AVG

Remark:
 Factor = Antenna Factor + Cable Loss – Pre-amplifier.
 All the x/y/z orientation has been investigated, and only worst case is presented in this report.

Polarization	Horizontal	Test Mode	TX /Mode 3-1Mbps(CH78)
Temperature	20 °C	Relative Humidity	48%
Pressure	1010 hPa		

Frequency (MHz)	Meter Reading (dBμV)	Factor (dB)	Emission Level (dBμV/m)	Limits (dBμV/m)	Margin (dB)	Detector Type
2483.5	60.09	-8.17	51.92	74	22.08	peak
2483.5	54.46	-8.17	46.29	54	7.71	AVG

Remark:
 Factor = Antenna Factor + Cable Loss – Pre-amplifier.
 All the x/y/z orientation has been investigated, and only worst case is presented in this report.



Test result for 2Mbps Mode:

Polarization	Vertical	Test Mode	TX /Mode1-2Mbps(CH0)
Temperature	20 °C	Relative Humidity	48%
Pressure	1010 hPa		

Frequency (MHz)	Meter Reading (dBμV)	Factor (dB)	Emission Level (dBμV/m)	Limits (dBμV/m)	Margin (dB)	Detector Type
2387	61.07	-8.76	52.31	74	21.69	peak
2387	55.64	-8.76	46.88	54	7.12	AVG
2390	63.13	-8.73	54.40	74	19.60	peak
2390	57.17	-8.73	48.44	54	5.56	AVG

Remark:
 Factor = Antenna Factor + Cable Loss – Pre-amplifier.
 All the x/y/z orientation has been investigated, and only worst case is presented in this report.

Polarization	Horizontal	Test Mode	TX /Mode1-2Mbps(CH0)
Temperature	20 °C	Relative Humidity	48%
Pressure	1010 hPa		

Frequency (MHz)	Meter Reading (dBμV)	Factor (dB)	Emission Level (dBμV/m)	Limits (dBμV/m)	Margin (dB)	Detector Type
2384	61.89	-8.76	53.13	74	20.87	peak
2384	56.27	-8.76	47.51	54	6.49	AVG
2390	62.35	-8.73	53.62	74	20.38	peak
2390	56.66	-8.73	47.93	54	6.07	AVG

Remark:
 Factor = Antenna Factor + Cable Loss – Pre-amplifier.
 All the x/y/z orientation has been investigated, and only worst case is presented in this report.





Polarization	Vertical	Test Mode	TX /Mode3-2Mbps(CH78)
Temperature	20 °C	Relative Humidity	48%
Pressure	1010 hPa		

Frequency (MHz)	Meter Reading (dBμV)	Factor (dB)	Emission Level (dBμV/m)	Limits (dBμV/m)	Margin (dB)	Detector Type
2483.5	60.01	-8.17	51.84	74	22.16	peak
2483.5	53.82	-8.17	45.65	54	8.35	AVG

Remark:
 Factor = Antenna Factor + Cable Loss – Pre-amplifier.
 All the x/y/z orientation has been investigated, and only worst case is presented in this report.

Polarization	Horizontal	Test Mode	TX /Mode3-2Mbps(CH78)
Temperature	20 °C	Relative Humidity	48%
Pressure	1010 hPa		

Frequency (MHz)	Meter Reading (dBμV)	Factor (dB)	Emission Level (dBμV/m)	Limits (dBμV/m)	Margin (dB)	Detector Type
2483.5	60.09	-8.17	51.92	74	22.08	peak
2483.5	54.45	-8.17	46.28	54	7.72	AVG

Remark:
 Factor = Antenna Factor + Cable Loss – Pre-amplifier.
 All the x/y/z orientation has been investigated, and only worst case is presented in this report.



Test result for 3Mbps Mode:

Polarization	Vertical	Test Mode	TX /Model 1-3Mbps(CH0)
Temperature	20 °C	Relative Humidity	48%
Pressure	1010 hPa		

Frequency (MHz)	Meter Reading (dBμV)	Factor (dB)	Emission Level (dBμV/m)	Limits (dBμV/m)	Margin (dB)	Detector Type
2387	61.45	-8.76	52.69	74	21.31	peak
2387	53.67	-8.76	44.91	54	9.09	AVG
2390	62.38	-8.73	53.65	74	20.35	peak
2390	56.76	-8.73	48.03	54	5.97	AVG

Remark:

Factor = Antenna Factor + Cable Loss – Pre-amplifier.

All the x/y/z orientation has been investigated, and only worst case is presented in this report.

Polarization	Horizontal	Test Mode	TX /Mode 1-3Mbps(CH0)
Temperature	20 °C	Relative Humidity	48%
Pressure	1010 hPa		

Frequency (MHz)	Meter Reading (dBμV)	Factor (dB)	Emission Level (dBμV/m)	Limits (dBμV/m)	Margin (dB)	Detector Type
2384	63.73	-8.76	54.97	74	19.03	peak
2384	54.07	-8.76	45.31	54	8.69	AVG
2390	62.60	-8.73	53.87	74	20.13	peak
2390	57.94	-8.73	49.21	54	4.79	AVG

Remark:

Factor = Antenna Factor + Cable Loss – Pre-amplifier.

All the x/y/z orientation has been investigated, and only worst case is presented in this report.





Polarization	Vertical	Test Mode	TX /Model 3-3Mbps(CH78)
Temperature	20 °C	Relative Humidity	48%
Pressure	1010 hPa		

Frequency (MHz)	Meter Reading (dBμV)	Factor (dB)	Emission Level (dBμV/m)	Limits (dBμV/m)	Margin (dB)	Detector Type
2483.5	62.07	-8.17	53.90	74	20.10	peak
2483.5	54.04	-8.17	45.87	54	8.13	AVG

Remark:
 Factor = Antenna Factor + Cable Loss – Pre-amplifier.
 All the x/y/z orientation has been investigated, and only worst case is presented in this report.

Polarization	Horizontal	Test Mode	TX /Model 3-3Mbps(CH78)
Temperature	20 °C	Relative Humidity	48%
Pressure	1010 hPa		

Frequency (MHz)	Meter Reading (dBμV)	Factor (dB)	Emission Level (dBμV/m)	Limits (dBμV/m)	Margin (dB)	Detector Type
2483.5	63.22	-8.17	55.05	74	18.95	peak
2483.5	54.99	-8.17	46.82	54	7.18	AVG

Remark:
 Factor = Antenna Factor + Cable Loss – Pre-amplifier.
 All the x/y/z orientation has been investigated, and only worst case is presented in this report.



Test result for hopping mode:

Polarization	Vertical	Test Mode	hopping mode-1Mbps
Temperature	20 °C	Relative Humidity	48%
Pressure	1010 hPa		

Frequency (MHz)	Meter Reading (dBμV)	Factor (dB)	Emission Level (dBμV/m)	Limits (dBμV/m)	Margin (dB)	Detector Type
2387	60.59	-8.76	51.83	74	22.17	peak
2387	55.67	-8.76	46.91	54	7.09	AVG
2390	63.32	-8.73	54.59	74	19.41	peak
2390	57.53	-8.73	48.80	54	5.20	AVG

Remark:
 Factor = Antenna Factor + Cable Loss – Pre-amplifier.
 All the x/y/z orientation has been investigated, and only worst case is presented in this report.

Polarization	Horizontal	Test Mode	Hopping mode-1Mbps
Temperature	20 °C	Relative Humidity	48%
Pressure	1010 hPa		

Frequency (MHz)	Meter Reading (dBμV)	Factor (dB)	Emission Level (dBμV/m)	Limits (dBμV/m)	Margin (dB)	Detector Type
2387	62.23	-8.76	53.47	74	20.53	peak
2387	53.54	-8.76	44.78	54	9.22	AVG
2390	63.70	-8.73	54.97	74	19.03	peak
2390	57.72	-8.73	48.99	54	5.01	AVG

Remark:
 Factor = Antenna Factor + Cable Loss – Pre-amplifier.
 All the x/y/z orientation has been investigated, and only worst case is presented in this report.





Polarization	Vertical	Test Mode	Hopping mode-1Mbps
Temperature	20 °C	Relative Humidity	48%
Pressure	1010 hPa		

Frequency (MHz)	Meter Reading (dBμV)	Factor (dB)	Emission Level (dBμV/m)	Limits (dBμV/m)	Margin (dB)	Detector Type
2483.5	60.65	-8.17	52.48	74	21.52	peak
2483.5	53.44	-8.17	45.27	54	8.73	AVG

Remark:
 Factor = Antenna Factor + Cable Loss – Pre-amplifier.
 All the x/y/z orientation has been investigated, and only worst case is presented in this report.

Polarization	Horizontal	Test Mode	Hopping mode-1Mbps
Temperature	20 °C	Relative Humidity	48%
Pressure	1010 hPa		

Frequency (MHz)	Meter Reading (dBμV)	Factor (dB)	Emission Level (dBμV/m)	Limits (dBμV/m)	Margin (dB)	Detector Type
2483.5	64.30	-8.17	56.13	74	17.87	peak
2483.5	54.01	-8.17	45.84	54	8.16	AVG

Remark:
 Factor = Antenna Factor + Cable Loss – Pre-amplifier.
 All the x/y/z orientation has been investigated, and only worst case is presented in this report.





5. NUMBER OF HOPPING CHANNEL

5.1 APPLIED PROCEDURES / LIMIT

FCC Part15 (15.247) , Subpart C				
Section	Test Item	Limit	Frequency Range (MHz)	Result
15.247 (a)(1)(iii)	Number of Hopping Channel	≥15	2400-2483.5	PASS

Spectrum Parameters	Setting
Attenuation	Auto
Span Frequency	> Operating Frequency Range
RB	1MHz
VB	3MHz
Detector	Peak
Trace	Max Hold
Sweep Time	Auto

5.1.1 TEST PROCEDURE

- a. The EUT was directly connected to the spectrum analyzer and antenna output port as show in the block diagram below,
- b. Spectrum Setting: RBW= 1MHz, VBW=3MHz, Sweep time = Auto.

5.1.2 DEVIATION FROM STANDARD

No deviation.

5.1.3 TEST SETUP

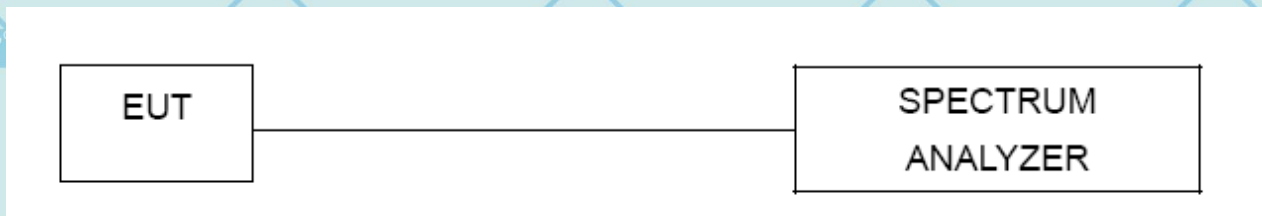

5.1.4 EUT OPERATION CONDITIONS

The EUT tested system was configured as the statements of 2.4 Unless otherwise a special operating condition is specified in the follows during the testing.



For Question,
Please Contact with WSCT
www.wsct-cert.com

5.2 TEST RESULTS

Number of Hopping Channel	79	Test Mode	Hopping Mode
Temperature	25°C	Relative Humidity	60%
Pressure	1015 hPa		

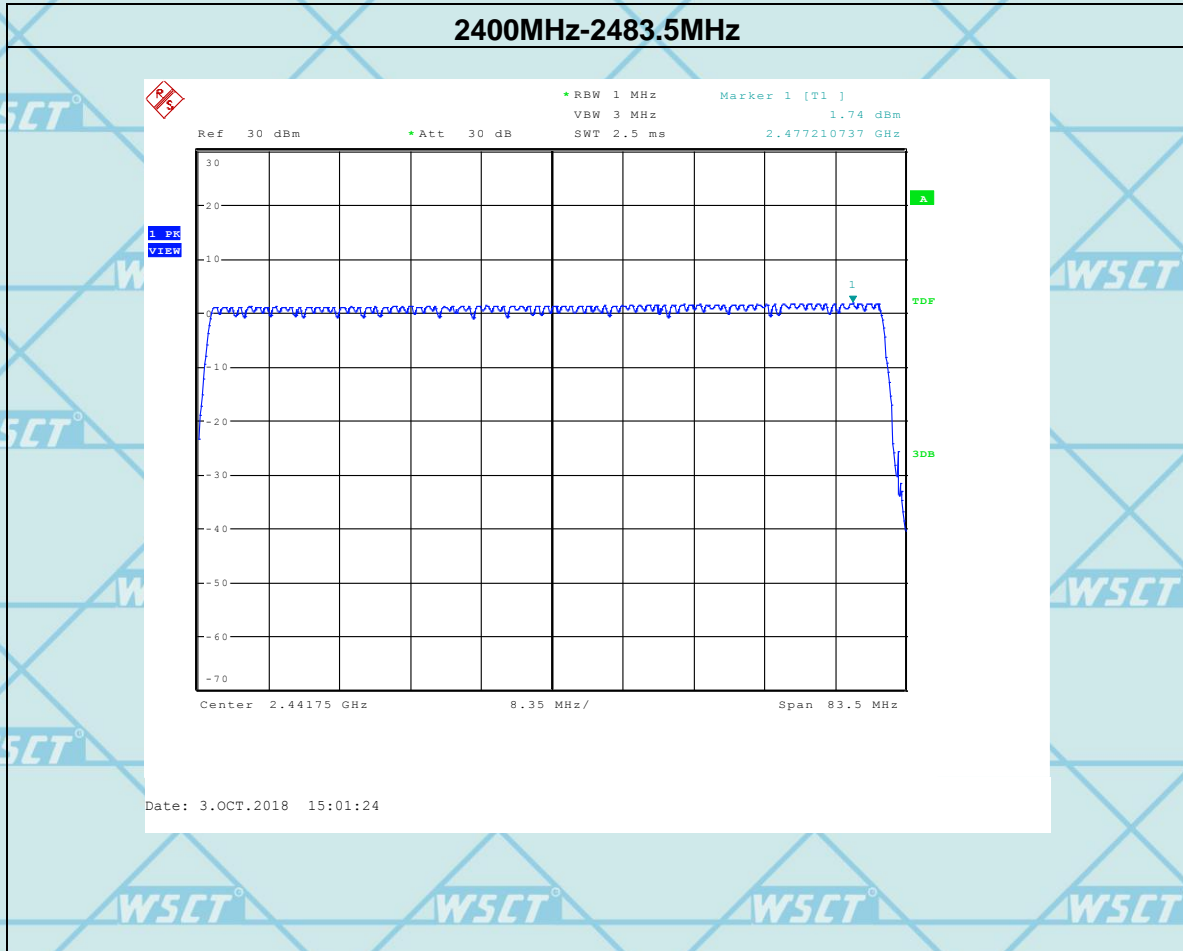



6. AVERAGE TIME OF OCCUPANCY

6.1 APPLIED PROCEDURES / LIMIT

FCC Part15 (15.247) , Subpart C				
Section	Test Item	Limit	Frequency Range (MHz)	Result
15.247 (a)(1)(iii)	Average Time of Occupancy	0.4sec	2400-2483.5	PASS

6.1.2 TEST PROCEDURE

- The EUT test port was connected to the spectrum analyzer with RF cable and antenna connector.
- Set RBW of spectrum analyzer to 1MHz and VBW to 3MHz.
- Use a video trigger with the trigger level set to enable triggering only on full pulses.
- Sweep Time is more than once pulse time.
- Set the center frequency on any frequency would be measure and set the frequency span to zero span.
- Measure the maximum time duration of one single pulse.
- Set the EUT for DH5, DH3 and DH1 packet transmitting.
- Measure the maximum time duration of one single pulse.
- $DH1 \text{ Dwell time} = \text{Pulse time} * (1600/2/79) * 31.6S$
 $DH3 \text{ Dwell time} = \text{Pulse time} * (1600/4/79) * 31.6S$
 $DH5 \text{ Dwell time} = \text{Pulse time} * (1600/6/79) * 31.6S$

6.1.3 DEVIATION FROM STANDARD

No deviation.





6.1.4 TEST SETUP

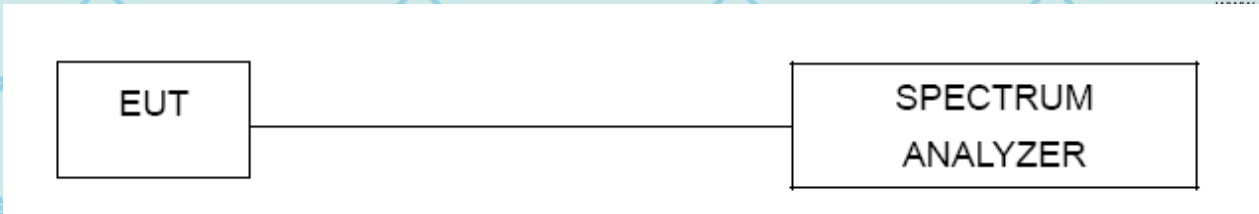

6.1.5 EUT OPERATION CONDITIONS

The EUT tested system was configured as the statements of 2.4 Unless otherwise a special operating condition is specified in the follows during the testing.





For Question,
Please Contact with WSCT
www.wsct-cert.com

6.2 TEST RESULTS

Note: *the worst case is 1Mbps as result in this part.*

Pressure	1012 hPa	Test Mode	DH1-1Mbps
Temperature	25°C	Relative Humidity	60%

Data Packet	Frequency	Pulse time(ms)	Dwell Time(S)	Limits (S)
DH1	2402MHz	0.563	0.180	0.4
DH1	2441MHz	0.563	0.180	0.4
DH1	2480MHz	0.563	0.180	0.4

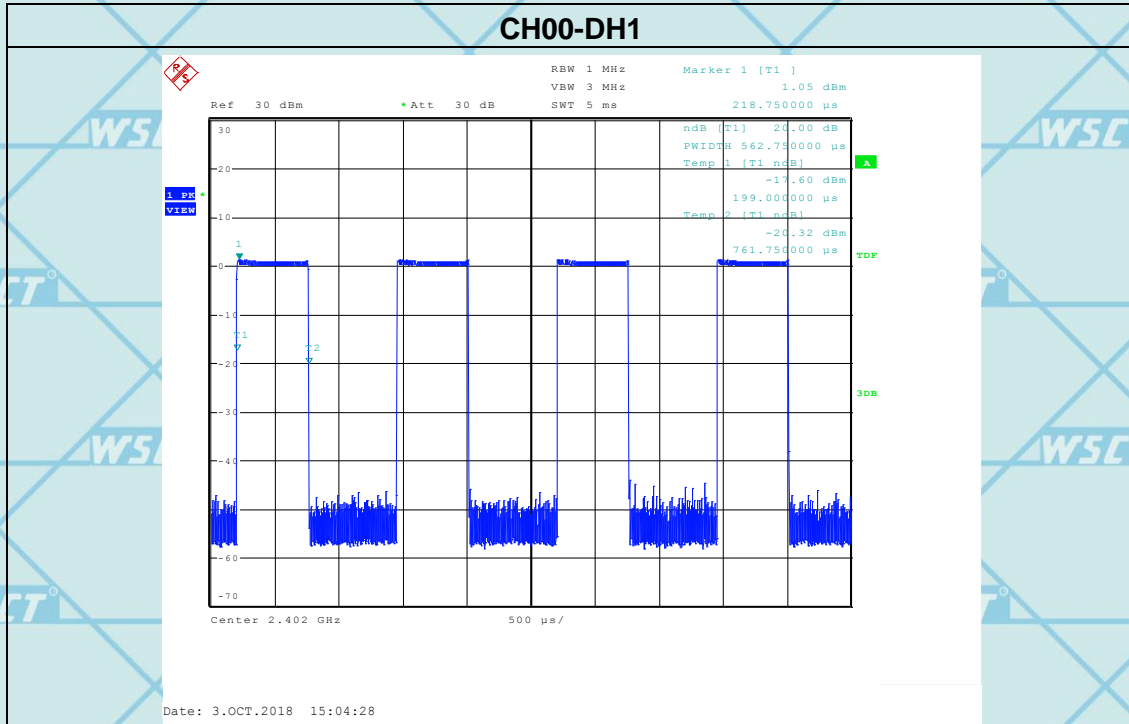



For Question,
Please Contact with WSCT
www.wsct-cert.com

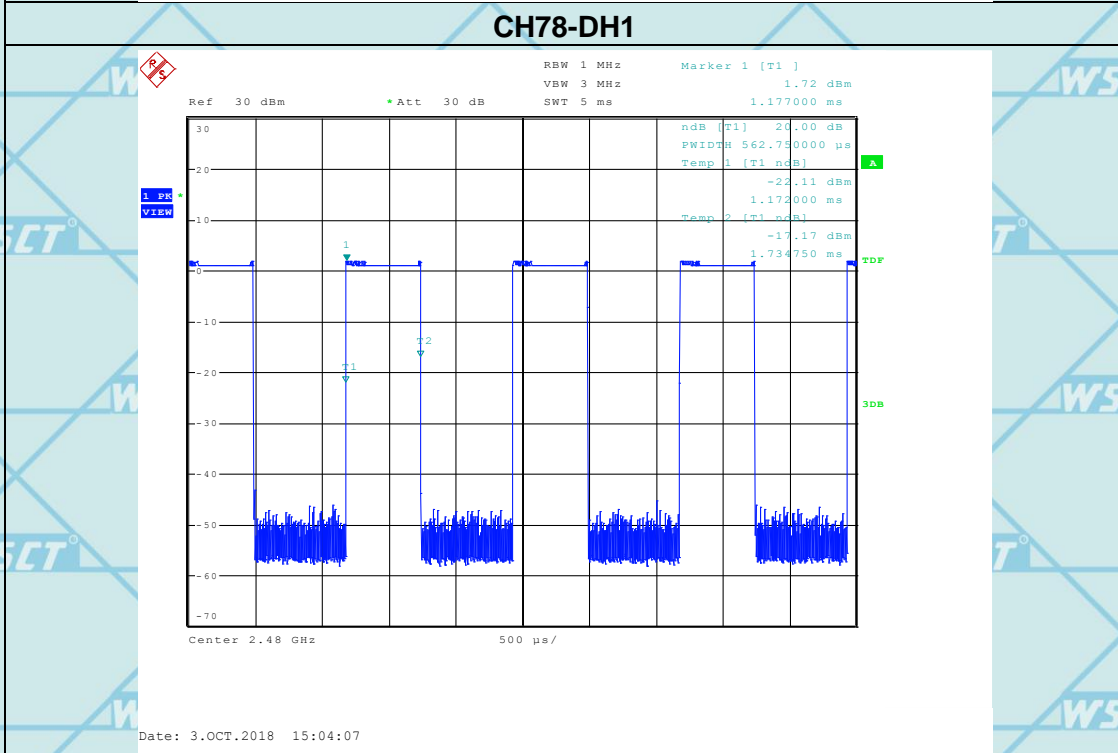
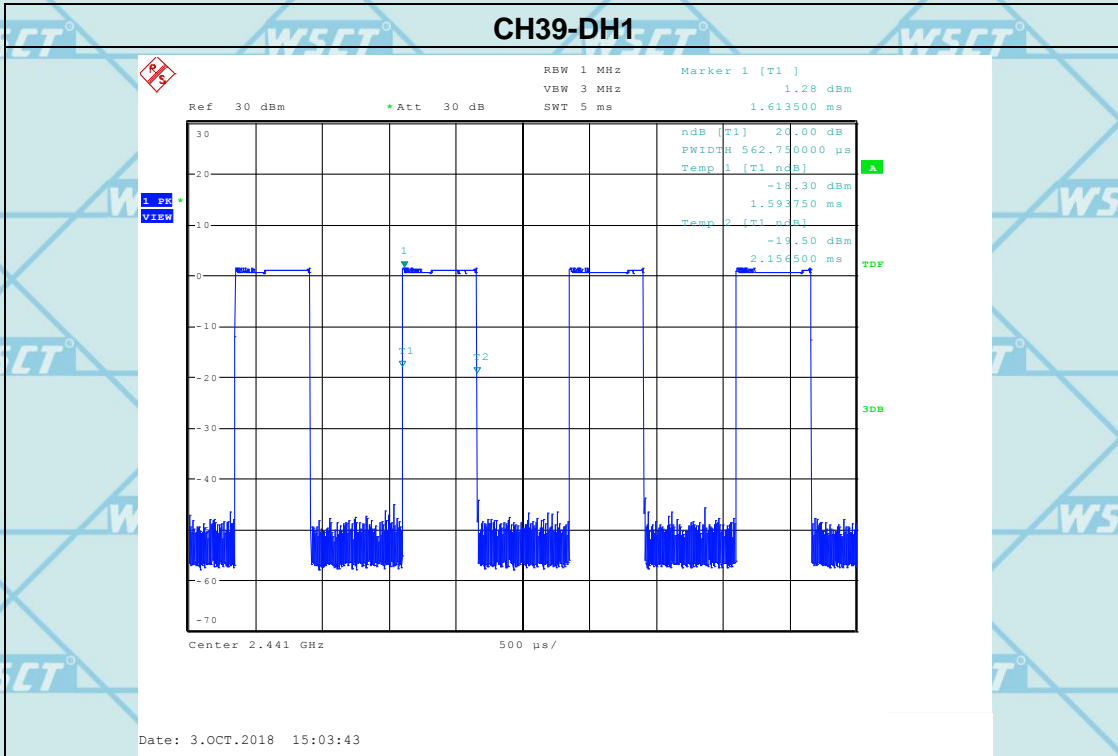



For Question,
Please Contact with WSCT
www.wsct-cert.com

Pressure	1012 hPa	Test Mode	DH3-1Mbps
Temperature	25°C	Relative Humidity	60%

Data Packet	Frequency	Pulse time(ms)	Dwell Time(S)	Limits (S)
DH3	2402MHz	1.771	0.283	0.4
DH3	2441MHz	1.771	0.283	0.4
DH3	2480MHz	1.771	0.283	0.4

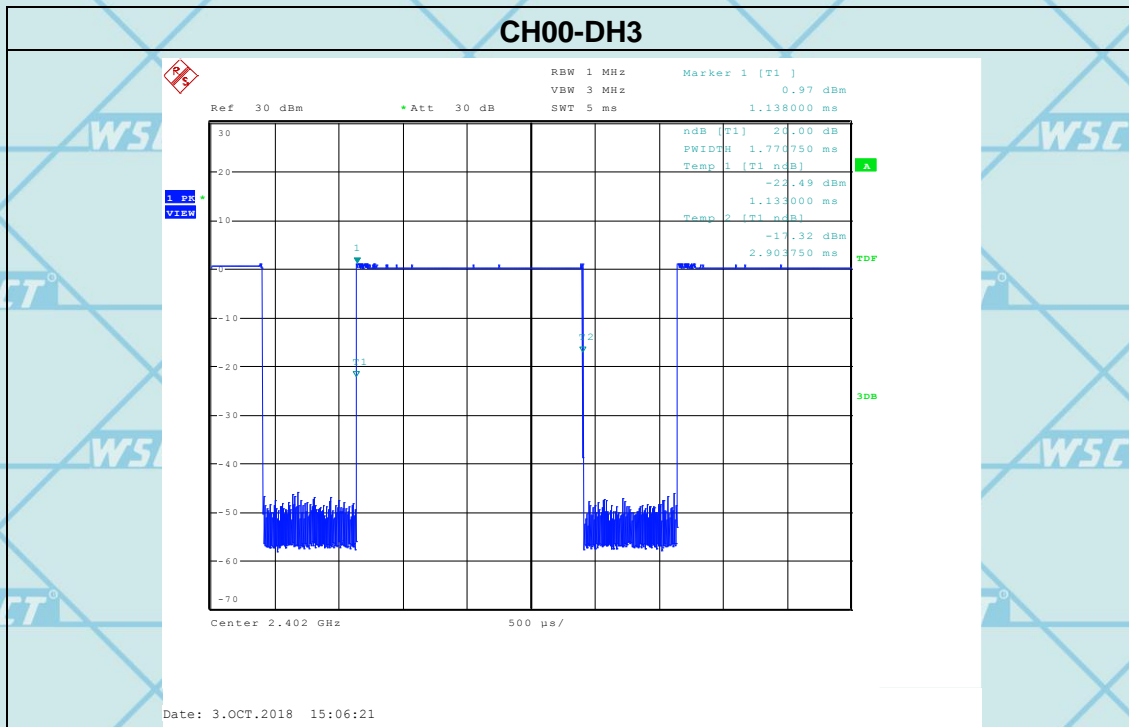



For Question, Please Contact with WSCT www.wsct-cert.com

CH39-DH3

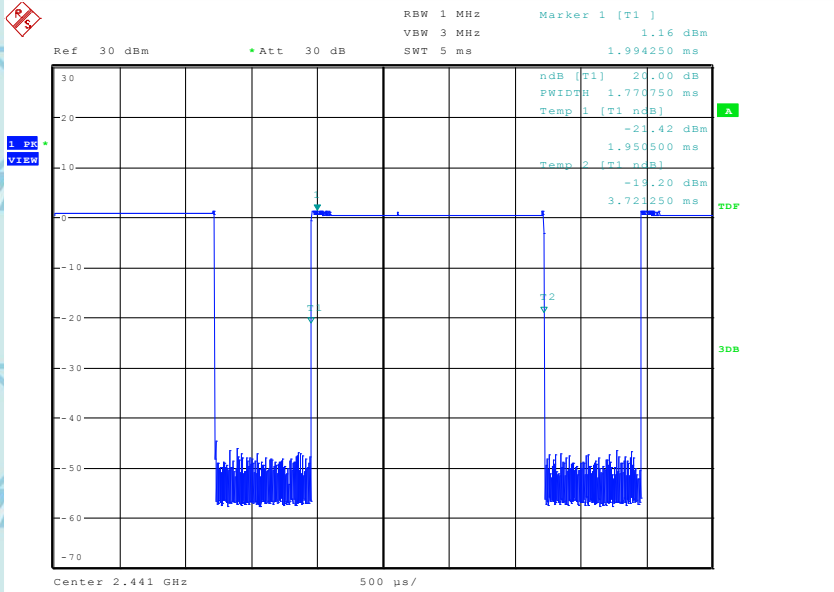

Date: 3.OCT.2018 15:05:29

CH78-DH3

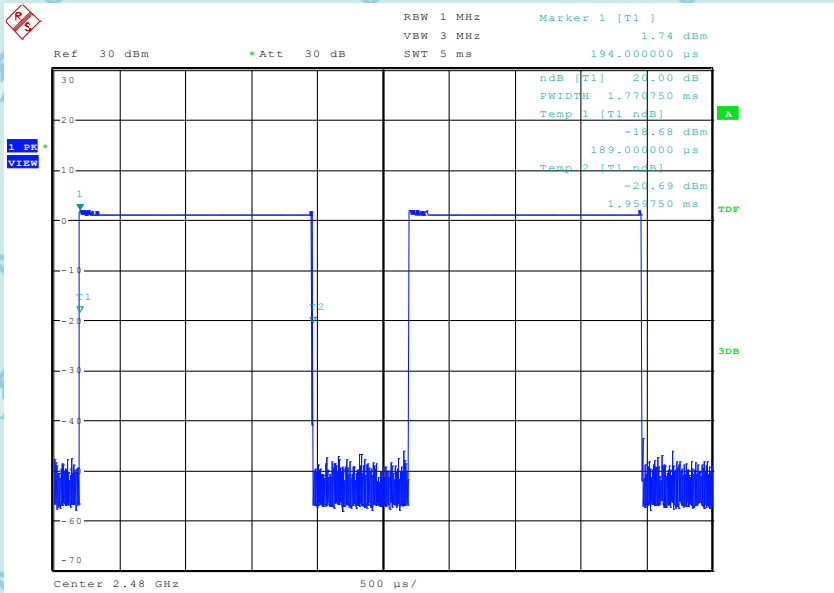

Date: 3.OCT.2018 15:05:55





For Question,
Please Contact with WSCT
www.wsct-cert.com

Pressure	1012 hPa	Test Mode	DH5-1Mbps
Temperature	25°C	Relative Humidity	60%

Data Packet	Frequency	Pulse time(ms)	Dwell Time(S)	Limits (S)
DH5	2402MHz	2.883	0.308	0.4
DH5	2441MHz	2.883	0.308	0.4
DH5	2480MHz	2.883	0.308	0.4

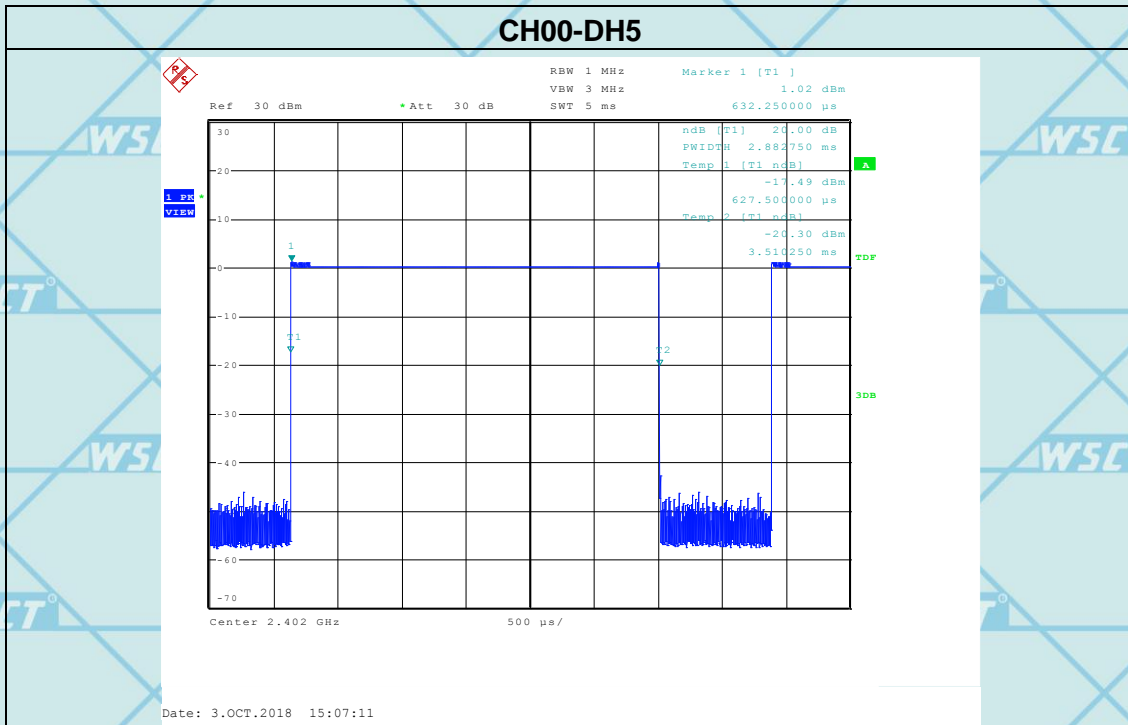



For Question, Please Contact with WSCT www.wsct-cert.com

CH39-DH5

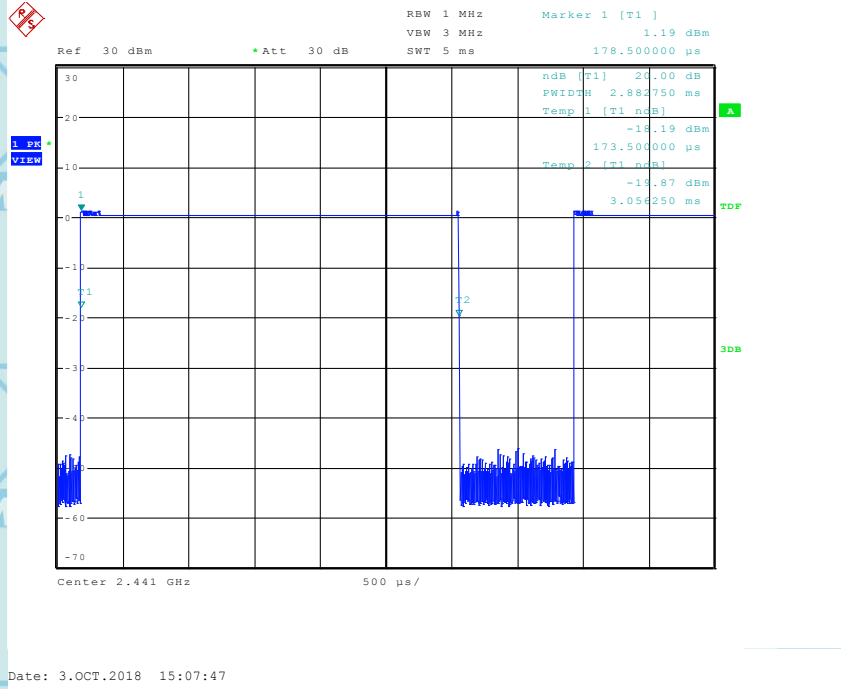

CH78-DH5

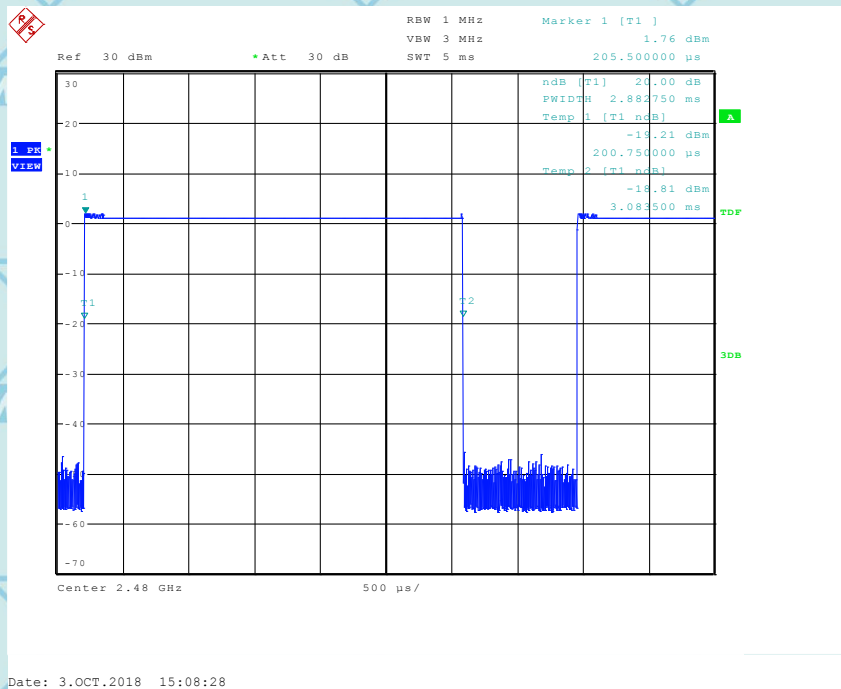



6. HOPPING CHANNEL SEPARATION MEASUREMENT

6.1 APPLIED PROCEDURES / LIMIT

Frequency hopping systems operating in the 2400-2483.5 MHz band may have hopping channel carrier frequencies that are separated by 25 kHz or two-thirds of the 20 dB bandwidth of the hopping channel, whichever is greater.

Spectrum Parameter	Setting
Attenuation	Auto
Span Frequency	> Measurement Bandwidth or Channel Separation
RB	Resolution (or IF) Bandwidth (RBW) \geq 1% of the span
VB	Video (or Average) Bandwidth (VBW) \geq RBW
Detector	Peak
Trace	Max hold
Sweep Time	Auto

6.1.2 TEST PROCEDURE

1. Check the calibration of the measuring instrument using either an internal calibrator or a known signal from an external generator.
2. Set the spectrum analyzer as follows: Span = wide enough to capture the peaks of two adjacent channels; Resolution (or IF) Bandwidth (RBW) \geq 1% of the span; Video (or Average) Bandwidth (VBW) \geq RBW; Sweep = auto; Detector function = peak; Trace = max hold
3. Measure the separation between the peaks of the adjacent channels using the marker-delta function.
4. Repeat above procedures until all frequencies measured were complete.

6.1.3 DEVIATION FROM STANDARD

No deviation.

6.1.4 TEST SETUP

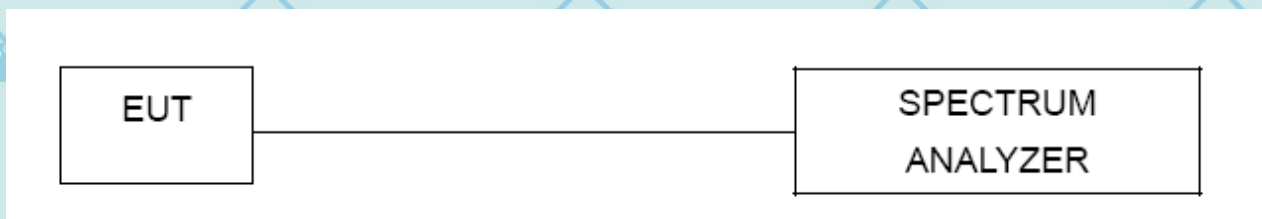

6.1.5 EUT OPERATION CONDITIONS

The EUT was programmed to be in continuously transmitting mode.





For Question,
Please Contact with WSCT
www.wsct-cert.com

6.2 TEST RESULTS

Pressure	1012 hPa	Test Mode	CH00 / CH39 /CH78 (1Mbps Mode)
Temperature	25°C	Relative Humidity	60%
Test Result	Pass		

Channel number	Channel frequency (MHz)	Separation Read value (KHz)	Separation limit (KHz)
00	2402	1000	20dB BW
39	2441	1000	20dB BW
78	2480	1000	20dB BW

Note: 20db bandwidth refer to section9.6

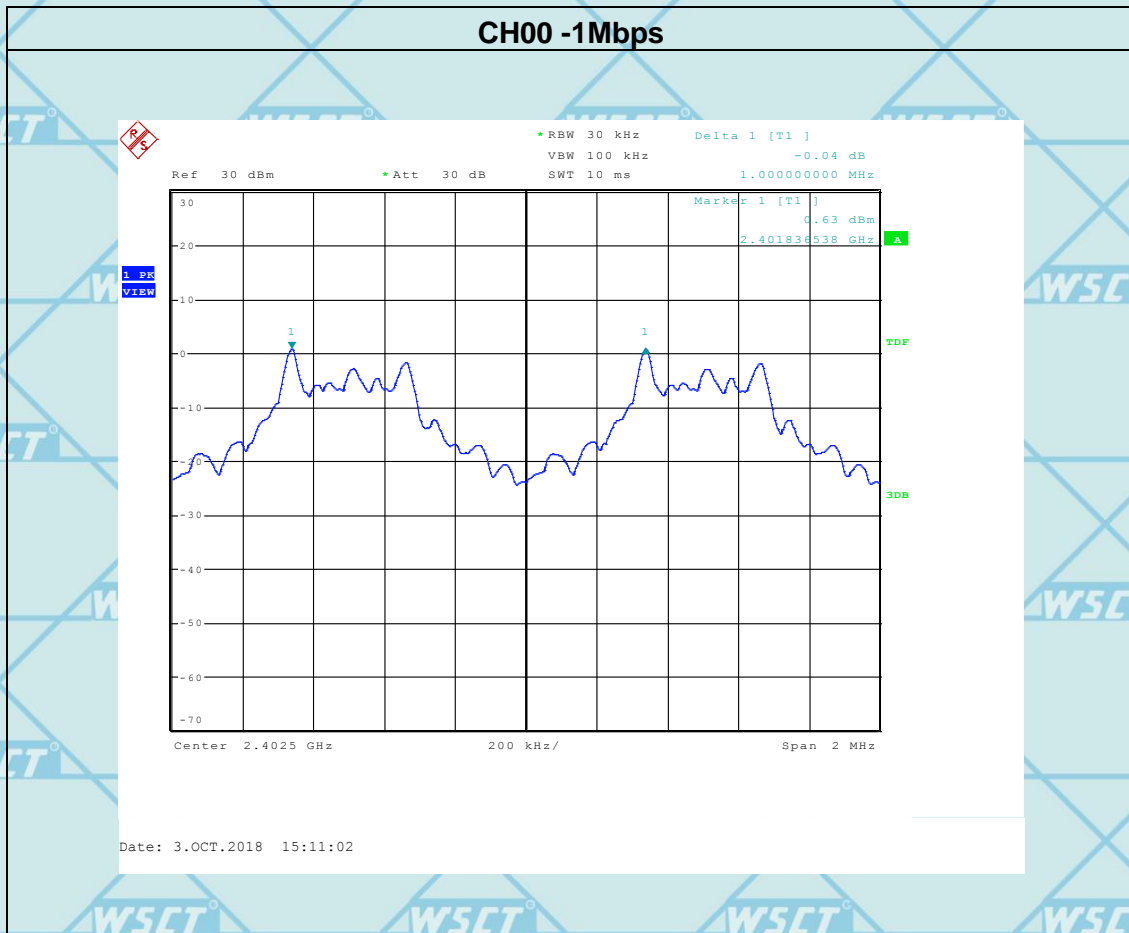



For Question, Please Contact with WSCT www.wsct-cert.com

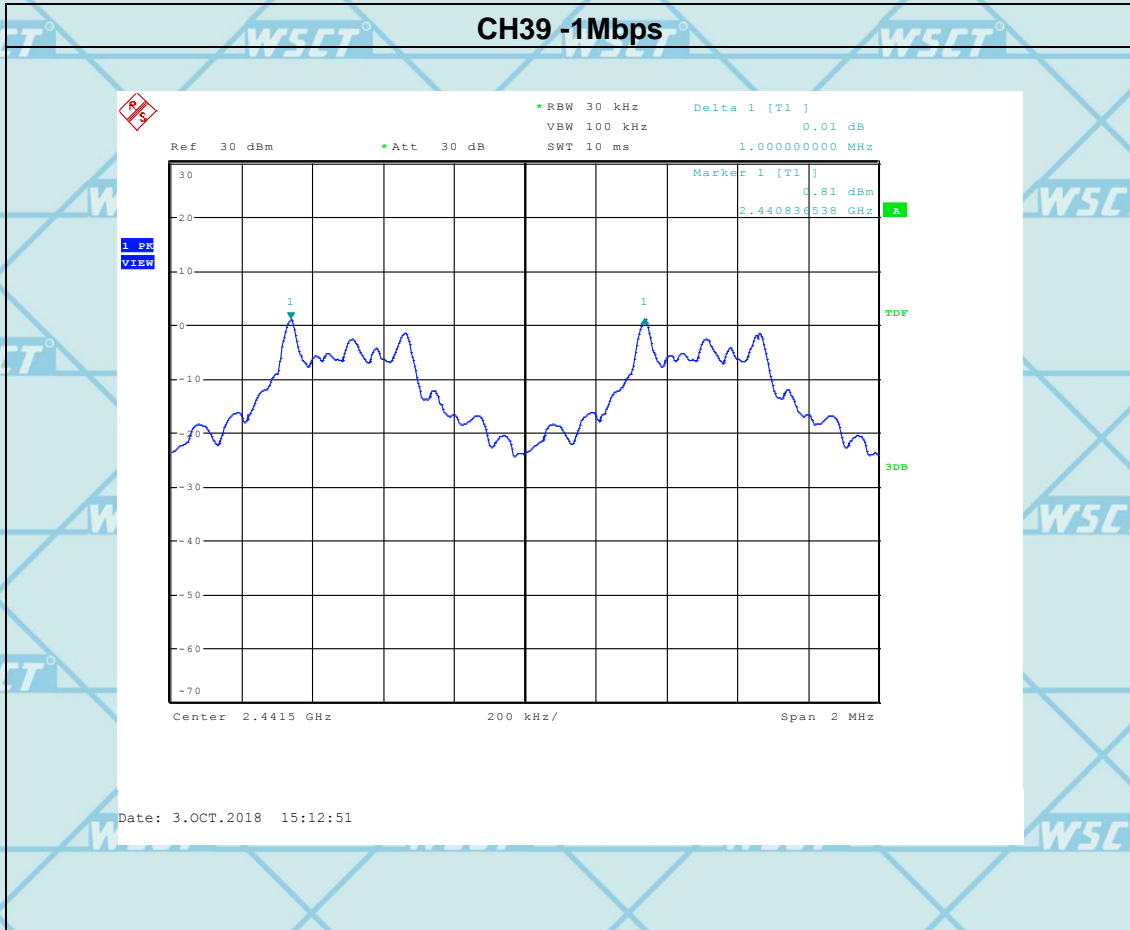



For Question, Please Contact with WSCT www.wsct-cert.com

CH78 -1Mbps





Pressure	1012 hPa	Test Mode	CH00 / CH39 /CH78 (2Mbps Mode)
Temperature	25°C	Relative Humidity	60%
Test Result	Pass		

Channel number	Channel frequency (MHz)	Separation Read value (KHz)	Separation limit (KHz)
00	2402	1000	2/3 *20dB BW
39	2441	1000	2/3 *20dB BW
78	2480	1000	2/3 *20dB BW

Note: 20db bandwidth refer to section 9.6

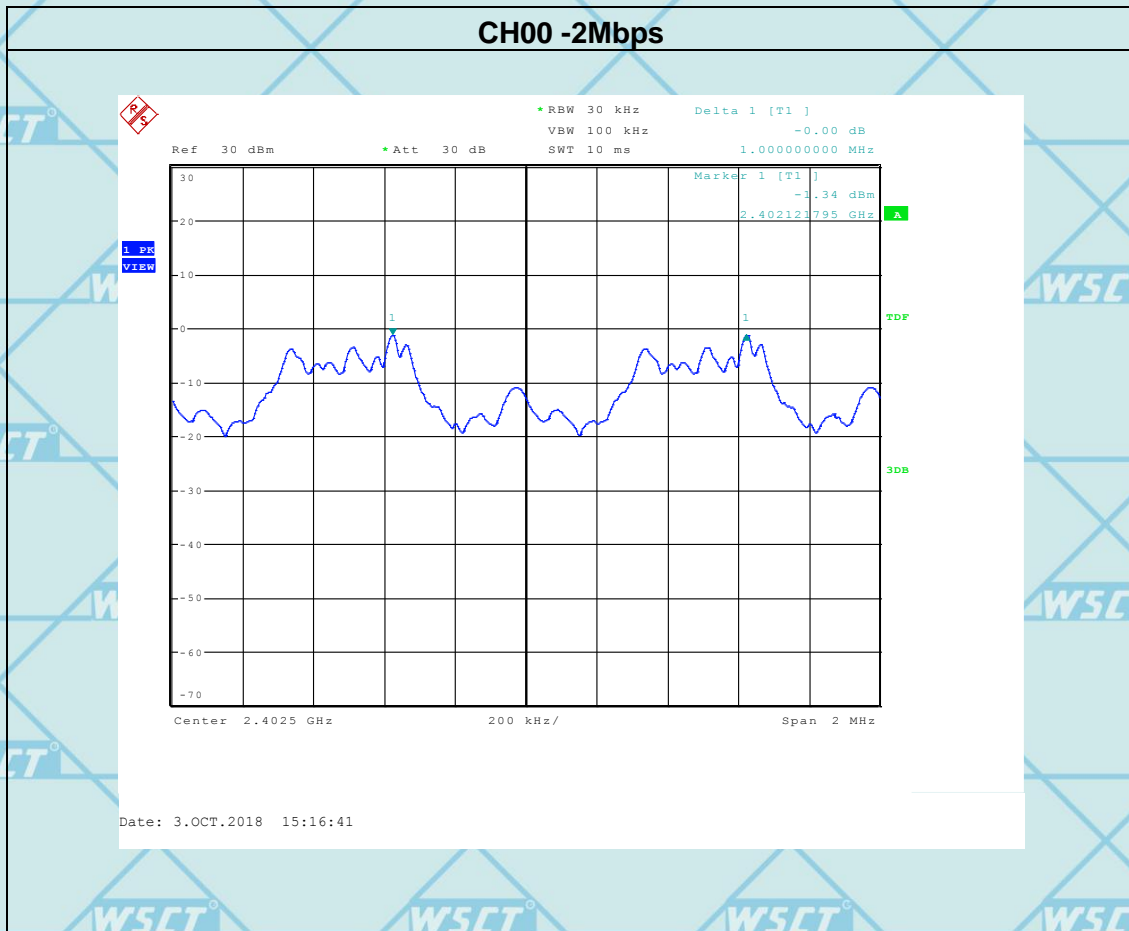



For Question, Please Contact with WSCT www.wsct-cert.com

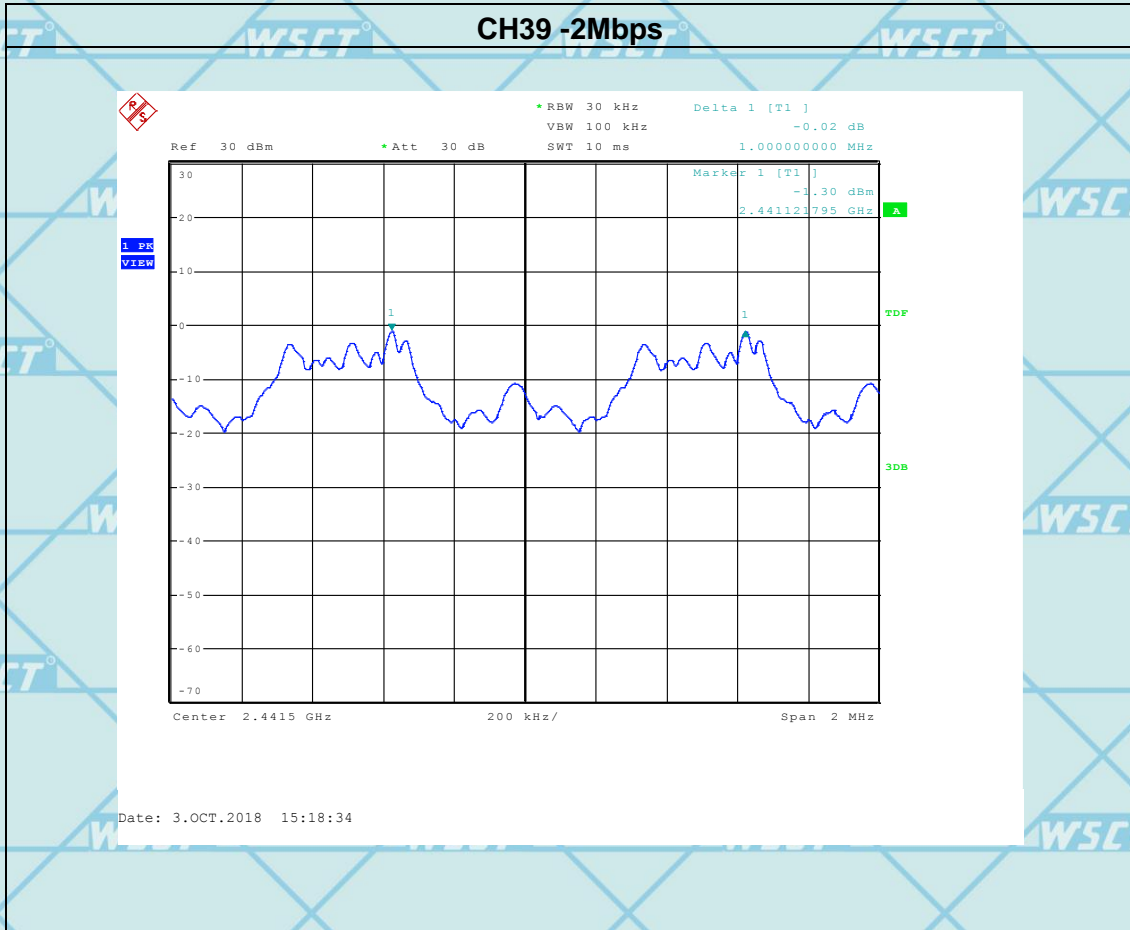



For Question, Please Contact with WSCT www.wsct-cert.com

CH78 -2Mbps

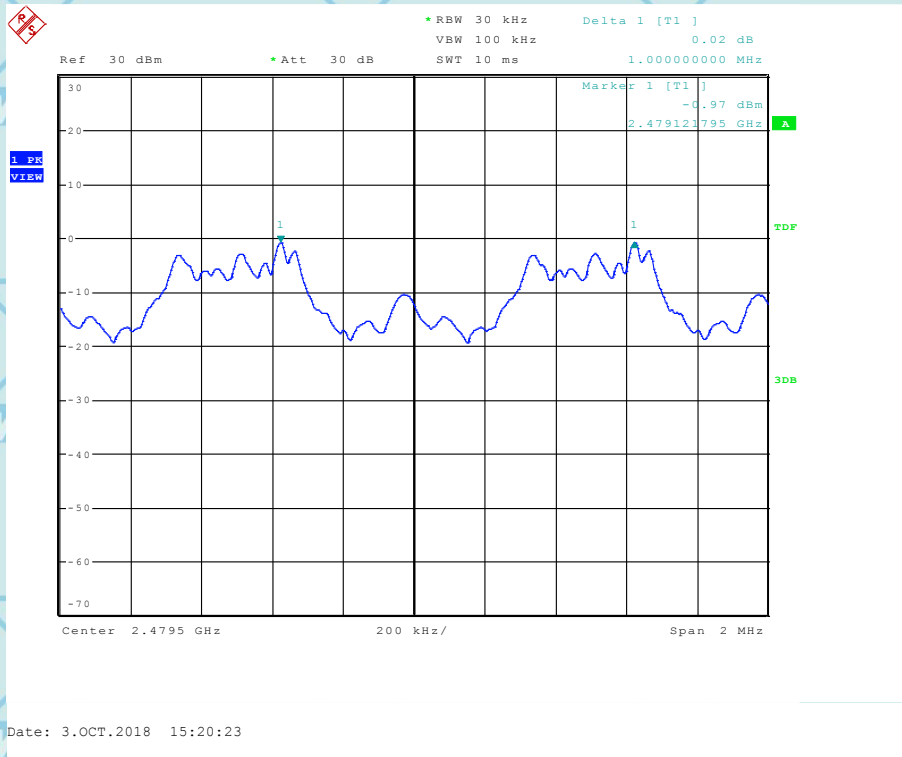



For Question,
Please Contact with WSCT
www.wsct-cert.com

Pressure	1012 hPa	Test Mode	CH00 / CH39 /CH78 (3Mbps Mode)
Temperature	25°C	Relative Humidity	60%
Test Result	Pass		

Channel number	Channel frequency (MHz)	Separation Read value (KHz)	Separation limit (KHz)
00	2402	1000	2/3 *20dB BW
39	2441	1000	2/3 *20dB BW
78	2480	1000	2/3 *20dB BW

Note: 20db bandwidth refer to section 9.6

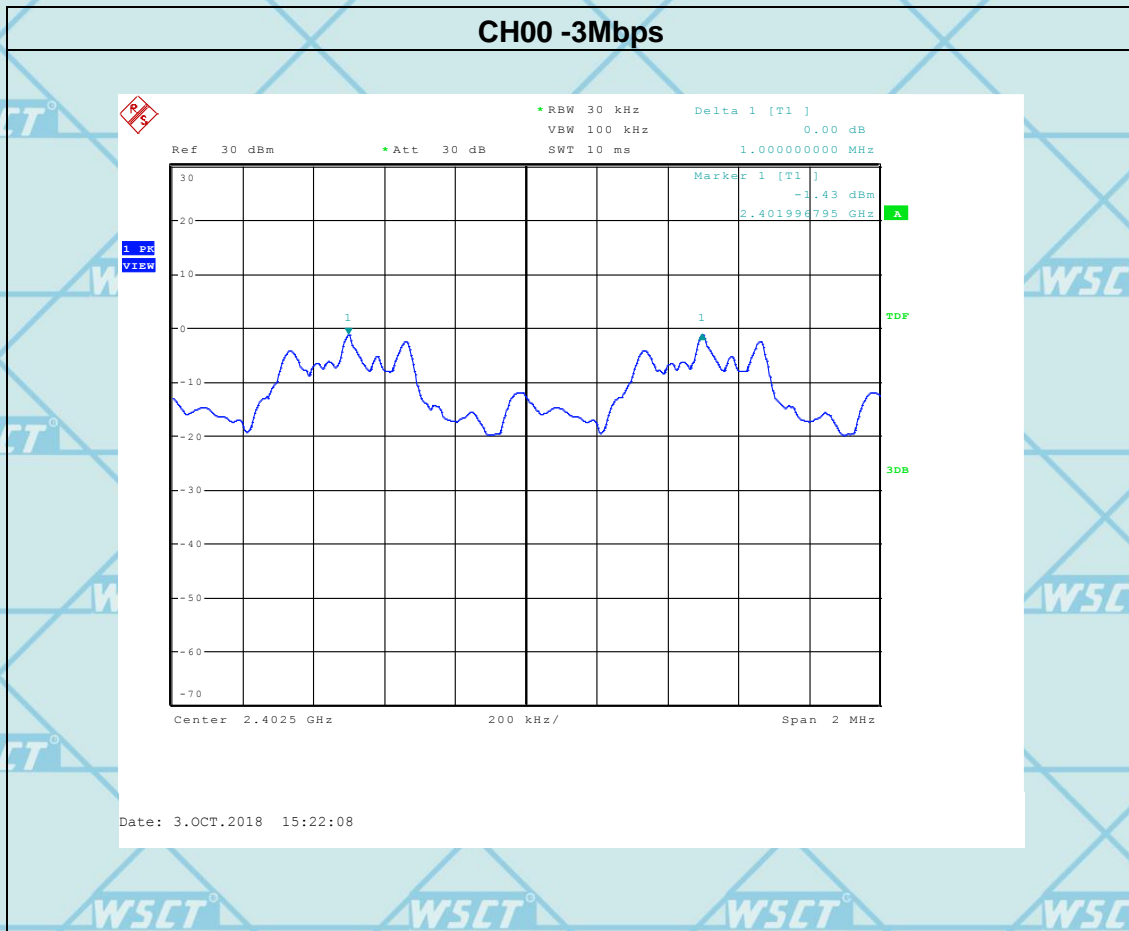



For Question, Please Contact with WSCT www.wsct-cert.com

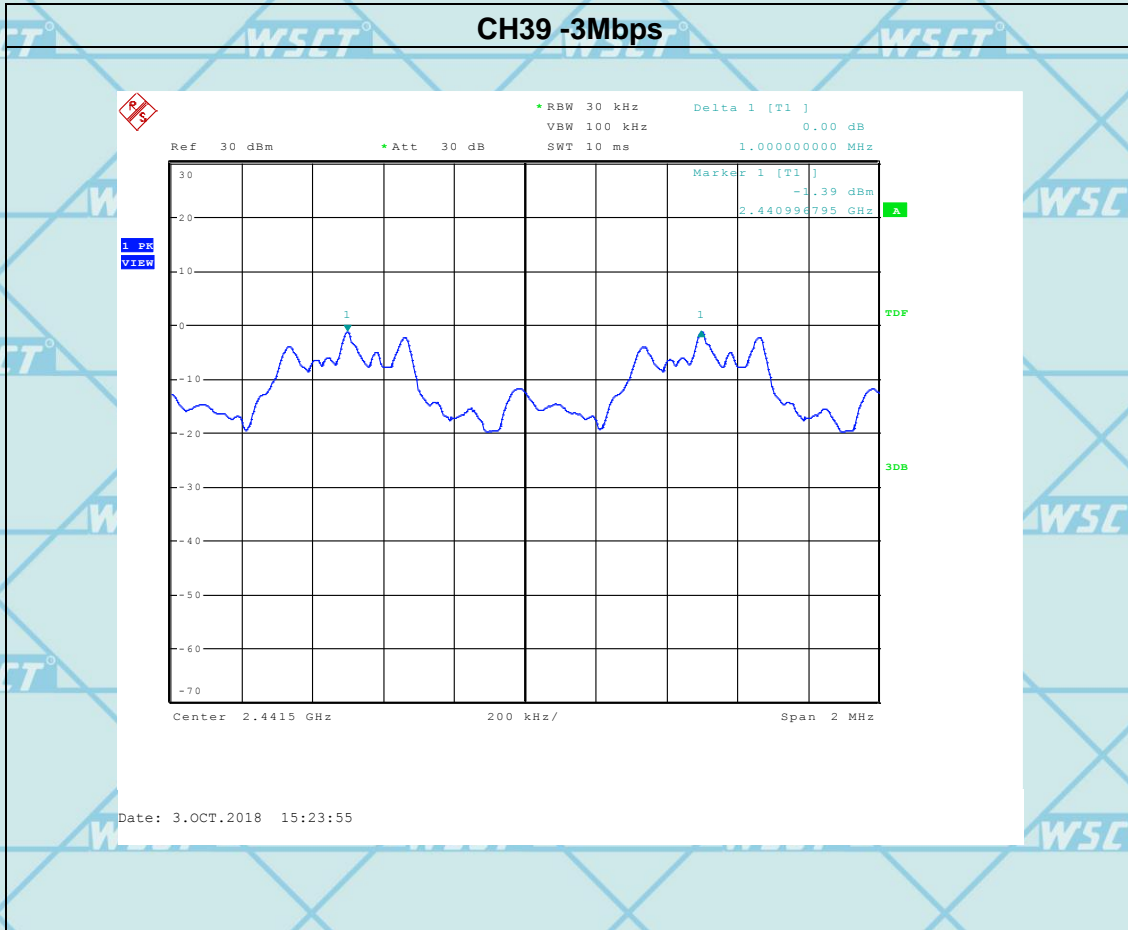



For Question, Please Contact with WSCT www.wsct-cert.com

CH78 -3Mbps

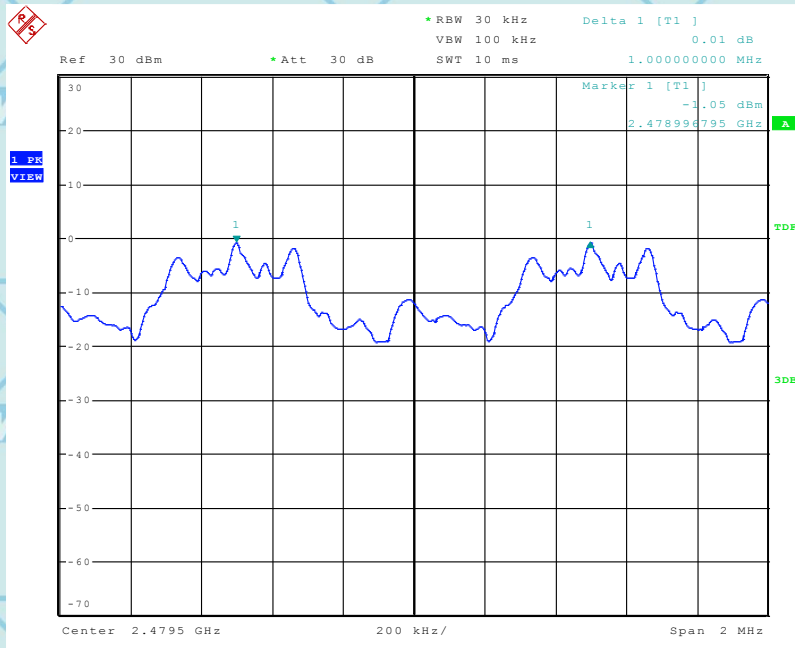

Date: 3.OCT.2018 15:26:13



世标检测认证股份 World Standardization Certification & Testing Group Co.,Ltd.

ADD:Building A-B Baoshi Science & technology Park, Baoshi Road, Bao'an District, Shenzhen, Guangdong, China TEL:86-755-26996143/26996144/26996145/26996192 FAX:86-755-86376605 E-mail:Fengbing.Wang@wsct-cert.com Http:www.wsct-cert.com

Member of the WSCT INC.



7. BANDWIDTH TEST

7.1 APPLIED PROCEDURES / LIMIT

FCC Part15 (15.247) , Subpart C				
Section	Test Item	Limit	Frequency Range (MHz)	Result
15.247 (a)(1)	Bandwidth	(20dB bandwidth)	2400-2483.5	PASS

Spectrum Parameter	Setting
Attenuation	Auto
Span Frequency	> Measurement Bandwidth or Channel Separation
RB	30kHz
VB	100 kHz
Detector	Peak
Trace	Max hold
Sweep Time	Auto

7.1.2 TEST PROCEDURE

1. Check the calibration of the measuring instrument (spectrum analyzer) using either an internal calibrator or a known signal from an external generator.
2. Set the spectrum analyzer as follows: VBW =30kHz, RBW=100kHz, Sweep = auto Detector function = peak ,Trace = max hold
3. Measure the highest amplitude appearing on spectral display and record the level to calculate results.
4. Repeat above procedures until all frequencies measured were complete.

7.1.3 DEVIATION FROM STANDARD

No deviation.

7.1.4 TEST SETUP

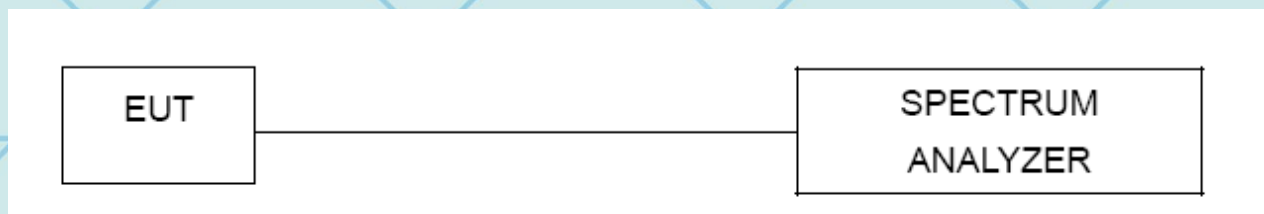

7.1.5 EUT OPERATION CONDITIONS

The EUT tested system was configured as the statements of 2.4 Unless otherwise a special operating condition is specified in the follows during the testing.





For Question,
Please Contact with WSCT
www.wsct-cert.com

7.2 TEST RESULTS

Note: *the worst case is DH5 as result in this part.*

Pressure	1012 hPa	Test Mode	CH00/CH39/C78(1Mbps)
Temperature	25°C	Relative Humidity	60%

Frequency	20dB Bandwidth (kHz)	Result
2402 MHz	837	PASS
2441 MHz	841	PASS
2480 MHz	827	PASS

CH00 -1Mbps

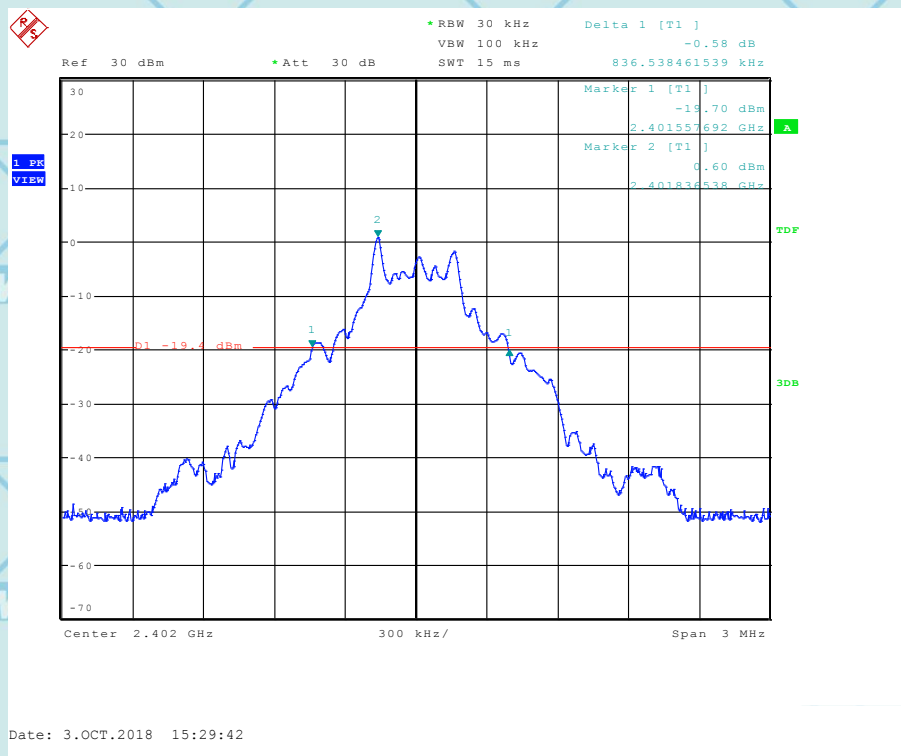



For Question, Please Contact with WSCT www.wsct-cert.com

CH39 -1Mbps

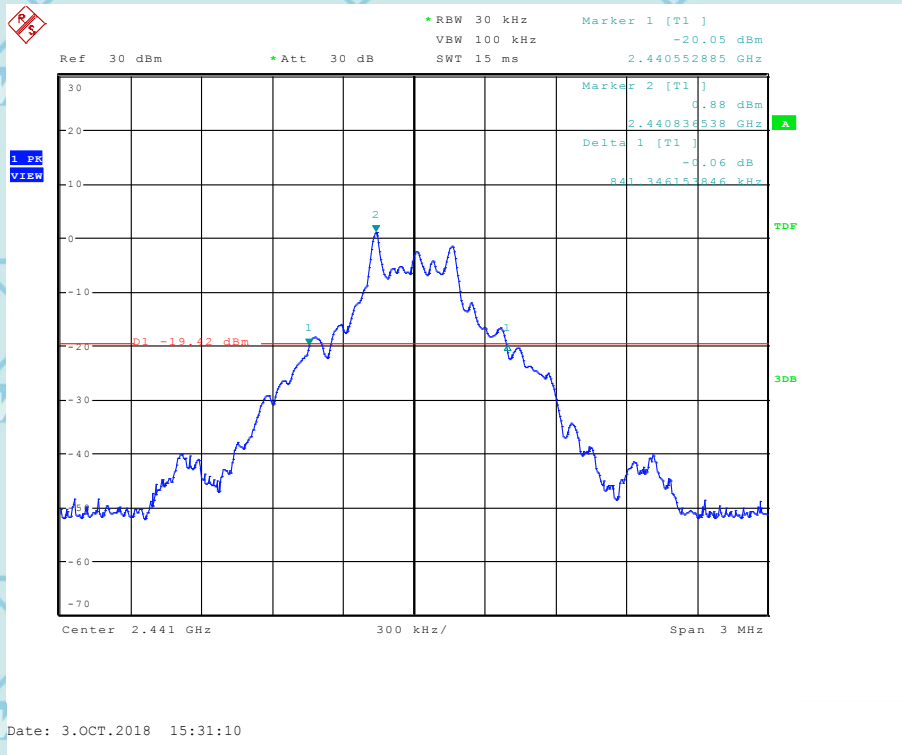



For Question, Please Contact with WSCT www.wsct-cert.com

CH78 -1Mbps

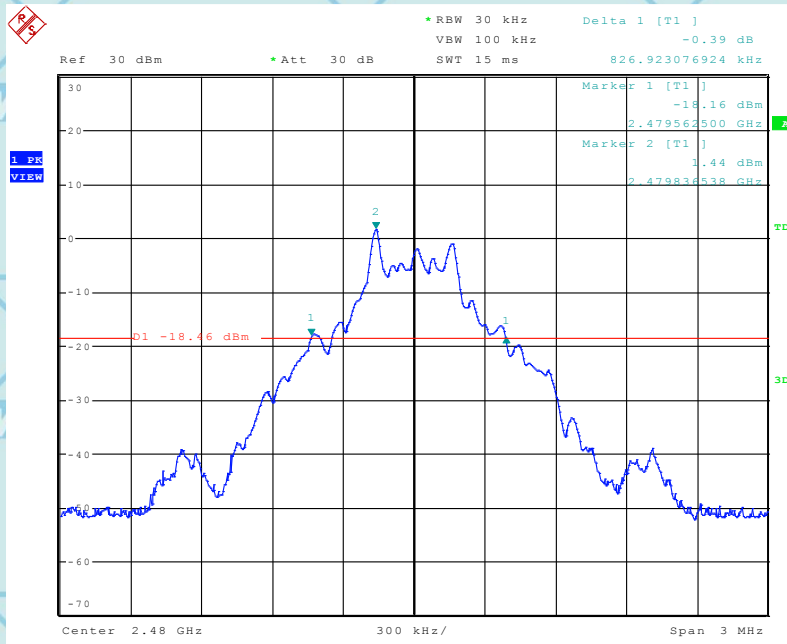

Date: 3.OCT.2018 15:32:43





For Question,
Please Contact with WSCT
www.wsct-cert.com

Note: *the worst case is DH5as result in this part.*

Pressure	1012 hPa	Test Mode	CH00/CH39/C78(2Mbps)
Temperature	25°C	Relative Humidity	60%

Frequency	20dB Bandwidth (kHz)	Result
2402 MHz	1135	PASS
2441 MHz	1149	PASS
2480 MHz	1149	PASS

CH00 -2Mbps

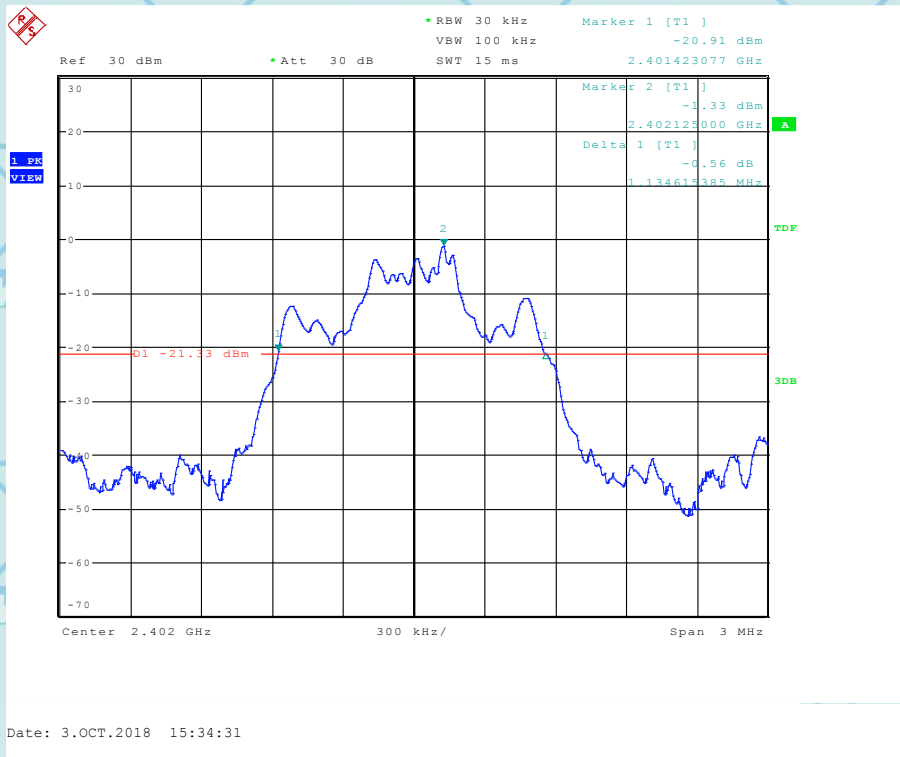



For Question, Please Contact with WSCT www.wsct-cert.com

CH39 -2Mbps

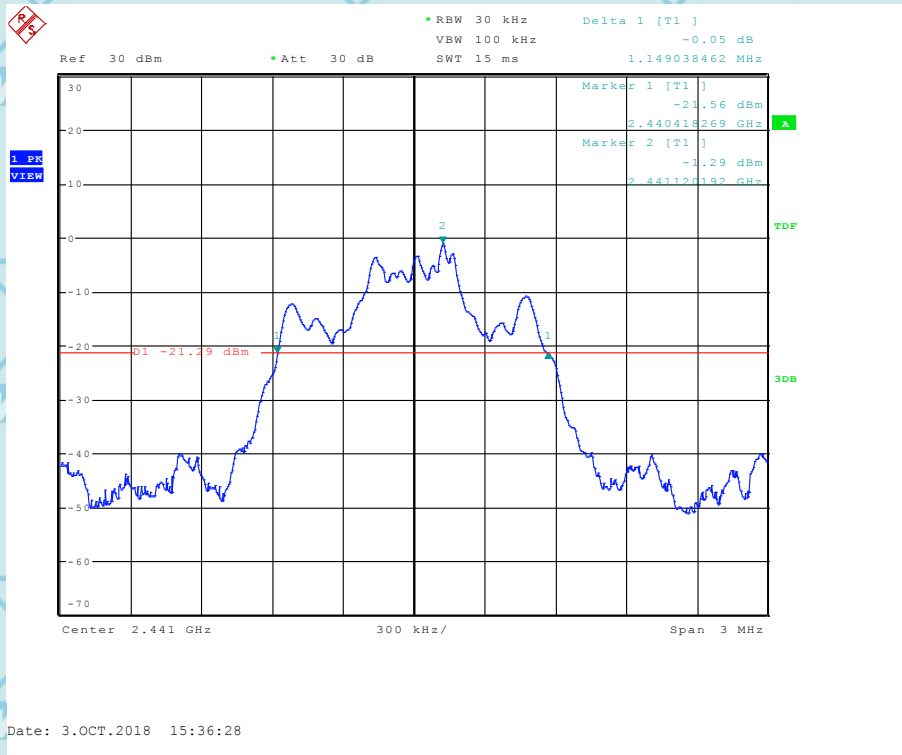



For Question, Please Contact with WSCT www.wsct-cert.com

CH78 -2Mbps

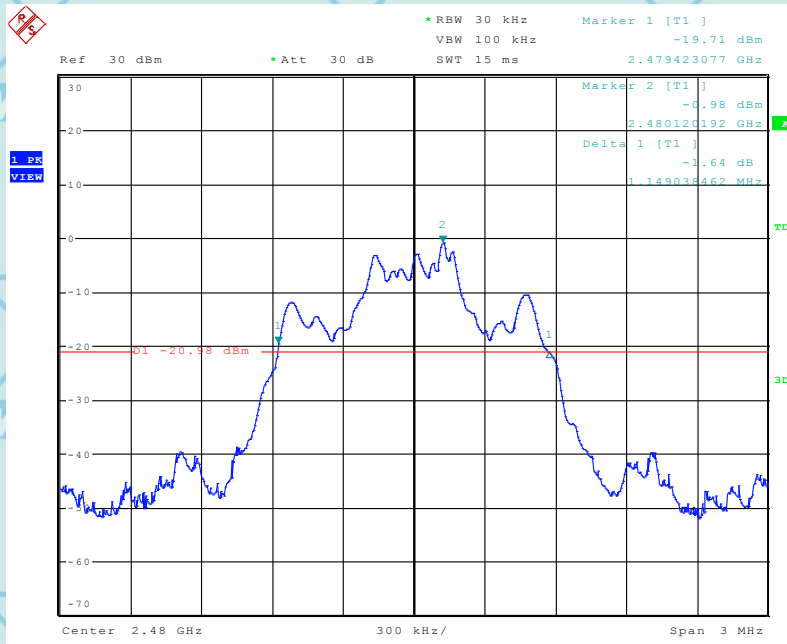

Date: 3.OCT.2018 15:38:09





Note: *the worst case is DH5as result in this part.*

Pressure	1012 hPa	Test Mode	CH00/CH39/C78(3Mbps)
Temperature	25°C	Relative Humidity	60%

Frequency	20dB Bandwidth (kHz)	Result
2402 MHz	1144	PASS
2441 MHz	1149	PASS
2480 MHz	1154	PASS

CH00 -3Mbps

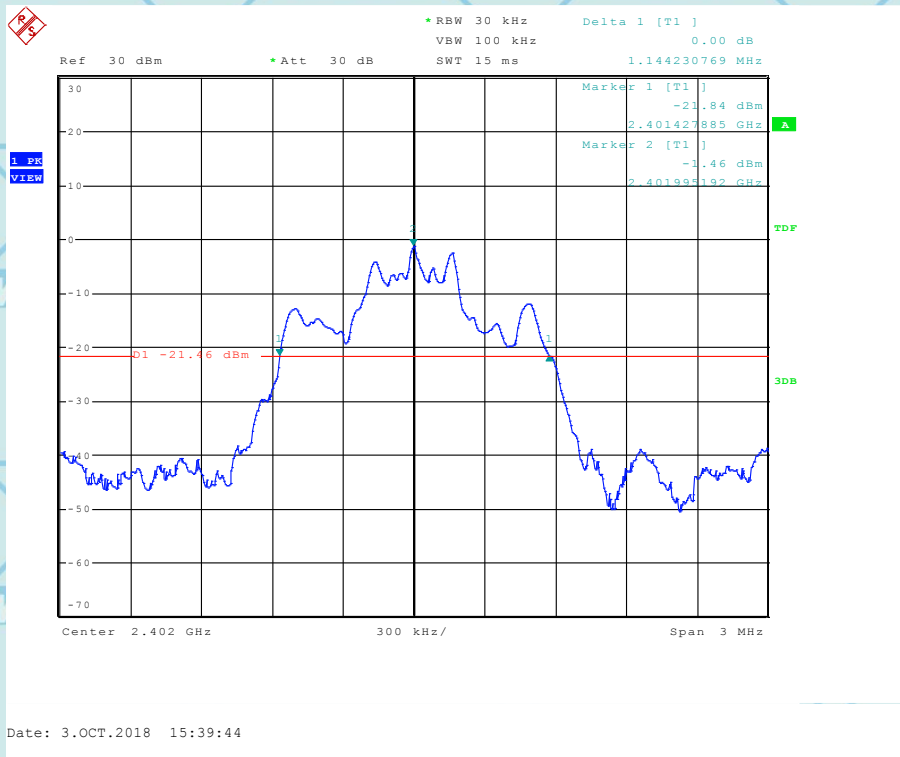



For Question, Please Contact with WSCT www.wsct-cert.com

CH39 -3Mbps

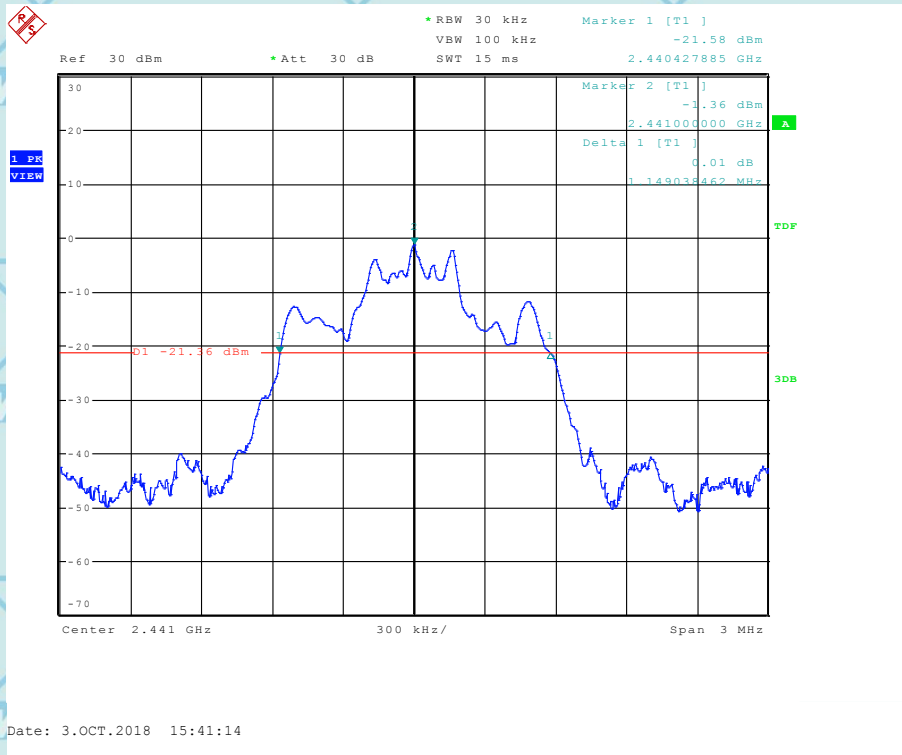



For Question, Please Contact with WSCT www.wsct-cert.com

CH78 -3Mbps

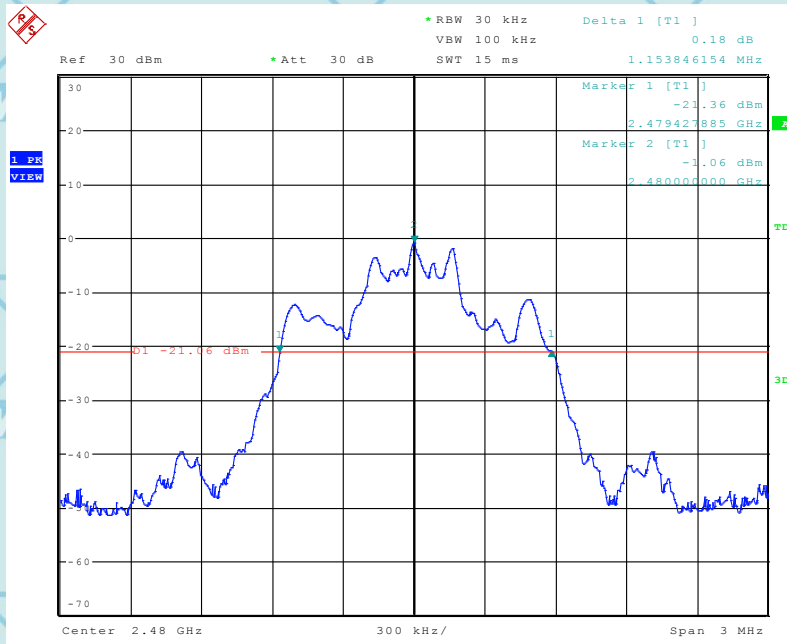

Date: 3.OCT.2018 15:43:04





8. PEAK OUTPUT POWER TEST

8.1 APPLIED PROCEDURES / LIMIT

FCC Part15 (15.247) , Subpart C				
Section	Test Item	Limit	Frequency Range (MHz)	Result
15.247 (b)(i)	Peak Output Power	1W for 1Mbps 0.125Wfor2/3Mbps	2400-2483.5	PASS

8.1.2 TEST PROCEDURE

- a. The EUT was directly connected to the spectrum analyze rand antenna output port as show in the block diagram below,
- b. Setting : RBW \geq the 20 dB bandwidth of the emission being measured
 Span \geq approximately 3 times the 20 dB bandwidth, centered on a hop ping channel
 VBW \geq RBW
 Sweep = auto
 Detector function = peak
 Trace = max hold

8.1.3 DEVIATION FROM STANDARD

No deviation.

8.1.4 TEST SETUP



8.1.5 EUT OPERATION CONDITIONS

The EUT tested system was configured as the statements of 2.4 Unless otherwise a special operating condition is specified in the follows during the testing.





For Question, Please Contact with WSCT
www.wsct-cert.com

8.2 TEST RESULTS

Pressure	1012 hPa	Test Mode	CH00/ CH39 /CH78 (1M/2M/3Mbps Mode)
Temperature	25°C	Relative Humidity	60%

Test Channel	Frequency (MHz)	Peak Output Power (dBm)	LIMIT(dBm)	Result
1Mbps				
CH00	2402	1.03	30	Pass
CH39	2441	1.29	30	Pass
CH78	2480	1.94	30	Pass
2Mbps				
CH00	2402	0.34	20.97	Pass
CH39	2441	0.51	20.97	Pass
CH78	2480	0.99	20.97	Pass
3Mbps				
CH00	2402	0.36	20.97	Pass
CH39	2441	0.51	20.97	Pass
CH78	2480	1.01	20.97	Pass

1Mbps
Channel: Low

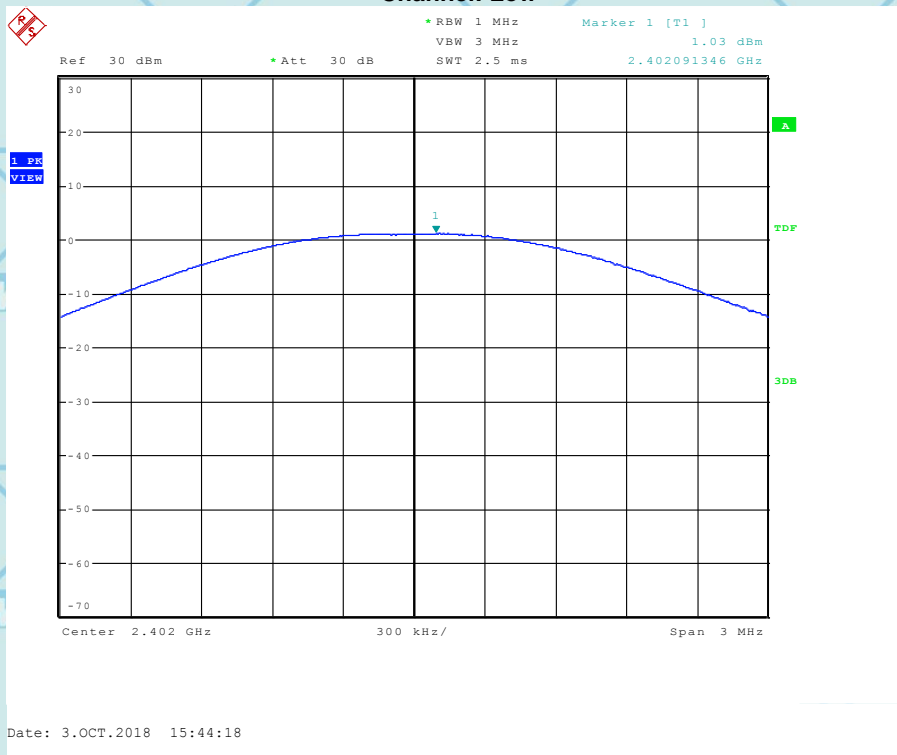



For Question,
Please Contact with WSCT
www.wsct-cert.com

Channel: Middle

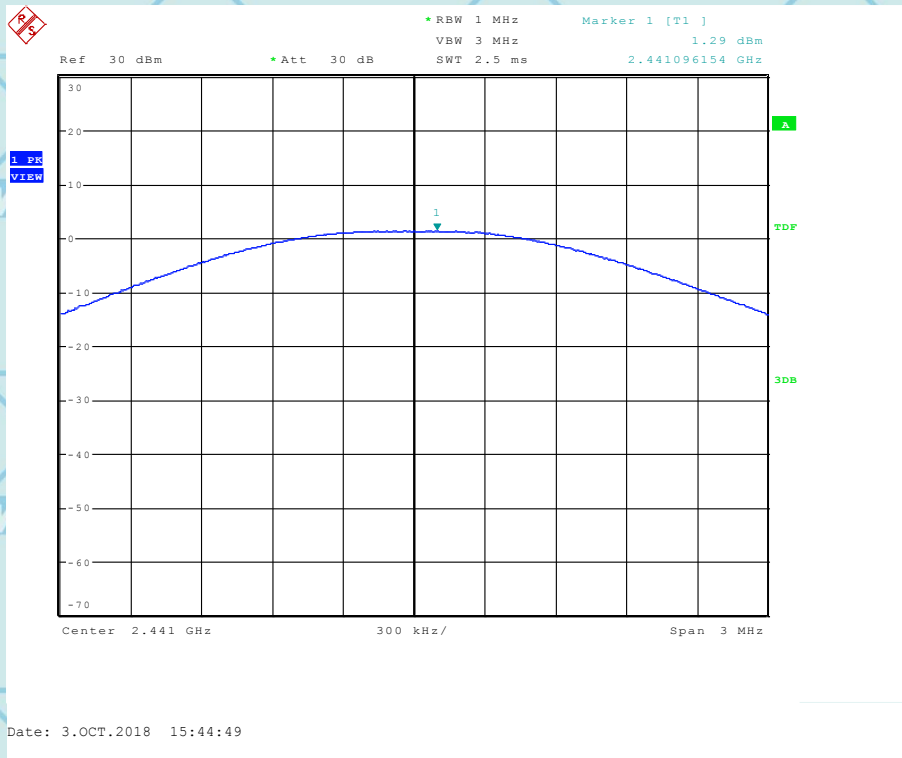

Channel: High

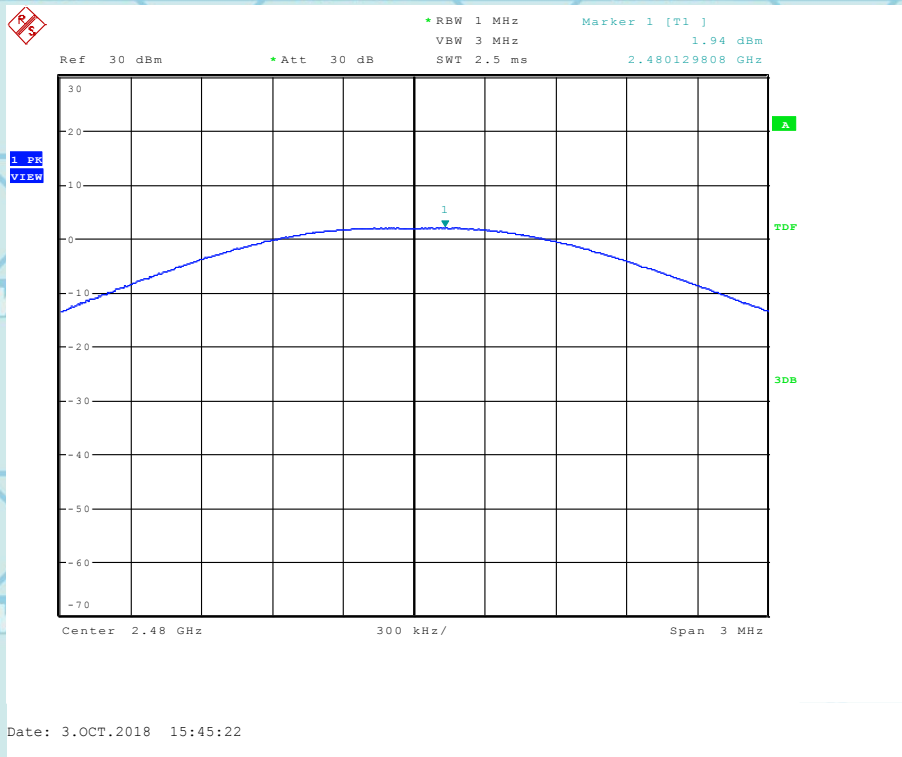



For Question,
Please Contact with WSCT
www.wsct-cert.com

2Mbps
Channel: Low

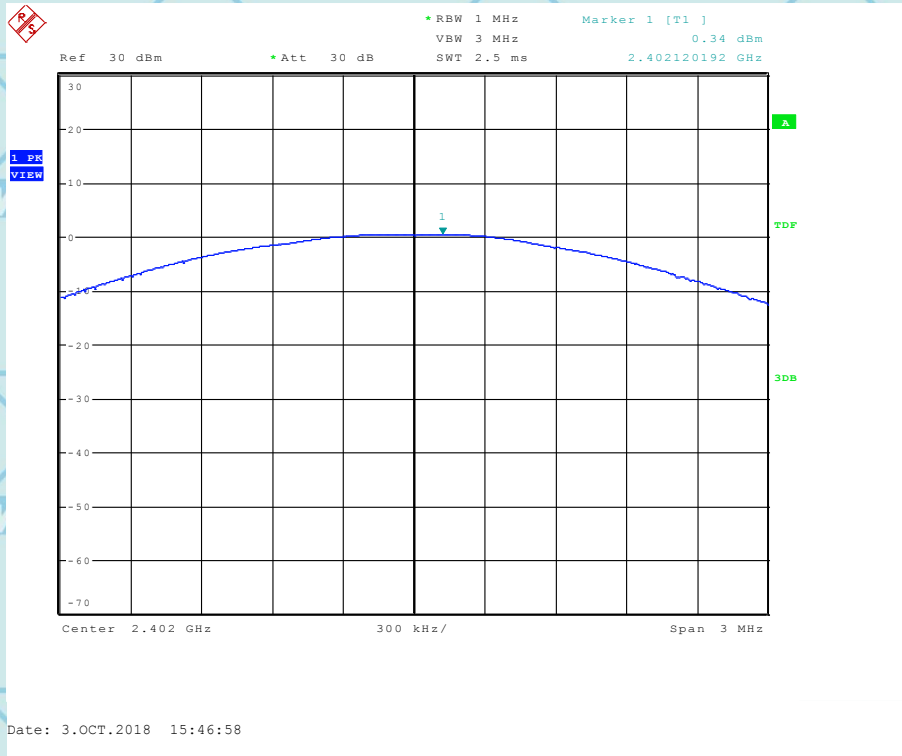

Channel: Middle

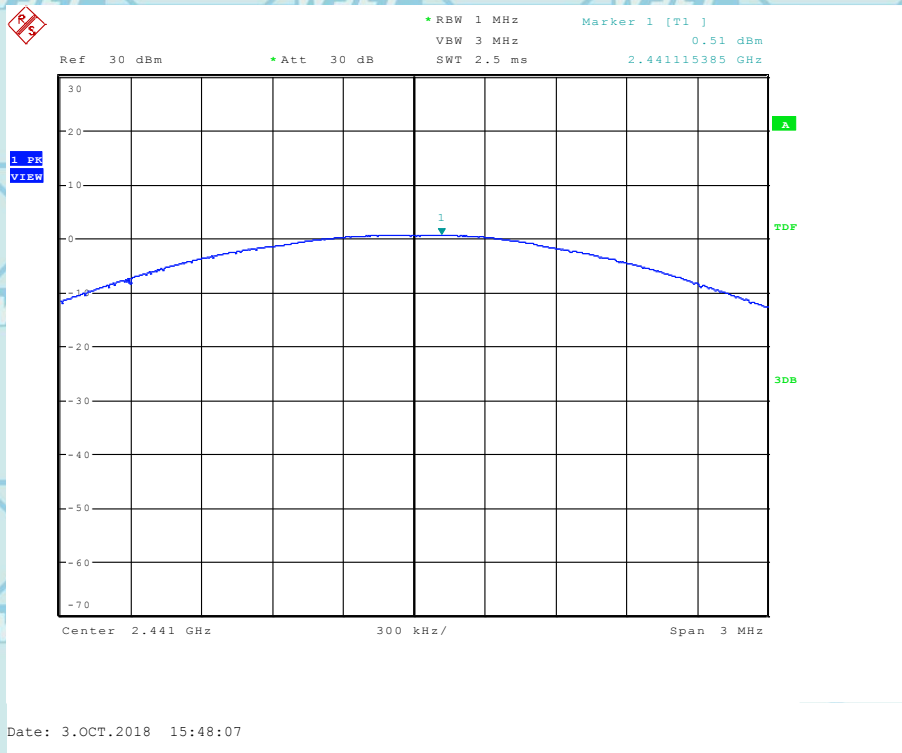



For Question,
Please Contact with WSCT
www.wsct-cert.com

Channel: High

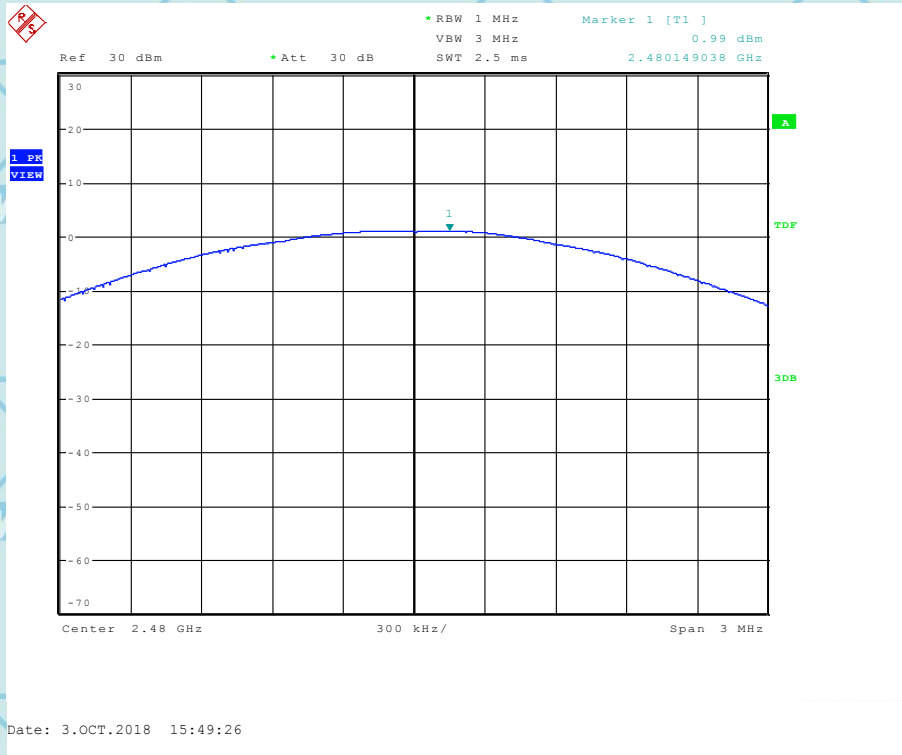

3Mbps
Channel: Low

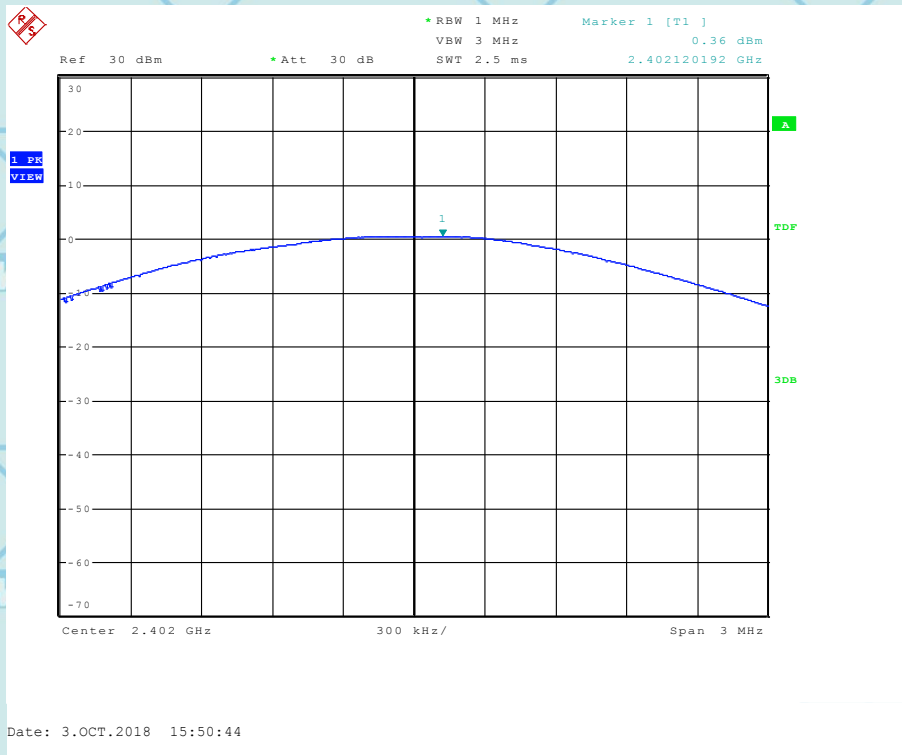



For Question, Please Contact with WSCT www.wsct-cert.com

Channel: Middle

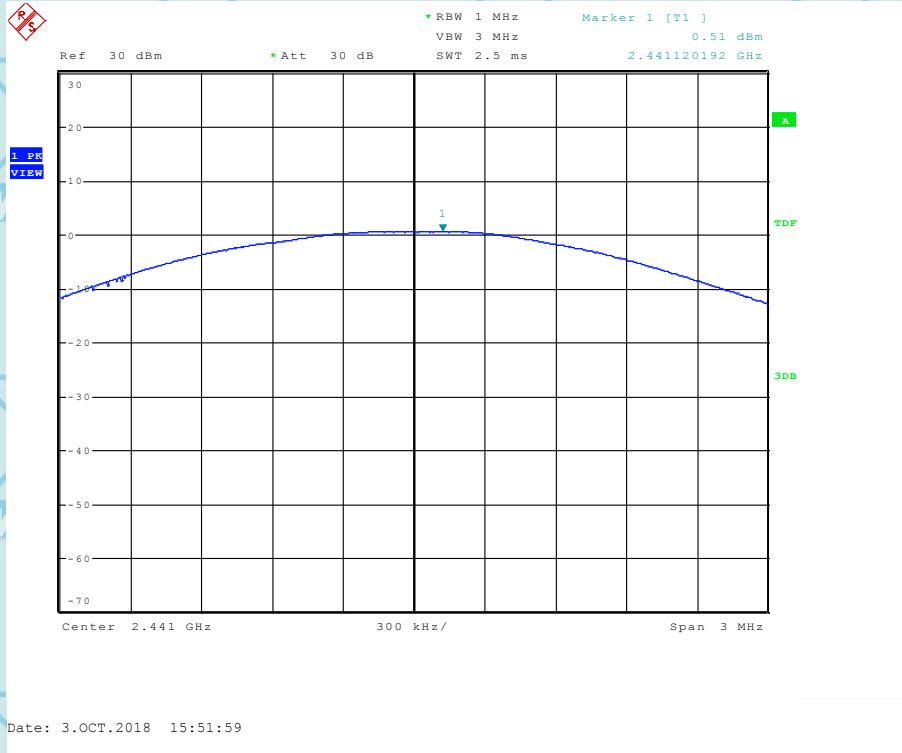

Channel: High

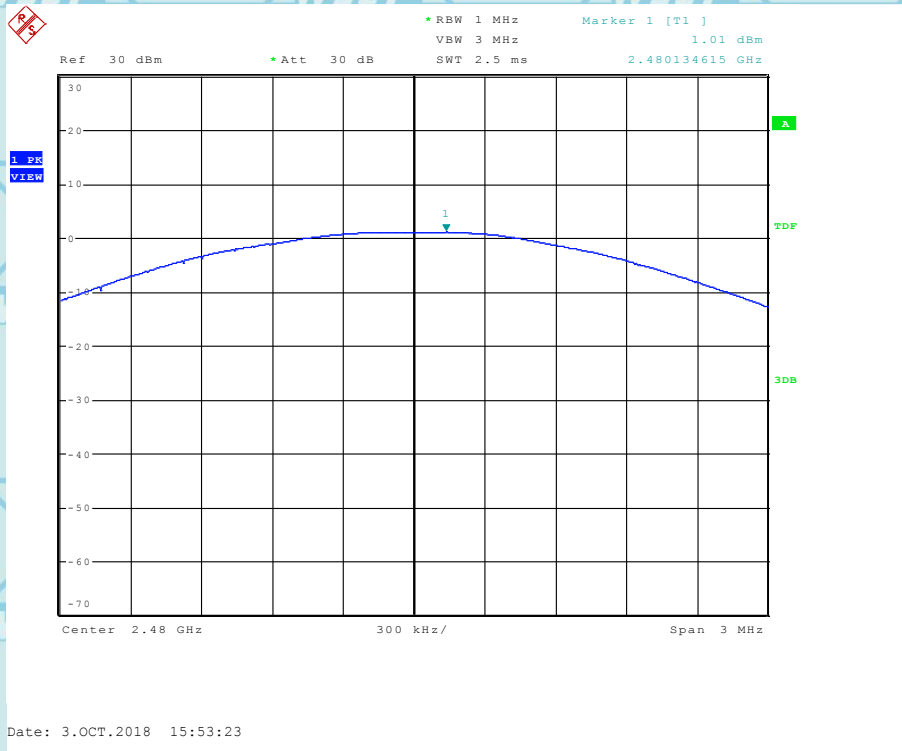



For Question,
Please Contact with WSCT
www.wsct-cert.com

9. 100KHZ BAND EDGES MEASUREMENT

9.1 APPLIED PROCEDURES / LIMIT

FCC Part15 (15.247) , Subpart C				
Section	Test Item	Limit	Frequency Range (MHz)	Result
15.247(d)	Band Edges Measurement	(20dB bandwidth)	2400-2483.5	PASS

1Mbps
Channel: Low

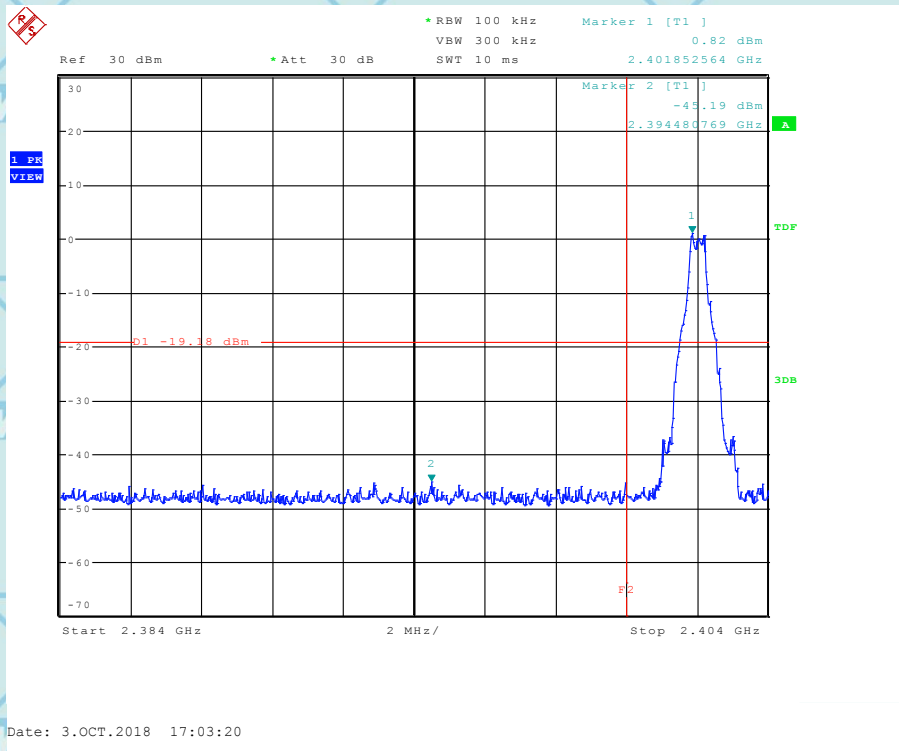



For Question, Please Contact with WSCT www.wsct-cert.com

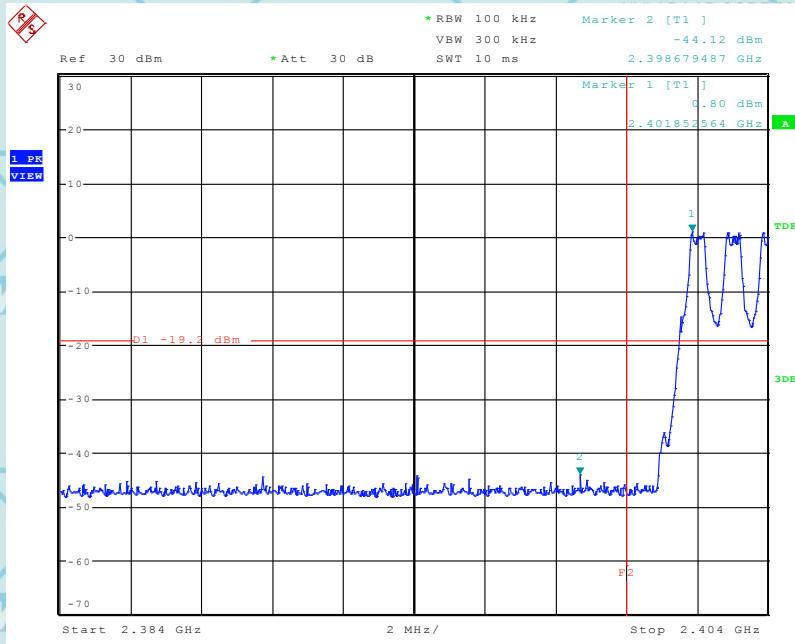

Date: 3.OCT.2018 17:04:57

Channel: High

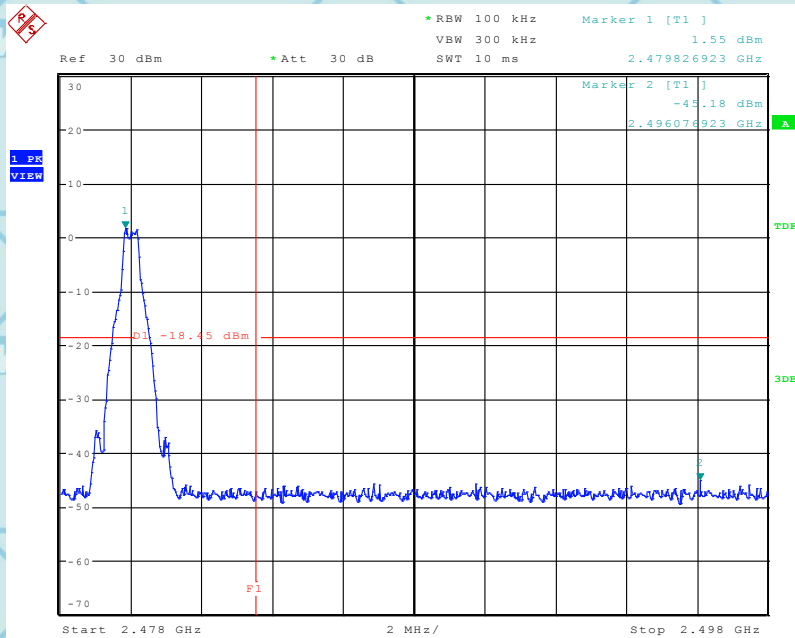

Date: 3.OCT.2018 17:06:01



世标检测认证股份

World Standardization Certification & Testing Group Co.,Ltd.

ADD:Building A-B Baoshi Science & technology Park, Baoshi Road, Bao'an District, Shenzhen, Guangdong, China TEL:86-755-26996143/26996144/26996145/26996192 FAX:86-755-86376605 E-mail:Fengbing.Wang@wsct-cert.com Http:www.wsct-cert.com

Member of the WSCT INC.



For Question, Please Contact with WSCT www.wsct-cert.com

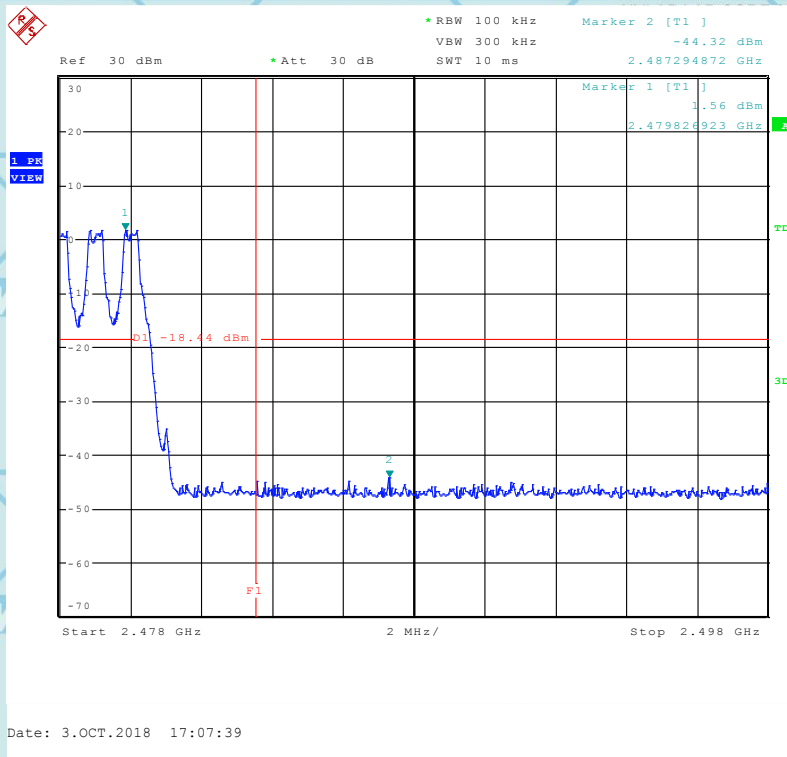

2Mbps Channel: Low

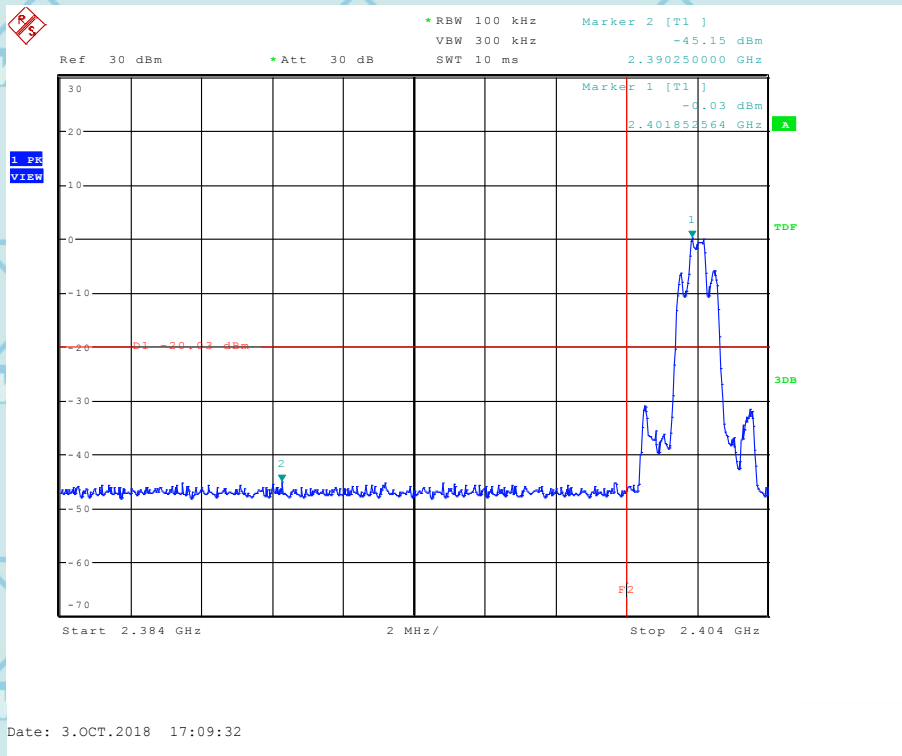



For Question, Please Contact with WSCT www.wsct-cert.com

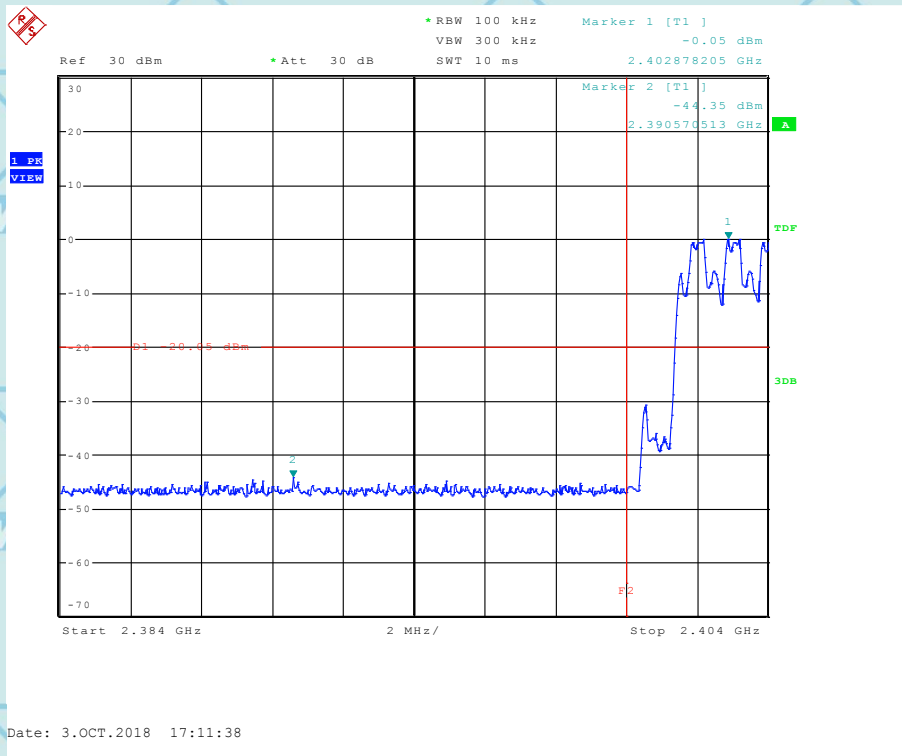

Channel: High

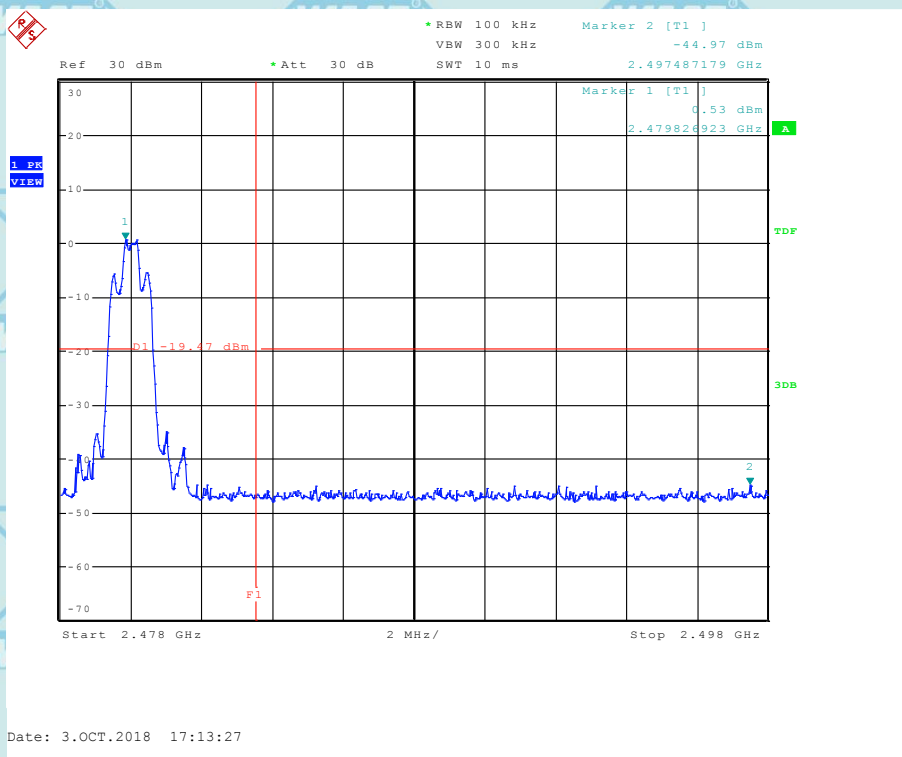



For Question, Please Contact with WSCT www.wsct-cert.com

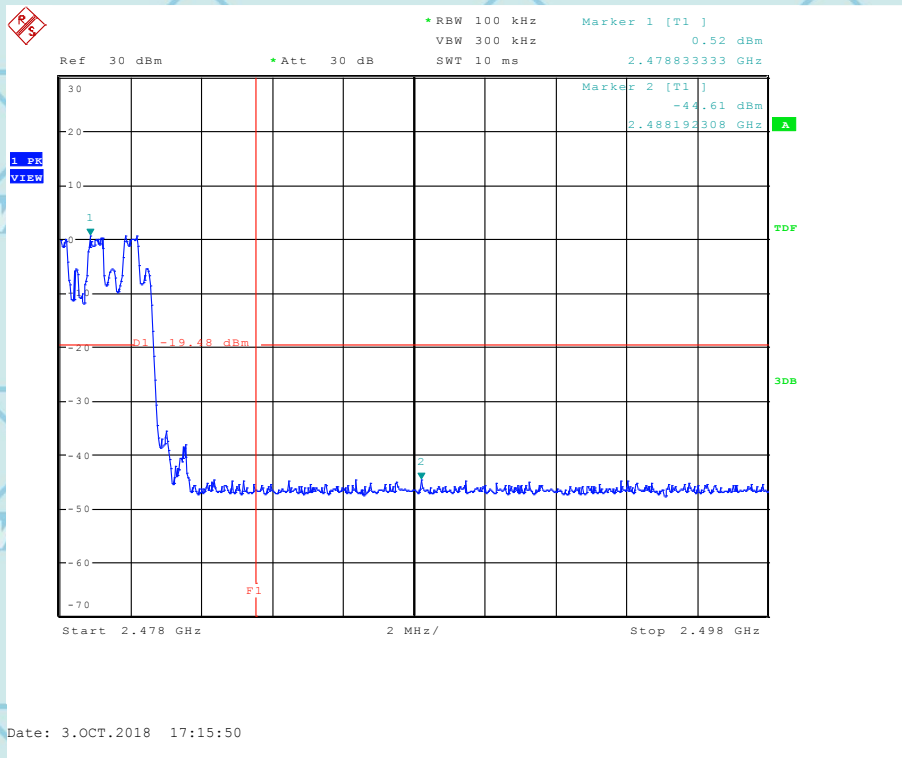

3Mbps Channel: Low

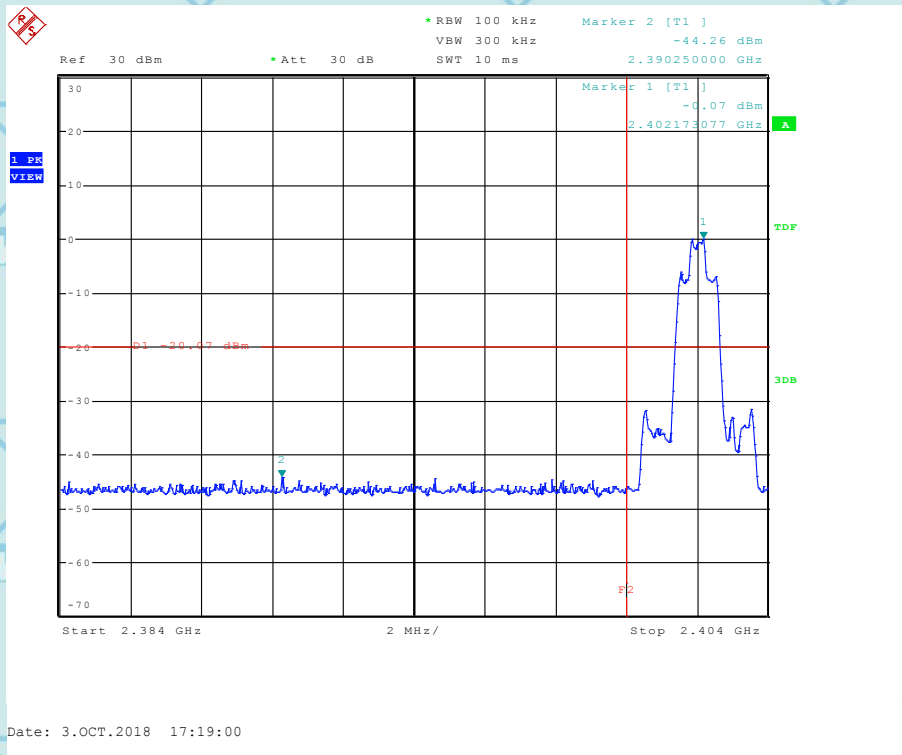



For Question, Please Contact with WSCT www.wsct-cert.com

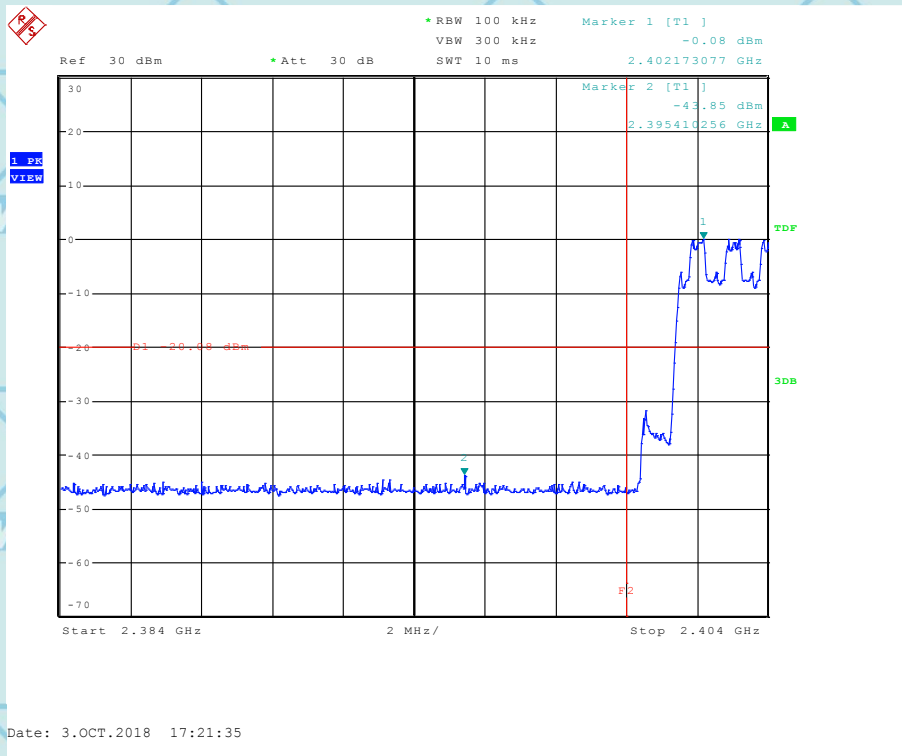

Channel: High

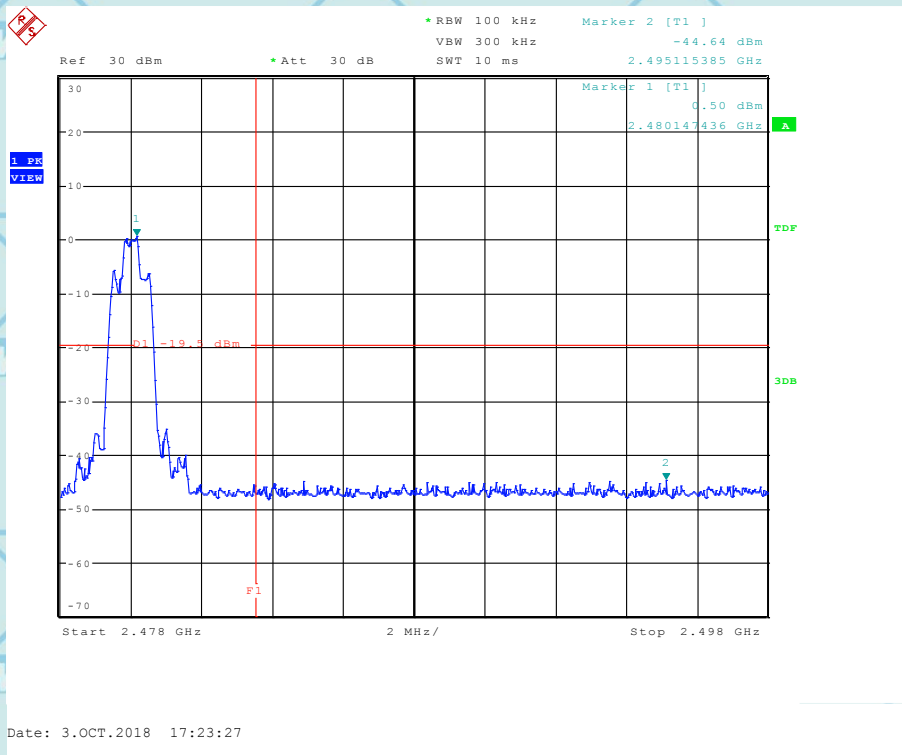



For Question, Please Contact with WSCT www.wsct-cert.com

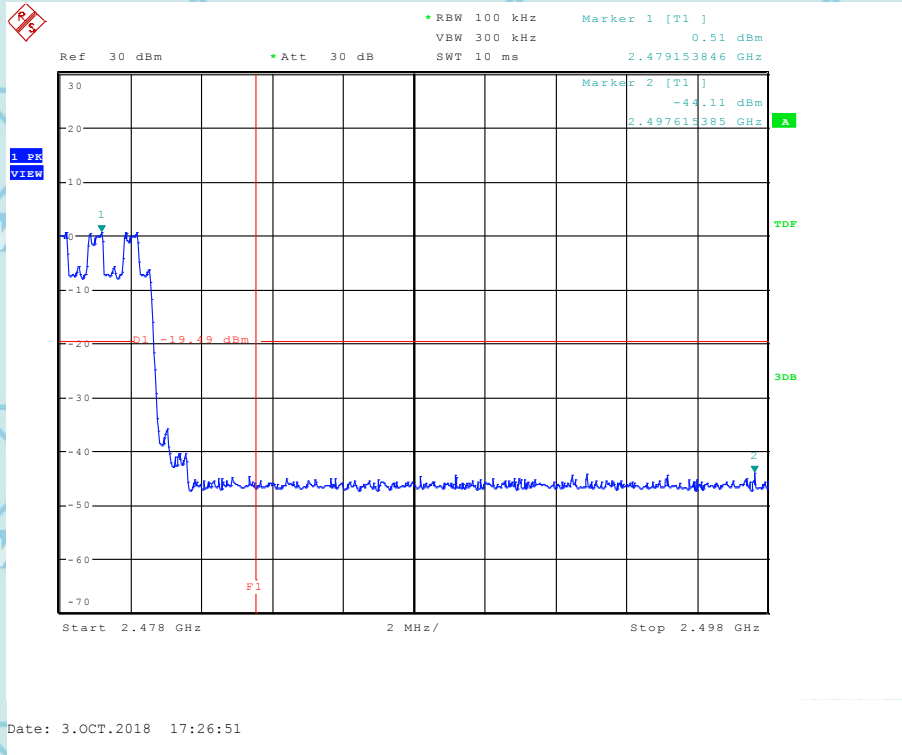

1Mbps

Channel: Low

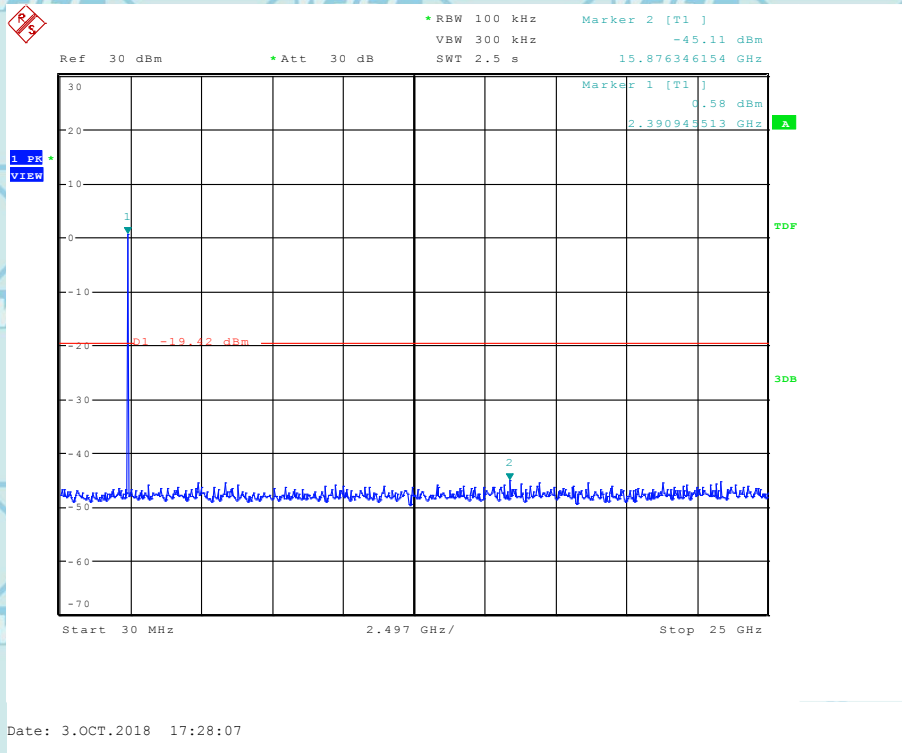



For Question, Please Contact with WSCT www.wsct-cert.com

Channel: Middle

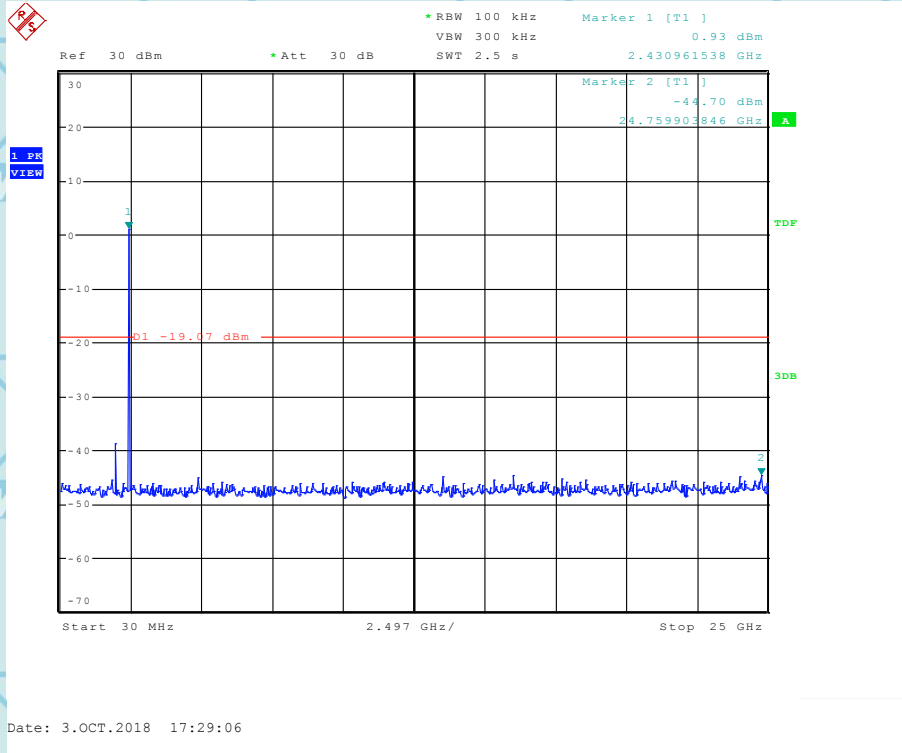

Channel: High

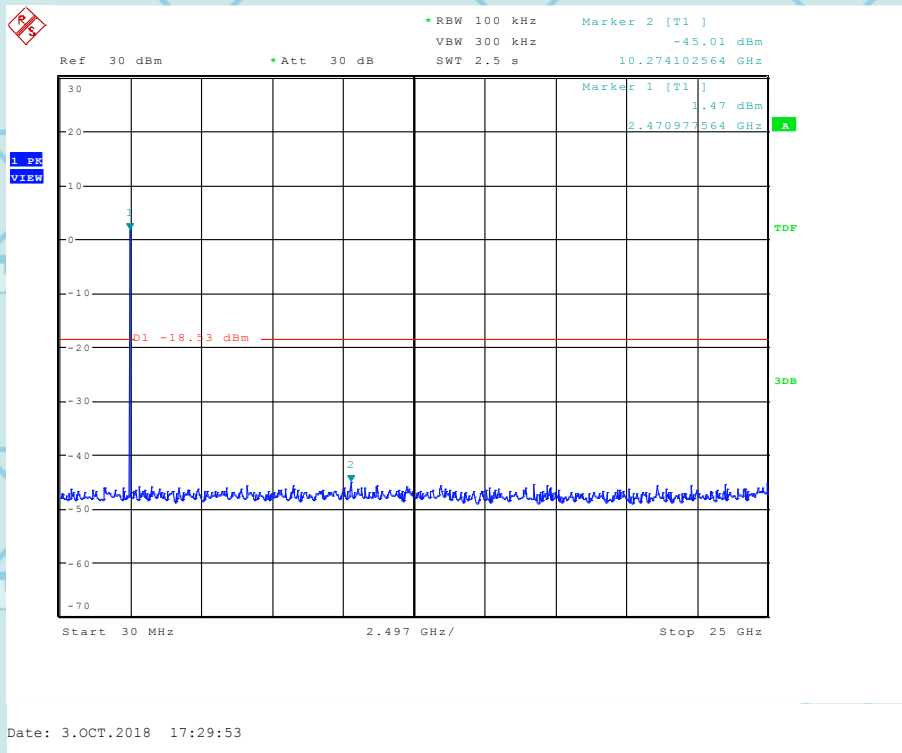



For Question, Please Contact with WSCT www.wsct-cert.com

2Mbps

Channel: Low

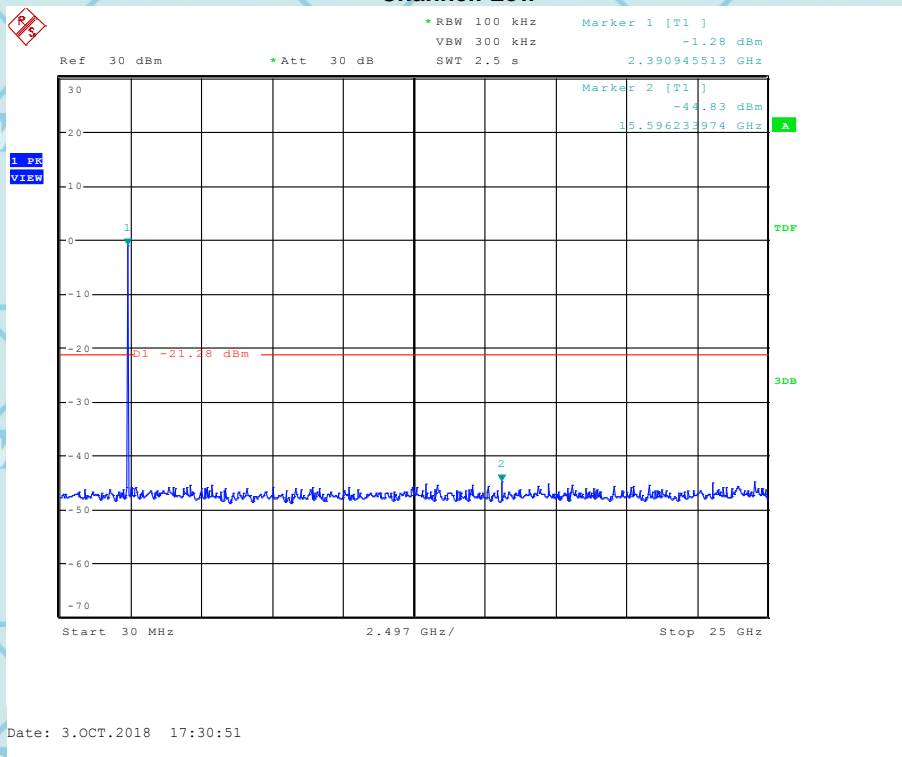

Channel: Middle

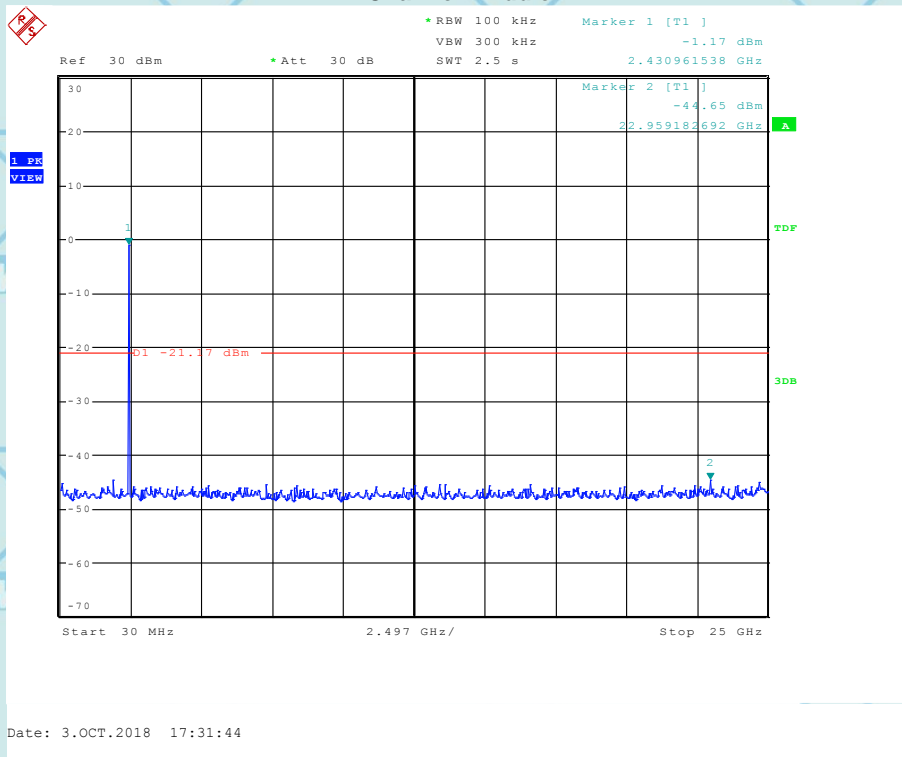



For Question, Please Contact with WSCT www.wsct-cert.com

Channel: High

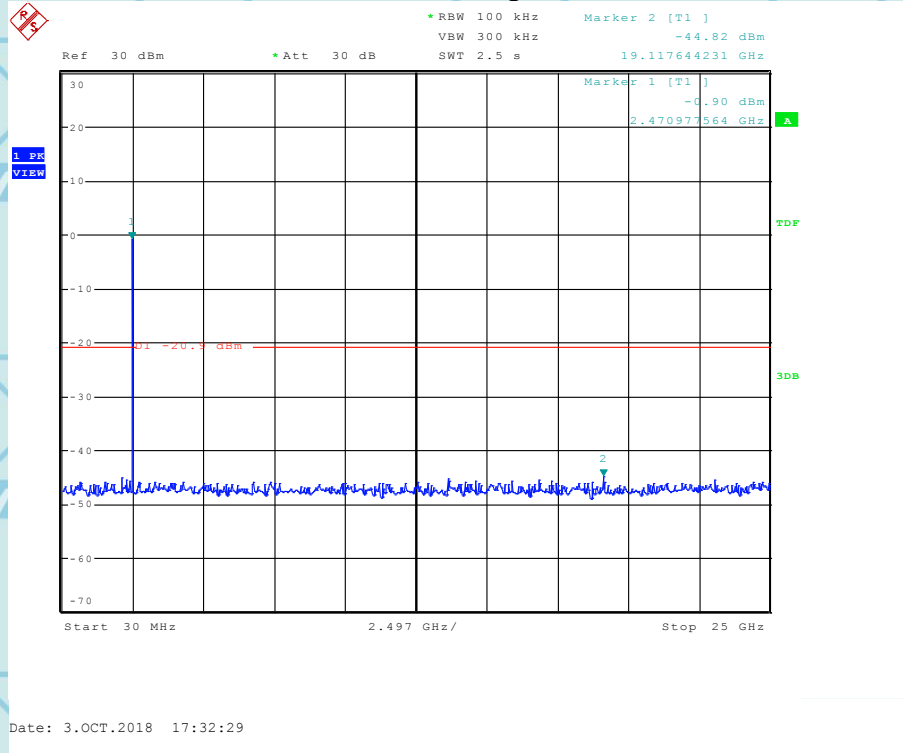

3Mbps

Channel: Low

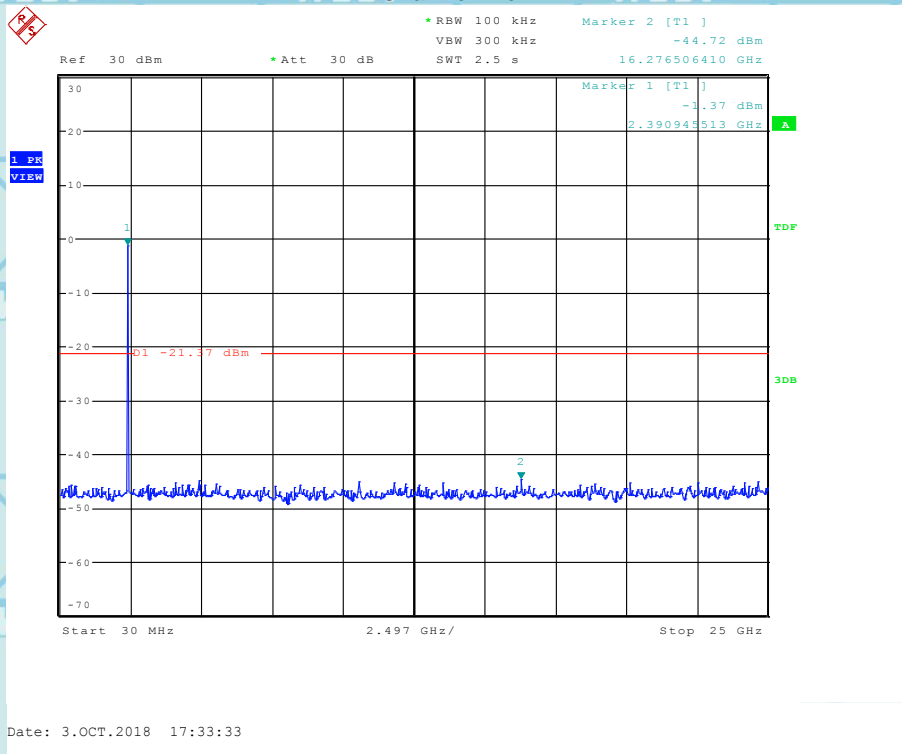



For Question,
Please Contact with WSCT
www.wsct-cert.com

Channel: Middle

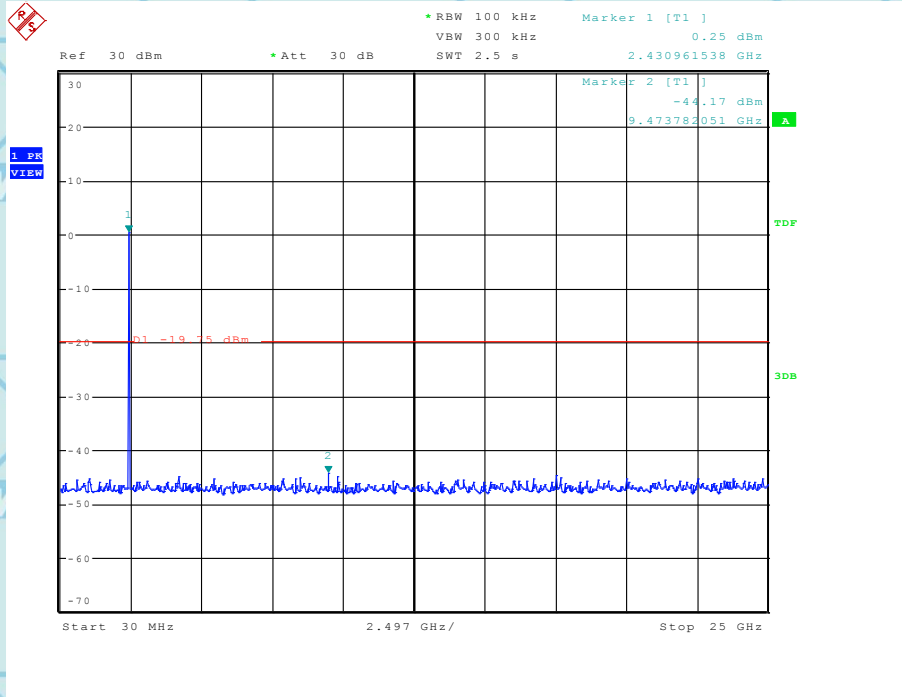

Date: 3.OCT.2018 17:34:25

Channel: High

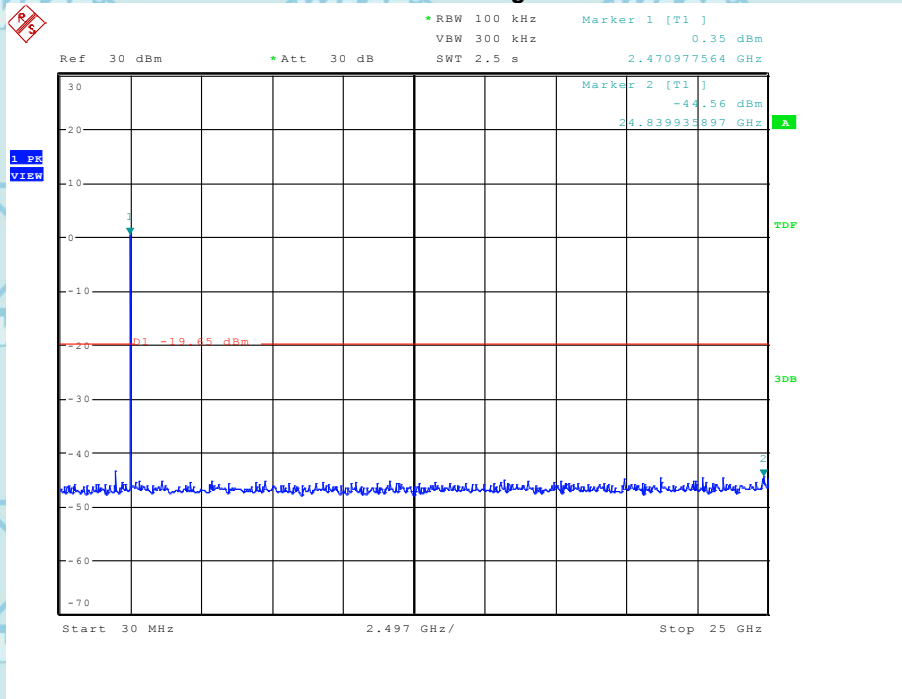

Date: 3.OCT.2018 17:35:22





10. ANTENNA APPLICATION

10.1 ANTENNA REQUIREMENT

The EUT'S antenna is met the requirement of FCC part 15C section 15.203 and 15.247

FCC part 15C section 15.247 requirements: Systems operating in the 2402-2480MHz band that are used exclusively for fixed.

10.1.2 Result

The EUT's antenna integrated on PCB, The antenna's gain is 1.26dBi and meets the requirement.

---END OF REPORT---

