

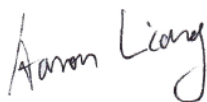

RF TEST REPORT

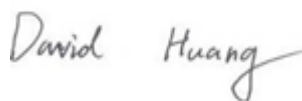

Report No.: 18070496-FCC-R1

Supersede Report No.: N/A

Applicant	INFINIX MOBILITY LIMITED	
Product Name	Mobile phone	
Model No.	X606D	
Serial No.	N/A	
Test Standard	FCC Part 22(H) ;FCC Part 24(E); FCC Part 27; ANSI/TIA-603-D: 2010	
Test Date	May 11 to 22, 2018	
Issue Date	May 23, 2018	
Test Result	<input checked="" type="checkbox"/> Pass <input type="checkbox"/> Fail	
Equipment complied with the specification	<input checked="" type="checkbox"/>	
Equipment did not comply with the specification	<input type="checkbox"/>	
		
Aaron Liang Test Engineer	David Huang Checked By	
This test report may be reproduced in full only Test result presented in this test report is applicable to the tested sample only		

Issued by:

SIEMIC (SHENZHEN-CHINA) LABORATORIES

Zone A, Floor 1, Building 2 Wan Ye Long Technology Park

South Side of Zhoushi Road, Bao' an District, Shenzhen, Guangdong China 518108

Phone: +86 0755 2601 4629801 Email: China@siemic.com.cn

Laboratories Introduction

SIEMIC, headquartered in the heart of Silicon Valley, with superior facilities in US and Asia, is one of the leading independent testing and certification facilities providing customers with one-stop shop services for Compliance Testing and Global Certifications.



In addition to testing and certification, SIEMIC provides initial design reviews and compliance management throughout a project. Our extensive experience with China, Asia Pacific, North America, European, and International compliance requirements, assures the fastest, most cost effective way to attain regulatory compliance for the global markets.

Accreditations for Conformity Assessment

Country/Region	Scope
USA	EMC, RF/Wireless, SAR, Telecom
Canada	EMC, RF/Wireless, SAR, Telecom
Taiwan	EMC, RF, Telecom, SAR, Safety
Hong Kong	RF/Wireless, SAR, Telecom
Australia	EMC, RF, Telecom, SAR, Safety
Korea	EMI, EMS, RF, SAR, Telecom, Safety
Japan	EMI, RF/Wireless, SAR, Telecom
Singapore	EMC, RF, SAR, Telecom
Europe	EMC, RF, SAR, Telecom, Safety

Test Report	18070496-FCC-R1
Page	3 of 91

This page has been left blank intentionally.

CONTENTS

1. REPORT REVISION HISTORY.....	5
2. CUSTOMER INFORMATION	5
3. TEST SITE INFORMATION.....	5
4. EQUIPMENT UNDER TEST (EUT) INFORMATION	6
5. TEST SUMMARY	9
6. MEASUREMENTS, EXAMINATION AND DERIVED RESULTS	10
6.1 RF EXPOSURE (SAR).....	10
6.2 RF OUTPUT POWER.....	11
6.3 PEAK-AVERAGE RATIO.....	26
6.4 OCCUPIED BANDWIDTH.....	30
6.5 SPURIOUS EMISSIONS AT ANTENNA TERMINALS.....	44
6.6 SPURIOUS RADIATED EMISSIONS.....	60
6.7 BAND EDGE.....	67
6.8 FREQUENCY STABILITY	81
ANNEX A. TEST INSTRUMENT.....	86
ANNEX B. TEST SETUP AND SUPPORTING EQUIPMENT.....	88
ANNEX C. EUT OPERATING CONKITIONS	90
ANNEX D. USER MANUAL / BLOCK DIAGRAM / SCHEMATICS / PARTLIST	91

1. Report Revision History

Report No.	Report Version	Description	Issue Date
18070496-FCC-R1	NONE	Original	May 23, 2018

2. Customer information

Applicant Name	INFINIX MOBILITY LIMITED
Applicant Add	RMS 05-15, 13A/F SOUTH TOWER WORLD FINANCE CTR HARBOUR CITY 17 CANTON RD TST KLN HONG KONG
Manufacturer	INFINIX MOBILITY LIMITED
Manufacturer Add	RMS 05-15, 13A/F SOUTH TOWER WORLD FINANCE CTR HARBOUR CITY 17 CANTON RD TST KLN HONG KONG

3. Test site information

Test Lab A:

Lab performing tests	SIEMIC (Shenzhen-China) LABORATORIES
Lab Address	Zone A, Floor 1, Building 2 Wan Ye Long Technology Park South Side of Zhoushi Road, Bao' an District, Shenzhen, Guangdong China 518108
FCC Test Site No.	535293
IC Test Site No.	4842E-1
Test Software	Radiated Emission Program-To Shenzhen v2.0

Test Lab B:

Lab performing tests	SIEMIC (Nanjing-China) Laboratories
Lab Address	2-1 Longcang Avenue Yuhua Economic and Technology Development Park, Nanjing, China
FCC Test Site No.	694825
IC Test Site No.	4842B-1
Test Software	EZ_EMG(ver.lcp-03A1)

Note: We just perform Radiated Spurious Emission above 18GHz in the test Lab. B.

4. Equipment under Test (EUT) Information

Description of EUT:	Mobile phone
Main Model:	X606D
Serial Model:	N/A
Date EUT received:	May 10, 2018
Test Date(s):	May 11 to 22, 2018
Equipment Category :	PCE
Antenna Gain:	GSM850: -3.03dBi PCS1900: -1.93dBi UMTS-FDD Band V: -3.03dBi UMTS-FDD Band II: -1.93dBi UMTS-FDD Band IV: -1.21dBi
Antenna Type:	PIFA antenna
Type of Modulation:	GSM / GPRS: GMSK EGPRS: GMSK,8PSK UMTS-FDD: QPSK
RF Operating Frequency (ies):	GSM850 TX: 824.2 ~ 848.8 MHz; RX: 869.2 ~ 893.8 MHz PCS1900 TX: 1850.2 ~ 1909.8 MHz; RX: 1930.2 ~ 1989.8 MHz UMTS-FDD Band V TX: 826.4 ~ 846.6 MHz; RX: 871.4 ~ 891.6 MHz UMTS-FDD Band II TX:1852.4 ~ 1907.6 MHz; RX: 1932.4 ~ 1987.6 MHz UMTS-FDD Band IV TX:1712.4 ~ 1752.6 MHz; RX : 2112.4 ~ 2152.6 MHz

Maximum Conducted
AV Power to Antenna:

GSM Voice:GSM850: 32.88 dBm
 PCS1900: 29.71 dBm
 GPRS:GSM850: 32.89 dBm
 PCS1900:29.73 dBm
 EGPRS(MCS5):GSM850: 26.62 dBm
 PCS1900: 26.92 dBm
 RMC:UMTS-FDD Band V: 23.01 dBm
 UMTS-FDD Band II: 22.55 dBm
 UMTS-FDD Band IV: 22.30 dBm
 HSUPA:UMTS-FDD Band V: 22.43 dBm
 UMTS-FDD Band II: 21.99 dBm
 UMTS-FDD Band IV: 21.71 dBm
 HSDPA:UMTS-FDD Band V: 22.45 dBm
 UMTS-FDD Band II: 21.89 dBm
 UMTS-FDD Band IV: 21.64 dBm

ERP/EIRP:

GSM Voice:GSM850: 27.70 dBm / ERP
 PCS1900: 27.78 dBm / EIRP
 GPRS:GSM850: 27.71 dBm / ERP
 PCS1900: 27.80 dBm / EIRP
 EGPRS(MCS5):GSM850: 21.44 dBm / ERP
 PCS1900: 24.99 dBm / EIRP
 RMC:UMTS-FDD Band V: 17.83 dBm / ERP
 UMTS-FDD Band II: 20.62 dBm / EIRP
 UMTS-FDD Band IV: 21.09 dBm / EIRP
 HSDPA:UMTS-FDD Band V: 17.25 dBm / ERP
 UMTS-FDD Band II: 19.89 dBm / EIRP
 UMTS-FDD Band IV: 20.43 dBm / EIRP
 HSUPA:UMTS-FDD Band V:17.20 dBm / ERP
 UMTS-FDD Band II: 19.90 dBm / EIRP
 UMTS-FDD Band IV: 22.13 dBm / EIRP

GSM 850: 124CH
 PCS1900: 299CH
 Number of Channels: UMTS-FDD Band V: 102CH
 UMTS-FDD Band IV: 202CH
 UMTS-FDD Band II: 277CH
 Port: Please refer to the user' s manual
 Adapter :
 Model: A88-502000
 Input: AC100-240V~50/60Hz,0.35A
 Output: DC 5.0V, 2.0A
 Input Power: Battery :
 Model: BL-39HX
 Rating: 3.85V, 3900mAh/4000mAh (min/typ)
 15.01Wh/15.40Wh (min/typ)
 Limited charge voltage: 4.4V
 Trade Name : Infinix
 GPRS/ EGPRS Multi-slot class 8/10/11/12
 FCC ID: 2AIZN-X606D

5. Test Summary

The product was tested in accordance with the following specifications.

All testing has been performed according to below product classification:

FCC Rules	Description of Test	Result
§ 1.1307; § 2.1093	RF Exposure (SAR)	Compliance
§2.1046; § 22.913(a); § 24.232(c); § 27.50(c.10) ; § 27.50(d.4)	RF Output Power	Compliance
§ 24.232 (d) ; § 27.50(d)	Peak-Average Ratio	Compliance
§ 2.1049; § 22.905; § 22.917; § 24.238; § 27.53(a.5)	99% & -26 dB Occupied Bandwidth	Compliance
§ 2.1051; § 22.917(a); § 24.238(a); § 27.53(h)	Spurious Emissions at Antenna Terminal	Compliance
§ 2.1053; § 22.917(a); § 24.238(a); § 27.53(h)	Field Strength of Spurious Radiation	Compliance
§ 22.917(a); § 24.238(a); § 27.53(h)	Out of band emission, Band Edge	Compliance
§ 2.1055; § 22.355; § 24.235; § 27.5(h); § 27.54	Frequency stability vs. temperature Frequency stability vs. voltage	Compliance

Note: Testing was performed by configuring EUT to maximum output power status, the declared output power class for different

Measurement Uncertainty

Emissions		
Test Item	Description	Uncertainty
Band Edge and Radiated Spurious Emissions	Confidence level of approximately 95% (in the case where distributions are normal), with a coverage factor of 2 (for EUTs < 0.5m X 0.5m X 0.5m)	+5.6dB/-4.5dB
-	-	-

6. MEASUREMENTS, EXAMINATION AND DERIVED RESULTS

6.1 RF Exposure (SAR)

Test Result: Pass

The EUT is a portable device, thus requires SAR evaluation;

Please refer to RF Exposure Evaluation Report: 18070496-FCC-H.

6.2 RF Output Power

Temperature	25°C
Relative Humidity	58%
Atmospheric Pressure	1016mbar
Test date :	May 16, 2018
Tested By :	Aaron Liang

Requirement(s):

Spec	Item	Requirement	Applicable
§22.913 (a)	a)	ERP:38.45dBm	<input checked="" type="checkbox"/>
§24.232 (c)	b)	EIRP:33dBm	<input checked="" type="checkbox"/>
§27.50 (c)	c)	EIRP: 30dBm	<input checked="" type="checkbox"/>

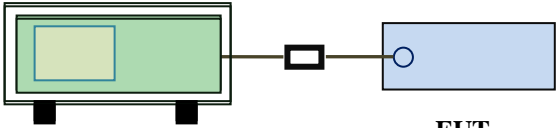
Test Setup	 <p style="text-align: center;">Base Station EUT</p>
------------	---

Test Procedure	<p>For Conducted Power:</p> <ul style="list-style-type: none"> - The transmitter output port was connected to base station. - Set EUT at maximum power through base station. - Select lowest, middle, and highest channels for each band and different test mode. <p>For ERP/EIRP:</p> <p>According with KDB 971168 v02r02</p> <ul style="list-style-type: none"> - The transmitter was placed on a wooden turntable, and it was transmitting into a non-radiating load which was also placed on the turntable. - The measurement antenna was placed at a distance of 3 meters from the EUT. During the tests, the antenna height and polarization as well as EUT azimuth were varied in order to identify the maximum level of emissions from the EUT. The test was performed by placing the EUT on 3-orthogonal axis. - The frequency range up to tenth harmonic of the fundamental
----------------	---

	<p>frequency was investigated.</p> <ul style="list-style-type: none"> - Remove the EUT and replace it with substitution antenna. A signal generator was connected to the substitution antenna by a non-radiating cable. The absolute levels of the spurious emissions were measured by the substitution. - Spurious emissions in dB = $10 \log (\text{TX power in Watts}/0.001)$ – the absolute level - Spurious attenuation limit in dB = $43 + 10 \text{ Log}_{10} (\text{power out in Watts})$.
Remark	
Result	<input checked="" type="checkbox"/> Pass <input type="checkbox"/> Fail

Test Data Yes N/A

Test Plot Yes (See below) N/A

Conducted Power

GSM Mode:

Burst Average Power (dBm);								
Band	GSM850				PCS1900			
Channel	128	190	251	Tune up Power tolerant	512	661	810	Tune up Power tolerant
Frequency (MHz)	824.2	836.6	848.8	/	1850.2	1880	1909.8	/
GSM Voice (1 uplink),GMSK	32.67	32.49	32.88	32±1	29.71	29.53	29.46	29±1
GPRS Multi-Slot Class 8 (1 uplink),GMSK	32.33	32.68	32.89	32±1	29.73	29.51	29.47	29±1
GPRS Multi-Slot Class 10 (2 uplink),GMSK	31.50	31.38	31.69	31±1	28.55	28.36	28.30	28±1
GPRS Multi-Slot Class 11 (3 uplink) GMSK	29.19	29.36	29.69	29±1	26.44	26.20	26.15	26±1
GPRS Multi-Slot Class 12 (4 uplink) GMSK	28.36	28.57	28.88	28±1	25.64	25.43	25.34	25±1
EGPRS Multi-Slot Class 8 (1 uplink) GMSK MCS1	32.31	32.67	32.88	32±1	29.77	29.46	29.44	29±1
EGPRS Multi-Slot Class 10 (2 uplink) GMSK MCS1	31.23	31.46	31.59	31±1	28.46	28.33	28.31	28±1
EGPRS Multi-Slot Class 11 (3 uplink) GMSK MCS1	29.1	29.33	29.61	29±1	26.41	26.25	26.49	26±1
EGPRS Multi-Slot Class 12 (4 uplink) GMSK MCS1	28.34	28.46	28.68	28±1	25.55	25.41	25.39	25±1
EGPRS Multi-Slot Class 8 (1 uplink) 8PSK MCS5	26.33	26.43	26.62	26±1	26.92	26.90	26.58	26±1

EGPRS Multi-Slot Class 10 (2 uplink) 8PSK MCS5	25.22	25.14	24.01	24.5±1	25.91	25.94	25.58	25.5±1
EGPRS Multi-Slot Class 11 (3 uplink) 8PSK MCS5	22.84	22.68	22.84	23±1	23.72	23.61	23.13	23±1
EGPRS Multi-Slot Class 12 (4 uplink) 8PSK MCS5	21.25	21.40	21.13	22±1	22.27	22.25	21.90	22±1

Remark :

GPRS, CS1 coding scheme.

EGPRS, MCS1 coding scheme.

EGPRS, MCS5 coding scheme.

Multi-Slot Class 8 , Support Max 4 downlink, 1 uplink , 5 working link

Multi-Slot Class 10 , Support Max 4 downlink, 2 uplink , 5 working link

Multi-Slot Class 11 , Support Max 4 downlink, 2 uplink , 5 working link

Multi-Slot Class 12 , Support Max 4 downlink, 4 uplink , 5 working link

UMTS Mode:

UMTS-FDD Band V

Band/ Time Slot configuration	Channel	Frequency	Average power (dBm)	Tune up Power tolerant
RMC 12.2kbps	4132	826.4	23.01	23±1
	4175	835	22.96	23±1
	4233	846.6	22.69	23±1
HSDPA Subtest1	4132	826.4	22.25	22±1
	4175	835	22.34	22±1
	4233	846.6	21.95	22±1
HSDPA Subtest2	4132	826.4	22.42	22±1
	4175	835	22.43	22±1
	4233	846.6	22.02	22±1
HSDPA Subtest3	4132	826.4	22.35	22±1
	4175	835	22.31	22±1
	4233	846.6	22.02	22±1
HSDPA Subtest4	4132	826.4	22.38	22±1
	4175	835	22.30	22±1
	4233	846.6	22.14	22±1
HSUPA Subtest1	4132	826.4	22.35	22±1
	4175	835	22.36	22±1
	4233	846.6	21.94	22±1
HSUPA Subtest2	4132	826.4	22.19	22±1
	4175	835	22.19	22±1
	4233	846.6	22.02	22±1
HSUPA Subtest3	4132	826.4	22.41	22±1
	4175	835	22.33	22±1
	4233	846.6	22.08	22±1
HSUPA Subtest4	4132	826.4	22.03	22±1
	4175	835	22.18	22±1
	4233	846.6	21.74	22±1
HSUPA Subtest5	4132	826.4	22.25	22±1
	4175	835	22.45	22±1
	4233	846.6	21.93	22±1

UMTS-FDD Band II

Band/ Time Slot configuration	Channel	Frequency	Average power (dBm)	Tune up Power tolerant
RMC 12.2kbps	9262	1852.4	22.55	22±1
	9400	1880	22.14	22±1
	9538	1907.6	21.93	22±1
HSDPA Subtest1	9262	1852.4	21.82	21±1
	9400	1880	21.47	21±1
	9538	1907.6	21.18	21±1
HSDPA Subtest2	9262	1852.4	21.91	21±1
	9400	1880	21.61	21±1
	9538	1907.6	21.37	21±1
HSDPA Subtest3	9262	1852.4	21.94	21±1
	9400	1880	21.52	21±1
	9538	1907.6	21.21	21±1
HSDPA Subtest4	9262	1852.4	21.99	21±1
	9400	1880	21.44	21±1
	9538	1907.6	21.38	21±1
HSUPA Subtest1	9262	1852.4	21.89	21±1
	9400	1880	21.39	21±1
	9538	1907.6	21.15	21±1
HSUPA Subtest2	9262	1852.4	21.83	21±1
	9400	1880	21.43	21±1
	9538	1907.6	21.19	21±1
HSUPA Subtest3	9262	1852.4	21.85	21±1
	9400	1880	21.51	21±1
	9538	1907.6	21.30	21±1
HSUPA Subtest4	9262	1852.4	21.83	21±1
	9400	1880	21.34	21±1
	9538	1907.6	21.12	21±1
HSUPA Subtest5	9262	1852.4	21.76	21±1
	9400	1880	21.60	21±1
	9538	1907.6	21.20	21±1

UMTS-FDD Band IV

Band/ Time Slot configuration	Channel	Frequency	Average power (dBm)	Tune up Power tolerant
RMC 12.2kbps	1313	1712.6	21.43	22±1
	1413	1732.6	22.30	22±1
	1512	1752.4	21.46	22±1
HSDPA Subtest1	1313	1712.6	20.70	21±1
	1413	1732.6	21.50	21±1
	1512	1752.4	20.85	21±1
HSDPA Subtest2	1313	1712.6	20.86	21±1
	1413	1732.6	21.71	21±1
	1512	1752.4	20.94	21±1
HSDPA Subtest3	1313	1712.6	20.70	21±1
	1413	1732.6	21.53	21±1
	1512	1752.4	20.69	21±1
HSDPA Subtest4	1313	1712.6	20.74	21±1
	1413	1732.6	21.68	21±1
	1512	1752.4	20.75	21±1
HSUPA Subtest1	1313	1712.6	20.82	21±1
	1413	1732.6	21.64	21±1
	1512	1752.4	20.80	21±1
HSUPA Subtest2	1313	1712.6	20.73	21±1
	1413	1732.6	21.64	21±1
	1512	1752.4	20.71	21±1
HSUPA Subtest3	1313	1712.6	20.70	21±1
	1413	1732.6	21.55	21±1
	1512	1752.4	20.84	21±1
HSUPA Subtest4	1313	1712.6	20.67	21±1
	1413	1732.6	21.40	21±1
	1512	1752.4	20.56	21±1
HSUPA Subtest5	1313	1712.6	20.79	21±1
	1413	1732.6	21.57	21±1
	1512	1752.4	20.88	21±1

ERP & EIRP

GSM Voice

ERP for Cellular Band (Part 22H)

Frequency (MHz)	Antenna Polarization (H/V)	Absolute Level (dBm)	Limit (dBm)	Margin (dB)
824.2	V	27.49	38.45	-10.96
824.2	H	26.75	38.45	-11.7
836.6	V	27.31	38.45	-11.14
836.6	H	25.97	38.45	-12.48
848.8	V	27.70	38.45	-10.75
848.8	H	26.83	38.45	-11.62

EIRP for PCS Band (Part 24E)

Frequency (MHz)	Antenna Polarization (H/V)	Absolute Level (dBm)	Limit (dBm)	Margin (dB)
1850.2	V	27.78	33	-5.22
1850.2	H	25.85	33	-7.15
1880	V	27.60	33	-5.4
1880	H	26.81	33	-6.19
1909.8	V	27.53	33	-5.47
1909.8	H	26.24	33	-6.76

GPRS:

ERP for Cellular Band (Part 22H)

Frequency (MHz)	Antenna Polarization (H/V)	Absolute Level (dBm)	Limit (dBm)	Margin (dB)
824.2	V	27.15	38.45	-11.3
824.2	H	26.03	38.45	-12.42
836.6	V	27.50	38.45	-10.95
836.6	H	26.32	38.45	-12.13
848.8	V	27.71	38.45	-10.74
848.8	H	26.47	38.45	-11.98

EIRP for PCS Band (Part 24E)

Frequency (MHz)	Antenna Polarization (H/V)	Absolute Level (dBm)	Limit (dBm)	Margin (dB)
1850.2	V	27.80	33	-5.2
1850.2	H	26.71	33	-6.29
1880	V	27.58	33	-5.42
1880	H	26.77	33	-6.23
1909.8	V	27.54	33	-5.46
1909.8	H	26.10	33	-6.9

EGPRS (MCS5):

ERP for Cellular Band (Part 22H)

Frequency (MHz)	Antenna Polarization (H/V)	Absolute Level (dBm)	Limit (dBm)	Margin (dB)
824.2	V	21.44	38.45	-17.01
824.2	H	19.55	38.45	-18.9
836.6	V	21.25	38.45	-17.2
836.6	H	19.62	38.45	-18.83
848.8	V	21.15	38.45	-17.3
848.8	H	19.77	38.45	-18.68

EIRP for PCS Band (Part 24E)

Frequency (MHz)	Antenna Polarization (H/V)	Absolute Level (dBm)	Limit (dBm)	Margin (dB)
1850.2	V	24.97	33	-8.03
1850.2	H	23.77	33	-9.23
1880	V	24.99	33	-8.01
1880	H	23.47	33	-9.53
1909.8	V	24.65	33	-8.35
1909.8	H	22.69	33	-10.31

RMC

ERP for UMTS-FDD Band V (Part 22H)

Frequency (MHz)	Antenna Polarization (H/V)	Absolute Level (dBm)	Limit (dBm)	Margin (dB)
826.4	V	17.83	38.45	-20.62
826.4	H	16.55	38.45	-21.9
835	V	17.78	38.45	-20.67
835	H	16.57	38.45	-21.88
846.6	V	17.51	38.45	-20.94
846.6	H	16.27	38.45	-22.18

EIRP for UMTS-FDD Band II (Part 24E)

Frequency (MHz)	Antenna Polarization (H/V)	Absolute Level (dBm)	Limit (dBm)	Margin (dB)
1852.4	V	20.62	33	-12.38
1852.4	H	19.30	33	-13.7
1880	V	20.21	33	-12.79
1880	H	19.27	33	-13.73
1907.6	V	20.00	33	-13
1907.6	H	18.67	33	-14.33

EIRP for UMTS-FDD Band IV (Part 27H)

Frequency (MHz)	Antenna Polarization (H/V)	Absolute Level (dBm)	Limit (dBm)	Margin (dB)
1712.4	V	20.22	30	-9.78
1712.4	H	18.97	30	-11.03
1740	V	21.09	30	-8.91
1740	H	19.16	30	-10.84
1752.6	V	20.25	30	-9.75
1752.6	H	19.19	30	-10.81

HSDPA

ERP for UMTS-FDD Band V (Part 22H)

Frequency (MHz)	Antenna Polarization (H/V)	Absolute Level (dBm)	Limit (dBm)	Margin (dB)
826.4	V	17.07	38.45	-21.38
826.4	H	15.67	38.45	-22.78
835	V	16.77	38.45	-21.68
835	H	15.26	38.45	-23.19
846.6	V	17.25	38.45	-21.2
846.6	H	16.22	38.45	-22.23

EIRP for UMTS-FDD Band II (Part 24E)

Frequency (MHz)	Antenna Polarization (H/V)	Absolute Level (dBm)	Limit (dBm)	Margin (dB)
1852.4	V	19.89	33	-13.11
1852.4	H	18.82	33	-14.18
1880	V	19.25	33	-13.75
1880	H	17.36	33	-15.64
1907.6	V	19.68	33	-13.32
1907.6	H	17.69	33	-15.31

EIRP for UMTS-FDD Band IV (Part 27H)

Frequency (MHz)	Antenna Polarization (H/V)	Absolute Level (dBm)	Limit (dBm)	Margin (dB)
1712.4	V	19.61	30	-10.39
1712.4	H	17.79	30	-12.21
1740	V	19.59	30	-10.41
1740	H	18.02	30	-11.98
1752.6	V	20.43	30	-9.57
1752.6	H	19.44	30	-10.56

HSUPA

ERP for UMTS-FDD Band V (Part 22H)

Frequency (MHz)	Antenna Polarization (H/V)	Absolute Level (dBm)	Limit (dBm)	Margin (dB)
826.4	V	17.20	38.45	-21.25
826.4	H	15.50	38.45	-22.95
835	V	16.96	38.45	-21.49
835	H	15.55	38.45	-22.9
846.6	V	17.18	38.45	-21.27
846.6	H	15.55	38.45	-22.9

EIRP for UMTS-FDD Band II (Part 24E)

Frequency (MHz)	Antenna Polarization (H/V)	Absolute Level (dBm)	Limit (dBm)	Margin (dB)
1852.4	V	19.45	33	-13.55
1852.4	H	18.32	33	-14.68
1880	V	19.46	33	-13.54
1880	H	18.09	33	-14.91
1907.6	V	19.90	33	-13.1
1907.6	H	18.62	33	-14.38

EIRP for UMTS-FDD Band IV (Part 27H)

Frequency (MHz)	Antenna Polarization (H/V)	Absolute Level (dBm)	Limit (dBm)	Margin (dB)
1712.4	V	22.13	30	-7.87
1712.4	H	21.31	30	-8.69
1740	V	20.98	30	-9.02
1740	H	19.45	30	-10.55
1752.6	V	21.73	30	-8.27
1752.6	H	20.17	30	-9.83

6.3 Peak-Average Ratio

Temperature	25°C
Relative Humidity	58%
Atmospheric Pressure	1016mbar
Test date :	May 16, 2018
Tested By :	Aaron Liang

Requirement(s):

Spec	Item	Requirement	Applicable
§24.232(d) § 27.50(d)	a)	The peak-to-average ratio (PAR) of the transmission may not exceed 13 dB.	<input checked="" type="checkbox"/>

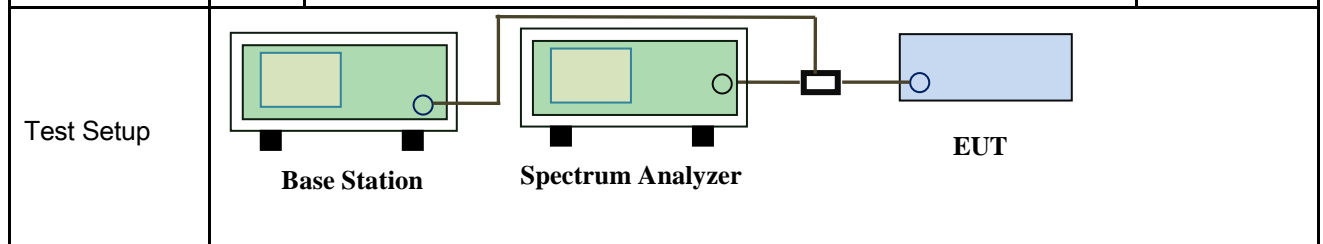

Test Procedure	<p>According with KDB 971168 v02r02</p> <p>5.7.2 Alternate procedure for PAPR</p> <p>5.1.2 Peak power measurements with a peak power meter</p> <p>The total peak output power may be measured using a broadband peak RF power meter. The power meter must have a video bandwidth that is greater than or equal to the emission bandwidth and utilize a fast-responding diode detector.</p> <p>5.2.3 Average power measurement with average power meter</p> <p>As an alternative to the use of a spectrum/signal analyzer or EMI receiver to perform a measurement of the total in-band average output power, a wideband RF average power meter with a thermocouple detector or equivalent can be used under certain conditions</p> <p>If the EUT can be configured to transmit continuously (i.e., the burst duty cycle $\geq 98\%$) and at all times the EUT is transmitting at its maximum output</p>
----------------	--

	<p>power level, then a conventional wide-band RF power meter can be used.</p> <p>If the EUT cannot be configured to transmit continuously (i.e., the burst duty cycle < 98%), then there are two options for the use of an average power meter. First, a gated average power meter can be used to perform the measurement if the gating parameters can be adjusted such that the power is measured only over active transmission bursts at maximum output power levels. A conventional average power meter can also be used if the measured burst duty cycle is constant (i.e., duty cycle variations are less than ± 2 percent) by performing the measurement over the on/off burst cycles and then correcting (increasing) the measured level by a factor equal to $10\log(1/\text{duty cycle})$</p>
Remark	
Result	<input checked="" type="checkbox"/> Pass <input type="checkbox"/> Fail

Test Data Yes N/A
Test Plot Yes (See below) N/A

GSM : GSM 1900 PK-AV POWER (PART 24E)

Frequency (MHz)	Conducted power(dBm)		Peak-Average Ratio(PAR)
	Peak	Average	
1850.2	30.52	29.71	0.81
1880	30.45	29.53	0.92
1909.8	30.68	29.46	1.22

GPRS 1900 PK-AV POWER (PART 24E)

Frequency (MHz)	Conducted power(dBm)		Peak-Average Ratio(PAR)
	Peak	Average	
1850.2	30.85	29.73	1.12
1880	30.71	29.51	1.2
1909.8	30.28	29.47	0.81

EGPRS (MSC1) 1900 PK-AV POWER (PART 24E)

Frequency (MHz)	Conducted power(dBm)		Peak-Average Ratio(PAR)
	Peak	Average	
1850.2	27.92	26.9	1.02
1880	28.01	26.92	1.09
1909.8	27.67	26.58	1.09

RMC : UMTS-FDD Band II PK-AV POWER (PART 24E)

Frequency (MHz)	Conducted power(dBm)		Peak-Average Ratio(PAR)
	Peak	Average	
1852.4	23.56	22.55	1.01
1880	23.24	22.14	1.1
1907.6	23.02	21.93	1.09

UMTS-FDD Band IV PK-AV POWER (PART 27)

Frequency (MHz)	Conducted power(dBm)		Peak-Average Ratio(PAR)
	Peak	Average	
1712.6	22.44	21.43	1.01
1732.6	23.08	22.3	0.78
1752.4	22.48	21.46	1.02

HSDPA : UMTS-FDD Band II PK-AV POWER (PART 24E)

Frequency (MHz)	Conducted power(dBm)		Peak-Average Ratio(PAR)
	Peak	Average	
1852.4	23.66	22.25	1.41
1880	23.52	22.34	1.18
1907.6	23.47	21.95	1.52

UMTS-FDD Band IV PK-AV POWER (PART 27)

Frequency (MHz)	Conducted power(dBm)		Peak-Average Ratio(PAR)
	Peak	Average	
1712.6	21.71	20.7	1.01
1732.6	22.32	21.5	0.82
1752.4	21.97	20.85	1.12

HSUPA : UMTS-FDD Band II PK-AV POWER (PART 24E)

Frequency (MHz)	Conducted power(dBm)		Peak-Average Ratio(PAR)
	Peak	Average	
1852.4	21.73	20.82	0.91
1880	22.75	21.64	1.11
1907.6	21.59	20.8	0.79

UMTS-FDD Band IV PK-AV POWER (PART 27)

Frequency (MHz)	Conducted power(dBm)		Peak-Average Ratio(PAR)
	Peak	Average	
1712.6	23.49	22.35	1.14
1732.6	23.45	22.36	1.09
1752.4	23.62	21.94	1.68

6.4 Occupied Bandwidth

Temperature	25°C
Relative Humidity	58%
Atmospheric Pressure	1016mbar
Test date :	May 16&21, 2018
Tested By :	Aaron Liang

Requirement(s):

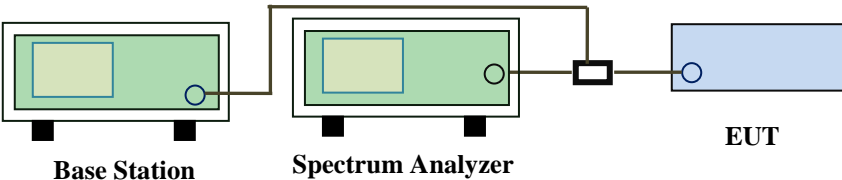
Spec	Item	Requirement	Applicable
§2.1049, §22.917, §22.905 §24.238 §27.53(a)	a)	99% Occupied Bandwidth(kHz)	<input checked="" type="checkbox"/>
	b)	26 dB Bandwidth(kHz)	<input checked="" type="checkbox"/>
Test Setup	 <p style="text-align: center;">Base Station Spectrum Analyzer EUT</p>		
Test Procedure	<ul style="list-style-type: none"> - The EUT was connected to Spectrum Analyzer and Base Station via power divider. - The 99% and 26 dB occupied bandwidth (BW) of the middle channel for the highest RF powers. 		
Remark			
Result	<input checked="" type="checkbox"/> Pass <input type="checkbox"/> Fail		

Test Data Yes N/A
 Test Plot Yes (See below) N/A

GSM Voice:

Cellular Band (Part 22H) result

Channel	Frequency (MHz)	99% Occupied Bandwidth (kHz)	26 dB Bandwidth (kHz)
128	824.2	247.80	312.6
190	836.6	246.18	312.4
251	848.8	248.17	314.8

PCS Band (Part 24E) result

Channel	Frequency (MHz)	99% Occupied Bandwidth (kHz)	26 dB Bandwidth (kHz)
512	1850	244.62	324.5
661	1880	245.56	322.4
810	1910	245.38	320.8

GPRS:

Cellular Band (Part 22H) result

Channel	Frequency (MHz)	99% Occupied Bandwidth (kHz)	26 dB Bandwidth (kHz)
128	824.2	245.27	315.7
190	836.6	247.70	317.9
251	848.8	243.09	313.5

PCS Band (Part 24E) result

Channel	Frequency (MHz)	99% Occupied Bandwidth (kHz)	26 dB Bandwidth (kHz)
512	1850	246.04	320.8
661	1880	245.63	322.4
810	1910	248.00	318.0

EGPRS (MCS 5):

Cellular Band (Part 22H) result

Channel	Frequency (MHz)	99% Occupied Bandwidth (kHz)	26 dB Bandwidth (kHz)
128	824.2	247.14	315.3
190	836.6	245.42	312.6
251	848.8	244.44	314.3

PCS Band (Part 24E) result

Channel	Frequency (MHz)	99% Occupied Bandwidth (kHz)	26 dB Bandwidth (kHz)
512	1850.2	245.26	319.6
661	1880.0	244.31	321.0
810	1909.8	248.76	320.6

RMC:

UMTS-FDD Band V (Part 22H)

Channel	Frequency (MHz)	99% Occupied Bandwidth (MHz)	26 dB Bandwidth (MHz)
4132	826.6	4.1423	4.668
4175	835.0	4.1579	4.666
4233	846.4	4.1518	4.658

UMTS-FDD Band II (Part 24E)

Channel	Frequency (MHz)	99% Occupied Bandwidth (MHz)	26 dB Bandwidth (MHz)
9262	1853	4.1499	4.690
9400	1880	4.1583	4.685
9538	1907	4.1534	4.681

UMTS-FDD Band IV (Part 27)

Channel	Frequency (MHz)	99% Occupied Bandwidth (MHz)	26 dB Bandwidth (MHz)
1313	1713	4.1485	4.680
1413	1733	4.1467	4.681
1512	1752	4.1528	4.679

HSDPA:

UMTS-FDD Band V (Part 22H)

Channel	Frequency (MHz)	99% Occupied Bandwidth (MHz)	26 dB Bandwidth (MHz)
4132	826.6	4.1473	4.658
4175	835.0	4.1558	4.673
4233	846.4	4.1473	4.652

UMTS-FDD Band II (Part 24E)

Channel	Frequency (MHz)	99% Occupied Bandwidth (MHz)	26 dB Bandwidth (MHz)
9262	1853	4.1545	4.690
9400	1880	4.1581	4.690
9538	1907	4.1609	4.687

UMTS-FDD Band IV (Part 27)

Channel	Frequency (MHz)	99% Occupied Bandwidth (MHz)	26 dB Bandwidth (MHz)
1313	1713	4.1475	4.682
1413	1733	4.1462	4.681
1512	1752	4.1612	4.675

HSUPA:

UMTS-FDD Band V (Part 22H)

Channel	Frequency (MHz)	99% Occupied Bandwidth (MHz)	26 dB Bandwidth (MHz)
4132	826.6	4.1410	4.667
4175	835.0	4.1523	4.679
4233	846.4	4.1576	4.638

UMTS-FDD Band II (Part 24E)

Channel	Frequency (MHz)	99% Occupied Bandwidth (MHz)	26 dB Bandwidth (MHz)
9262	1853	4.1674	4.693
9400	1880	4.1560	4.689
9538	1907	4.1568	4.687

UMTS-FDD Band IV (Part 27)

Channel	Frequency (MHz)	99% Occupied Bandwidth (MHz)	26 dB Bandwidth (MHz)
1313	1713	4.1490	4.690
1413	1733	4.1545	4.676
1512	1752	4.1575	4.676

Test Plots

GSM Voice:

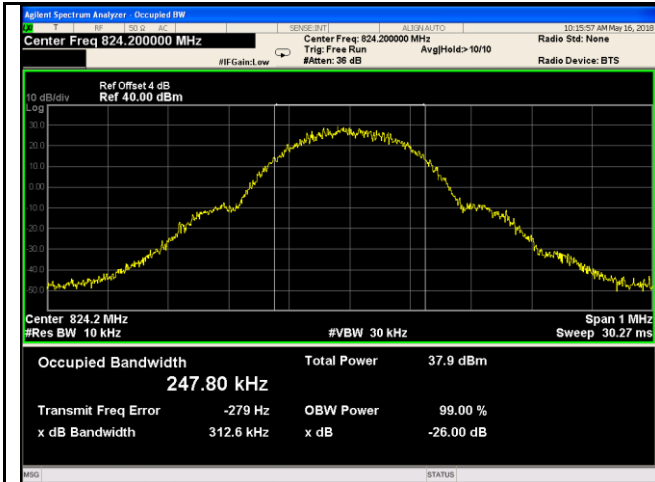

GSM 850 BW - Low CH 824.2MHz

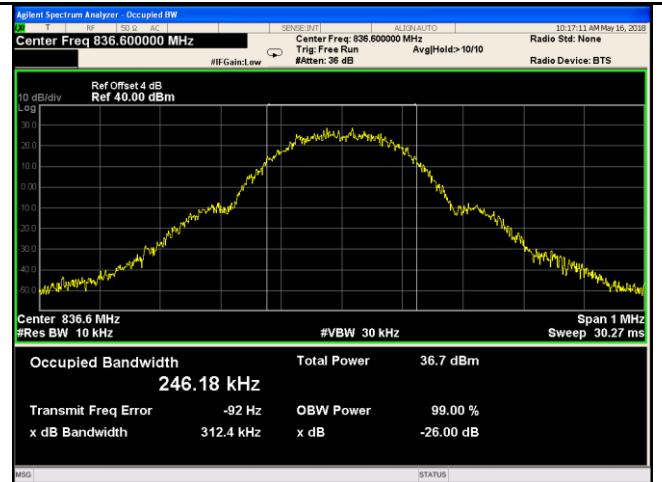

GSM 850 BW - Mid CH 836.6MHz

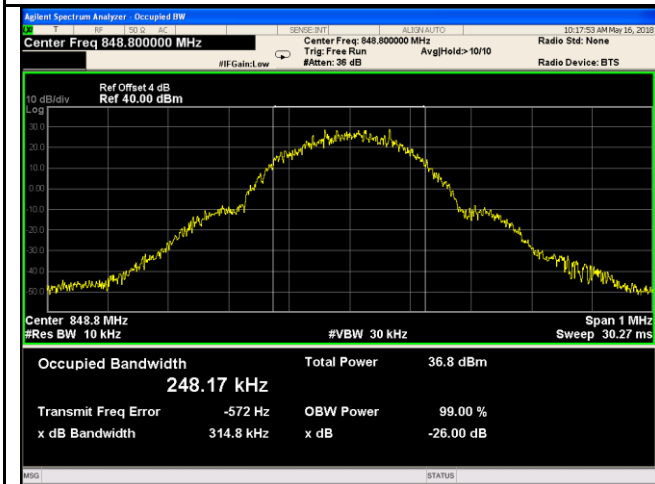

GSM 850 BW - High CH 848.8MHz

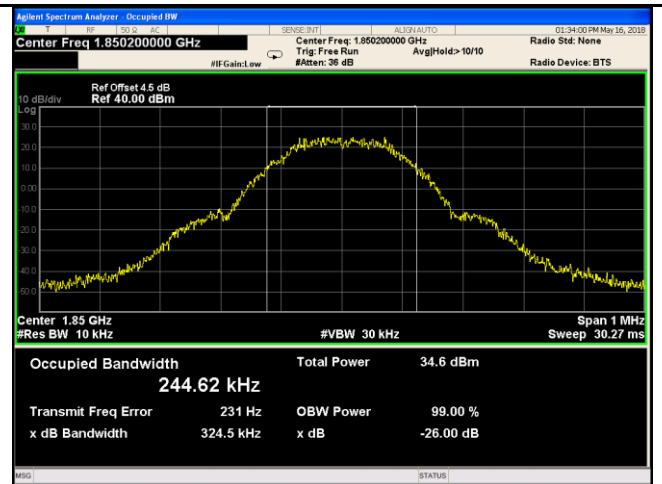

PCS 1900 BW - Low CH 1850MHz

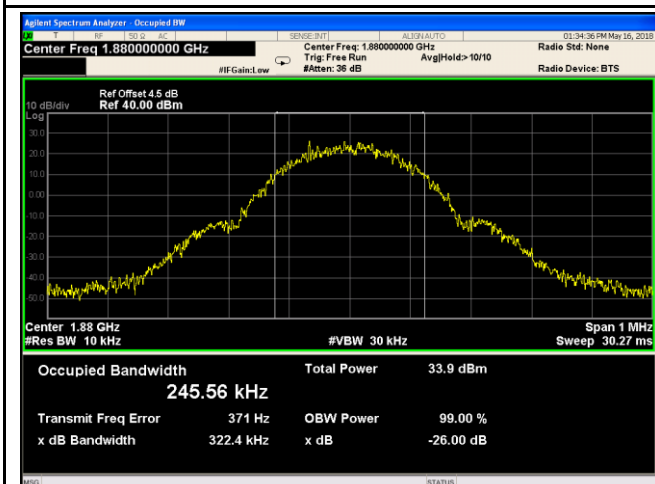

PCS 1900 BW - Mid CH 1880MHz

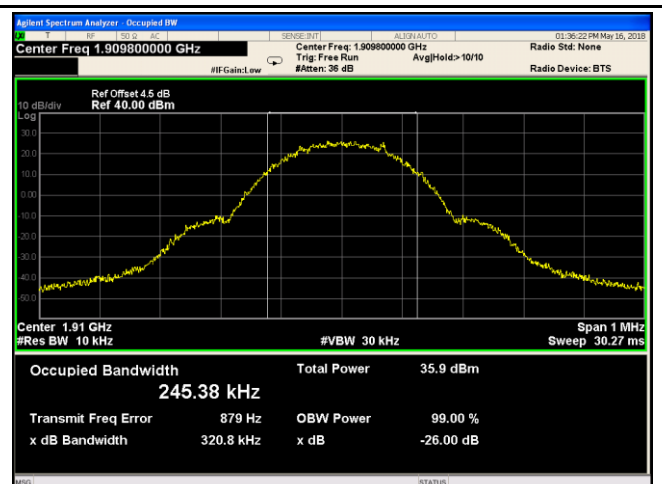

PCS 1900 BW - High CH 1910MHz

GPRS:

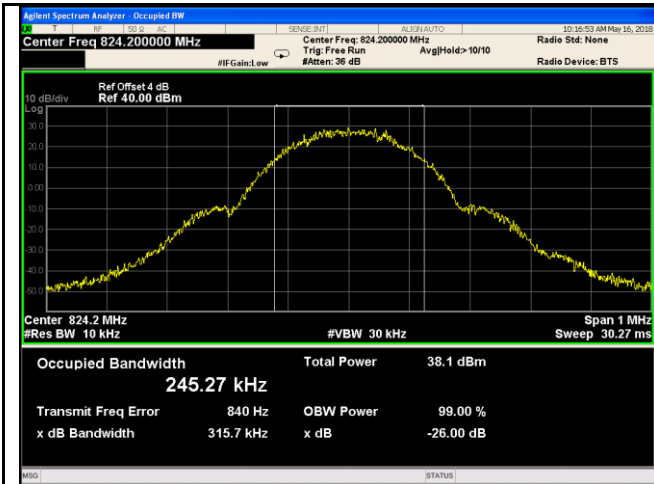

GSM 850 BW - Low CH 824.2MHz

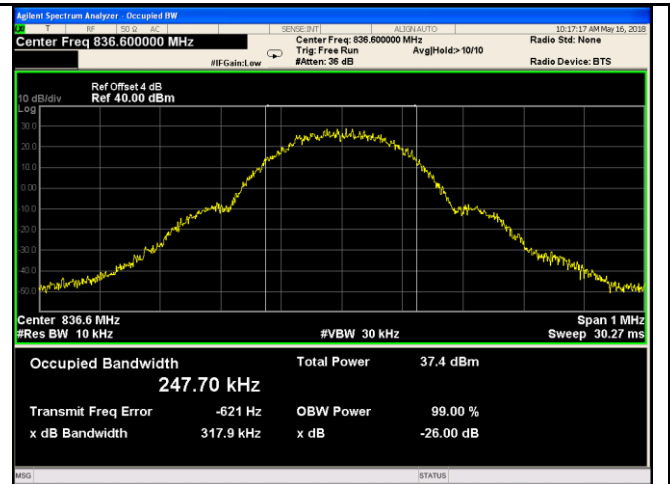

GSM 850 BW - Mid CH 836.6MHz

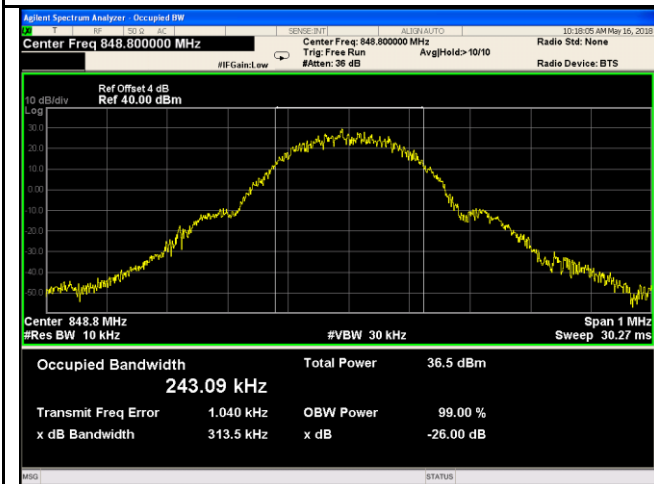

GSM 850 BW - High CH 848.8MHz

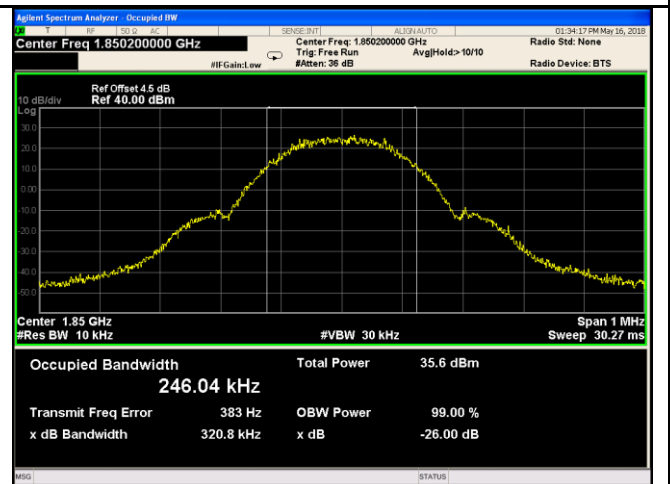

PCS 1900 BW - Low CH 1850MHz

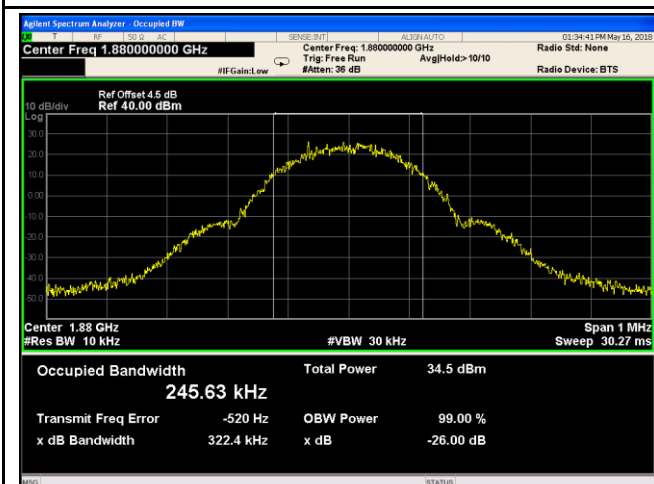

PCS 1900 BW - Mid CH 1880MHz

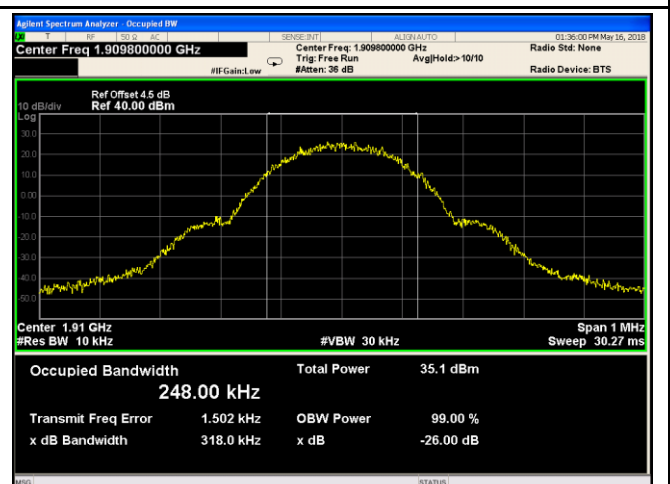

PCS 1900 BW - High CH 1910MHz

EGPRS:

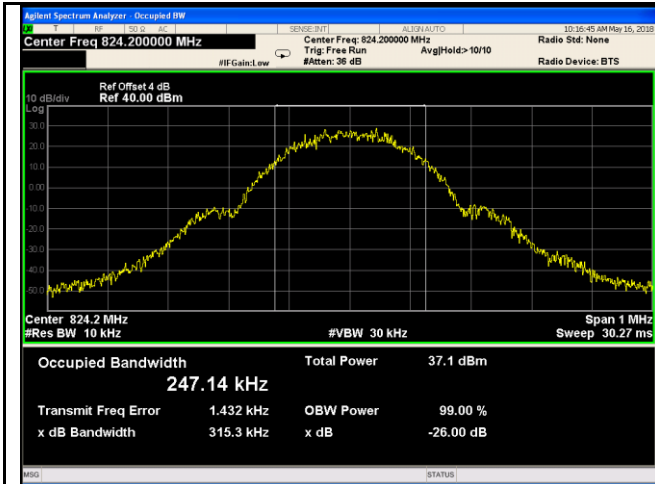

GSM 850 BW - Low CH 824.2MHz

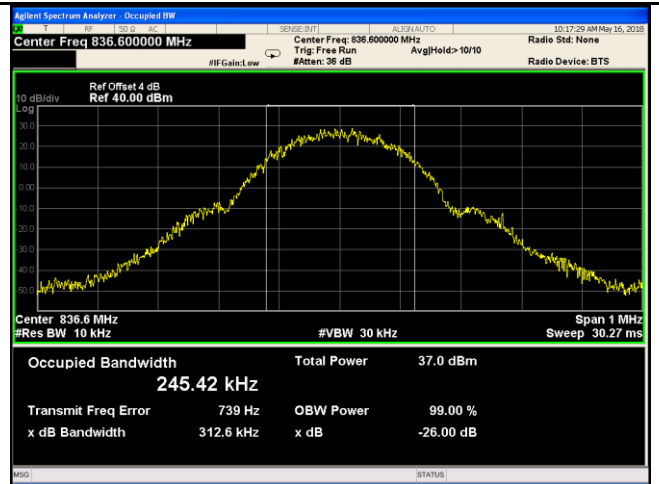

GSM 850 BW - Mid CH 836.6MHz

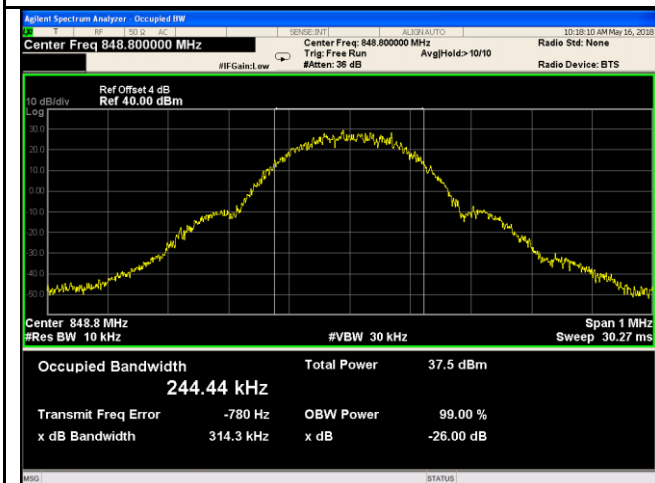

GSM 850 BW - High CH 848.8MHz

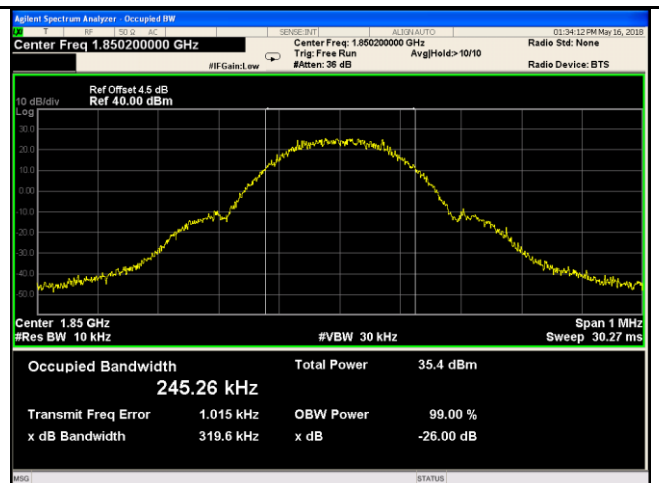

PCS 1900 BW - Low CH 1850.2MHz

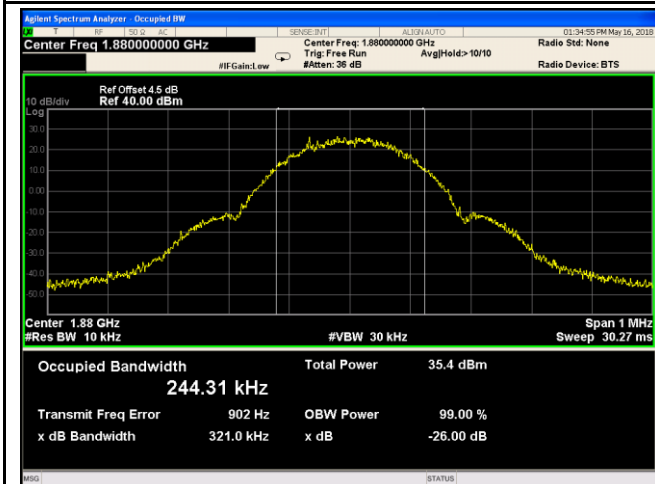

PCS 1900 BW - Mid CH 1880MHz

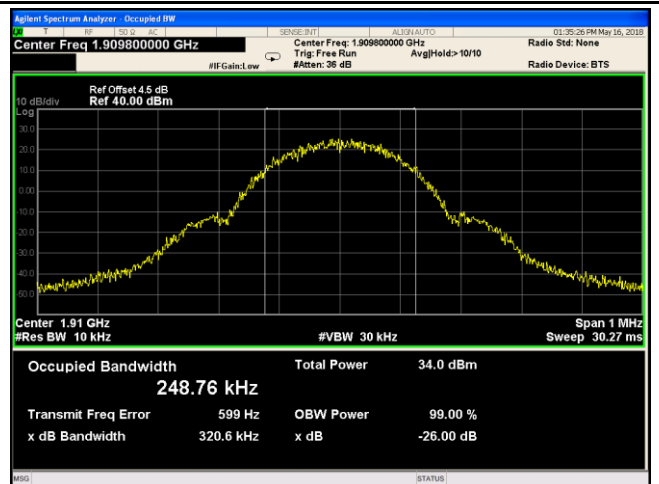

PCS 1900 BW - High CH 1910MHz

RMC:

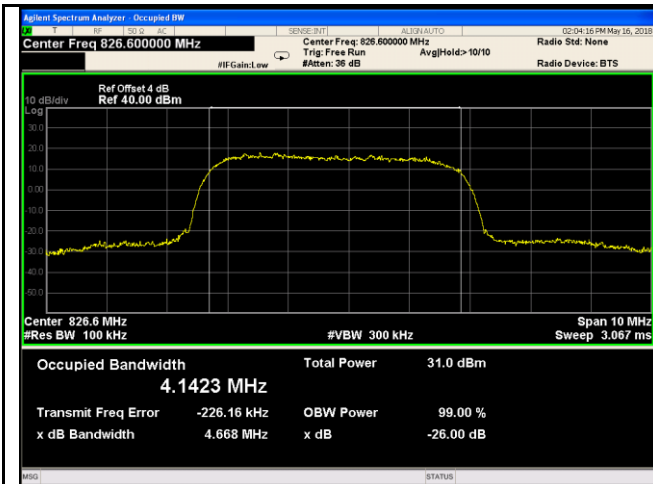

Band V BW - Low CH 826.6 MHz

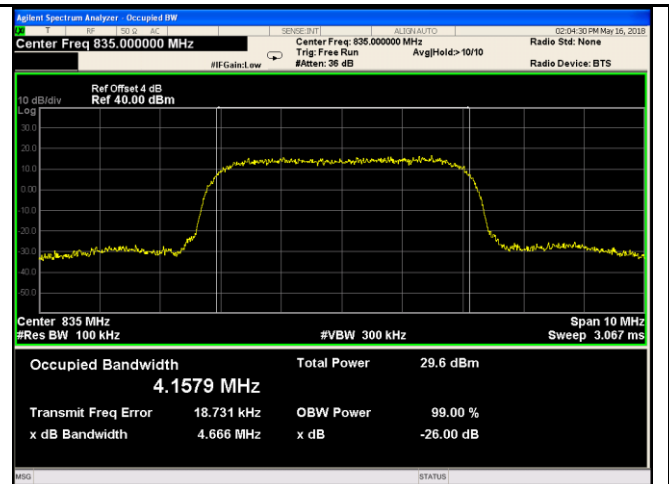

Band V BW - Mid CH 835.0 MHz

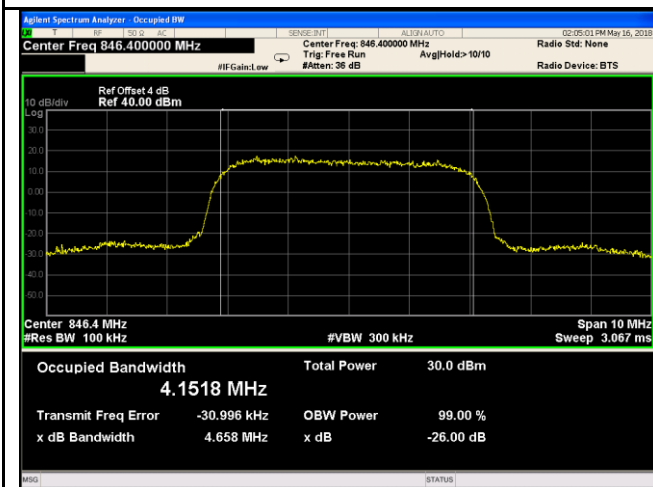

Band V BW - High CH 846.4 MHz

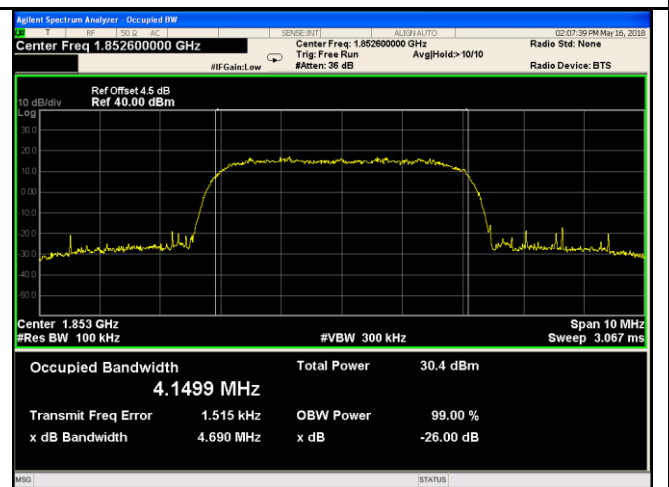

Band II BW - Low CH 1853MHz

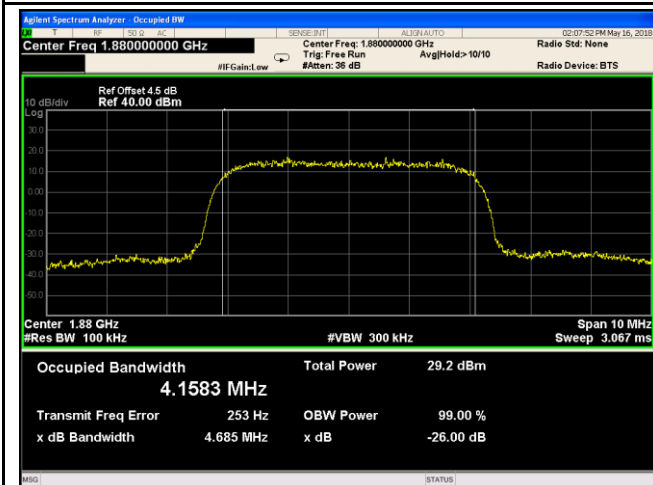

Band II BW - Mid CH 1880MHz

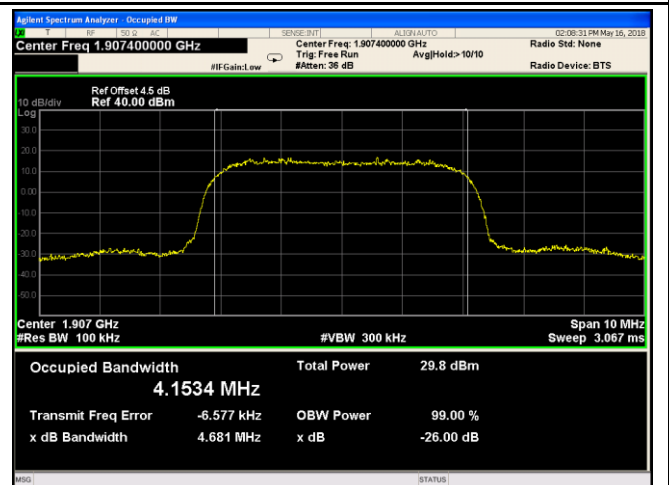

Band II BW - High CH 1907MHz

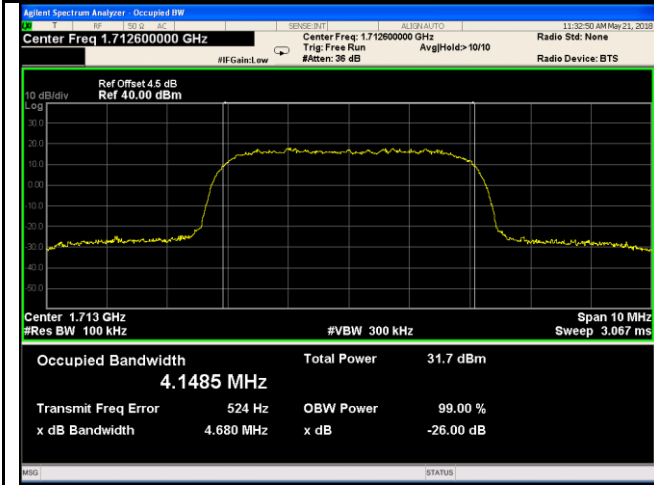

Band IV BW - Low CH 1713MHz

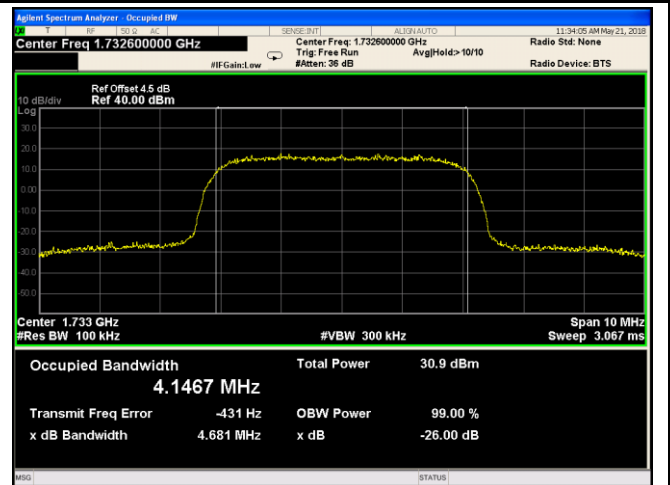

Band IVBW - Mid CH 1733MHz

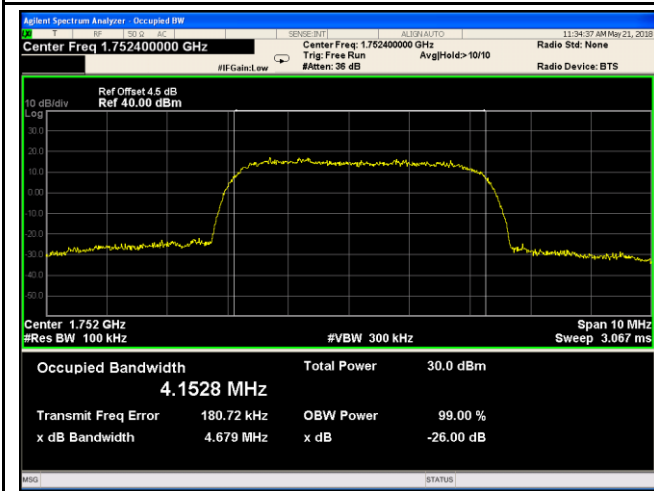

Band IV BW - High CH 1752MHz

HSDPA:

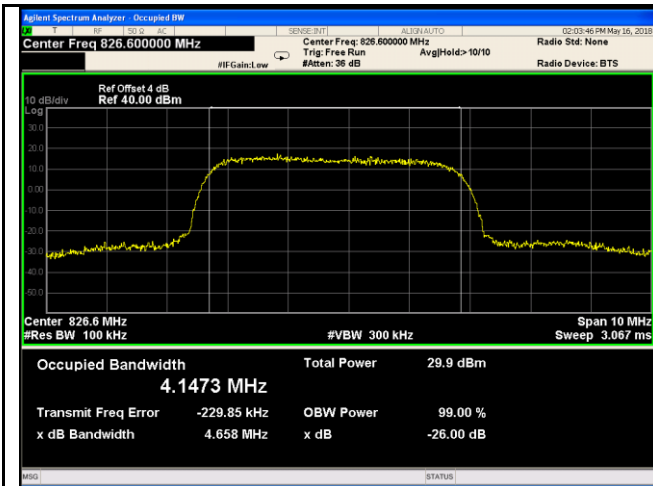

Band V BW - Low CH 826.6 MHz

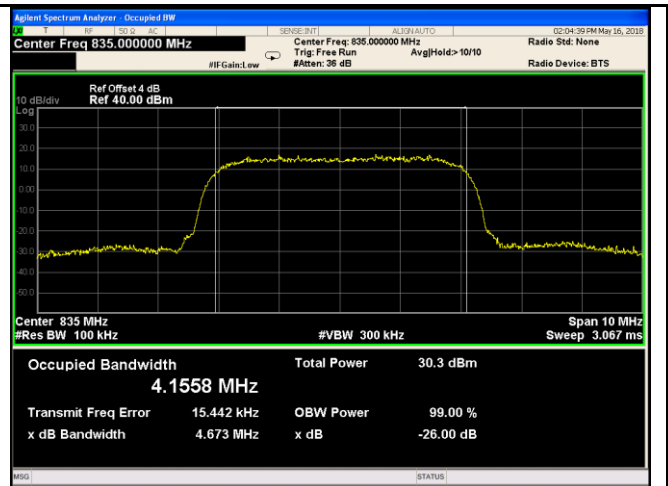

Band V BW - Mid CH 835.0 MHz

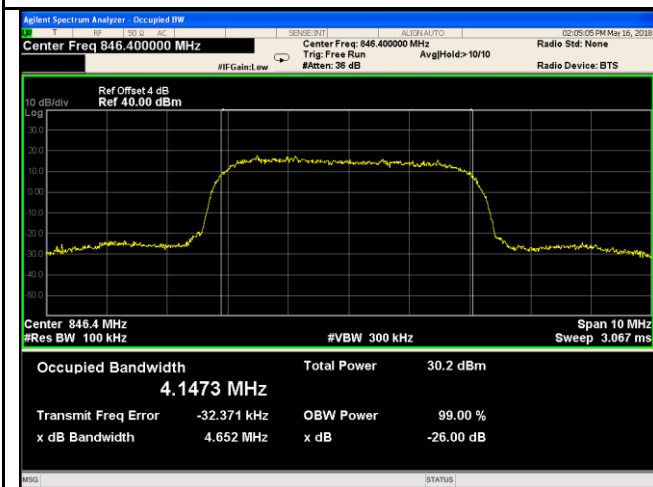

Band V BW - High CH 846.4 MHz

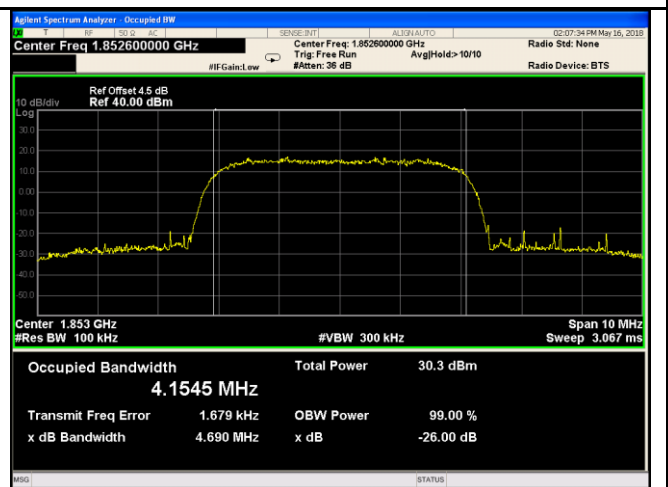

Band II BW - Low CH 1853MHz

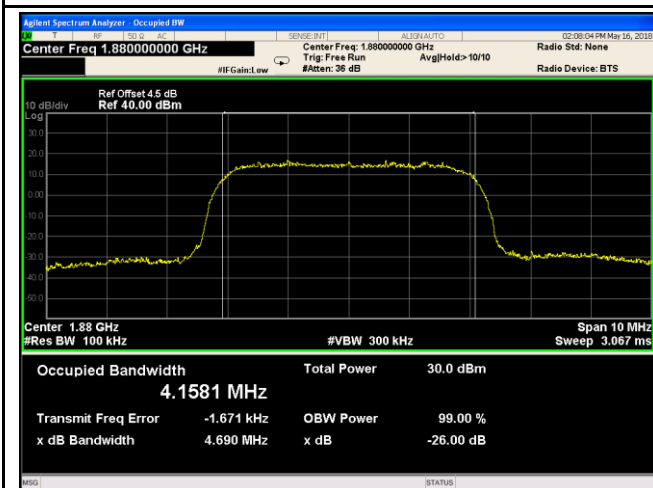

Band II BW - Mid CH 1880MHz

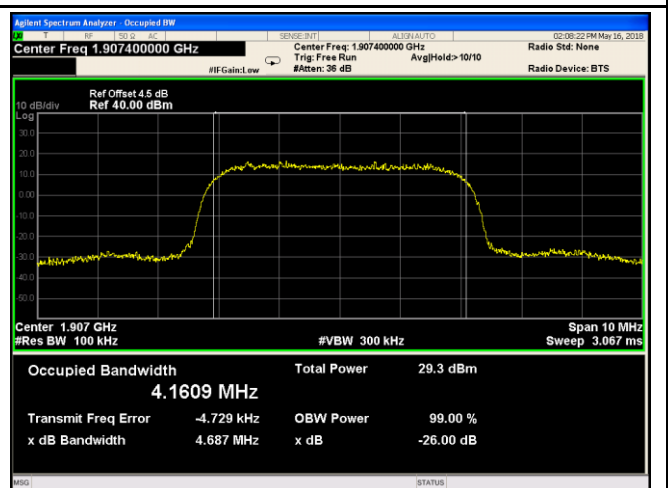

Band II BW - High CH 1907MHz

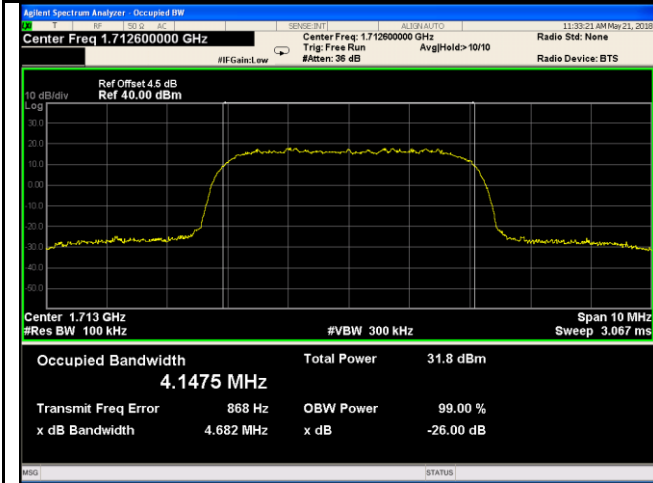

Band IV BW - Low CH 1713MHz

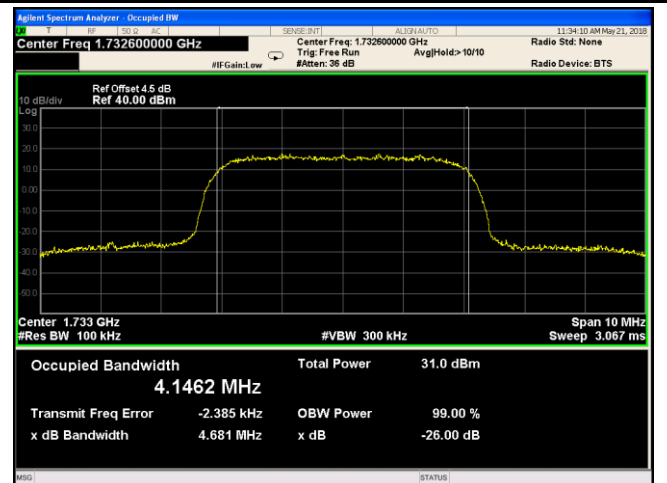

Band IVBW - Mid CH 1733MHz

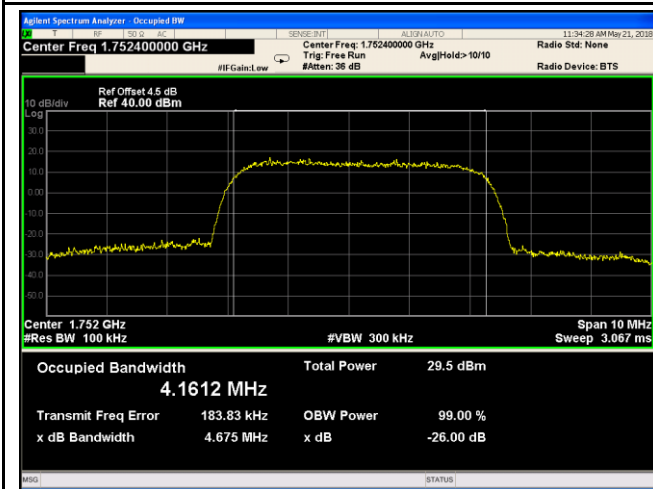

Band IV BW - High CH 1752MHz

HSUPA:

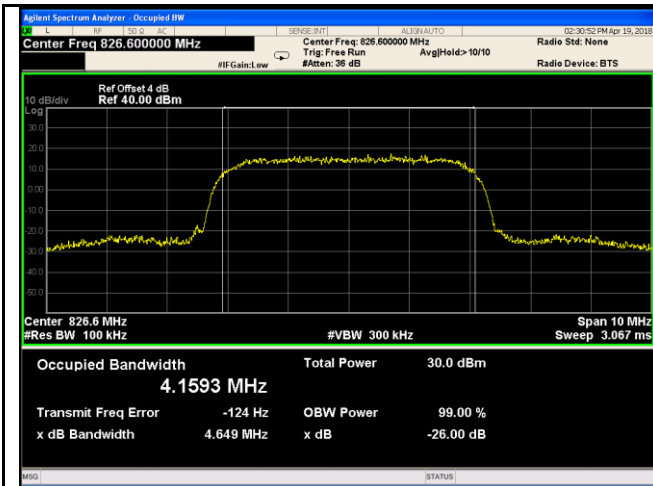

Band V BW - Low CH 826.6 MHz

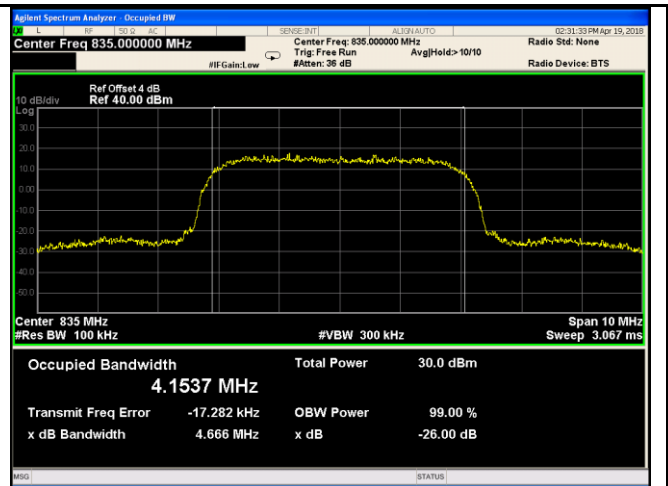

Band V BW - Mid CH 835.0 MHz

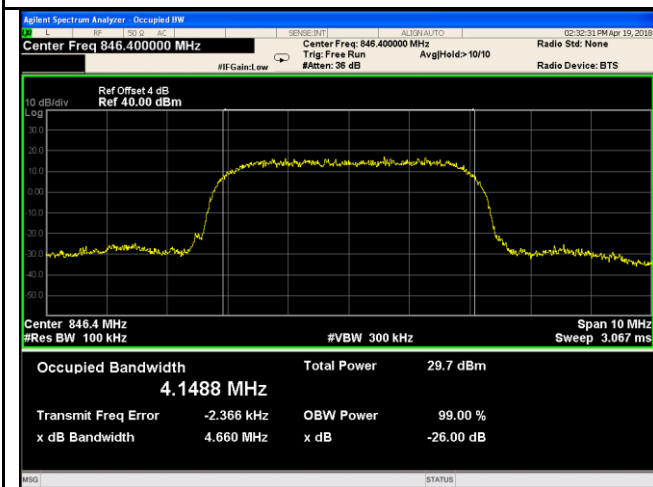

Band V BW - High CH 846.4 MHz

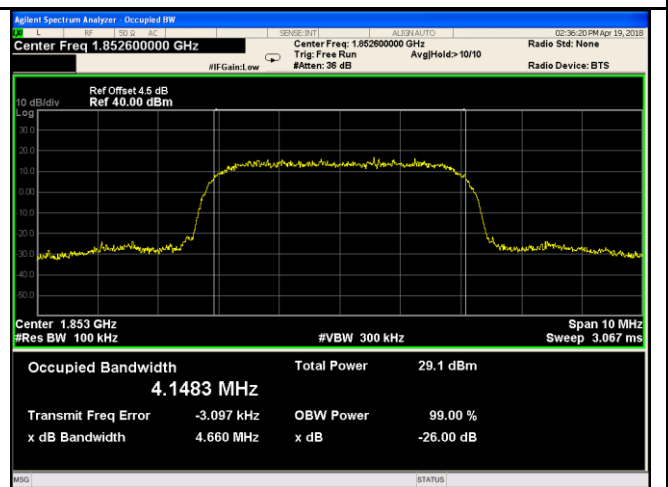

Band II BW - Low CH 1853MHz

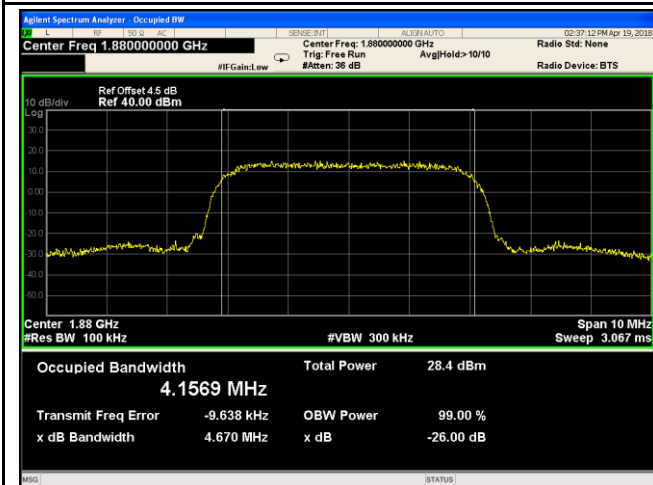

Band II BW - Mid CH 1880MHz

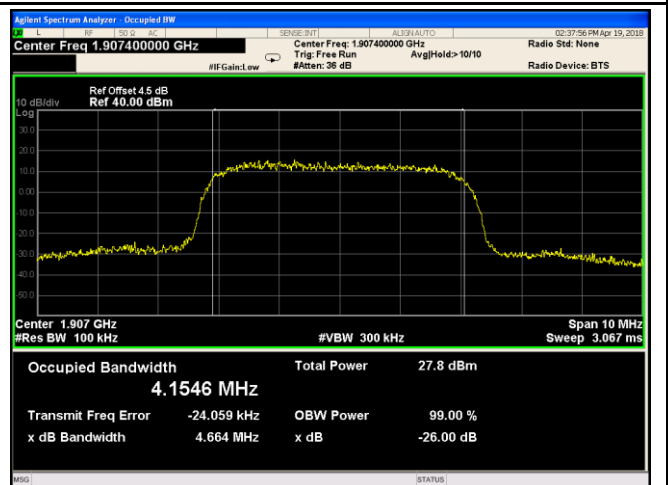

Band II BW - High CH 1907MHz

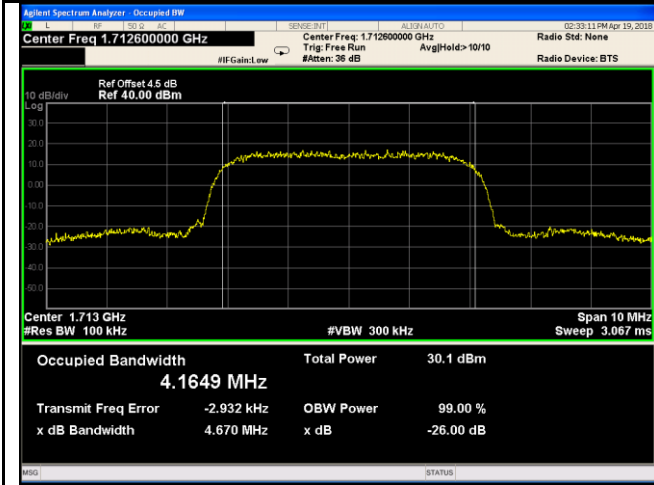

Band IV BW - Low CH 1713MHz

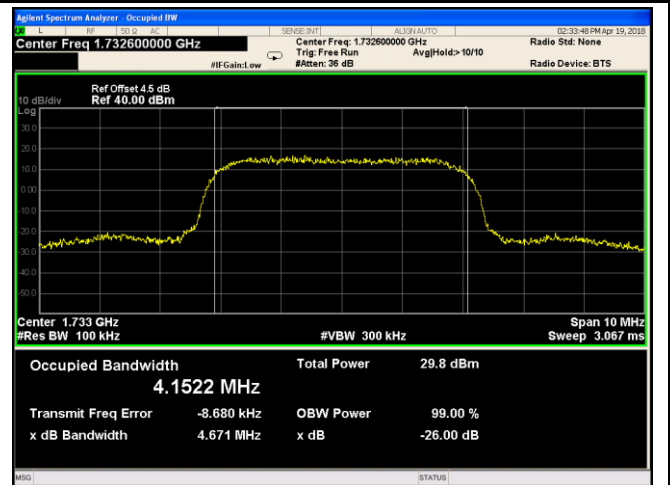

Band IVBW - Mid CH 1733MHz

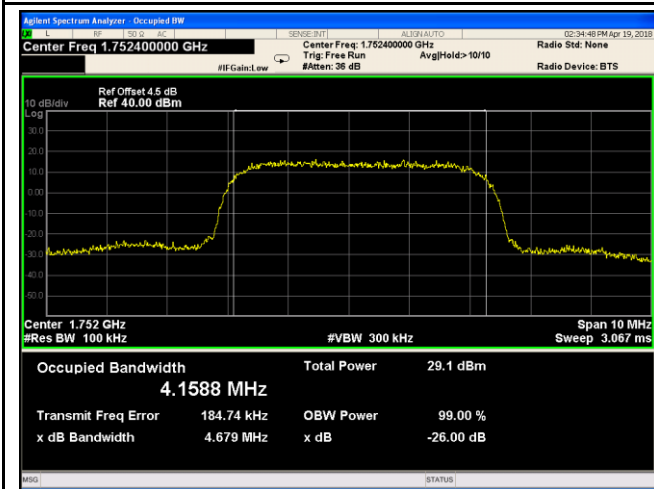

Band IV BW - High CH 1752MHz

6.5 Spurious Emissions at Antenna Terminals

Temperature	25°C
Relative Humidity	58%
Atmospheric Pressure	1016mbar
Test date :	May 16&21, 2018
Tested By :	Aaron Liang

Requirement(s):

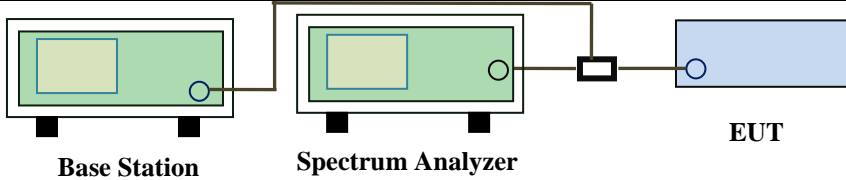
Spec	Item	Requirement	Applicable
§2.1051, §22.917(a)& §24.238(a) § 27.53(h)	a)	The power of any emission outside of the authorized operating frequency ranges must be lower than the transmitter power (P) by a factor of at least $43 + 10 \log(P)$ dB	<input checked="" type="checkbox"/>
Test Setup	 <p style="text-align: center;"> Base Station Spectrum Analyzer EUT </p>		
Test Procedure	<ul style="list-style-type: none"> - The EUT was connected to Spectrum Analyzer and Base Station via power divider. - The Band Edges of low and high channels for the highest RF powers were measured. - Setting RBW as roughly BW/100. 		
Remark			
Result	<input checked="" type="checkbox"/> Pass <input type="checkbox"/> Fail		

Test Data Yes N/A
 Test Plot Yes (See below) N/A

Test Plots

GSM Voice:

Cellular Band (Part 22H) result

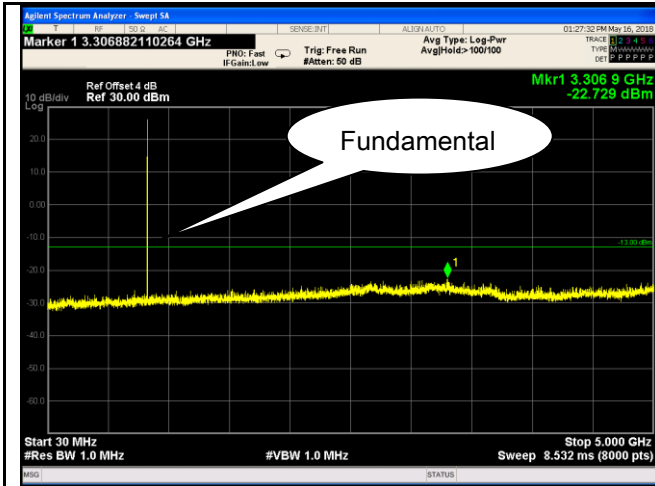

GSM 850 - Low Channel-1

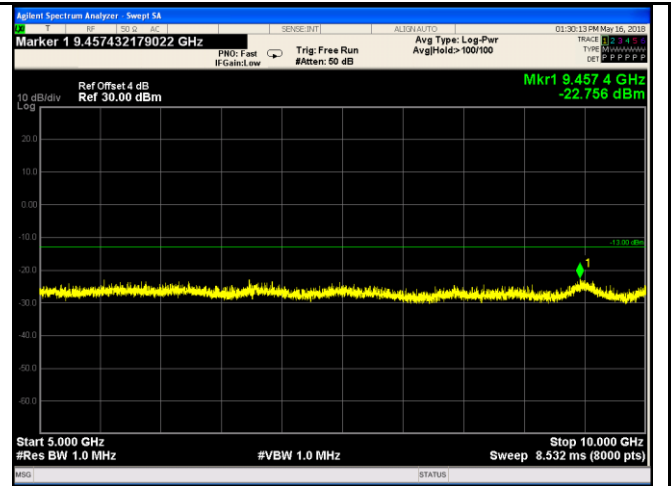

GSM 850 - Low Channel-2

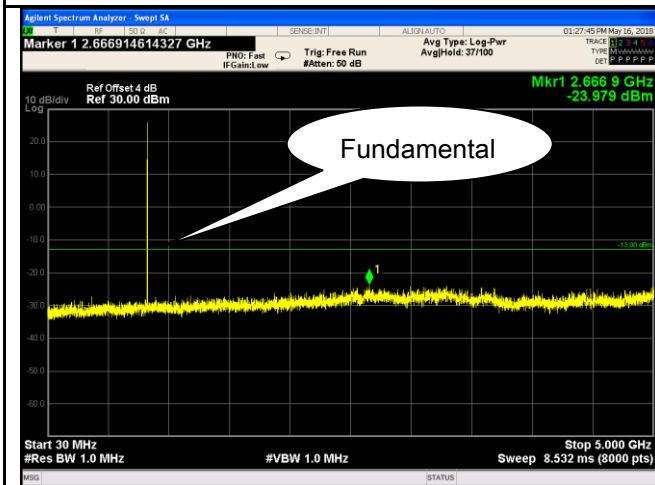

GSM 850 Middle Channel-1

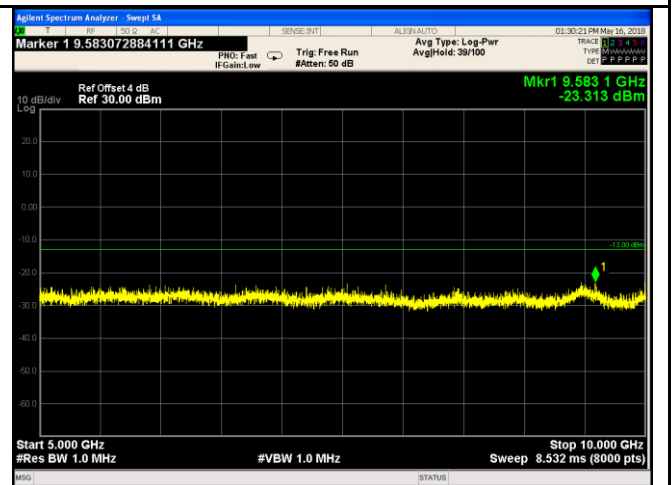

GSM 850 Middle Channel-2

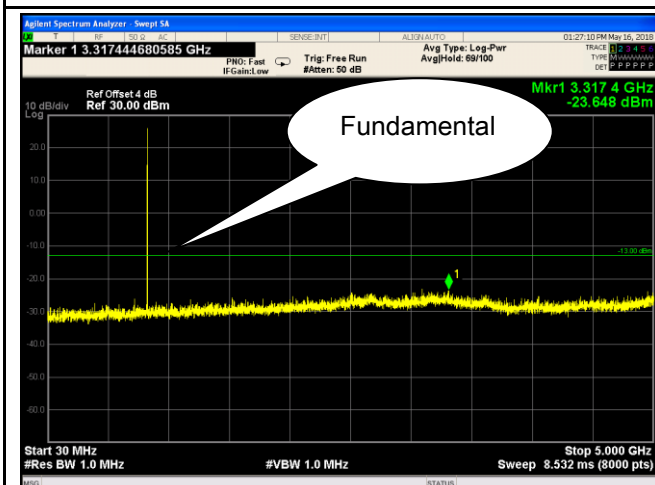

GSM 850 - High Channel-1

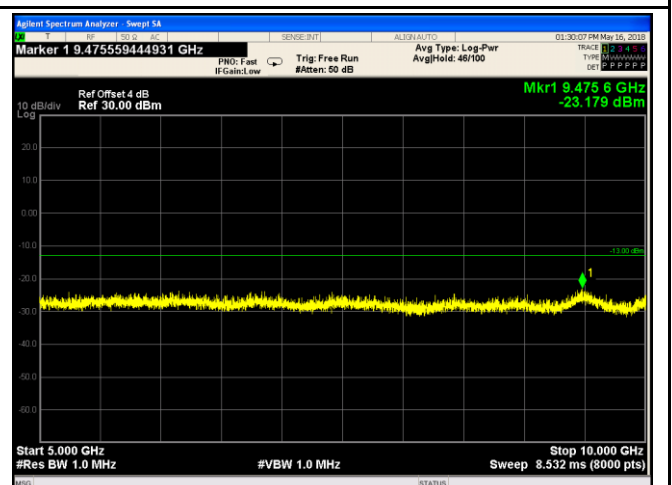

GSM 850 - High Channel-2

PCS Band (Part24E) result

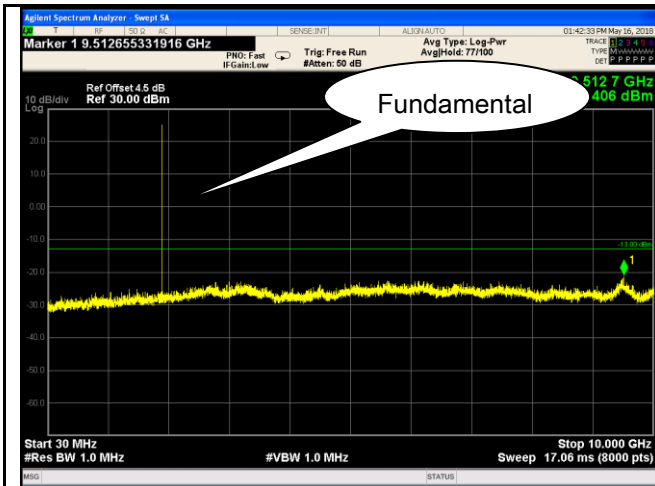

PCS1900 - Low Channel-1

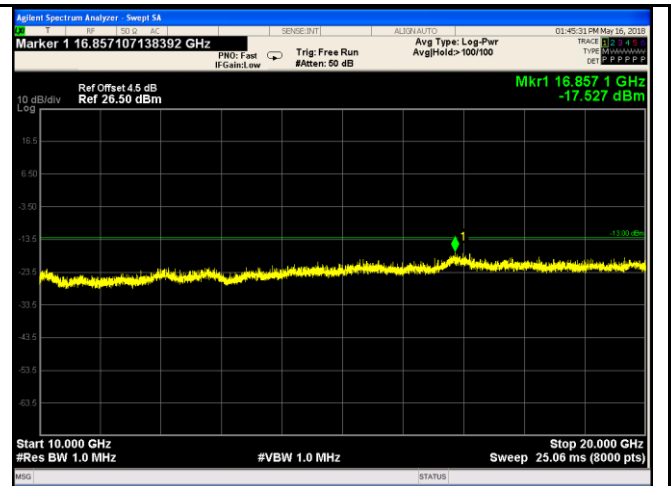

PCS 1900 - Low Channel-2

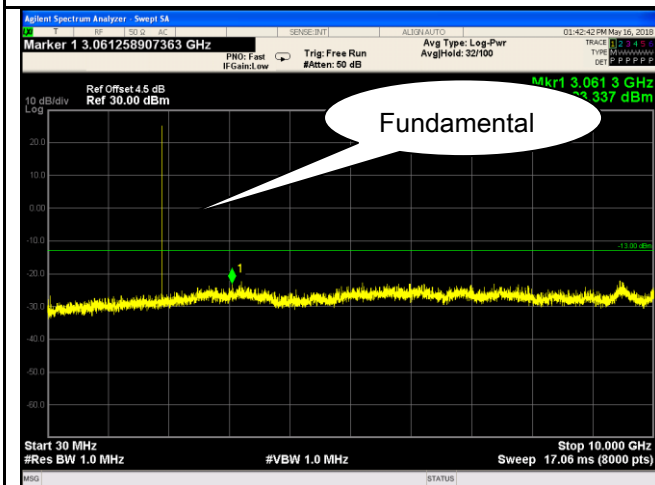

PCS1900 - Middle Channel-1

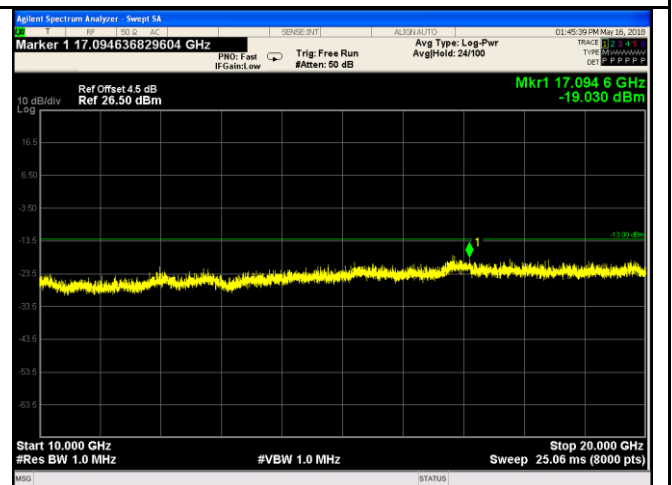

PCS 1900 - Middle Channel-2

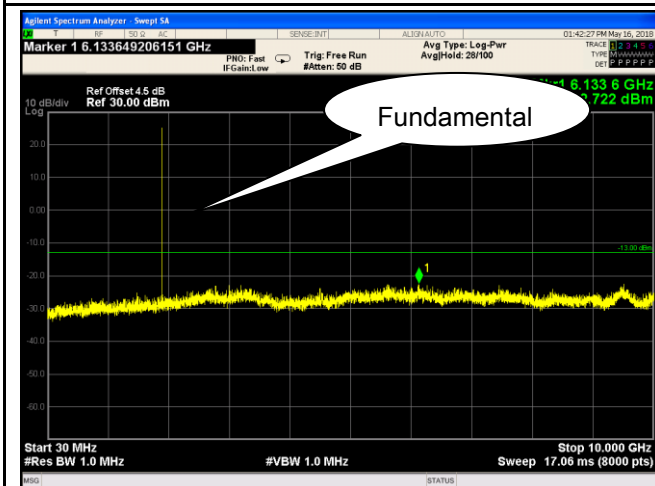

PCS1900 - High Channel-1

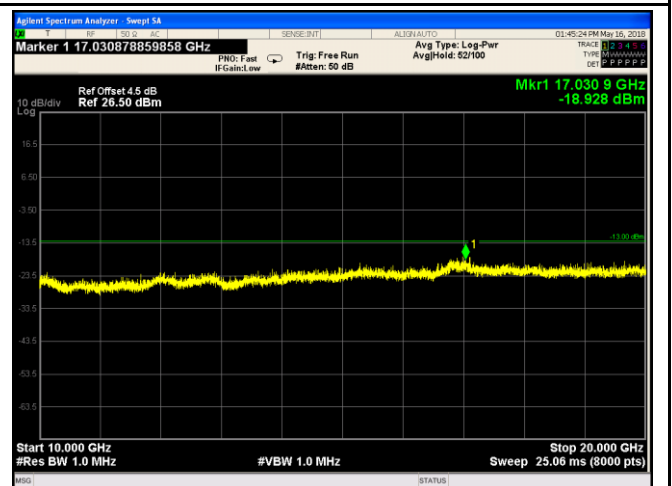

PCS 1900 - High Channel-2

GPRS:

Cellular Band (Part 22H) result

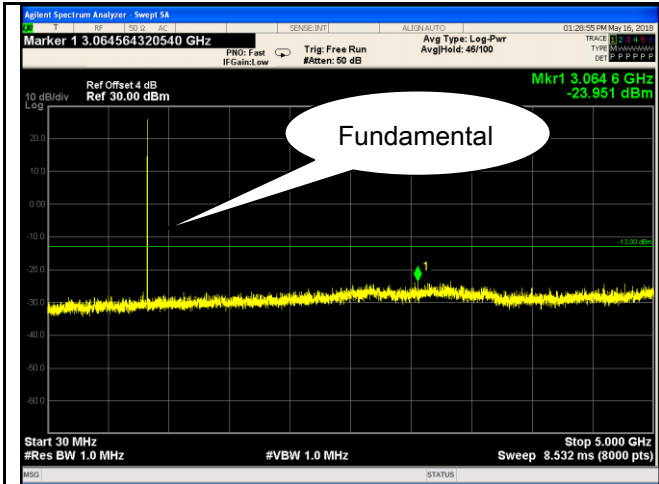

GSM 850 - Low Channel-1

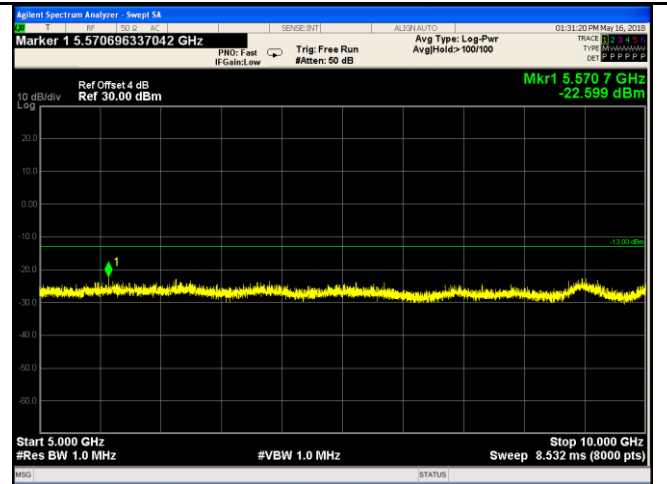

GSM 850 - Low Channel-2

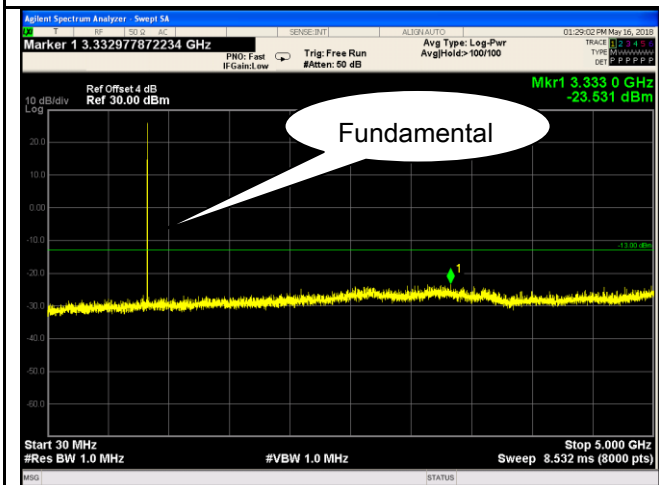

GSM 850 Middle Channel-1

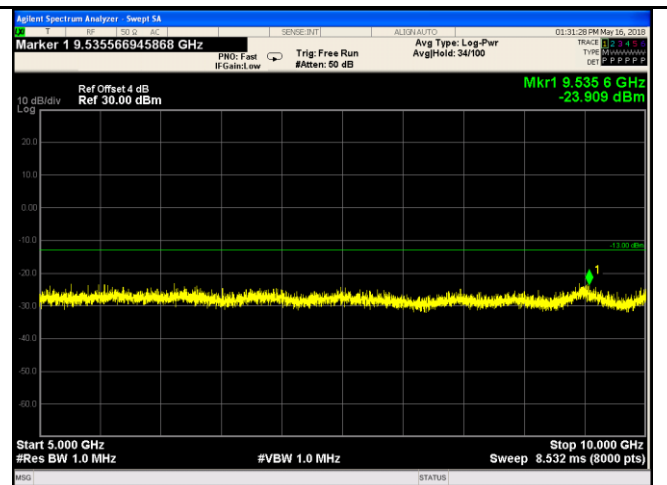

GSM 850 Middle Channel-2

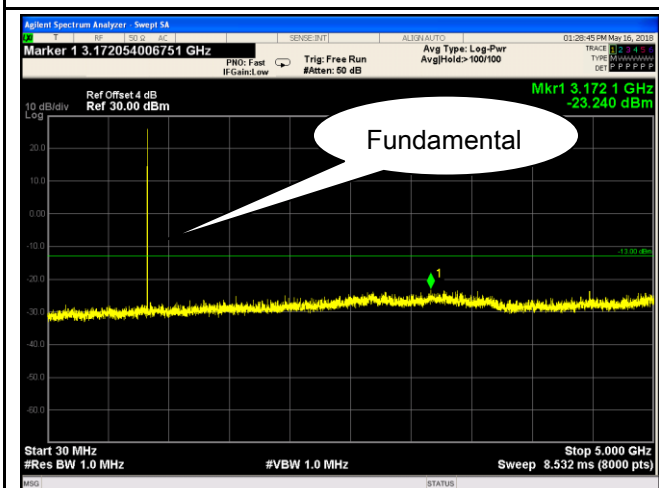

GSM 850 - High Channel-1

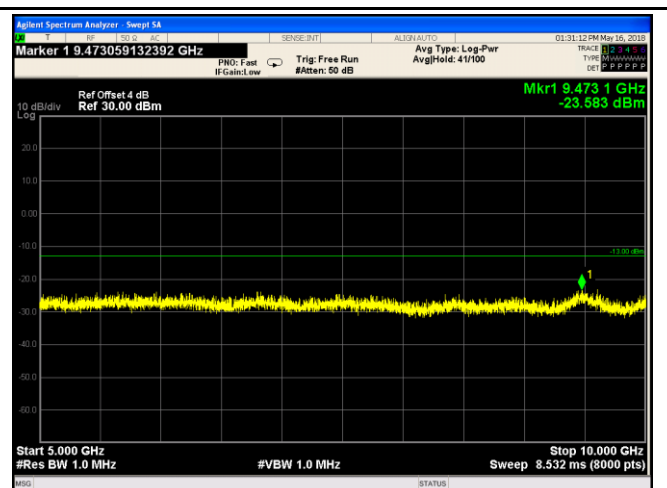

GSM 850 - High Channel-2

PCS Band (Part24E) result

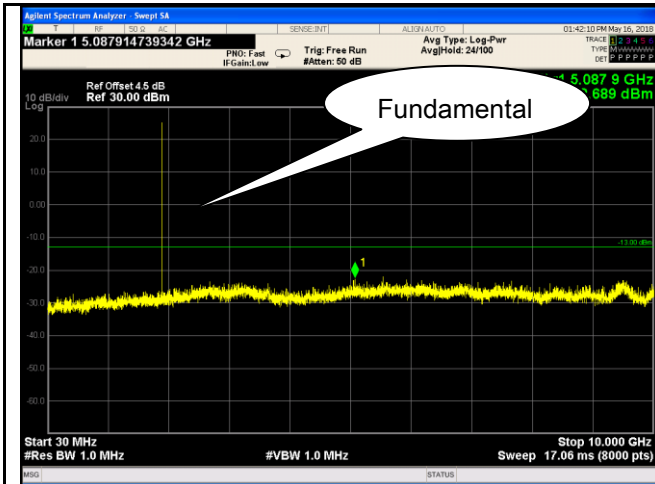

PCS1900 - Low Channel-1

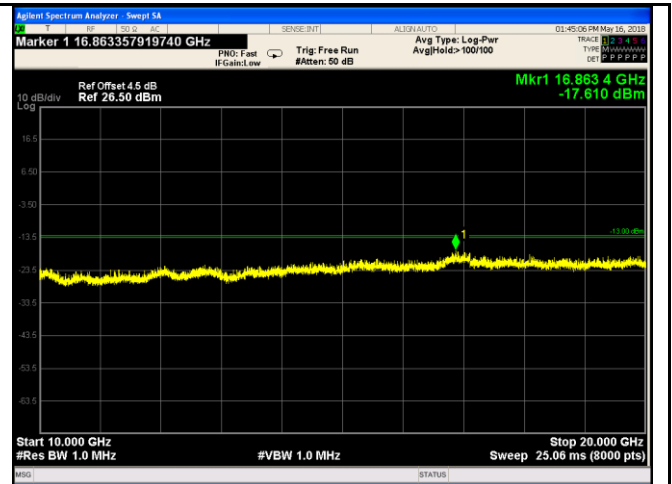

PCS 1900 - Low Channel-2

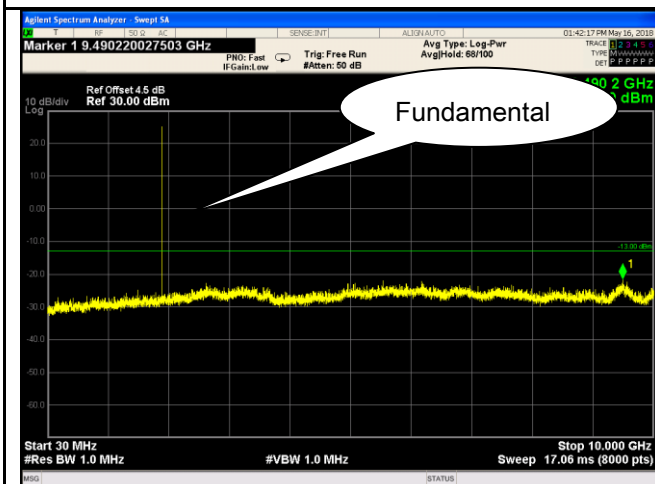

PCS1900 - Middle Channel-1

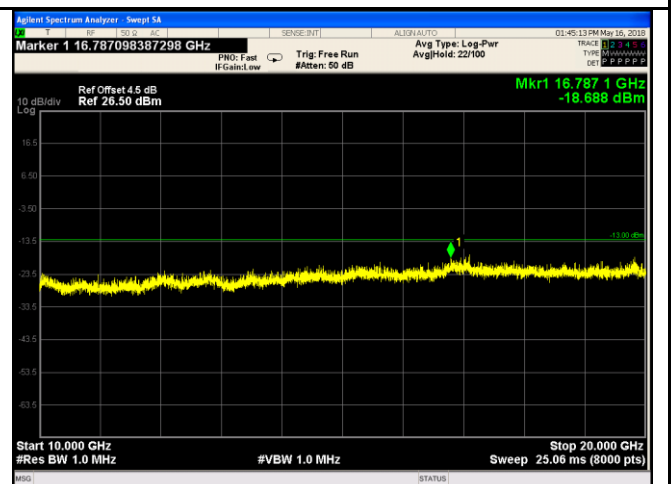

PCS 1900 - Middle Channel-2

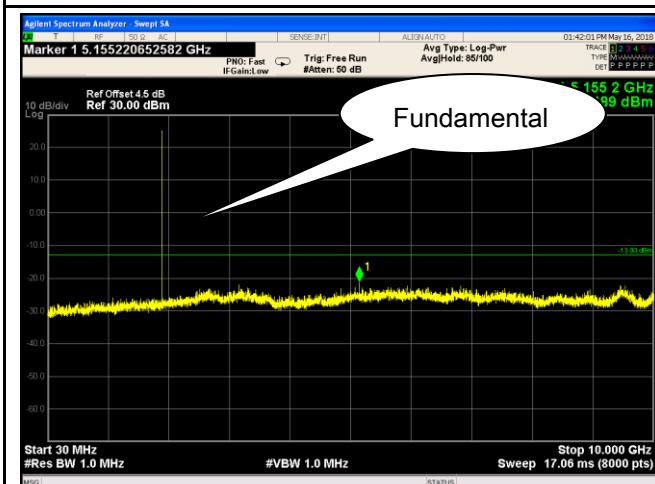

PCS1900 - High Channel-1

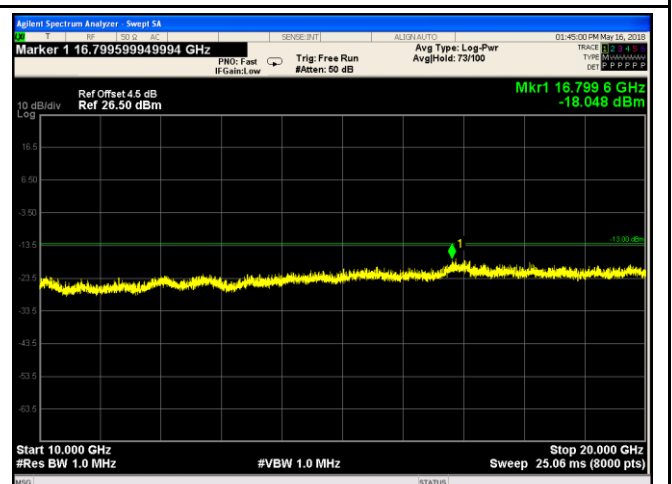

PCS 1900 - High Channel-2

EGPRS (MCS 5):
Cellular Band (Part 22H) result

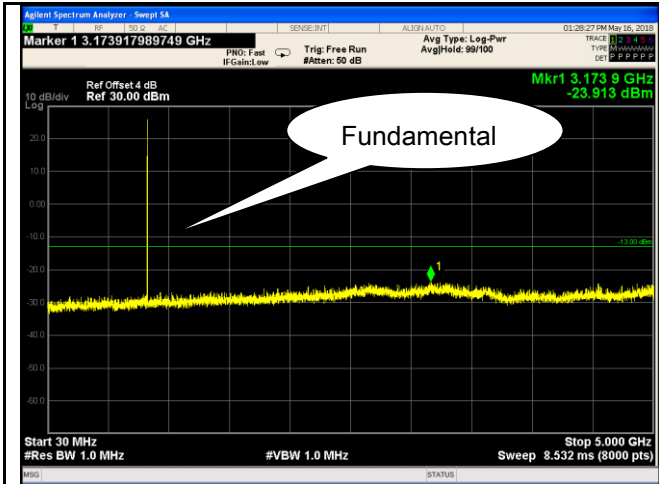

GSM 850 - Low Channel-1

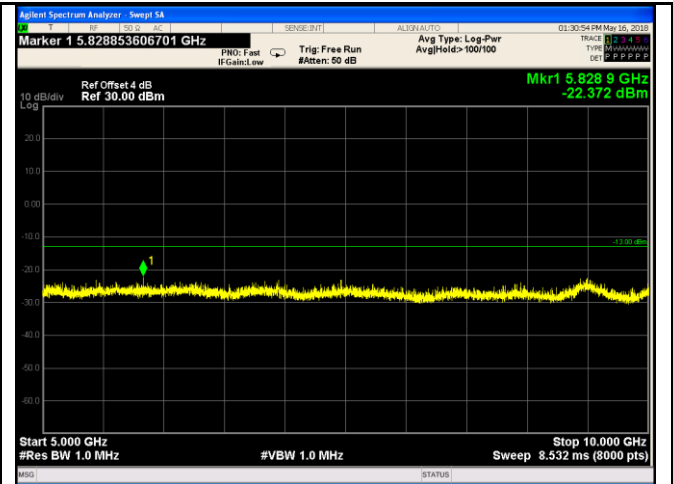

GSM 850 - Low Channel-2

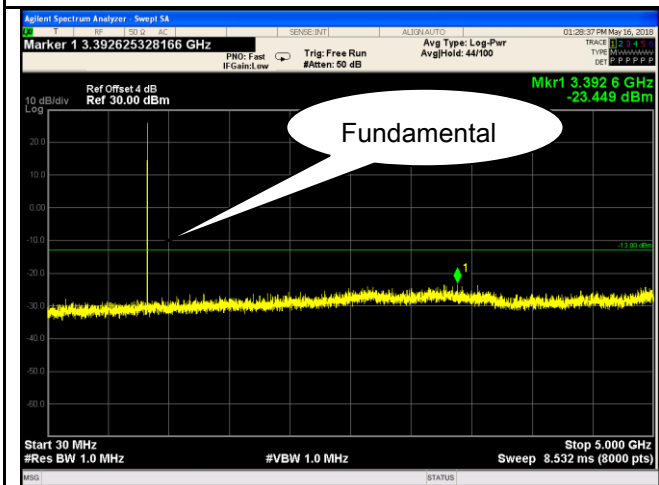

GSM 850 Middle Channel-1

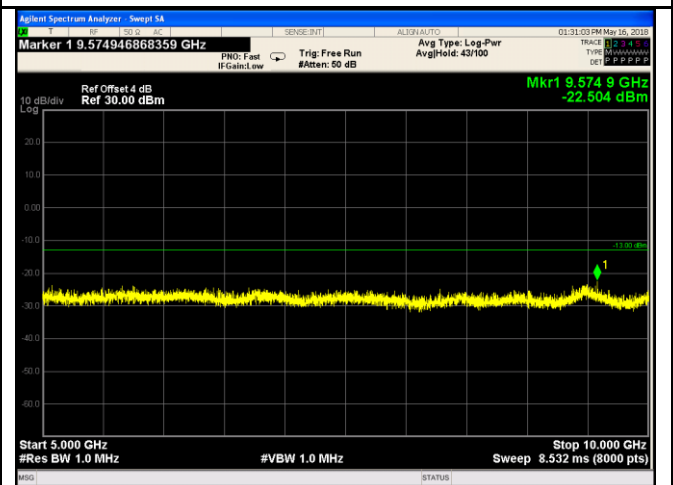

GSM 850 Middle Channel-2

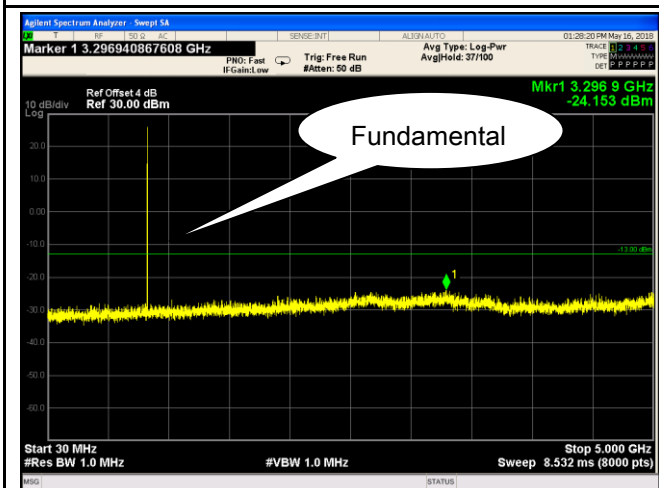

GSM 850 - High Channel-1

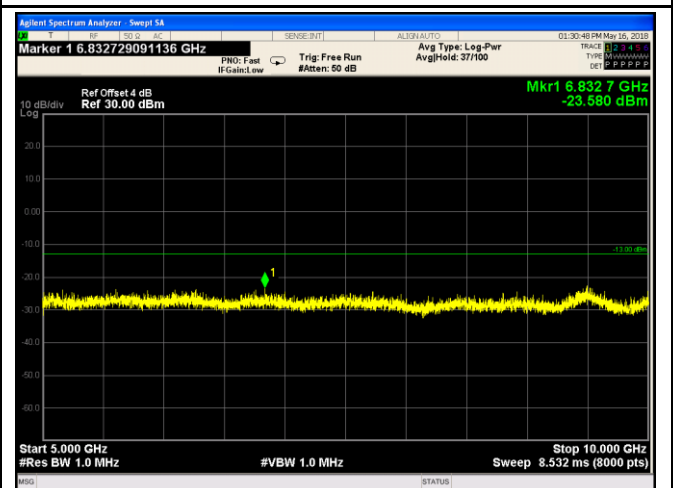

GSM 850 - High Channel-2

PCS Band (Part24E) result

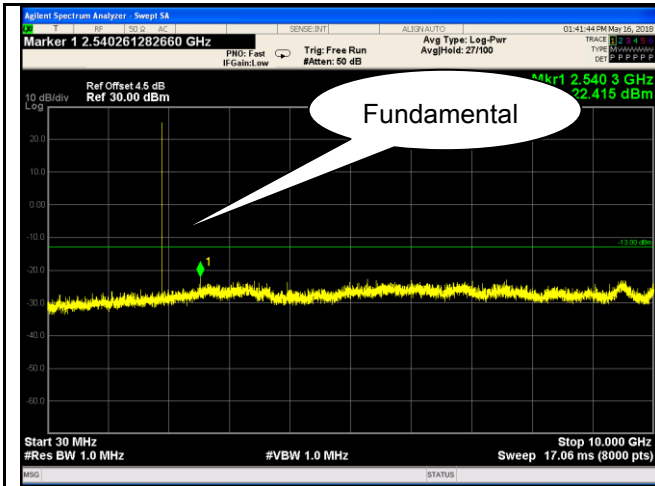

PCS1900 - Low Channel-1

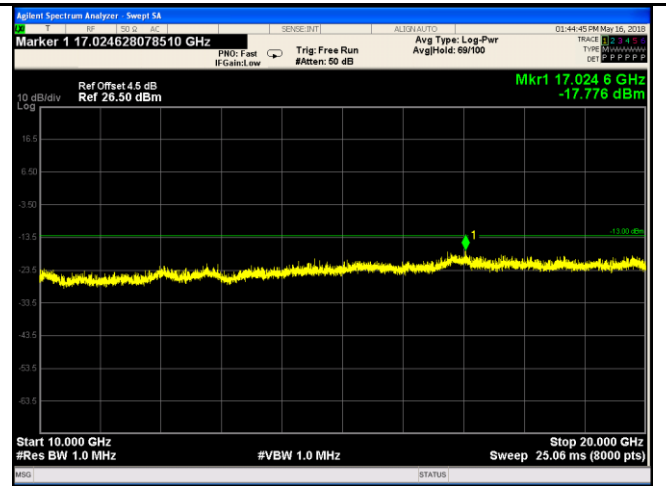

PCS 1900 - Low Channel-2

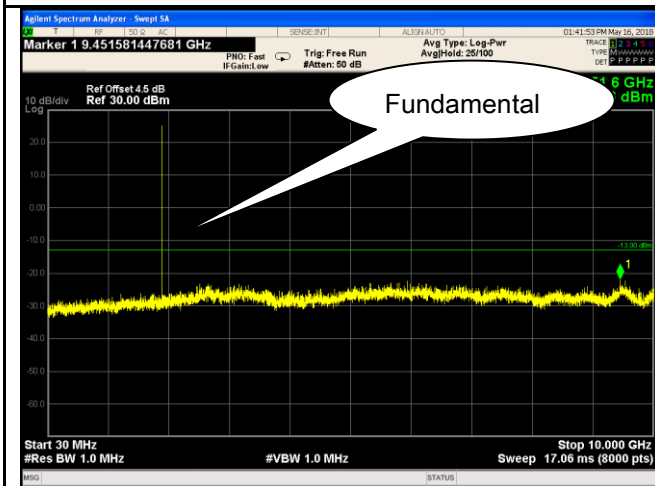

PCS1900 - Middle Channel-1

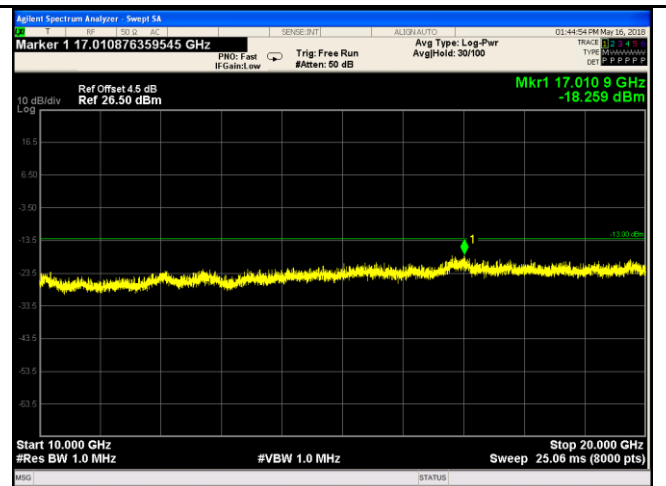

PCS 1900 - Middle Channel-2

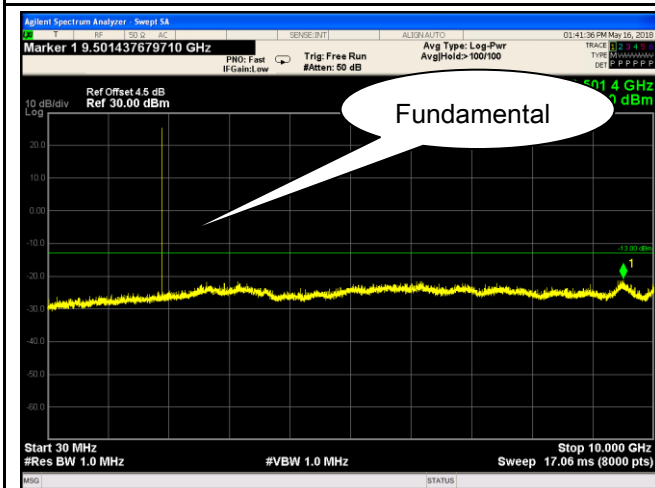

PCS1900 - High Channel-1

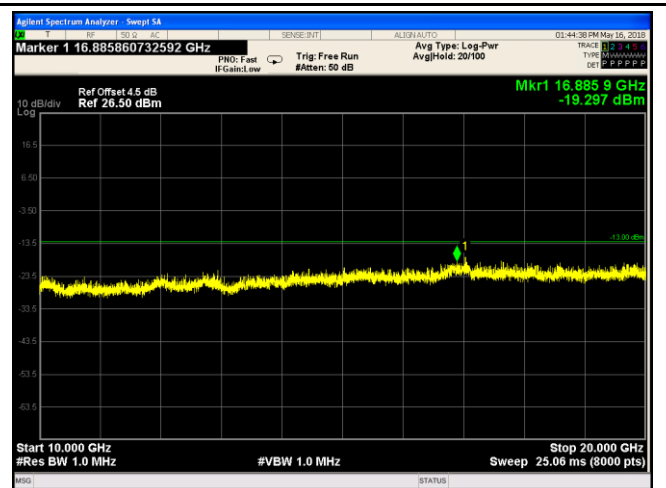

PCS 1900 - High Channel-2