



FCC RF Test Report

APPLICANT : INFINIX MOBILITY LIMITED
EQUIPMENT : Mobile Phone
BRAND NAME : Infinix
MODEL NAME : X604
FCC ID : 2AIZN-X604
STANDARD : 47 CFR Part 2, 24(E), 27(L), 27(M)
CLASSIFICATION : PCS Licensed Transmitter Held to Ear (PCE)

The product was received on Mar. 09, 2018 and completely tested on Apr. 26, 2018. We, Sporton International (Shenzhen) Inc., would like to declare that the tested sample has been evaluated in accordance with the test procedures given in ANSI C63.26-2015 and the testing has shown the tested sample to be in compliance with the applicable technical standards. The test results in this report apply exclusively to the tested model / sample. Without written approval of Sporton International (Shenzhen) Inc., the test report shall not be reproduced except in full.



Approved by: Eric Shih / Manager

Sporton International (Shenzhen) Inc.

**1/F, 2/F, Bldg 5, Shiling Industrial Zone, Xinwei Village, Xili, Nanshan Shenzhen City
Guangdong Province 518055 China**



TABLE OF CONTENTS

REVISION HISTORY... 3
SUMMARY OF TEST RESULT ... 4
1 GENERAL DESCRIPTION ... 5
1.1 Applicant ... 5
1.2 Manufacturer ... 5
1.3 Product Feature of Equipment Under Test ... 5
1.4 Product Specification of Equipment Under Test ... 6
1.5 Modification of EUT ... 6
1.6 Maximum ERP/EIRP Power, Frequency Tolerance, and Emission Designator ... 7
1.7 Testing Location ... 8
1.8 Applicable Standards ... 8
2 TEST CONFIGURATION OF EQUIPMENT UNDER TEST ... 9
2.1 Test Mode ... 9
2.2 Connection Diagram of Test System ... 10
2.3 Support Unit used in test configuration and system ... 11
2.4 Measurement Results Explanation Example ... 11
2.5 Frequency List of Low/Middle/High Channels ... 12
3 CONDUCTED TEST ITEMS ... 14
3.1 Measuring Instruments ... 14
3.2 Test Setup ... 14
3.3 Test Result of Conducted Test ... 14
3.4 Conducted Output Power and ERP/EIRP ... 15
3.5 Peak-to-Average Ratio ... 16
3.6 Occupied Bandwidth ... 17
3.7 Conducted Band Edge ... 18
3.8 Conducted Spurious Emission ... 20
3.9 Frequency Stability ... 21
4 RADIATED TEST ITEMS ... 22
4.1 Measuring Instruments ... 22
4.2 Test Setup ... 22
4.3 Test Result of Radiated Test ... 22
4.4 Radiated Spurious Emission ... 23
5 LIST OF MEASURING EQUIPMENT ... 24
6 UNCERTAINTY OF EVALUATION ... 25
APPENDIX A. TEST RESULTS OF CONDUCTED TEST
APPENDIX B. TEST RESULTS OF RADIATED TEST
APPENDIX C. TEST SETUP PHOTOGRAPHS



REVISION HISTORY

REPORT NO.	VERSION	DESCRIPTION	ISSUED DATE
FG830917B	Rev. 01	Initial issue of report	May 04, 2018



SUMMARY OF TEST RESULT

Report Section	FCC Rule	Description	Limit	Result	Remark
3.4	§2.1046	Conducted Output Power	Reporting Only	PASS	-
	§24.232(c) §27.50(h)(2)	Equivalent Isotropic Radiated Power (Band 2) (Band 7)	EIRP < 2Watt	PASS	-
	§27.50(d)(4)	Equivalent Isotropic Radiated Power (Band 4)	EIRP < 1Watt	PASS	-
3.5	§24.232(d)	Peak-to-Average Ratio	<13 dB	PASS	-
3.6	§2.1049	Occupied Bandwidth	Reporting Only	PASS	-
3.7	§2.1051 §24.238(a) §27.53(h)	Conducted Band Edge Measurement (Band 2) (Band 4)	< 43+10log ₁₀ (P[Watts])	PASS	-
	§27.53(m)(4)	Conducted Band Edge Measurement (Band 7)	§27.53(m)(4)		
3.8	§2.1051 §24.238(a) §27.53(h)	Conducted Spurious Emission (Band 2) (Band 4)	< 43+10log ₁₀ (P[Watts])	PASS	-
	§2.1051 §27.53(m)(4)	Conducted Spurious Emission (Band 7)	< 55+10log ₁₀ (P[Watts])		
3.9	§2.1055 §22.355	Frequency Stability Temperature & Voltage	< 2.5 ppm for Part 22H	PASS	-
	§2.1055 §24.235 §27.54		Within Authorized Band		
4.4	§2.1053 §24.238(a) §27.53(h)	Radiated Spurious Emission (Band 2) (Band 4)	< 43+10log ₁₀ (P[Watts])	PASS	Under limit 20.43 dB at 3758.740 MHz
	§2.1053 §27.53(m)(4)	Radiated Spurious Emission (Band 7)	< 55+10log ₁₀ (P[Watts])		



1 General Description

1.1 Applicant

INFINIX MOBILITY LIMITED

RMS 05-15, 13A/F SOUTH TOWER WORLD FINANCE CTR HARBOUR CITY 17 CANTON RD TST
KLN HONG KONG

1.2 Manufacturer

SHENZHEN TECNO TECHNOLOGY CO.,LTD.

1/-4/TH FLOOR,7TH FLOOR, 3RD BUILDING, PACIFIC INDUSTRIAL PARK, NO.2088, SHENYAN
ROAD, YANTIAN DISTRICT, SHENZHEN, GUANGDONG, CHINA

1.3 Product Feature of Equipment Under Test

Product Feature	
Equipment	Mobile Phone
Brand Name	Infinix
Model Name	X604
FCC ID	2AIZN-X604
EUT supports Radios application	GSM/GPRS/EGPRS/WCDMA/HSPA/DC-HSDPA/ HSPA+(16QAM uplink is not supported)/LTE WLAN 2.4GHz 802.11b/g/n HT20/HT40 Bluetooth v3.0+EDR/ Bluetooth v4.0 LE/ Bluetooth v4.1 LE/ Bluetooth v4.2 LE
IMEI Code	Conducted: 355784090024720/355784090024738 Radiation: 355784090025883/355784090025891
HW Version	V1.4
SW Version	X604-H633HIJ-O-PR2-20180124V1
EUT Stage	Identical Prototype



1.4 Product Specification of Equipment Under Test

Standards-related Product Specification	
Tx Frequency	LTE Band 2 : 1850.7 MHz ~ 1909.3 MHz LTE Band 4 : 1710.7 MHz ~ 1754.3 MHz LTE Band 7 : 2502.5 MHz ~ 2567.5 MHz
Rx Frequency	LTE Band 2 : 1930.7 MHz ~ 1989.3 MHz LTE Band 4 : 2110.7 MHz ~ 2154.3 MHz LTE Band 7 : 2622.5MHz ~ 2687.5 MHz
Bandwidth	LTE Band 2 : 1.4MHz / 3MHz / 5MHz / 10MHz / 15MHz / 20MHz LTE Band 4 : 1.4MHz / 3MHz / 5MHz / 10MHz / 15MHz / 20MHz LTE Band 7 : 5MHz/ 10MHz / 15MHz / 20MHz
Maximum Output Power to Antenna	LTE Band 2 : 22.77 dBm LTE Band 4 : 22.67 dBm LTE Band 7 : 23.32 dBm
Antenna Gain	LTE Band 2 : -1.88 dBi LTE Band 4 : -1.15 dBi LTE Band 7 : -2.33 dBi
Type of Modulation	QPSK / 16QAM

1.5 Modification of EUT

No modifications are made to the EUT during all test items.



1.6 Maximum ERP/EIRP Power, Frequency Tolerance, and Emission Designator

LTE Band 2		QPSK			16QAM		
BW (MHz)	Frequency Range (MHz)	Emission Designator (99%OBW)	Frequency Tolerance (ppm)	Maximum EIRP(W)	Emission Designator (99%OBW)	Frequency Tolerance (ppm)	Maximum EIRP(W)
1.4	1850.7 ~ 1909.3	1M09G7D	-	0.1225	1M09W7D	-	0.1079
3	1851.5 ~ 1908.5	2M72G7D	-	0.1225	2M71W7D	-	0.1086
5	1852.5 ~ 1907.5	4M54G7D	-	0.1197	4M53W7D	-	0.1151
10	1855.0 ~ 1905.0	9M07G7D	0.0133	0.1222	9M05W7D	-	0.1096
15	1857.5 ~ 1902.5	13M5G7D	-	0.1225	13M5W7D	-	0.1094
20	1860.0 ~ 1900.0	18M5G7D	-	0.1227	18M4W7D	-	0.1062
LTE Band 4		QPSK			16QAM		
BW (MHz)	Frequency Range (MHz)	Emission Designator (99%OBW)	Frequency Tolerance (ppm)	Maximum EIRP(W)	Emission Designator (99%OBW)	Frequency Tolerance (ppm)	Maximum EIRP(W)
1.4	1710.7 ~ 1754.3	1M09G7D	-	0.1409	1M09W7D	-	0.1279
3	1711.5 ~ 1753.5	2M71G7D	-	0.1396	2M70W7D	-	0.1271
5	1712.5 ~ 1752.5	4M54G7D	-	0.1400	4M50W7D	-	0.1256
10	1715.0 ~ 1750.0	9M09G7D	0.0121	0.1413	9M03W7D	-	0.1262
15	1717.5 ~ 1747.5	13M5G7D	-	0.1416	13M5W7D	-	0.1225
20	1720.0 ~ 1745.0	18M5G7D	-	0.1419	18M5W7D	-	0.1271
LTE Band 7		QPSK			16QAM		
BW (MHz)	Frequency Range (MHz)	Emission Designator (99%OBW)	Frequency Tolerance (ppm)	Maximum EIRP(W)	Emission Designator (99%OBW)	Frequency Tolerance (ppm)	Maximum EIRP(W)
5	2502.5 ~ 2567.5	4M50G7D	-	0.1247	4M52W7D	-	0.1104
10	2505.0 ~ 2565.0	9M05G7D	0.0099	0.1253	9M07W7D	-	0.1112
15	2507.5 ~ 2562.5	13M4G7D	-	0.1253	13M5W7D	-	0.1107
20	2510.0 ~ 2560.0	18M4G7D	-	0.1256	18M4W7D	-	0.1084



1.7 Testing Location

Sporton International (Shenzhen) Inc. is accredited to ISO 17025 by National Voluntary Laboratory Accreditation Program (NVLAP code: 600156-0) and the FCC designation No. are CN5018 and CN5019.

Test Site	Sporton International (Shenzhen) Inc.	
Test Site Location	1/F, 2/F, Bldg 5, Shiling Industrial Zone, Xinwei Village, Xili, Nanshan Shenzhen City Guangdong Province 518055 China TEL: +86-755-8637-9589 FAX: +86-755-8637-9595	
Test Site No.	Sporton Site No.	FCC Test Firm Registration No.
	TH01-SZ	251365

Test Site	Sporton International (Shenzhen) Inc.	
Test Site Location	No. 3 Bldg the third floor of south, Shahe River west, Fengzeyuan Warehouse, Nanshan District Shenzhen City Guangdong Province 518055 China TEL: +86-755-3320-2398	
Test Site No.	Sporton Site No.	FCC Test Firm Registration No.
	03CH03-SZ	577730

Note: The test site complies with ANSI C63.4 2014 requirement.

1.8 Applicable Standards

According to the specifications of the manufacturer, the EUT must comply with the requirements of the following standards:

- ♦ 47 CFR Part 2, 24(E), 27(L), 27(M)
- ♦ ANSI C63.26-2015
- ♦ FCC KDB 971168 D01 Power Meas License Digital Systems v03r01
- ♦ FCC KDB 412172 D01 Determining ERP and EIRP v01r01

Remark:

1. All test items were verified and recorded according to the standards and without any deviation during the test.
2. This EUT has also been tested and complied with the requirements of FCC Part 15, Subpart B, recorded in a separate test report.



2 Test Configuration of Equipment Under Test

2.1 Test Mode

Antenna port conducted and radiated test items listed below are performed according to KDB 971168 D01 Power Meas License Digital Systems v03r01 with maximum output power.

Radiated measurements are performed by rotating the EUT in three different orthogonal test planes to find the maximum emission.

Test Items	Band	Bandwidth (MHz)						Modulation		RB #			Test Channel		
		1.4	3	5	10	15	20	QPS K	16QA M	1	Half	Full	L	M	H
Max. Output Power	2	v	v	v	v	v	v	v	v	v	v	v	v	v	v
	4	v	v	v	v	v	v	v	v	v	v	v	v	v	v
	7	-	-	v	v	v	v	v	v	v	v	v	v	v	v
Peak-to-Average Ratio	2						v	v	v	v		v	v	v	v
	4						v	v	v	v		v	v	v	v
	7	-	-				v	v	v	v		v	v	v	v
26dB and 99% Bandwidth	2	v	v	v	v	v	v	v	v			v	v	v	v
	4	v	v	v	v	v	v	v	v			v	v	v	v
	7	-	-	v	v	v	v	v	v			v	v	v	v
Conducted Band Edge	2	v	v	v	v	v	v	v	v	v		v	v		v
	4	v	v	v	v	v	v	v	v	v		v	v		v
	7	-	-	v	v	v	v	v	v	v		v	v		v
Conducted Spurious Emission	2	v	v	v	v	v	v	v	v	v			v	v	v
	4	v	v	v	v	v	v	v	v	v			v	v	v
	7	-	-	v	v	v	v	v	v	v			v	v	v
Frequency Stability	2				v			v				v		v	
	4				v			v				v		v	
	7	-	-		v			v				v		v	
E.R.P./E.I.R.P.	2	v	v	v	v	v	v	v	v	v			v	v	v
	4	v	v	v	v	v	v	v	v	v			v	v	v
	7	-	-	v	v	v	v	v	v	v			v	v	v
Radiated Spurious Emission	2	v	v	v	v	v	v	v		v				v	
	4	v	v	v	v	v	v	v		v				v	
	7	-	-	v	v	v	v	v		v				v	

Note	<ol style="list-style-type: none"> 1. The mark “v “ means that this configuration is chosen for testing 2. The mark “-“ means that this bandwidth is not supported. 3. The device is investigated from 30MHz to 10 times of fundamental signal for radiated spurious emission test under different RB size/offset and modulations in exploratory test. Subsequently, only the worst case emissions are reported.
-------------	---

2.2 Connection Diagram of Test System

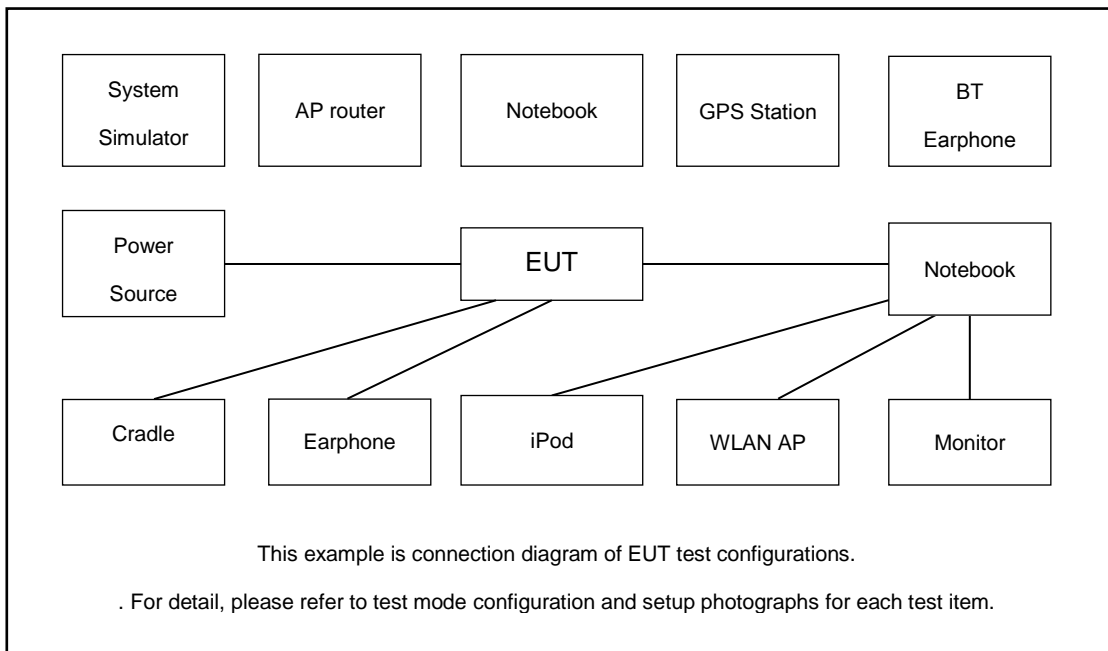



2.3 Support Unit used in test configuration and system

Item	Equipment	Trade Name	Model No.	FCC ID	Data Cable	Power Cord
1.	LTE Base Station	Anritsu	MT8820C	N/A	N/A	Unshielded, 1.8 m
2.	DC Power Supply	GW INSTEK	GPS-3030D	N/A	N/A	Unshielded, 1.8 m

2.4 Measurement Results Explanation Example

For all conducted test items:

The offset level is set in the spectrum analyzer to compensate the RF cable loss and attenuator factor between EUT conducted output port and spectrum analyzer. With the offset compensation, the spectrum analyzer reading level is exactly the EUT RF output level.

The spectrum analyzer offset is derived from RF cable loss and attenuator factor.

$$\text{Offset} = \text{RF cable loss} + \text{attenuator factor}.$$

Following shows an offset computation example with cable loss 4.5 dB and 10dB attenuator.

Example :

$$\begin{aligned} \text{Offset(dB)} &= \text{RF cable loss(dB)} + \text{attenuator factor(dB)}. \\ &= 4.5 + 10 = 14.5 \text{ (dB)} \end{aligned}$$



2.5 Frequency List of Low/Middle/High Channels

LTE Band 2 Channel and Frequency List				
BW [MHz]	Channel/Frequency(MHz)	Lowest	Middle	Highest
20	Channel	18700	18900	19100
	Frequency	1860	1880	1900
15	Channel	18675	18900	19125
	Frequency	1857.5	1880	1902.5
10	Channel	18650	18900	19150
	Frequency	1855	1880	1905
5	Channel	18625	18900	19175
	Frequency	1852.5	1880	1907.5
3	Channel	18615	18900	19185
	Frequency	1851.5	1880	1908.5
1.4	Channel	18607	18900	19193
	Frequency	1850.7	1880	1909.3

LTE Band 4 Channel and Frequency List				
BW [MHz]	Channel/Frequency(MHz)	Lowest	Middle	Highest
20	Channel	20050	20175	20300
	Frequency	1720	1732.5	1745
15	Channel	20025	20175	20325
	Frequency	1717.5	1732.5	1747.5
10	Channel	20000	20175	20350
	Frequency	1715	1732.5	1750
5	Channel	19975	20175	20375
	Frequency	1712.5	1732.5	1752.5
3	Channel	19965	20175	20385
	Frequency	1711.5	1732.5	1753.5
1.4	Channel	19957	20175	20393
	Frequency	1710.7	1732.5	1754.3



LTE Band 7 Channel and Frequency List				
BW [MHz]	Channel/Frequency(MHz)	Lowest	Middle	Highest
20	Channel	20850	21100	21350
	Frequency	2510	2535	2560
15	Channel	20825	21100	21375
	Frequency	2507.5	2535	2562.5
10	Channel	20800	21100	21400
	Frequency	2505	2535	2565
5	Channel	20775	21100	21425
	Frequency	2502.5	2535	2567.5

3 Conducted Test Items

3.1 Measuring Instruments

See list of measuring instruments of this test report.

3.2 Test Setup

3.2.1 Conducted Output Power



3.2.2 Peak-to-Average Ratio, Occupied Bandwidth ,Conducted Band-Edge and Conducted Spurious Emission



3.2.3 Frequency Stability

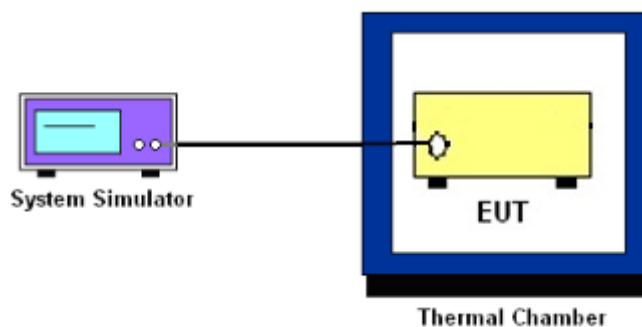

3.3 Test Result of Conducted Test

Please refer to Appendix A.



3.4 Conducted Output Power and ERP/EIRP

3.4.1 Description of the Conducted Output Power Measurement and ERP/EIRP Measurement

A system simulator was used to establish communication with the EUT. Its parameters were set to force the EUT transmitting at maximum output power. The measured power in the radio frequency on the transmitter output terminals shall be reported.

The EIRP of mobile transmitters must not exceed 2 Watts for LTE Band 2 and Band 7.

The EIRP of mobile transmitters must not exceed 1 Watts for LTE Band 4.

According to KDB 412172 D01 Power Approach,

$EIRP = P_T + G_T - L_C$, $ERP = EIRP - 2.15$, where

P_T = transmitter output power in dBm

G_T = gain of the transmitting antenna in dBi

L_C = signal attenuation in the connecting cable between the transmitter and antenna in dB

3.4.2 Test Procedures

1. The transmitter output port was connected to the system simulator.
2. Set EUT at maximum power through the system simulator.
3. Select lowest, middle, and highest channels for each band and different modulation.
4. Measure and record the power level from the system simulator.



3.5 Peak-to-Average Ratio

3.5.1 Description of the PAR Measurement

Power Complementary Cumulative Distribution Function (CCDF) curves provide a means for characterizing the power peaks of a digitally modulated signal on a statistical basis. A CCDF curve depicts the probability of the peak signal amplitude exceeding the average power level. Most contemporary measurement instrumentation include the capability to produce CCDF curves for an input signal provided that the instrument's resolution bandwidth can be set wide enough to accommodate the entire input signal bandwidth. In measuring transmissions in this band using an average power technique, the peak-to-average ratio (PAR) of the transmission may not exceed 13 dB.

3.5.2 Test Procedures

1. The testing ANSI C63.26 Section 5.2.3.4 (CCDF).
2. The EUT was connected to spectrum and system simulator via a power divider.
3. Set the CCDF (Complementary Cumulative Distribution Function) option in spectrum analyzer.
4. The highest RF powers were measured and recorded the maximum PAPR level associated with a probability of 0.1 %.
5. Record the deviation as Peak to Average Ratio.



3.6 Occupied Bandwidth

3.6.1 Description of Occupied Bandwidth Measurement

The occupied bandwidth is the width of a frequency band such that, below the lower and above the upper frequency limits, the mean powers emitted are each equal to a specified percentage 0.5% of the total mean transmitted power.

The 26 dB emission bandwidth is defined as the frequency range between two points, one above and one below the carrier frequency, at which the spectral density of the emission is attenuated 26 dB below the maximum in-band spectral density of the modulated signal. Spectral density (power per unit bandwidth) is to be measured with a detector of resolution bandwidth equal to approximately 1.0% of the emission bandwidth.

3.6.2 Test Procedures

1. The testing follows ANSI C63.26 Section 5.4.
2. The EUT was connected to spectrum analyzer and system simulator via a power divider.
3. The spectrum analyzer center frequency is set to the nominal EUT channel center frequency. The span range for the spectrum analyzer shall be between two and five times the anticipated OBW.
4. The nominal resolution bandwidth (RBW) shall be in the range of 1 to 5 % of the anticipated OBW, and the VBW shall be at least 3 times the RBW.
5. Set the detection mode to peak, and the trace mode to max hold.
6. Determine the reference value: Set the EUT to transmit a modulated signal. Allow the trace to stabilize. Set the spectrum analyzer marker to the highest level of the displayed trace.
(this is the reference value)
7. Determine the “-26 dB down amplitude” as equal to (Reference Value – X).
8. Place two markers, one at the lowest and the other at the highest frequency of the envelope of the spectral display such that each marker is at or slightly below the “-X dB down amplitude” determined in step 6. If a marker is below this “-X dB down amplitude” value it shall be placed as close as possible to this value. The OBW is the positive frequency difference between the two markers.
9. Use the 99 % power bandwidth function of the spectrum analyzer and report the measured bandwidth.



3.7 Conducted Band Edge

3.7.1 Description of Conducted Band Edge Measurement

24.238 (a)

For operations in the 1850-1910 and 1930-1990 MHz band, the FCC limit is $43 + 10\log_{10}(P[\text{Watts}])$ dB below the transmitter power $P(\text{Watts})$ in a 1MHz bandwidth. However, in the 1 MHz bands immediately outside and adjacent to the frequency block a resolution bandwidth of at least one percent of the emission bandwidth of the fundamental emission of the transmitter may be employed.

27.53 (h)

For operations in the 1710 – 1755 MHz band, the FCC limit is $43 + 10\log_{10}(P[\text{Watts}])$ dB below the transmitter power $P(\text{Watts})$ in a 1 MHz bandwidth. However, in the 1MHz bands immediately outside and adjacent to the licensee's frequency block, a resolution bandwidth of at least one percent of the emission bandwidth of the fundamental emission of the transmitter may be employed.

27.53(m)(4)

For mobile digital stations, the attenuation factor shall be not less than $40 + 10 \log (P)$ dB on all frequencies between the channel edge and 5 megahertz from the channel edge, $43 + 10 \log (P)$ dB on all frequencies between 5 megahertz and X megahertz from the channel edge, and $55 + 10 \log (P)$ dB on all frequencies more than X megahertz from the channel edge, where X is the greater of 6 megahertz or the actual emission bandwidth as defined in paragraph (m)(6) of this section. In addition, the attenuation factor shall not be less that $43 + 10 \log (P)$ dB on all frequencies between 2490.5 MHz and 2496 MHz and $55 + 10 \log (P)$ dB at or below 2490.5 MHz. Mobile Satellite Service licensees operating on frequencies below 2495 MHz may also submit a documented interference complaint against BRS licensees operating on channel BRS Channel 1 on the same terms and conditions as adjacent channel BRS or EBS licensees.



3.7.2 Test Procedures

1. The testing follows ANSI C63.26 section 5.7
2. The EUT was connected to spectrum analyzer and system simulator via a power divider.
3. The band edges of low and high channels for the highest RF powers were measured.
4. Set RBW \geq 1% EBW in the 1MHz band immediately outside and adjacent to the band edge.
5. Beyond the 1 MHz band from the band edge, RBW=1MHz was used.
6. Set spectrum analyzer with RMS detector.
7. The RF fundamental frequency should be excluded against the limit line in the operating frequency band.
8. Checked that all the results comply with the emission limit line.

Example:

The limit line is derived from $43 + 10\log(P)$ dB below the transmitter power P(Watts)
= P(W)- [43 + 10log(P)] (dB)
= [30 + 10log(P)] (dBm) - [43 + 10log(P)] (dB) = -13dBm.

9. For LTE Band 7, the other 40 dB, and 55 dB have additionally applied same calculation above.



3.8 Conducted Spurious Emission

3.8.1 Description of Conducted Spurious Emission Measurement

The power of any emission outside of the authorized operating frequency ranges must be lower than the transmitter power (P) by a factor of at least $43 + 10 \log (P)$ dB.

For Band 7:

The power of any emission outside of the authorized operating frequency ranges must be lower than the transmitter power (P) by a factor of at least $55 + 10 \log (P)$ dB.

It is measured by means of a calibrated spectrum analyzer and scanned from 30 MHz up to a frequency including its 10th harmonic.

3.8.2 Test Procedures

1. The testing follows ANSI C63.26 section 5.7
2. The EUT was connected to spectrum analyzer and system simulator via a power divider.
3. The RF output of EUT was connected to the spectrum analyzer by RF cable and attenuator. The path loss was compensated to the results for each measurement.
4. The middle channel for the highest RF power within the transmitting frequency was measured.
5. The conducted spurious emission for the whole frequency range was taken.
6. Make the measurement with the spectrum analyzer's RBW = 1MHz, VBW = 3MHz.
7. Set spectrum analyzer with RMS detector.
8. Taking the record of maximum spurious emission.
9. The RF fundamental frequency should be excluded against the limit line in the operating frequency band.
10. The limit line is derived from $43 + 10\log(P)$ dB below the transmitter power P(Watts)
= $P(W) - [43 + 10\log(P)]$ (dB)
= $[30 + 10\log(P)]$ (dBm) - $[43 + 10\log(P)]$ (dB)
= -13dBm.
11. For Band 7
The limit line is derived from $55 + 10\log(P)$ dB below the transmitter power P(Watts)
= $P(W) - [55 + 10\log(P)]$ (dB)
= $[30 + 10\log(P)]$ (dBm) - $[55 + 10\log(P)]$ (dB)
= -25dBm.



3.9 Frequency Stability

3.9.1 Description of Frequency Stability Measurement

The frequency stability shall be measured by variation of ambient temperature and variation of primary supply voltage to ensure that the fundamental emission stays within the authorized frequency block. The frequency stability of the transmitter shall be maintained within $\pm 0.00025\%$ ($\pm 2.5\text{ppm}$) of the center frequency.

3.9.2 Test Procedures for Temperature Variation

1. The testing follows ANSI C63.26 section 5.6.4
2. The EUT was set up in the thermal chamber and connected with the system simulator.
3. With power OFF, the temperature was decreased to -30°C and the EUT was stabilized before testing. Power was applied and the maximum change in frequency was recorded within one minute.
4. With power OFF, the temperature was raised in 10°C step up to 50°C . The EUT was stabilized at each step for at least half an hour. Power was applied and the maximum frequency change was recorded within one minute.

3.9.3 Test Procedures for Voltage Variation

1. The testing follows ANSI C63.26 section 5.6.5
2. The EUT was placed in a temperature chamber at $20\pm 5^{\circ}\text{C}$ and connected with the system simulator.
3. The power supply voltage to the EUT was varied from 85% to 115% of the nominal value measured at the input to the EUT.
4. The variation in frequency was measured for the worst case.

4 Radiated Test Items

4.1 Measuring Instruments

See list of measuring instruments of this test report.

4.2 Test Setup

4.2.1 For radiated test from 30MHz to 1GHz

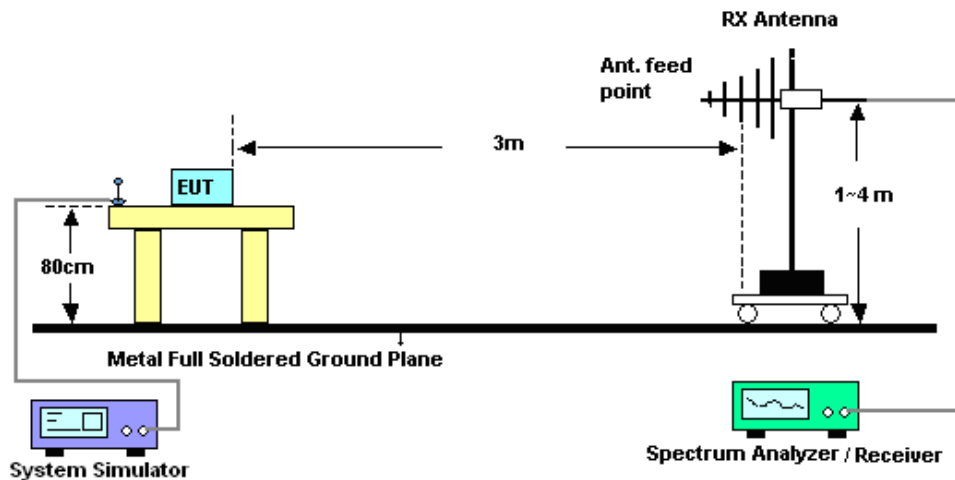

4.2.2 For radiated test above 1GHz

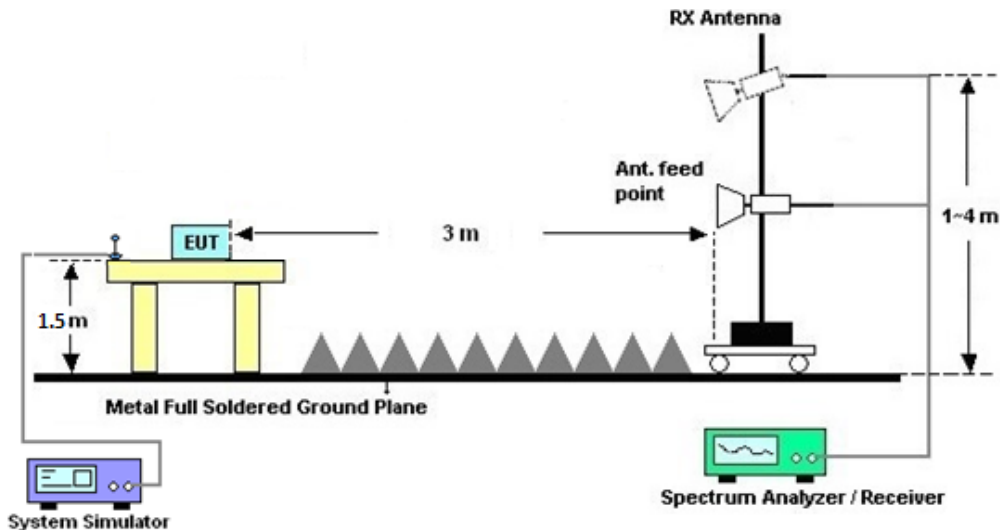

4.3 Test Result of Radiated Test

Please refer to Appendix B.



4.4 Radiated Spurious Emission

4.4.1 Description of Radiated Spurious Emission

The radiated spurious emission was measured by substitution method according to ANSI C63.26. The power of any emission outside of the authorized operating frequency ranges must be attenuated below the transmitter power (P) by a factor of at least $43 + 10 \log (P)$ dB.

For Band 7

The power of any emission outside of the authorized operating frequency ranges must be attenuated below the transmitter power (P) by a factor of at least $55 + 10 \log (P)$ dB.

4.4.2 Test Procedures

1. The testing follows ANSI C63.26 Section 5.5
2. The EUT was placed on a turntable with 0.8 meter height for frequency below 1GHz and 1.5 meter height for frequency above 1GHz respectively above ground.
3. The EUT was set 3 meters from the receiving antenna mounted on the antenna tower.
4. The table was rotated 360 degrees to determine the position of the highest spurious emission.
5. The height of the receiving antenna is varied between 1m to 4m to search the maximum spurious emission for both horizontal and vertical polarizations.
6. During the measurement, the system simulator parameters were set to force the EUT transmitting at maximum output power.
7. Make the measurement with the spectrum analyzer's RBW = 1MHz, VBW = 3MHz, taking the record of maximum spurious emission.
8. A horn antenna was substituted in place of the EUT and was driven by a signal generator.
9. Tune the output power of signal generator to the same emission level with EUT maximum spurious emission.
10. $EIRP (dBm) = S.G. Power - Tx Cable Loss + Tx Antenna Gain$
11. $ERP (dBm) = EIRP - 2.15$
12. The RF fundamental frequency should be excluded against the limit line in the operating frequency band.

The limit line is derived from $43 + 10\log(P)$ dB below the transmitter power P(Watts)
 $= P(W) - [43 + 10\log(P)] (dB)$
 $= [30 + 10\log(P)] (dBm) - [43 + 10\log(P)] (dB)$
 $= -13dBm.$

13. For Band 7:

The limit line is derived from $55 + 10\log(P)$ dB below the transmitter power P(Watts)
 $EIRP (dBm) = S.G. Power - Tx Cable Loss + Tx Antenna Gain$
 $ERP (dBm) = EIRP - 2.15$



5 List of Measuring Equipment

Instrument	Manufacturer	Model No.	Serial No.	Characteristics	Calibration Date	Test Date	Due Date	Remark
Spectrum Analyzer	R&S	FSV40	101078	9kHz~40GHz	Apr.19, 2018	Apr. 20, 2018~ Apr. 26, 2018	Apr.18, 2019	Conducted (TH01-SZ)
Radio Communication Analyzer	Anritsu	MT8820C	6201563777	2G/3G/4G (CDMA)	Jan. 03, 2018	Apr. 20, 2018~ Apr. 26, 2018	Jan. 02, 2019	Conducted (TH01-SZ)
Thermal Chamber	Ten Billion Hongzhangroup	LP-150U	H2014081803	-40~+150°C	Jul. 20, 2017	Apr. 20, 2018~ Apr. 26, 2018	Jul. 19, 2018	Conducted (TH01-SZ)
EXA Spectrum Analyzer	KEYSIGHT	N9010A	MY55150246	10Hz~44GHz;	Apr. 20, 2017	Mar. 24, 2018~ Mar. 25, 2018	Apr. 19, 2018	Radiation (03CH03-SZ)
Bilog Antenna	TeseQ	CBL6112D	35408	30MHz-2GHz	Apr. 25, 2017	Mar. 24, 2018~ Mar. 25, 2018	Apr. 24, 2018	Radiation (03CH03-SZ)
Double Ridge Horn Antenna	SCHWARZBECK	BBHA9120D	9120D-1355	1GHz~18GHz	Jul. 09, 2017	Mar. 24, 2018~ Mar. 25, 2018	Jul. 08, 2018	Radiation (03CH03-SZ)
Amplifier	Burgeon	BPA-530	102210	0.01Hz ~3000MHz	Oct. 19, 2017	Mar. 24, 2018~ Mar. 25, 2018	Oct. 18, 2018	Radiation (03CH03-SZ)
HF Amplifier	MITEQ	TTA1840-35-HG	1871923	18GHz~40GHz	Jul. 18, 2017	Mar. 24, 2018~ Mar. 25, 2018	Jul. 17, 2018	Radiation (03CH03-SZ)
SHF-EHF Horn	com-power	AH-840	101071	18Ghz-40GHz	Jun. 16, 2017	Mar. 24, 2018~ Mar. 25, 2018	Jun. 15, 2018	Radiation (03CH03-SZ)
Amplifier	Agilent Technologies	83017A	MY39501302	500MHz~26.5GHz	Dec. 27, 2017	Mar. 24, 2018~ Mar. 25, 2018	Dec. 26, 2018	Radiation (03CH03-SZ)
AC Power Source	Chroma	61601	616010001985	N/A	NCR	Mar. 24, 2018~ Mar. 25, 2018	NCR	Radiation (03CH03-SZ)
Turn Table	EM	EM1000	N/A	0~360 degree	NCR	Mar. 24, 2018~ Mar. 25, 2018	NCR	Radiation (03CH03-SZ)
Antenna Mast	EM	EM1000	N/A	1 m~4 m	NCR	Mar. 24, 2018~ Mar. 25, 2018	NCR	Radiation (03CH03-SZ)

NCR: No Calibration Required



6 Uncertainty of Evaluation

Uncertainty of Radiated Emission Measurement (30 MHz ~ 1000 MHz)

Measuring Uncertainty for a Level of Confidence of 95% ($U = 2Uc(y)$)	3.0dB
---	-------

Uncertainty of Radiated Emission Measurement (1GHz ~ 18GHz)

Measuring Uncertainty for a Level of Confidence of 95% ($U = 2Uc(y)$)	3.6dB
---	-------

Uncertainty of Radiated Emission Measurement (18GHz ~ 40GHz)

Measuring Uncertainty for a Level of Confidence of 95% ($U = 2Uc(y)$)	3.8dB
---	-------



Appendix A. Test Results of Conducted Test

Conducted Output Power(Average power)

LTE Band 2 Maximum Average Power [dBm]						
BW [MHz]	RB Size	RB Offset	Mod	Lowest	Middle	Highest
20	1	0	QPSK	22.58	22.72	22.61
20	1	49		22.77	22.70	22.64
20	1	99		22.51	22.52	22.39
20	50	0		21.82	21.73	21.66
20	50	24		21.78	21.75	21.66
20	50	50		21.80	21.62	21.57
20	100	0		21.83	21.65	21.63
20	1	0	16-QAM	22.14	22.06	22.03
20	1	49		21.63	22.01	22.02
20	1	99		21.91	21.74	21.92
20	50	0		20.73	20.86	20.75
20	50	24		20.67	20.80	20.66
20	50	50		20.68	20.79	20.51
20	100	0		20.63	20.89	20.67
15	1	0	QPSK	22.70	22.73	22.55
15	1	37		22.76	22.63	22.74
15	1	74		22.67	22.62	22.50
15	36	0		21.79	21.82	21.69
15	36	20		21.72	21.80	21.65
15	36	39		21.70	21.79	21.59
15	75	0		21.69	21.77	21.71
15	1	0	16-QAM	21.64	21.59	21.54
15	1	37		21.80	22.27	22.10
15	1	74		22.03	22.09	21.66
15	36	0		20.71	20.93	20.80
15	36	20		20.74	20.87	20.70
15	36	39		20.71	20.76	20.62
15	75	0		20.72	20.78	20.67



LTE Band 2 Maximum Average Power [dBm]						
BW [MHz]	RB Size	RB Offset	Mod	Lowest	Middle	Highest
10	1	0	QPSK	22.75	22.72	22.54
10	1	25		22.74	22.69	22.55
10	1	49		22.59	22.70	22.52
10	25	0		21.82	21.76	21.68
10	25	12		21.84	21.71	21.71
10	25	25		21.82	21.74	21.55
10	50	0		21.82	21.73	21.65
10	1	0	16-QAM	21.98	22.13	21.74
10	1	25		22.28	22.21	22.11
10	1	49		22.03	22.08	21.79
10	25	0		20.77	20.83	20.82
10	25	12		20.67	20.89	20.83
10	25	25		20.86	20.77	20.63
10	50	0		20.75	21.00	20.70
5	1	0	QPSK	22.55	22.55	22.37
5	1	12		22.65	22.61	22.61
5	1	24		22.66	22.63	22.47
5	12	0		21.76	21.74	21.57
5	12	7		21.72	21.72	21.73
5	12	13		21.83	21.67	21.57
5	25	0		21.79	21.70	21.69
5	1	0	16-QAM	21.72	22.08	21.59
5	1	12		22.49	22.13	22.33
5	1	24		21.62	21.72	21.83
5	12	0		20.71	20.77	20.64
5	12	7		20.75	20.89	20.60
5	12	13		20.79	20.76	20.53
5	25	0		20.77	20.80	20.69



LTE Band 2 Maximum Average Power [dBm]						
BW [MHz]	RB Size	RB Offset	Mod	Lowest	Middle	Highest
3	1	0	QPSK	22.70	22.65	22.49
3	1	8		22.76	22.73	22.59
3	1	14		22.66	22.70	22.48
3	8	0		21.82	21.78	21.62
3	8	4		21.81	21.78	21.56
3	8	7		21.74	21.71	21.60
3	15	0		21.75	21.75	21.66
3	1	0	16-QAM	21.91	22.24	21.69
3	1	8		21.85	22.13	21.97
3	1	14		21.69	21.62	21.43
3	8	0		20.84	20.97	20.67
3	8	4		20.81	20.82	20.72
3	8	7		20.81	20.78	20.69
3	15	0		20.72	20.89	20.62
1.4	1	0	QPSK	22.62	22.74	22.51
1.4	1	3		22.76	22.75	22.67
1.4	1	5		22.64	22.74	22.46
1.4	3	0		22.74	22.73	22.62
1.4	3	1		22.73	22.63	22.64
1.4	3	3		22.69	22.69	22.61
1.4	6	0		21.74	21.75	21.65
1.4	1	0	16-QAM	22.17	22.15	21.35
1.4	1	3		22.01	21.96	22.02
1.4	1	5		21.64	22.21	21.89
1.4	3	0		21.71	21.60	21.57
1.4	3	1		21.69	21.75	21.62
1.4	3	3		21.79	21.87	21.64
1.4	6	0		21.00	20.83	20.82



LTE Band 4 Maximum Average Power [dBm]						
BW [MHz]	RB Size	RB Offset	Mod	Lowest	Middle	Highest
20	1	0	QPSK	22.48	22.61	22.65
20	1	49		22.50	22.58	22.67
20	1	99		22.25	22.32	22.46
20	50	0		21.65	21.67	21.68
20	50	24		21.58	21.70	21.75
20	50	50		21.49	21.53	21.55
20	100	0		21.54	21.61	21.62
20	1	0	16-QAM	21.67	22.10	21.64
20	1	49		22.19	21.78	21.59
20	1	99		21.33	21.50	21.53
20	50	0		20.53	20.58	20.61
20	50	24		20.61	20.55	20.55
20	50	50		20.48	20.53	20.38
20	100	0		20.52	20.59	20.53
15	1	0	QPSK	22.54	22.56	22.59
15	1	37		22.52	22.57	22.66
15	1	74		22.41	22.52	22.41
15	36	0		21.57	21.68	21.57
15	36	20		21.59	21.68	21.62
15	36	39		21.48	21.68	21.49
15	75	0		21.55	21.58	21.58
15	1	0	16-QAM	21.42	21.70	21.98
15	1	37		22.03	22.03	21.98
15	1	74		21.92	21.67	21.59
15	36	0		20.59	20.57	20.69
15	36	20		20.49	20.57	20.59
15	36	39		20.48	20.57	20.37
15	75	0		20.57	20.55	20.51



LTE Band 4 Maximum Average Power [dBm]						
BW [MHz]	RB Size	RB Offset	Mod	Lowest	Middle	Highest
10	1	0	QPSK	22.50	22.52	22.65
10	1	25		22.60	22.64	22.65
10	1	49		22.37	22.61	22.52
10	25	0		21.63	21.75	21.67
10	25	12		21.64	21.65	21.64
10	25	25		21.54	21.66	21.52
10	50	0		21.59	21.73	21.60
10	1	0	16-QAM	21.66	21.65	21.64
10	1	25		21.61	22.16	22.14
10	1	49		21.47	21.41	22.09
10	25	0		20.58	20.54	20.69
10	25	12		20.60	20.56	20.52
10	25	25		20.63	20.62	20.46
10	50	0		20.64	20.74	20.53
5	1	0	QPSK	22.42	22.61	22.39
5	1	12		22.56	22.58	22.59
5	1	24		22.48	22.42	22.52
5	12	0		21.53	21.60	21.58
5	12	7		21.58	21.62	21.57
5	12	13		21.54	21.57	21.54
5	25	0		21.60	21.65	21.52
5	1	0	16-QAM	21.76	21.64	21.47
5	1	12		21.63	22.14	21.47
5	1	24		21.47	22.03	21.30
5	12	0		20.50	20.62	20.51
5	12	7		20.52	20.59	20.60
5	12	13		20.42	20.54	20.45
5	25	0		20.54	20.47	20.39



LTE Band 4 Maximum Average Power [dBm]						
BW [MHz]	RB Size	RB Offset	Mod	Lowest	Middle	Highest
3	1	0	QPSK	22.60	22.59	22.57
3	1	8		22.40	22.45	22.48
3	1	14		22.56	22.57	22.50
3	8	0		21.58	21.66	21.53
3	8	4		21.57	21.70	21.55
3	8	7		21.59	21.70	21.44
3	15	0		21.62	21.58	21.48
3	1	0	16-QAM	21.95	22.19	21.62
3	1	8		21.65	21.78	21.37
3	1	14		21.56	21.83	21.94
3	8	0		20.64	20.72	20.58
3	8	4		20.61	20.69	20.60
3	8	7		20.45	20.63	20.64
3	15	0		20.52	20.65	20.56
1.4	1	0	QPSK	22.52	22.57	22.46
1.4	1	3		22.62	22.64	22.54
1.4	1	5		22.44	22.52	22.42
1.4	3	0		22.53	22.57	22.48
1.4	3	1		22.55	22.58	22.63
1.4	3	3		22.59	22.64	22.52
1.4	6	0		21.63	21.61	21.60
1.4	1	0	16-QAM	21.89	21.80	21.68
1.4	1	3		21.73	22.22	21.51
1.4	1	5		21.36	21.63	21.95
1.4	3	0		21.58	21.75	21.37
1.4	3	1		21.59	21.85	21.59
1.4	3	3		21.65	21.69	21.49
1.4	6	0		20.75	20.87	20.77



LTE Band 7 Maximum Average Power [dBm]						
BW [MHz]	RB Size	RB Offset	Mod	Lowest	Middle	Highest
20	1	0	QPSK	22.77	23.17	23.12
20	1	49		23.14	23.32	23.26
20	1	99		22.83	23.18	23.17
20	50	0		22.04	22.45	22.24
20	50	24		22.16	22.55	22.34
20	50	50		22.07	22.52	22.36
20	100	0		21.99	22.54	22.24
20	1	0	16-QAM	22.39	22.63	22.31
20	1	49		22.68	22.34	22.44
20	1	99		22.15	22.28	22.45
20	50	0		20.99	21.22	21.47
20	50	24		21.11	21.34	21.52
20	50	50		21.04	21.26	21.45
20	100	0		20.99	21.26	21.31
15	1	0	QPSK	22.83	23.13	23.21
15	1	37		23.14	23.26	23.31
15	1	74		22.95	23.21	23.30
15	36	0		22.05	22.27	22.49
15	36	20		22.16	22.29	22.45
15	36	39		22.05	22.41	22.43
15	75	0		22.02	22.39	22.44
15	1	0	16-QAM	21.96	22.36	22.53
15	1	37		22.61	22.77	22.62
15	1	74		22.10	22.72	22.47
15	36	0		21.06	21.32	21.40
15	36	20		21.08	21.34	21.52
15	36	39		21.10	21.40	21.48
15	75	0		21.05	21.28	21.39



LTE Band 7 Maximum Average Power [dBm]						
BW [MHz]	RB Size	RB Offset	Mod	Lowest	Middle	Highest
10	1	0	QPSK	22.96	23.09	23.26
10	1	25		23.01	23.27	23.31
10	1	49		22.85	23.13	23.28
10	25	0		21.91	22.35	22.54
10	25	12		22.07	22.35	22.48
10	25	25		22.11	22.36	22.44
10	50	0		21.96	22.34	22.44
10	1	0	16-QAM	21.97	22.66	22.45
10	1	25		21.99	22.79	22.47
10	1	49		21.89	22.57	22.29
10	25	0		20.95	21.22	21.51
10	25	12		21.01	21.28	21.44
10	25	25		21.09	21.31	21.54
10	50	0		21.11	21.34	21.42
5	1	0	QPSK	22.67	23.01	23.23
5	1	12		23.01	23.29	23.29
5	1	24		22.85	23.02	23.27
5	12	0		21.93	22.30	22.44
5	12	7		21.98	22.42	22.46
5	12	13		22.06	22.32	22.43
5	25	0		21.91	22.24	22.41
5	1	0	16-QAM	22.13	22.64	22.72
5	1	12		22.34	22.72	22.76
5	1	24		21.78	22.02	22.48
5	12	0		20.90	21.16	21.33
5	12	7		21.01	21.30	21.56
5	12	13		20.96	21.25	21.48
5	25	0		20.98	21.29	21.32



ERP/EIRP

LTE Band 2 (G _T - L _C = -1.88 dB) QPSK									
Bandwidth	1.4M			3M			5M		
Channel	18607	18900	19193	18615	18900	19185	18625	18900	19175
	(Low)	(Mid)	(High)	(Low)	(Mid)	(High)	(Low)	(Mid)	(High)
Frequency	1850.7	1880	1909.3	1851.5	1880	1908.5	1852.5	1880	1907.5
(MHz)									
Conducted Power (dBm)	22.76	22.75	22.67	22.76	22.73	22.59	22.66	22.63	22.47
Conducted Power (Watts)	0.1888	0.1884	0.1849	0.1888	0.1875	0.1816	0.1845	0.1832	0.1766
EIRP(dBm)	20.88	20.87	20.79	20.88	20.85	20.71	20.78	20.75	20.59
EIRP(Watts)	0.1225	0.1222	0.1199	0.1225	0.1216	0.1178	0.1197	0.1189	0.1146

LTE Band 2 (G _T - L _C = -1.88 dB) QPSK									
Bandwidth	10M			15M			20M		
Channel	18650	18900	19150	18675	18900	19125	18650	18900	19100
	(Low)	(Mid)	(High)	(Low)	(Mid)	(High)	(Low)	(Mid)	(High)
Frequency	1855	1880	1905	1857.5	1880	1902.5	1860	1880	1900
(MHz)									
Conducted Power (dBm)	22.75	22.72	22.54	22.76	22.63	22.74	22.77	22.70	22.64
Conducted Power (Watts)	0.1884	0.1871	0.1795	0.1888	0.1832	0.1879	0.1892	0.1862	0.1837
EIRP(dBm)	20.87	20.84	20.66	20.88	20.75	20.86	20.89	20.82	20.76
EIRP(Watts)	0.1222	0.1213	0.1164	0.1225	0.1189	0.1219	0.1227	0.1208	0.1191



LTE Band 2 (G _T - L _C = -1.88 dB) 16QAM									
Bandwidth	1.4M			3M			5M		
Channel	18607	18900	19193	18615	18900	19185	18625	18900	19175
	(Low)	(Mid)	(High)	(Low)	(Mid)	(High)	(Low)	(Mid)	(High)
Frequency (MHz)	1850.7	1880	1909.3	1851.5	1880	1908.5	1852.5	1880	1907.5
Conducted Power (dBm)	21.64	22.21	21.89	21.91	22.24	21.69	22.49	22.13	22.33
Conducted Power (Watts)	0.1459	0.1663	0.1545	0.1552	0.1675	0.1476	0.1774	0.1633	0.1710
EIRP(dBm)	19.76	20.33	20.01	20.03	20.36	19.81	20.61	20.25	20.45
EIRP(Watts)	0.0946	0.1079	0.1002	0.1007	0.1086	0.0957	0.1151	0.1059	0.1109

LTE Band 2 (G _T - L _C = -1.88 dB) 16QAM									
Bandwidth	10M			15M			20M		
Channel	18650	18900	19150	18675	18900	19125	18650	18900	19100
	(Low)	(Mid)	(High)	(Low)	(Mid)	(High)	(Low)	(Mid)	(High)
Frequency (MHz)	1855	1880	1905	1857.5	1880	1902.5	1860	1880	1900
Conducted Power (dBm)	22.28	22.21	22.11	21.80	22.27	22.10	22.14	22.06	22.03
Conducted Power (Watts)	0.1690	0.1663	0.1626	0.1514	0.1687	0.1622	0.1637	0.1607	0.1596
EIRP(dBm)	20.40	20.33	20.23	19.92	20.39	20.22	20.26	20.18	20.15
EIRP(Watts)	0.1096	0.1079	0.1054	0.0982	0.1094	0.1052	0.1062	0.1042	0.1035



LTE Band 4 (G _T - L _C = -1.15 dB) QPSK									
Bandwidth	1.4M			3M			5M		
Channel	19957	20175	20393	19965	20175	20385	19975	20175	20375
	(Low)	(Mid)	(High)	(Low)	(Mid)	(High)	(Low)	(Mid)	(High)
Frequency (MHz)	1710.7	1732.5	1754.3	1711.5	1732.5	1753.5	1712.5	1732.5	1752.5
Conducted Power (dBm)	22.62	22.64	22.54	22.60	22.59	22.57	22.42	22.61	22.39
Conducted Power (Watts)	0.1828	0.1837	0.1795	0.1820	0.1816	0.1807	0.1746	0.1824	0.1734
EIRP(dBm)	21.47	21.49	21.39	21.45	21.44	21.42	21.27	21.46	21.24
EIRP(Watts)	0.1403	0.1409	0.1377	0.1396	0.1393	0.1387	0.1340	0.1400	0.1330

LTE Band 4 (G _T - L _C = -1.15 dB) QPSK									
Bandwidth	10M			15M			20M		
Channel	20000	20175	20350	20025	20175	20325	20050	20175	20300
	(Low)	(Mid)	(High)	(Low)	(Mid)	(High)	(Low)	(Mid)	(High)
Frequency (MHz)	1715	1732.5	1750	1717.5	1732.5	1747.5	1720	1732.5	1745
Conducted Power (dBm)	22.60	22.64	22.65	22.52	22.57	22.66	22.50	22.58	22.67
Conducted Power (Watts)	0.1820	0.1837	0.1841	0.1786	0.1807	0.1845	0.1778	0.1811	0.1849
EIRP(dBm)	21.45	21.49	21.50	21.37	21.42	21.51	21.35	21.43	21.52
EIRP(Watts)	0.1396	0.1409	0.1413	0.1371	0.1387	0.1416	0.1365	0.1390	0.1419



LTE Band 4 (G _T - L _C = -1.15 dB) 16QAM									
Bandwidth	1.4M			3M			5M		
Channel	19957	20175	20393	19965	20175	20385	19975	20175	20375
	(Low)	(Mid)	(High)	(Low)	(Mid)	(High)	(Low)	(Mid)	(High)
Frequency (MHz)	1710.7	1732.5	1754.3	1711.5	1732.5	1753.5	1712.5	1732.5	1752.5
Conducted Power (dBm)	21.73	22.22	21.51	21.95	22.19	21.62	21.63	22.14	21.47
Conducted Power (Watts)	0.1489	0.1667	0.1416	0.1567	0.1656	0.1452	0.1455	0.1637	0.1403
EIRP(dBm)	20.58	21.07	20.36	20.80	21.04	20.47	20.48	20.99	20.32
EIRP(Watts)	0.1143	0.1279	0.1086	0.1202	0.1271	0.1114	0.1117	0.1256	0.1076

LTE Band 4 (G _T - L _C = -1.15 dB) 16QAM									
Bandwidth	10M			15M			20M		
Channel	20000	20175	20350	20025	20175	20325	20050	20175	20300
	(Low)	(Mid)	(High)	(Low)	(Mid)	(High)	(Low)	(Mid)	(High)
Frequency (MHz)	1715	1732.5	1750	1717.5	1732.5	1747.5	1720	1732.5	1745
Conducted Power (dBm)	21.61	22.16	22.14	22.03	22.03	21.98	22.19	21.78	21.59
Conducted Power (Watts)	0.1449	0.1644	0.1637	0.1596	0.1596	0.1578	0.1656	0.1507	0.1442
EIRP(dBm)	20.46	21.01	20.99	20.88	20.88	20.83	21.04	20.63	20.44
EIRP(Watts)	0.1112	0.1262	0.1256	0.1225	0.1225	0.1211	0.1271	0.1156	0.1107



LTE Band 7 (G _T - L _C = -2.33dB) QPSK			
Bandwidth	5M		
Channel	20775	21100	21425
	(Low)	(Mid)	(High)
Frequency	2502.5	2535	2567.5
(MHz)			
Conducted Power (dBm)	23.01	23.29	23.29
Conducted Power (Watts)	0.2000	0.2133	0.2133
EIRP(dBm)	20.68	20.96	20.96
EIRP(Watts)	0.1169	0.1247	0.1247

LTE Band 7 (G _T - L _C = -2.33dB) QPSK									
Bandwidth	10M			15M			20M		
Channel	20800	21100	21400	20825	21100	21375	20850	21100	21350
	(Low)	(Mid)	(High)	(Low)	(Mid)	(High)	(Low)	(Mid)	(Mid)
Frequency	2505	2535	2565	2507.5	2535	2562.5	2510	2535	2560
(MHz)									
Conducted Power (dBm)	23.01	23.27	23.31	23.14	23.26	23.31	23.14	23.32	23.26
Conducted Power (Watts)	0.2000	0.2123	0.2143	0.2061	0.2118	0.2143	0.2061	0.2148	0.2118
EIRP(dBm)	20.68	20.94	20.98	20.81	20.93	20.98	20.81	20.99	20.93
EIRP(Watts)	0.1169	0.1242	0.1253	0.1205	0.1239	0.1253	0.1205	0.1256	0.1239



LTE Band 7 ($G_T - L_C = -2.33\text{dB}$) 16QAM			
Bandwidth	5M		
Channel	20775	21100	21425
	(Low)	(Mid)	(High)
Frequency	2502.5	2535	2567.5
(MHz)			
Conducted Power (dBm)	22.34	22.72	22.76
Conducted Power (Watts)	0.1714	0.1871	0.1888
EIRP(dBm)	20.01	20.39	20.43
EIRP(Watts)	0.1002	0.1094	0.1104

LTE Band 7 ($G_T - L_C = -2.33\text{dB}$) 16QAM									
Bandwidth	10M			15M			20M		
Channel	20800	21100	21400	20825	21100	21375	20850	21100	21350
	(Low)	(Mid)	(High)	(Low)	(Mid)	(High)	(Low)	(Mid)	(Mid)
Frequency	2505	2535	2565	2507.5	2535	2562.5	2510	2535	2560
(MHz)									
Conducted Power (dBm)	21.99	22.79	22.47	22.61	22.77	22.62	22.68	22.34	22.44
Conducted Power (Watts)	0.1581	0.1901	0.1766	0.1824	0.1892	0.1828	0.1854	0.1714	0.1754
EIRP(dBm)	19.66	20.46	20.14	20.28	20.44	20.29	20.35	20.01	20.11
EIRP(Watts)	0.0925	0.1112	0.1033	0.1067	0.1107	0.1069	0.1084	0.1002	0.1026



Peak-to-Average Ratio

Mode	LTE Band 2 / 20MHz				
Mod.	QPSK		16QAM		Limit: 13dB
RB Size	1RB	Full RB	1RB	Full RB	Result
Lowest CH	4.99	5.04	6.32	6	PASS
Middle CH	4.9	5.28	5.91	6.06	
Highest CH	5.1	5.04	6.29	5.91	

Mode	LTE Band 4 / 20MHz				
Mod.	QPSK		16QAM		Limit: 13dB
RB Size	1RB	Full RB	1RB	Full RB	Result
Lowest CH	4.7	5.22	5.68	6.12	PASS
Middle CH	5.16	5.25	6.12	6.14	
Highest CH	4.64	5.13	6.17	6.06	

Mode	LTE Band 7 / 20MHz				
Mod.	QPSK		16QAM		Limit: 13dB
RB Size	1RB	Full RB	1RB	Full RB	Result
Lowest CH	4.03	4.96	4.96	6.06	PASS
Middle CH	4.75	5.19	5.59	6.09	
Highest CH	4.32	4.99	4.99	5.94	



LTE Band 2 / 20MHz / QPSK

Lowest Channel / 1RB

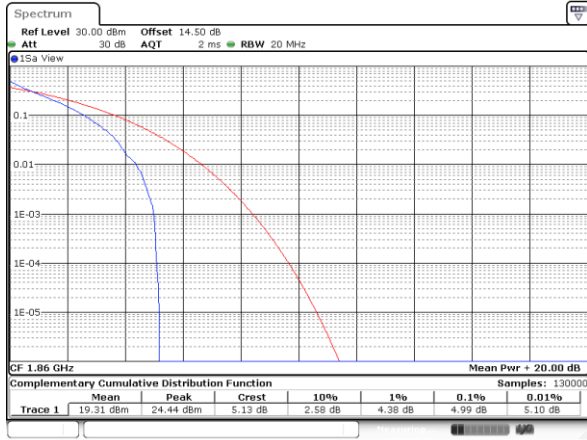

Date: 23.APR.2018 13:52:02

Lowest Channel / Full RB

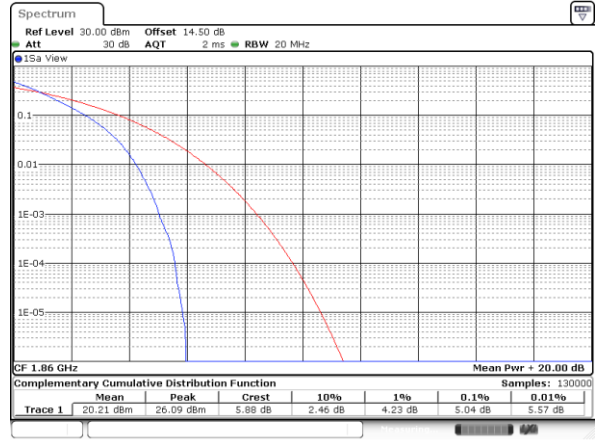

Date: 23.APR.2018 13:52:12

Middle Channel / 1RB

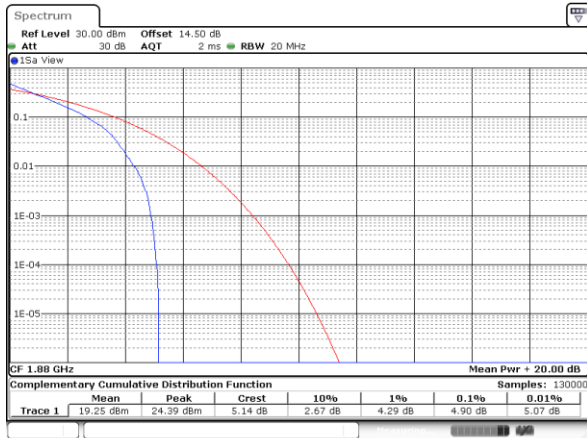

Date: 23.APR.2018 13:52:21

Middle Channel / Full RB

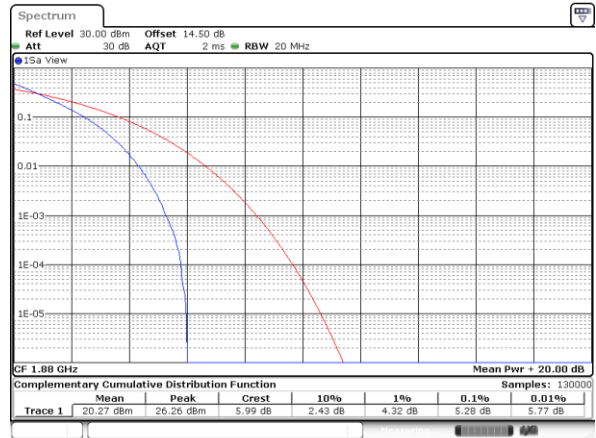

Date: 23.APR.2018 13:52:30

Highest Channel / 1RB

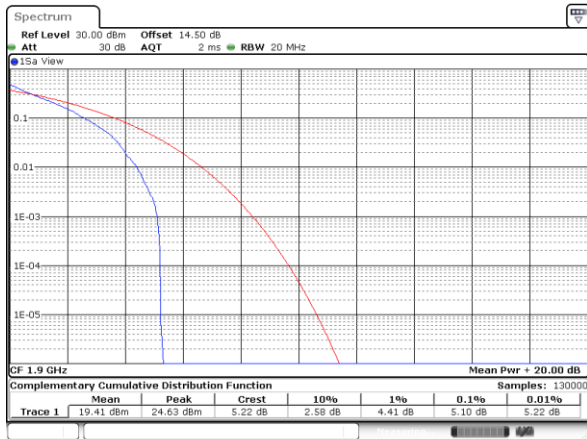

Date: 23.APR.2018 13:52:39

Highest Channel / Full RB

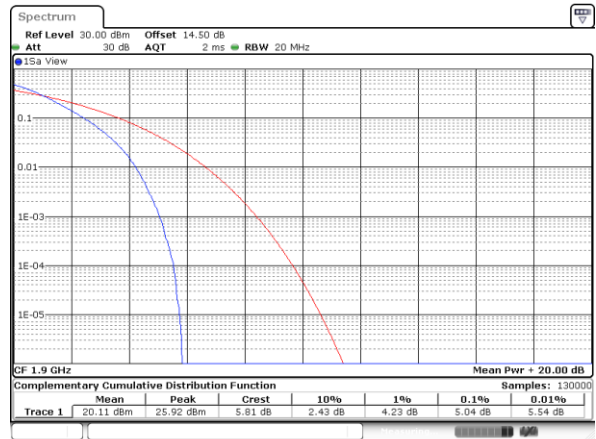

Date: 23.APR.2018 13:52:48



LTE Band 2 / 20MHz / 16QAM

Lowest Channel / 1RB

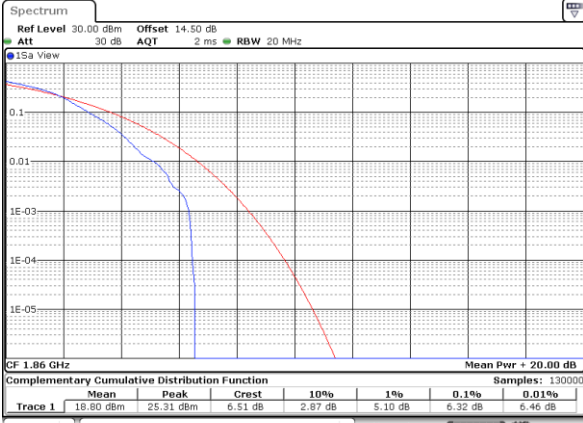

Date: 23.APR.2018 13:50:43

Lowest Channel / Full RB

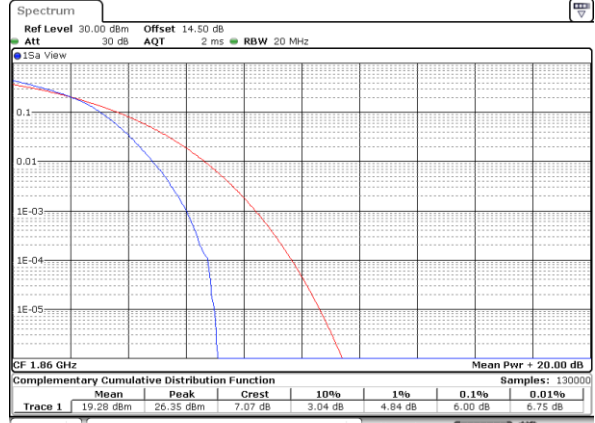

Date: 23.APR.2018 13:51:01

Middle Channel / 1RB



Date: 23.APR.2018 13:51:16

Middle Channel / Full RB

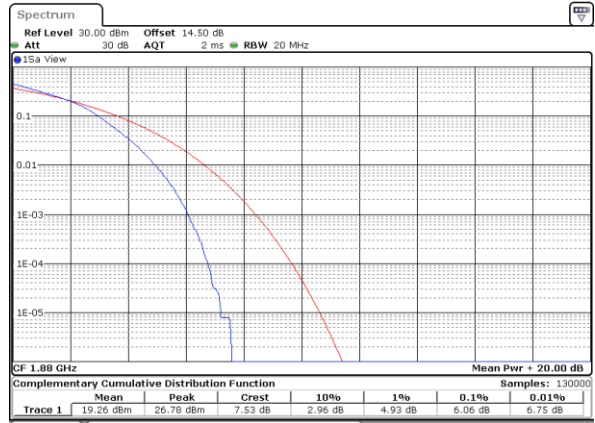

Date: 23.APR.2018 13:51:29

Highest Channel / 1RB

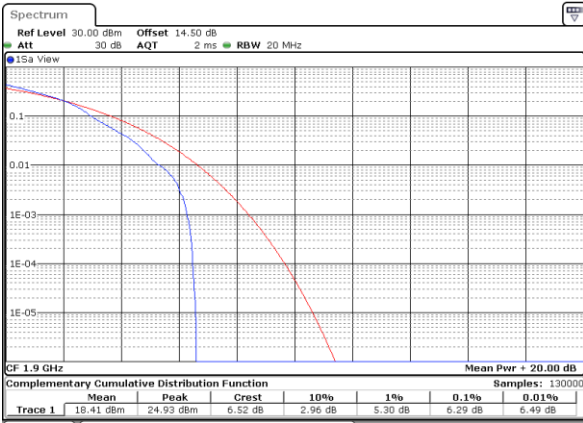

Date: 23.APR.2018 13:51:44

Highest Channel / Full RB

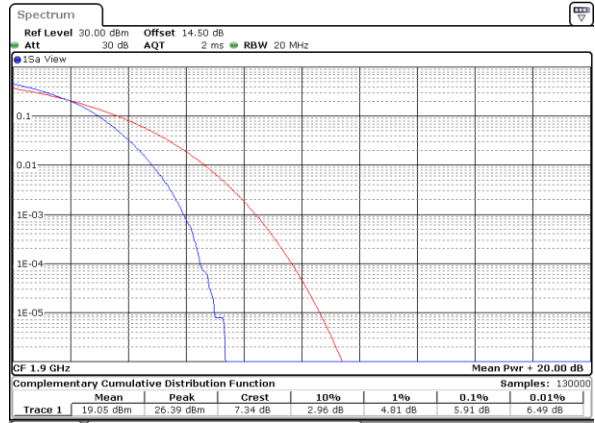

Date: 23.APR.2018 13:51:54



LTE Band 4 / 20MHz / QPSK

Lowest Channel / 1RB

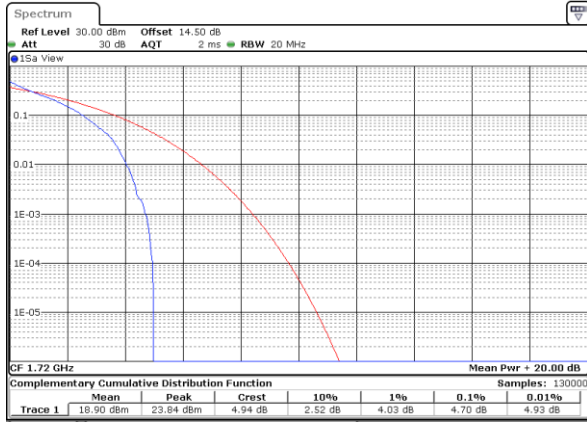

Date: 23.APR.2018 15:10:59

Lowest Channel / Full RB

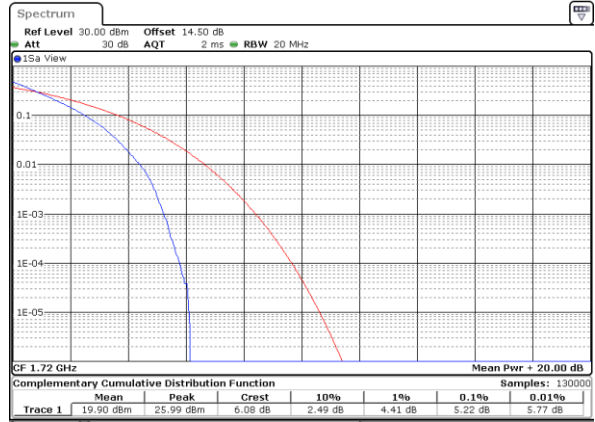

Date: 23.APR.2018 15:11:12

Middle Channel / 1RB

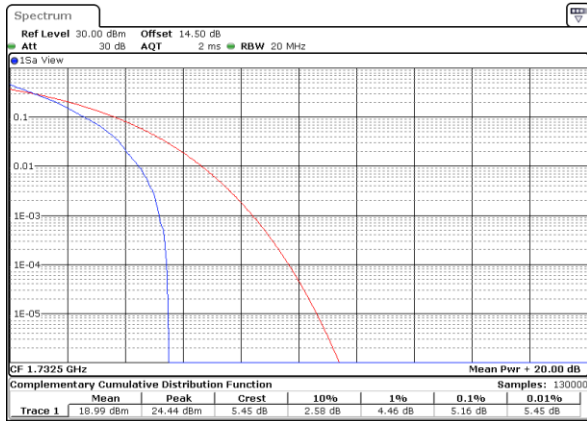

Date: 23.APR.2018 15:11:25

Middle Channel / Full RB

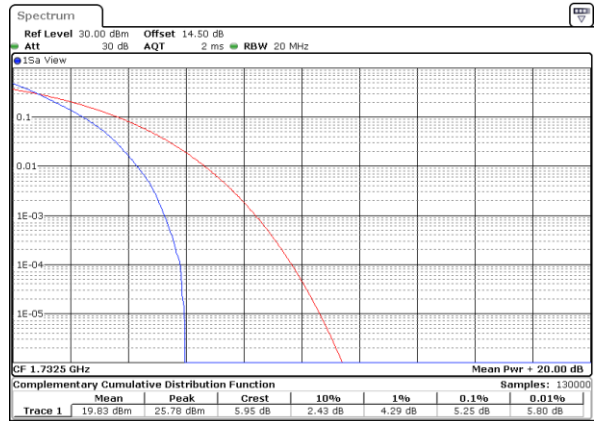

Date: 23.APR.2018 15:11:40

Highest Channel / 1RB



Date: 23.APR.2018 15:12:08

Highest Channel / Full RB



Date: 23.APR.2018 15:12:23



LTE Band 4 / 20MHz / 16QAM

Lowest Channel / 1RB

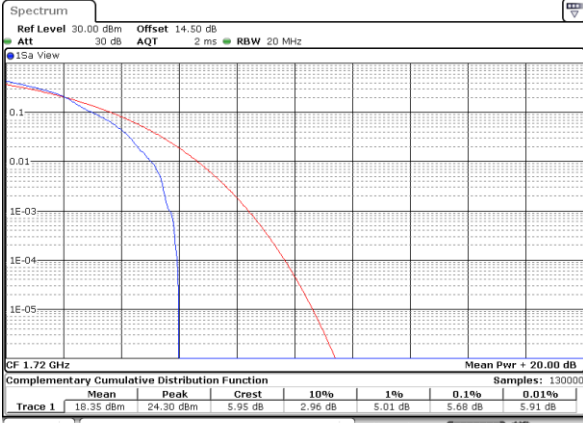

Date: 23.APR.2018 15:09:39

Lowest Channel / Full RB

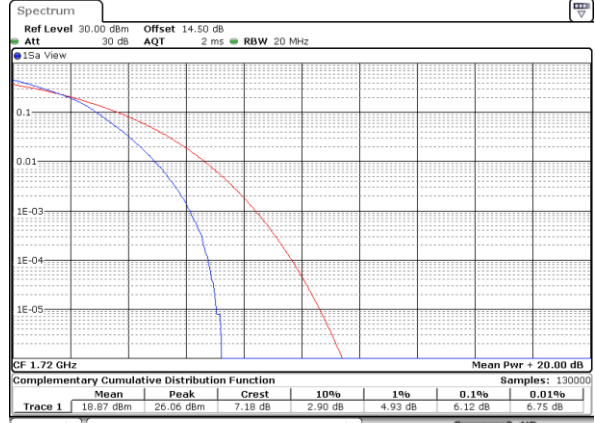

Date: 23.APR.2018 15:10:52

Middle Channel / 1RB

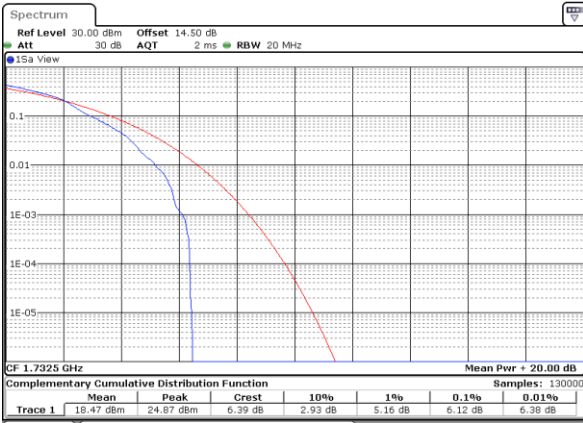

Date: 23.APR.2018 15:10:05

Middle Channel / Full RB

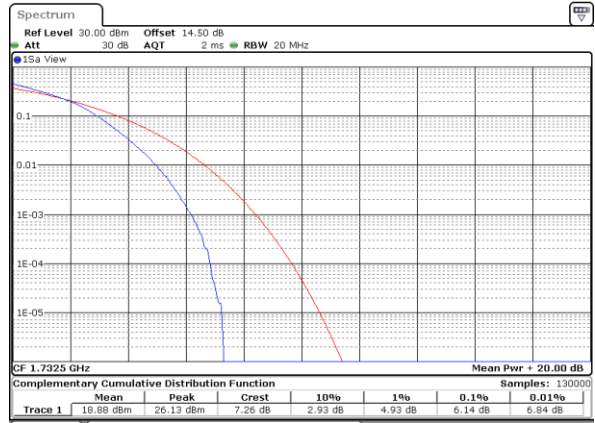

Date: 23.APR.2018 15:10:20

Highest Channel / 1RB

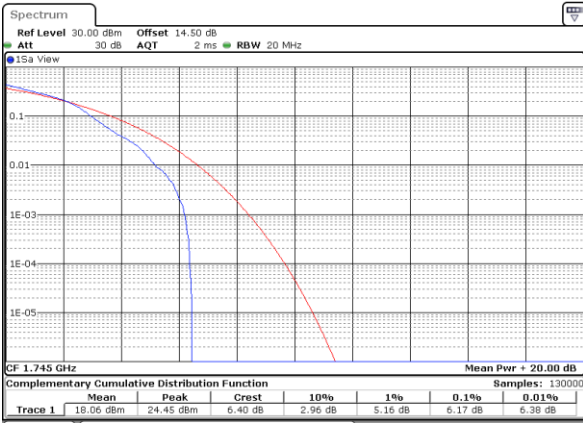

Date: 23.APR.2018 15:10:30

Highest Channel / Full RB

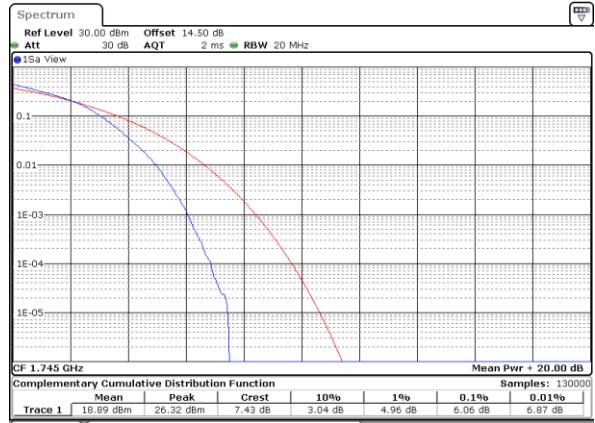

Date: 23.APR.2018 15:10:45



LTE Band 7 / 20MHz / QPSK

Lowest Channel / 1RB

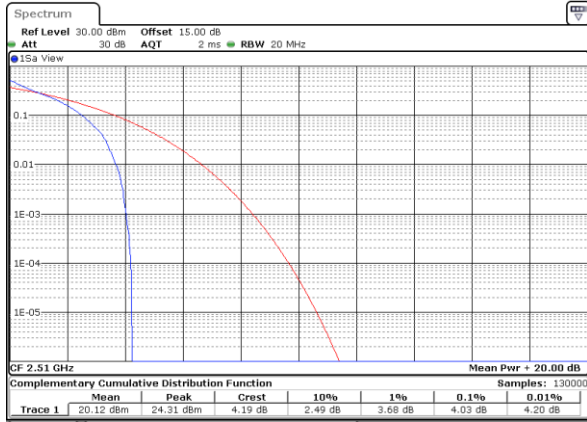

Date: 23.APR.2018 15:50:20

Lowest Channel / Full RB

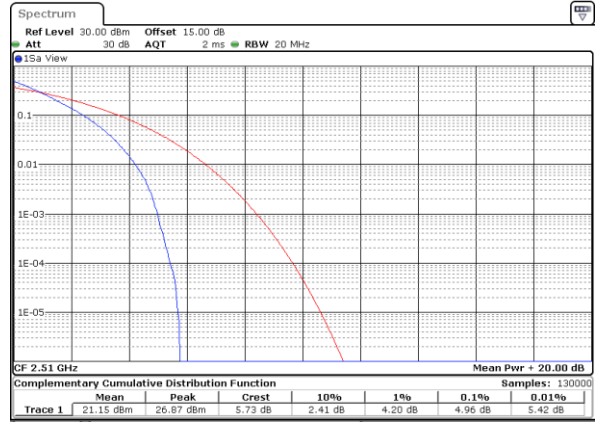

Date: 23.APR.2018 15:50:29

Middle Channel / 1RB

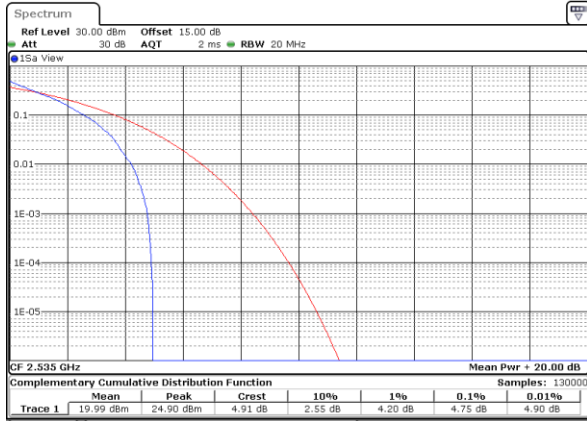

Date: 23.APR.2018 15:50:38

Middle Channel / Full RB

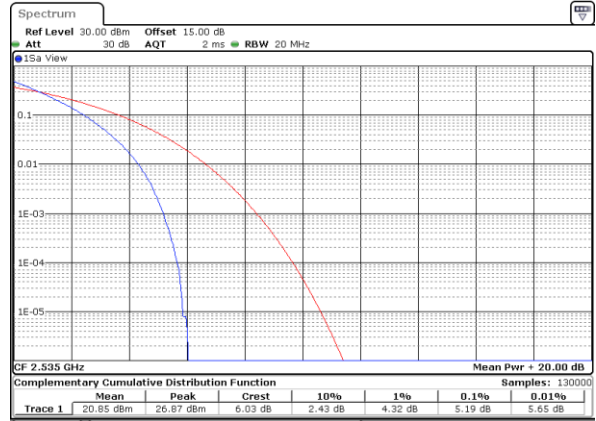

Date: 23.APR.2018 15:50:48

Highest Channel / 1RB

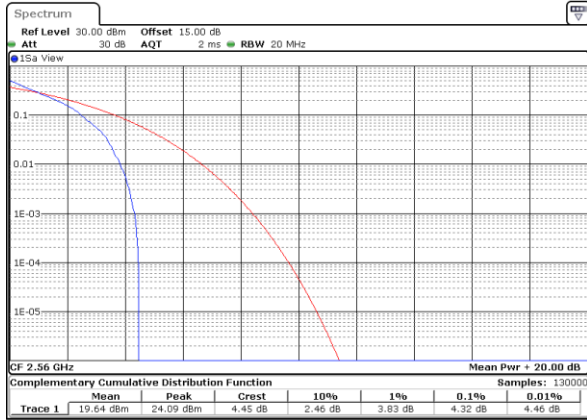

Date: 23.APR.2018 15:50:57

Highest Channel / Full RB

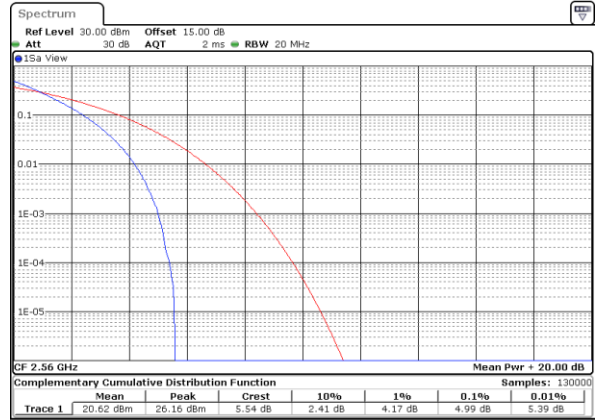

Date: 23.APR.2018 15:51:07



LTE Band 7 / 20MHz / 16QAM

Lowest Channel / 1RB

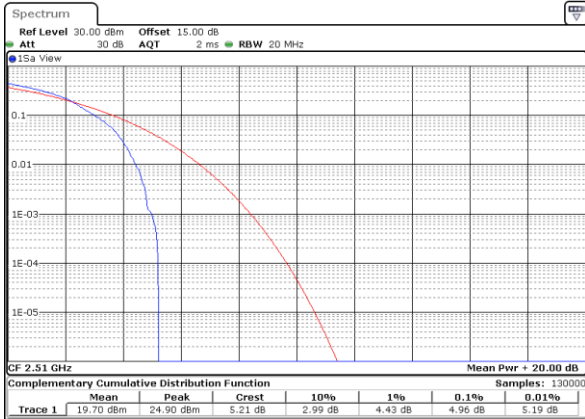

Date: 23.APR.2018 15:49:18

Lowest Channel / Full RB



Date: 23.APR.2018 15:49:28

Middle Channel / 1RB

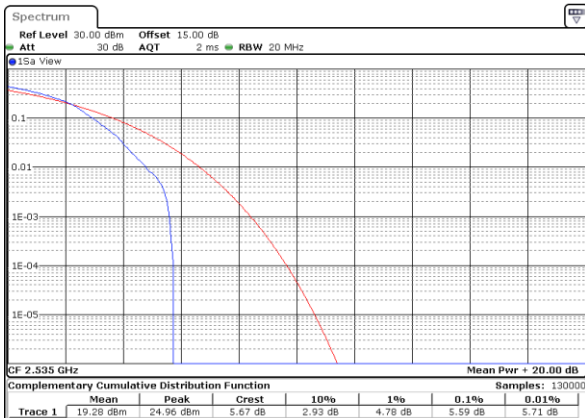

Date: 23.APR.2018 15:49:37

Middle Channel / Full RB

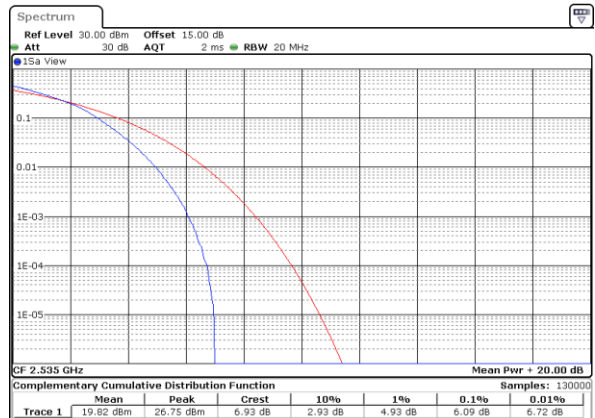

Date: 23.APR.2018 15:49:47

Highest Channel / 1RB



Date: 23.APR.2018 15:49:59

Highest Channel / Full RB



Date: 23.APR.2018 15:50:11



26dB Bandwidth

Mode	LTE Band 2 : 26dB BW(MHz)											
	1.4MHz		3MHz		5MHz		10MHz		15MHz		20MHz	
Mod.	QPSK	16QAM	QPSK	16QAM	QPSK	16QAM	QPSK	16QAM	QPSK	16QAM	QPSK	16QAM
Lowest CH	1.267	1.27	2.967	2.931	5.005	4.915	9.87	9.87	15.015	14.416	20.22	20.18
Middle CH	1.29	1.267	2.973	2.955	4.975	5.005	9.99	9.79	14.715	14.925	20.18	20.22
Highest CH	1.264	1.278	2.967	2.943	4.975	5.065	9.85	9.85	14.655	14.955	20.38	20.22

Mode	LTE Band 4 : 26dB BW(MHz)											
	1.4MHz		3MHz		5MHz		10MHz		15MHz		20MHz	
Mod.	QPSK	16QAM	QPSK	16QAM	QPSK	16QAM	QPSK	16QAM	QPSK	16QAM	QPSK	16QAM
Lowest CH	1.27	1.264	2.949	2.955	5.015	5.045	9.91	9.73	14.505	15.165	20.1	20.22
Middle CH	1.264	1.295	2.961	2.931	5.015	4.955	9.81	9.75	14.236	14.595	20.46	20.26
Highest CH	1.259	1.259	2.967	2.985	5.035	5.015	9.83	10.09	14.535	14.685	20.18	20.18

Mode	LTE Band 7 : 26dB BW(MHz)							
	5MHz		10MHz		15MHz		20MHz	
Mod.	QPSK	16QAM	QPSK	16QAM	QPSK	16QAM	QPSK	16QAM
Lowest CH	4.895	4.905	9.93	9.99	14.535	14.326	20.18	20.3
Middle CH	4.965	4.845	9.81	9.95	14.236	14.266	20.22	20.1
Highest CH	5.095	4.965	9.85	9.77	14.955	14.356	20.18	20.1



LTE Band 2

Lowest Channel / 1.4MHz / QPSK

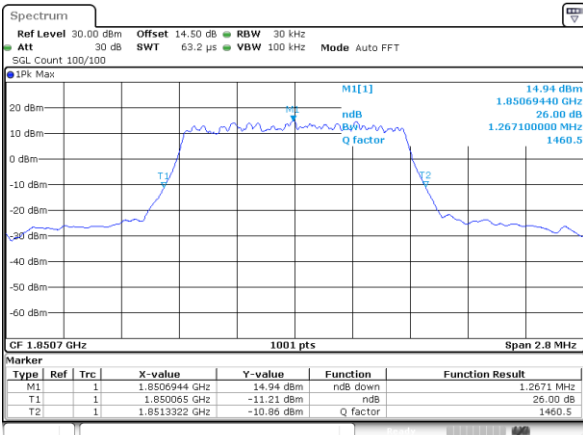

Date: 23.APR.2018 11:35:36

Lowest Channel / 1.4MHz / 16QAM

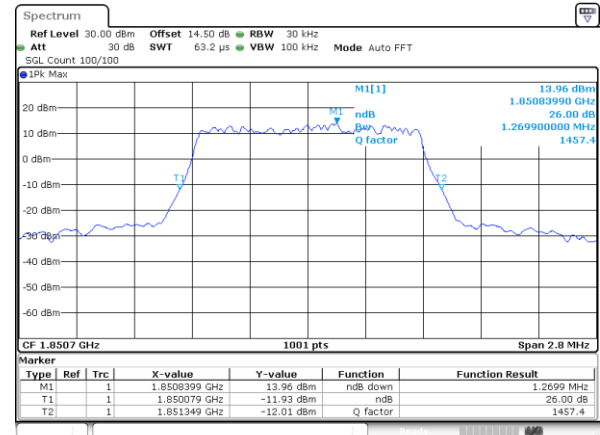

Date: 23.APR.2018 11:35:46

Middle Channel / 1.4MHz / QPSK

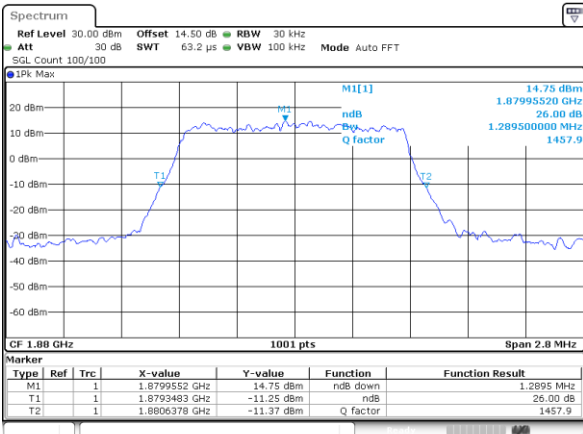

Date: 23.APR.2018 11:38:07

Middle Channel / 1.4MHz / 16QAM

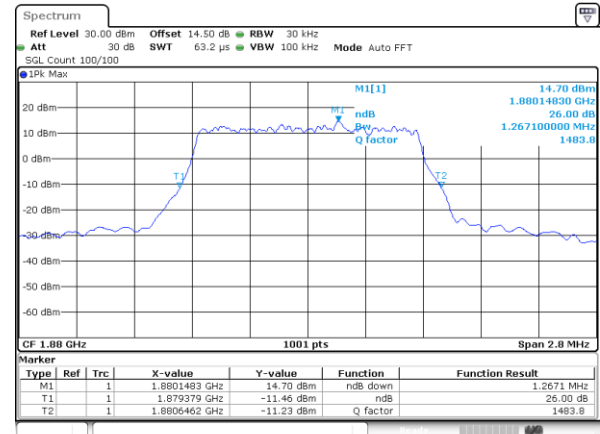

Date: 23.APR.2018 11:38:17

Highest Channel / 1.4MHz / QPSK

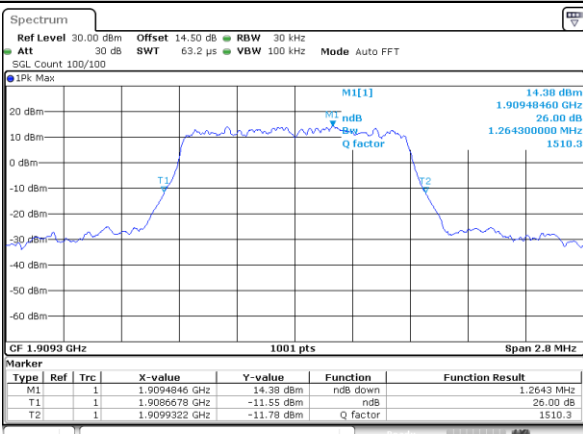

Date: 23.APR.2018 11:40:39

Highest Channel / 1.4MHz / 16QAM

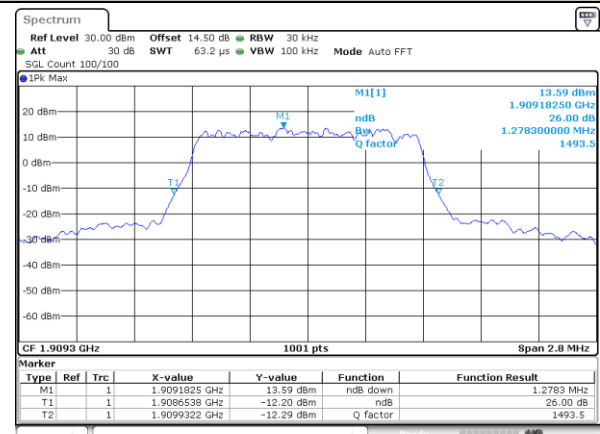

Date: 23.APR.2018 11:40:48



LTE Band 2

Lowest Channel / 3MHz / QPSK

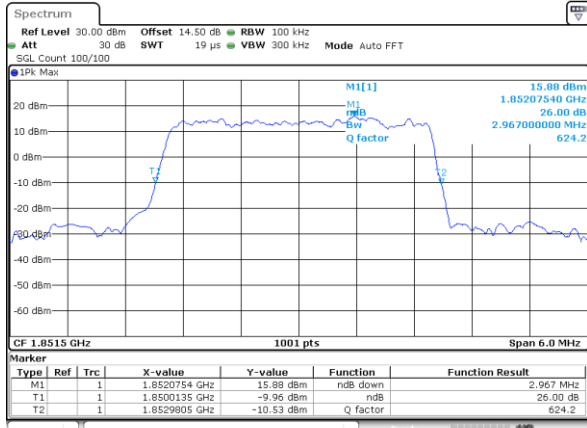

Date: 23.APR.2018 11:43:10

Lowest Channel / 3MHz / 16QAM

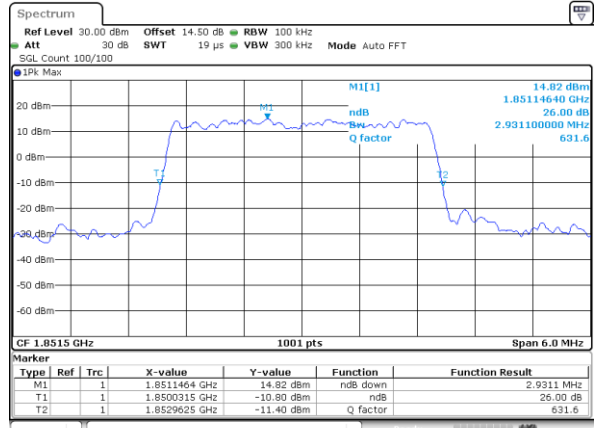

Date: 23.APR.2018 11:43:20

Middle Channel / 3MHz / QPSK

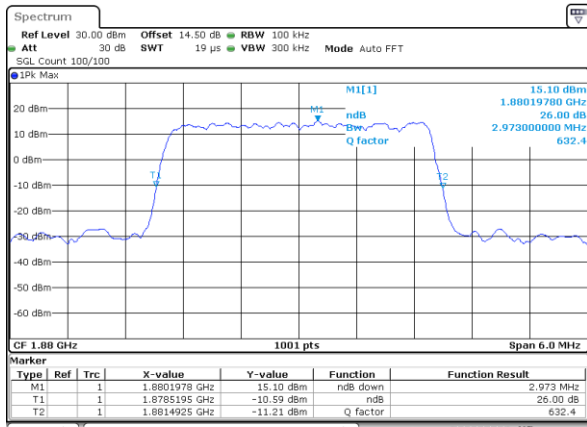

Date: 23.APR.2018 11:45:43

Middle Channel / 3MHz / 16QAM

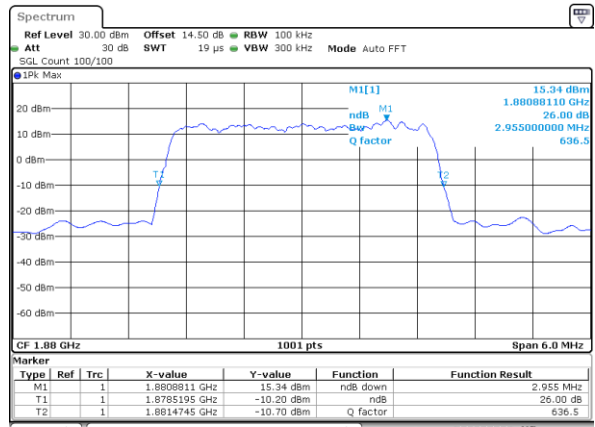

Date: 23.APR.2018 11:45:53

Highest Channel / 3MHz / QPSK

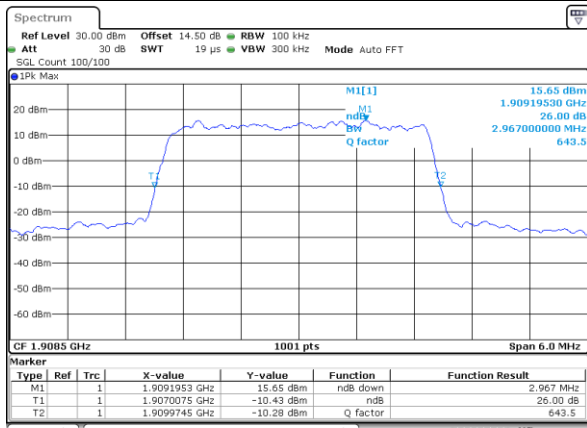

Date: 23.APR.2018 11:48:16

Highest Channel / 3MHz / 16QAM

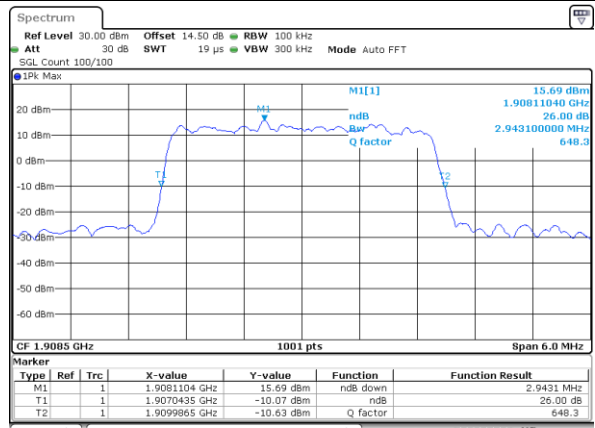

Date: 23.APR.2018 11:48:26



LTE Band 2

Lowest Channel / 5MHz / QPSK

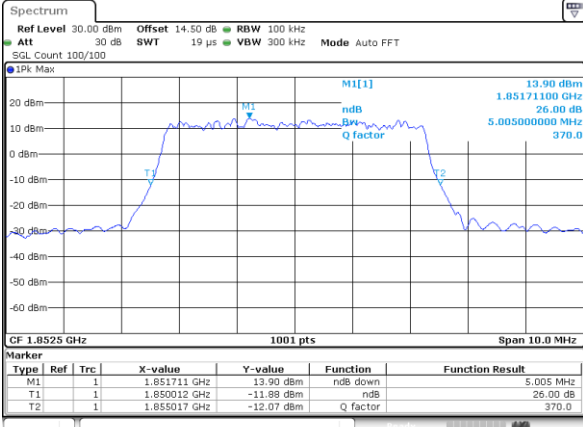

Date: 23.APR.2018 11:50:49

Lowest Channel / 5MHz / 16QAM

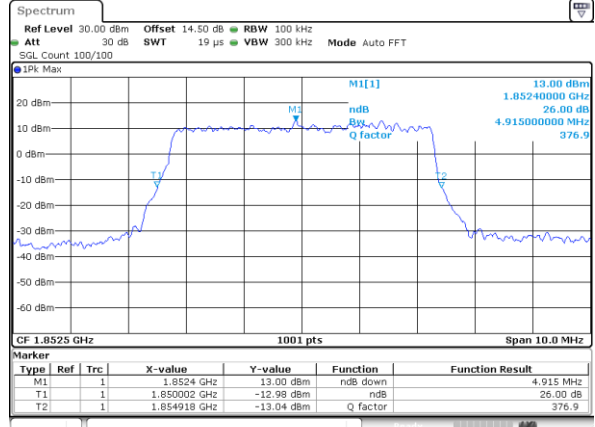

Date: 23.APR.2018 11:50:59

Middle Channel / 5MHz / QPSK

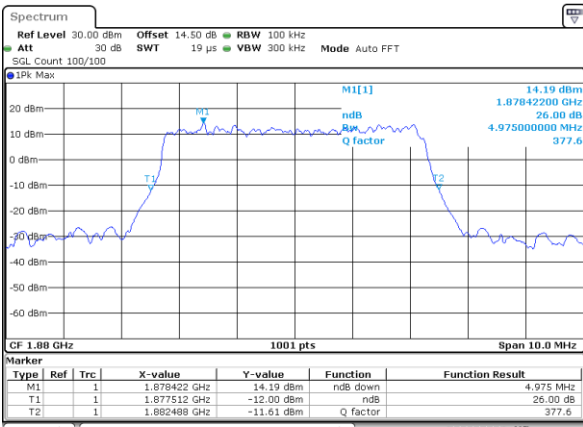

Date: 23.APR.2018 11:53:21

Middle Channel / 5MHz / 16QAM

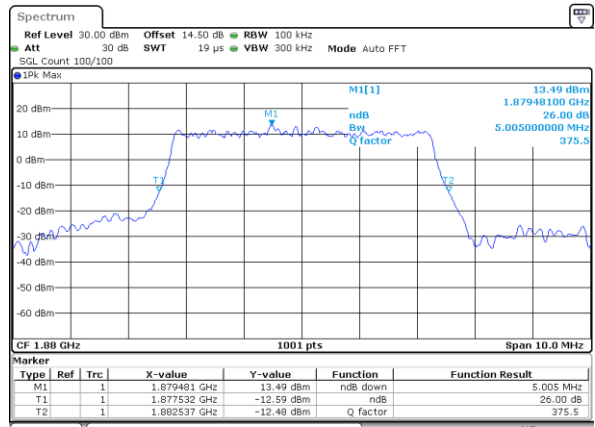

Date: 23.APR.2018 11:53:32

Highest Channel / 5MHz / QPSK

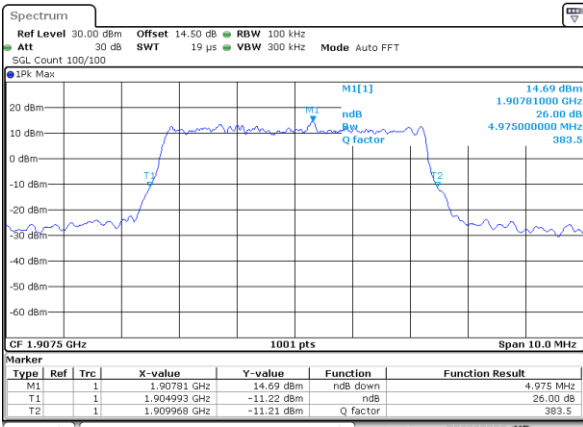

Date: 23.APR.2018 11:55:54

Highest Channel / 5MHz / 16QAM

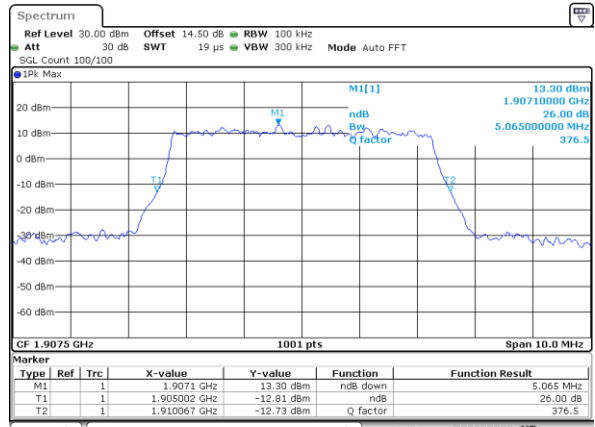

Date: 23.APR.2018 11:56:05



LTE Band 2

Lowest Channel / 10MHz / QPSK

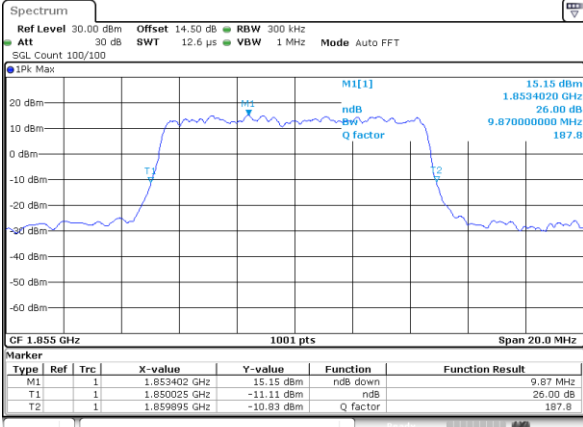

Date: 23.APR.2018 11:58:20

Lowest Channel / 10MHz / 16QAM

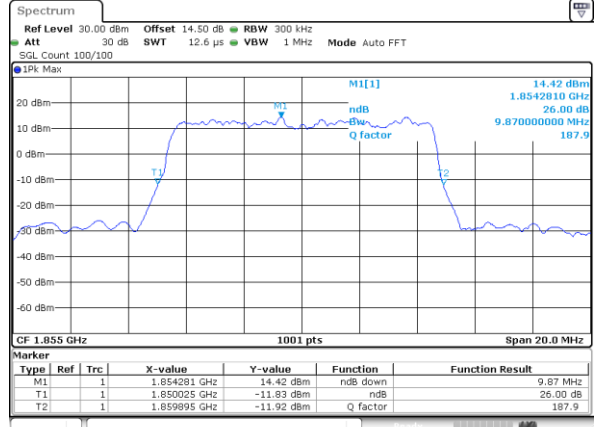

Date: 23.APR.2018 11:58:38

Middle Channel / 10MHz / QPSK

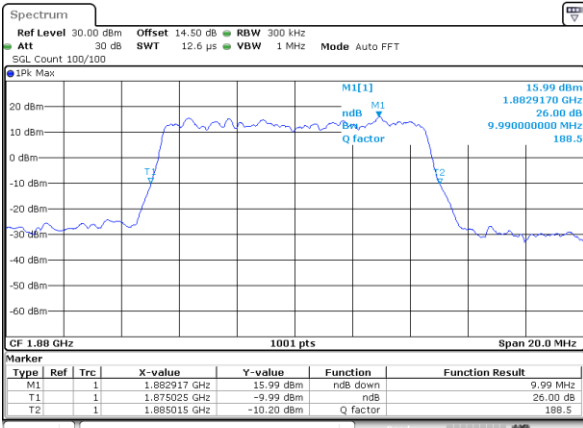

Date: 23.APR.2018 12:01:00

Middle Channel / 10MHz / 16QAM

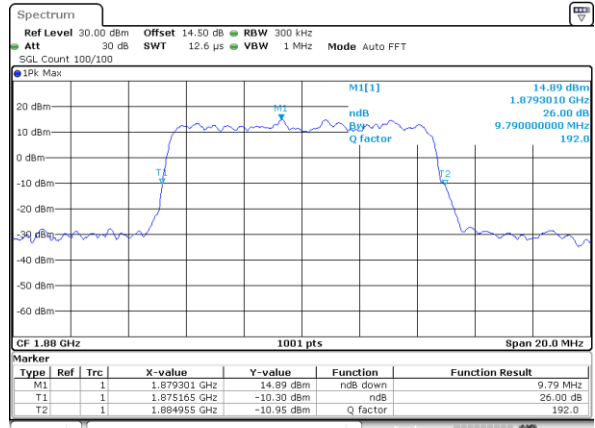

Date: 23.APR.2018 12:01:10

Highest Channel / 10MHz / QPSK

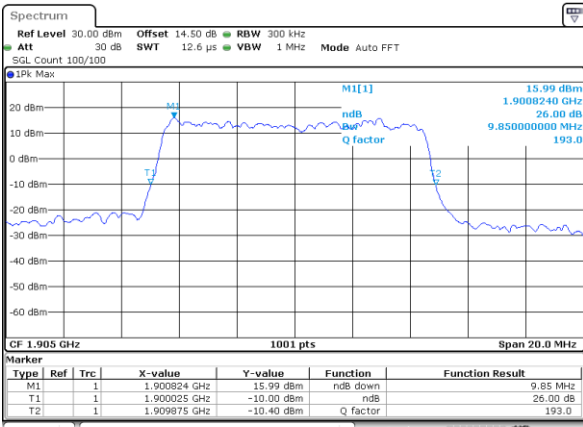

Date: 23.APR.2018 12:03:32

Highest Channel / 10MHz / 16QAM

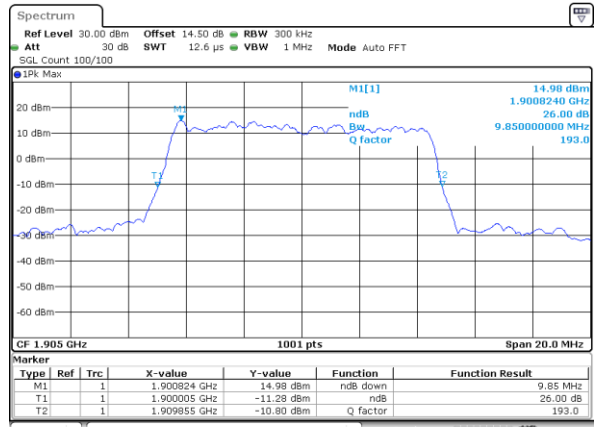

Date: 23.APR.2018 12:03:42



LTE Band 2

Lowest Channel / 15MHz / QPSK

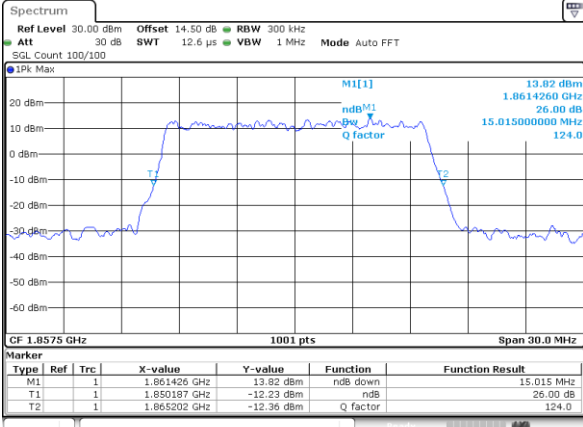

Date: 23.APR.2018 12:10:08

Lowest Channel / 15MHz / 16QAM

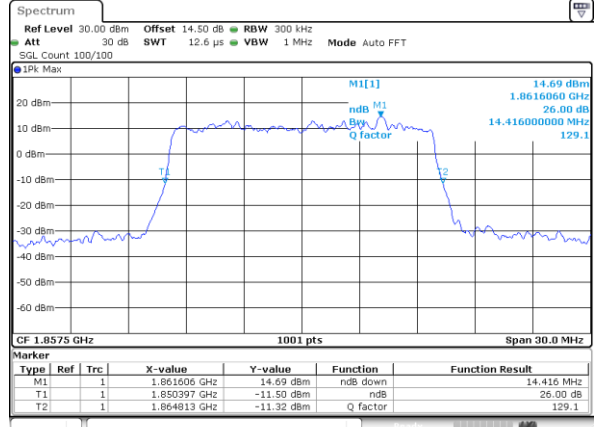

Date: 23.APR.2018 12:10:19

Middle Channel / 15MHz / QPSK

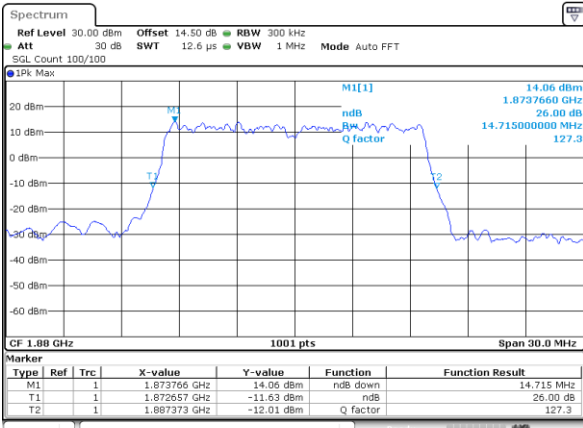

Date: 23.APR.2018 12:10:44

Middle Channel / 15MHz / 16QAM

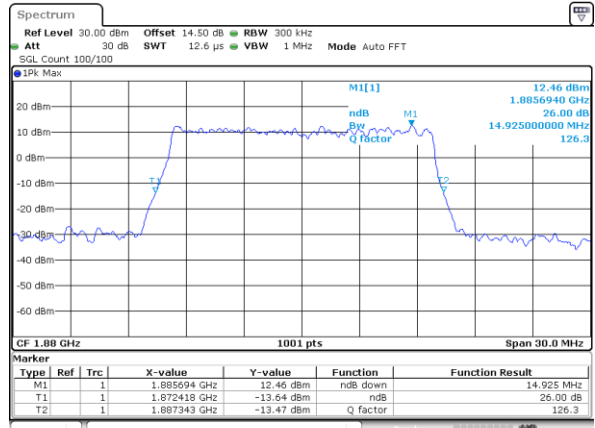

Date: 23.APR.2018 12:10:54

Highest Channel / 15MHz / QPSK

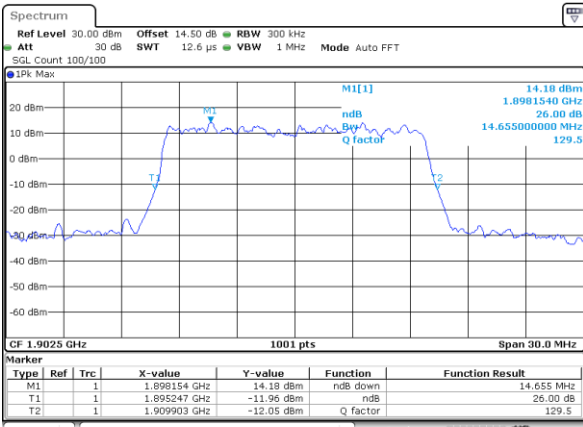

Date: 23.APR.2018 12:11:17

Highest Channel / 15MHz / 16QAM

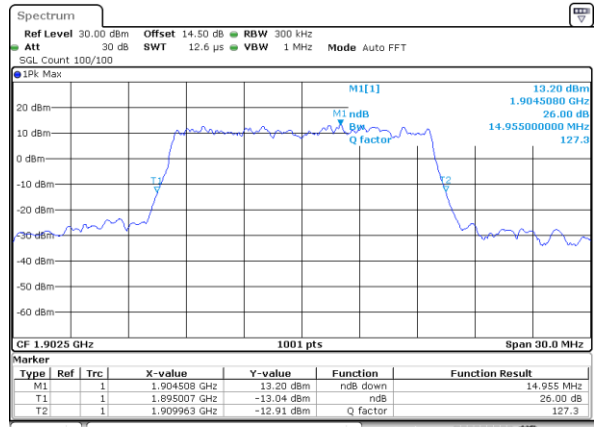

Date: 23.APR.2018 12:11:27



LTE Band 2

Lowest Channel / 20MHz / QPSK

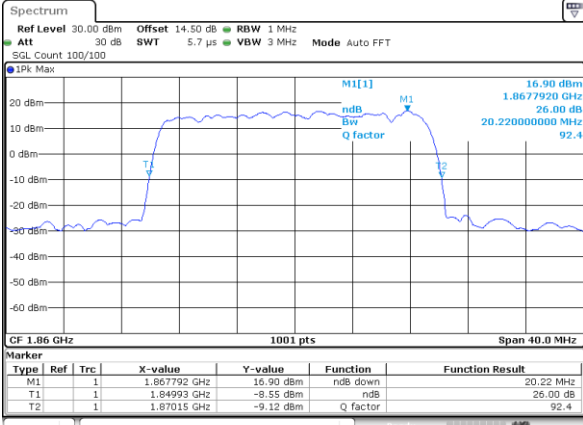

Date: 23.APR.2018 12:13:50

Lowest Channel / 20MHz / 16QAM

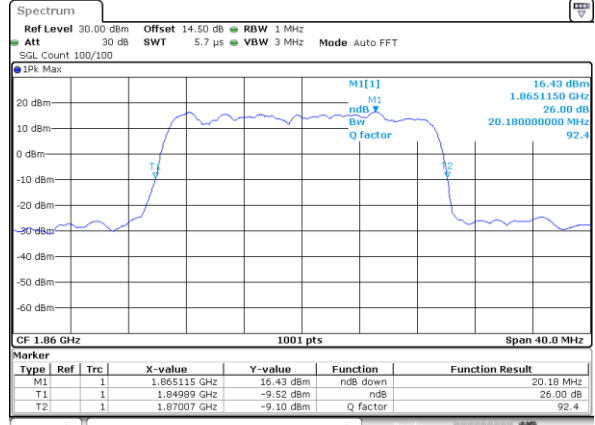

Date: 23.APR.2018 12:14:01

Middle Channel / 20MHz / QPSK

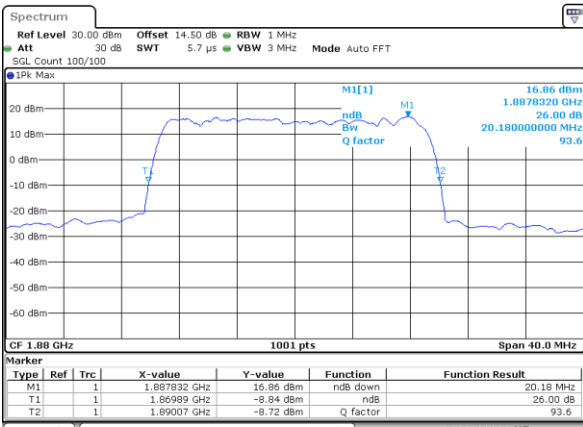

Date: 23.APR.2018 13:45:55

Middle Channel / 20MHz / 16QAM

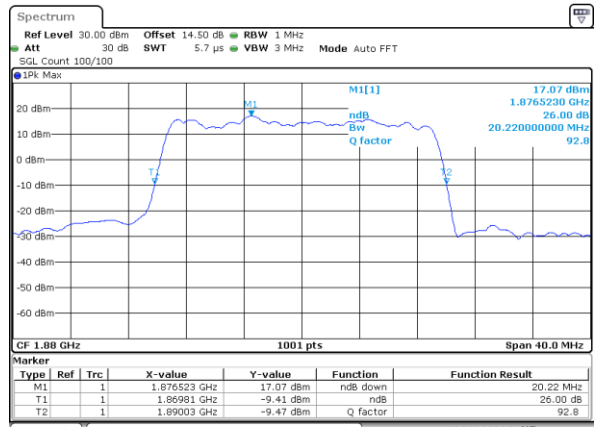

Date: 23.APR.2018 13:46:05

Highest Channel / 20MHz / QPSK

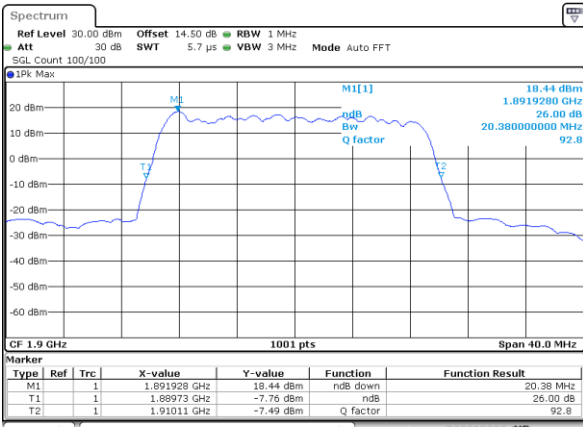

Date: 23.APR.2018 13:48:28

Highest Channel / 20MHz / 16QAM

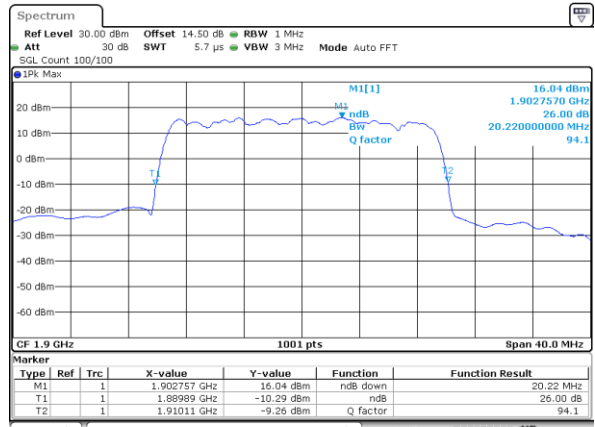

Date: 23.APR.2018 13:48:38



LTE Band 4

Lowest Channel / 1.4MHz / QPSK

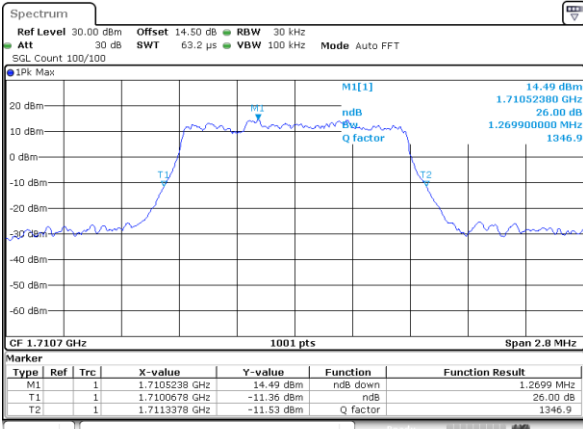

Date: 23.APR.2018 14:02:40

Lowest Channel / 1.4MHz / 16QAM

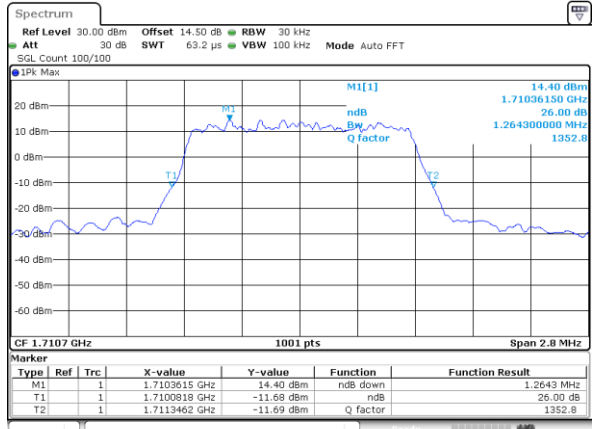

Date: 23.APR.2018 14:02:50

Middle Channel / 1.4MHz / QPSK

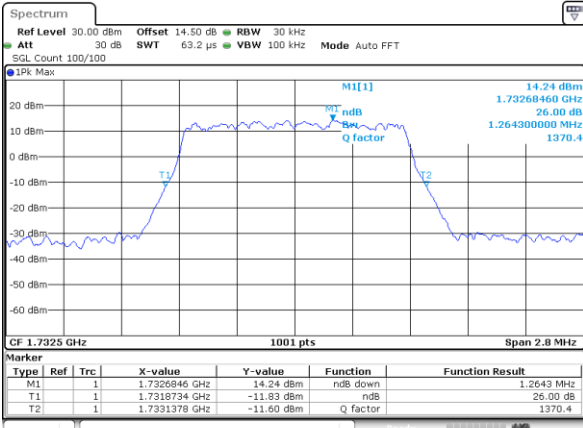

Date: 23.APR.2018 14:06:43

Middle Channel / 1.4MHz / 16QAM

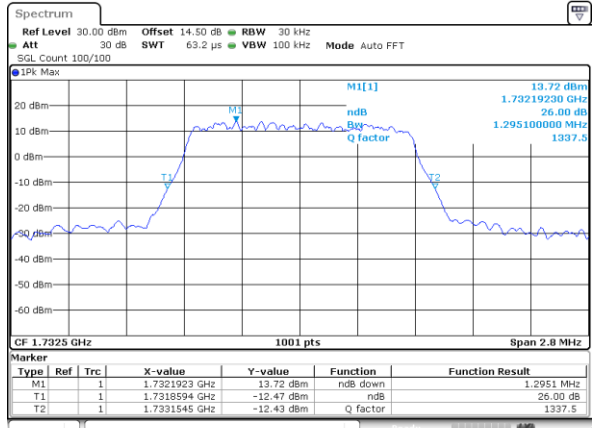

Date: 23.APR.2018 14:06:53

Highest Channel / 1.4MHz / QPSK

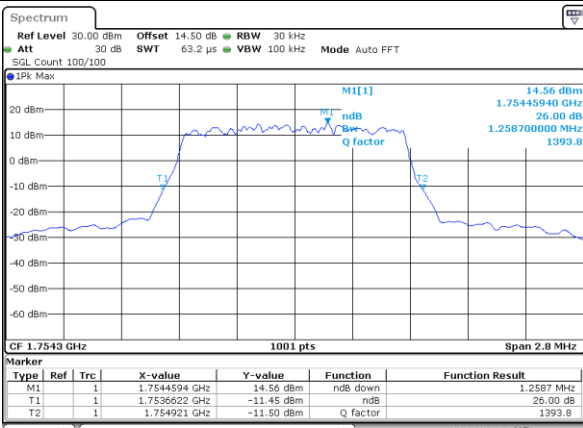

Date: 23.APR.2018 14:27:09

Highest Channel / 1.4MHz / 16QAM

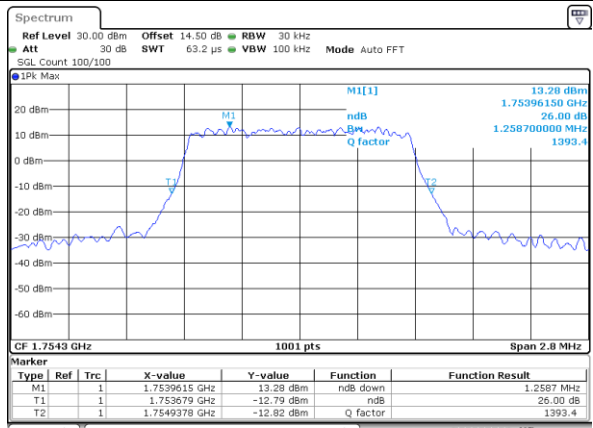

Date: 23.APR.2018 14:27:19



LTE Band 4

Lowest Channel / 3MHz / QPSK

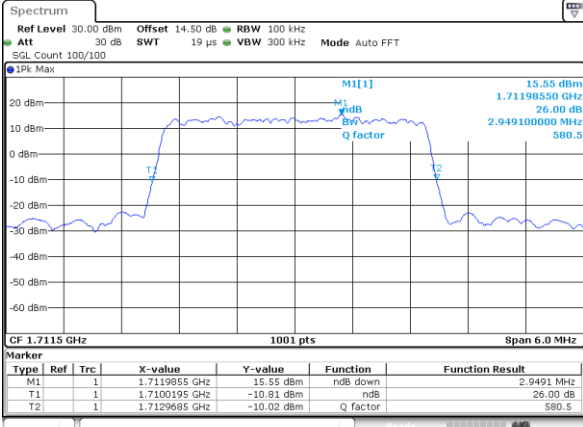

Date: 23.APR.2018 14:29:42

Lowest Channel / 3MHz / 16QAM

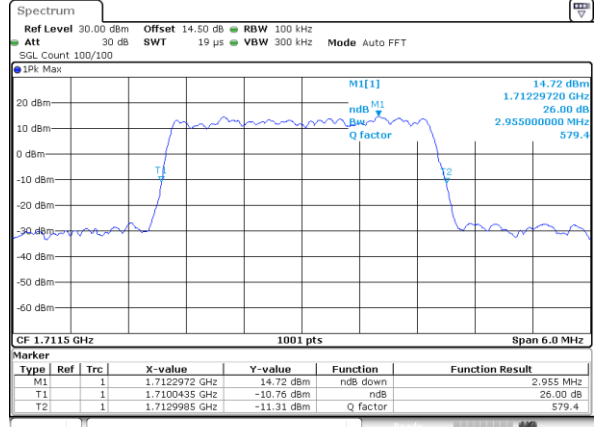

Date: 23.APR.2018 14:29:52

Middle Channel / 3MHz / QPSK

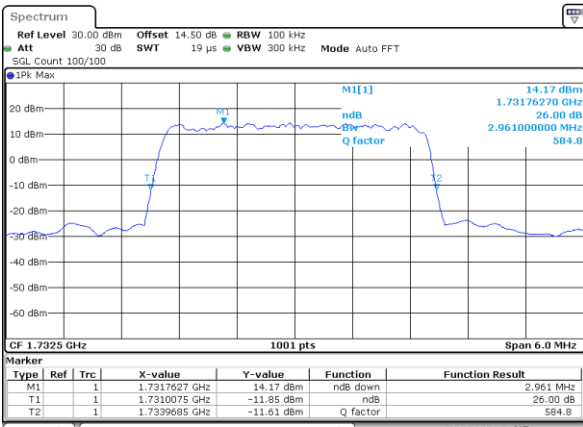

Date: 23.APR.2018 14:32:15

Middle Channel / 3MHz / 16QAM

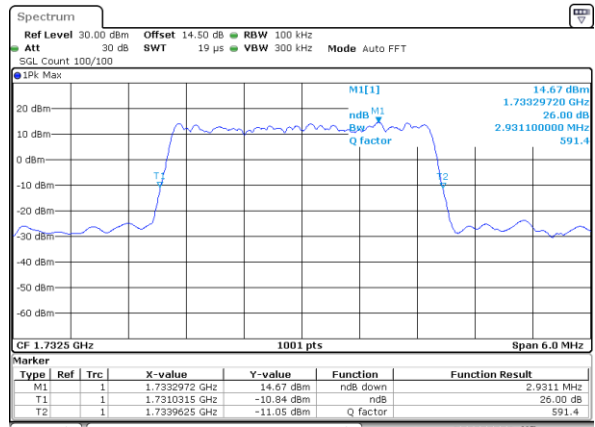

Date: 23.APR.2018 14:32:25

Highest Channel / 3MHz / QPSK

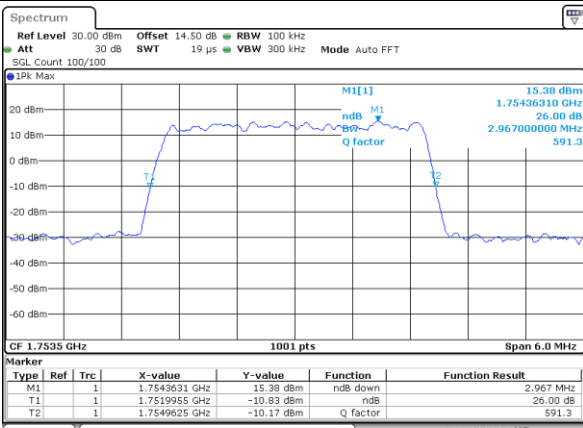

Date: 23.APR.2018 14:34:47

Highest Channel / 3MHz / 16QAM

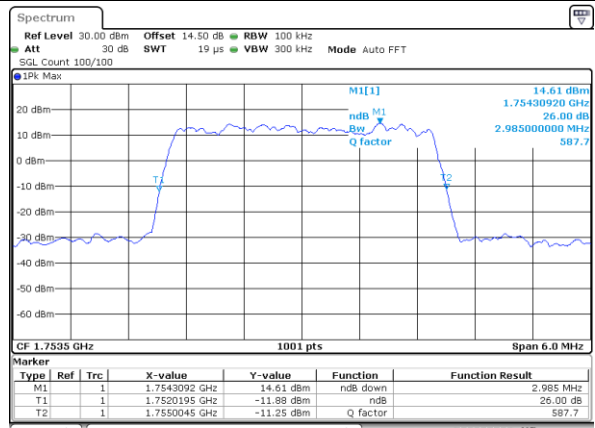

Date: 23.APR.2018 14:34:57



LTE Band 4

Lowest Channel / 5MHz / QPSK

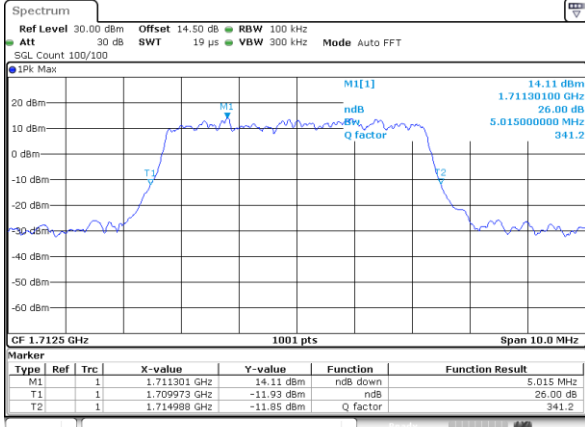

Date: 23.APR.2018 14:37:21

Lowest Channel / 5MHz / 16QAM

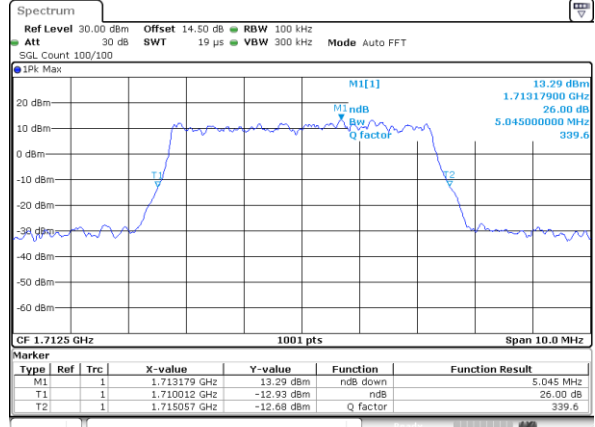

Date: 23.APR.2018 14:37:31

Middle Channel / 5MHz / QPSK

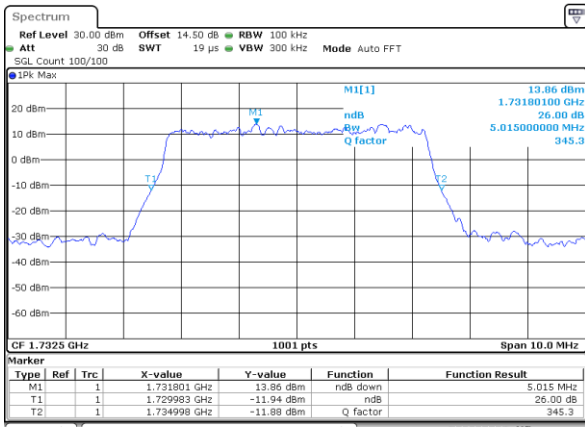

Date: 23.APR.2018 14:39:54

Middle Channel / 5MHz / 16QAM

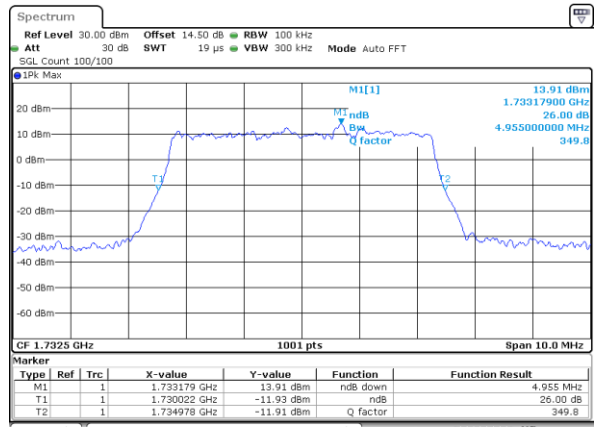

Date: 23.APR.2018 14:40:04

Highest Channel / 5MHz / QPSK

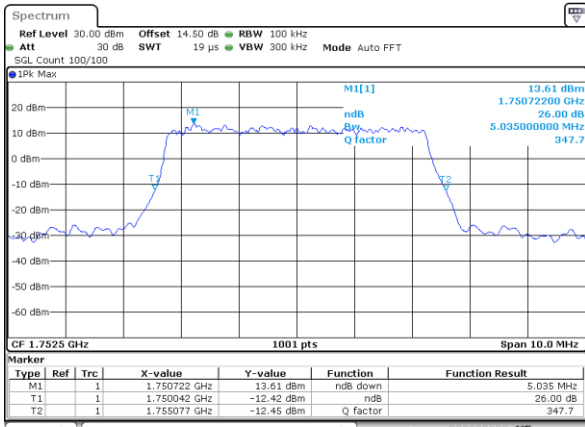

Date: 23.APR.2018 14:42:26

Highest Channel / 5MHz / 16QAM

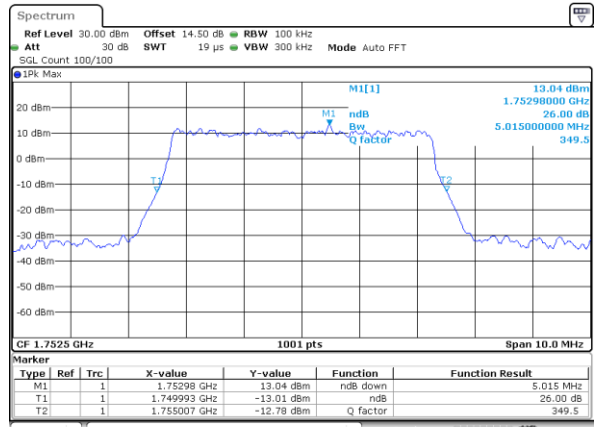

Date: 23.APR.2018 14:42:36



LTE Band 4

Lowest Channel / 10MHz / QPSK

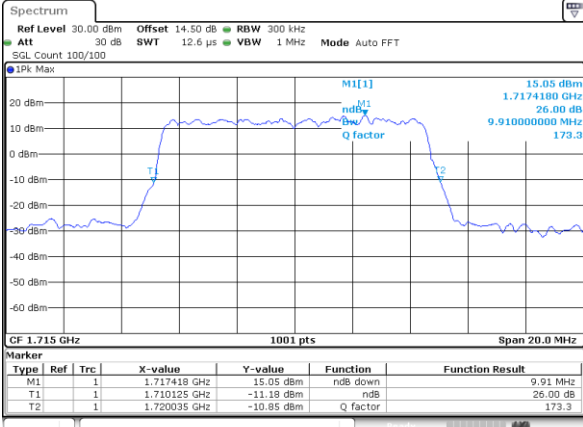

Date: 23.APR.2018 14:44:59

Lowest Channel / 10MHz / 16QAM

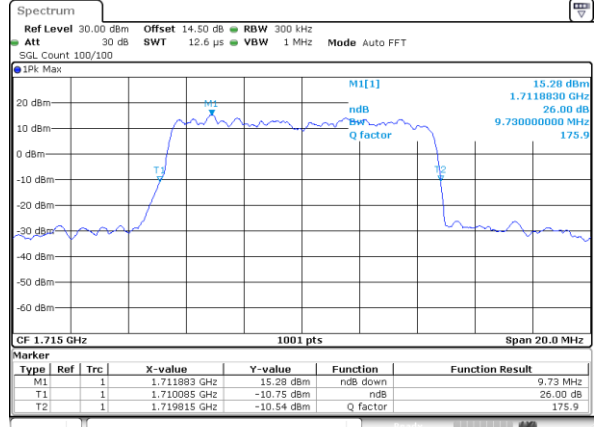

Date: 23.APR.2018 14:45:09

Middle Channel / 10MHz / QPSK

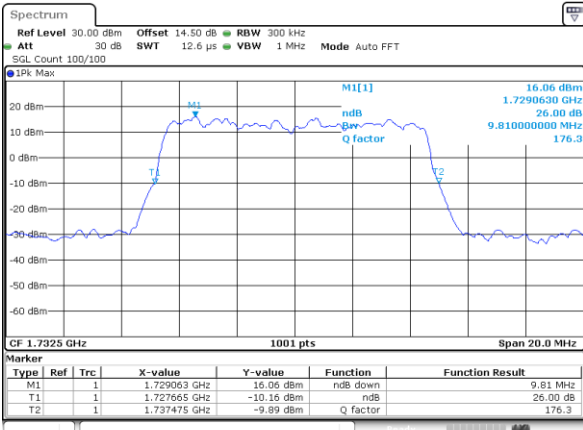

Date: 23.APR.2018 14:47:33

Middle Channel / 10MHz / 16QAM

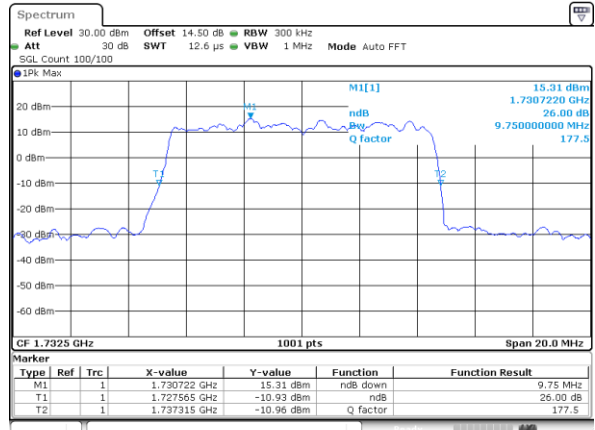

Date: 23.APR.2018 14:47:43

Highest Channel / 10MHz / QPSK

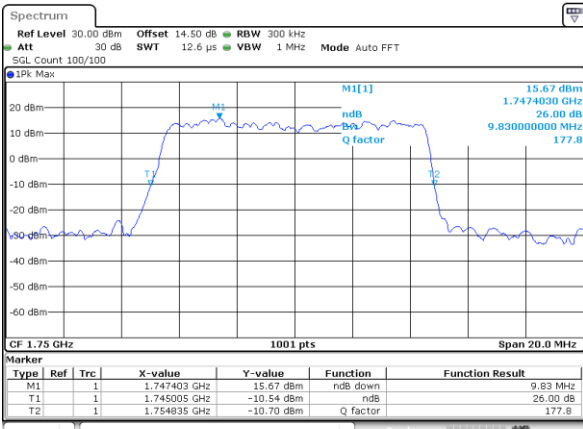

Date: 23.APR.2018 14:50:06

Highest Channel / 10MHz / 16QAM

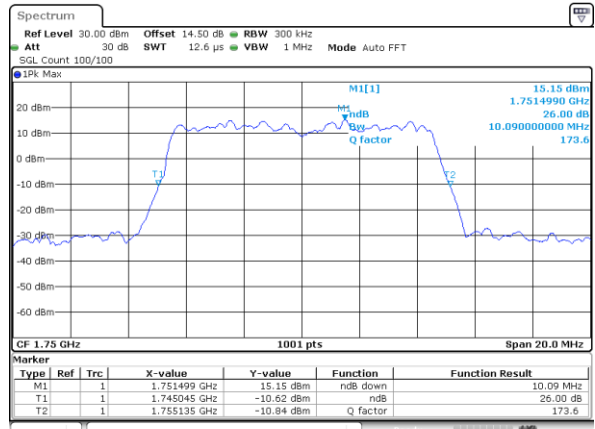

Date: 23.APR.2018 14:50:16