

DFS Report

Application Purpose : Original grant

Applicant Name: : INFINIX MOBILITY LIMITED

FCC ID : 2AIZN-X602

Equipment Type : Mobile phone

Model Name : X602

Report Number : FCC16093968A-8

Standard(S) : FCC Part 15 Subpart E

Date Of Receipt : September 05, 2016

Date Of Issue : October 19, 2016

Test By : 

(Daisy Qin)

Reviewed By : 

(Sol Qin)

Authorized by : 

(Michal Ling)

Prepared by : **QTC Certification & Testing Co., Ltd.**
2nd Floor,B1 Buiding,Fengyeyuan Industrial Plant,,Liuxian
2st.Road,Xin'an Street,Bao'an District,,Shenzhen,
518000China.
Registration Number: 588523

REPORT REVISE RECORD

Report Version	Revise Time	Issued Date	Valid Version	Notes
V1.0	/	October 19, 2016	Valid	Original Report

Table of Contents	Page
1. GENERAL INFORMATION	4
2. TEST DESCRIPTION	5
2.1 MEASUREMENT UNCERTAINTY	5
2.2 DFS OVERVIEW	6
2.3 DFS DETECTION THRESHOLDS	7
2.4 RESPONSE REQUIREMENTS	7
2.5 RADAR TEST WAVEFORMS	8
2.6 LONG PULSE RADAR TEST WAVEFORM	10
2.7 FREQUENCY HOPPING RADAR TEST WAVEFORM	12
3. SUMMARY OF TEST RESULTS	13
4. MEASUREMENT INSTRUMENTS	14
DESCRIPTION OF SUPPORT UNITS	14
5. TEST PROCEDURE	15
5.1 DFS MEASUREMENT SYSTEM	15
5.2 CALIBRATION OF DFS DETECTION THRESHOLD LEVEL	15
6. TEST RESULTS	17
6.1 PLOTS OF RADAR WAVEFORM, AND WLAN TRAFFIC	17
6.2 IN-SERVICE MONITORING FOR CHANNEL MOVE TIME, CHANNEL CLOSING TRANSMISSION TIME	21

1. GENERAL INFORMATION

GENERAL DESCRIPTION OF EUT

Test Model	X602
Applicant	INFINIX MOBILITY LIMITED
Address	RMS 05-15, 13A/F SOUTH TOWER WORLD FINANCE CTR HARBOUR CITY 17 CANTON RD TST KLN HONG KONG
Manufacturer	SHENZHEN TECNO TECHNOLOGY CO.,LTD.
Address	1-4th Floor,3rd Building,Pacific Industrial Park,No.2088,Shenyang Road,Yantian District,Shenzhen,Guangdong,China
Equipment Type	Mobile phone
Brand Name	Infinix
Hardware version:	V1.1_B1-BOM
Software version:	X602-H972B1-M-160823V7
Extreme Temp. Tolerance	-10°C to +65°C
Battery information:	Li-Polymer Battery : BL-40FX Voltage: 3.85V Capacity: 4000mAh Limited Charge Voltage: 4.4V
Adapter Information:	Adapter: CQ-18KX Input: 100-240V 50/60Hz 600mA Output: 5V-6V 3A Output: 6V-9V 2A Output: 9V-12V 1.5A
Operating Frequency	see the below table
Channels	see the below table
Channel Spacing	see the below table
Modulation Type	see the below table
Antenna Type:	PIFA Antenna
Antenna gain:	-4dBi
Data of receipt	September 05, 2016
Date of test	September 05, 2016 to October 19 , 2016
Deviation	None
Condition of Test Sample	Normal

2. TEST DESCRIPTION

2.1 MEASUREMENT UNCERTAINTY

The reported uncertainty of measurement $y \pm U$, where expanded uncertainty U is based on a standard uncertainty multiplied by a coverage factor of $k=2$, providing a level of confidence of approximately **95** %.

No.	Item	Uncertainty
1	Timing (Channel move time, aggregate transmission time)	$\pm 0.24\%$
2	Timing (non occupancy period)	± 5 seconds
3	DFS Threshold (radiated)	± 1.6 dBm
4	DFS Threshold (conducted)	± 1.2 dBm

2.2 DFS OVERVIEW

A U-NII network will employ a DFS function to detect signals from radar systems and to avoid co-channel operation with these systems. This applies to the 5250-5350 MHz and/or 5470-5725 MHz bands.

Within the context of the operation of the DFS function, a U-NII device will operate in either *Master Mode* or *Client Mode*. U-NII devices operating in *Client Mode* can only operate in a network controlled by a U-NII device operating in *Master Mode*.

Tables 1 and 2 shown below summarize the information contained in sections 5.1.1 and 5.1.2

Table 1: Applicability of DFS Requirements Prior to Use of a Channel

Requirement	Operational Mode		
	Master	Client Without Radar Detection	Client With Radar Detection
<i>Non-Occupancy Period</i>	Yes	Not required	Yes
<i>DFS Detection Threshold</i>	Yes	Not required	Yes
<i>Channel Availability Check Time</i>	Yes	Not required	Not required
<i>U-NII Detection Bandwidth</i>	Yes	Not required	Yes

Table 2: Applicability of DFS requirements during normal operation

Requirement	Operational Mode	
	Master Device or Client with Radar Detection	Client Without Radar Detection
<i>DFS Detection Threshold</i>	Yes	Not required
<i>Channel Closing Transmission Time</i>	Yes	Yes
<i>Channel Move Time</i>	Yes	Yes
<i>U-NII Detection Bandwidth</i>	Yes	Not required

Additional requirements for devices with multiple bandwidth modes	Master Device or Client with Radar Detection	Client Without Radar Detection
<i>U-NII Detection Bandwidth and Statistical Performance Check</i>	All BW modes must be tested	Not required
<i>Channel Move Time and Channel Closing Transmission Time</i>	Test using widest BW mode available	Test using the widest BW mode available for the link
<i>All other tests</i>	Any single BW mode	Not required
Note: Frequencies selected for statistical performance check (Section 7.8.4) should include several frequencies within the radar detection bandwidth and frequencies near the edge of the radar detection bandwidth. For 802.11 devices it is suggested to select frequencies in each of the bonded 20 MHz channels and the channel center frequency.		

The operational behavior and individual DFS requirements that are associated with these modes are as follows:

2.3 DFS DETECTION THRESHOLDS

Table 3 below provides the *DFS Detection Thresholds* for *Master Devices* as well as *Client Devices* incorporating *In-Service Monitoring*.

Table 3: DFS Detection Thresholds for Master Devices and Client Devices with Radar Detection

Maximum Transmit Power	Value (See Notes 1, 2, and 3)
EIRP \geq 200 milliwatt	-64 dBm
EIRP < 200 milliwatt and power spectral density < 10 dBm/MHz	-62 dBm
EIRP < 200 milliwatt that do not meet the power spectral density requirement	-64 dBm
<p>Note 1: This is the level at the input of the receiver assuming a 0 dBi receive antenna.</p> <p>Note 2: Throughout these test procedures an additional 1 dB has been added to the amplitude of the test transmission waveforms to account for variations in measurement equipment. This will ensure that the test signal is at or above the detection threshold level to trigger a DFS response.</p> <p>Note 3: EIRP is based on the highest antenna gain. For MIMO devices refer to KDB Publication 662911 D01.</p>	

2.4 RESPONSE REQUIREMENTS

Table 4 provides the response requirements for *Master* and *Client Devices* incorporating DFS.

Table 4: DFS Response Requirement Values

Parameter	Value
<i>Non-occupancy period</i>	Minimum 30 minutes
<i>Channel Availability Check Time</i>	60 seconds
<i>Channel Move Time</i>	10 seconds See Note 1.
<i>Channel Closing Transmission Time</i>	200 milliseconds + an aggregate of 60 milliseconds over remaining 10 second period. See Notes 1 and 2.
<i>U-NII Detection Bandwidth</i>	Minimum 100% of the U-NII 99% transmission power bandwidth. See Note 3.
<p>Note 1: <i>Channel Move Time</i> and the <i>Channel Closing Transmission Time</i> should be performed with Radar Type 0. The measurement timing begins at the end of the Radar Type 0 burst.</p> <p>Note 2: The <i>Channel Closing Transmission Time</i> is comprised of 200 milliseconds starting at the beginning of the <i>Channel Move Time</i> plus any additional intermittent control signals required to facilitate a <i>Channel</i> move (an aggregate of 60 milliseconds) during the remainder of the 10 second period. The aggregate duration of control signals will not count quiet periods in between transmissions.</p> <p>Note 3: During the <i>U-NII Detection Bandwidth</i> detection test, radar type 0 should be used. For each frequency step the minimum percentage of detection is 90 percent. Measurements are performed with no data traffic.</p>	

2.5 RADAR TEST WAVEFORMS

This section provides the parameters for required test waveforms, minimum percentage of successful detections, and the minimum number of trials that must be used for determining DFS conformance. Step intervals of 0.1 microsecond for Pulse Width, 1 microsecond for PRI, 1 MHz for chirp width and 1 for the number of pulses will be utilized for the random determination of specific test waveforms.

2.5.1 Short Pulse Radar Test Waveforms

Table 5 – Short Pulse Radar Test Waveforms

Radar Type	Pulse Width (μsec)	PRI (μsec)	Number of Pulses	Minimum Percentage of Successful Detection	Minimum Number of Trials
0	1	1428	18	See Note 1	See Note 1
1	1	Test A: 15 unique PRI values randomly selected from the list of 23 PRI values in Table 5a	Roundup $\left\{ \left(\frac{1}{360} \right) \cdot \left(\frac{19 \cdot 10^6}{\text{PRI}_{\mu\text{sec}}} \right) \right\}$	60%	30
		Test B: 15 unique PRI values randomly selected within the range of 518-3066 μsec, with a minimum increment of 1 μsec, excluding PRI values selected in Test A			
2	1-5	150-230	23-29	60%	30
3	6-10	200-500	16-18	60%	30
4	11-20	200-500	12-16	60%	30
Aggregate (Radar Types 1-4)				80%	120
Note 1: Short Pulse Radar Type 0 should be used for the detection bandwidth test, channel move time, and channel closing time tests.					

A minimum of 30 unique waveforms are required for each of the Short Pulse Radar Types 2 through 4. If more than 30 waveforms are used for Short Pulse Radar Types 2 through 4, then each additional waveform must also be unique and not repeated from the previous waveforms. If more than 30 waveforms are used for Short Pulse Radar Type 1, then each additional waveform is generated with Test B and must also be unique and not repeated from the previous waveforms in Tests A or B.

For example if in Short Pulse Radar Type 1 Test B a PRI of 3066 μsec is selected, the number of pulses would be

$$\text{Roundup} \left\{ \left(\frac{1}{360} \right) \cdot \left(\frac{19 \cdot 10^6}{3066} \right) \right\} = \text{Round up } \{17.2\} = 18.$$

Table 5a - Pulse Repetition Intervals Values for Test A

Pulse Repetition Frequency Number	Pulse Repetition Frequency (Pulses Per Second)	Pulse Repetition Interval (Microseconds)
1	1930.5	518
2	1858.7	538
3	1792.1	558
4	1730.1	578
5	1672.2	598
6	1618.1	618
7	1567.4	638
8	1519.8	658
9	1474.9	678
10	1432.7	698
11	1392.8	718
12	1355	738
13	1319.3	758
14	1285.3	778
15	1253.1	798
16	1222.5	818
17	1193.3	838
18	1165.6	858
19	1139	878
20	1113.6	898
21	1089.3	918
22	1066.1	938
23	326.2	3066

The aggregate is the average of the percentage of successful detections of Short Pulse Radar Types 1-4. For example, the following table indicates how to compute the aggregate of percentage of successful detections.

Radar Type	Number of Trials	Number of Successful Detections	Minimum Percentage of Successful Detection
1	35	29	82.9%
2	30	18	60%
3	30	27	90%
4	50	44	88%
Aggregate (82.9% + 60% + 90% + 88%)/4 = 80.2%			

2.6 Long Pulse Radar Test Waveform

Table 6 – Long Pulse Radar Test Waveform

Radar Type	Pulse Width (μ sec)	Chirp Width (MHz)	PRI (μ sec)	Number of Pulses per <i>Burst</i>	Number of <i>Bursts</i>	Minimum Percentage of Successful Detection	Minimum Number of Trials
5	50-100	5-20	1000-2000	1-3	8-20	80%	30

The parameters for this waveform are randomly chosen. Thirty unique waveforms are required for the Long Pulse Radar Type waveforms. If more than 30 waveforms are used for the Long Pulse Radar Type waveforms, then each additional waveform must also be unique and not repeated from the previous waveforms.

Each waveform is defined as follows:

- 1) The transmission period for the Long Pulse Radar test signal is 12 seconds.
- 2) There are a total of 8 to 20 *Bursts* in the 12 second period, with the number of *Bursts* being randomly chosen. This number is *Burst Count*.
- 3) Each *Burst* consists of 1 to 3 pulses, with the number of pulses being randomly chosen. Each *Burst* within the 12 second sequence may have a different number of pulses.
- 4) The pulse width is between 50 and 100 microseconds, with the pulse width being randomly chosen. Each pulse within a *Burst* will have the same pulse width. Pulses in different *Bursts* may have different pulse widths.
- 5) Each pulse has a linear frequency modulated chirp between 5 and 20 MHz, with the chirp width being randomly chosen. Each pulse within a *transmission period* will have the same chirp width. The chirp is centered on the pulse. For example, with a radar frequency of 5300 MHz and a 20 MHz chirped signal, the chirp starts at 5290 MHz and ends at 5310 MHz.
- 6) If more than one pulse is present in a *Burst*, the time between the pulses will be between 1000 and 2000 microseconds, with the time being randomly chosen. If three pulses are present in a *Burst*, the random time interval between the first and second pulses is chosen independently of the random time interval between the second and third pulses.
- 7) The 12 second transmission period is divided into even intervals. The number of intervals is equal to *Burst Count*. Each interval is of length $(12,000,000 / \textit{Burst Count})$ microseconds. Each interval contains one *Burst*. The start time for the *Burst*, relative to the beginning of the interval, is between 1 and $[(12,000,000 / \textit{Burst Count}) - (\textit{Total Burst Length}) + (\textit{One Random PRI Interval})]$ microseconds, with the start time being randomly chosen. The step interval for the start time is 1 microsecond. The start time for each *Burst* is chosen randomly.

A representative example of a Long Pulse Radar Type waveform:

- 1) The total test waveform length is 12 seconds.
- 2) Eight (8) *Bursts* are randomly generated for the *Burst Count*.
- 3) *Burst* 1 has 2 randomly generated pulses.

- 4) The pulse width (for both pulses) is randomly selected to be 75 microseconds.
- 5) The PRI is randomly selected to be at 1213 microseconds.
- 6) *Bursts* 2 through 8 are generated using steps 3 – 5.
- 7) Each *Burst* is contained in even intervals of 1,500,000 microseconds. The starting location for Pulse 1, *Burst* 1 is randomly generated (1 to 1,500,000 minus the total *Burst* 1 length + 1 random

PRI interval) at the 325,001 microsecond step. *Bursts* 2 through 8 randomly fall in successive 1,500,000 microsecond intervals (i.e. *Burst* 2 falls in the 1,500,001 – 3,000,000 microsecond range).

Figure 1 provides a graphical representation of the Long Pulse Radar Test Waveform.

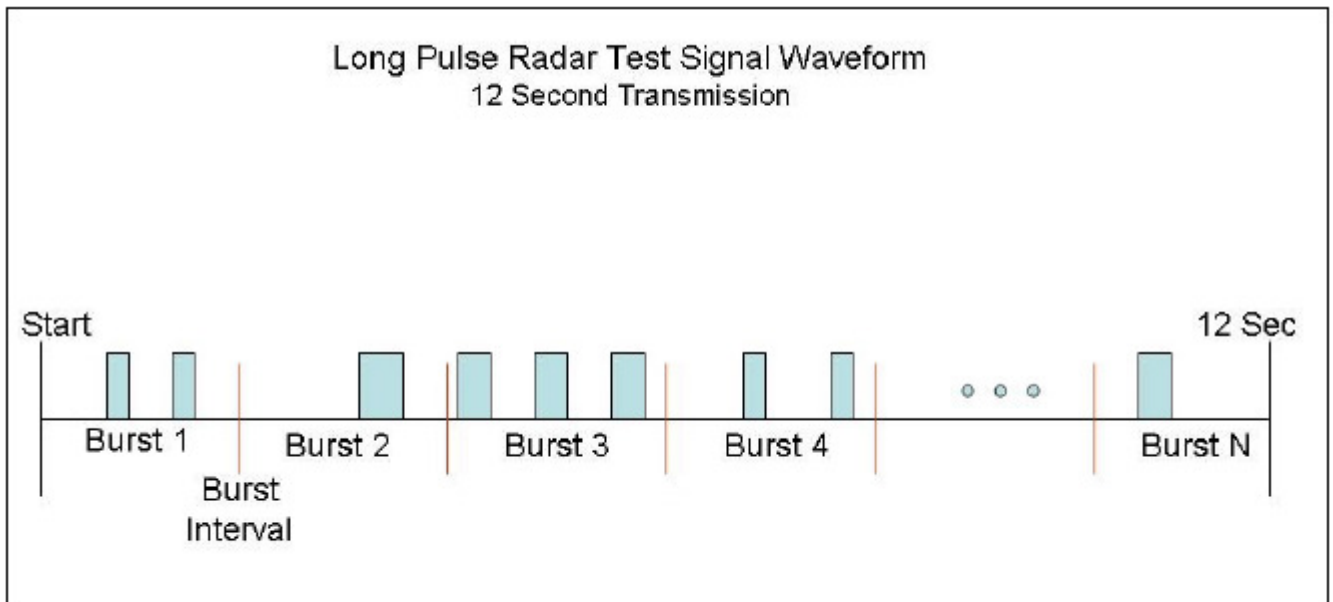

Figure 1: Graphical Representation of a Long Pulse Radar Type Waveform

2.7 Frequency Hopping Radar Test Waveform

Table 7 – Frequency Hopping Radar Test Waveform

Radar Type	Pulse Width (μsec)	PRI (μsec)	Pulses per Hop	Hopping Rate (kHz)	Hopping Sequence Length (msec)	Minimum Percentage of Successful Detection	Minimum Number of Trials
6	1	333	9	0.333	300	70%	30

For the Frequency Hopping Radar Type, the same *Burst* parameters are used for each waveform. The hopping sequence is different for each waveform and a 100-length segment is selected from the hopping sequence defined by the following algorithm: 4

The first frequency in a hopping sequence is selected randomly from the group of 475 integer frequencies from 5250 – 5724 MHz. Next, the frequency that was just chosen is removed from the group and a frequency is randomly selected from the remaining 474 frequencies in the group. This process continues until all 475 frequencies are chosen for the set. For selection of a random frequency, the frequencies remaining within the group are always treated as equally likely.

3. SUMMARY OF TEST RESULTS

Test procedures according to the technical standards:

FCC Part 15 , Subpart E			
Standard Section	Test Item	Judgment	Remark
15.407	Channel Closing Transmission Time	PASS	
15.407	Channel Move Time	PASS	

NOTE:

(1) "N/A" denotes test is not applicable in this test report.

4. MEASUREMENT INSTRUMENTS

Kind of Equipment	Manufacturer	Type No.	Last Calibrated	Calibrated until
R&S Spectrum analyzer	R&S	FSP40	08/19/2016	08/18/2017
Spectrum analyzer	Agilent	E4446A	08/19/2016	08/18/2017
Signal generator	Agilent	8645A	08/19/2016	08/18/2017
Oscilloscope	Tektronix	TDS 5104	08/19/2016	08/18/2017

DESCRIPTION OF SUPPORT UNITS

The EUT has been tested as an independent unit together with other necessary accessories or support units. The following support units or accessories were used to form a representative test configuration during the tests.

Item	Equipment	Mfr/Brand	Model/Type No.	Series No.	Note
1	Xtreme N DUO Wireless Bridge/Access Point	D-Link	DAP-1522	/	FCC ID KA2AP1522B1

Note: This device was functioned as slave without radar detection mode.

5. TEST PROCEDURE

5.1 DFS MEASUREMENT SYSTEM

A complete DFS Measurement System consists of two subsystems:

- (1) The Radar Signal Generating Subsystem and
- (2) The Traffic Monitoring Subsystem.

The control PC is necessary for generating the Radar waveforms in Table 10, 11 and 12. The traffic monitoring subsystem is specified to the type of unit under test (UUT).

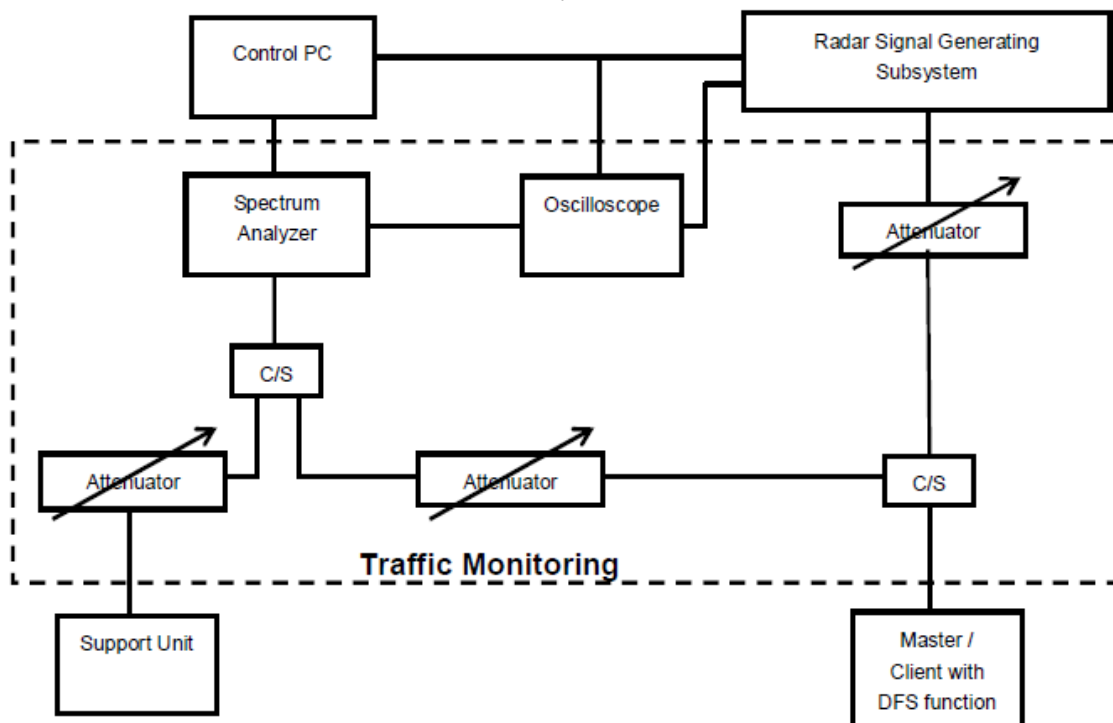

The test transmission will always be from the Master Device to the Client Device. While the Client device is set up to associate with the Master device and play the MPEG file (6 y Magic Hours) from Master device, the designated MPEG test file and instructions are located at:
<http://ntiacsd.ntia.doc.gov/dfs/>.

5.2 CALIBRATION OF DFS DETECTION THRESHOLD LEVEL

The measured channel is 5260MHz. The radar signal was the same as transmitted channels, and injected into the antenna port of Client Device with Radar Detection, measured the channel closing transmission time and channel move time.

SLAVE WITHOUT RADAR DETECTION MODE

The antenna gain is -4dBi and required detection threshold is -65dBm (= -62 +1 - 4)dBm. The calibrated conducted detection threshold level is set to -65dBm.

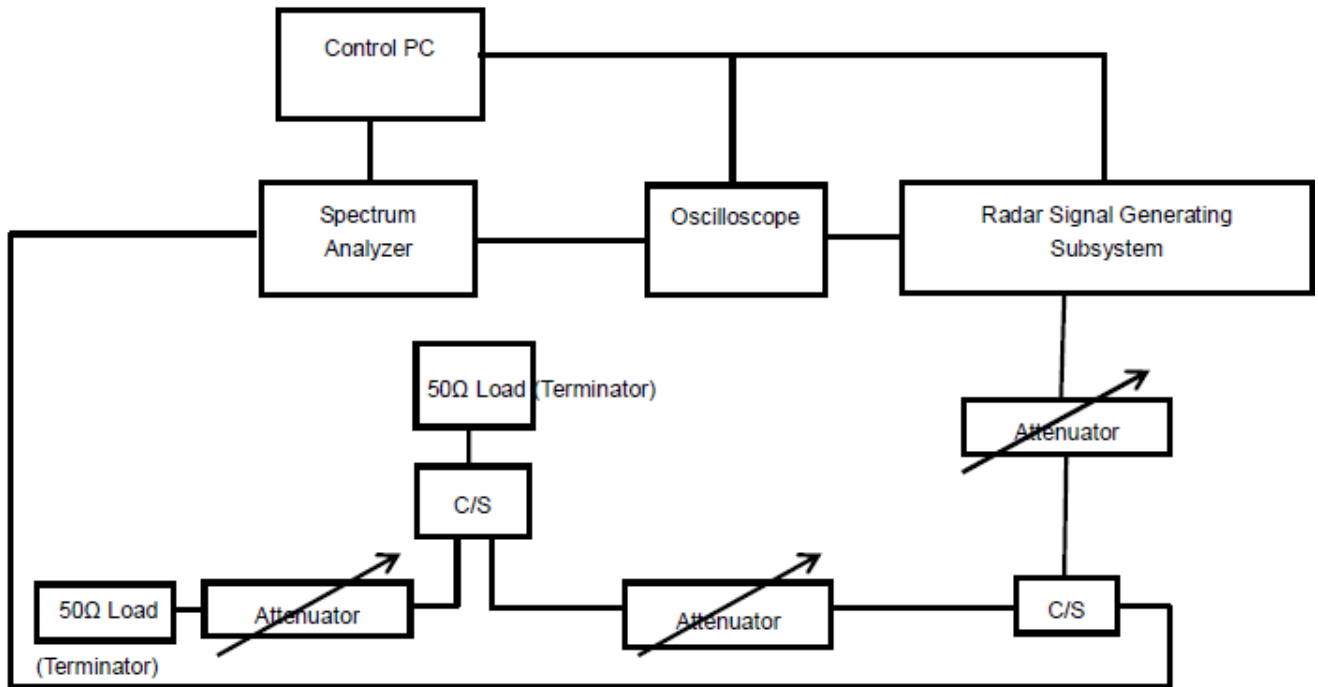

DEVIATION FROM TEST STANDARD

No deviation.

6. TEST RESULTS

6.1 PLOTS OF RADAR WAVEFORM, AND WLAN TRAFFIC

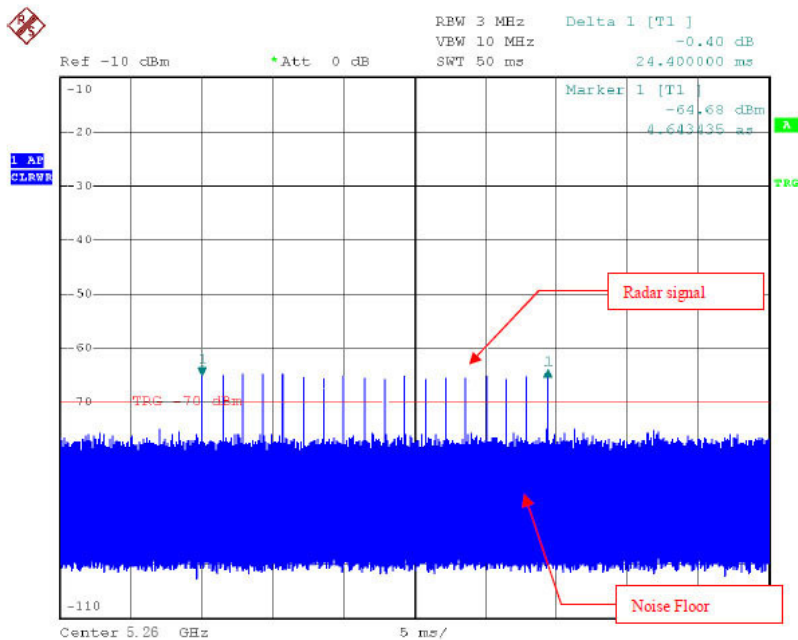

Radar Signal Type 1

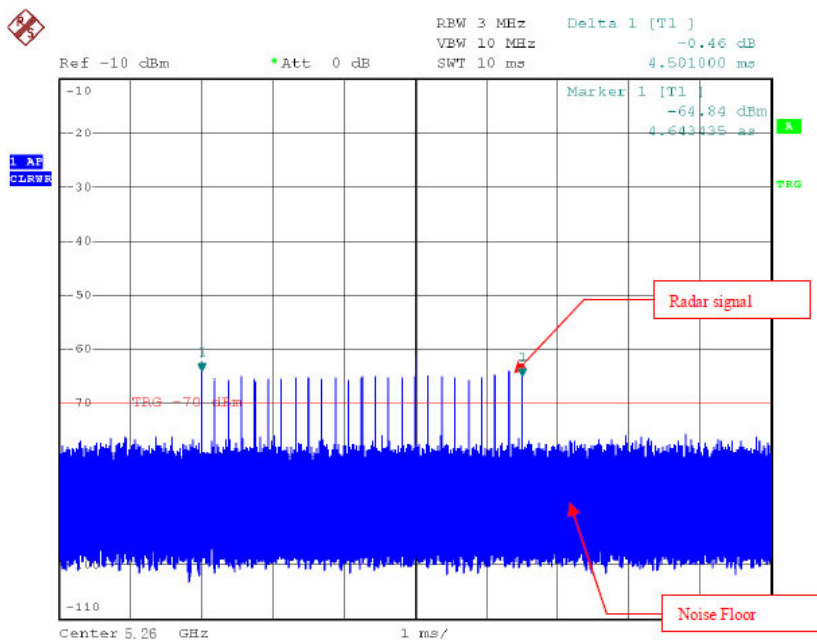

Radar Signal Type 2

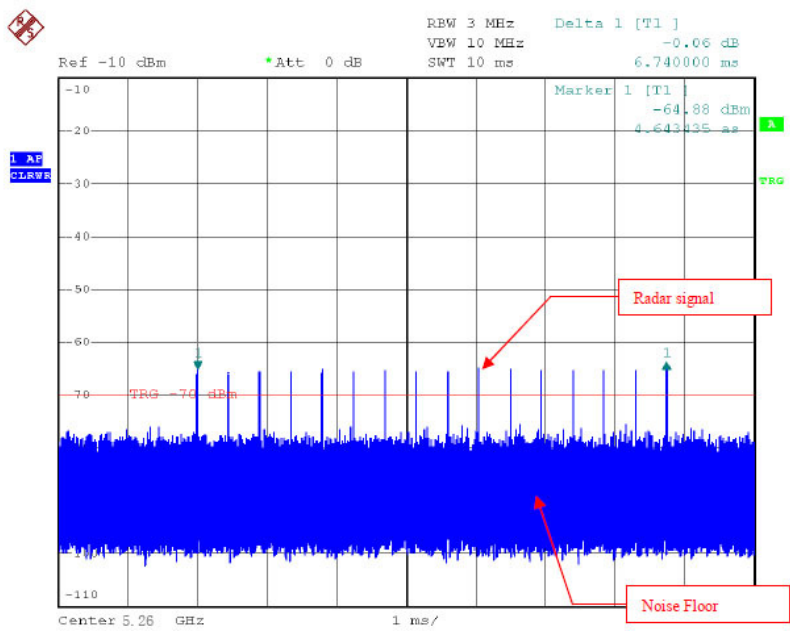

Radar Signal Type 3

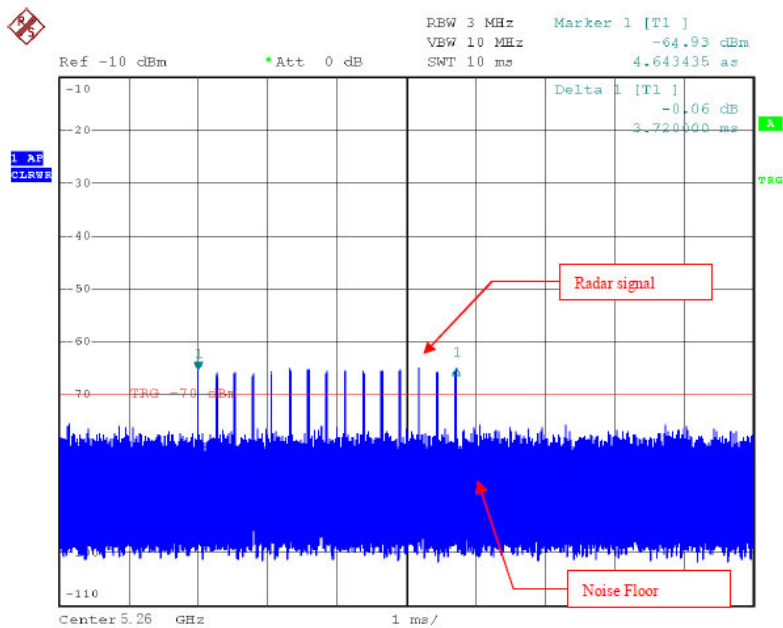

Radar Signal Type 4

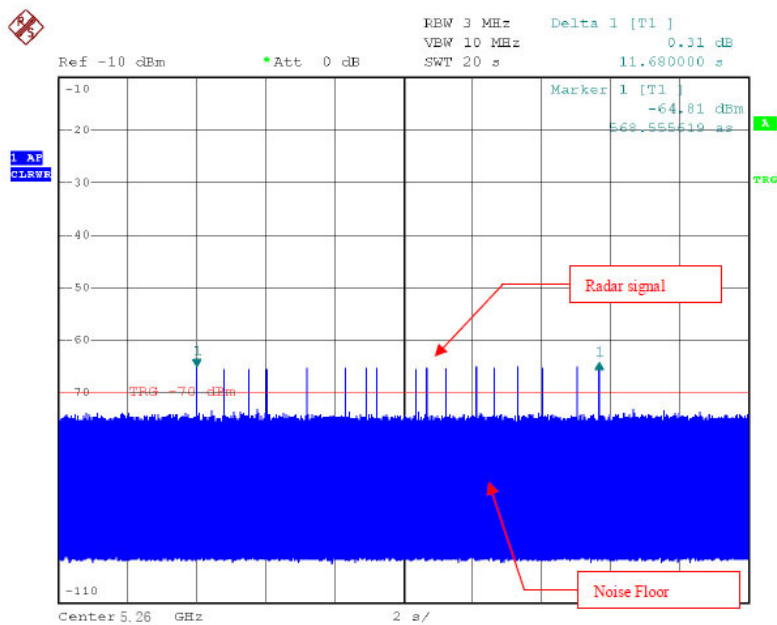

Radar Signal Type 5

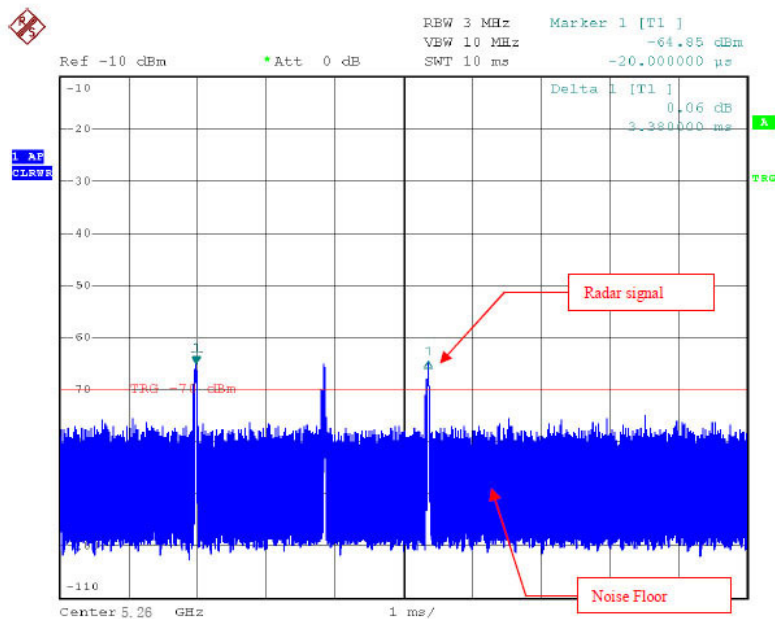

Single Burst of Radar Signal Type 5

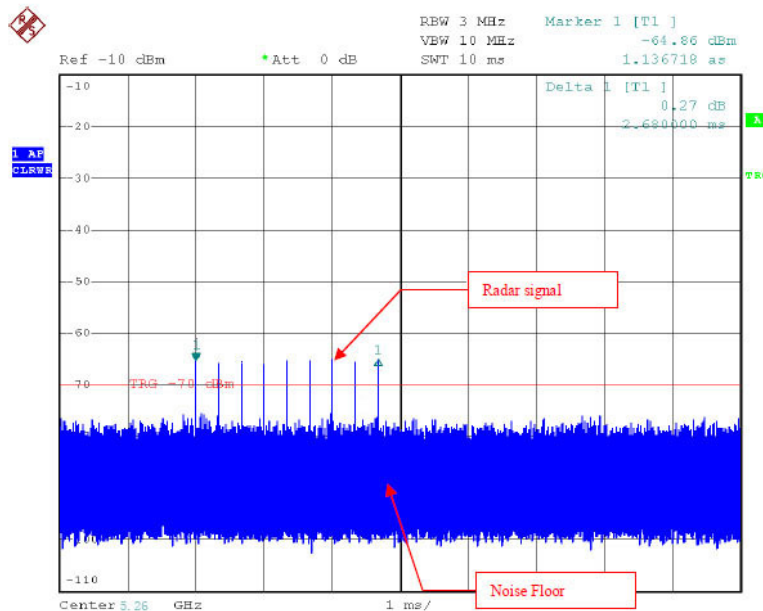

Radar Signal Type 6

Duty Cycle @ 5260MHz

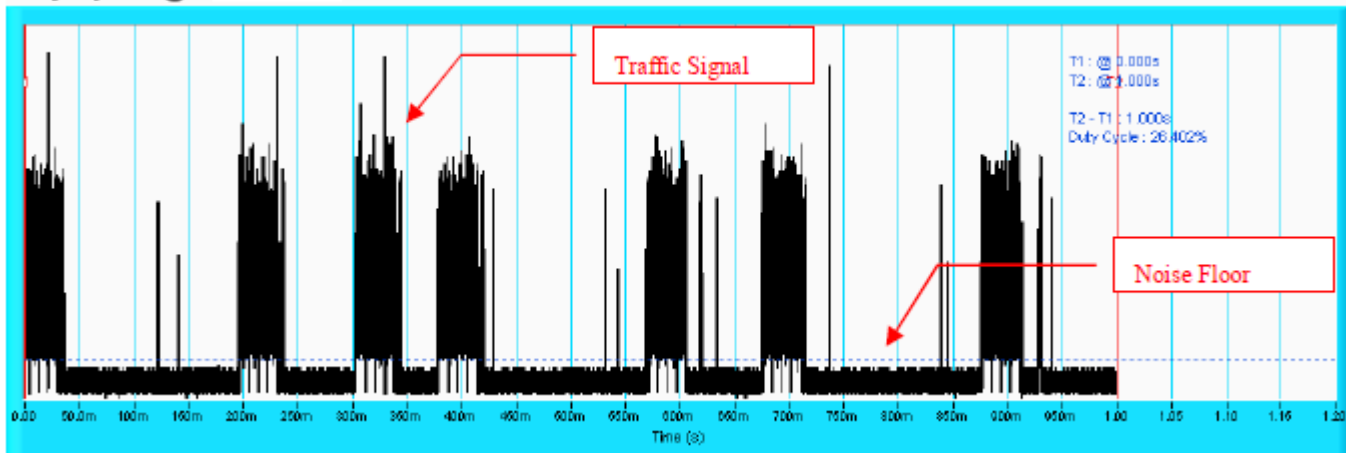

WLAN TRAFFIC

NOTE: T1 denotes the start of duty cycle period is 0th second. T2 denotes the end of duty cycle period is 1th second. T2 – T1= 1 seconds. Duty Cycle =26.402%

6.2 IN-SERVICE MONITORING FOR CHANNEL MOVE TIME, CHANNEL CLOSING TRANSMISSION TIME

Radar signal Type 1

Channel Closing Transmission Time & Channel Move Time @ 5260MHz

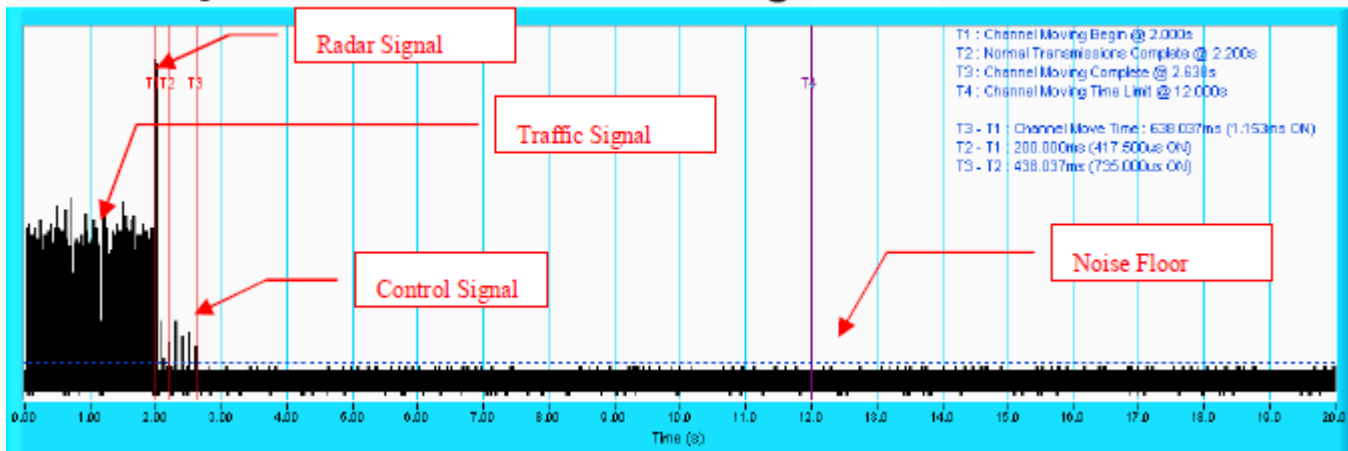

NOTE: T1 denotes the start of Channel Move Time upon the end of the last Radar burst. T2 denotes the data transmission time of 200ms from T1. T3 denotes the end of Channel Move Time. T4 denotes the 10 second from T1 to observe the aggregate duration of transmissions.

Channel Closing Transmission Time & Channel Move Time @ 5260MHz

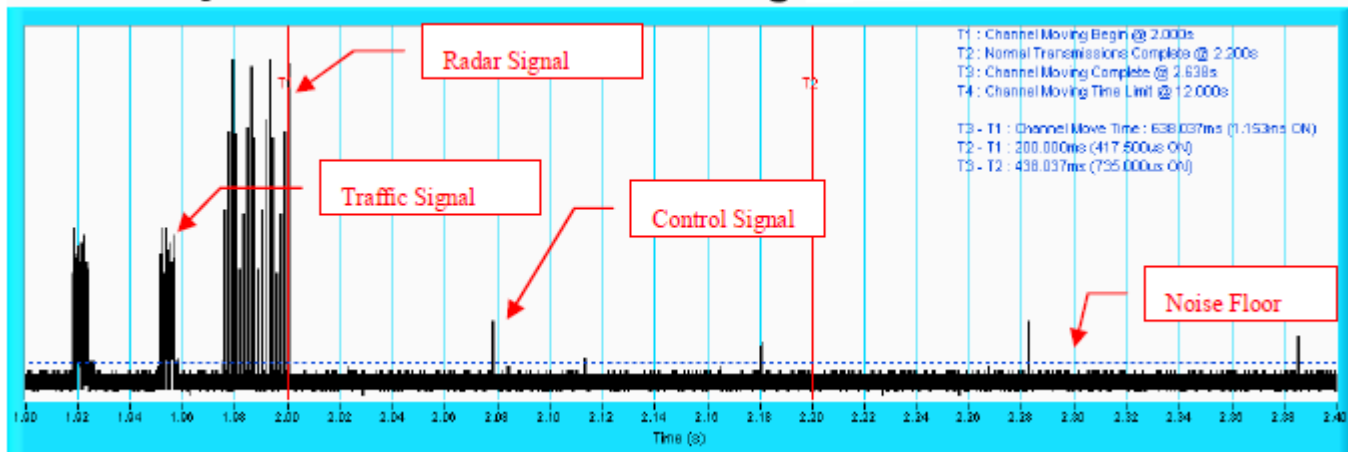

NOTE: An expanded plot for the device vacates the channel in the required.

Radar signal Type 2

Channel Closing Transmission Time & Channel Move Time @ 5260MHz

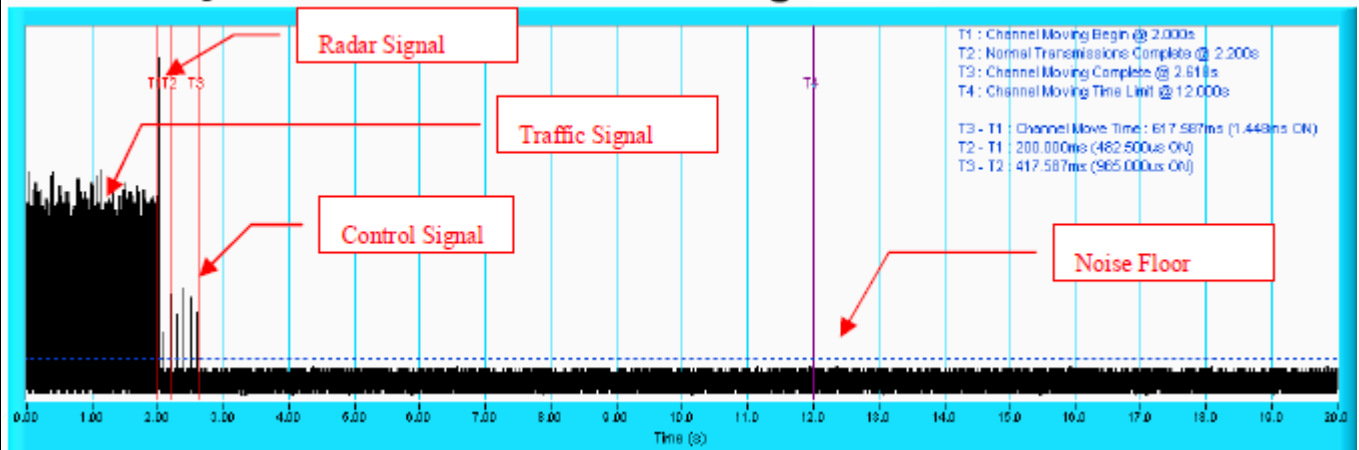

NOTE: T1 denotes the start of Channel Move Time upon the end of the last Radar burst. T2 denotes the data transmission time of 200ms from T1. T3 denotes the end of Channel Move Time. T4 denotes the 10 second from T1 to observe the aggregate duration of transmissions.

Channel Closing Transmission Time & Channel Move Time @ 5260MHz

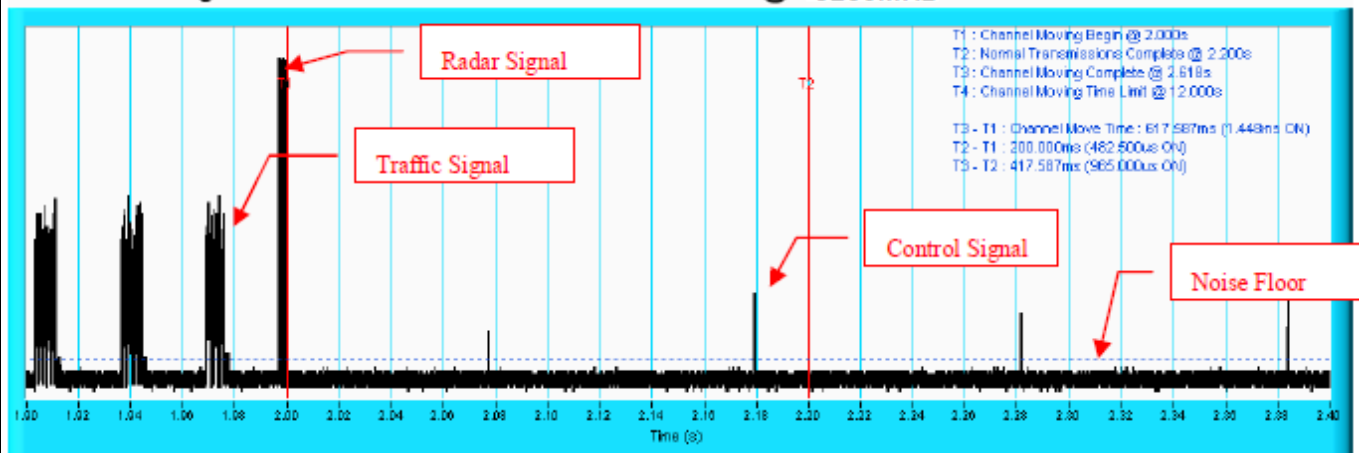

NOTE: An expanded plot for the device vacates the channel in the required.

Radar signal Type 3

Channel Closing Transmission Time & Channel Move Time @ 5260MHz

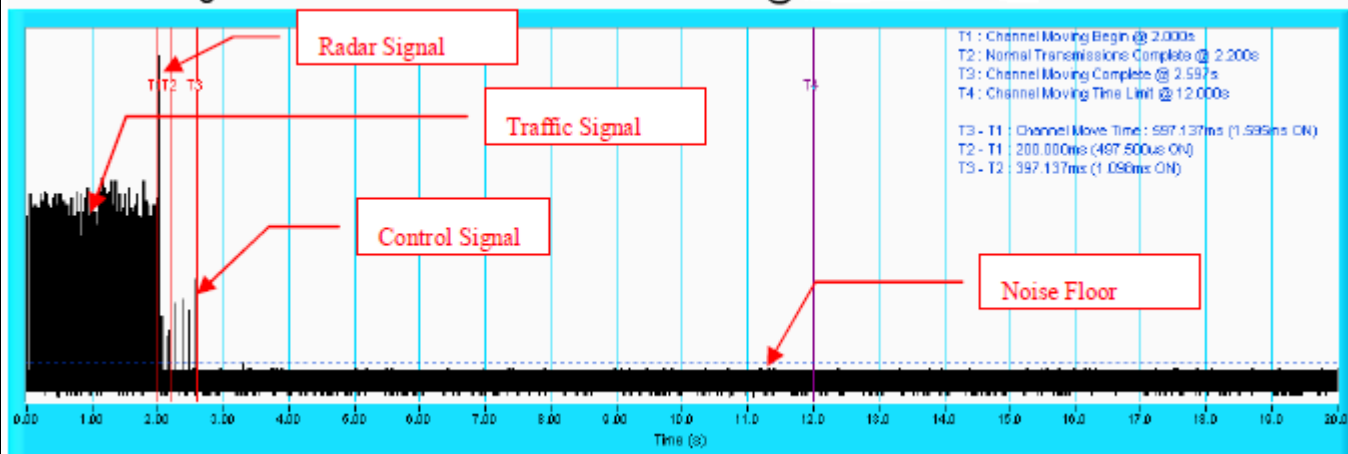

NOTE: T1 denotes the start of Channel Move Time upon the end of the last Radar burst. T2 denotes the data transmission time of 200ms from T1. T3 denotes the end of Channel Move Time. T4 denotes the 10 second from T1 to observe the aggregate duration of transmissions.

Channel Closing Transmission Time & Channel Move Time @ 5260MHz

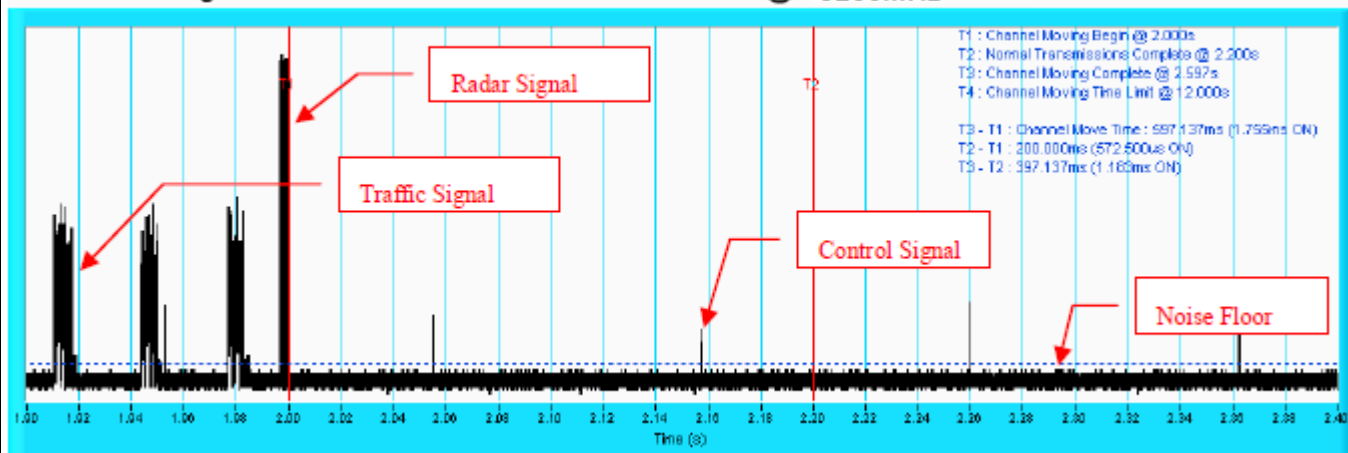

NOTE: An expanded plot for the device vacates the channel in the required.

Radar signal Type 4

Channel Closing Transmission Time & Channel Move Time @ 5260MHz

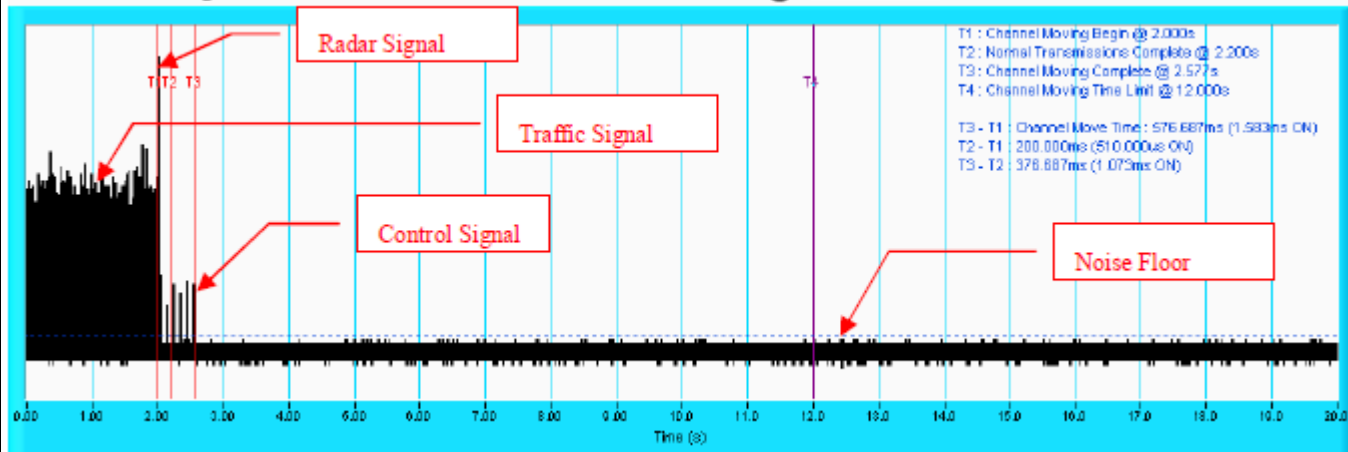

NOTE: T1 denotes the start of Channel Move Time upon the end of the last Radar burst. T2 denotes the data transmission time of 200ms from T1. T3 denotes the end of Channel Move Time. T4 denotes the 10 second from T1 to observe the aggregate duration of transmissions.

Channel Closing Transmission Time & Channel Move Time @ 5260MHz

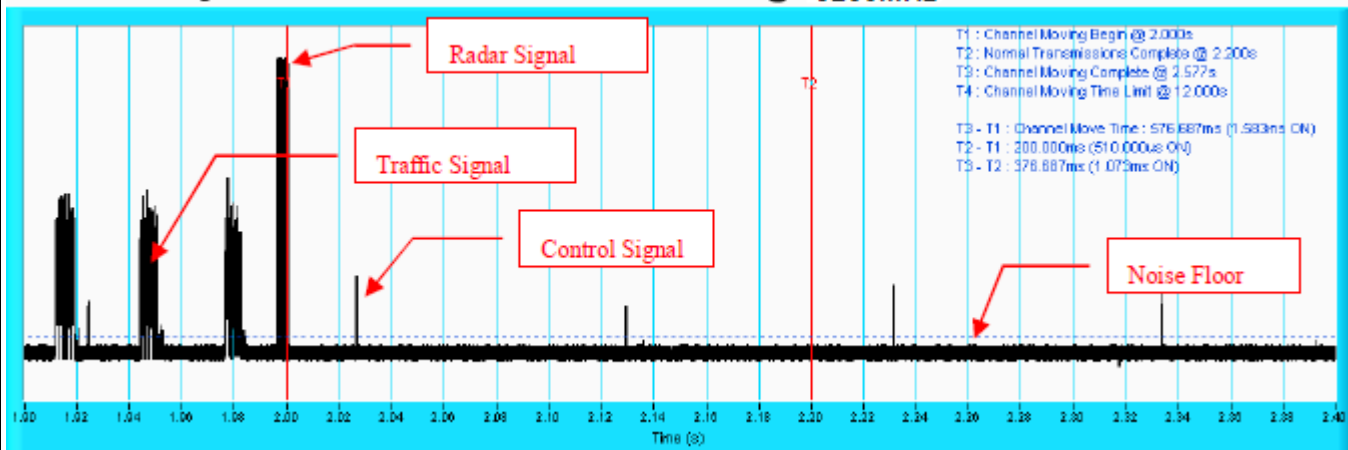

NOTE: An expanded plot for the device vacates the channel in the required.

Radar signal Type 5

Channel Closing Transmission Time & Channel Move Time @ 5260MHz

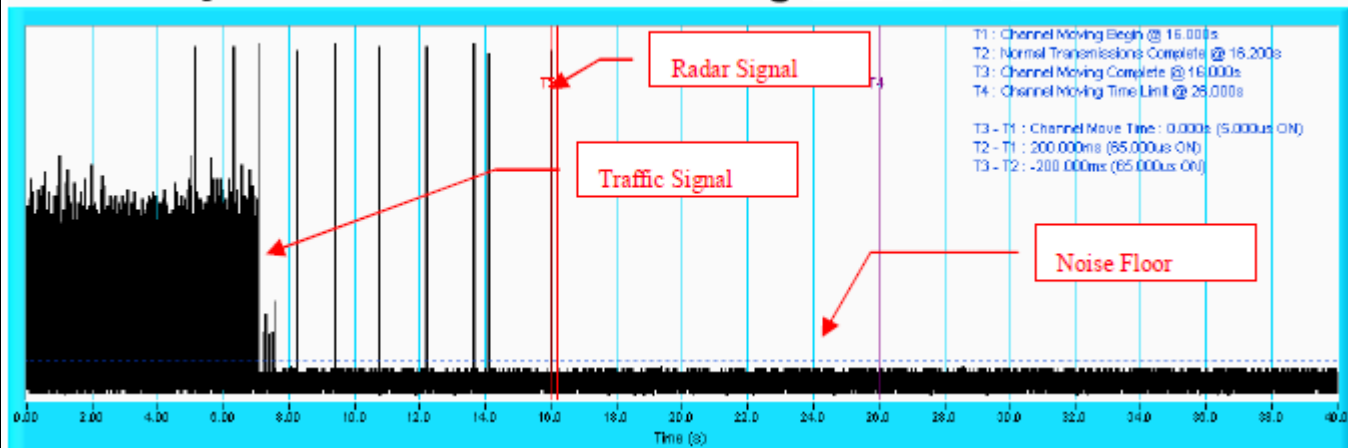

NOTE: T1 denotes the start of Channel Move Time upon the end of the last Radar burst. T2 denotes the data transmission time of 200ms from T1. T3 denotes the end of Channel Move Time. T4 denotes the 10 second from T1 to observe the aggregate duration of transmissions.

Channel Closing Transmission Time & Channel Move Time @ 5260MHz

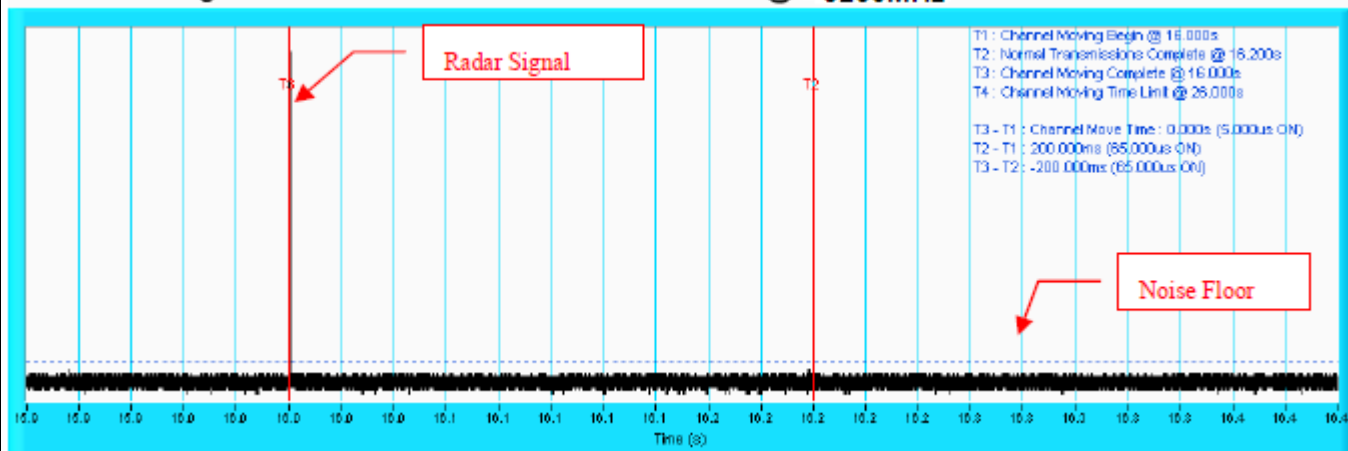

NOTE: An expanded plot for the device vacates the channel in the required.

Radar signal Type 6

Channel Closing Transmission Time & Channel Move Time @ 5260MHz

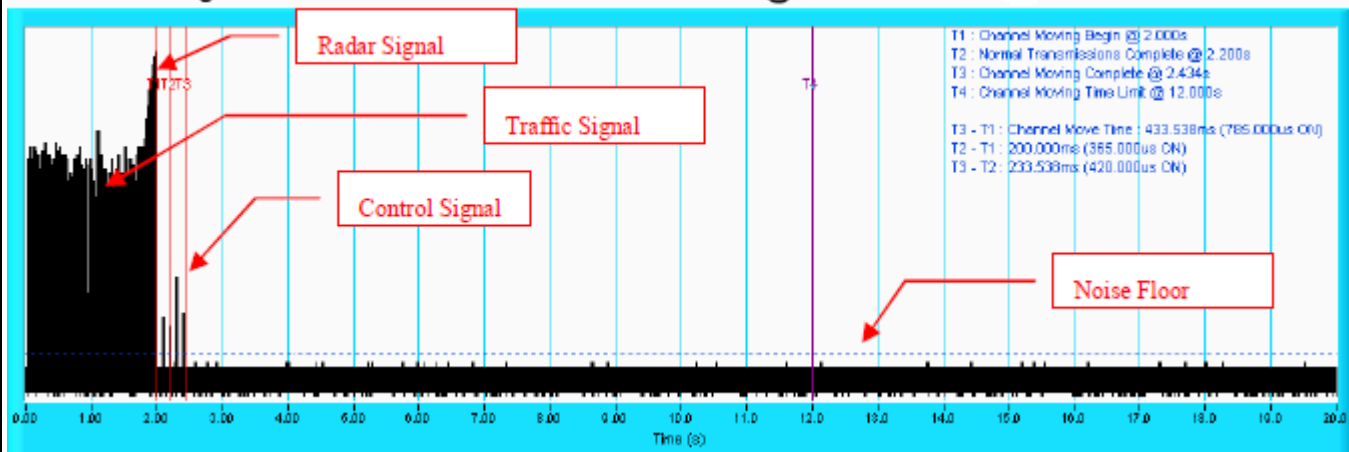

NOTE: T1 denotes the start of Channel Move Time upon the end of the last Radar burst. T2 denotes the data transmission time of 200ms from T1. T3 denotes the end of Channel Move Time. T4 denotes the 10 second from T1 to observe the aggregate duration of transmissions.

Channel Closing Transmission Time & Channel Move Time @ 5260MHz

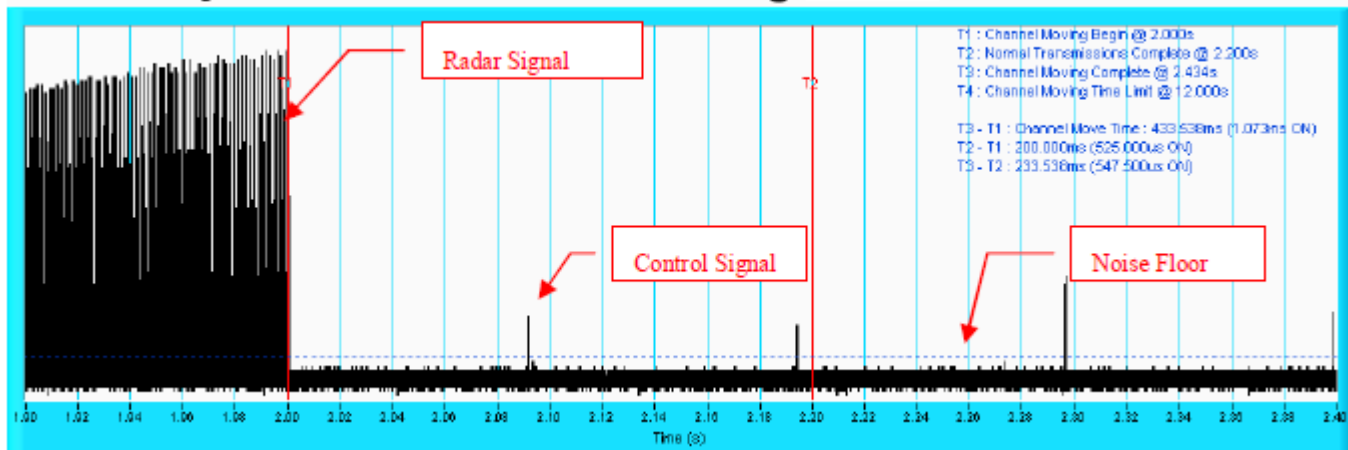

---END OF REPORT---