

REPORT REVISE RECORD

Report Version	Revise Time	Issued Date	Valid Version	Notes
V1.0	/	October 12, 2016	Valid	Original Report
V1.1	/	November 07, 2016	Valid	Original Report

Table of Contents	Page
1. GENERAL INFORMATION	5
2. TEST DESCRIPTION	7
2.1 MEASUREMENT UNCERTAINTY	7
2.2 DESCRIPTION OF TEST MODES	8
2.3 TABLE OF PARAMETERS OF TEXT SOFTWARE SETTING	9
2.4 CONFIGURATION OF SYSTEM UNDER TEST	9
2.5 DESCRIPTION OF SUPPORT UNITS (CONDUCTED MODE)	9
3. SUMMARY OF TEST RESULTS	10
4. MEASUREMENT INSTRUMENTS	11
5. EMC EMISSION TEST	12
5.1 CONDUCTED EMISSION MEASUREMENT	12
5.1.1 POWER LINE CONDUCTED EMISSION LIMITS	12
5.1.2 TEST PROCEDURE	13
5.1.3 DEVIATION FROM TEST STANDARD	13
5.1.4 TEST SETUP	13
5.1.5 EUT OPERATING CONDITIONS	13
5.1.6 TEST RESULTS	14
5.2 RADIATED EMISSION MEASUREMENT	16
5.2.1 RADIATED EMISSION LIMITS	16
5.2.2 TEST PROCEDURE	16
5.2.3 DEVIATION FROM TEST STANDARD	17
5.2.4 TEST SETUP	18
5.2.5 EUT OPERATING CONDITIONS	19
5.2.5.1 RESULTS (BELOW 30 MHZ)	20
5.2.5.2 TEST RESULTS (BETWEEN 30M – 1000 MHZ)	21
5.2.5.3 TEST RESULTS (1GHZ TO 25GHZ)	23
6. ANTENNA APPLICATION	29
7. 6DB BANDWIDTH MEASUREMENT	30
7.1 TEST SETUP	30
7.2 LIMITS OF 6DB BANDWIDTH MEASUREMENT	30
7.3 TEST PROCEDURE	30
8. MAXIMUM PEAK OUTPUT POWER	38
8.1 TEST SETUP	38
8.2 LIMITS OF MAXIMUM PEAK OUTPUT POWER	38
8.3 TEST PROCEDURE	38

Table of Contents**Page**

9. POWER SPECTRAL DENSITY MEASUREMENT	47
9.1 TEST SETUP	47
9.2 LIMITS OF POWER SPECTRAL DENSITY MEASUREMENT	47
9.3 TEST PROCEDURE	47
9.4 TEST RESULT	48
10. OUT OF BAND MEASUREMENT	55
10.1 TEST SETUP FOR BAND EDGE	55
10.2 LIMITS OF OUT OF BAND EMISSIONS MEASUREMENT	55
10.4 TEST RESULT	55
11. EUT TEST PHOTO	68
12. PHOTOGRAPHS OF EUT	70

1. GENERAL INFORMATION

GENERAL DESCRIPTION OF EUT

Test Model	X602
Applicant	INFINIX MOBILITY LIMITED
Address	RMS 05-15, 13A/F SOUTH TOWER WORLD FINANCE CTR HARBOUR CITY 17 CANTON RD TST KLN HONG KONG
Manufacturer	SHENZHEN TECNO TECHNOLOGY CO.,LTD.
Address	1-4th Floor,3rd Building,Pacific Industrial Park,No.2088,Shenyan Road,Yantian District,Shenzhen,Guangdong,China
Equipment Type	Mobile phone
Brand Name	Infinix
Hardware version:	V1.1_B1-BOM
Software version:	X602-H972B1-M-160823V7
Extreme Temp. Tolerance	-10°C to +65°C
Battery information:	Li-Polymer Battery : BL-40FX Voltage: 3.85V Capacity: 4000mAh Limited Charge Voltage: 4.4V
Adapter Information:	Adapter: CQ-18KX Input: 100-240V 50/60Hz 600mA Output: 5V-6V 3A Output: 6V-9V 2A Output: 9V-12V 1.5A
Operating Frequency	2412-2462MHz
Channels	11
Channel Spacing	5MHz
Modulation Type	CCK for IEEE 802.11b OFDM for IEEE 802.11g/n HT-20/n HT-40
Antenna Type:	Integral Antenna
Antenna gain:	-4dBi
Data of receipt	September 05, 2016
Date of test	September 05, 2016, to October 11, 2016
Deviation	None
Condition of Test Sample	Normal

We hereby certify that:

All measurement facilities used to collect the measurement data are located at QTC Certification & Testing Co., Ltd.

Registration Number: 588523

The data evaluation, test procedures, and equipment configurations shown in this report were made in accordance with the procedures given in ANSI C 63.10-2013. The sample tested as described in this report is in compliance with the FCC Rules Part15 Subpart C.

ALL the testing were referenced KDB NO.558074V03R05

The offset factor to the measurement is conducted as the average.

The test results of this report relate only to the tested sample identified in this report.

2. TEST DESCRIPTION

2.1 MEASUREMENT UNCERTAINTY

The reported uncertainty of measurement $y \pm U$, where expanded uncertainty U is based on a standard uncertainty multiplied by a coverage factor of $k=2$, providing a level of confidence of approximately **95** %.

No.	Item	Uncertainty
1	Conducted Emission Test	$\pm 3.2\text{dB}$
2	RF power, conducted	$\pm 0.16\text{dB}$
3	Spurious emissions, conducted	$\pm 0.21\text{dB}$
4	All emissions, radiated(<1G)	$\pm 4.7\text{dB}$
5	All emissions, radiated(>1G)	$\pm 4.7\text{dB}$
6	Temperature	$\pm 0.5^\circ\text{C}$
7	Humidity	$\pm 2\%$

2.2 DESCRIPTION OF TEST MODES

To investigate the maximum EMI emission characteristics generates from EUT, the test system was pre-scanning tested base on the consideration of following EUT operation mode or test configuration mode which possible have effect on EMI emission level. Each of these EUT operation mode(s) or test configuration mode(s) mentioned above was evaluated respectively.

Pretest Mode	Description
Mode 1	802.11b
Mode 2	802.11g
Mode 3	802.11n20
Mode 4	802.11n40

For Conducted Emission	
Final Test Mode	Description
Mode 1	802.11b

For Radiated Emission	
Final Test Mode	Description
Mode 1	802.11b
Mode 2	802.11g
Mode 3	802.11n20
Mode 4	802.11n40

Note:

- (1) The measurements are performed at the highest, middle, lowest available channels.**
- (2) The EUT use new battery.**
- (3)The data rate was set in 1Mbps, 6 Mbps, 6.5 Mbps and 13.5M for radiated emission due to the highest RF output power.**
- (4) Record the worst case of each test item in this report.**

2.3 TABLE OF PARAMETERS OF TEXT SOFTWARE SETTING

During testing channel & power controlling software provided by the customer was used to control the operating channel as well as the output power level. The RF output power selection is for the setting of RF output power expected by the customer and is going to be fixed on the firmware of the final end product power parameters of FHSS

Test software Version	N/A
Test program	*#3646633#*

Frequency(802.11b/g/n20)	2412 MHz	2437 MHz	2462 MHz
Frequency(802.11n40)	2422 MHz	2437 MHz	2452 MHz

2.4 CONFIGURATION OF SYSTEM UNDER TEST

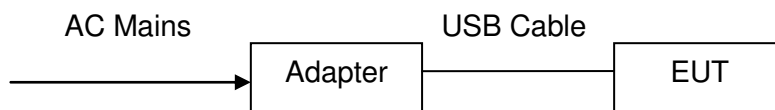

(EUT: Mobile phone)

I/O Port of EUT			
I/O Port Type	Q'TY	Cable	Tested with
USB port	1	1m USB cable, unshielded	1
Power	1	1m	1

2.5 DESCRIPTION OF SUPPORT UNITS (CONDUCTED MODE)

The EUT has been tested as an independent unit together with other necessary accessories or support units. The following support units or accessories were used to form a representative test configuration during the tests.

Item	Equipment	Mfr/Brand	Model/Type No.	Series No.	Note
1	Adapter	/	CQ-18KX	/	/
2	Earphone	/	N/A	/	/

Note:

- (1) The support equipment was authorized by Declaration of Confirmation.
- (2) For detachable type I/O cable should be specified the length in cm in 『Length』 column.
- (3) “YES” is means “shielded” “with core”; “NO” is means “unshielded” “without core”.
- (4) The adapter supply by the applicant.

3. SUMMARY OF TEST RESULTS

Test procedures according to the technical standards:

FCC Part15 (15.247) , Subpart C			
Standard Section	Test Item	Judgment	Remark
15.207	Conducted Emission Test	PASS	Complies
15.247(a)(2) Limit	Spectrum bandwidth of a Orthogonal Frequency Division Multiplex System Limit: 6dB bandwidth>500kHz	PASS	Complies
15.247(b)	Maximum peak outputpower Limit: max. 30dBm	PASS	Complies
15.109,15.205 & 15.209	Transmitter Radiated Emission Limit: Table 15.209	PASS	Complies
15.247(e)	Power Spectral Density Limit: max. 8dBm	PASS	Complies
15.247(d)	Out of Band Emission and Restricted Band Radiation Limit: 20dB less than peak value of fundamental frequency Restricted band limit: Table 15.209	PASS	Complies

NOTE:

(1) "N/A" denotes test is not applicable in this test report.

4. MEASUREMENT INSTRUMENTS

NAME OF EQUIPMENT	MANUFACTURER	MODEL	SERIAL NUMBER	Calibration Date	Calibration Due.
EMI Test Receiver	R&S	ESCI	100005	08/19/2016	08/18/2017
LISN	AFJ	LS16	16010222119	08/19/2016	08/18/2017
LISN(EUT)	Mestec	AN3016	04/10040	08/19/2016	08/18/2017
Universal Radio Communication Tester	R&S	CMU 200	1100.0008.02	08/19/2016	08/18/2017
Coaxial cable	Megalon	LMR400	N/A	08/12/2016	08/11/2017
GPIO cable	Megalon	GPIO	N/A	08/12/2016	08/11/2017
Spectrum Analyzer	R&S	FSU	100114	08/19/2016	08/18/2017
Pre Amplifier	H.P.	HP8447E	2945A02715	10/13/2016	10/12/2017
Pre-Amplifier	CDSI	PAP-1G18-38	--	10/13/2016	10/12/2017
Bi-log Antenna	SUNOL Sciences	JB3	A021907	09/13/2016	09/12/2017
9*6*6 Anechoic	--	--	--	08/21/2016	08/20/2017
Horn Antenna	COMPLIANCE ENGINEERING	CE18000	--	09/13/2016	09/12/2017
Horn Antenna	SCHWARZBECK	BBHA9120D	9120D-631	08/23/2016	08/22/2017
Cable	TIME MICROWAVE	LMR-400	N-TYPE04	04/25/2016	04/24/2017
System-Controller	CCS	N/A	N/A	N.C.R	N.C.R
Turn Table	CCS	N/A	N/A	N.C.R	N.C.R
Antenna Tower	CCS	N/A	N/A	N.C.R	N.C.R
RF cable	Murata	MXHQ87WA3000	-	08/21/2016	08/20/2017
Loop Antenna	EMCO	6502	00042960	08/22/2016	08/21/2017
Horn Antenna	SCHWARZBECK	BBHA 9170	1123	08/19/2016	08/18/2017
Power meter	Anritsu	ML2487A	6K00003613	08/23/2016	08/22/2017
Power sensor	Anritsu	MX248XD	--	08/19/2016	08/18/2017

5. EMC EMISSION TEST

5.1 CONDUCTED EMISSION MEASUREMENT

5.1.1 POWER LINE CONDUCTED EMISSION Limits (Frequency Range 150KHz-30MHz)

FREQUENCY (MHz)	Class A (dBuV)		Class B (dBuV)		Standard
	Quasi-peak	Average	Quasi-peak	Average	
0.15 -0.5	79.00	66.00	66 - 56 *	56 - 46 *	FCC
0.50 -5.0	73.00	60.00	56.00	46.00	FCC
5.0 -30.0	73.00	60.00	60.00	50.00	FCC

Note:

- (1) The tighter limit applies at the band edges.
- (2) The limit of " * " marked band means the limitation decreases linearly with the logarithm of the frequency in the range.

The following table is the setting of the receiver

Receiver Parameters	Setting
Attenuation	10 dB
Start Frequency	0.15 MHz
Stop Frequency	30 MHz
IF Bandwidth	9 kHz

5.1.2 TEST PROCEDURE

- The EUT was placed 0.4 meters from the horizontal ground plane with EUT being connected to the power mains through a line impedance stabilization network (LISN). All other support equipments powered from additional LISN(s). The LISN provide 50 Ohm/ 50uH of coupling impedance for the measuring instrument.
- Interconnecting cables that hang closer than 40 cm to the ground plane shall be folded back and forth in the center forming a bundle 30 to 40 cm long.
- I/O cables that are not connected to a peripheral shall be bundled in the center. The end of the cable may be terminated, if required, using the correct terminating impedance. The overall length shall not exceed 1 m.
- LISN at least 80 cm from nearest part of EUT chassis.
- For the actual test configuration, please refer to the related Item –EUT Test Photos.

5.1.3 DEVIATION FROM TEST STANDARD

No deviation

5.1.4 TEST SETUP

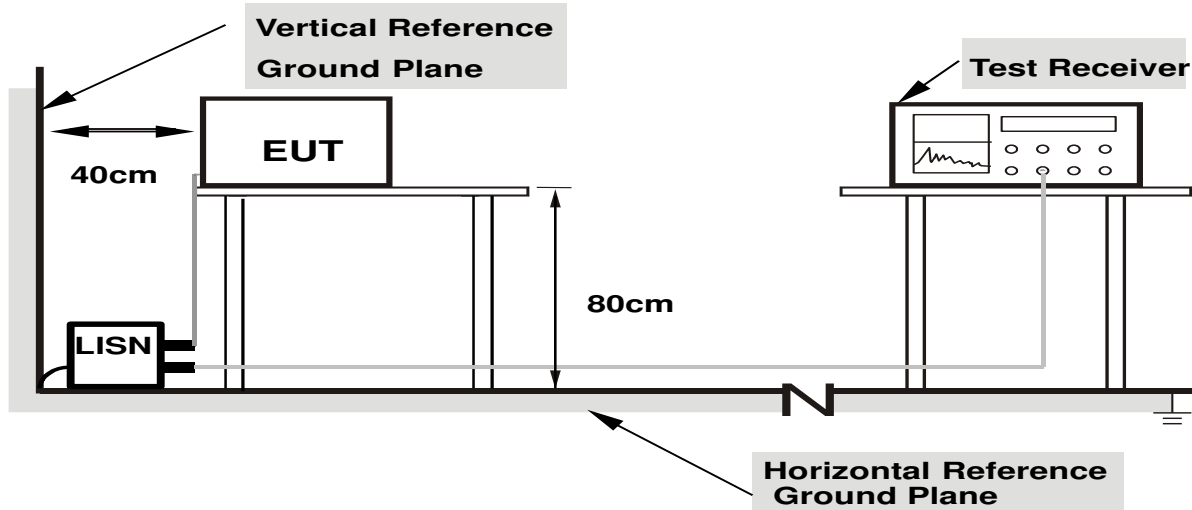

- Note:**
- Support units were connected to second LISN.
 - Both of LISNs (AMN) are 80 cm from EUT and at least 80 cm from other units and other metal planes

5.1.5 EUT OPERATING CONDITIONS

The EUT was configured for testing in a typical fashion (as a customer would normally use it). The EUT has been programmed to continuously transmit during test. This operating condition was tested and used to collect the included data.

5.1.6 TEST RESULTS

EUT	Mobile phone	Model Name	X602
Temperature	26 °C	Relative Humidity	54%
Pressure	1010hPa	Phase	L
Test Date	September 06, 2016	Test Mode	Mode 1

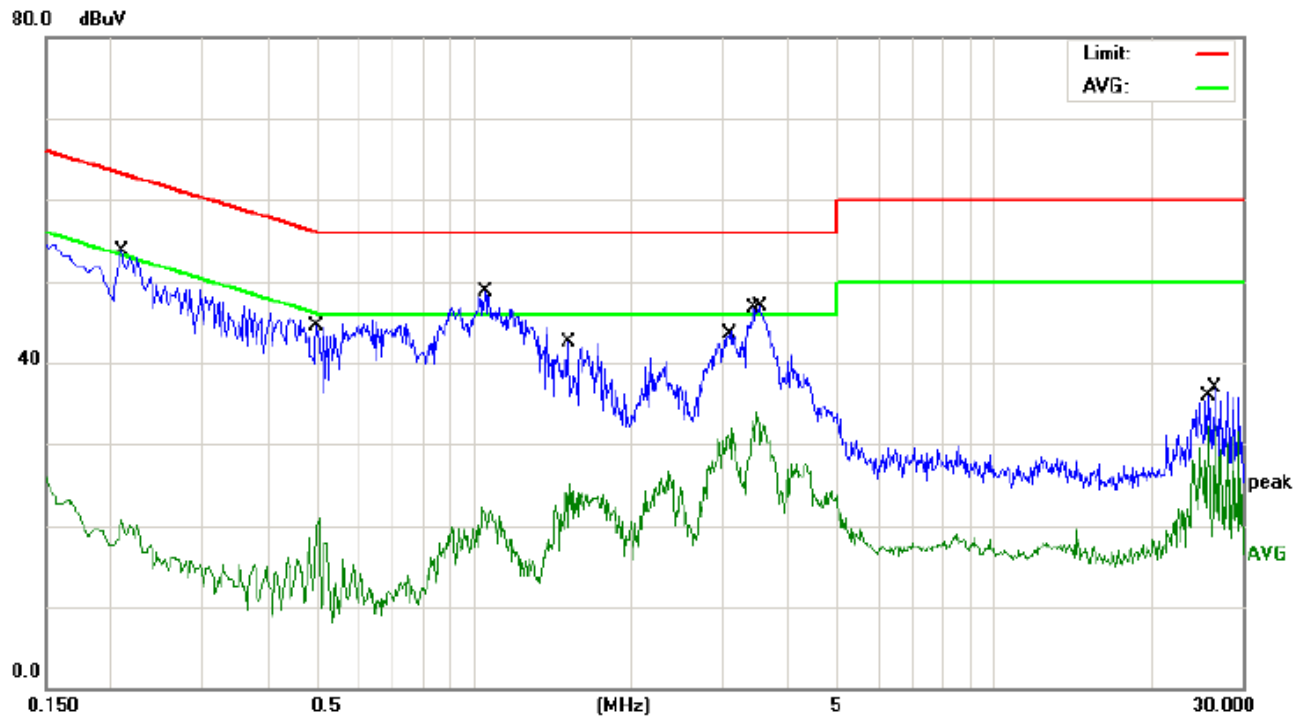

No.	Mk.	Freq. MHz	Reading Level dBuV	Correct Factor dB	Measure- ment dBuV	Limit dBuV	Over dB	Detector
1		0.2100	28.26	20.86	49.12	63.20	-14.08	QP
2		0.2100	-0.22	20.86	20.64	53.20	-32.56	AVG
3		0.5020	0.16	20.80	20.96	46.00	-25.04	AVG
4		1.0380	1.72	20.68	22.40	46.00	-23.60	AVG
5	*	1.0500	24.05	20.68	44.73	56.00	-11.27	QP
6		1.5140	17.93	20.62	38.55	56.00	-17.45	QP
7		1.5339	4.39	20.62	25.01	46.00	-20.99	AVG
8		3.0780	18.61	20.54	39.15	56.00	-16.85	QP
9		3.5060	13.47	20.52	33.99	46.00	-12.01	AVG
10		3.5460	21.42	20.52	41.94	56.00	-14.06	QP
11		25.7820	11.97	20.20	32.17	50.00	-17.83	AVG
12		26.4300	12.61	20.20	32.81	60.00	-27.19	QP

Remark: All the modes have been investigated, and only worst mode is presented in this report.

EUT	Mobile phone	Model Name	X602
Temperature	26 °C	Relative Humidity	54%
Pressure	1010hPa	Phase	N
Test Date	September 06, 2016	Test Mode	Mode 1

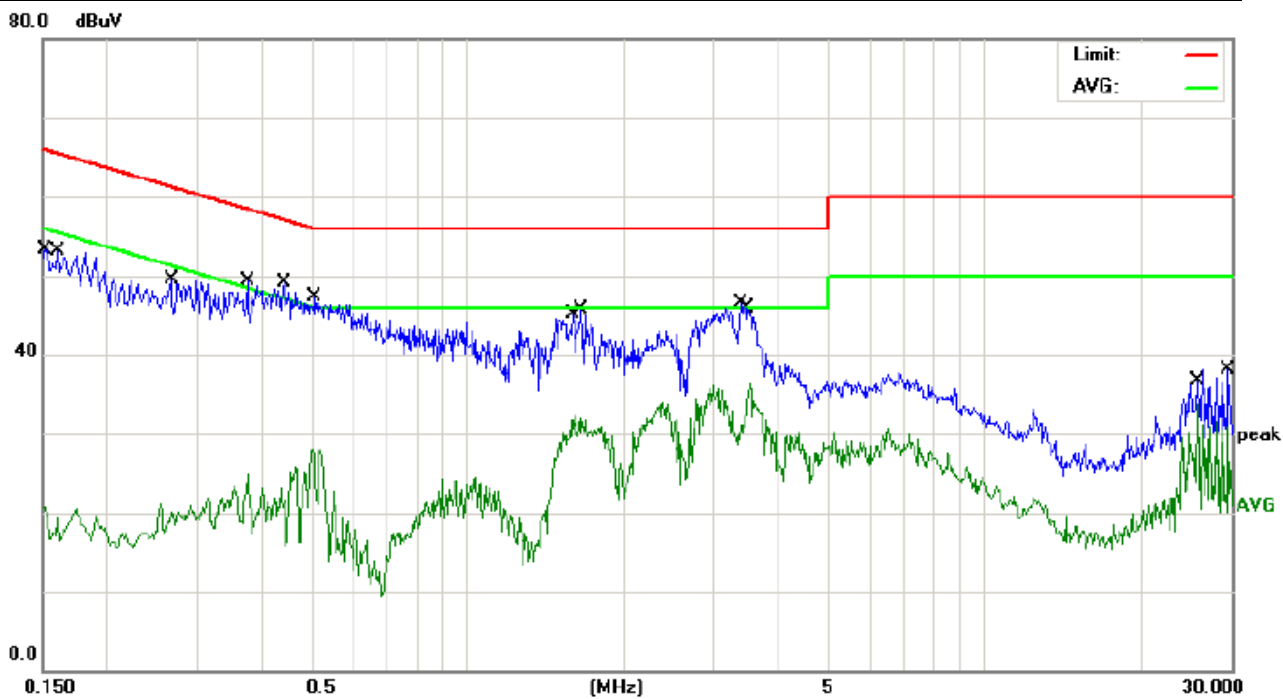

No.	Mk.	Freq. MHz	Reading Level dBuV	Correct Factor dB	Measure- ment dBuV	Limit dBuV	Over dB	Detector
1		0.1516	-0.16	20.88	20.72	55.91	-35.19	AVG
2		0.1597	28.49	20.88	49.37	65.47	-16.10	QP
3		0.2660	24.73	20.86	45.59	61.24	-15.65	QP
4		0.3740	4.13	20.82	24.95	48.41	-23.46	AVG
5		0.4420	24.27	20.82	45.09	57.02	-11.93	QP
6		0.4994	7.40	20.80	28.20	46.01	-17.81	AVG
7		1.6019	11.73	20.62	32.35	46.00	-13.65	AVG
8		1.6620	21.17	20.62	41.79	56.00	-14.21	QP
9		3.3740	21.69	20.52	42.21	56.00	-13.79	QP
10	*	3.5180	15.68	20.52	36.20	46.00	-9.80	AVG
11		25.7620	13.51	20.20	33.71	50.00	-16.29	AVG
12		29.6180	13.72	20.22	33.94	60.00	-26.06	QP

Remark: All the modes have been investigated, and only worst mode is presented in this report.

5.2 RADIATED EMISSION MEASUREMENT

5.2.1 RADIATED EMISSION LIMITS (Frequency Range 9kHz-1000MHz)

20dBc in any 100 kHz bandwidth outside the operating frequency band. In case the emission fall within the restricted band specified on 15.205(a), then the 15.209(a) limit in the table below has to be followed.

Frequencies (MHz)	Field Strength (micorvolts/meter)	Measurement Distance (meters)
0.009~0.490	2400/F(KHz)	300
0.490~1.705	24000/F(KHz)	30
1.705~30.0	30	30
30~88	100	3
88~216	150	3
216~960	200	3
Above 960	500	3

LIMITS OF RADIATED EMISSION MEASUREMENT (Above 1000MHz)

FREQUENCY (MHz)	Limit (dBuV/m) (at 3M)	
	PEAK	AVERAGE
Above 1000	74	54

Notes:

- (1) The limit for radiated test was performed according to FCC PART 15C.
- (2) The tighter limit applies at the band edges.
- (3) Emission level (dBuV/m)=20log Emission level (uV/m).

Spectrum Parameter	Setting
Attenuation	Auto
Start Frequency	1000 MHz
Stop Frequency	10th carrier harmonic
RB / VB (emission in restricted band)	1 MHz / 1 MHz for Peak, 1 MHz / 1Hz for Average

Receiver Parameter	Setting
Attenuation	Auto
Start ~ Stop Frequency	9kHz~150kHz / RB 200Hz for QP
Start ~ Stop Frequency	150kHz~30MHz / RB 9kHz for QP
Start ~ Stop Frequency	30MHz~1000MHz / RB 120kHz for QP

5.2.2 TEST PROCEDURE

- a. The measuring distance of at 3 m shall be used for measurements at frequency up to 1GHz. For frequencies above 1GHz, any suitable measuring distance may be used.

- b. The EUT was placed on the top of a rotating table 0.8 meters above the ground at a 3 meter open area test site. The table was rotated 360 degrees to determine the position of the highest radiation.
- c. The height of the equipment or of the substitution antenna shall be 0.8 m; the height of the test antenna shall vary between 1 m to 4 m. Both horizontal and vertical polarizations of the antenna are set to make the measurement.
- d. The initial step in collecting conducted emission data is a spectrum analyzer peak detector mode pre-scanning the measurement frequency range. Significant peaks are then marked and then Quasi Peak detector mode re-measured.
- e. If the Peak Mode measured value compliance with and lower than Quasi Peak Mode Limit, the EUT shall be deemed to meet QP Limits and then no additional QP Mode measurement performed.
- f. For the actual test configuration, please refer to the related Item –EUT Test Photos.

Note:

Both horizontal and vertical antenna polarities were tested and performed pretest to three orthogonal axis. The worst case emissions were reported

5.2.3 DEVIATION FROM TEST STANDARD

No deviation

5.2.4 TEST SETUP

(A) Radiated Emission Test-Up Frequency Below 30MHz

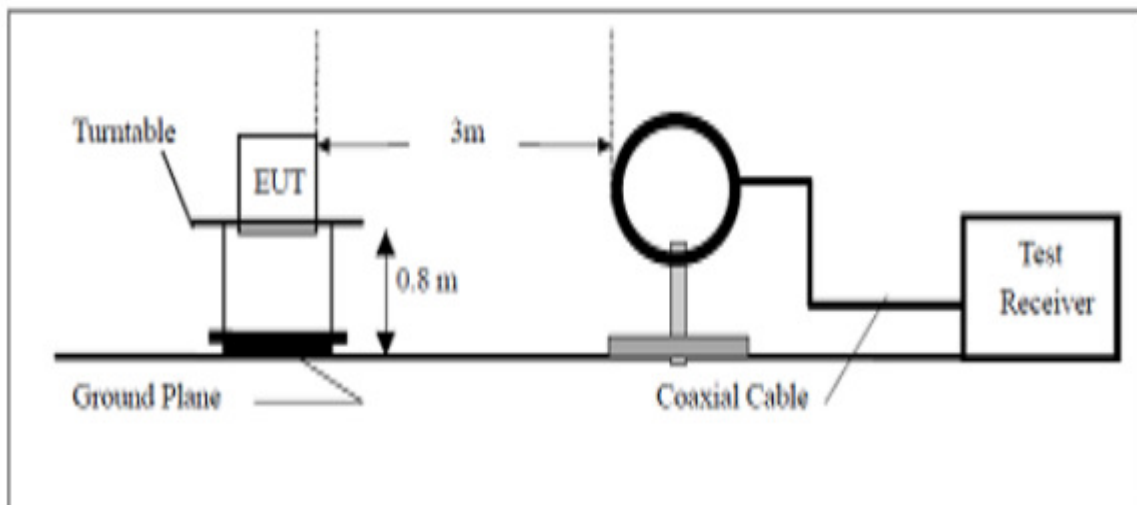

(B) Radiated Emission Test-Up Frequency 30MHz~1GHz

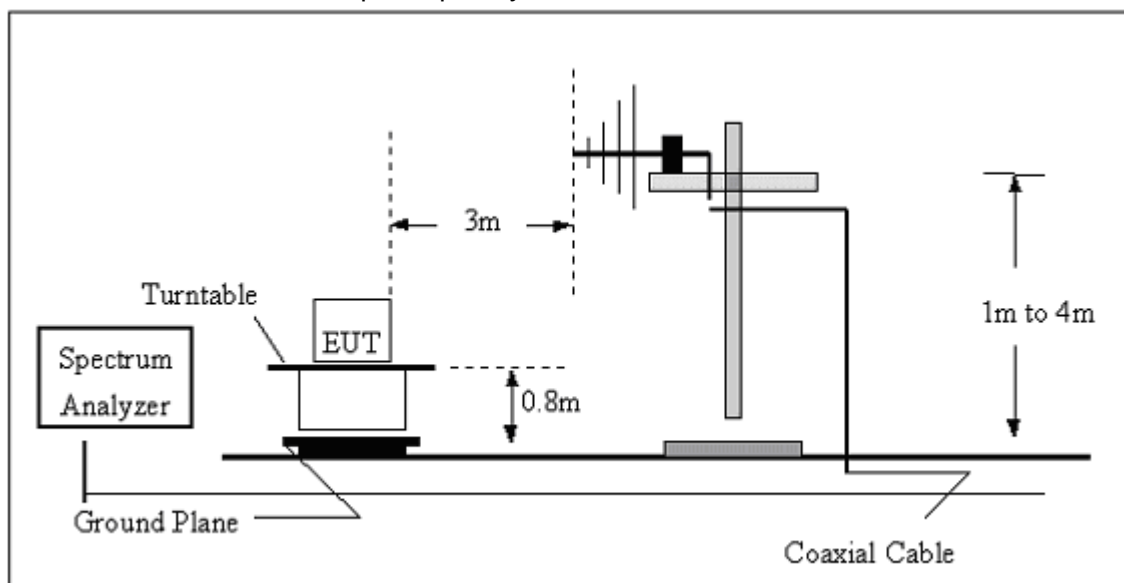

(C) Radiated Emission Test-Up Frequency Above 1GHz

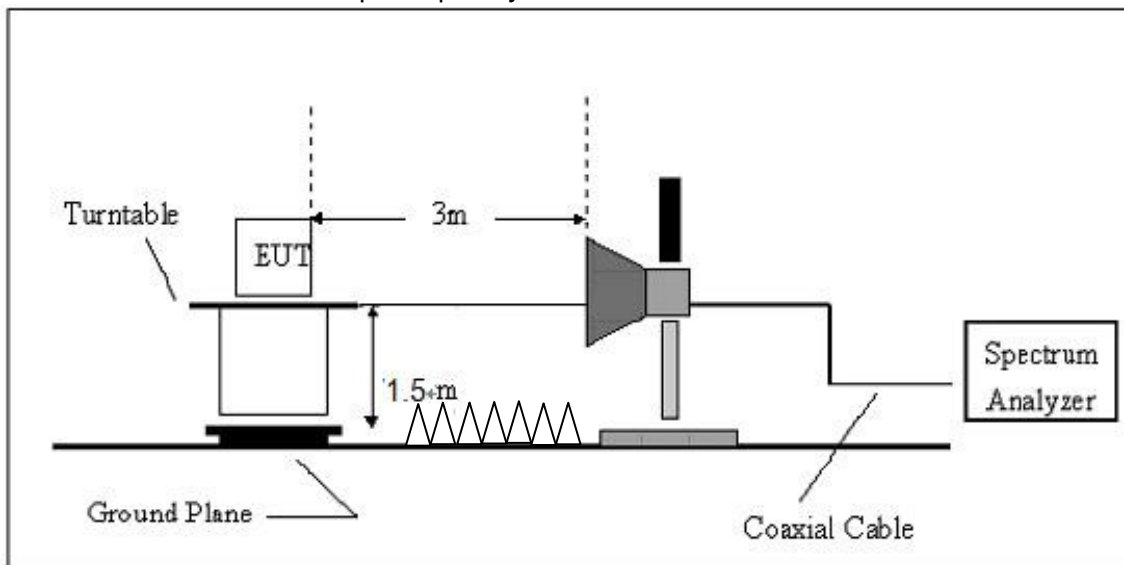
**5.2.5 EUT OPERATING CONDITIONS**

The EUT tested system was configured as the statements of 2.4 Unless otherwise a special operating condition is specified in the follows during the testing.

5.2.5.1 RESULTS (BELOW 30 MHZ)

EUT	Mobile phone	Model Name	X602
Temperature	20 °C	Relative Humidity	48%
Pressure	1010 hPa	Polarization	---
Test Mode	Mode 1	Test Date	September 06, 2016

Freq. (MHz)	Reading (dBuV/m)	Limit (dBuV/m)	Margin (dB)	State P/F
--	--	--	--	P
--	--	--	--	P

NOTE:

No result in this part for margin above 20dB.

Distance extrapolation factor = $20 \log (\text{specific distance}/\text{test distance})$ (dB);

Limit line = specific limits(dBuV) + distance extrapolation factor.

All the x/y/z orientation has been investigated, and only worst case is presented in this report.

5.2.5.2 TEST RESULTS (BETWEEN 30M – 1000 MHZ)

EUT	Mobile phone	Model Name	X602
Temperature	20 °C	Relative Humidity	48%
Pressure	1010 hPa	Polarization :	Horizontal
Test Mode	Mode 1	Test Date	September 06, 2016

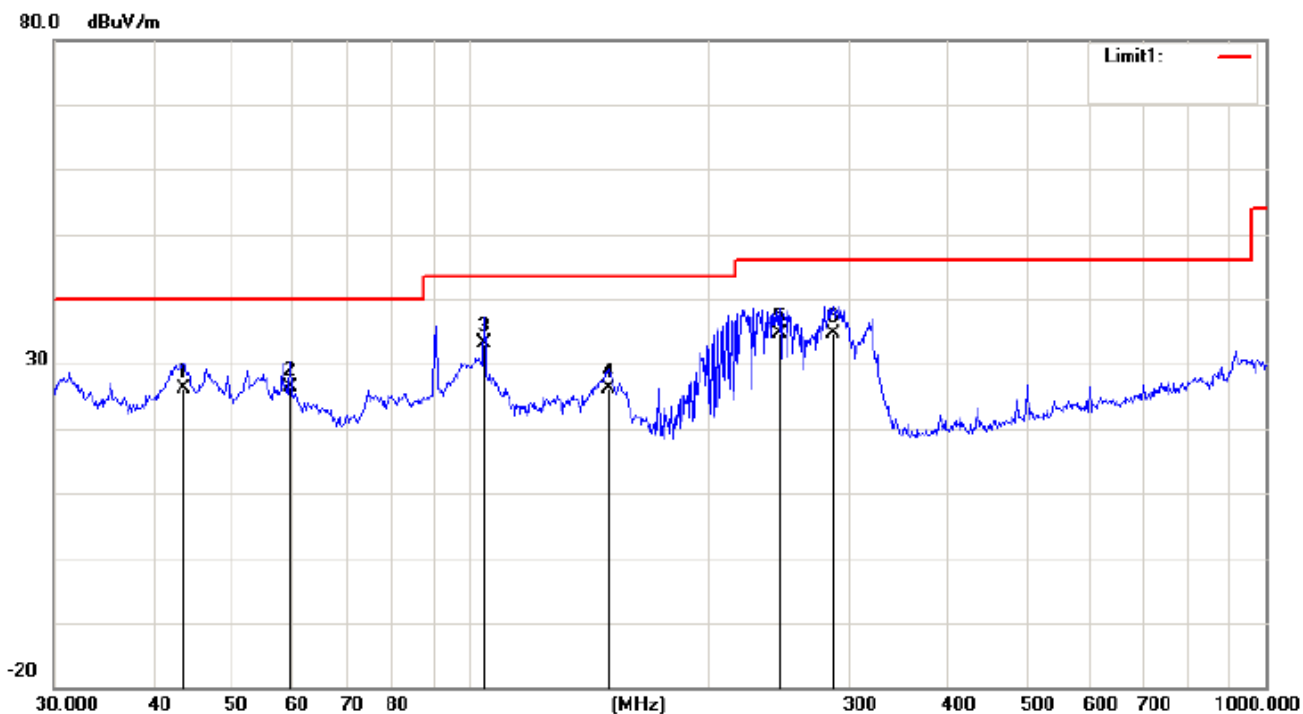

No.	Mk.	Freq. MHz	Reading Level dBuV	Correct Factor dB	Measure- ment dBuV/m	Limit dBuV/m	Over dB	Detector
1		43.6584	32.13	-6.01	26.12	40.00	-13.88	QP
2		59.4405	35.67	-9.40	26.27	40.00	-13.73	QP
3	*	104.1701	38.19	-5.18	33.01	43.50	-10.49	QP
4		149.4857	29.82	-3.81	26.01	43.50	-17.49	QP
5		245.0900	41.02	-6.42	34.60	46.00	-11.40	QP
6		285.9778	40.52	-5.96	34.56	46.00	-11.44	QP

Remark: All the modes have been investigated, and only worst mode is presented in this report.

EUT	Mobile phone	Model Name	X602
Temperature	20 °C	Relative Humidity	48%
Pressure	1010 hPa	Polarization :	Vertical
Test Mode	Mode 1	Test Date	September 06, 2016

80.0 dBuV/m

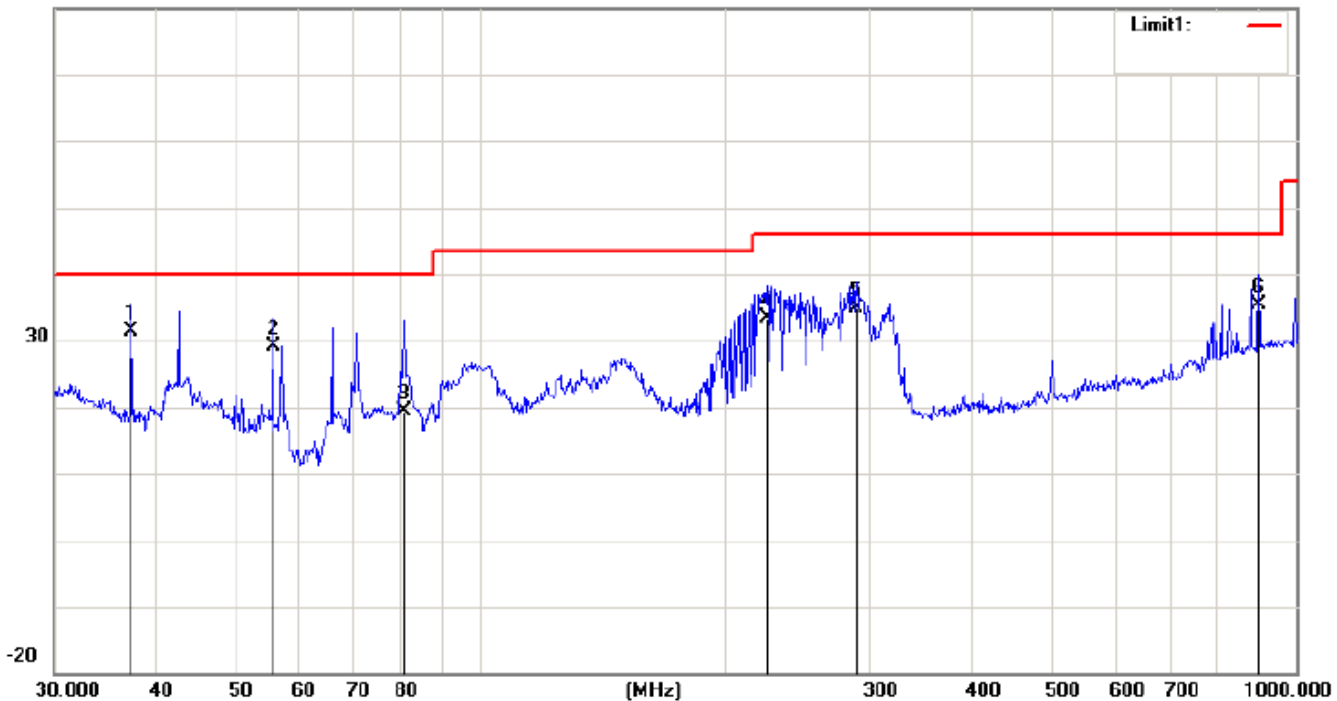

No.	Mk.	Freq. MHz	Reading Level dBuV	Correct Factor dB	Measure- ment dBuV/m	Limit dBuV/m	Over dB	Detector
1	*	37.2855	32.87	-1.53	31.34	40.00	-8.66	QP
2		55.6094	38.72	-9.49	29.23	40.00	-10.77	QP
3		80.6442	27.21	-7.78	19.43	40.00	-20.57	QP
4		224.5193	38.97	-5.70	33.27	46.00	-12.73	QP
5		289.0021	40.83	-5.91	34.92	46.00	-11.08	QP
6		900.1474	29.68	5.73	35.41	46.00	-10.59	QP

Remark: All the modes have been investigated, and only worst mode is presented in this report.

5.2.5.3 TEST RESULTS (1GHZ TO 25GHZ)

EUT	Mobile phone	Model Name	X602
Temperature	20 °C	Relative Humidity	48%
Pressure	1010 hPa	Test Mode	Mode 1 TX
Test Date	September 06, 2016	Frequency	2412MHz

Freq. (MHz)	Ant. Pol.	Emission Level(dBuV)		Limit 3m(dBuV/m)		Over(dB)	
		PK	AV	PK	AV	PK	AV
4824	V	60.01	39.62	74	54	-13.99	-14.38
7236	V	58.32	40.59	74	54	-15.68	-13.41
4824	H	59.17	40.24	74	54	-14.83	-13.76
7236	H	58.41	39.41	74	54	-15.59	-14.59

Remark:

All emissions not reported were more than 20dB below the specified limit or in the noise floor.

Factor = Antenna Factor + Cable Loss – Pre-amplifier.

All the x/y/z orientation has been investigated, and only worst case is presented in this report.

EUT	Mobile phone	Model Name	X602
Temperature	20 °C	Relative Humidity	48%
Pressure	1010 hPa	Test Mode	Mode 1 TX
Test Date	September 06, 2016	Frequency	2437MHz

Freq. (MHz)	Ant.Pol.	Emission Level(dBuV)		Limit 3m(dBuV/m)		Over(dB)	
		PK	AV	PK	AV	PK	AV
4874	V	60.94	39.91	74	54	-13.06	-14.09
7311	V	59.12	40.19	74	54	-14.88	-13.81
4874	H	58.92	40.84	74	54	-15.08	-13.16
7311	H	58.23	39.23	74	54	-15.77	-14.77

Remark:

All emissions not reported were more than 20dB below the specified limit or in the noise floor.

Factor = Antenna Factor + Cable Loss – Pre-amplifier.

All the x/y/z orientation has been investigated, and only worst case is presented in this report.

EUT	Mobile phone	Model Name	X602
Temperature	20 °C	Relative Humidity	48%
Pressure	1010 hPa	Test Mode	Mode 1 TX
Test Date	September 06, 2016	Frequency	2462MHz

Freq. (MHz)	Ant. Pol.	Emission Level(dBuV)		Limit 3m(dBuV/m)		Over(dB)	
		PK	AV	PK	AV	PK	AV
4924	V	59.19	41.24	74	54	-14.81	-12.76
7386	V	59.55	40.26	74	54	-14.45	-13.74
4924	H	59.88	39.51	74	54	-14.12	-14.49
7386	H	58.81	39.81	74	54	-15.19	-14.19

Remark:

All emissions not reported were more than 20dB below the specified limit or in the noise floor.

Factor = Antenna Factor + Cable Loss – Pre-amplifier.

All the x/y/z orientation has been investigated, and only worst case is presented in this report.

EUT	Mobile phone	Model Name	X602
Temperature	20 °C	Relative Humidity	48%
Pressure	1010 hPa	Test Mode	Mode2 TX
Test Date	September 06, 2016	Frequency	2412MHz

Freq. (MHz)	Ant. Pol.	Emission Level(dBuV)		Limit 3m(dBuV/m)		Over(dB)	
		PK	AV	PK	AV	PK	AV
4824	V	60.79	41.06	74	54	-13.21	-12.94
7236	V	58.68	40.66	74	54	-15.32	-13.34
4824	H	58.84	40.89	74	54	-15.16	-13.11
7236	H	59.45	40.45	74	54	-14.55	-13.55

Remark:

All emissions not reported were more than 20dB below the specified limit or in the noise floor.

Factor = Antenna Factor + Cable Loss – Pre-amplifier.

All the x/y/z orientation has been investigated, and only worst case is presented in this report.

EUT	Mobile phone	Model Name	X602
Temperature	20 °C	Relative Humidity	48%
Pressure	1010 hPa	Test Mode	Mode 2 TX
Test Date	September 06, 2016	Frequency	2437MHz

Freq. (MHz)	Ant.Pol.	Emission Level(dBuV)		Limit 3m(dBuV/m)		Over(dB)	
		PK	AV	PK	AV	PK	AV
4874	V	60.53	40.10	74	54	-13.47	-13.90
7311	V	58.98	40.93	74	54	-15.02	-13.07
4874	H	59.90	39.30	74	54	-14.10	-14.70
7311	H	58.72	39.72	74	54	-15.28	-14.28

Remark:

All emissions not reported were more than 20dB below the specified limit or in the noise floor.

Factor = Antenna Factor + Cable Loss – Pre-amplifier.

All the x/y/z orientation has been investigated, and only worst case is presented in this report.

EUT	Mobile phone	Model Name	X602
Temperature	20 °C	Relative Humidity	48%
Pressure	1010 hPa	Test Mode	Mode 2 TX
Test Date	September 06, 2016	Frequency	2462MHz

Freq. (MHz)	Ant.Pol.	Emission Level(dBuV)		Limit 3m(dBuV/m)		Over(dB)	
		PK	AV	PK	AV	PK	AV
4924	V	59.16	39.65	74	54	-14.84	-14.35
7386	V	58.27	40.96	74	54	-15.73	-13.04
4924	H	58.15	40.20	74	54	-15.85	-13.80
7386	H	58.91	39.91	74	54	-15.09	-14.09

Remark:

All emissions not reported were more than 20dB below the specified limit or in the noise floor.

Factor = Antenna Factor + Cable Loss – Pre-amplifier.

All the x/y/z orientation has been investigated, and only worst case is presented in this report.

EUT	Mobile phone	Model Name	X602
Temperature	20 °C	Relative Humidity	48%
Pressure	1010 hPa	Test Mode	Mode3 TX
Test Date	September 06, 2016	Frequency	2412MHz

Freq. (MHz)	Ant. Pol.	Emission Level(dBuV)		Limit 3m(dBuV/m)		Over(dB)	
		PK	AV	PK	AV	PK	AV
4824	V	59.48	41.00	74	54	-14.52	-13.00
7236	V	58.05	40.15	74	54	-15.95	-13.85
4824	H	59.60	40.06	74	54	-14.40	-13.94
7236	H	58.82	39.82	74	54	-15.18	-14.18

Remark:

All emissions not reported were more than 20dB below the specified limit or in the noise floor.
Factor = Antenna Factor + Cable Loss – Pre-amplifier.

All the x/y/z orientation has been investigated, and only worst case is presented in this report.

EUT	Mobile phone	Model Name	X602
Temperature	20 °C	Relative Humidity	48%
Pressure	1010 hPa	Test Mode	Mode 3 TX
Test Date	September 06, 2016	Frequency	2437MHz

Freq. (MHz)	Ant. Pol.	Emission Level(dBuV)		Limit 3m(dBuV/m)		Over(dB)	
		PK	AV	PK	AV	PK	AV
4874	V	60.82	40.98	74	54	-13.18	-13.02
7311	V	59.79	40.43	74	54	-14.21	-13.57
4874	H	59.22	39.81	74	54	-14.78	-14.19
7311	H	59.58	40.58	74	54	-14.42	-13.42

Remark:

All emissions not reported were more than 20dB below the specified limit or in the noise floor.
Factor = Antenna Factor + Cable Loss – Pre-amplifier.

All the x/y/z orientation has been investigated, and only worst case is presented in this report.

EUT	Mobile phone	Model Name	X602
Temperature	20 °C	Relative Humidity	48%
Pressure	1010 hPa	Test Mode	Mode 3 TX
Test Date	September 06, 2016	Frequency	2462MHz

Freq. (MHz)	Ant.Pol.	Emission Level(dBuV)		Limit 3m(dBuV/m)		Over(dB)	
		PK	AV	PK	AV	PK	AV
4924	V	59.49	40.19	74	54	-14.51	-13.81
7386	V	59.64	39.92	74	54	-14.36	-14.08
4924	H	59.68	40.57	74	54	-14.32	-13.43
7386	H	58.27	39.27	74	54	-15.73	-14.73

Remark:

All emissions not reported were more than 20dB below the specified limit or in the noise floor.
Factor = Antenna Factor + Cable Loss – Pre-amplifier.

All the x/y/z orientation has been investigated, and only worst case is presented in this report.

EUT	Mobile phone	Model Name	X602
Temperature	20 °C	Relative Humidity	48%
Pressure	1010 hPa	Test Mode	Mode4 TX
Test Date	September 06, 2016	Frequency	2422MHz

Freq. (MHz)	Ant. Pol.	Emission Level(dBuV)		Limit 3m(dBuV/m)		Over(dB)	
		PK	AV	PK	AV	PK	AV
4844	V	59.52	39.78	74	54	-14.48	-14.22
7266	V	59.25	39.95	74	54	-14.75	-14.05
4844	H	58.53	40.87	74	54	-15.47	-13.13
7266	H	58.78	39.78	74	54	-15.22	-14.22

Remark:

All emissions not reported were more than 20dB below the specified limit or in the noise floor.
Factor = Antenna Factor + Cable Loss – Pre-amplifier.

All the x/y/z orientation has been investigated, and only worst case is presented in this report.

EUT	Mobile phone	Model Name	X602
Temperature	20 °C	Relative Humidity	48%
Pressure	1010 hPa	Test Mode	Mode 4 TX
Test Date	September 06, 2016	Frequency	2437MHz

Freq. (MHz)	Ant.Pol.	Emission Level(dBuV)		Limit 3m(dBuV/m)		Over(dB)	
		PK	AV	PK	AV	PK	AV
4874	V	60.39	41.76	74	54	-13.61	-12.24
7311	V	59.67	40.73	74	54	-14.33	-13.27
4874	H	58.22	40.90	74	54	-15.78	-13.10
7311	H	59.17	40.17	74	54	-14.83	-13.83

Remark:

All emissions not reported were more than 20dB below the specified limit or in the noise floor.

Factor = Antenna Factor + Cable Loss – Pre-amplifier.

All the x/y/z orientation has been investigated, and only worst case is presented in this report.

EUT	Mobile phone	Model Name	X602
Temperature	20 °C	Relative Humidity	48%
Pressure	1010 hPa	Test Mode	Mode 4 TX
Test Date	September 06, 2016	Frequency	2452MHz

Freq. (MHz)	Ant.Pol.	Emission Level(dBuV)		Limit 3m(dBuV/m)		Over(dB)	
		PK	AV	PK	AV	PK	AV
4904	V	60.69	40.75	74	54	-13.31	-13.25
7356	V	59.33	40.11	74	54	-14.67	-13.89
4904	H	58.80	40.79	74	54	-15.20	-13.21
7356	H	58.94	39.94	74	54	-15.06	-14.06

Remark:

All emissions not reported were more than 20dB below the specified limit or in the noise floor.

Factor = Antenna Factor + Cable Loss – Pre-amplifier.

All the x/y/z orientation has been investigated, and only worst case is presented in this report.

6. ANTENNA APPLICATION

6.1 Antenna requirement

The EUT'S antenna is met the requirement of FCC part 15C section 15.203 and 15.247

FCC part 15C section 15.247 requirements: Systems operating in the 2402-2480MHz band that are used exclusively for fixed, point-to-point operations may employ transmitting antennas with directional gain greater than 6dBi provided the maximum peak output power of the intentional radiator is reduced by 1dB for every 3dB that the directional gain of the antenna exceeds 6dBi.

6.2 Result

The EUT's antenna integrated on PCB, The antenna's gain is -4dBi and meets the requirement.

7.0. 6DB BANDWIDTH MEASUREMENT

7.1 TEST SETUP

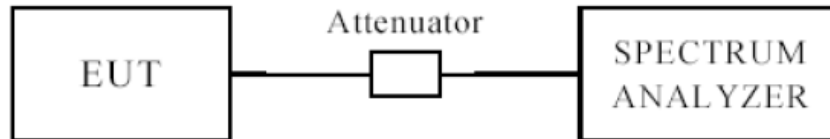

7.2 LIMITS OF 6DB BANDWIDTH MEASUREMENT

The minimum of 6dB Bandwidth Measurement is >500 kHz

7.3 TEST PROCEDURE

1. Set resolution bandwidth (RBW) = 100 kHz
2. Set the video bandwidth (VBW) $\geq 3 \times$ RBW.
3. Detector = Peak.
4. Trace mode = max hold.
5. Sweep = auto couple.
6. Allow the trace to stabilize.
7. Measure the maximum width of the emission that is constrained by the frequencies associated with the two outermost amplitude points (upper and lower) that are attenuated by 6 dB relative to the maximum level measured in the fundamental emission.

7.4 TEST RESULT

6dB Occupied Bandwidth

EUT		Mobile phone		Model		X602	
Mode		802.11b		Humidity		56% RH	
Temperature		24 deg. C,					
Channel	Channel Frequency (MHz)	Data Transfer Rate (Mbps)	6 dB Bandwidth (kHz)	Minimum Limit (MHz)	Pass/ Fail		
1	2412	1	8205.1	0.5	Pass		
6	2437	1	8141.0	0.5	Pass		
11	2462	1	8589.7	0.5	Pass		

EUT		Mobile phone		Model		X602	
Mode		802.11g		Humidity		56% RH	
Temperature		24 deg. C,					
Channel	Channel Frequency (MHz)	Data Transfer Rate (Mbps)	6 dB Bandwidth (kHz)	Minimum Limit (MHz)	Pass/ Fail		
1	2412	6	11666.7	0.5	Pass		
6	2437	6	11923.1	0.5	Pass		
11	2462	6	15128.2	0.5	Pass		

EUT		Mobile phone		Model		X602	
Mode		802.11n20		Humidity		56% RH	
Temperature		24 deg. C,					
Channel	Channel Frequency (MHz)	Data Transfer Rate (Mbps)	6 dB Bandwidth (kHz)	Minimum Limit (MHz)	Pass/ Fail		
1	2412	6.5	11346.2	0.5	Pass		
6	2437	6.5	12051.3	0.5	Pass		
11	2462	6.5	15897.4	0.5	Pass		

EUT		Mobile phone		Model		X602	
Mode		802.11n40		Humidity		56% RH	
Temperature		24 deg. C,					
Channel	Channel Frequency (MHz)	Data Transfer Rate (Mbps)	6 dB Bandwidth (kHz)	Minimum Limit (MHz)	Pass/ Fail		
3	2422	13.5	35897.4	0.5	Pass		
6	2437	13.5	36282.1	0.5	Pass		
9	2452	13.5	36153.8	0.5	Pass		

802.11b at 1Mbps of CH1

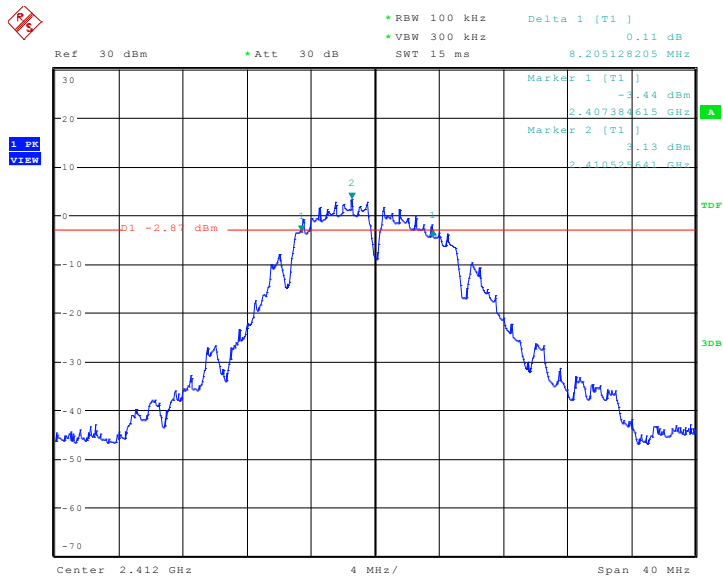

Date: 20.SEP.2016 09:32:01

802.11b at 1Mbps of CH6

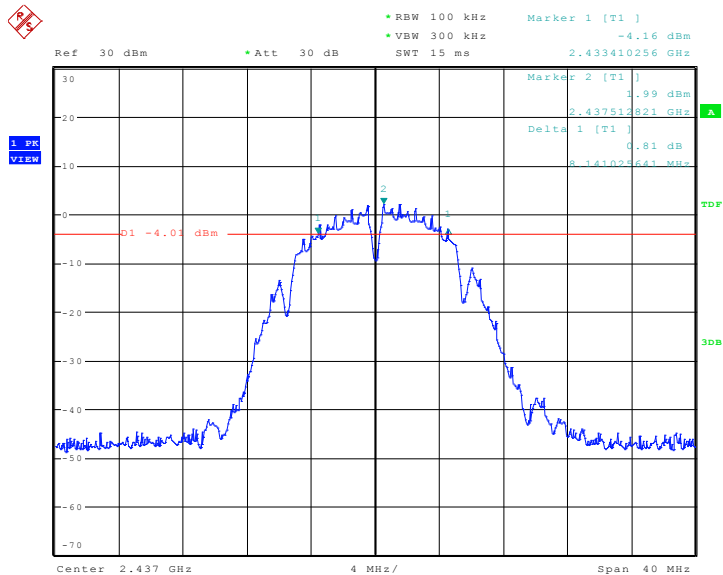

Date: 20.SEP.2016 09:33:38

802.11b at 1Mbps of CH11

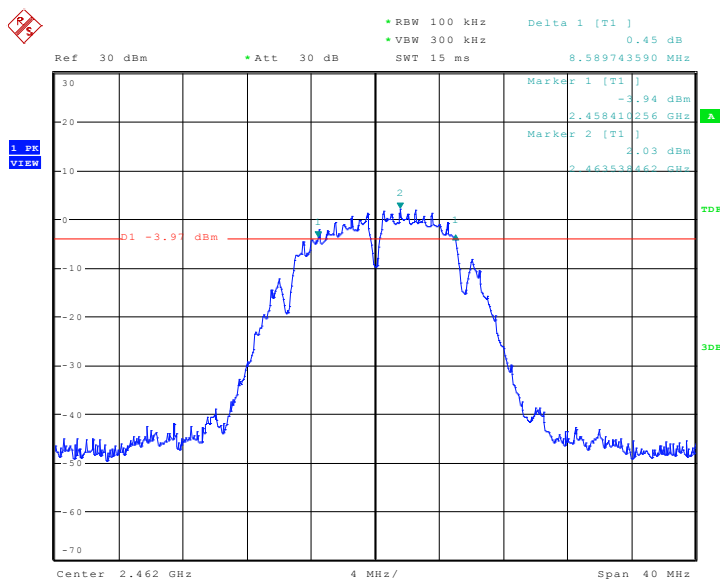

Date: 20.SEP.2016 09:35:06

802.11g at 6Mbps of CH1

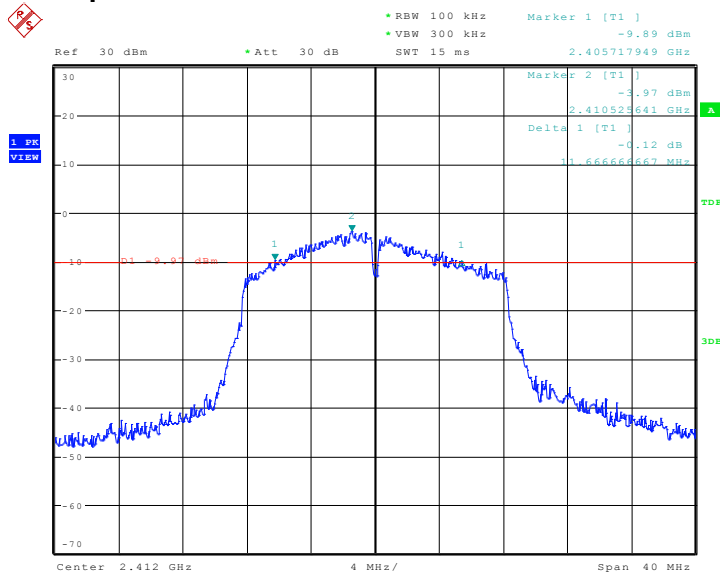

Date: 20.SEP.2016 09:36:05

802.11g at 6Mbps of CH6

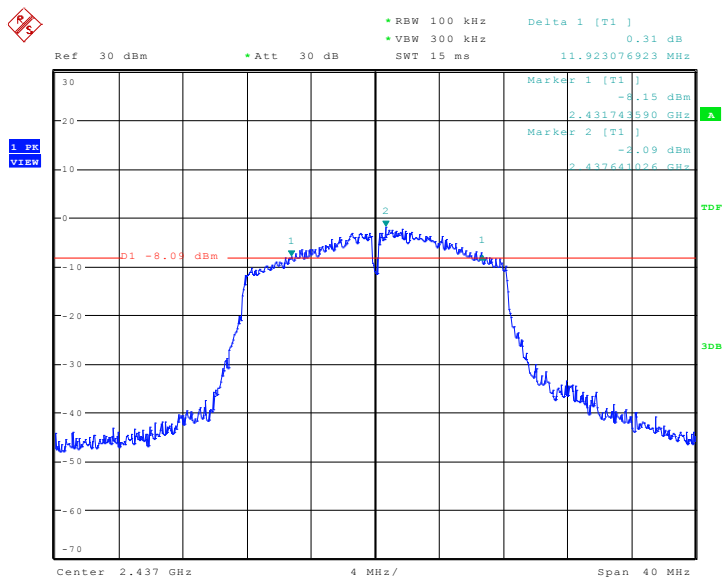

Date: 20.SEP.2016 09:37:08

802.11g at 6Mbps of CH11

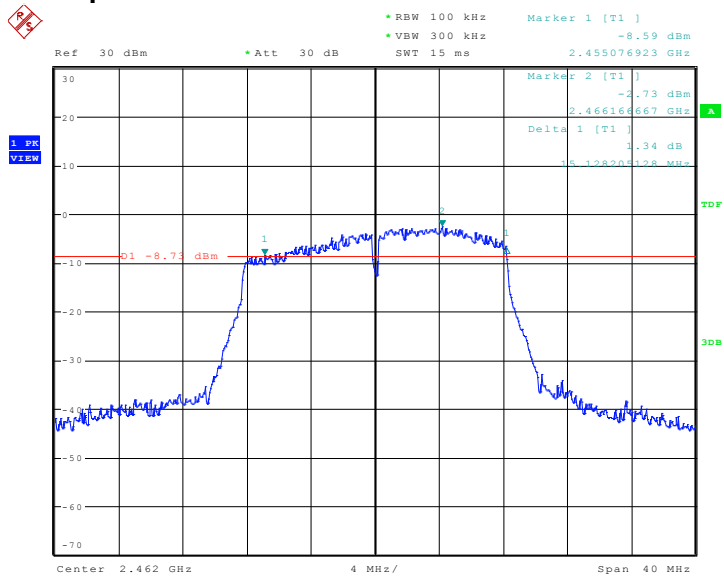

Date: 20.SEP.2016 09:38:43

802.11n at HT20 of CH1

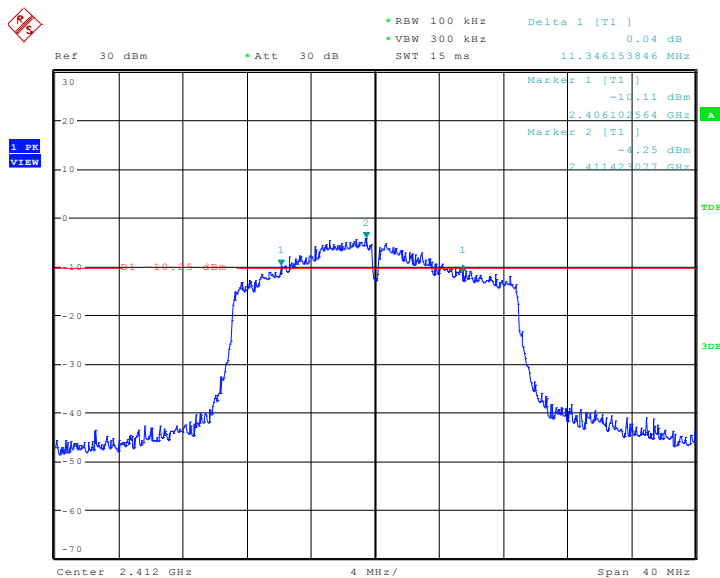

Date: 20.SEP.2016 09:39:32

802.11n at HT20 of CH6

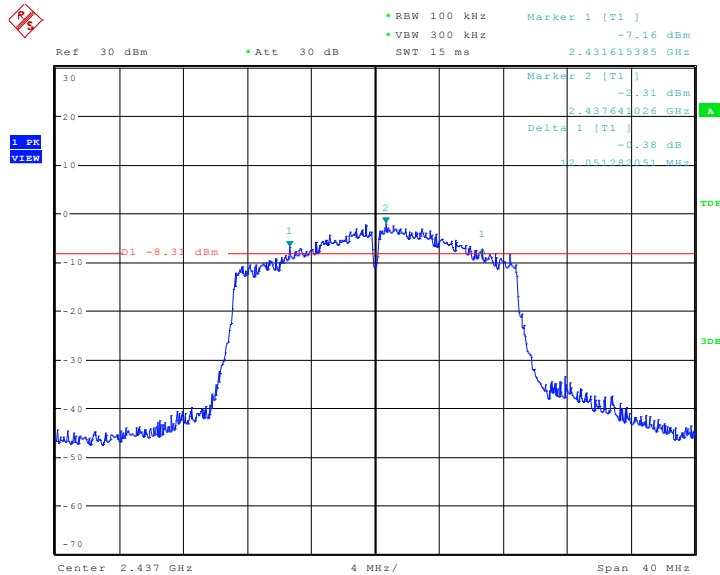

Date: 20.SEP.2016 09:41:02

802.11n at HT20 of CH11

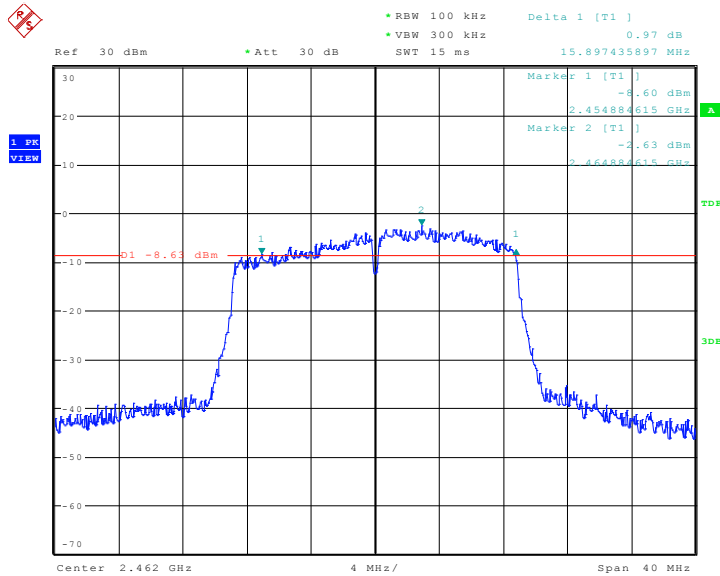

Date: 20.SEP.2016 09:41:51

802.11n at HT40 of CH3

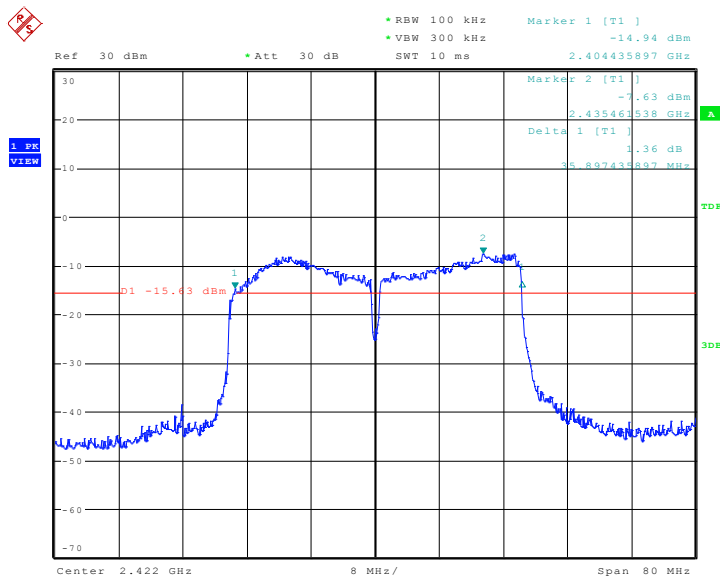

Date: 20.SEP.2016 09:45:01

802.11n at HT40 of CH6

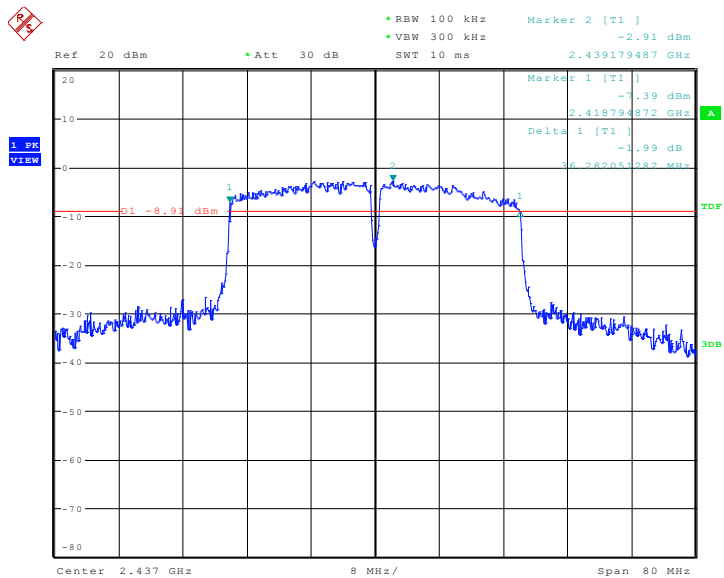

802.11n at HT40 of CH9

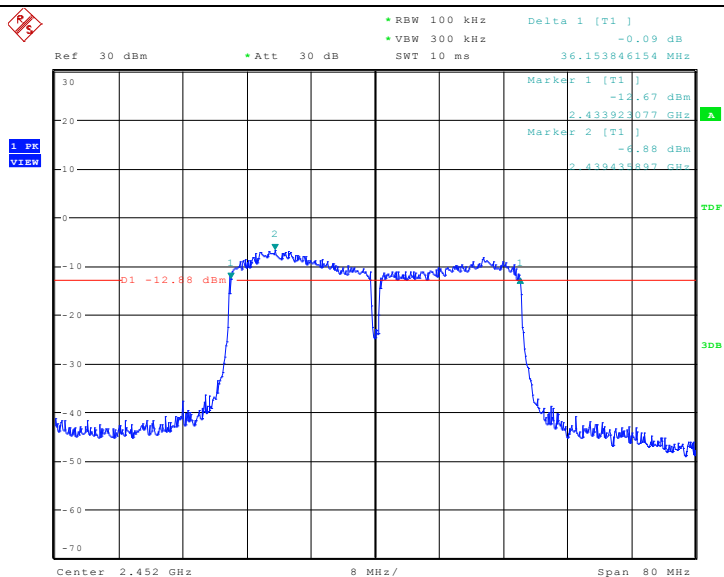

Date: 20.SEP.2016 09:46:34

8.0. MAXIMUM PEAK OUTPUT POWER

8.1 TEST SETUP

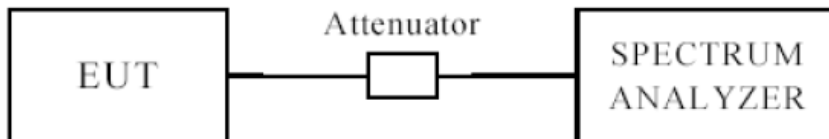

8.2 LIMITS OF MAXIMUM PEAK OUTPUT POWER

The Maximum Peak Output Power Measurement is 30dBm.

8.3 TEST PROCEDURE

The RF power output was measured with a spectrum analyzer connected to the RF Antenna connector measurement while EUT was operating in transmit mode at the appropriate centre frequency.

Note: the peak power was measured.

8.4 TEST RESULTS

EUT	Mobile phone	Model	X602	
Mode	802.11b	Humidity	56% RH	
Temperature	24 deg. C,			
Channel	Channel Frequency (MHz)	Peak Power Output (dBm)	Peak Power Limit (dBm)	Pass/ Fail
1	2412	14.46	30	Pass
6	2437	17.00	30	Pass
11	2462	17.44	30	Pass

Note: 1. At final test to get the worst-case emission at 1Mbps for CH1, CH6 and CH11

2. The result basic equation calculation as follow:

Peak Power Output = Peak Power Reading + Cable loss + Attenuator

3. The worse case was recorded

EUT	Mobile phone	Model	X602	
Mode	802.11g	Humidity	56% RH	
Temperature	24 deg. C,			
Channel	Channel Frequency (MHz)	Peak Power Output (dBm)	Peak Power Limit (dBm)	Pass/ Fail
1	2412	12.73	30	Pass
6	2437	14.64	30	Pass
11	2462	15.18	30	Pass

Note: 1. At final test to get the worst-case emission at 6 Mbps for CH1, CH6 and CH11

2. The result basic equation calculation as follow:

Peak Power Output = Peak Power Reading + Cable loss + Attenuator

3. The worse case was recorded

EUT		Mobile phone		Model		X602	
Mode		802.11n(HT20)		Humidity		56% RH	
Temperature		24 deg. C,					
Channel	Channel Frequency (MHz)	Peak Power Output (dBm)	Peak Power Limit (dBm)	Pass/ Fail			
1	2412	12.43	30	Pass			
6	2437	14.78	30	Pass			
11	2462	15.15	30	Pass			

Note: 1. At final test to get the worst-case emission at 6.5Mbps for CH1, CH6 and CH11

2. The result basic equation calculation as follow:

Peak Power Output = Peak Power Reading + Cable loss + Attenuator

3. The worse case was recorded

EUT		Mobile phone		Model		X602	
Mode		802.11n (HT40)		Humidity		56% RH	
Temperature		24 deg. C,					
Channel	Channel Frequency (MHz)	Peak Power Output (dBm)	Peak Power Limit (dBm)	Pass/ Fail			
3	2422	10.63	30	Pass			
6	2437	12.25	30	Pass			
9	2452	12.16	30	Pass			

Note: 1. At final test to get the worst-case emission at 13.5Mbps for CH3, CH6 and CH9

2. The result basic equation calculation as follow:

Peak Power Output = Peak Power Reading + Cable loss + Attenuator

3. The worse case was recorded.

802.11b at 1Mbps of CH1

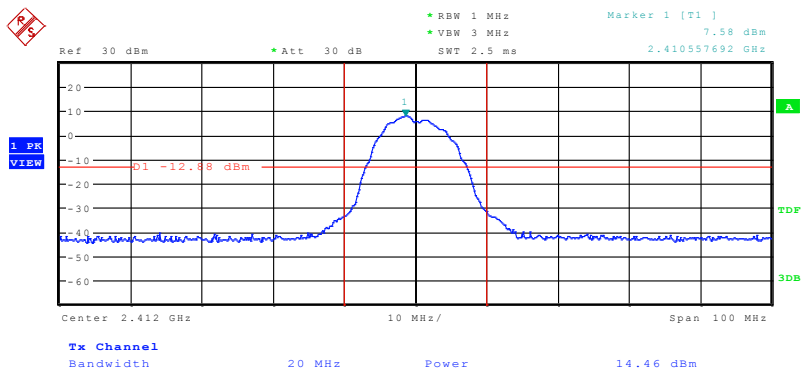

Date: 20.SEP.2016 09:57:20

802.11b at 1Mbps of CH6

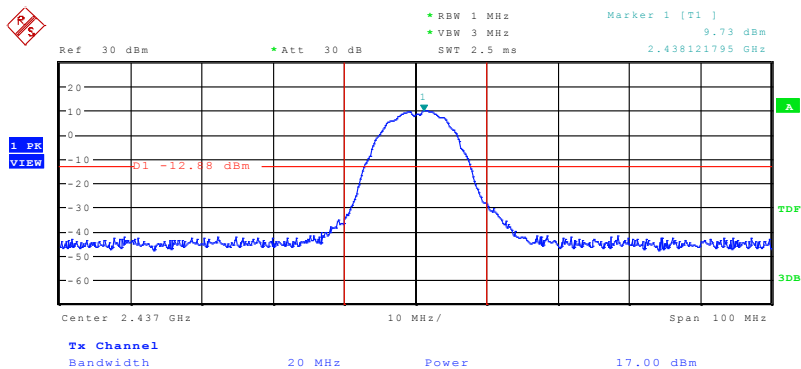

Date: 20.SEP.2016 09:57:46

802.11b at 1Mbps of CH11

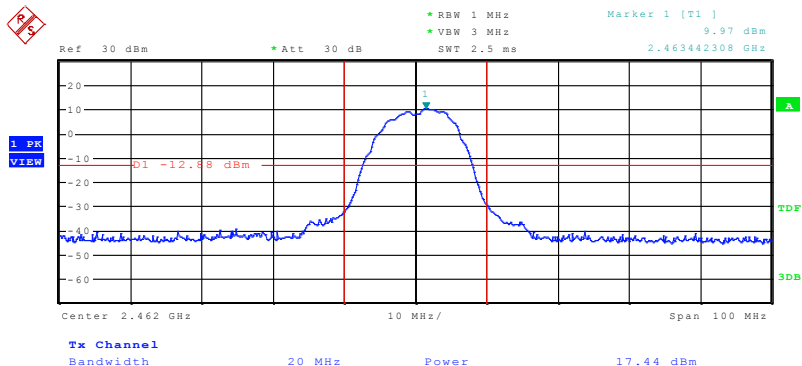

Date: 20.SEP.2016 09:58:08

802.11g at 6Mbps of CH1

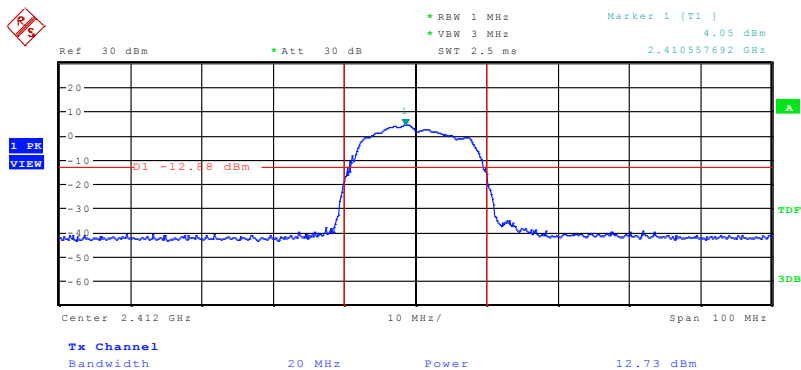

Date: 20.SEP.2016 10:00:07

802.11g at 6Mbps of CH6

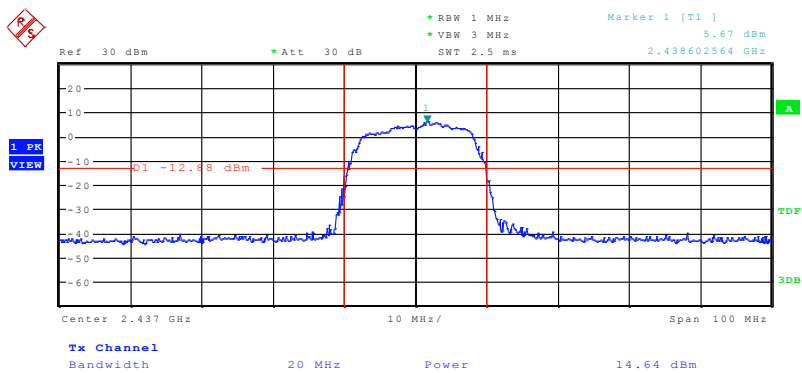

Date: 20.SEP.2016 10:00:53

802.11g at 6Mbps of CH11

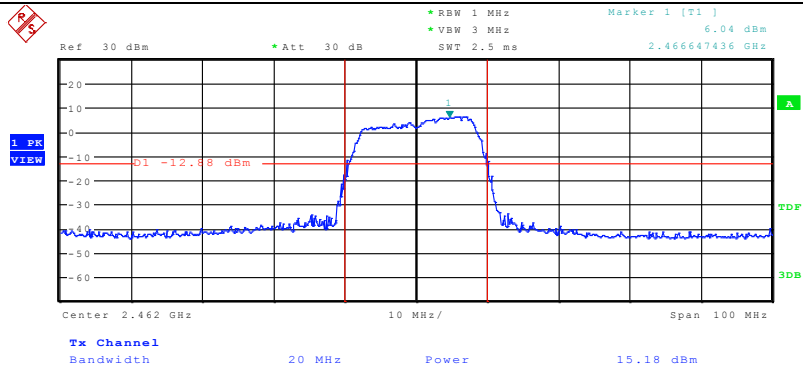

Date: 20.SEP.2016 10:01:16

802.11n HT-20 at 6.5Mbps of CH1

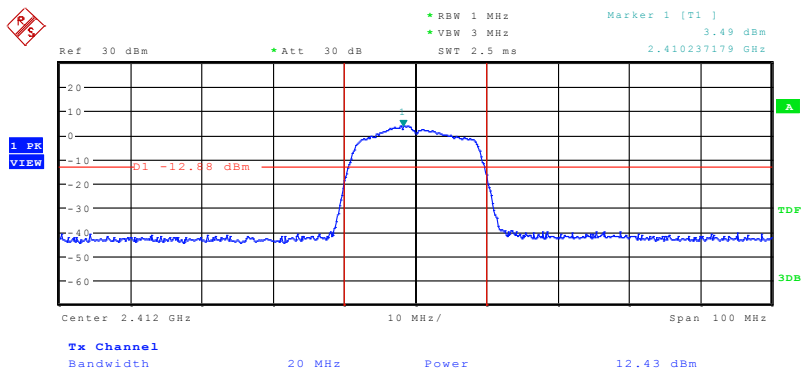

Date: 20.SEP.2016 10:01:49

802.11n HT-20 at 6.5Mbps of CH6

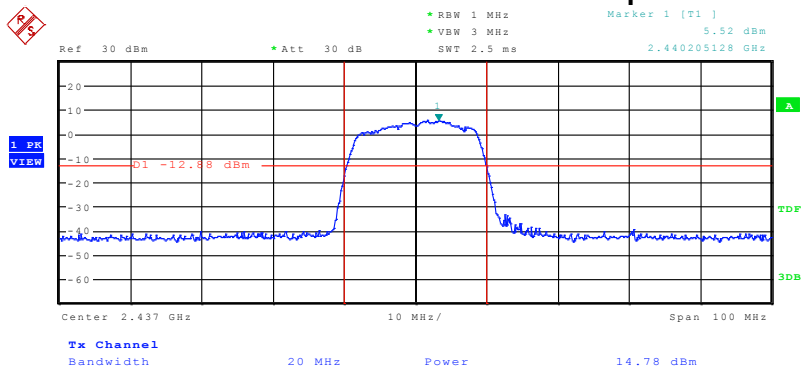

Date: 20.SEP.2016 10:02:10

802.11n HT-20 at 6.5Mbps of CH11

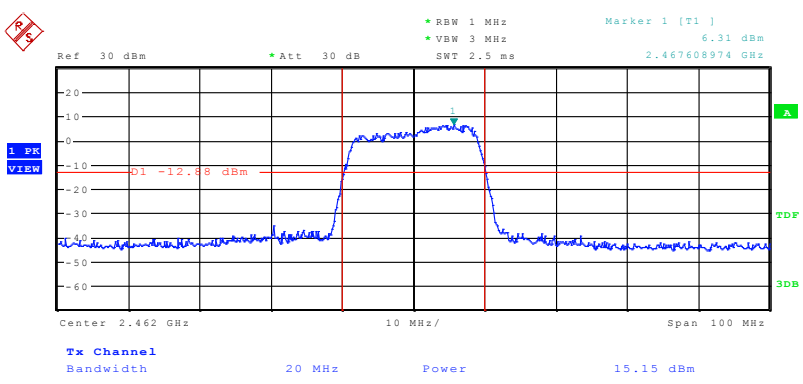

Date: 20.SEP.2016 10:02:42

802.11n HT-40 at 13.5Mbps of CH3

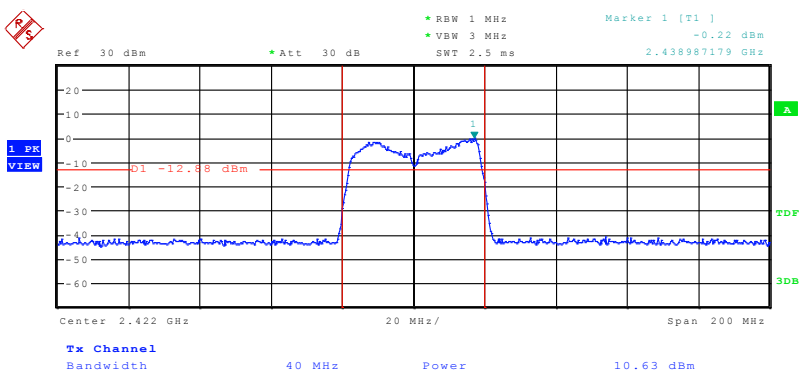

Date: 20.SEP.2016 10:03:56

802.11n HT-40 at 13.5Mbps of CH6

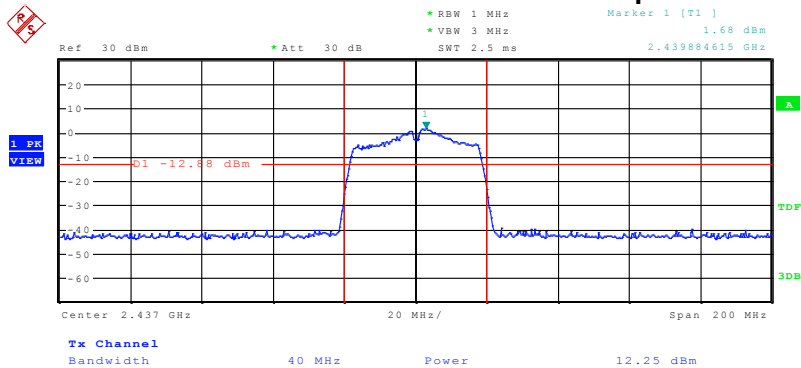

Date: 20.SEP.2016 10:04:38

802.11n HT-40 at 13.5Mbps of CH9

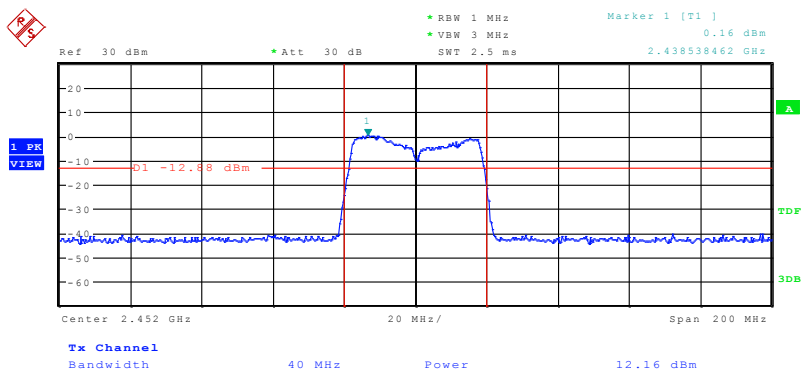

Date: 20.SEP.2016 10:05:05

9. POWER SPECTRAL DENSITY MEASUREMENT

9.1 TEST SETUP

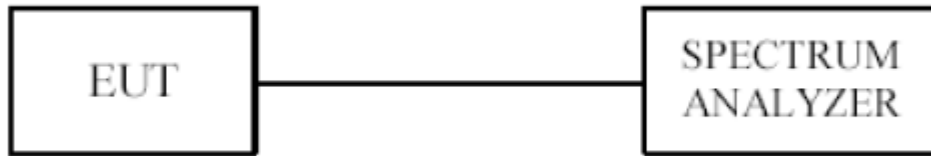

9.2 LIMITS OF POWER SPECTRAL DENSITY MEASUREMENT

The Maximum Power Spectral Density Measurement is 8dBm.

9.3 TEST PROCEDURE

1. Use this procedure when the maximum peak conducted output power in the fundamental emission is used to demonstrate compliance.
2. Set the RBW = 3 kHz.
3. Set the VBW = 10 kHz.
4. Set the span to 1.5 times the DTS channel bandwidth.
5. Detector = peak.
6. Sweep time = auto couple.
7. Trace mode = max hold.
8. Allow trace to fully stabilize.
9. Use the peak marker function to determine the maximum amplitude level.
10. If measured value exceeds limit, reduce RBW (no less than 3 kHz) and repeat.
11. The resulting peak PSD level must be ≤ 8 dBm.

9.4 TEST RESULT

EUT	Mobile phone	Model	X602	
Mode	802.11b	Humidity	56% RH	
Temperature	24 deg. C,			
Channel	Channel Frequency (MHz)	Final RF Power Level in (dBm)	Maximum Limit (dBm)	Pass/ Fail
1Mbps				
1	2412	-17.41	8	Pass
6	2437	-15.63	8	Pass
11	2462	-15.70	8	Pass

EUT	Mobile phone	Model	X602	
Mode	802.11g	Humidity	56% RH	
Temperature	24 deg. C,			
Channel	Channel Frequency (MHz)	Final RF Power Level in (dBm)	Maximum Limit (dBm)	Pass/ Fail
6Mbps				
1	2412	-17.32	8	Pass
6	2437	-17.10	8	Pass
11	2462	-17.37	8	Pass

EUT	Mobile phone	Model	X602	
Mode	802.11n HT20	Humidity	56% RH	
Temperature	24 deg. C,			
Channel	Channel Frequency (MHz)	Final RF Power Level in (dBm)	Maximum Limit (dBm)	Pass/ Fail
6.5Mbps				
1	2412	-17.84	8	Pass
6	2437	-16.12	8	Pass
11	2462	-16.83	8	Pass

EUT	Mobile phone	Model	X602	
Mode	802.11n HT40	Humidity	56% RH	
Temperature	24 deg. C,			
Channel	Channel Frequency (MHz)	Final RF Power Level in (dBm)	Maximum Limit (dBm)	Pass/ Fail
13.5Mbps				
3	2422	-18.30	8	Pass
6	2437	-18.25	8	Pass
9	2452	-20.17	8	Pass

Remark: All of the modes have been investigated, and only worst mode is presented in this report.

802.11b at 1Mbps of CH1

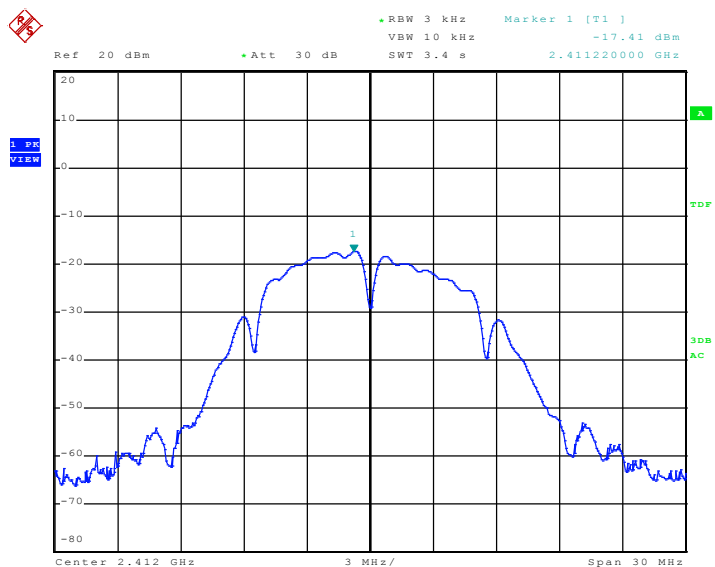

Date: 20.SEP.2016 10:27:09

802.11b at 1Mbps at CH6

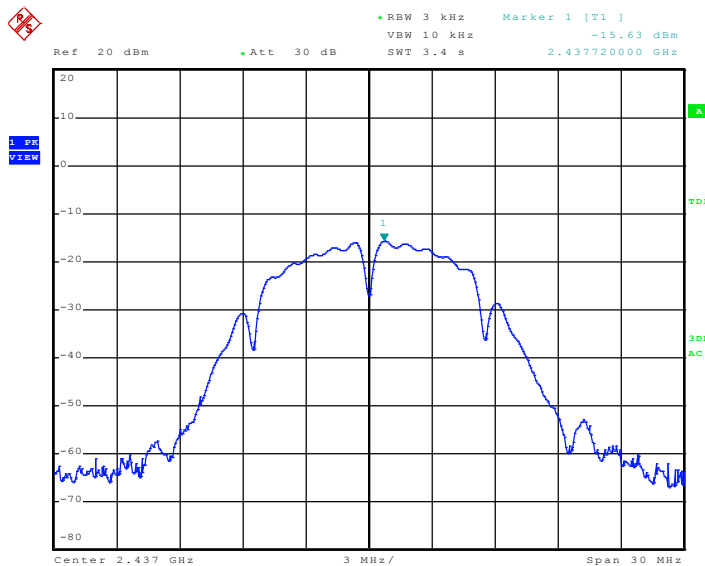

Date: 20.SEP.2016 10:27:30

802.11b at 1Mbps of CH11

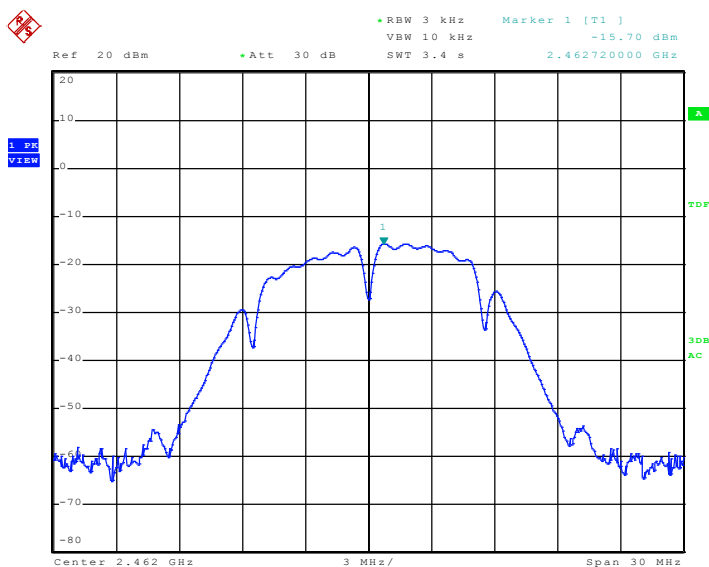

Date: 20.SEP.2016 10:27:58

802.11g at 6Mbps of CH1

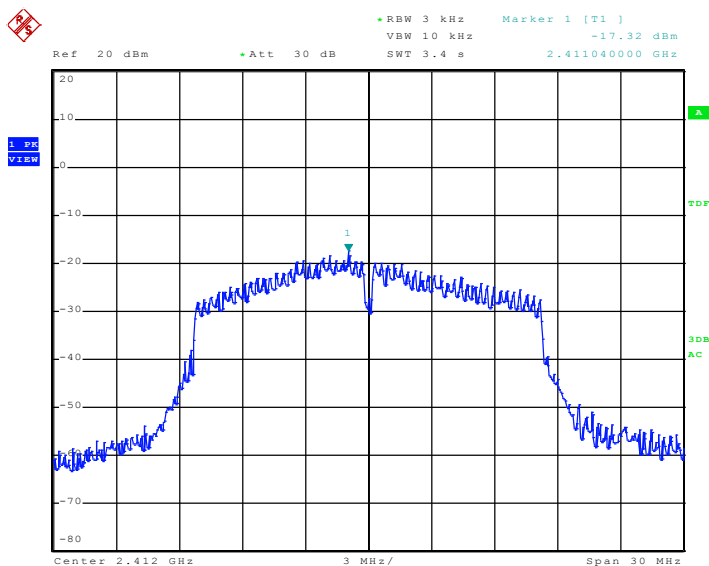

Date: 20.SEP.2016 10:28:27

802.11g at 6Mbps of CH6

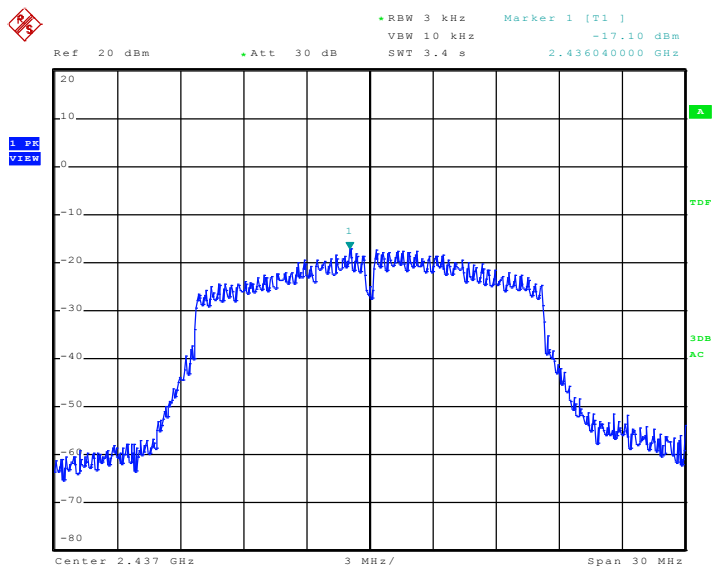

802.11g at 6Mbps of CH11

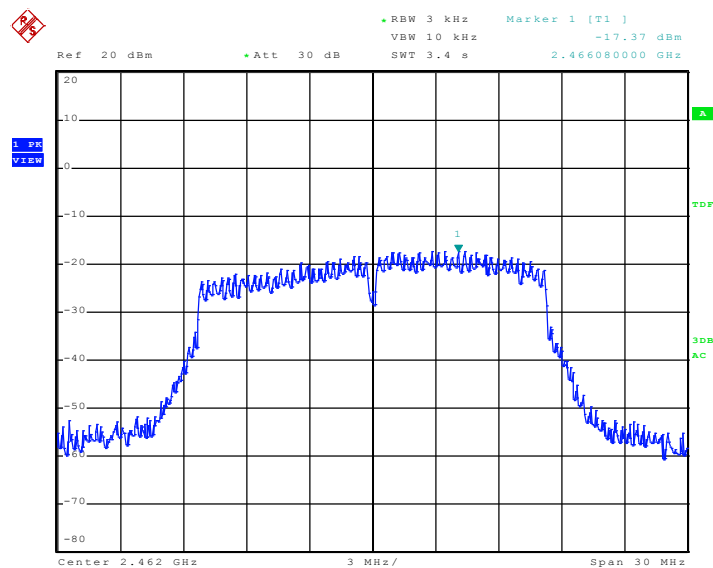

Date: 20.SEP.2016 10:29:14

802.11n HT20 at 6.5Mbps of CH1

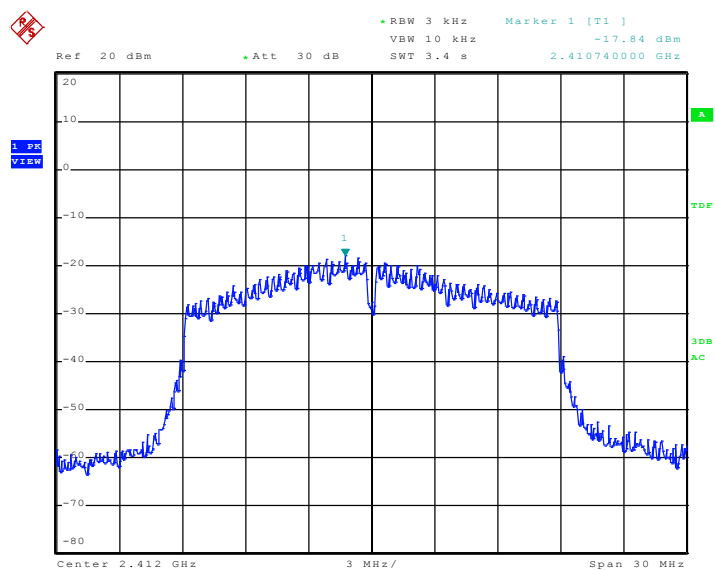

Date: 20.SEP.2016 10:29:59

802.11n HT20 at 6.5Mbps of CH6

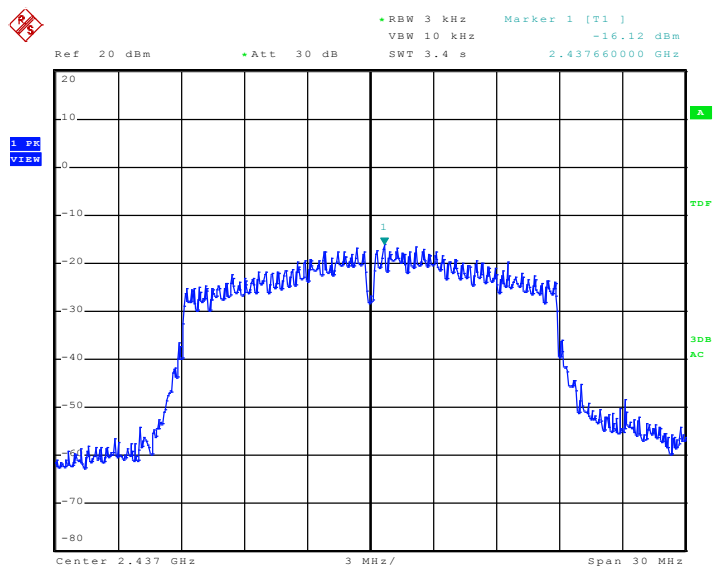

Date: 20.SEP.2016 10:30:21

802.11n HT20 at 6.5Mbps of CH11

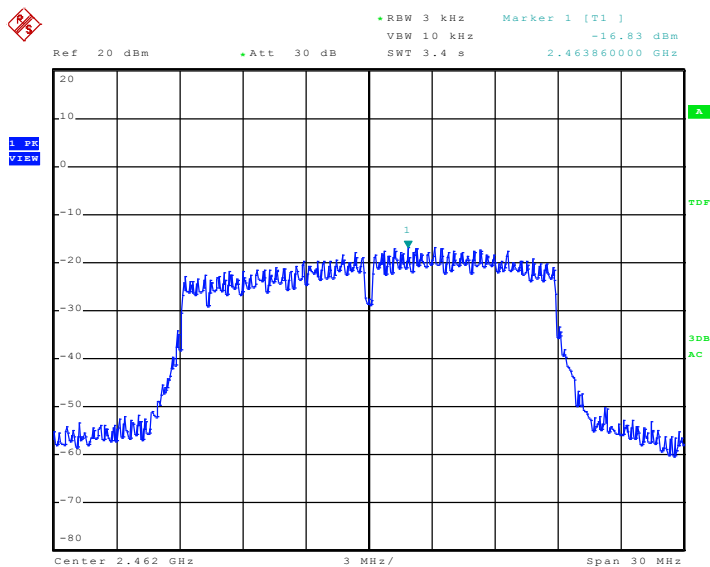

Date: 20.SEP.2016 10:30:50

802.11n HT40 at 13.5Mbps of CH3

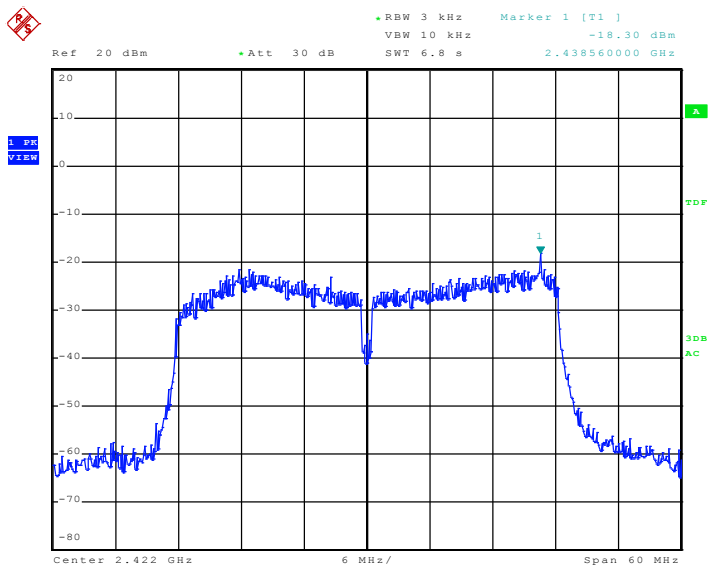

Date: 20.SEP.2016 10:31:23

802.11n HT40 at 13.5Mbps of CH6

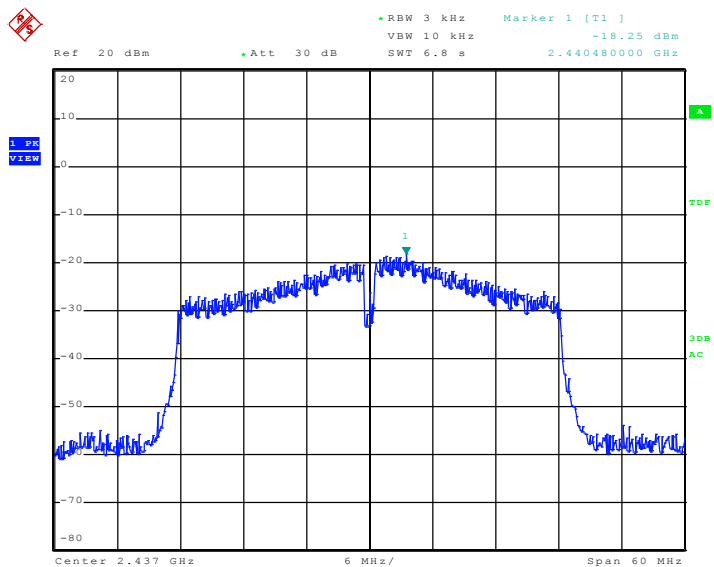

Date: 20.SEP.2016 10:32:07

802.11n HT40 at 13.5Mbps of CH9

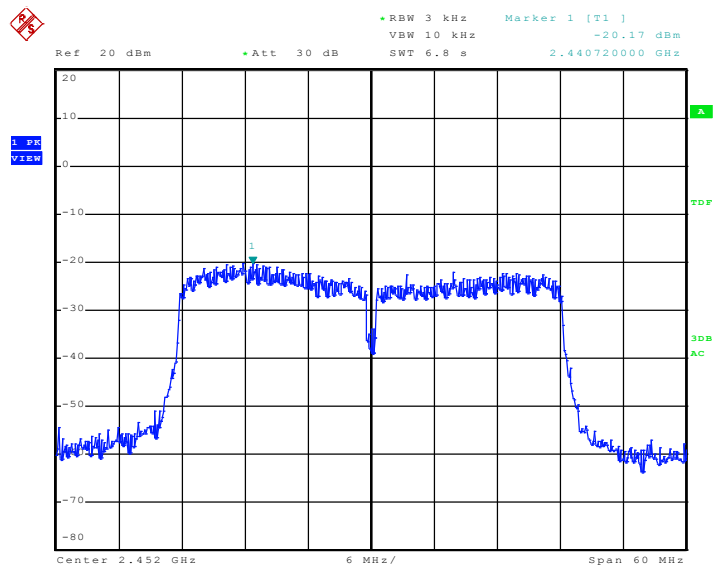

Date: 20.SEP.2016 10:33:01

10. OUT OF BAND MEASUREMENT

10.1 TEST SETUP FOR BAND EDGE

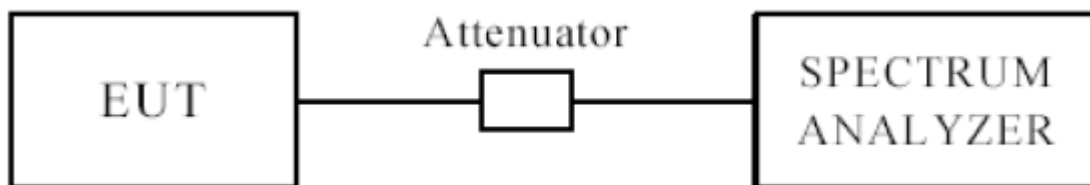

The restricted band requirement based on radiated emission test; please see the clause 6 for the test setup

10.2 LIMITS OF OUT OF BAND EMISSIONS MEASUREMENT

1. Below -20dB of the highest emission level of operating band (in 100kHz Resolution Bandwidth).
2. Fall in the restricted bands listed in section 15.205. The maximum permitted average field strength is listed in section 15.209.

10.3 TEST PROCEDURE

For signals in the restricted bands above and below the $2.4\text{-}2.483\text{GHz}$ allocated band a measurement was made of radiated emission test. (Peak values with $\text{RBW}=\text{VBW}=1\text{MHz}$ and PK detector. AV value with $\text{RBW}=1\text{MHz}$, $\text{VBW}=10\text{Hz}$ and PK detector)

For bandage test, the spectrum set as follows: $\text{RBW}=100\text{ kHz}$, $\text{VBW}=100\text{ kHz}$. A conducted measurement used

10.4 TEST RESULT

Please see next pages

Note: This is a handheld device. The radiated emissions should be tested under 3-axes position (Lying, Stand), After pre-test. It was found that the worse radiated emission was get at the lying position.

Radiated measurement:**802.11b**

Indicated		result (PK/AV)	Antenna Polar (H/V)	Correction Factor			FCC Part 15.247		
Frequency (MHz)	Receiver Reading (dB μ V/m)			Ant. Factor (dB/m)	Cable Loss (dB)	Pre-Amp. Gain (dB)	Cord. Amp. (dB μ V/m)	Limit (dB μ V/m)	Margin (dB)
Low Channel (2412MHz)									
2390	31.22	AV	V	30.3	4.1	33.1	32.52	54	21.48
2390	30.99	AV	H	30.3	4.1	33.1	32.29	54	21.71
2390	39.42	PK	V	30.3	4.1	33.1	40.72	74	33.28
2390	42.03	PK	H	30.3	4.1	33.1	43.33	74	30.67
High Channel (2462MHz)									
2483.5	29.88	AV	V	31	4.4	32.7	32.58	54	21.42
2483.5	31.33	AV	H	31	4.4	32.7	34.03	54	19.97
2483.5	40.63	PK	V	31	4.4	32.7	43.33	74	30.67
2483.5	39.89	PK	H	31	4.4	32.7	42.59	74	31.41

802.11g

Indicated		result (PK/AV)	Antenna Polar (H/V)	Correction Factor			FCC Part 15.247		
Frequency (MHz)	Receiver Reading (dB μ V/m)			Ant. Factor (dB/m)	Cable Loss (dB)	Pre-Amp. Gain (dB)	Cord. Amp. (dB μ V/m)	Limit (dB μ V/m)	Margin (dB)
Low Channel (2412MHz)									
2390	34.39	AV	V	30.3	4.1	33.1	35.69	54	18.31
2390	35.04	AV	H	30.3	4.1	33.1	36.34	54	17.66
2390	49.35	PK	V	30.3	4.1	33.1	50.65	74	23.35
2390	50.02	PK	H	30.3	4.1	33.1	51.32	74	22.68
High Channel (2462MHz)									
2483.5	31.31	AV	V	31	4.4	32.7	34.01	54	19.99
2483.5	31.53	AV	H	31	4.4	32.7	34.23	54	19.77
2483.5	41.79	PK	V	31	4.4	32.7	44.49	74	29.51
2483.5	40.34	PK	H	31	4.4	32.7	43.04	74	30.96

Note: The BAND EDGE RESTRICTED BANDS emission is too low at least 20dB to the Fundamental.

802.11n HT20

Indicated		result (PK/AV)	Antenna Polar (H/V)	Correction Factor			FCC Part 15.247		
Frequency (MHz)	Receiver Reading (dB μ V/m)			Ant. Factor (dB/m)	Cable Loss (dB)	Pre-Amp. Gain (dB)	Cord. Amp. (dB μ V/m)	Limit (dB μ V/m)	Margin (dB)
Low Channel (2412MHz)									
2390	33.91	AV	V	30.3	4.1	33.1	35.21	54	18.79
2390	33.66	AV	H	30.3	4.1	33.1	34.96	54	19.04
2390	49.91	PK	V	30.3	4.1	33.1	51.21	74	22.79
2390	51.85	PK	H	30.3	4.1	33.1	53.15	74	20.85
High Channel (2462MHz)									
2483.5	32.01	AV	V	31	4.4	32.7	34.71	54	19.29
2483.5	29.30	AV	H	31	4.4	32.7	32.00	54	22.00
2483.5	42.07	PK	V	31	4.4	32.7	44.77	74	29.23
2483.5	40.60	PK	H	31	4.4	32.7	43.30	74	30.70

802.11n HT40

Indicated		result (PK/AV)	Antenna Polar (H/V)	Correction Factor			FCC Part 15.247		
Frequency (MHz)	Receiver Reading (dB μ V/m)			Ant. Factor (dB/m)	Cable Loss (dB)	Pre-Amp. Gain (dB)	Cord. Amp. (dB μ V/m)	Limit (dB μ V/m)	Margin (dB)
Low Channel (2422MHz)									
2390	36.49	AV	V	30.3	4.1	33.1	37.79	54	16.21
2390	36.76	AV	H	30.3	4.1	33.1	38.06	54	15.94
2390	52.32	PK	V	30.3	4.1	33.1	53.62	74	20.38
2390	52.68	PK	H	30.3	4.1	33.1	53.98	74	20.02
High Channel (2452MHz)									
2483.5	31.86	AV	V	31	4.4	32.7	34.56	54	19.44
2483.5	33.49	AV	H	31	4.4	32.7	36.19	54	17.81
2483.5	45.76	PK	V	31	4.4	32.7	48.46	74	25.54
2483.5	44.98	PK	H	31	4.4	32.7	47.68	74	26.32

Note: The BAND EDGE RESTRICTED BANDS emission is too low at least 20dB to the Fundamental.

Band Edges Measurement:

802.11b:

Low channel

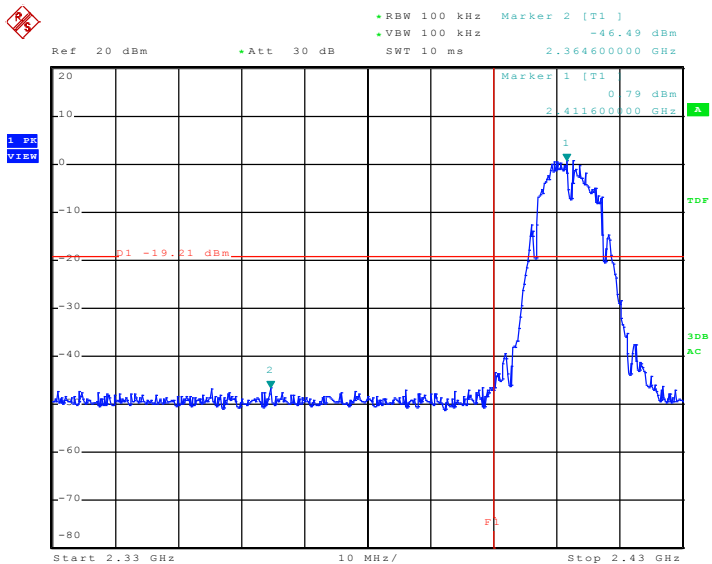

Date: 20.SEP.2016 10:35:02

High channel

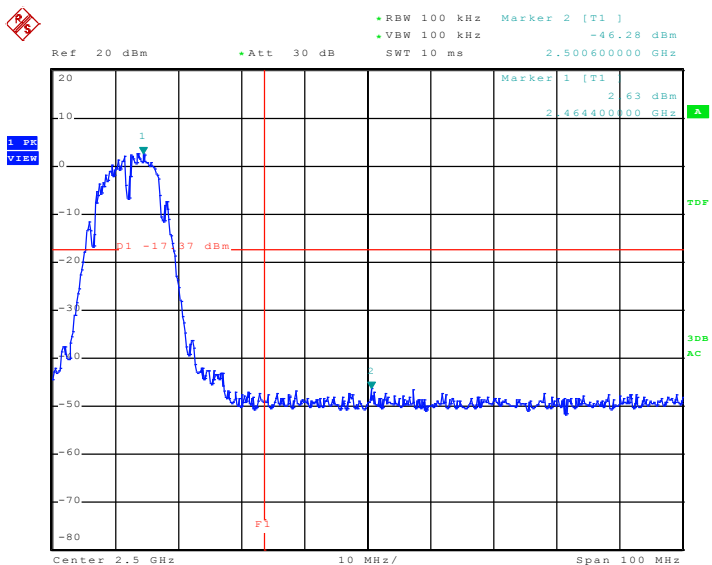

Date: 20.SEP.2016 10:41:49

802.11g:

Low channel

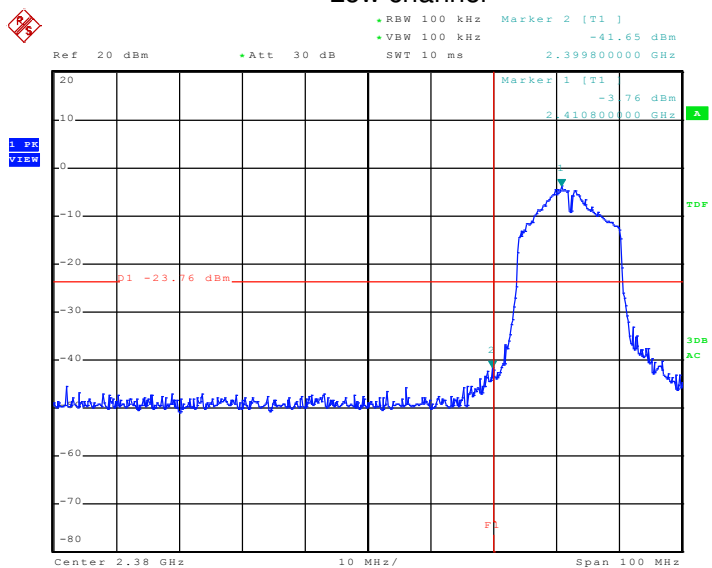

Date: 20.SEP.2016 10:35:55

High channel

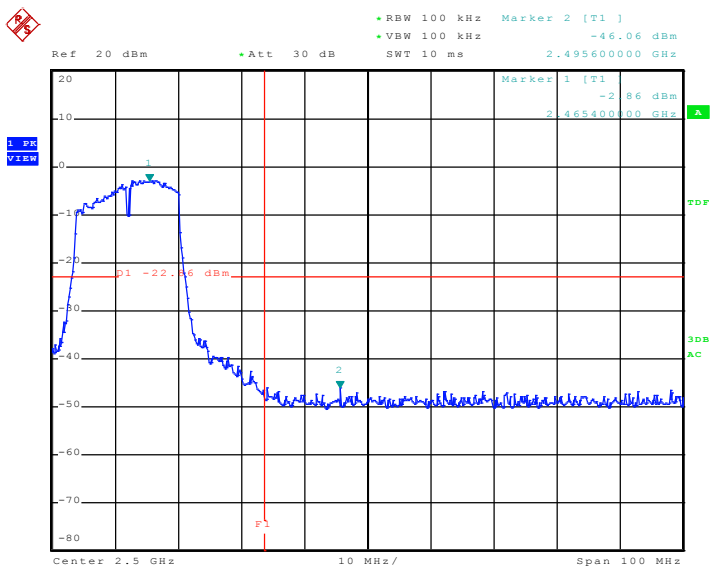

Date: 20.SEP.2016 10:40:52

802.11n HT20:

Low channel

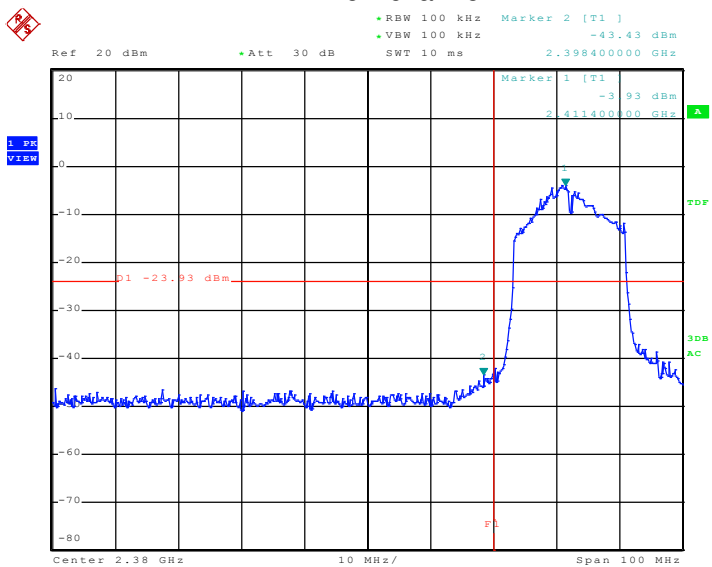

Date: 20.SEP.2016 10:36:38

High channel

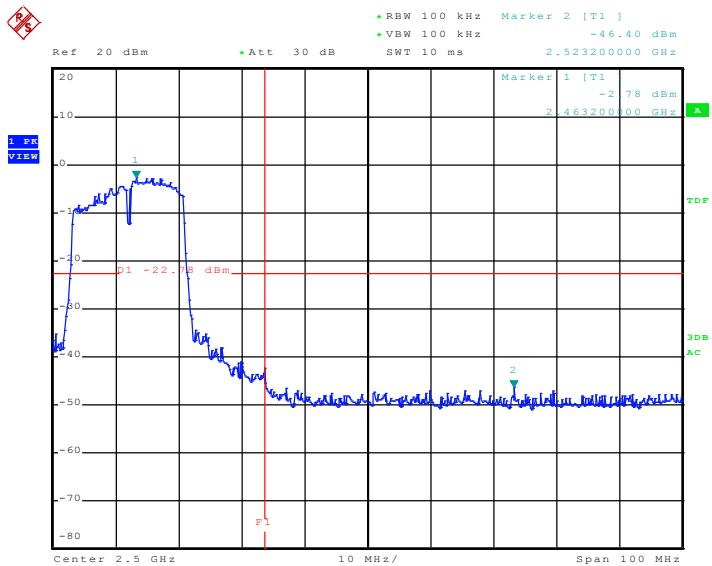

Date: 20.SEP.2016 10:40:13

802.11n HT40:

Low channel

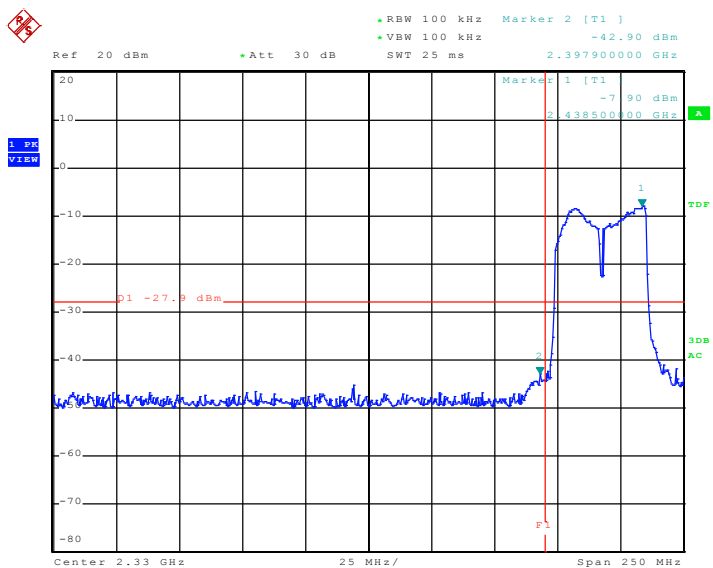

Date: 20.SEP.2016 10:37:32

High channel

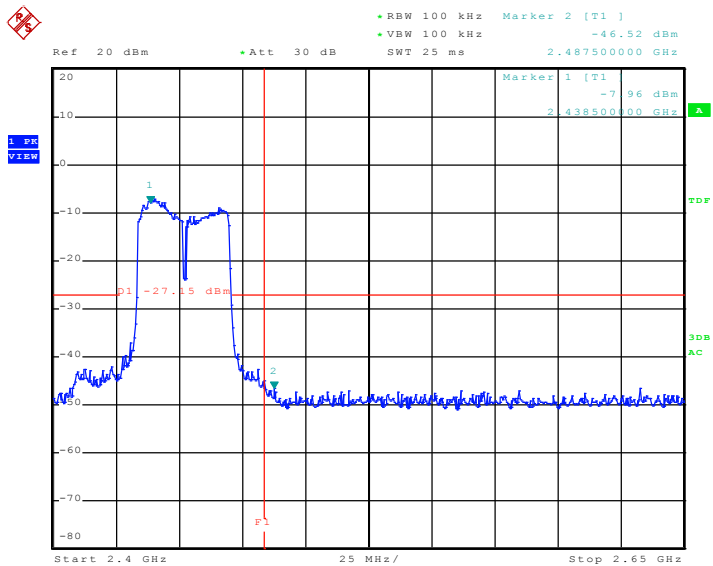

Date: 20.SEP.2016 10:38:57

Conducted measurement:

802.11b:

Low channel

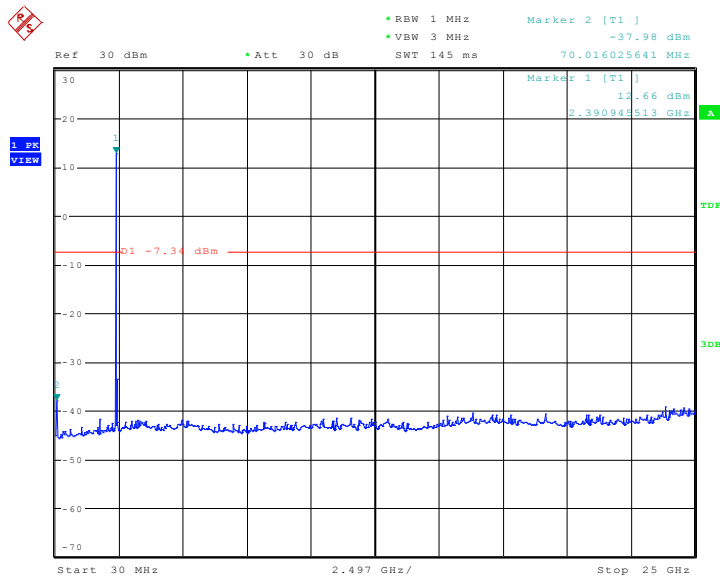

Date: 13.SEP.2016 16:23:04

Middle channel

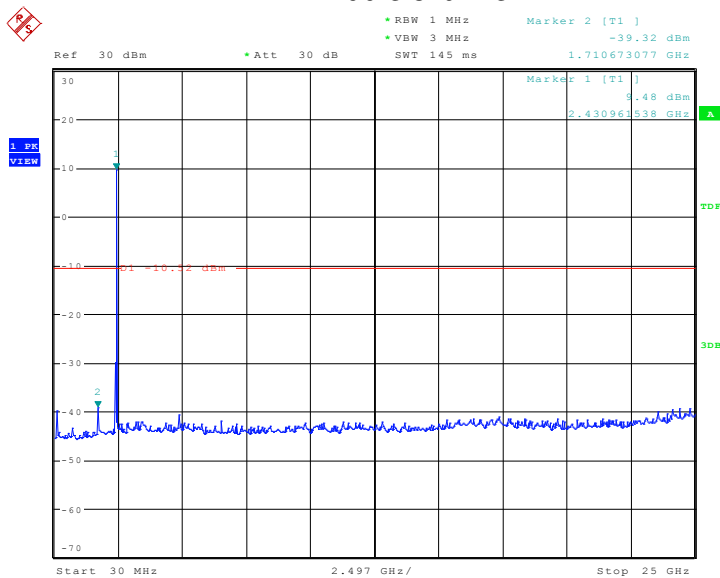

Date: 13.SEP.2016 16:23:47

High channel

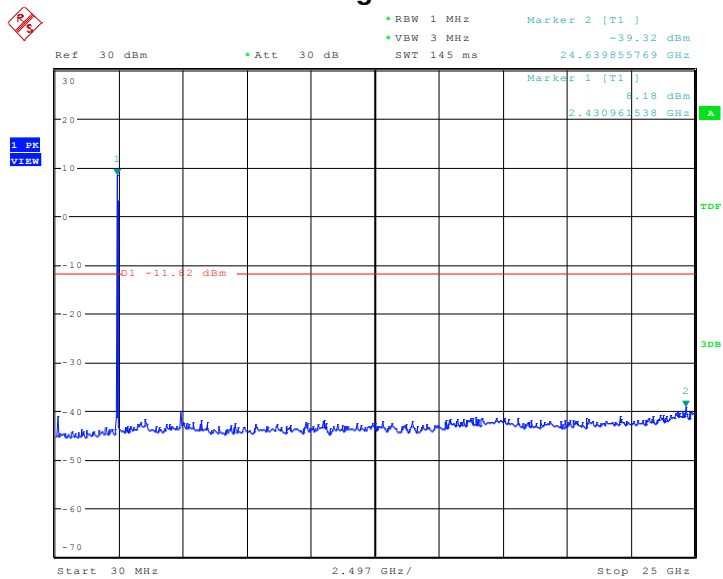

Date: 13.SEP.2016 16:25:36

802.11g:

Low channel

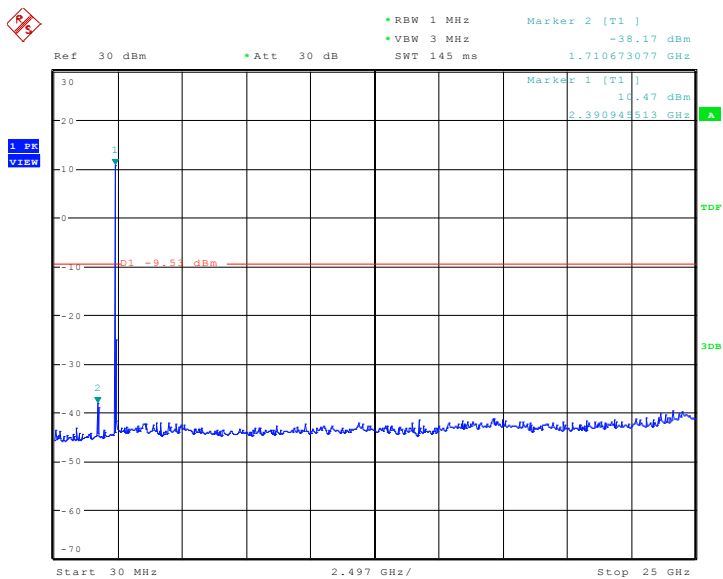

Date: 13.SEP.2016 16:26:38

Middle channel

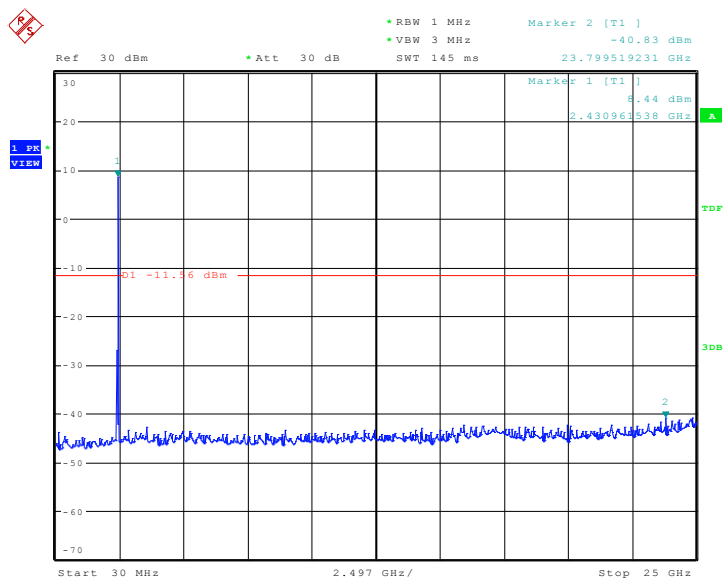

Date: 13.SEP.2016 16:30:01

High channel

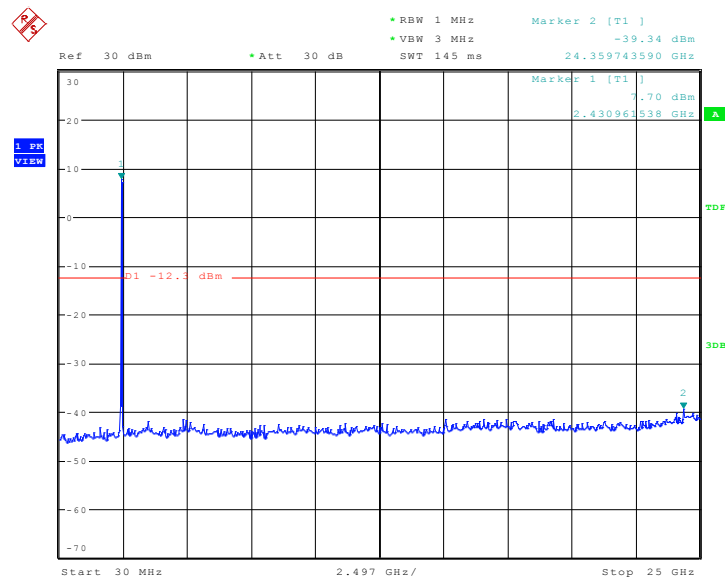

Date: 13.SEP.2016 16:30:51

802.11n HT20:

Low channel

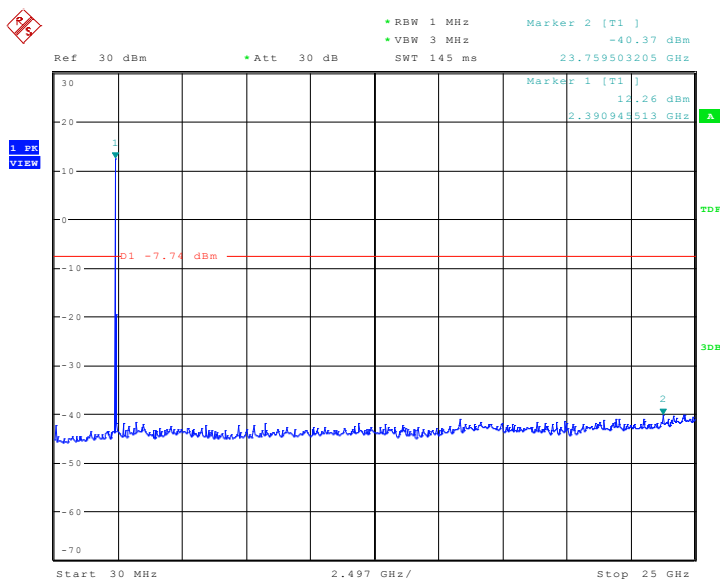

Date: 13.SEP.2016 16:32:06

Middle channel

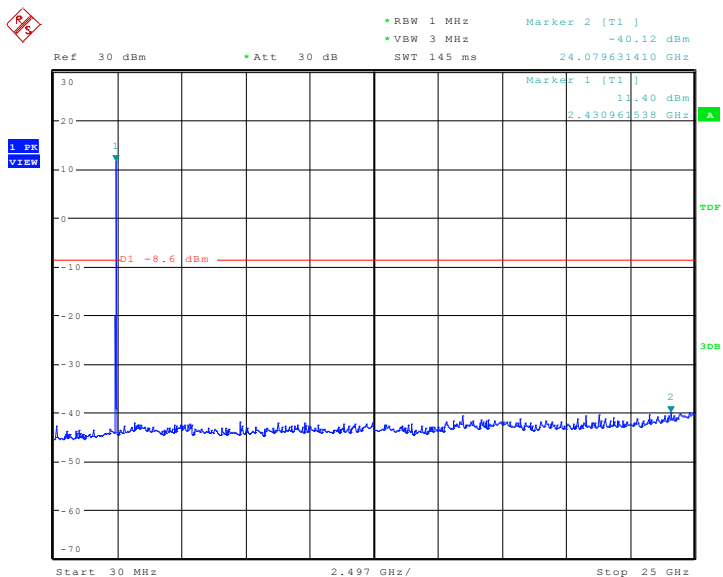

Date: 13 SEP 2016 16:33:03

High channel

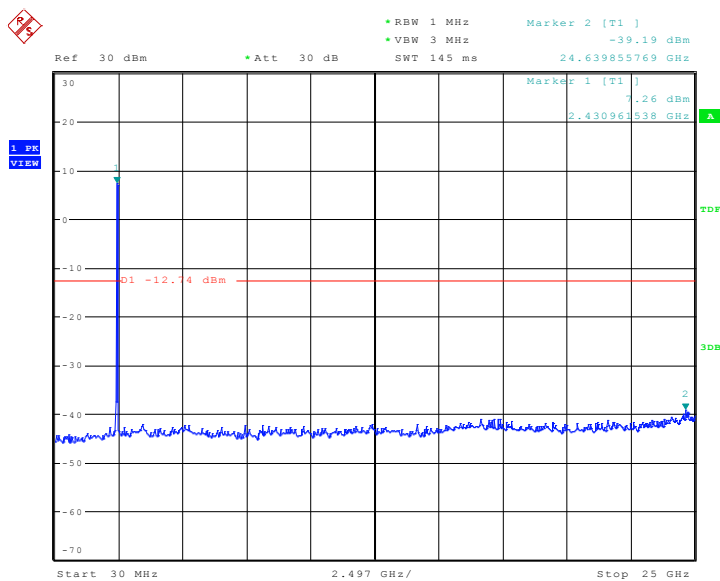

802.11n HT40:

Low channel

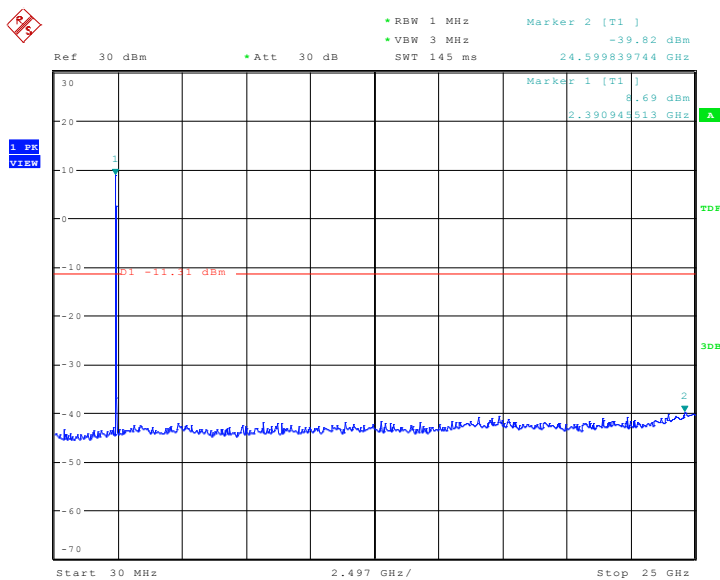

Middle channel

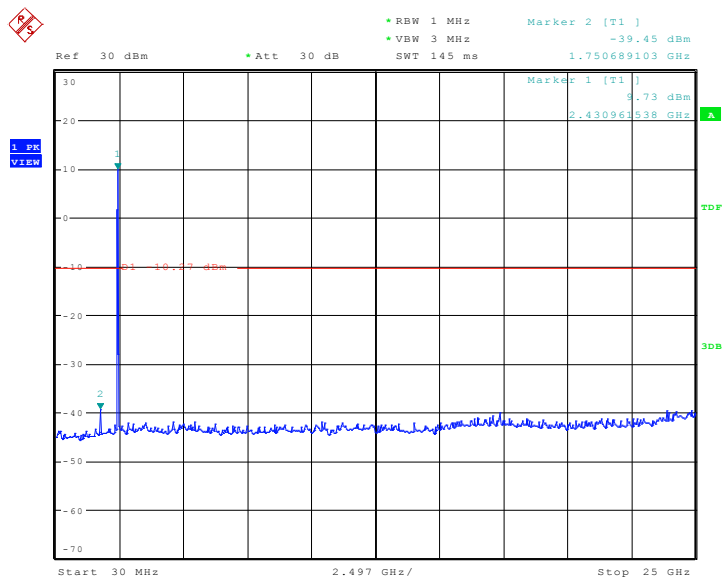

High channel

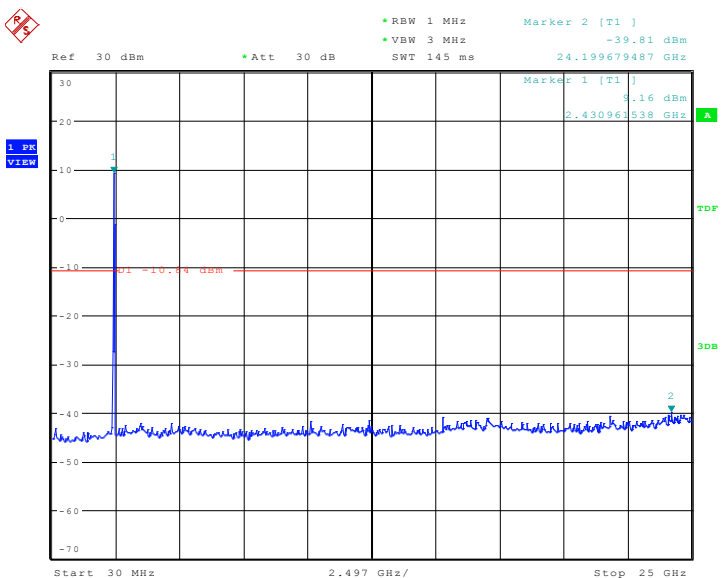

11. EUT TEST PHOTO

CONDUCTED EMISSION TEST



RADIATED EMISSION TEST
(Frequency from 30MHz to 1GHz)

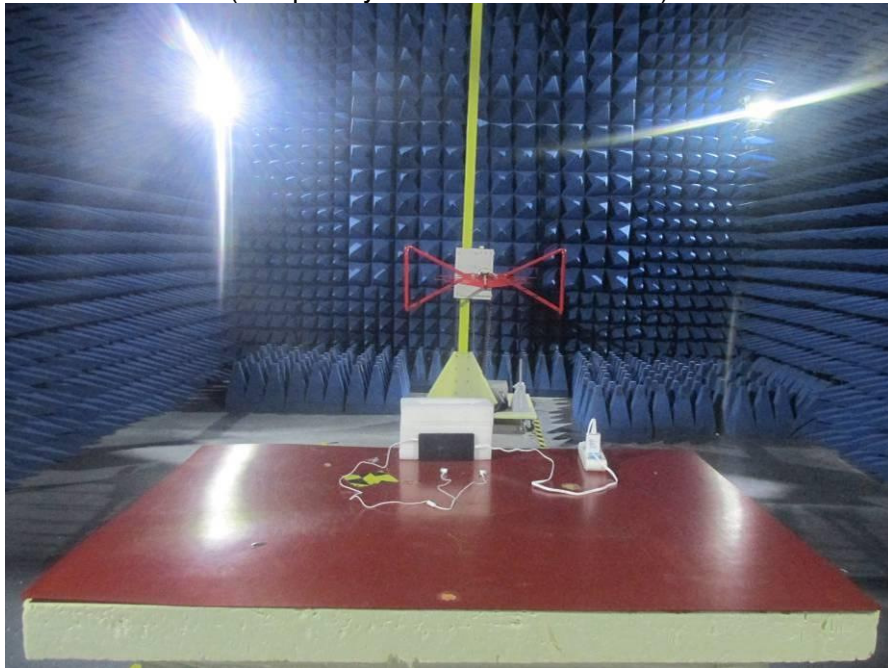

RADIATED EMISSION TEST
(Frequency above 1GHz)

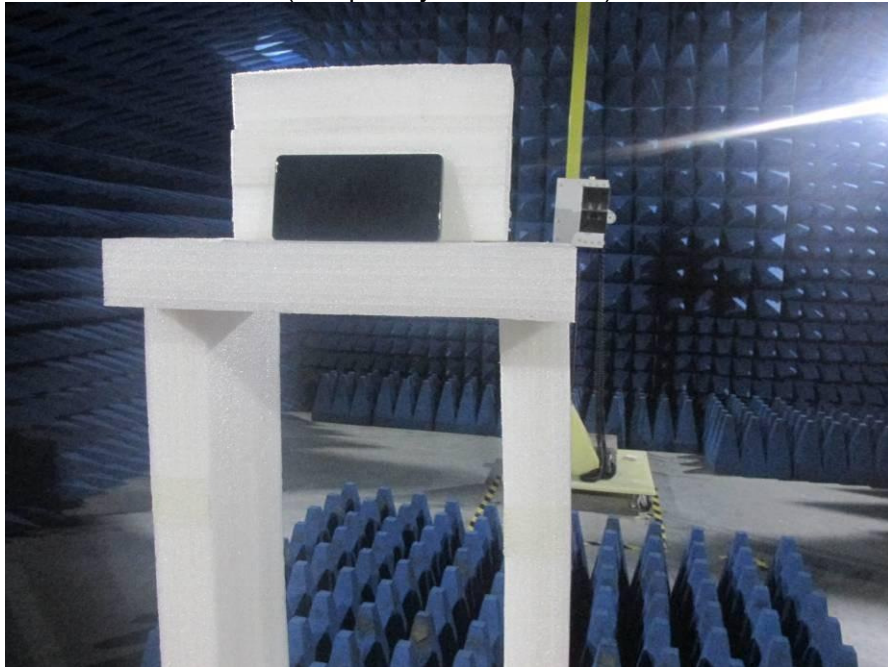

12. PHOTOGRAPHS OF EUT

Appearance photograph of EUT



Appearance photograph of EUT



Appearance photograph of EUT



Appearance photograph of EUT

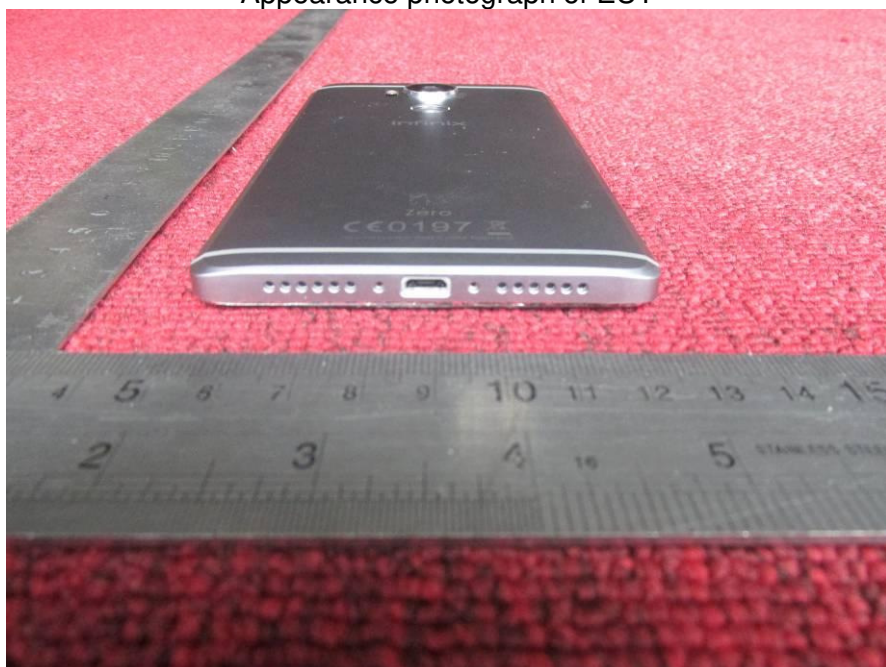

Appearance photograph of EUT



Appearance photograph of EUT



Appearance photograph of EUT



Appearance photograph of EUT



Internal photograph of EUT



Internal photograph of EUT



Internal photograph of EUT



Internal photograph of EUT

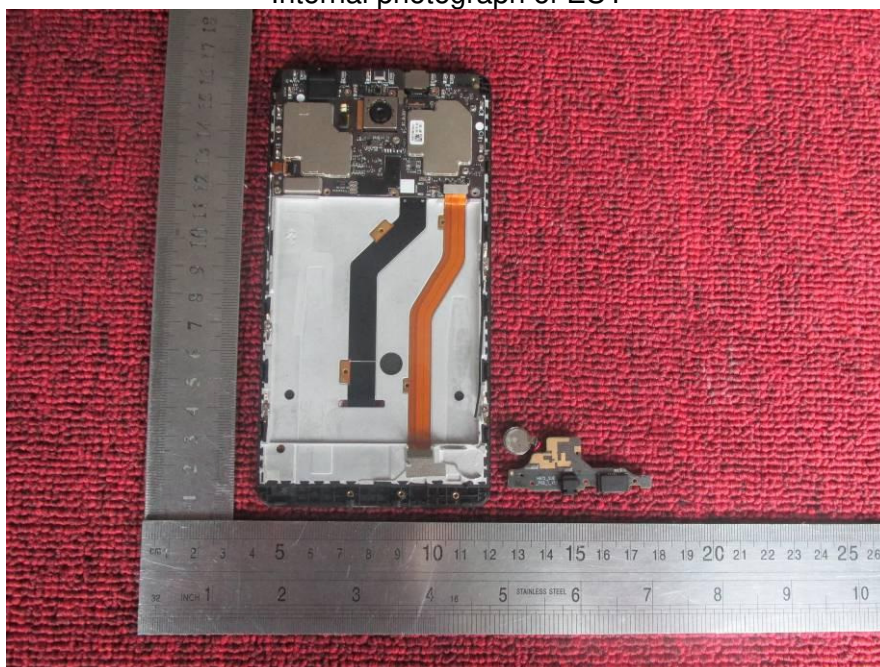

Internal photograph of EUT

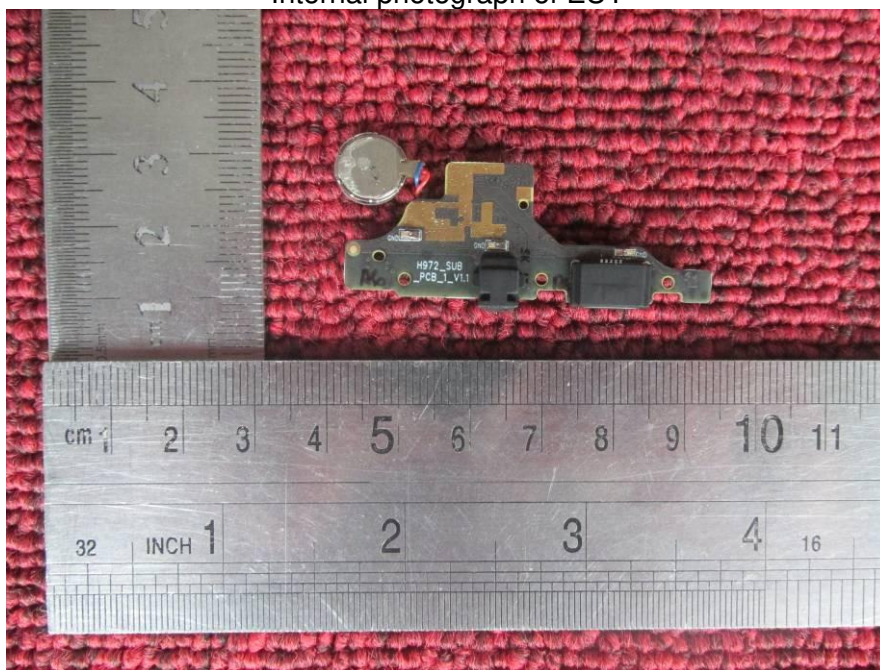

Internal photograph of EUT

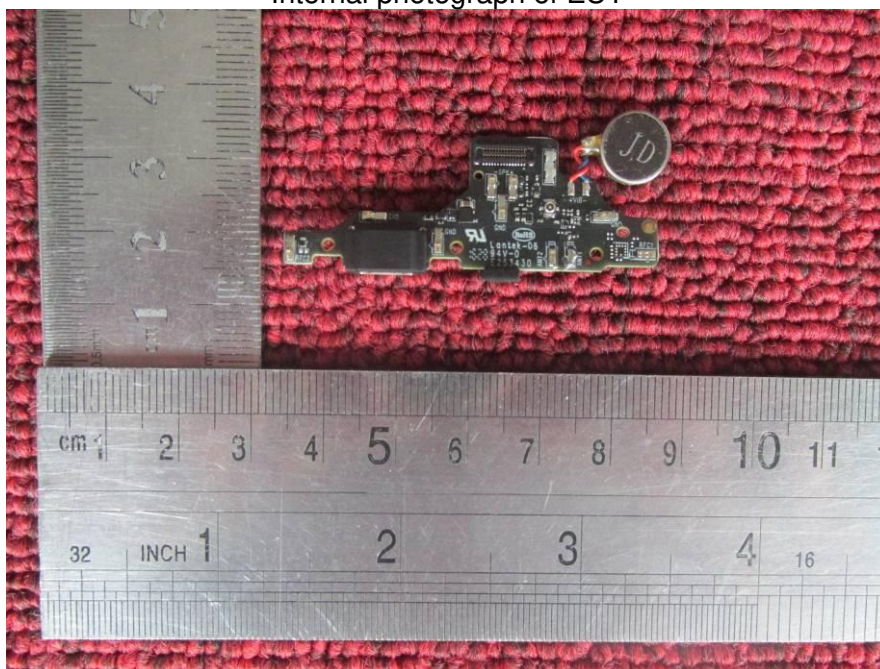

Internal photograph of EUT

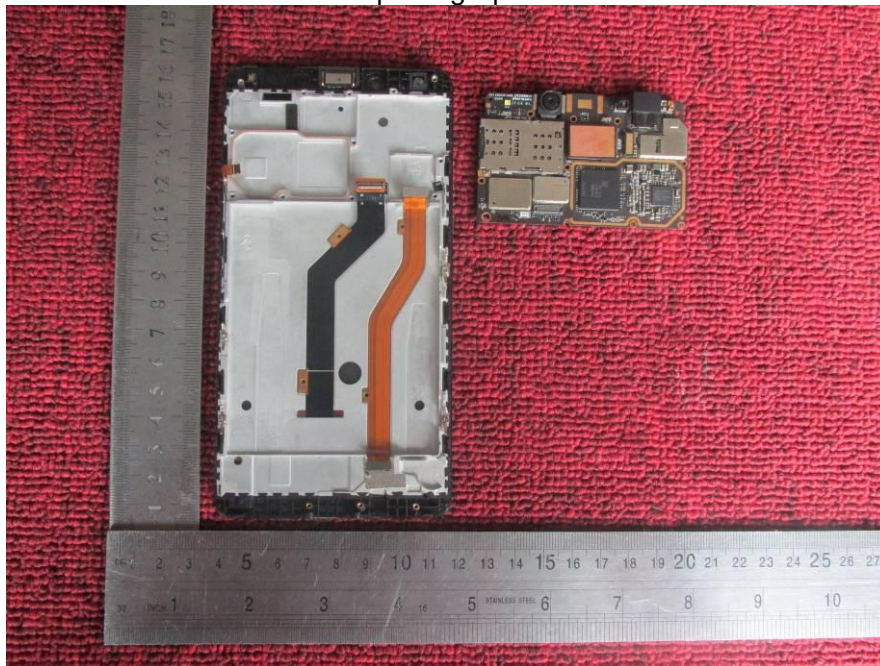

Internal photograph of EUT

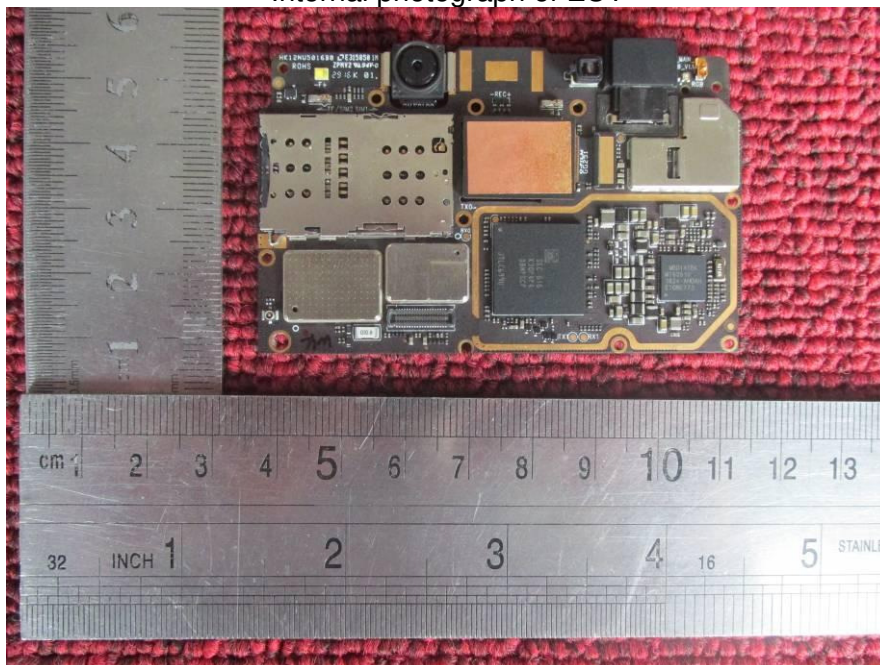

Internal photograph of EUT

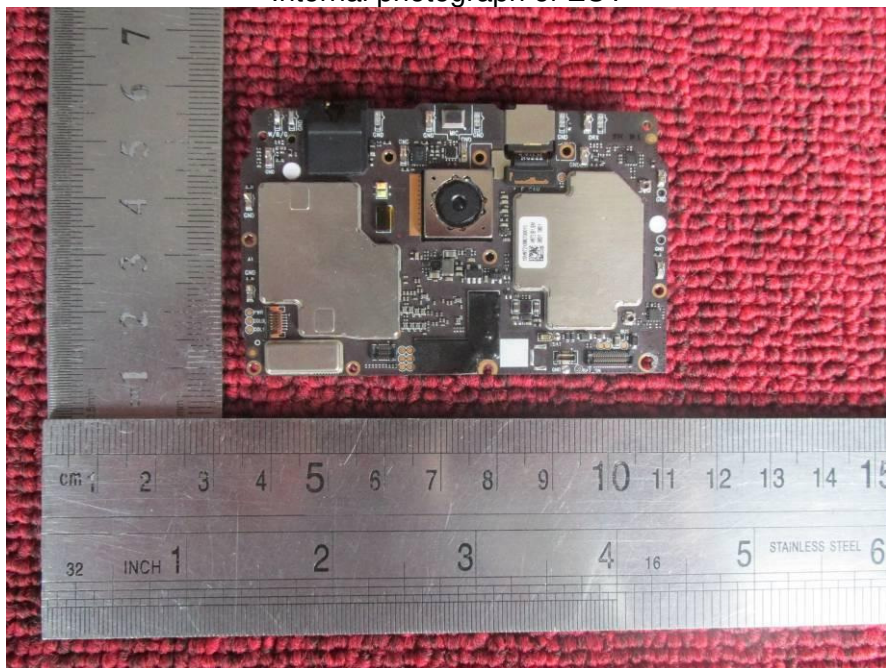

Internal photograph of EUT

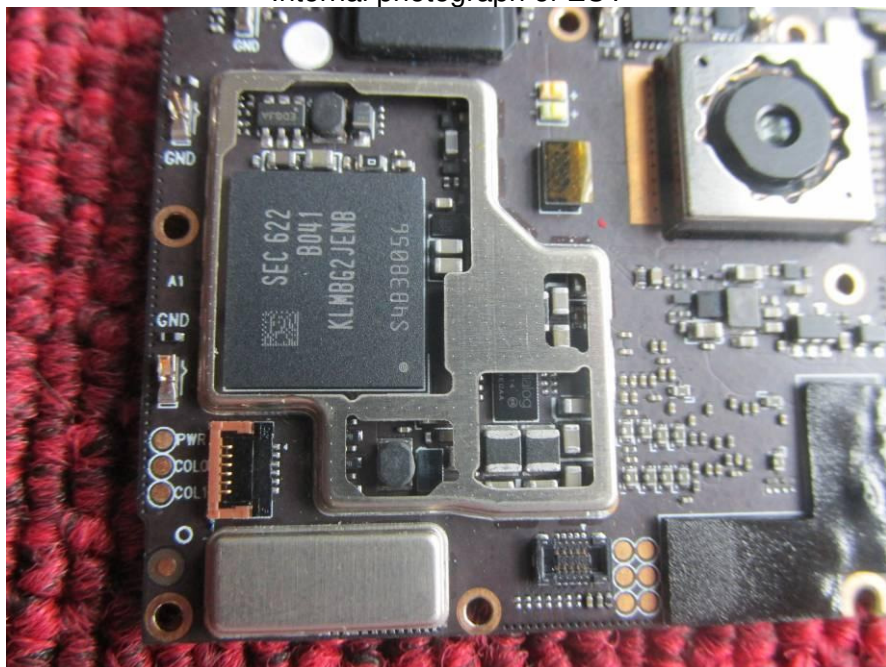

Internal photograph of EUT

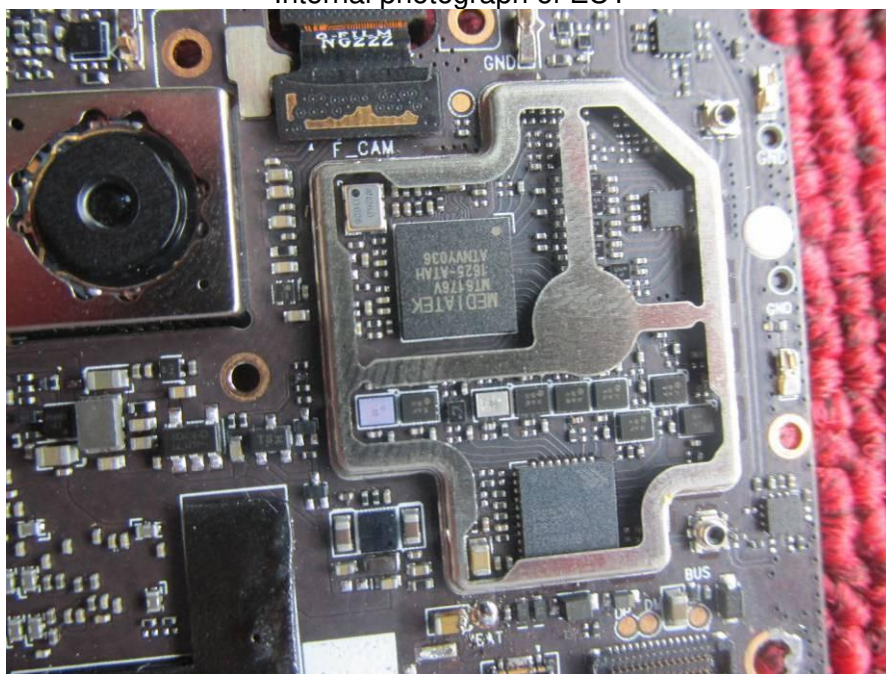

Internal photograph of EUT

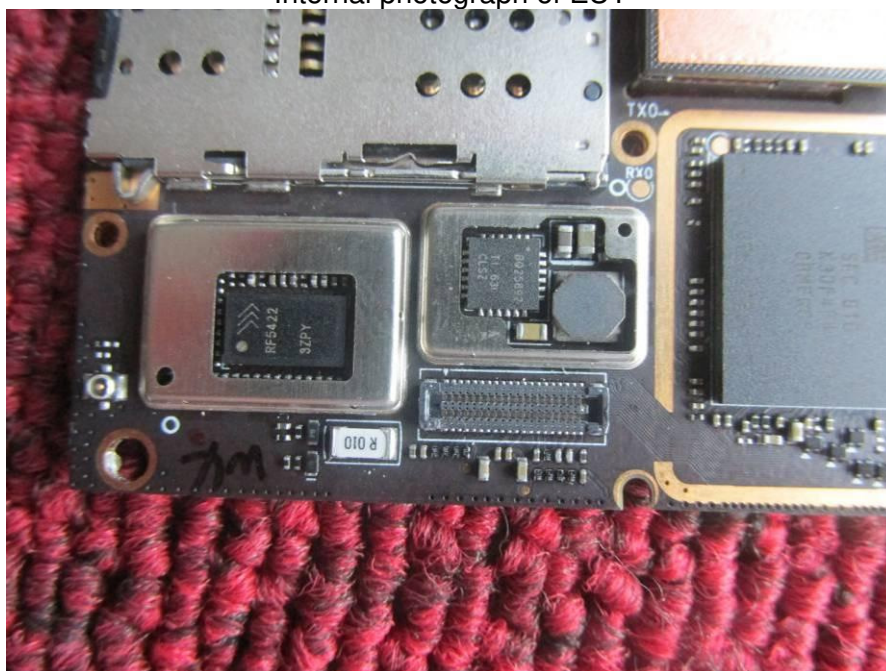

Internal photograph of EUT

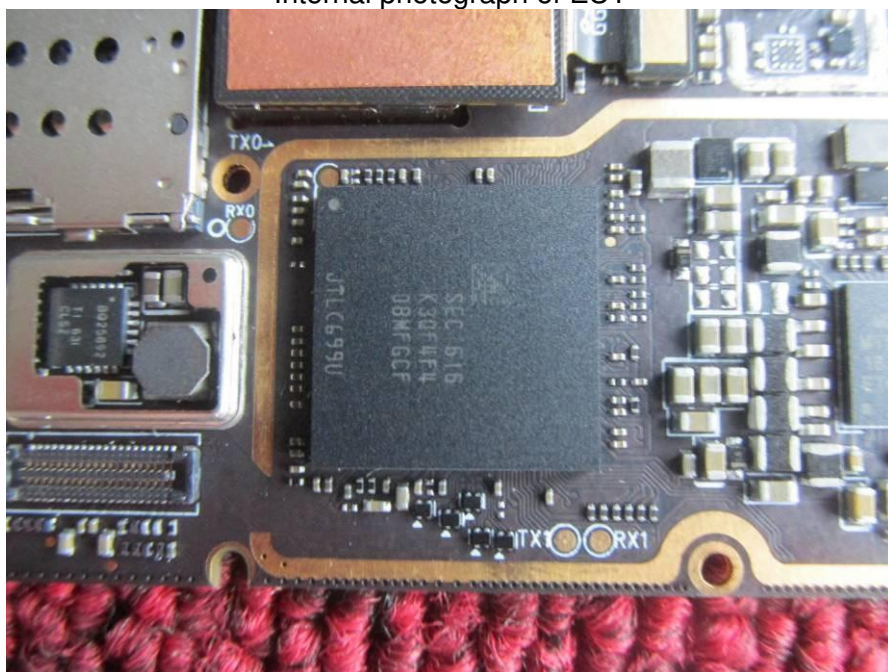

Internal photograph of EUT

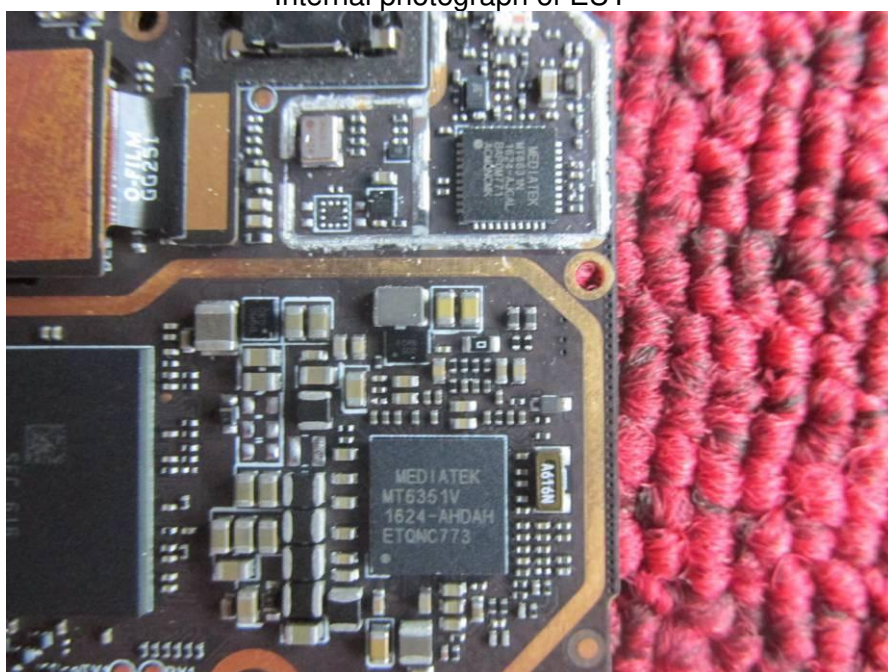

---END OF REPORT---