



# FCC Report

**Application Purpose** : Original grant  
**Applicant Name:** : INFINIX MOBILITY LIMITED  
**FCC ID** : 2AIZN-X571  
**Equipment Type** : Mobile phone  
**Model Name** : X571  
**Report Number** : FCC17060520A-4  
**Standard(S)** : FCC Part 15 Subpart B  
**Date Of Receipt** : June 14, 2017  
**Date Of Issue** : June 30, 2017

**Test By** :   
\_\_\_\_\_  
(Dekun Liu)

**Reviewed By** :   
\_\_\_\_\_  
(Sol Qin)

**Authorized by** :   
\_\_\_\_\_  
(Michal Ling)

**Prepared by** : **QTC Certification & Testing Co., Ltd.**  
2nd Floor,Bl Building,Fengyeyuan Industrial Plant,,  
Liuxian 2st. Road, Xin'an Street, Bao'an  
District,,Shenzhen,518000  
**Registration Number: 588523**

**REPORT REVISE RECORD**

<b>Report Version</b>	<b>Revise Time</b>	<b>Issued Date</b>	<b>Valid Version</b>	<b>Notes</b>
V1.0	/	June 30, 2017	Valid	Original Report

<b>Table of Contents</b>	<b>Page</b>
<b>1. GENERAL INFORMATION</b>	<b>4</b>
<b>2. TEST DESCRIPTION</b>	<b>6</b>
2.1 MEASUREMENT UNCERTAINTY	6
2.2 DESCRIPTION OF TEST MODES	7
2.3 CONFIGURATION OF SYSTEM UNDER TEST	8
2.4 DESCRIPTION OF SUPPORT UNITS (CONDUCTED MODE)	9
<b>3. SUMMARY OF TEST RESULTS</b>	<b>10</b>
<b>4. MEASUREMENT INSTRUMENTS</b>	<b>11</b>
<b>5. EMC EMISSION TEST</b>	<b>12</b>
5.1 CONDUCTED EMISSION MEASUREMENT	12
5.1.1 POWER LINE CONDUCTED EMISSION LIMITS	12
5.1.2 TEST PROCEDURE	13
5.1.3 DEVIATION FROM TEST STANDARD	13
5.1.4 TEST SETUP	13
5.1.5 EUT OPERATING CONDITIONS	13
5.1.6 TEST RESULTS	14
5.2 RADIATED EMISSION MEASUREMENT	16
5.2.1 RADIATED EMISSION LIMITS	16
5.2.2 TEST PROCEDURE	17
5.2.3 DEVIATION FROM TEST STANDARD	17
5.2.4 TEST SETUP	18
5.2.5 EUT OPERATING CONDITIONS	18
5.2.5.1 TEST RESULTS (BETWEEN 30M – 1000 MHZ)	19
5.2.5.2 TEST RESULTS (1GHZ TO 40GHZ)	21
<b>6. EUT TEST PHOTO</b>	<b>22</b>
<b>7. PHOTOGRAPHS OF EUT</b>	<b>26</b>

# 1. GENERAL INFORMATION

Test Model	X571
Applicant	INFINIX MOBILITY LIMITED
Address	RMS 05-15, 13A/F SOUTH TOWER WORLD FINANCE CTR HARBOUR CITY 17 CANTON RD TST KLN HONG KONG
Manufacturer	SHENZHEN TECNO TECHNOLOGY CO.,LTD.
Address	1-4th Floor,3rd Building,Pacific Industrial Park,No.2088,Shenyan Road,Yantian District,Shenzhen,Guangdong,China
Equipment Type	Mobile phone
Brand Name	<b>Infinix</b>
Hardware	V1.1
Software	X571-H5311B-N-PR2-170511V85
Battery information:	Li-Polymer Battery : BL-44AX Voltage: 3.85V Capacity: 4400mAh/4500mAh(min/typ) Limited Charge Voltage: 4.4V
Adapter Information:	Adapter: CQ-25JX Input: AC 100-240V 50/60Hz 0.8A Output: DC 5V $\pm$ 2A/5V $\pm$ 5A Max
Data of receipt	June 14, 2017
Date of test	June 14, 2017 to June 29, 2017
Deviation	None
Condition of Test Sample	Normal

**We hereby certify that:**

The above equipment was tested by QTC Certification & Testing Co., Ltd.

2nd Floor, BI Building, Fengyeyuan Industrial Plant, Liuxian 2st. Road, Xin'an Street, Bao'an District, Shenzhen, 518000

Registration Number: 588523

The data evaluation, test procedures, and equipment configurations shown in this report were made in accordance with the procedures given in ANSI C 63.4:2014. The sample tested as described in this report is in compliance with the FCC Rules Part 15 Subpart B.

The test results of this report relate only to the tested sample identified in this report.

## 2. TEST DESCRIPTION

### 2.1 MEASUREMENT UNCERTAINTY

The reported uncertainty of measurement  $y \pm U$ , where expanded uncertainty  $U$  is based on a standard uncertainty multiplied by a coverage factor of  $k=2$ , providing a level of confidence of approximately **95** %.

No.	Item	Uncertainty
1	Conducted Emission Test	$\pm 3.2$ dB
2	RF power, conducted	$\pm 0.16$ dB
3	Spurious emissions, conducted	$\pm 0.21$ dB
4	All emissions, radiated(<1G)	$\pm 4.7$ dB
5	All emissions, radiated(>1G)	$\pm 4.7$ dB
6	Temperature	$\pm 0.5$ °C
7	Humidity	$\pm 2$ %

## 2.2 DESCRIPTION OF TEST MODES

To investigate the maximum EMI emission characteristics generates from EUT, the test system was pre-scanning tested base on the consideration of following EUT operation mode or test configuration mode which possible have effect on EMI emission level. Each of these EUT operation mode(s) or test configuration mode(s) mentioned above was evaluated respectively.

Pretest Mode	Description
Mode 1	Video Recording
Model 2	Video Playing
Mode 3	Exchange data with computer
Mode 4	GPS
Mode 5	FM

For Conducted Emission	
Final Test Mode	Test with Keyboard and Mouse
Mode 1	Video Recording
Model 2	Video Playing
Mode 3	Exchange data with computer
Mode 4	GPS
Mode 5	FM

For Radiated Emission	
Final Test Mode	Test with Keyboard and Mouse
Mode 1	Video Recording
Model 2	Video Playing
Mode 3	Exchange data with computer
Mode 4	GPS
Mode 5	FM

### 2.3 CONFIGURATION OF SYSTEM UNDER TEST

Mode 1&2&4&5:

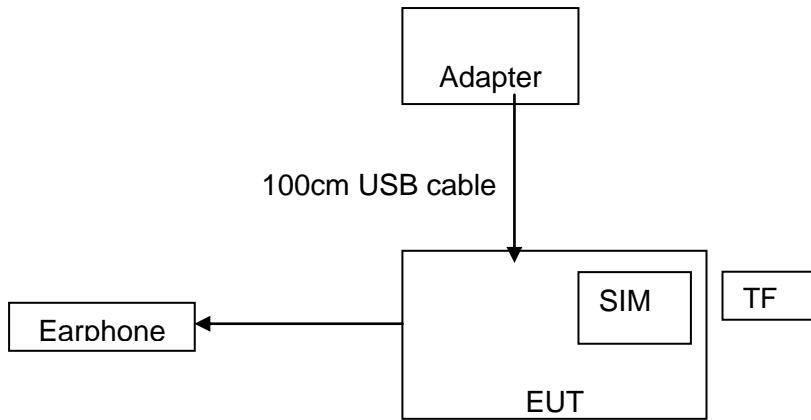

(EUT: Mobile phone)

Mode 3:

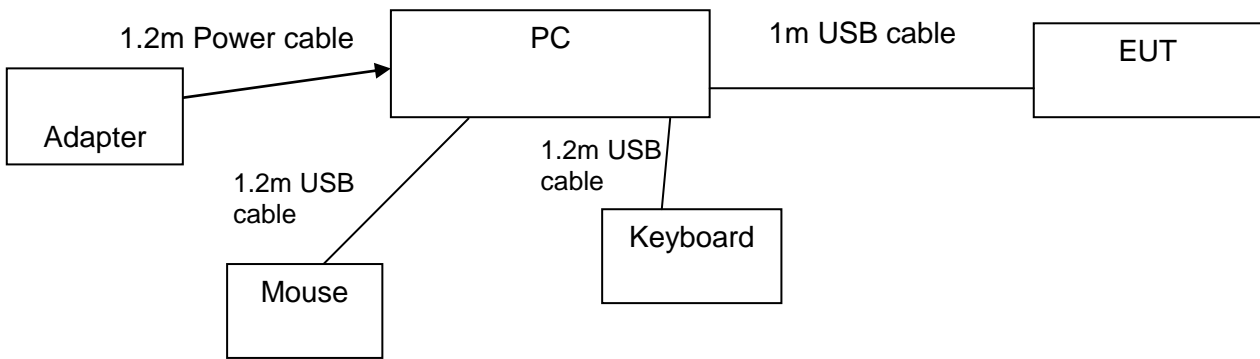

(EUT: Mobile phone)

I/O Port of EUT			
I/O Port Type	Q'TY	Cable	Tested with
Power	1	1m USB cable, unshielded	1
Earphone	1	1m USB cable, unshielded	1



## 2.4 DESCRIPTION OF SUPPORT UNITS (CONDUCTED MODE)

The EUT has been tested as an independent unit together with other necessary accessories or support units. The following support units or accessories were used to form a representative test configuration during the tests.

Item	Equipment	Mfr/Brand	Model/Type No.	Series No.	Note
1	Adapter	/	CQ-25JX	/	/
2	Keyboard	HP	SK-2880	435302-AA-	/
3	Mouse	DELL	MS111-1	/	/

**Note:**

- (1) The support equipment was authorized by Declaration of Confirmation.
- (2) For detachable type I/O cable should be specified the length in cm in 『Length』 column.

### 3. SUMMARY OF TEST RESULTS

Test procedures according to the technical standards:

FCC Part15 , Subpart B			
Standard Section	Test Item	Judgment	Remark
15.107	CONDUCTED EMISSION	PASS	
15.109	RADIATED EMISSION	PASS	

NOTE:

(1) "N/A" denotes test is not applicable in this test report.

## 4. MEASUREMENT INSTRUMENTS

Kind of Equipment	Manufacturer	Type No.	Serial No.	Last Calibrated	Calibrated until
ESCI Test Receiver	R&S	ESCI	100005	08/19/2016	08/18/2017
LISN	AFJ	LS16	16010222119	08/19/2016	08/18/2017
LISN(EUT)	Mestec	AN3016	04/10040	08/19/2016	08/18/2017
pre-amplifier	CDSI	PAP-1G18-38	--	08/19/2016	08/18/2017
System Controller	CT	SC100	-	08/19/2016	08/18/2017
Bi-log Antenna	Chase	CBL6111C	2576	08/19/2016	08/18/2017
Spectrum analyzer	R&S	FSU26	200409	08/19/2016	08/18/2017
Horn Antenna	SCHWARZBECK	9120D	1141	08/19/2016	08/18/2017
Bi-log Antenna	SCHWABEBECK	VULB9163	9163/340	08/19/2016	08/18/2017
Pre Amplifier	H.P.	HP8447E	2945A02715	10/13/2016	10/12/2017
9*6*6 Anechoic	--	--	--	08/21/2016	08/20/2017

# 5. EMC EMISSION TEST

## 5.1 CONDUCTED EMISSION MEASUREMENT

### 5.1.1 POWER LINE CONDUCTED EMISSION Limits (Frequency Range 150KHz-30MHz)

FREQUENCY (MHz)	Class A (dBuV)		Class B (dBuV)		Standard
	Quasi-peak	Average	Quasi-peak	Average	
0.15 -0.5	79.00	66.00	66 - 56 *	56 - 46 *	FCC
0.50 -5.0	73.00	60.00	56.00	46.00	FCC
5.0 -30.0	73.00	60.00	60.00	50.00	FCC

Note:

- (1) The tighter limit applies at the band edges.
- (2) The limit of " \* " marked band means the limitation decreases linearly with the logarithm of the frequency in the range.

The following table is the setting of the receiver

Receiver Parameters	Setting
Attenuation	10 dB
Start Frequency	0.15 MHz
Stop Frequency	30 MHz
IF Bandwidth	9 kHz

### 5.1.2 TEST PROCEDURE

- The EUT was placed 0.4 meters from the horizontal ground plane with EUT being connected to the power mains through a line impedance stabilization network (LISN). All other support equipments powered from additional LISN(s). The LISN provide 50 Ohm/ 50uH of coupling impedance for the measuring instrument.
- Interconnecting cables that hang closer than 40 cm to the ground plane shall be folded back and forth in the center forming a bundle 30 to 40 cm long.
- I/O cables that are not connected to a peripheral shall be bundled in the center. The end of the cable may be terminated, if required, using the correct terminating impedance. The overall length shall not exceed 1 m.
- LISN at least 80 cm from nearest part of EUT chassis.
- For the actual test configuration, please refer to the related Item –EUT Test Photos.

### 5.1.3 DEVIATION FROM TEST STANDARD

No deviation

### 5.1.4 TEST SETUP

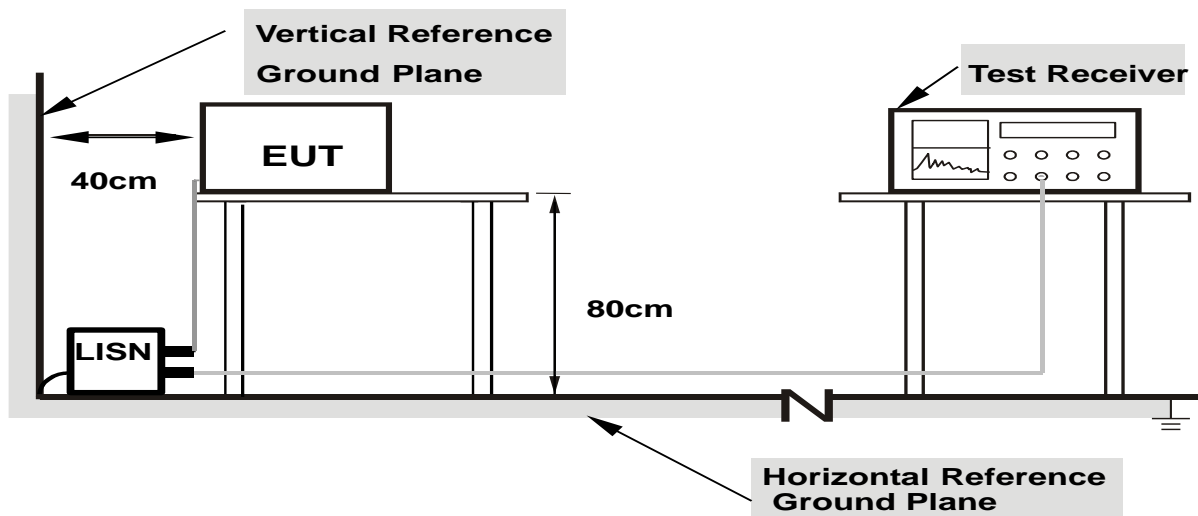

- Note: 1.Support units were connected to second LISN.**  
**2.Both of LISNs (AMN) are 80 cm from EUT and at least 80 from other units and other metal planes**

### 5.1.5 EUT OPERATING CONDITIONS

The EUT was configured for testing in a typical fashion (as a customer would normally use it). The EUT has been programmed to continuously transmit during test. This operating condition was tested and used to collect the included data.

### 5.1.6 TEST RESULTS

This is the worst pattern data

EUT	Mobile phone	Model Name	X571
Temperature	26 °C	Relative Humidity	54%
Pressure	1010hPa	Phase	L
Test Date	June 15, 2017	Test Mode	Mode 3

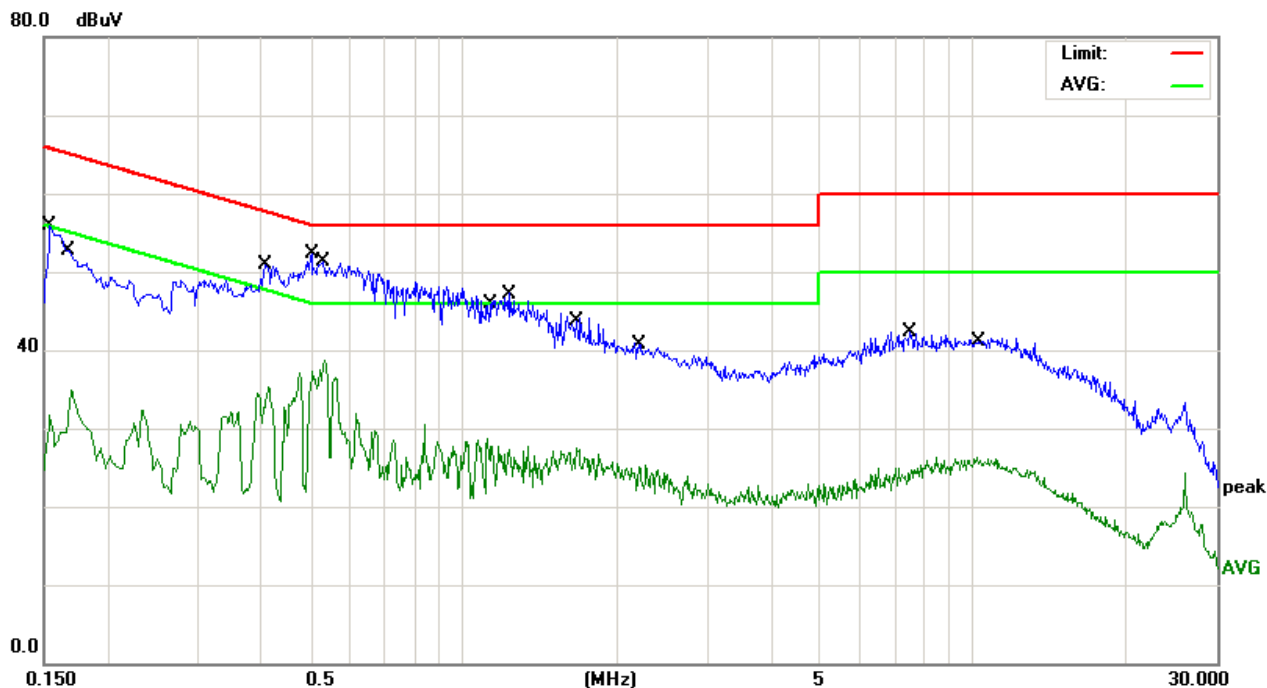

No.	Mk.	Freq. MHz	Reading Level dBuV	Correct Factor dB	Measure- ment dBuV	Limit dBuV	Over dB	Detector
1		0.1539	44.00	11.85	55.85	65.78	-9.93	QP
2		0.1700	23.28	11.62	34.90	54.96	-20.06	AVG
3		0.4100	39.89	10.92	50.81	57.65	-6.84	QP
4		0.4140	24.47	10.91	35.38	47.57	-12.19	AVG
5	*	0.5020	41.47	10.80	52.27	56.00	-3.73	QP
6		0.5340	27.85	10.79	38.64	46.00	-7.36	AVG
7		1.1140	18.08	10.62	28.70	46.00	-17.30	AVG
8		1.2340	36.58	10.62	47.20	56.00	-8.80	QP
9		1.6700	16.86	10.60	27.46	46.00	-18.54	AVG
10		2.2100	30.09	10.59	40.68	56.00	-15.32	QP
11		7.5179	31.78	10.57	42.35	60.00	-17.65	QP
12		10.1379	15.72	10.59	26.31	50.00	-23.69	AVG

EUT	Mobile phone	Model Name	X571
Temperature	26 °C	Relative Humidity	54%
Pressure	1010hPa	Phase	N
Test Date	June 15, 2017	Test Mode	Mode 3

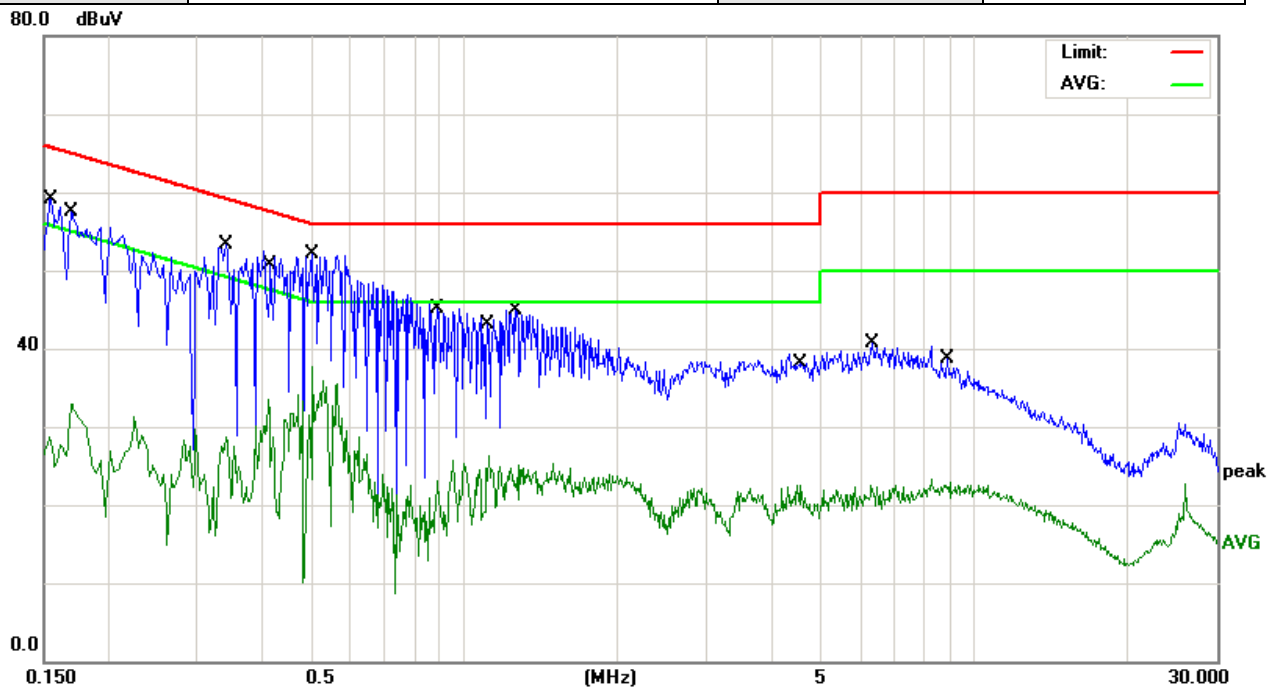

No.	Mk.	Freq. MHz	Reading Level dBuV	Correct Factor dB	Measure- ment dBuV	Limit dBuV	Over dB	Detector
1		0.1547	47.32	11.84	59.16	65.74	-6.58	QP
2		0.1700	21.30	11.62	32.92	54.96	-22.04	AVG
3		0.3420	42.21	11.02	53.23	59.15	-5.92	QP
4		0.4140	22.59	10.91	33.50	47.57	-14.07	AVG
5	*	0.5020	41.30	10.80	52.10	56.00	-3.90	QP
6		0.5060	26.99	10.80	37.79	46.00	-8.21	AVG
7		0.8860	34.46	10.68	45.14	56.00	-10.86	QP
8		1.1180	15.69	10.62	26.31	46.00	-19.69	AVG
9		1.2660	34.31	10.63	44.94	56.00	-11.06	QP
10		4.5059	11.97	10.54	22.51	46.00	-23.49	AVG
11		6.3459	30.13	10.56	40.69	60.00	-19.31	QP
12		9.0099	12.36	10.58	22.94	50.00	-27.06	AVG

## 5.2 RADIATED EMISSION MEASUREMENT

### 5.2.1 RADIATED EMISSION LIMITS (Frequency Range 9kHz-1000MHz)

The field strength of radiated emissions from unintentional radiators at a distance of 3 meters shall not exceed the following values:

Frequencies (MHz)	Field Strength (micorvolts/meter)	Measurement Distance (meters)
0.009~0.490	2400/F(KHz)	300
0.490~1.705	24000/F(KHz)	30
1.705~30.0	30	30
30~88	100	3
88~216	150	3
216~960	200	3
Above 960	500	3

#### LIMITS OF RADIATED EMISSION MEASUREMENT (Above 1000MHz)

FREQUENCY (MHz)	Limit (dBuV/m) (at 3M)	
	PEAK	AVERAGE
Above 1000	74	54

Notes:

- (1) The limit for radiated test was performed according to FCC PART 15B.
- (2) The tighter limit applies at the band edges.
- (3) Emission level (dBuV/m)=20log Emission level (uV/m).

Spectrum Parameter	Setting
Attenuation	Auto
Start Frequency	1000 MHz
Stop Frequency	10th carrier harmonic
RB / VB (emission in restricted band)	1 MHz / 1 MHz for Peak, 1 MHz / 1Hz for Average

Receiver Parameter	Setting
Attenuation	Auto
Start ~ Stop Frequency	9kHz~150kHz / RB 200Hz for QP
Start ~ Stop Frequency	150kHz~30MHz / RB 9kHz for QP
Start ~ Stop Frequency	30MHz~1000MHz / RB 120kHz for QP



**5.2.2 TEST PROCEDURE**

- a. The measuring distance of at 3 m shall be used for measurements at frequency up to 1GHz. For frequencies above 1GHz, any suitable measuring distance may be used.
- b. The EUT was placed on the top of a rotating table 0.8 meters above the ground at a 3 meter open area test site. The table was rotated 360 degrees to determine the position of the highest radiation.
- c. The height of the equipment or of the substitution antenna shall be 0.8 m; the height of the test antenna shall vary between 1 m to 4 m. Both horizontal and vertical polarizations of the antenna are set to make the measurement.
- d. The initial step in collecting conducted emission data is a spectrum analyzer peak detector mode pre-scanning the measurement frequency range. Significant peaks are then marked and then Quasi Peak detector mode re-measured.
- e. If the Peak Mode measured value compliance with and lower than Quasi Peak Mode Limit, the EUT shall be deemed to meet QP Limits and then no additional QP Mode measurement performed.
- f. For the actual test configuration, please refer to the related Item –EUT Test Photos.

Note:

***Both horizontal and vertical antenna polarities were tested and performed pretest to three orthogonal axis. The worst case emissions were reported***

**5.2.3 DEVIATION FROM TEST STANDARD**

No deviation

### 5.2.4 TEST SETUP

(A) Radiated Emission Test-Up Frequency 30MHz~1GHz

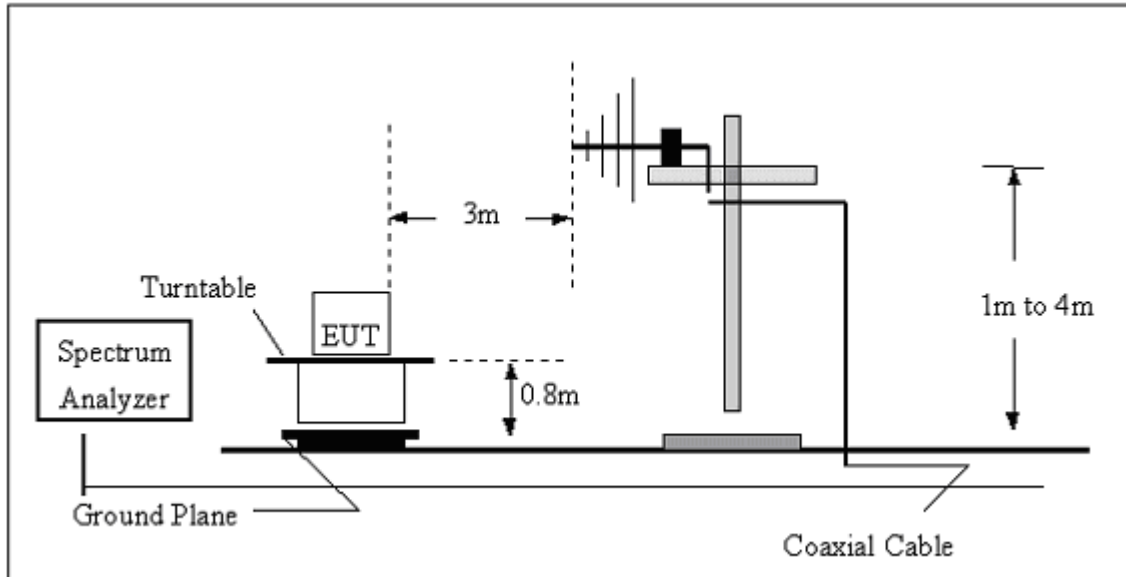

(B) Radiated Emission Test-Up Frequency Above 1GHz

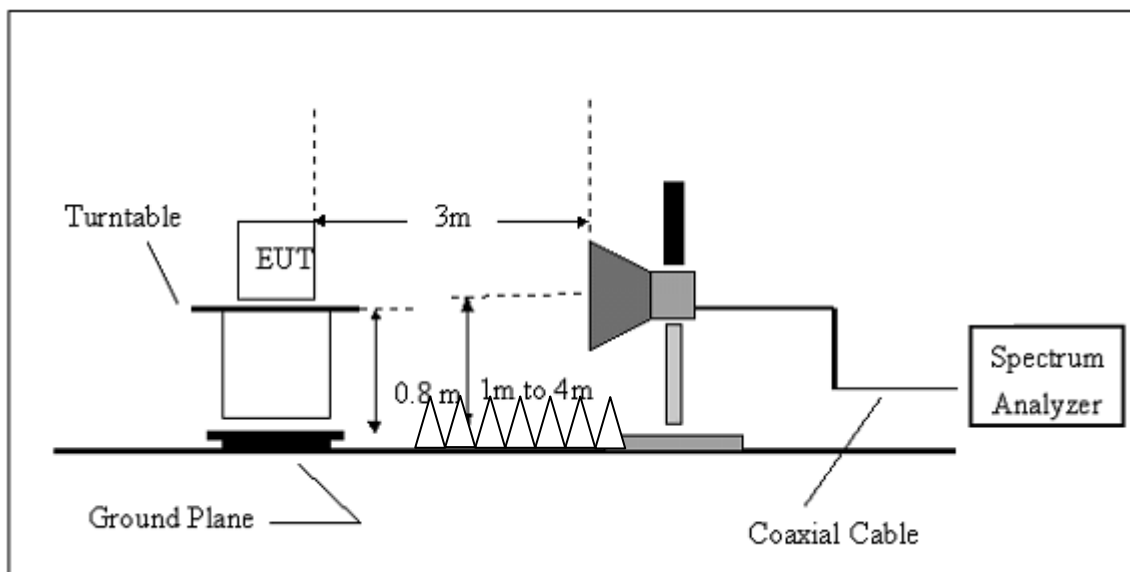

### 5.2.5 EUT OPERATING CONDITIONS

The EUT tested system was configured as the statements of 2.4 Unless otherwise a special operating condition is specified in the follows during the testing.

### 5.2.5.1 TEST RESULTS (BETWEEN 30M – 1000 MHZ)

This is the worst pattern data

EUT	Mobile phone	Model Name	X571
Temperature	20 °C	Relative Humidity	48%
Pressure	1010 hPa	Polarization :	Horizontal
Test Mode	Mode 3	Test Date	June 15, 2017

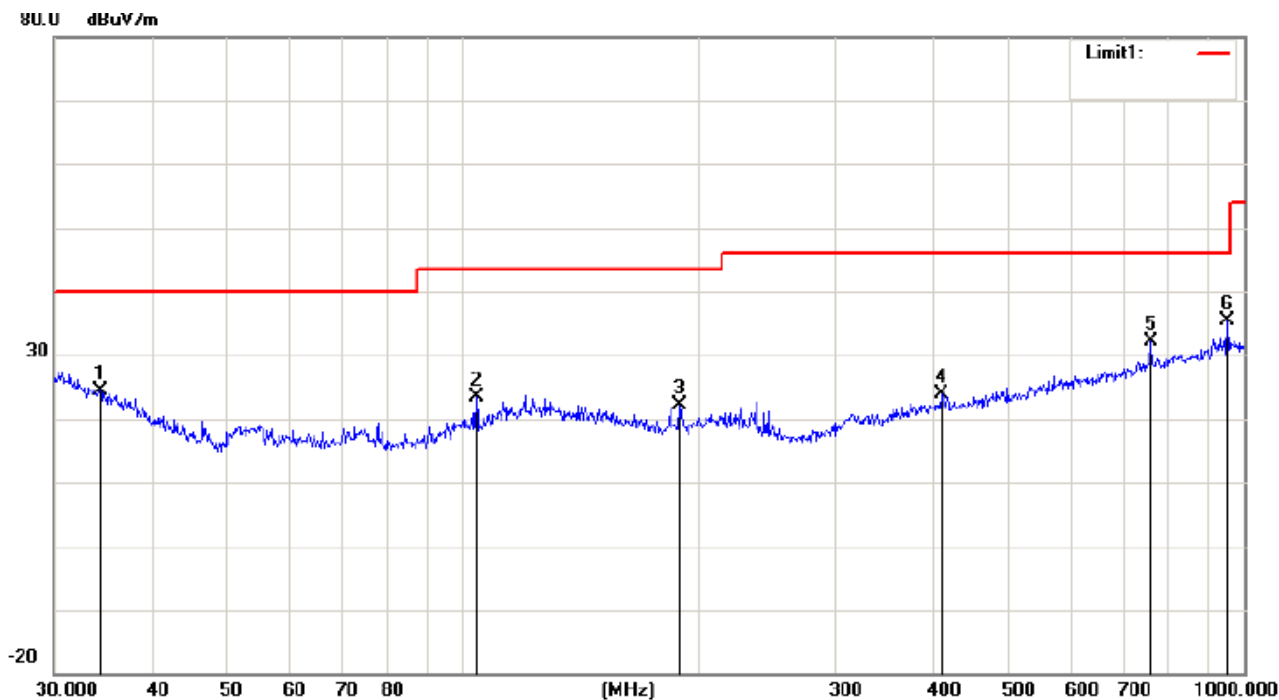

No.	Mk.	Freq. MHz	Reading Level dBuV	Correct Factor dB	Measure- ment dBuV/m	Limit dBuV/m	Over dB	Detector
1		34.3964	23.87	0.54	24.41	40.00	-15.59	QP
2		104.1701	28.62	-5.18	23.44	43.50	-20.06	QP
3		189.7385	27.47	-5.28	22.19	43.50	-21.31	QP
4		410.3825	25.91	-1.96	23.95	46.00	-22.05	QP
5		760.7036	28.57	3.56	32.13	46.00	-13.87	QP
6	*	952.0937	13.22	22.19	35.41	46.00	-10.59	QP

EUT	Mobile phone	Model Name	X571
Temperature	20 °C	Relative Humidity	48%
Pressure	1010 hPa	Polarization :	Vertical
Test Mode	Mode 3	Test Date	June 15, 2017

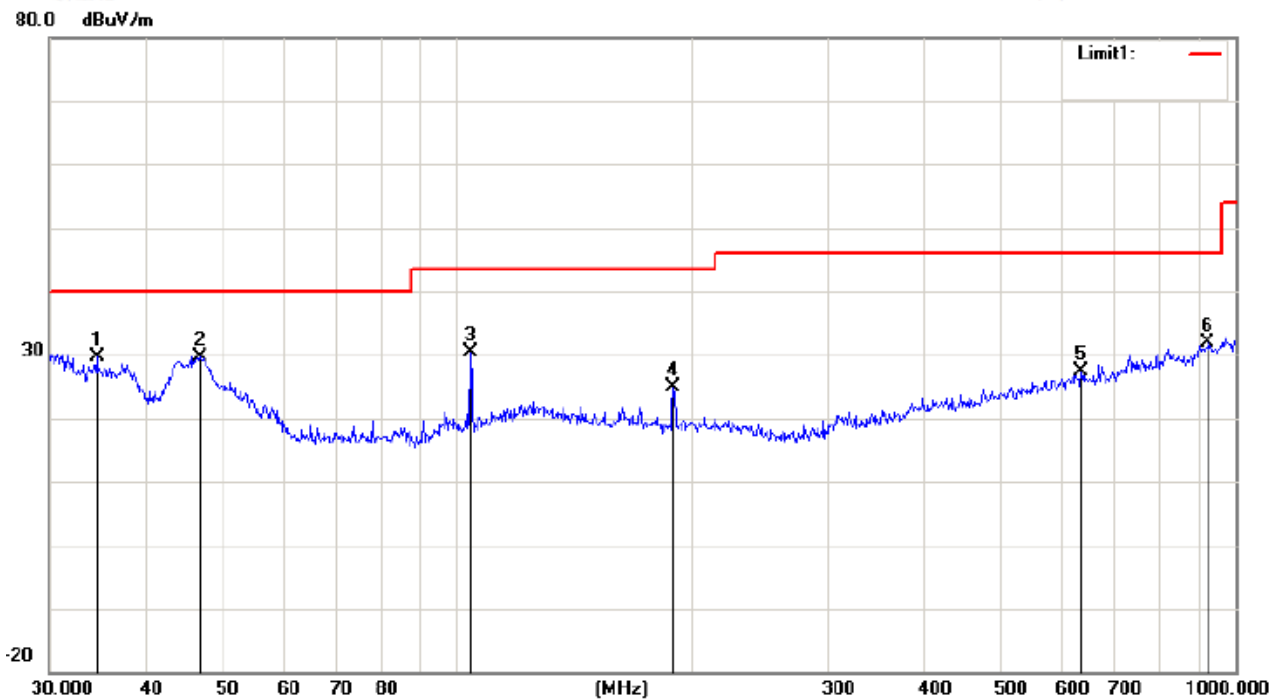

No.	Mk.	Freq. MHz	Reading Level dBuV	Correct Factor dB	Measure- ment dBuV/m	Limit dBuV/m	Over dB	Detector
1	*	34.5173	29.22	0.46	29.68	40.00	-10.32	QP
2		46.8303	37.21	-7.56	29.65	40.00	-10.35	QP
3		104.1701	35.47	-5.18	30.29	43.50	-13.21	QP
4		189.7385	30.19	-5.28	24.91	43.50	-18.59	QP
5		633.9073	25.91	1.35	27.26	46.00	-18.74	QP
6		922.5157	25.25	6.70	31.95	46.00	-14.05	QP

**5.2.5.2 TEST RESULTS (1GHZ TO 40GHZ)**

This is the worst pattern data

EUT	Mobile phone	Model Name	X571
Temperature	20 °C	Relative Humidity	48%
Pressure	1010 hPa	Test Mode	Mode 3
Test Date	June 15, 2017		

Freq. (MHz)	Ant. Pol.	Emission Level(dBuV)		Limit 3m(dBuV/m)		Over(dB)	
		PK	AV	PK	AV	PK	AV
2485.7	V	59.40	41.24	74	54	-14.60	-12.76
6458.4	V	58.98	39.37	74	54	-15.02	-14.63
2490.6	H	59.16	40.11	74	54	-14.84	-13.89
6478.5	H	59.74	40.74	74	54	-14.26	-13.26

**Remark:**

All emissions not reported were more than 20dB below the specified limit or in the noise floor.

Factor = Antenna Factor + Cable Loss – Pre-amplifier.

All the x/y/z orientation has been investigated, and only worst case is presented in this report.

# 6. EUT TEST PHOTO

CONDUCTED EMISSION TEST



CONDUCTED EMISSION TEST



RADIATED EMISSION TEST

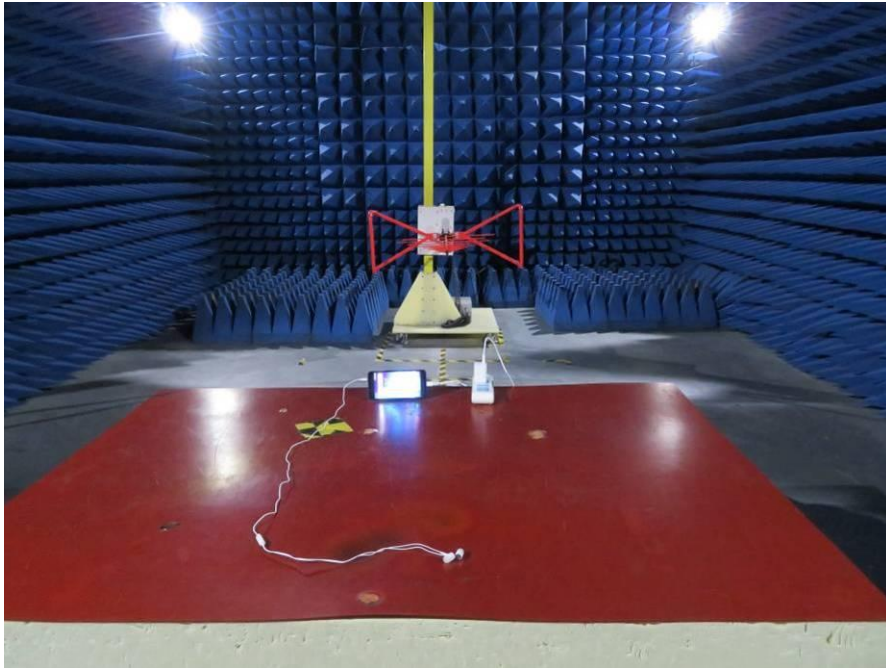

RADIATED EMISSION TEST

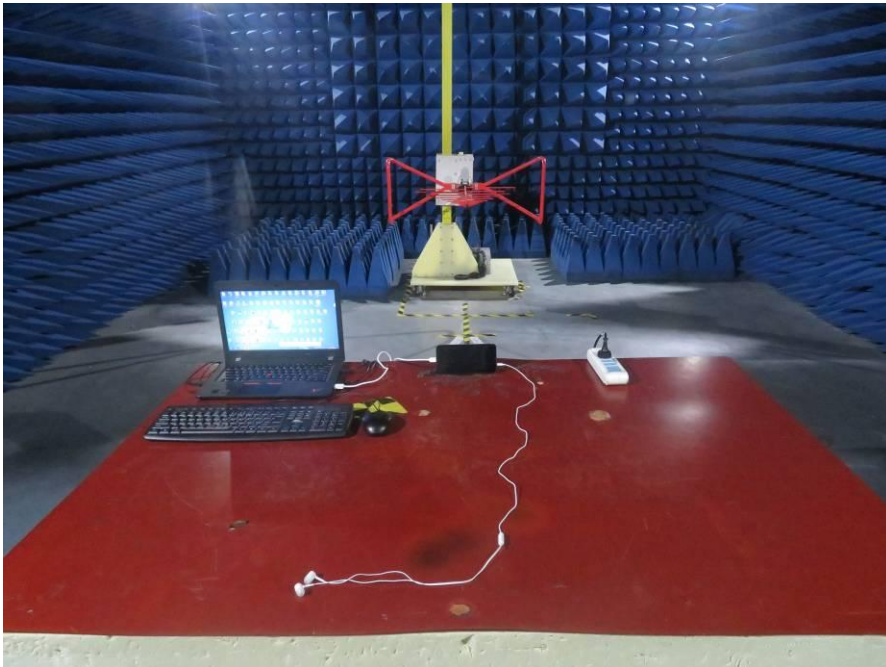

RADIATED EMISSION TEST

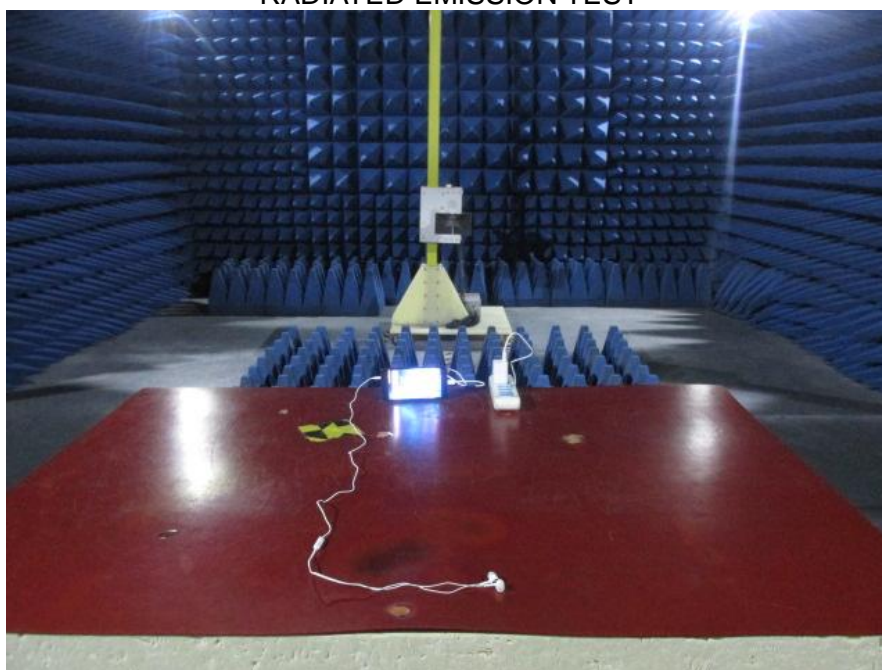

RADIATED EMISSION TEST

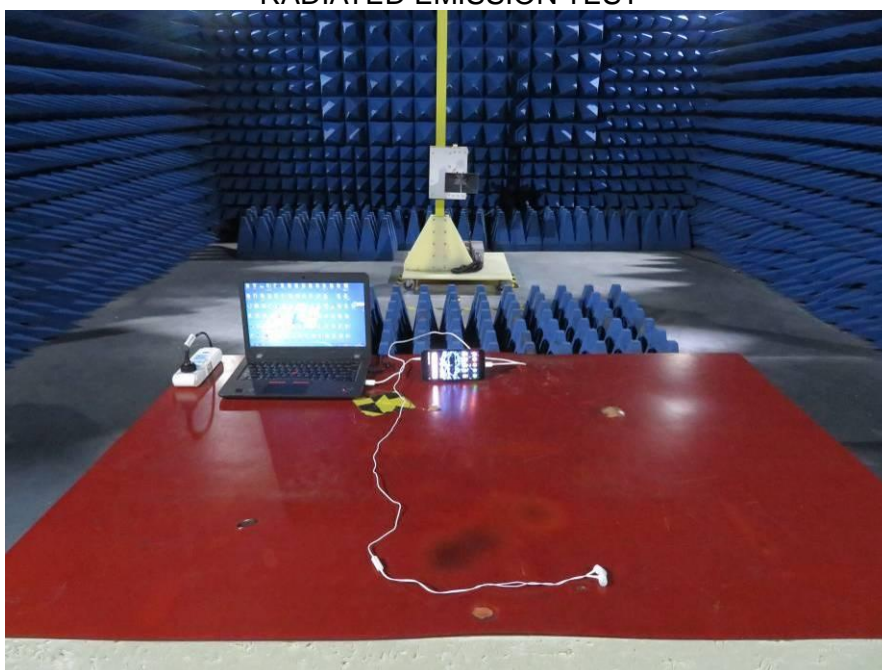



RADIATED EMISSION TEST

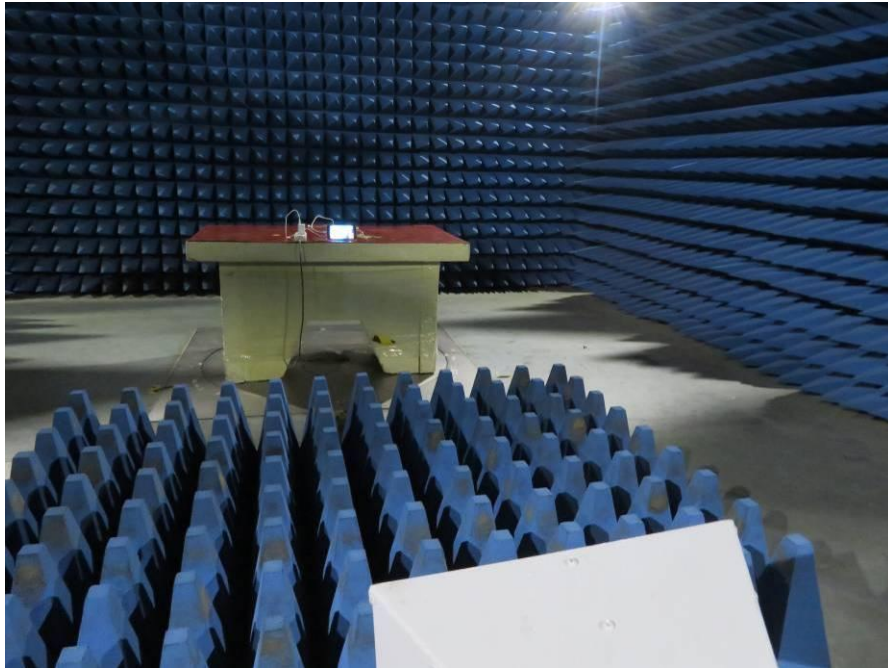

RADIATED EMISSION TEST

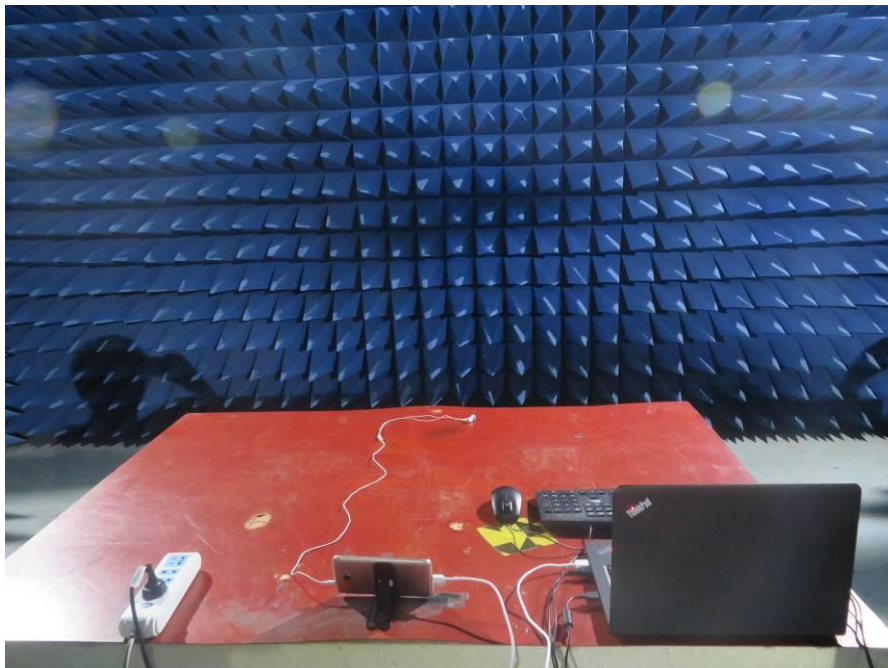

# 7. PHOTOGRAPHS OF EUT

Appearance photograph of EUT



Appearance photograph of EUT

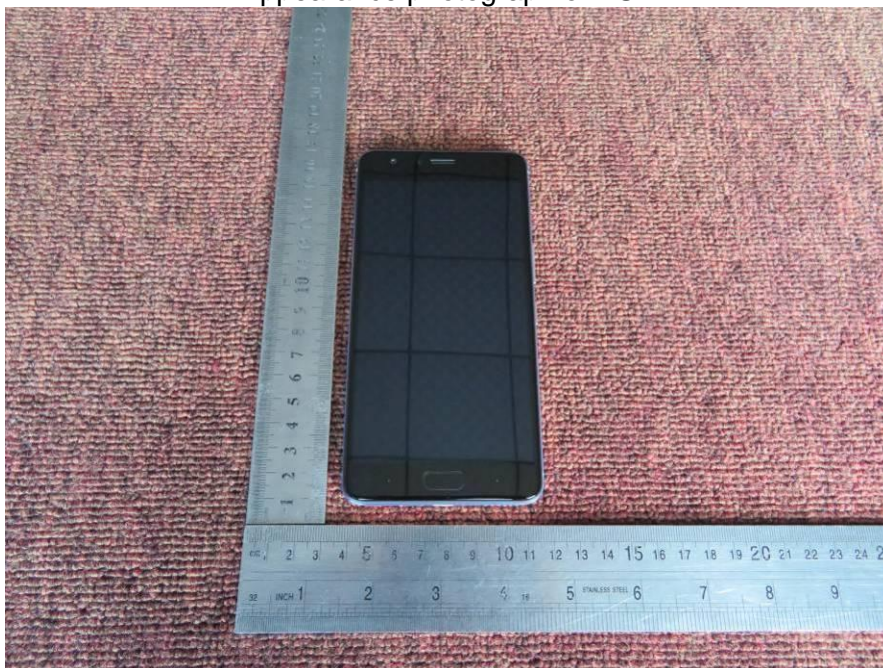

Appearance photograph of EUT



Appearance photograph of EUT



Appearance photograph of EUT



Appearance photograph of EUT

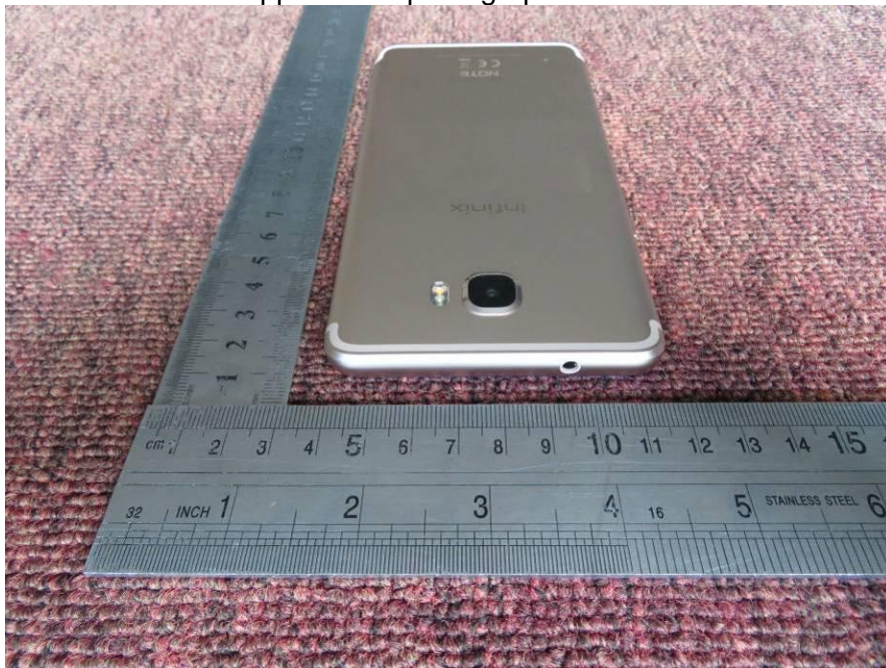

Appearance photograph of EUT



Internal photograph of EUT



Internal photograph of EUT

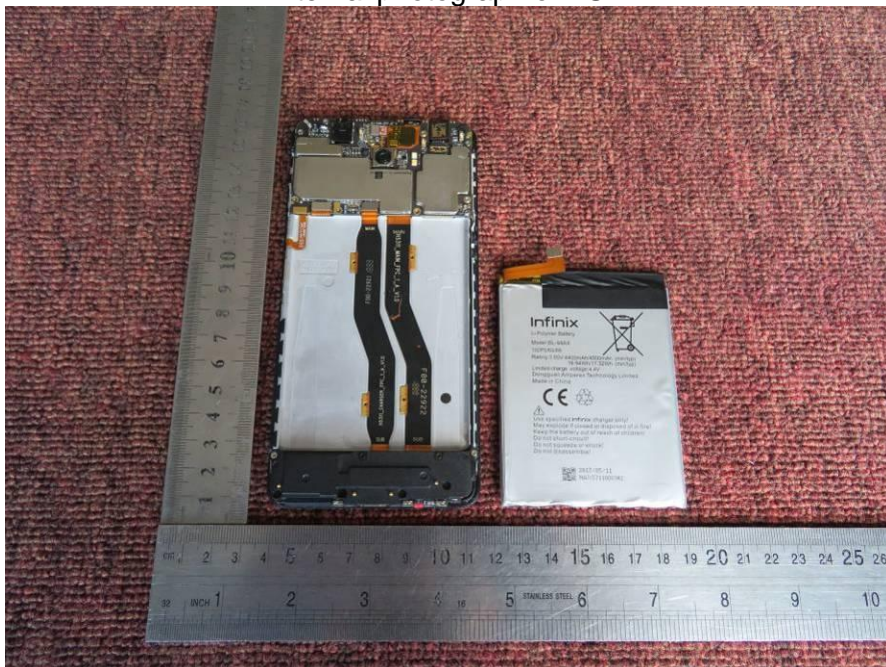

Internal photograph of EUT



Internal photograph of EUT



Internal photograph of EUT

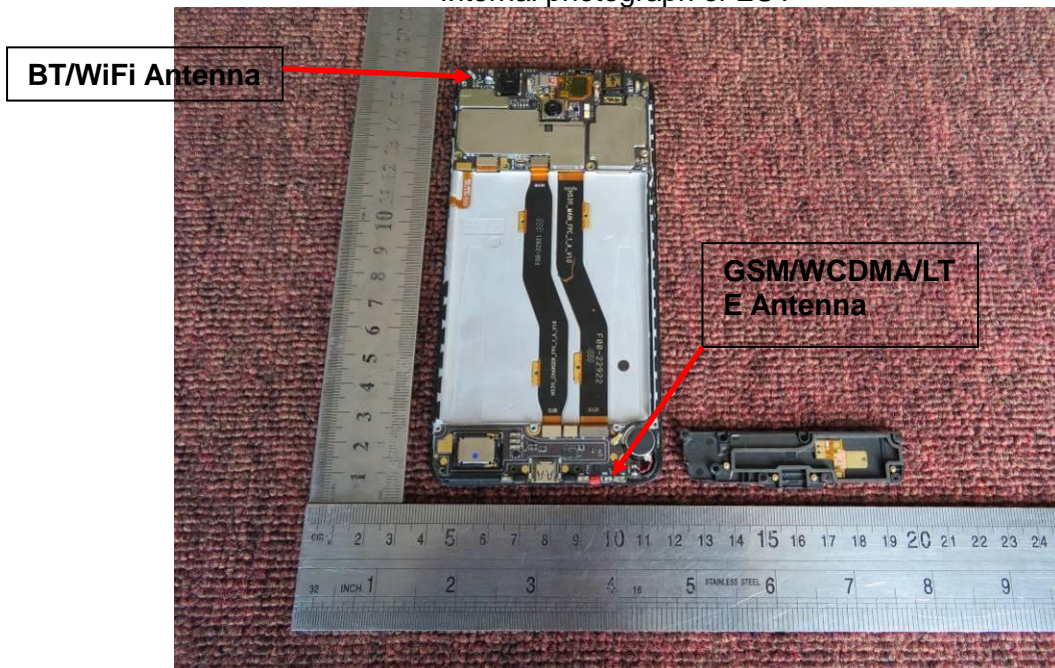

Internal photograph of EUT



Internal photograph of EUT

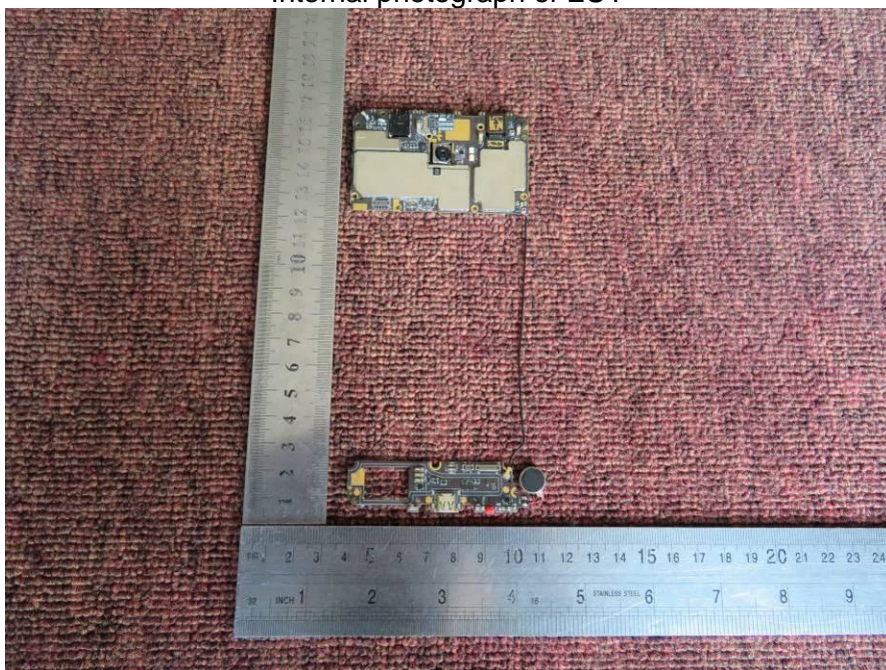



Internal photograph of EUT

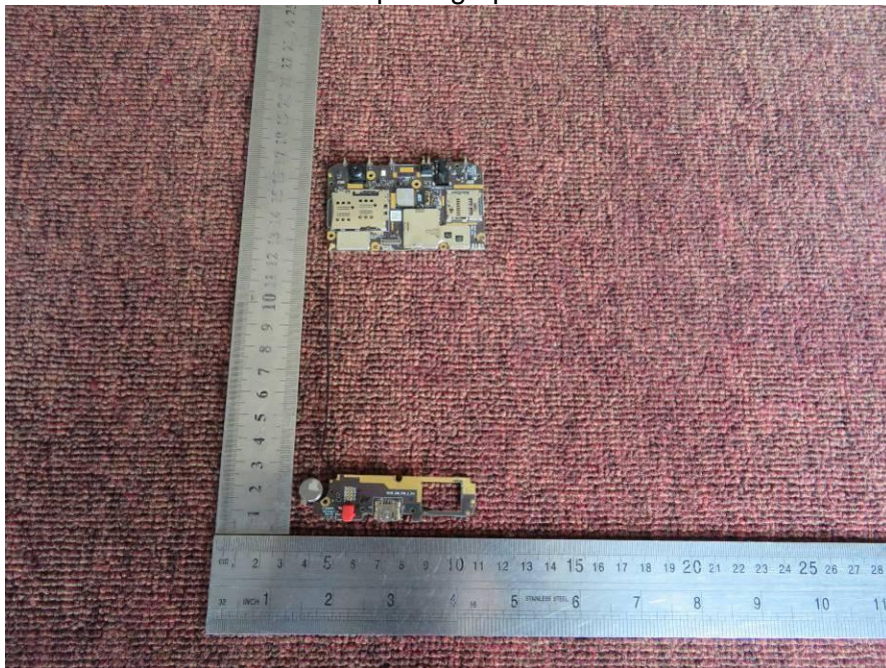

Internal photograph of EUT



Internal photograph of EUT

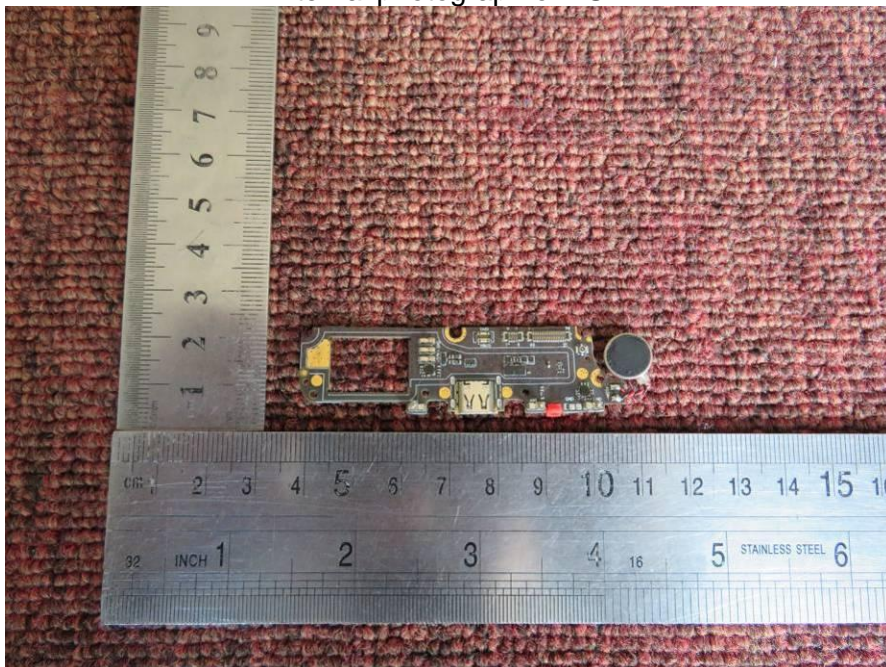

Internal photograph of EUT

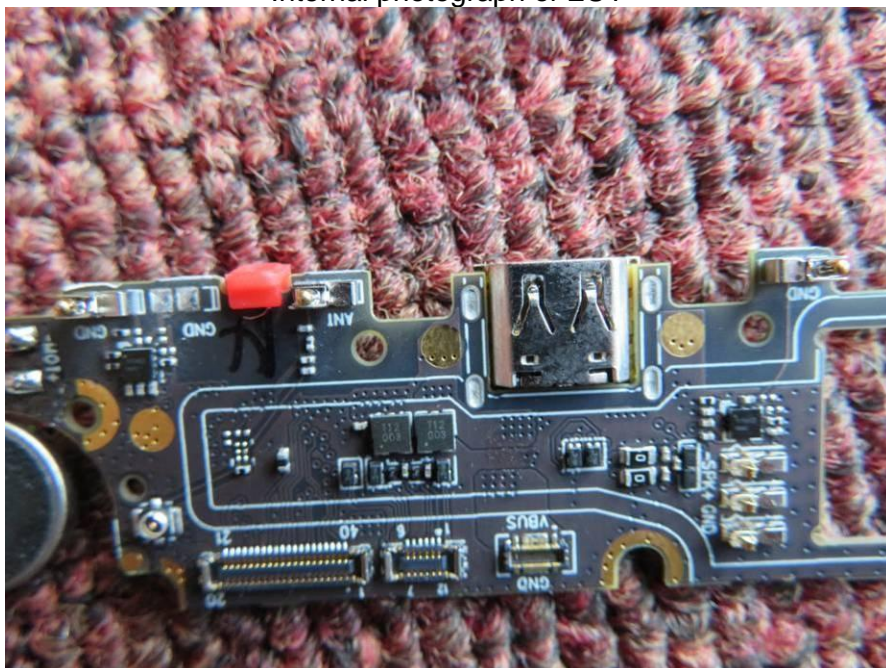

Internal photograph of EUT

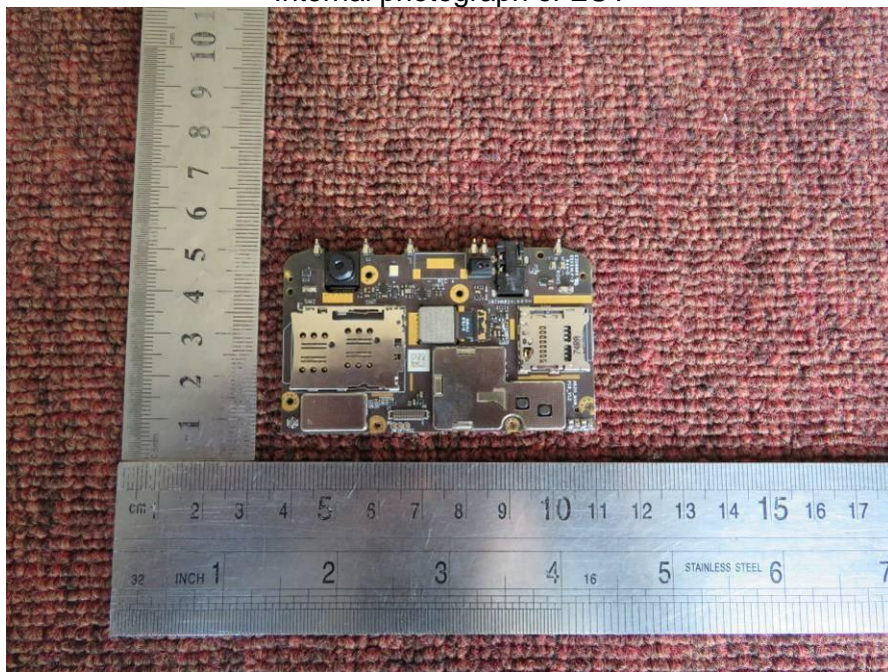

Internal photograph of EUT

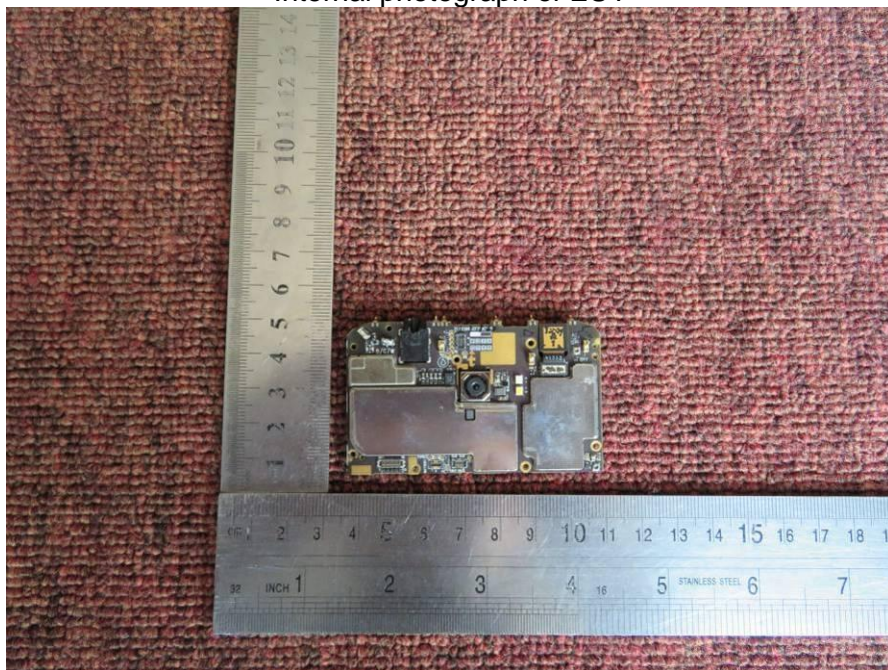

Internal photograph of EUT

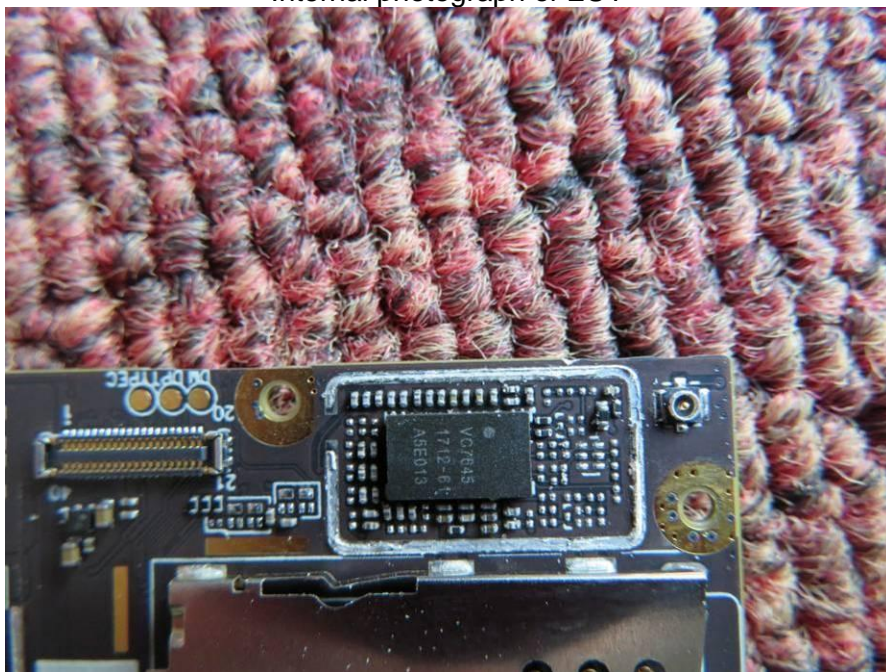

Internal photograph of EUT

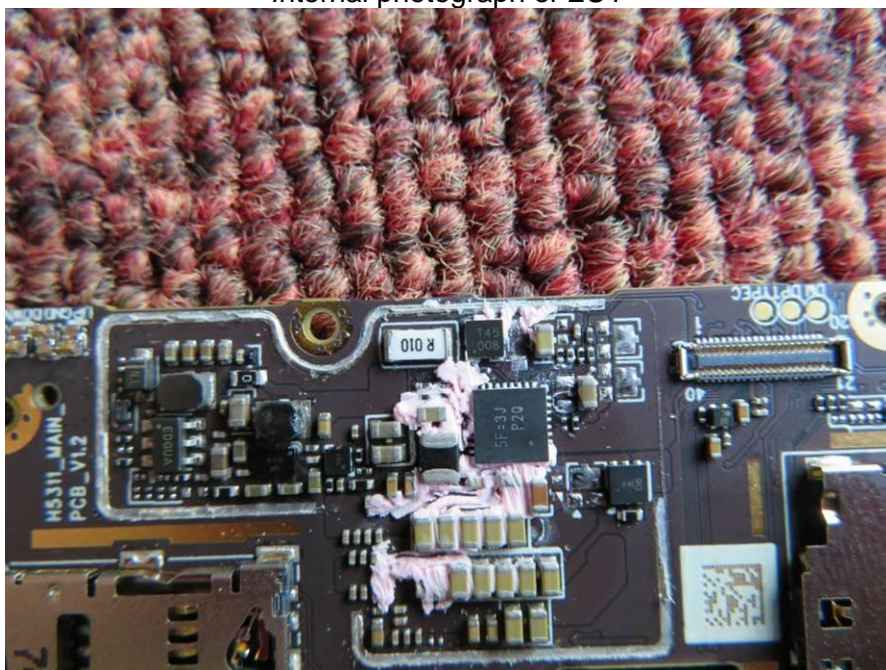

Internal photograph of EUT

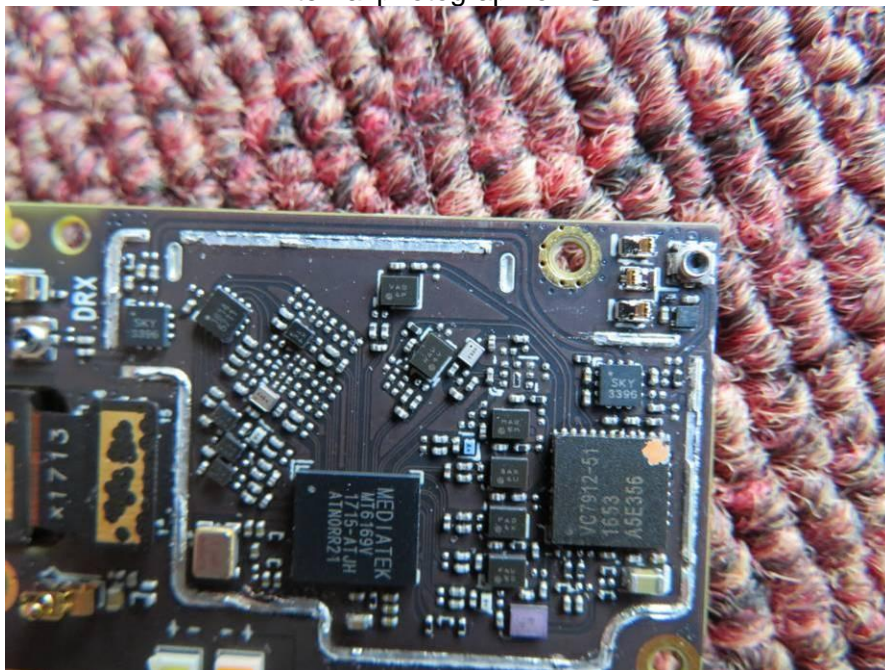

Internal photograph of EUT

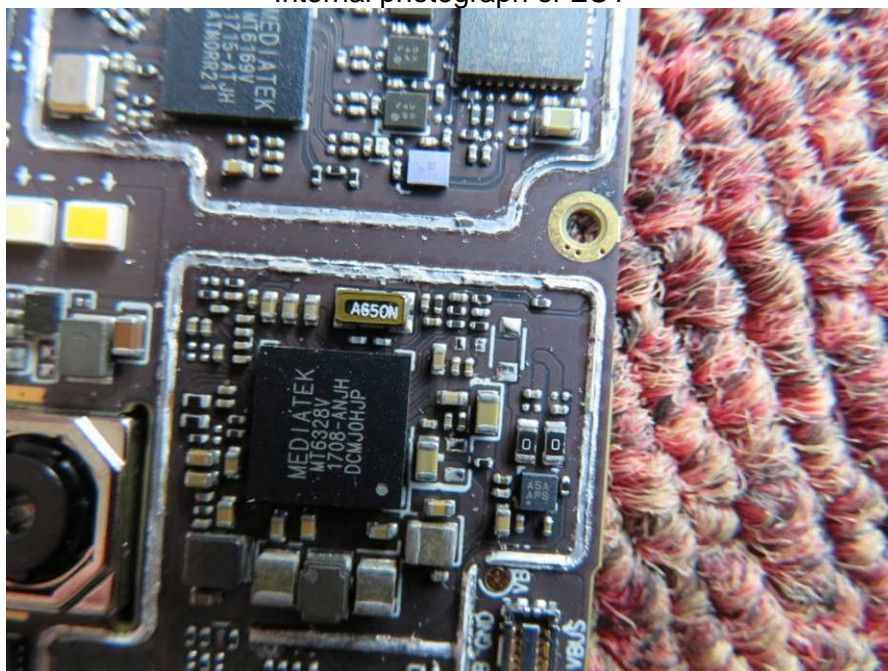

Internal photograph of EUT

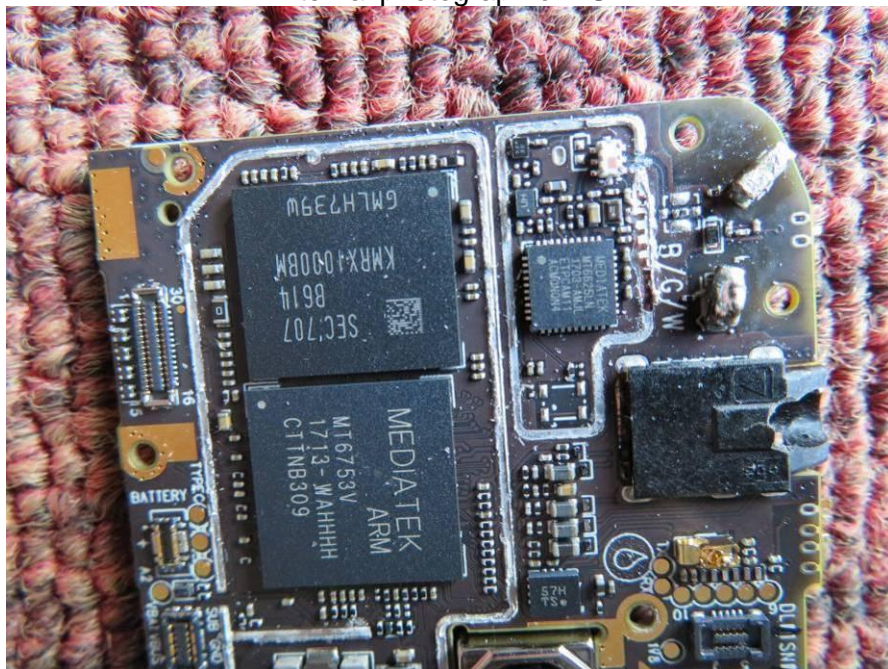

---END OF REPORT---