

FCC SAR Compliance Test Report

For

INFINIX MOBILITY LIMITED

RMS 05-15, 13A/F SOUTH TOWER WORLD FINANCE CTR HARBOUR CITY 17 CANTON

RD TST KLN HONG KONG

Model: X571

Test Engineer: Lily Zhao

Report Number: FCC17060520A-6

Report Date: 2017-06-22

FCC ID: 2AIZN-X571

Check By: Stars Liang

Stars Liang

Approved By: Michal Ling

Michal Ling

Prepared By: QTC Certification & Testing Co., Ltd.
2nd Floor, BI Building, Fengyeyuan Industrial Plant,,
Liuxian 2st. Road, Xin'an Street, Bao'an
District,, Shenzhen, 518000
Tel: +86-755-26996144 EXT:8164
Fax: +86-755-26996253

Table of contents

1	General information	5
1.1	Notes	5
1.2	Application details	5
1.3	Statement of Compliance.....	6
1.4	EUT Information	7
2	Testing laboratory	9
3	Test Environment.....	9
4	Applicant and Manufacturer	9
5	Test standard/s:.....	10
5.1	RF exposure limits.....	11
5.2	SAR Definition	11
6	SAR Measurement System	12
6.1	The Measurement System	12
6.2	Robot.....	13
6.3	Probe	13
6.4	Measurement procedure	14
6.5	Description of interpolation/extrapolation scheme.....	15
6.6	Phantom.....	16
6.7	Device Holder	17
6.8	Video Positioning System.....	18
6.9	Tissue simulating liquids: dielectric properties	19
6.10	Tissue simulating liquids: parameters	20
7	System Check.....	22
7.1	System check procedure	22
7.2	System check results	23
8	SAR Test Test Configuration	24
8.1	GSM Test Configurations.....	24
8.2	UMTS Test Configuration.....	24
8.3	LTE Test Configuration	26
8.4	Wi-Fi Test Configuration	28

8.5 WiFi 2.4G SAR Test Procedures.....28

8.6 WiFi 5G SAR Test Procedures.....29

9 Detailed Test Results.....31

9.1 Conducted Power measurements.....31

9.1.1 Conducted Power of GSM850.....31

9.1.2 Conducted Power of GSM1900.....32

9.1.3 Conducted Power of UMTS Band II.....33

9.1.4 Conducted Power of UMTS Band IV33

9.1.5 Conducted Power of UMTS Band V34

9.1.6 Conducted Power of LTE Band II35

9.1.7 Conducted Power of LTE Band IV.....38

9.1.8 Conducted Power of LTE Band VII.....41

9.1.9 Conducted Power of Wi-Fi 2.4G43

9.1.10 Conducted Power of Wi-Fi 5G43

9.1.11 Conducted Power of BT45

9.1.12 Tune-up power tolerance46

9.2 SAR test results47

9.2.1 Results overview of GSM850.....50

9.2.2 Results overview of GSM1900.....51

9.2.3 Results overview of UMTS Band II.....52

9.2.4 Results overview of UMTS Band IV53

9.2.5 Results overview of UMTS Band V54

9.2.6 Results overview of LTE Band II55

9.2.7 Results overview of LTE Band IV56

9.2.8 Results overview of LTE Band VII.....57

9.2.9 Results overview of Wi-Fi 2.4G58

9.2.10 Results overview of Wi-Fi 5G59

10 Multiple Transmitter Information.....60

10.1.1 Stand-alone SAR test exclusion.....61

10.1.2 Simultaneous Transmission Possibilities.....62

10.1.3 SAR Summation Scenario63

11 Measurement uncertainty evaluation68

- 11.1 Measurement uncertainty evaluation for SAR test68
- 11.2 Measurement uncertainty evaluation for system check.....69
- 12 Test equipment and ancillaries used for tests70
- Annex A: System performance verification.....71
- Annex B: Measurement results.....71
- Annex C: Calibration reports71
- Annex D: Photo documentation.....72

Modified History

REV.	Modification Description	Issued Date	Remark
REV.1.0	Initial Test Report Release	2017-06-22	Stars Liang

1 General information

1.1 Notes

The test results of this test report relate exclusively to the test item specified in this test report. Shenzhen Timeway Testing Laboratories does not assume responsibility for any conclusions and generalisations drawn from the test results with regard to other specimens or samples of the type of the equipment represented by the test item. The test report is not to be reproduced or published in full without the prior written permission.

1.2 Application details

Date of receipt of test item: 2017-06-14
Start of test: 2017-06-15
End of test: 2017-06-21

1.3 Statement of Compliance

The maximum results of Specific Absorption Rate (SAR) found during testing for X571 is as below:

Band	Position	MAX Reported SAR_{1g} (W/kg)
GSM850	Head	0.308
	Body & Hotspot 10mm	0.321
GSM1900	Head	0.138
	Body & Hotspot 10mm	0.799
UMTS Band II	Head	0.311
	Body & Hotspot 10mm	0.556
UMTS Band IV	Head	0.321
	Body & Hotspot 10mm	0.501
UMTS Band V	Head	0.216
	Body & Hotspot 10mm	0.229
LTE Band II	Head	0.102
	Body & Hotspot 10mm	0.425
LTE Band IV	Head	0.134
	Body & Hotspot 10mm	0.334
LTE Band VII	Head	0.108
	Body & Hotspot 10mm	0.038
Wi-Fi 2.4G	Head	0.325
	Body & Hotspot 10mm	0.115
Wi-Fi 5G	Head	0.194
	Body & Hotspot 10mm	0.110
The highest simultaneous SAR is 0.907W/kg per KDB690783 D01		

The device is in compliance with Specific Absorption Rate (SAR) for general population/uncontrolled exposure limits of 1.6 W/Kg as averaged over any 1g tissue according to the FCC rule §2.1093, the ANSI/IEEE C95.1:2005, the NCRP Report Number 86 for uncontrolled environment, according to the Industry Canada Radio Standards Specification RSS-102 for General Population/Uncontrolled exposure, and had been tested in accordance with the measurement methods and procedures specified in IEEE Std 1528-2013.

1.4 EUT Information

Device Information:			
Product Type:	Mobile phone		
Model:	X571		
Trade Name:	Infinix		
Device Type:	Portable device		
Exposure Category:	uncontrolled environment / general population		
Production Unit or Identical Prototype:	Production Unit		
Hardware version:	V1.1		
Software version :	X571-H5311B-N-PR2-170511V85		
Antenna Type :	Internal Antenna		
Device Operating Configurations:			
Supporting Mode(s) :	GSM850,PCS1900, UMTS Band II, UMTS Band IV ,UMTS Band V,LTE Band II, LTE Band IV , LTE Band VII ,Wi-Fi , BT		
Modulation:	GSM(GMSK),UMTS(QPSK/16QAM),LTE(QPSK/16QAM), Wi-Fi(OFDM/CCK),BT(GFSK/ $\pi/4$ -DQPSK/ 8-DPSK)		
Device Class :	Class B, No DTM Mode		
Operating Frequency Range(s)	Band	TX(MHz)	RX(MHz)
	GSM850	824~849	869~894
	GSM1900	1850~1910	1930~1990
	UMTS Band II	1850~1910	1930~1990
	UMTS Band IV	1710~1755	2110~2155
	UMTS Band V	824~849	869~894
	LTE Band II	1850~1910	1930~1990
	LTE Band IV	1710~1755	2110~2155
	LTE Band VII	2500~2570	2620~2690
	Wi-Fi (2.4G)	2412-2462	
	Wi-Fi (5G)	5150~5250 5725~5850	
	BT	2402~2480	
	GPRS class level:	GPRS class 12	
Test Channels (low-mid-high):	128-190-251(GSM850)		
	512-661-810(GSM1900)		
	9262-9400-9538(UMTS Band II)		

	1312-1413-1513(UMTS Band IV)
	4132-4182-4233(UMTS Band V)
	18700-18900-19100(LTE Band II)
	20050-20175-20300(LTE Band IV)
	20850-21100-21350(LTE Band VII)
	1-6-11 (Wi-Fi 2.4G)
	802.11a/n/ac 20M: 36-40-44-48-52-56-60-64-149-153-157-161-165
	802.11 n/ac 40M: 38-46-54-62-151-159 (Wi-Fi 5G)
	0-39-78(BT) 0-19-39(BLE)
Power Source:	3.85 VDC/4400mAh/4500mAh(min/typ) Rechargeable Battery

2 Testing laboratory

Test Site	QTC Certification & Testing Co., Ltd.
Test Location	2nd Floor, BI Building, Fengyeyuan Industrial Plant,, Liuxian 2st. Road, Xin'an Street, Bao'an District,, Shenzhen, 518000
Telephone	+86-755-26996144 EXT:8164
Fax	+86-755-26996253

3 Test Environment

	Required	Actual
Ambient temperature:	18 – 25 °C	22 ± 2 °C
Tissue Simulating liquid:	22 ± 2 °C	22 ± 2 °C
Relative humidity content:	30 – 70 %	30 – 70 %

4 Applicant and Manufacturer

Applicant/Client Name:	INFINIX MOBILITY LIMITED
Applicant Address:	RMS 05-15, 13A/F SOUTH TOWER WORLD FINANCE CTR HARBOUR CITY 17 CANTON RD TST KLN HONG KONG
Manufacturer Name:	SHENZHEN TECNO TECHNOLOGY CO.,LTD.
Manufacturer Address:	1-4th Floor, 3rd Building, Pacific Industrial Park, No.2088, Shenyang Road, Yantian District, Shenzhen, Guangdong, China

5 Test standard/s:

ANSI Std C95.1-2005	Safety Levels with Respect to Human Exposure to Radio Frequency Electromagnetic Fields, 3 kHz to 300 GHz.
IEEE Std 1528-2013	Recommended Practice for Determining the Peak Spatial-Average Specific Absorption Rate (SAR) in the Human Head from Wireless Communications Devices: Measurement Techniques
RSS-102	Radio Frequency Exposure Compliance of Radiocommunication Apparatus (All Frequency Bands (Issue 5 March 2015)
KDB447498 D01	General RF Exposure Guidance v06
KDB648474 D04	Head set SAR v01r03
KDB941225 D06	Hot Spot SAR V02r01
KDB941225 D01	3G SAR Measurement Procedures
KDB248227 D01	SAR meas for 802.11 a/b/g v02r02
KDB865664 D01	SAR Measurement 100 MHz to 6 GHz v01r04
KDB865664 D02	RF Exposure Reporting v01r02
KDB 941225 D05	SAR Evaluation Considerations for LTE Devices
KDB941225 D05A	LTE Rel.10 KDB Inquiry Sheet v01r02

5.1 RF exposure limits

Human Exposure	Uncontrolled Environment General Population	Controlled Environment Occupational
Spatial Peak SAR* (Brain/Body/Arms/Legs)	1.60 mW/g	8.00 mW/g
Spatial Average SAR** (Whole Body)	0.08 mW/g	0.40 mW/g
Spatial Peak SAR*** (Heads/Feet/Ankle/Wrist)	4.00 mW/g	20.00 mW/g

The limit applied in this test report is shown in bold letters

Notes:

- * The Spatial Peak value of the SAR averaged over any 1 gram of tissue (defined as a tissue volume in the shape of a cube) and over the appropriate averaging time.
- ** The Spatial Average value of the SAR averaged over the whole body.
- *** The Spatial Peak value of the SAR averaged over any 10 grams of tissue (defined as a tissue volume in the shape of a cube) and over the appropriate averaging time.

Uncontrolled Environments are defined as locations where there is the exposure of individuals who have no knowledge or control of their exposure.

Controlled Environments are defined as locations where there is exposure that may be incurred by persons who are aware of the potential for exposure, (i.e. as a result of employment or occupation).

5.2 SAR Definition

Specific Absorption Rate is defined as the time derivative (rate) of the incremental energy (dW) absorbed by (dissipated in) an incremental mass (dm) contained in a volume element (dV) of a given density (ρ).

$$SAR = \frac{d}{dt} \left(\frac{dW}{dm} \right) = \frac{d}{dt} \left(\frac{dW}{\rho dV} \right)$$

SAR is expressed in units of watts per kilogram (W/kg). SAR can be related to the electric field at a point by

$$SAR = \frac{\sigma |E|^2}{\rho}$$

where:

- σ = conductivity of the tissue (S/m)
- ρ = mass density of the tissue (kg/m³)

E = rms electric field strength (V/m)

6 SAR Measurement System

6.1 The Measurement System

Comosar is a system that is able to determine the SAR distribution inside a phantom of human being according to different standards. The Comosar system consists of the following items:

- Main computer to control all the system
- 6 axis robot
- Data acquisition system
- Miniature E-field probe
- Device holder
- Head simulating tissue

The following figure shows the system.



The EUT under test operating at the maximum power level is placed in the phone holder, under the phantom, which is filled with head simulating liquid. The E-Field probe measures the electric field inside the phantom. The OpenSAR software computes the results to give a SAR value in a 1g or 10g mass.

6.2 Robot

The COMOSAR system uses the high precision robots KR 6 R900 sixx type out of the newer series from Satimo SA (France).For the 6-axis controller COMOSAR system, the KUKA robot controller version from Satimo is used. The KR 6 R900 sixx robot series have many features that are important for our application:

- High precision (repeatability 0.02 mm)
- High reliability (industrial design)
- Jerk-free straight movements
- Low ELF interference (the closed metallic construction shields against motor control fields)
- 6-axis controller

6.3 Probe

For the measurements the Specific Dosimetric E-Field Probe SSE 5 with following specifications is used



Figure 1 – MVG COMOSAR Dosimetric E field Dipole

- Dynamic range: 0.01-100 W/kg

Probe Length	330 mm
Length of Individual Dipoles	4.5 mm
Maximum external diameter	8 mm
Probe Tip External Diameter	5 mm
Distance between dipoles / probe extremity	2.7 mm

- Calibration range: 300MHz to 3GHz for head & body simulating liquid.

Angle between probe axis (evaluation axis) and surface normal line:less than 30°



Figure 2 – MVG COMOSAR Dosimetric E field Dipole

Dynamic range: 0.01-100 W/kg

Probe Length	330 mm
Length of Individual Dipoles	2 mm
Maximum external diameter	8 mm
Probe Tip External Diameter	2.5 mm
Distance between dipoles / probe extremity	1 mm

- Calibration range: 5GHz to 6GHz for head & body simulating liquid.

Angle between probe axis (evaluation axis) and surface normal line:less than 30°

6.4 Measurement procedure

The following steps are used for each test position

- Establish a call with the maximum output power with a base station simulator. The connection between the mobile and the base station simulator is established via air interface.
- Measurement of the local E-field value at a fixed location. This value serves as a reference value for calculating a possible power drift.
- Measurement of the SAR distribution with a grid of 8 to 16 mm * 8 to 16 mm and a constant distance to the inner surface of the phantom. Since the sensors can not directly measure at the inner phantom surface, the values between the sensors and the inner phantom surface are extrapolated. With these values the area of the maximum SAR is calculated by an interpolation scheme.
- Around this point, a cube of 30 * 30 * 30 mm or 32 * 32 * 32 mm is assessed by measuring 5 or 8 * 5 or 8 * 4 or 5 mm. With these data, the peak spatial-average SAR value can be calculated.

Spatial Peak SAR Evaluation

The procedure for spatial peak SAR evaluation has been implemented according to the test standard. It can be conducted for 1g and 10g, as well as for user-specific masses. The SATIMO software includes all numerical procedures necessary to evaluate the spatial peak SAR value.

The base for the evaluation is a "cube" measurement. The measured volume must include the 1g and 10g cubes with the highest averaged SAR values. For that purpose, the center of the measured volume is aligned to the interpolated peak SAR value of a previously performed area scan.

The entire evaluation of the spatial peak values is performed within the post-processing engine. The system always gives the maximum values for the 1g and 10g cubes. The algorithm to find the cube with highest averaged SAR is divided into the following stages:

- (a) Extraction of the measured data (grid and values) from the Zoom Scan
- (b) Calculation of the SAR value at every measurement point based on all stored data (A/D values and measurement parameters)
- (c) Generation of a high-resolution mesh within the measured volume
- (d) Interpolation of all measured values from the measurement grid to the high-resolution grid
- (e) Extrapolation of the entire 3-D field distribution to the phantom surface over the distance from sensor to surface
- (f) Calculation of the averaged SAR within masses of 1g and 10g

SAR Averaged Methods

In SATIMO, the interpolation and extrapolation are both based on the modified Quadratic Shepard's method. The interpolation scheme combines a least-square fitted function method and a weighted average method which are the two basic types of computational interpolation and approximation.

Extrapolation routines are used to obtain SAR values between the lowest measurement points and the inner phantom surface. The extrapolation distance is determined by the surface detection distance and the probe sensor offset. The uncertainty increases with the extrapolation distance. To keep the uncertainty within 1% for the 1 g and 10 g cubes, the extrapolation distance should not be larger than 5 mm.

6.5 Description of interpolation/extrapolation scheme

- The local SAR inside the phantom is measured using small dipole sensing elements inside a probe body. The probe tip must not be in contact with the phantom surface in order to minimise measurements errors, but the highest local SAR will occur at the surface of the phantom.
- An extrapolation is used to determine these highest local SAR values. The extrapolation is based on a fourth-order least-square polynomial fit of measured data. The local SAR value is then extrapolated from the liquid surface with a 1 mm step.
- The measurements have to be performed over a limited time (due to the duration of the battery) so the step of measurement is high. It could vary between 5 and 8 mm. To obtain an accurate assessment of the maximum SAR average over 10 grams and 1 gram requires a very fine resolution in the three dimensional scanned data array.

6.6 Phantom

For the measurements the Specific Anthropomorphic Mannequin (SAM) defined by the IEEE SCC-34/SC2 group is used. The phantom is a polyurethane shell integrated in a wooden table. The thickness of the phantom amounts to 2mm +/- 0.2mm. It enables the dosimetric evaluation of left and right phone usage and includes an additional flat phantom part for the simplified performance check. The phantom set-up includes a cover, which prevents the evaporation of the liquid.



System Material	Permittivity	Loss Tangent
Delrin	3.7	0.005

6.7 Device Holder

The positioning system allows obtaining cheek and tilting position with a very good accuracy. In compliance with CENELEC, the tilt angle uncertainty is lower than 1°.

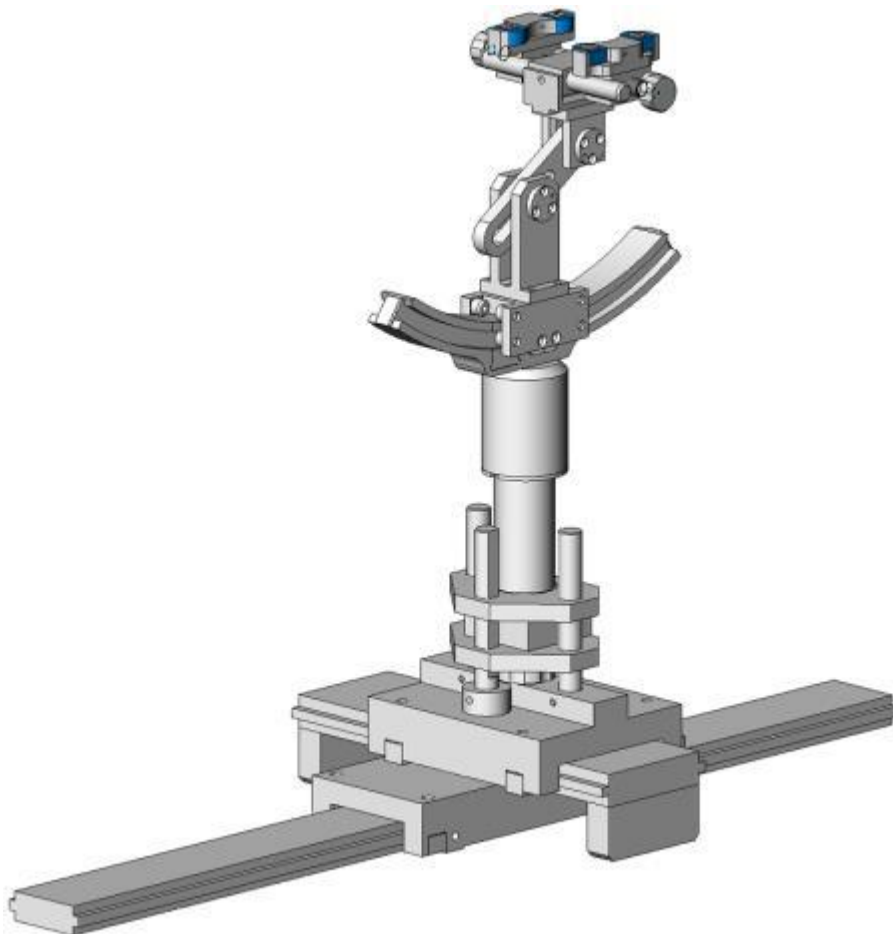

Device holder

System Material	Permittivity	Loss Tangent
Delrin	3.7	0.005

6.8 Video Positioning System

- The video positioning system is used in OpenSAR to check the probe. Which is composed of a camera, LED, mirror and mechanical parts. The camera is piloted by the main computer with firewire link.
- During the process, the actual position of the probe tip with respect to the robot arm is measured, as well as the probe length and the horizontal probe offset. The software then corrects all movements, such that the robot coordinates are valid for the probe tip.
- The repeatability of this process is better than 0.1 mm. If a position has been taught with an aligned probe, the same position will be reached with another aligned probe within 0.1 mm, even if the other probe has different dimensions. During probe rotations, the probe tip will keep its actual position.



6.9 Tissue simulating liquids: dielectric properties

For SAR measurement of the field distribution inside the phantom, the phantom must be filled with homogeneous tissue simulating liquid to a depth of at least 15 cm. For head SAR testing, the liquid height from the ear reference point (ERP) of the phantom to the liquid top surface is larger than 15 cm. For body SAR testing, the liquid height from the center of the flat phantom to the liquid top surface is larger than 15 cm. The simulating liquids should be checked at the beginning of a series of SAR measurements to determine if the dielectric parameters are within the tolerances of the specified target values. The measured conductivity and relative permittivity should be within ± 5% of the target values.

The following materials are used for producing the tissue-equivalent materials.

(Liquids used for tests are marked with ☒):

Ingredients(% of weight)	Frequency (MHz)					
	<input type="checkbox"/> 750	<input checked="" type="checkbox"/> 835	<input checked="" type="checkbox"/> 1800	<input checked="" type="checkbox"/> 1900	<input checked="" type="checkbox"/> 2450	<input checked="" type="checkbox"/> 2600
frequency band	<input type="checkbox"/> 750	<input checked="" type="checkbox"/> 835	<input checked="" type="checkbox"/> 1800	<input checked="" type="checkbox"/> 1900	<input checked="" type="checkbox"/> 2450	<input checked="" type="checkbox"/> 2600
Tissue Type	Head	Head	Head	Head	Head	Head
Water	39.2	41.45	52.64	55.242	62.7	55.242
Salt (NaCl)	2.7	1.45	0.36	0.306	0.5	0.306
Sugar	57.0	56.0	0.0	0.0	0.0	0.0
HEC	0.0	1.0	0.0	0.0	0.0	0.0
Bactericide	0.0	0.1	0.0	0.0	0.0	0.0
Triton X-100	0.0	0.0	0.0	0.0	36.8	0.0
DGBE	0.0	0.0	47.0	44.542	0.0	44.452
Ingredients(% of weight)	Frequency (MHz)					
frequency band	<input type="checkbox"/> 750	<input checked="" type="checkbox"/> 835	<input checked="" type="checkbox"/> 1800	<input checked="" type="checkbox"/> 1900	<input checked="" type="checkbox"/> 2450	<input checked="" type="checkbox"/> 2600
Tissue Type	Body	Body	Body	Body	Body	Body
Water	50.30	52.4	69.91	69.91	73.2	64.493
Salt (NaCl)	1.60	1.40	0.13	0.13	0.04	0.024
Sugar	47.0	45.0	0.0	0.0	0.0	0.0
HEC	0.0	1.0	0.0	0.0	0.0	0.0
Bactericide	0.0	0.1	0.0	0.0	0.0	0.0
Triton X-100	0.0	0.0	0.0	0.0	0.0	0.0
DGBE	0.0	0.0	29.96	29.96	26.7	32.252

Salt: 99+% Pure Sodium Chloride

Sugar: 98+% Pure Sucrose

Water: De-ionized, 16MΩ+ resistivity

HEC: Hydroxyethyl Cellulose

DGBE: 99+% Di(ethylene glycol) butyl ether, [2-(2-butoxyethoxy)ethanol]

Triton X-100(ultra pure): Polyethylene glycol mono [4-(1,1,3,3-tetramethylbutyl)phenyl]ether

☒ Simulating Head Liquid for 5G(HBBL3500-5800MHz), Manufactured by SPEAG:

Ingredients	(% by weight)
Water	50-65%
Mineral oil	10-30%
Emulsifiers	8-25%
Sodium salt	0-1.5%

Simulating Body Liquid for 5G(MBBL3500-5800MHz), Manufactured by SPEAG:

Ingredients	(% by weight)
Water	60-80%
Esters, Emulsifiers, Inhibitors	20-40%
Sodium salt	0-1.5%

6.10 Tissue simulating liquids: parameters

Tissue Type	Measured Frequency (MHz)	Target Tissue				Measured Tissue		Liquid Temp.	Test Date
		Target Permittivity ϵ_r	Range of $\pm 5\%$	Target Conductivity σ (S/m)	Range of $\pm 5\%$	ϵ_r	σ (S/m)		
835MHz Head	825	41.60	39.52~43.68	0.90	0.86~0.95	40.34	0.91	21.6°C	2017-06-10
	835	41.50	39.43~43.58	0.90	0.86~0.95	40.33	0.92		
	850	41.50	39.43~43.58	0.92	0.87~0.97	40.11	0.94		
835MHz Body	825	55.20	52.44~57.96	0.97	0.92~1.02	54.04	0.98		
	835	55.20	52.44~57.96	0.97	0.92~1.02	53.93	0.99		
	850	55.20	52.44~57.96	0.99	0.94~1.04	53.69	1.01		
1800MHz Head	1710	40.10	38.10~42.10	1.35	1.28~1.42	39.95	1.34	21.6°C	2017-06-15
	1730	40.10	38.10~42.10	1.35	1.29~1.43	39.87	1.36		
	1750	40.10	38.10~42.10	1.37	1.30~1.44	39.69	1.39		
	1800	40.00	38.00~42.00	1.40	1.33~1.47	39.48	1.44		
1800MHz Body	1710	53.50	50.83~56.18	1.46	1.39~1.53	53.24	1.45		
	1730	53.50	50.83~56.18	1.48	1.41~1.55	53.39	1.47		
	1750	53.40	50.73~56.07	1.49	1.42~1.56	53.19	1.49		
	1800	53.30	50.64~55.97	1.52	1.44~1.60	52.97	1.54		
1900MHz Head	1850	40.00	38.00~42.00	1.40	1.33~1.47	39.93	1.37	21.6°C	2017-05-24
	1880	40.00	38.00~42.00	1.40	1.33~1.47	39.91	1.40		
	1900	40.00	38.00~42.00	1.40	1.33~1.47	39.98	1.41		
	1910	40.00	38.00~42.00	1.40	1.33~1.47	39.97	1.42		
1900MHz Body	1850	53.30	50.64~55.97	1.52	1.44~1.60	53.23	1.49		
	1880	53.30	50.64~55.97	1.52	1.44~1.60	53.36	1.53		
	1900	53.30	50.64~55.97	1.52	1.44~1.60	53.37	1.56		
	1910	53.30	50.64~55.97	1.52	1.44~1.60	53.37	1.57		
2450MHz Head	2410	39.30	37.34~41.26	1.76	1.67~1.85	39.22	1.78	21.6°C	2017-06-17
	2435	39.20	37.24~41.16	1.79	1.70~1.88	39.25	1.77		

	2450	39.20	37.24~41.16	1.80	1.71~1.89	39.24	1.76		
	2460	39.20	37.24~41.16	1.81	1.72~1.90	39.20	1.76		
2450MHz Body	2410	52.80	50.16~55.44	1.91	1.81~2.00	52.72	1.92		
	2435	52.70	50.07~55.34	1.94	1.84~2.04	52.75	1.92		
	2450	52.70	50.07~55.34	1.95	1.85~2.05	52.74	1.91		
	2460	52.70	50.07~55.34	1.96	1.86~2.06	52.70	1.91		
2600MHz Head	2510	39.00	37.05~40.95	1.96	1.86~2.06	38.87	1.93	21.6°C	2017-06-08
	2535	39.00	37.05~40.95	1.96	1.86~2.06	38.58	1.93		
	2560	39.00	37.05~40.95	1.96	1.86~2.06	38.98	2.02		
	2600	39.00	37.05~40.95	1.96	1.86~2.06	52.50	2.02		
2600MHz Body	2510	52.50	49.90~55.11	2.16	2.05~2.27	52.21	2.05		
	2535	52.50	49.90~55.11	2.16	2.05~2.27	51.92	2.06		
	2560	52.50	49.90~55.11	2.16	2.05~2.27	52.01	2.09		
	2600	52.50	49.90~55.11	2.16	2.05~2.27	38.87	1.93		
5G Head	5200	36.0	34.20~37.80	4.66	4.43~4.89	35.62	4.50	21.6°C	2017-06-17
	5300	35.9	34.10~37.70	4.76	4.52~5.00	35.52	4.83		
	5800	35.3	33.54~37.07	5.27	5.01~5.53	34.63	5.16		
5G Body	5200	49.0	46.55~51.45	5.30	5.03~5.56	49.86	5.19		
	5300	48.9	46.05~51.35	5.42	5.15~5.69	48.32	5.27		
	5800	48.20	45.79~50.61	6.00	5.70~6.30	47.74	6.09		
ε _r = Relative permittivity, σ= Conductivity									

7 System Check

7.1 System check procedure

The System check is performed by using a System check dipole which is positioned parallel to the planar part of the SAM phantom at the reference point. The distance of the dipole to the SAM phantom is determined by a spacer. The dipole is connected to the signal source consisting of signal generator and amplifier via a directional coupler, N-connector cable and adaption to SMA. It is fed with a power of 100 mW. To adjust this power a power meter is used. The power sensor is connected to the cable before the System check to measure the power at this point and do adjustments at the signal generator. At the outputs of the directional coupler both return loss as well as forward power are controlled during the validation to make sure that emitted power at the dipole is kept constant. This can also be checked by the power drift measurement after the test (result on plot).

System check results have to be equal or near the values determined during dipole calibration (target SAR in table above) with the relevant liquids and test system.

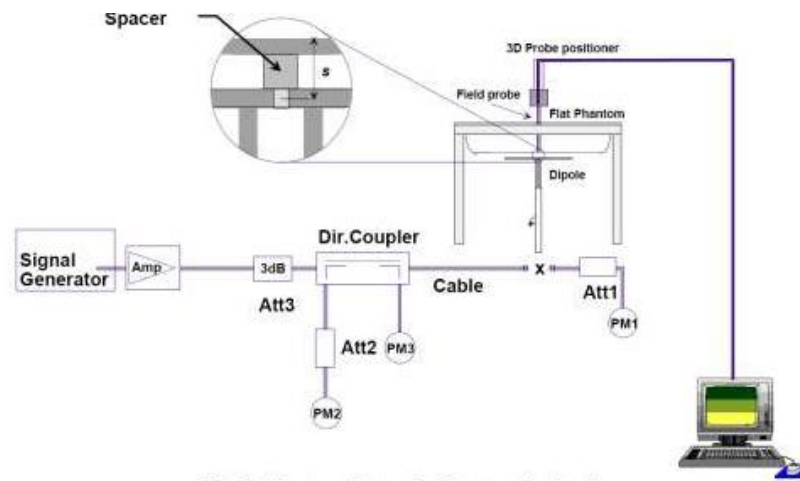

7.2 System check results

The system Check is performed for verifying the accuracy of the complete measurement system and performance of the software. The following table shows System check results for all frequency bands and tissue liquids used during the tests (plot(s) see annex A).

System Check	Target SAR (1W) (+/-10%)				Measured SAR (Normalized to 1W)		Liquid Temp.	Test Date
	1-g (W/g)	Range of $\pm 10\%$ 1-g (W/g)	10-g (W/g)	Range of $\pm 10\%$ 10-g (W/g)	1-g (W/g)	10-g (W/g)		
D835V2 Head	9.82	8.84~10.80	6.35	5.72~6.99	9.700	6.150	21.6°C	2017/06/10
D1800V2 Head	37.09	33.38~40.80	19.77	17.93~21.75	39.980	20.600	21.6°C	2017/06/15
D1900V2 Head	38.93	35.04~42.82	20.27	18.45~22.55	39.980	21.070	21.6°C	2017/05/24
D2450V2 Head	53.41	48.07~58.75	23.95	21.56~26.35	53.930	24.530	21.6°C	2017/06/17
D2600V2 Head	56.88	51.20~62.56	24.92	22.43~27.41	53.180	23.430	21.6°C	2017/06/08
D5200V2 Head	164.05	147.65~180.45	57.03	51.33~62.73	174.700	56.790	21.6°C	2017/06/17
D5300V2 Head	171.66	154.50~188.82	59.33	53.40~65.26	177.950	61.560	21.6°C	2017/06/17
D5800V2 Head	185.02	166.52~203.52	62.43	56.19~68.67	185.190	63.340	21.6°C	2017/06/17
D835V2 Body	9.41	8.47~10.35	6.22	5.99~6.84	10.150	6.450	21.6°C	2017/06/10
D1800V2 Body	38.03	34.23~41.83	20.69	18.62~22.76	41.560	21.720	21.6°C	2017/06/15
D1900V2 Body	38.73	34.86~42.60	20.48	18.43~22.53	39.330	20.940	21.6°C	2017/05/24
D2450V2 Body	51.39	46.25~56.53	23.63	21.27~25.99	54.330	23.330	21.6°C	2017/06/17
D2600V2 Body	54.54	49.09~59.99	24.37	21.94~26.80	57.860	25.600	21.6°C	2017/06/08
D5200V2 Body	163.36	147.03~179.69	57.09	51.39~62.79	167.180	59.640	21.6°C	2017/06/17
D5300V2 Body	166.22	149.60~182.84	57.22	51.50~62.94	165.370	58.820	21.6°C	2017/06/17
D5800V2 Body	177.10	159.39~194.81	59.95	53.96~65.94	179.660	60.800	21.6°C	2017/06/17

Note: All SAR values are normalized to 1W forward power.

Note: 5G band system check USES standard waveguide, so the test results are standard en62209-2 table B2

8 SAR Test Test Configuration

8.1 GSM Test Configurations

SAR tests for GSM850 and GSM1900, a communication link is set up with a base station by air link. Using CMU200 the power level is set to “5” and “0” in SAR of GSM850 and GSM1900. The tests in the band of GSM 850 and GSM 1900 are performed in the mode of GPRS/EGPRS function. Since the GPRS class is 12 for this EUT, it has at most 4 timeslots in uplink and at most 4 timeslots in downlink, the maximum total timeslot is 5.

When SAR tests for EGPRS mode is necessary, GMSK modulation should be used to minimize SAR measurement error due to higher peak-to-average power (PAR) ratios inherent in 8-PSK.

8.2 UMTS Test Configuration

1) Output Power Verification

Maximum output power is verified on the high, middle and low channels according to procedures described in section 5.2 of 3GPP TS 34.121, using the appropriate RMC or AMR with TPC (transmit power control) set to all “1”s for WCDMA/HSDPA or by applying the required inner loop power control procedures to maintain maximum output power while HSUPA is active. Results for all applicable physical channel configurations (DPCCH, DPDCHn and spreading codes, HSDPA, HSPA) are required in the SAR report. All configurations that are not supported by the Headset or cannot be measured due to technical or equipment limitations must be clearly identified.

2) WCDMA

a. Head SAR Measurements

SAR for next to the ear head exposure is measured using a 12.2 kbps RMC with TPC bits configured to all “1”s. The 3G SAR test reduction procedure is applied to AMR configurations with 12.2 kbps RMC as the primary mode. Otherwise, SAR is measured for 12.2 kbps AMR in 3.4 kbps SRB (signaling radio bearer) using the highest reported SAR configuration in 12.2 kbps RMC for head exposure.

b. Body SAR Measurements

SAR for body-worn accessory configurations is measured using a 12.2 kbps RMC with TPC bits configured to all “1”s. The 3G SAR test reduction procedure is applied to other spreading codes and multiple DPDCHn configurations supported by the Headset with 12.2 kbps RMC as the primary mode

3) HSDPA

SAR for body exposure configurations is measured according to the “Body SAR Measurements” procedures of 3G device. When the maximum output power and tune-up tolerance specified for production units in a secondary mode is $\leq \frac{1}{4}$ dB higher than the primary mode or when the highest reported SAR of the primary mode is scaled by the ratio of specified maximum output power and tune-up tolerance of secondary to primary mode and the adjusted SAR is ≤ 1.2 W/kg, SAR measurement is not required for the secondary mode. This is referred to as the 3G SAR test reduction procedure in the following SAR test guidance, where the primary mode is identified in the applicable wireless mode test procedures and the secondary mode is wireless mode being considered for SAR test reduction by that procedure. When the 3G SAR test reduction procedure is not satisfied, it is identified as “otherwise” in the applicable procedures; SAR measurement is required for the secondary mode.

Per KDB941225 D01, the 3G SAR test reduction procedure is applied to HSDPA body configurations with 12.2 kbps RMC as the primary mode. Otherwise, SAR is measured for HSDPA using the HSDPA body SAR procedures for the highest reported SAR body exposure configuration in 12.2 kbps RMC.

HSDPA should be configured according to UE category of a test device. The number of HS-DSCH/HS-PDSCHs, HARQ processes, minimum inter-TTI interval, transport block sizes and RV coding sequence are defined by the H-set. To maintain a consistent test configuration and stable transmission condition, QPSK is used in the H-set for SAR testing. HS-DPCCH should be configured with a CQI feedback cycle of 4ms with a CQI repetition factor of 2 to maintain a constant rate of active CQI slots. The β_c and β_d gain factors for DPCCH and DPDCH were set according to the values in the below table, β_{hs} for HSDPCCH is set automatically to the correct value when ΔACK , $\Delta NACK$, $\Delta CQI = 8$. The variation of the β_c / β_d ratio causes a power reduction at sub-tests 2 - 4.

Sub-test ¹	β_c ²	β_d ²	β_d (SF) ²	β_c / β_d ²	β_{hs} (1) ²	CM(dB)(2) ²	MPR (dB) ²
1 ²	2/15 ²	15/15 ²	64 ²	2/15 ²	4/15 ²	0.0 ²	0 ²
2 ²	12/15(3) ²	15/15(3) ²	64 ²	12/15(3) ²	24/15 ²	1.0 ²	0 ²
3 ²	15/15 ²	8/15 ²	64 ²	15/8 ²	30/15 ²	1.5 ²	0.5 ²
4 ²	15/15 ²	4/15 ²	64 ²	15/4 ²	30/15 ²	1.5 ²	0.5 ²

Note 1: ΔACK , $\Delta NACK$ and $\Delta CQI = 8$ $A_{hs} = \beta_{hs} / \beta_c = 30/15$ $\beta_{hs} = 30/15 * \beta_c$ ²

Note 2: CM=1 for $\beta_c / \beta_d = 12/15$, $\beta_{hs} / \beta_c = 24/15$. For all other combinations of DPDCH, DPCCH and HS-DPCCH the MPR is based on the relative CM difference. This is applicable for only UEs that support HSDPA in release 6 and later releases.²

Note 3: For subtest 2 the β_c / β_d ratio of 12/15 for the TFC during the measurement period (TF1, TF0) is achieved by setting the signalled gain factors for the reference TFC (TF1, TF1) to $\beta_c = 11/15$ and $\beta_d = 15/15$ ²

The measurements were performed with a Fixed Reference Channel (FRC) and H-Set 1 QPSK.:

Parameter	Value
Nominal average inf. bit rate	534 kbit/s
Inter-TTI Distance	3 TTI's
Number of HARQ Processes	2 Processes
Information Bit Payload	3202 Bits
MAC-d PDU size	336 Bits
Number Code Blocks	1 Block
Binary Channel Bits Per TTI	4800 Bits
Total Available SMLs in UE	19200 SMLs
Number of SMLs per HARQ Process	9600 SMLs
Coding Rate	0.67
Number of Physical Channel Codes	5

4)HSUPA

SAR for body exposure configurations is measured according to the "Body SAR Measurements" procedures of 3G device. When the maximum output power and tune-up tolerance specified for production units in a secondary mode is $\leq 1/4$ dB higher than the primary mode or when the highest reported SAR of the primary mode is scaled by the ratio of specified maximum output power and tune-up tolerance of secondary to primary mode and the adjusted SAR is ≤ 1.2 W/kg, SAR measurement is not required for the secondary mode.

Per KDB941225 D01v03, the 3G SAR test reduction procedure is applied to HSPA (HSUPA/HSDPA with RMC) body configurations with 12.2 kbps RMC as the primary mode. Otherwise, SAR is measured for HSPA using the HSPA body SAR procedures for the highest reported body exposure SAR configuration in 12.2 kbps RMC.

8.3 LTE Test Configuration

SAR for LTE band exposure configurations is measured according to the procedures of KDB 941225 D05 SAR for LTE Devices. The CMW500 WideBand Radio Communication Tester was used for LTE output power measurements and SAR testing. Closed loop power control was used so the UE transmits with maximum output power during SAR testing. SAR test were performed with the same number of RB and RB offsets transmitting on all TTI frames (Maximum TTI)

1) Spectrum Plots for RB configurations

A properly configured base station simulator was used for LTE output power measurements and SAR testing. Therefore, spectrum plots for RB configurations were not required to be included in this report.

2) MPR

When MPR is implemented permanently within the UE, regardless of network requirements, only those RB configurations allowed by 3GPP for the channel bandwidth and modulation combinations may be tested with MPR active. Configurations with RB allocations less than the RB thresholds required by 3GPP must be tested without MPR.

The allowed Maximum Power Reduction (MPR) for the maximum output power due to higher order modulation and transmit bandwidth configuration (resource blocks) is specified in Table 6.2.3-1 of the 3GPP TS36.101.

Table 6.2.3-1: Maximum Power Reduction (MPR) for Power Class 3

Modulation	Channel bandwidth / Transmission bandwidth (RB)						MPR (dB)
	1.4 MHz	3.0 MHz	5 MHz	10 MHz	15 MHz	20 MHz	
QPSK	> 5	> 4	> 8	> 12	> 16	> 18	≤ 1
16 QAM	≤ 5	≤ 4	≤ 8	≤ 12	≤ 16	≤ 18	≤ 1
16 QAM	> 5	> 4	> 8	> 12	> 16	> 18	≤ 2

3) A-MPR

A-MPR (Additional MPR) has been disabled for all SAR tests by using Network Signalling Value of "NS_01" on the base station simulator.

4) LTE procedures for SAR testing

A) Largest channel bandwidth standalone SAR test requirements

i) QPSK with 1 RB allocation

Start with the largest channel bandwidth and measure SAR for QPSK with 1 RB allocation, using the RB offset and required test channel combination with the highest maximum output power for RB offsets at the upper edge, middle and lower edge of each required test channel. When the reported SAR is ≤ 0.8 W/kg, testing of the remaining RB offset configurations and required test channels is not required for 1 RB allocation; otherwise, SAR is required for the remaining required test channels and only for the RB offset configuration with the highest output power for that channel. When the reported SAR of a required test channel is > 1.45 W/kg, SAR is required for all three RB offset configurations for that required test channel.

ii) QPSK with 50% RB allocation

The procedures required for 1 RB allocation in i) are applied to measure the SAR for QPSK with 50% RB allocation.

iii) QPSK with 100% RB allocation

For QPSK with 100% RB allocation, SAR is not required when the highest maximum output power for 100% RB allocation is less than the highest maximum output power in 50% and 1 RB allocations and the highest reported SAR for 1 RB and 50% RB allocation in i) and ii) are ≤ 0.8 W/kg. Otherwise, SAR is measured for the highest

output power channel and if the reported SAR is > 1.45 W/kg, the remaining required test channels must also be tested.

iv) Higher order modulations

For each modulation besides QPSK; e.g., 16-QAM, 64-QAM, apply the QPSK procedures in above sections to determine the QAM configurations that may need SAR measurement. For each configuration identified as required for testing, SAR is required only when the highest maximum output power for the configuration in the higher order modulation is $> \frac{1}{2}$ dB higher than the same configuration in QPSK or when the reported SAR for the QPSK configuration is > 1.45 W/kg.

B) Other channel bandwidth standalone SAR test requirements

For the other channel bandwidths used by the device in a frequency band, apply all the procedures required for the largest channel bandwidth in section A) to determine the channels and RB configurations that need SAR testing and only measure SAR when the highest maximum output power of a configuration requiring testing in the smaller channel bandwidth is $> \frac{1}{2}$ dB higher than the equivalent channel configurations in the largest channel bandwidth configuration or the reported SAR of a configuration for the largest channel bandwidth is > 1.45 W/kg.

5) TDD LTE test configuration

According to KDB 941225 D05 SAR for LTE Devices v02r04, for Time-Division Duplex (TDD) systems, SAR must be tested using a fixed periodic duty factor according to the highest transmission duty factor implemented for the device and supported by the defined 3GPP LTE TDD configurations.

8.4 Wi-Fi Test Configuration

For the 802.11b/g SAR tests, a communication link is set up with the test mode software for Wi-Fi mode test. The Absolute Radio Frequency Channel Number (ARFCN) is allocated to 1, 6 and 11 respectively in the case of 2450 MHz. During the test, at the each test frequency channel, the EUT is operated at the RF continuous emission mode. Each channel should be tested at the lowest data rate. 802.11b/g operating modes are tested independently according to the service requirements in each frequency band. 802.11b/g modes are tested on channel 1, 6, 11; however, if output power reduction is necessary for channels 1 and/or 11 to meet restricted band requirements the highest output channel closest to each of these channels must be tested instead.

SAR is not required for 802.11g/n channels when the maximum average output power is less than 0.25dB higher than that measured on the corresponding 802.11b channels.

Mode	Band	GHz	Channel	"Default Test Channels"	
				802.11b	802.11g
802.11b/g	2.4 GHz	2412	1#	√	Δ
		2437	6	√	Δ
		2462	11#	√	Δ

Notes:

√ = "default test channels"

Δ = possible 802.11g channels with maximum average output $\frac{1}{4}$ dB the "default test channels"

= when output power is reduced for channel 1 and /or 11 to meet restricted band requirements the highest output channels closest to each of these channels should be tested.

802.11 Test Channels per FCC Requirements

8.5 WiFi 2.4G SAR Test Procedures

Separate SAR procedures are applied to DSSS and OFDM configurations in the 2.4 GHz band to simplify DSSS test requirements. For 802.11b DSSS SAR measurements, DSSS SAR procedure applies to fixed exposure test position and initial test position procedure applies to multiple exposure test positions.

A) 802.11b DSSS SAR Test Requirements

SAR is measured for 2.4 GHz 802.11b DSSS using either a fixed test position or, when applicable, the initial test position procedure. SAR test reduction is determined according to the following:

- 1) When the reported SAR of the highest measured maximum output power channel (section 3.1 of of KDB 248227D01v02) for the exposure configuration is ≤ 0.8 W/kg, no further SAR testing is required for 802.11b DSSS in that exposure configuration.
- 2) When the reported SAR is > 0.8 W/kg, SAR is required for that exposure configuration using the next highest measured output power channel. When any reported SAR is > 1.2 W/kg, SAR is required for the third channel; i.e., all channels require testing.

B) 2.4GHz 802.11g/n OFDM SAR Test Exclusion Requirements

When SAR measurement is required for 2.4 GHz 802.11g/n OFDM configurations, the measurement and test reduction procedures for OFDM are applied (section 5.3 of of KDB 248227D01v02r01). SAR is not required for the following 2.4 GHz OFDM conditions.

- 1) When KDB Publication 447498 SAR test exclusion applies to the OFDM configuration.
- 2) When the highest reported SAR for DSSS is adjusted by the ratio of OFDM to DSSS specified maximum output power and the adjusted SAR is ≤ 1.2 W/kg.

C) SAR Test Requirements for OFDM configurations

When SAR measurement is required for 802.11 g/n OFDM configurations, each standalone and frequency aggregated band is considered separately for SAR test reduction. In applying the initial test configuration and subsequent test configuration procedures, the 802.11 transmission configuration with the highest specified maximum output power and the channel within a test configuration with the highest measured maximum output power should be clearly distinguished to apply the procedures.

8.6 WiFi 5G SAR Test Procedures**A) U-NII-1 and U-NII-2A Bands**

For devices that operate in only one of the U-NII-1 and U-NII-2A bands, the normally required SAR procedures for OFDM configurations are applied. For devices that operate in both U-NII bands using the same transmitter and antenna(s), SAR test reduction is determined according to the following:

- 1) When the same maximum output power is specified for both bands, begin SAR measurement in U- NII-2A band by applying the OFDM SAR requirements. If the highest reported SAR for a test configuration is ≤ 1.2 W/kg, SAR is not required for U-NII-1 band for that configuration (802.11 mode and exposure condition); otherwise, both bands are tested independently for SAR.
- 2) When different maximum output power is specified for the bands, begin SAR measurement in the band with higher specified maximum output power. The highest reported SAR for the tested configuration is adjusted by the ratio of lower to higher specified maximum output power for the two bands. When the adjusted SAR is ≤ 1.2 W/kg, SAR is not required for the band with lower maximum output power in that test configuration; otherwise, both bands are tested independently for SAR.
- 3) The two U-NII bands may be aggregated to support a 160 MHz channel on channel number 50.

Without additional testing, the maximum output power for this is limited to the lower of the maximum output power certified for the two bands. When SAR measurement is required for at least one of the bands and the highest reported SAR adjusted by the ratio of specified maximum output power of aggregated to standalone band is > 1.2 W/kg, SAR is required for the 160 MHz channel. This procedure does not apply to an aggregated band with maximum output higher than the standalone band(s); the aggregated band must be tested independently for SAR. SAR is not required when the 160 MHz channel is operating at a reduced maximum power and also qualifies for SAR test exclusion.

B) U-NII-2C and U-NII-3 Bands

The frequency range covered by these bands is 380 MHz (5.47 – 5.85 GHz), which requires a minimum of at least two SAR probe calibration frequency points to support SAR measurements. when Terminal Doppler Weather Radar (TDWR) restriction applies, all channels that operate at 5.60 – 5.65 GHz must be included to apply the SAR test reduction and measurement procedures.

When the same transmitter and antenna(s) are used for U-NII-2C band and U-NII-3 band or 5.8 GHz band of §15.247, the bands may be aggregated to enable additional channels with 20, 40 or 80 MHz bandwidth to span across the band gap, as illustrated in Appendix B. The maximum output power for the additional band gap

channels is limited to the lower of those certified for the bands. Unless band gap channels are permanently disabled, they must be considered for SAR testing. The frequency range covered by these bands is 380 MHz (5.47 – 5.85 GHz), which requires a minimum of at least two SAR probe calibration frequency points to support SAR measurements. To maintain SAR measurement accuracy and to facilitate test reduction, the channels in U-NII-2C band above 5.65 GHz may be grouped with the 5.8 GHz channels in U-NII-3 or §15.247 band to enable two SAR probe calibration frequency points to cover the bands, including the band gap channels. When band gap channels are supported and the bands are not aggregated for SAR testing, band gap channels must be considered independently in each band according to the normally required OFDM SAR measurement and probe calibration frequency points requirements.

C) OFDM Transmission Mode SAR Test Configuration and Channel Selection Requirements

The initial test configuration for 5 GHz OFDM transmission modes is determined by the 802.11 configuration with the highest maximum output power specified for production units, including tune-up tolerance, in each standalone and aggregated frequency band. SAR for the initial test configuration is measured using the highest maximum output power channel determined by the default power measurement procedures. When multiple configurations in a frequency band have the same specified maximum output power, the initial test configuration is determined according to the following steps applied sequentially.

- 1) The largest channel bandwidth configuration is selected among the multiple configurations with the same specified maximum output power.
- 2) If multiple configurations have the same specified maximum output power and largest channel bandwidth, the lowest order modulation among the largest channel bandwidth configurations is selected.
- 3) If multiple configurations have the same specified maximum output power, largest channel bandwidth and lowest order modulation, the lowest data rate configuration among these configurations is selected.
- 4) When multiple transmission modes (802.11 a/g/n/ac) have the same specified maximum output power, largest channel bandwidth, lowest order modulation and lowest data rate, the lowest order 802.11 mode is selected; i.e., 802.11a is chosen over 802.11n then 802.11ac or 802.11g is chosen over 802.11n. After an initial test configuration is determined, if multiple test channels have the same measured maximum output power, the channel chosen for SAR measurement is determined according to the following. These channel selection procedures apply to both the initial test configuration and subsequent test configuration(s), with respect to the default power measurement procedures or additional power measurements required for further SAR test reduction. The same procedures also apply to subsequent highest output power channel(s) selection.
 - 1) The channel closest to mid-band frequency is selected for SAR measurement.
 - 2) For channels with equal separation from mid-band frequency; for example, high and low channels or two mid-band channels, the higher frequency (number) channel is selected for SAR measurement.

D) SAR Test Requirements for OFDM configurations

When SAR measurement is required for 802.11 a/n/ac OFDM configurations, each standalone and frequency aggregated band is considered separately for SAR test reduction. When the same transmitter and antenna(s) are used for U-NII-1 and U-NII-2A bands, additional SAR test reduction applies. When band gap channels between U-NII-2C band and 5.8 GHz U-NII-3 or §15.247 band are supported, the highest maximum output power transmission mode configuration and maximum output power channel across the bands must be used to determine SAR test reduction, according to the initial test configuration and subsequent test configuration requirements. In applying the initial test configuration and subsequent test configuration procedures, the 802.11 transmission configuration with the highest specified maximum output power and the channel within a test configuration with the highest measured maximum output power should be clearly distinguished to apply the procedures.

9 Detailed Test Results

9.1 Conducted Power measurements

The maximum conducted average power (Unit: dBm) including tune-up tolerance is shown as below.

9.1.1 Conducted Power of GSM850

GSM850(SIM1)		Burst-Averaged output Power (dBm)			Division Factors	Source Based time Average Power(dBm)		
		128CH	190CH	251CH		128CH	190CH	251CH
GSM(CS)		32.95	32.86	32.89	-9.03	23.92	23.83	23.86
GPRS (GMSK)	1 Tx Slot	32.26	32.23	32.28	-9.03	23.23	23.20	23.25
	2 Tx Slots	31.58	31.56	31.57	-6.02	25.56	25.54	25.55
	3 Tx Slots	30.26	30.38	30.35	-4.26	26.00	26.12	26.09
	4 Tx Slots	29.88	29.79	29.86	-3.01	26.87	26.78	26.85
EGPRS (8-PSK)	1 Tx Slot	28.63	28.61	28.63	-9.03	19.60	19.58	19.60
	2 Tx Slots	27.82	27.83	27.80	-6.02	21.80	21.81	21.78
	3 Tx Slots	27.08	27.00	27.05	-4.26	22.82	22.74	22.79
	4 Tx Slots	26.66	26.55	26.57	-3.01	23.65	23.54	23.56

GSM850(SIM2)		Burst-Averaged output Power (dBm)			Division Factors	Source Based time Average Power(dBm)		
		128CH	190CH	251CH		128CH	190CH	251CH
GSM(CS)		32.86	32.83	32.88	-9.03	23.83	23.80	23.85
GPRS (GMSK)	1 Tx Slot	32.23	32.22	32.24	-9.03	23.20	23.19	23.21
	2 Tx Slots	31.36	31.30	31.33	-6.02	25.34	25.28	25.31
	3 Tx Slots	30.29	30.32	30.31	-4.26	26.03	26.06	26.05
	4 Tx Slots	29.78	29.68	29.65	-3.01	26.77	26.67	26.64
EGPRS (8-PSK)	1 Tx Slot	28.33	28.35	28.28	-9.03	19.30	19.32	19.25
	2 Tx Slots	27.58	27.56	27.66	-6.02	21.56	21.54	21.64
	3 Tx Slots	26.98	26.95	26.91	-4.26	22.72	22.69	22.65
	4 Tx Slots	26.37	26.31	26.33	-3.01	23.36	23.30	23.32

Note: 1) The conducted power of GSM850 is measured with RMS detector.

2) Frame-averaged output power was calculated from the measured burst-averaged output power by converting the slot powers into linear units and calculating the energy over 8 timeslots.

3)The bolded GPRS 4Tx slots mode was selected for SAR testing according the highest Source Based time Average Power table.

4) channel /Frequency: 128/824.2; 190/836.6; 251/848.8

9.1.2 Conducted Power of GSM1900

GSM1900(SIM1)		Burst-Averaged output Power (dBm)			Division Factors	Source Based time Average Power(dBm)		
		512CH	661CH	810CH		512CH	661CH	810CH
GSM(CS)		30.18	30.23	30.19	-9.03	21.15	21.20	21.16
GPRS (GMSK)	1 Tx Slot	29.68	29.66	29.62	-9.03	20.65	20.63	20.59
	2 Tx Slots	28.83	28.90	28.85	-6.02	22.81	22.88	22.83
	3 Tx Slots	27.22	27.31	27.33	-4.26	22.96	23.05	23.07
	4 Tx Slots	26.83	26.86	26.80	-3.01	23.82	23.85	23.79
EGPRS (8-PSK)	1 Tx Slot	27.36	27.33	27.45	-9.03	18.33	18.30	18.42
	2 Tx Slots	26.72	26.73	26.82	-6.02	20.70	20.71	20.80
	3 Tx Slots	25.93	25.95	25.91	-4.26	21.67	21.69	21.65
	4 Tx Slots	25.33	25.38	25.35	-3.01	22.32	22.37	22.34

GSM1900(SIM2)		Burst-Averaged output Power (dBm)			Division Factors	Source Based time Average Power(dBm)		
		512CH	661CH	810CH		512CH	661CH	810CH
GSM(CS)		29.93	29.92	29.96	-9.03	20.90	20.89	20.93
GPRS (GMSK)	1 Tx Slot	29.35	29.35	29.36	-9.03	20.32	20.32	20.33
	2 Tx Slots	27.95	28.63	28.67	-6.02	21.93	22.61	22.65
	3 Tx Slots	27.23	27.28	27.22	-4.26	22.97	23.02	22.96
	4 Tx Slots	26.70	26.73	26.65	-3.01	23.69	23.72	23.64
EGPRS (8-PSK)	1 Tx Slot	27.25	27.28	27.26	-9.03	18.22	18.25	18.23
	2 Tx Slots	26.55	26.58	26.57	-6.02	20.53	20.56	20.55
	3 Tx Slots	25.82	25.83	25.81	-4.26	21.56	21.57	21.55
	4 Tx Slots	25.25	25.29	25.26	-3.01	22.24	22.28	22.25

Note: 1) The conducted power of GSM1900 is measured with RMS detector.

2) Frame-averaged output power was calculated from the measured burst-averaged output power by converting the slot powers into linear units and calculating the energy over 8 timeslots.

3)The bolded GPRS 4Tx slots mode was selected for SAR testing according the highest Source Based time Average Power table.

4) channel /Frequency: 512/1850.2; 661/1880; 810/1909.8

9.1.3 Conducted Power of UMTS Band II

UMTS Band II		Conducted Power (dBm)		
		9262CH	9400CH	9538CH
WCDMA	12.2kbps RMC	21.60	21.66	21.76
HSDPA	Subtest 1	21.20	21.42	21.31
	Subtest 2	21.15	20.58	20.64
	Subtest 3	21.10	20.52	20.58
	Subtest 4	21.02	20.62	20.56
HSUPA	Subtest 1	21.32	20.75	20.82
	Subtest 2	21.12	20.55	20.70
	Subtest 3	21.15	20.73	20.80
	Subtest 4	20.62	20.65	20.71
	Subtest 5	20.95	20.85	20.81

Note: 1) channel /Frequency: 9262/1852.4, 9400/1880, 9538/1907.6

9.1.4 Conducted Power of UMTS Band IV

UMTS Band IV		Conducted Power (dBm)		
		1312CH	1413CH	1513CH
WCDMA	12.2kbps RMC	22.06	22.18	22.12
HSDPA	Subtest 1	21.51	21.53	21.55
	Subtest 2	21.82	21.74	21.42
	Subtest 3	21.72	21.51	21.45
	Subtest 4	21.61	21.78	21.58
HSUPA	Subtest 1	21.56	21.38	21.33
	Subtest 2	21.58	21.65	21.42
	Subtest 3	21.42	21.45	21.33
	Subtest 4	21.35	21.49	21.32
	Subtest 5	21.37	21.43	21.38

Note: 1) channel /Frequency: 1312/1712.4, 1413/1732.5, 1513/1752.6

9.1.5 Conducted Power of UMTS Band V

UMTS Band V		Conducted Power (dBm)		
		4132CH	4182CH	4233CH
WCDMA	12.2kbps RMC	22.49	22.43	22.45
HSDPA	Subtest 1	22.23	22.25	22.17
	Subtest 2	21.72	21.71	21.72
	Subtest 3	21.33	21.32	21.43
	Subtest 4	21.55	21.55	21.62
HSUPA	Subtest 1	21.62	21.56	21.66
	Subtest 2	21.52	21.82	21.52
	Subtest 3	21.33	21.33	21.22
	Subtest 4	21.53	21.27	21.33
	Subtest 5	21.28	21.26	21.28

Note: 1) channel /Frequency: 4132/826.4, 4182/836.4, 4233/846.6

9.1.6 Conducted Power of LTE Band II

Conducted Power of LTE Band II						
Bandwidth	Modulation	RB size	RB offset	Channel	Channel	Channel
				18607	18900	19193
1.4MHz	QPSK	1	0	21.26	21.47	21.03
			3	20.96	20.74	21.41
			5	21.25	21.03	20.79
		3	0	21.29	20.77	21.11
			2	21.00	21.23	21.46
			3	21.24	21.25	21.31
	6	0	20.79	20.65	20.96	
	16QAM	1	0	21.17	21.27	20.76
			3	20.68	20.79	21.12
			5	21.02	21.47	21.08
		3	0	20.68	20.76	21.34
			2	21.05	20.66	21.28
			3	21.41	20.75	21.12
	6	0	20.87	20.64	20.56	
Bandwidth	Modulation	RB size	RB offset	Channel	Channel	Channel
				18615	18900	19185
3MHz	QPSK	1	0	20.80	21.02	20.70
			7	21.20	20.91	20.87
			14	20.53	21.12	21.01
		8	0	20.69	20.51	21.00
			4	20.53	20.87	20.63
			7	21.02	20.96	21.46
	15	0	20.53	21.18	21.24	
	16QAM	1	0	20.64	21.37	20.97
			7	21.14	20.64	20.86
			14	20.77	21.42	20.56
		8	0	20.73	20.93	21.34
			4	20.96	21.32	20.82
			7	20.99	21.32	21.30
		15	0	21.21	20.51	21.34

Conducted Power of LTE Band II						
Bandwidth	Modulation	RB size	RB offset	Channel	Channel	Channel
				18625	18900	19175
5MHz	QPSK	1	0	21.13	21.45	20.51
			13	21.08	20.73	20.90
			24	20.72	20.95	20.57
		12	0	21.37	20.61	21.30
			6	20.76	20.61	20.68
			13	20.67	21.12	21.44
	25	0	21.18	20.76	20.80	
	16QAM	1	0	20.61	21.19	20.65
			13	21.36	20.63	21.01
			24	21.47	20.84	21.36
		12	0	21.23	21.32	20.80
			6	20.75	21.01	20.49
			13	21.27	21.27	20.80
		25	0	21.06	21.33	20.68
Bandwidth		Modulation	RB size	RB offset	Channel	Channel
	18650				18900	19150
10MHz	QPSK	1	0	21.14	21.28	20.90
			25	21.13	21.35	21.32
			49	21.37	21.05	21.35
		25	0	21.16	20.88	21.12
			13	21.21	20.86	20.51
			25	21.15	21.39	21.19
	50	0	21.33	20.68	20.70	
	16QAM	1	0	21.26	20.84	20.86
			25	21.29	20.52	20.77
			49	20.59	20.74	21.13
		25	0	21.23	21.33	21.20
			13	20.95	20.60	20.84
			25	20.86	20.94	21.21
		50	0	20.61	20.52	20.99

Conducted Power of LTE Band II							
Bandwidth	Modulation	RB size	RB offset	Channel	Channel	Channel	
				18675	18900	19125	
15MHz	QPSK	1	0	21.02	21.36	20.74	
			38	20.71	20.67	20.83	
			74	21.02	20.74	21.27	
		36	0	20.71	20.51	21.21	
			18	21.42	20.51	21.12	
			39	21.06	21.31	20.64	
		75	0	21.10	20.86	21.43	
		16QAM	1	0	20.69	20.79	21.26
				38	20.80	21.23	21.10
	74			20.72	20.99	20.82	
	36		0	20.88	20.51	20.49	
			18	21.03	20.69	20.73	
	75	0	20.65	20.62	20.98		

Conducted Power of LTE Band II

Bandwidth	Modulation	RB size	RB offset	Channel	Channel	Channel	
				18700	18900	19100	
20MHz	QPSK	1	0	20.72	20.55	21.40	
			50	20.66	21.43	20.55	
			99	21.29	21.16	21.45	
		50	0	21.26	20.52	20.74	
			25	21.41	20.73	21.46	
			50	20.73	20.99	21.44	
		100	0	21.20	21.06	20.63	
		16QAM	1	0	21.20	21.39	20.96
				50	21.02	21.29	21.17
	99			21.23	20.86	20.69	
	50		0	21.14	20.57	20.96	
			25	21.33	21.26	20.59	
	100	0	21.47	20.66	20.56		

9.1.7 Conducted Power of LTE Band IV

Conducted Power of LTE Band IV							
Bandwidth	Modulation	RB size	RB offset	Channel	Channel	Channel	
				19957	20175	20393	
1.4MHz	QPSK	1	0	21.33	21.15	20.76	
			3	20.88	21.37	21.24	
			5	20.81	20.56	20.93	
		3	0	21.03	20.52	20.56	
			2	20.50	21.29	20.46	
			3	21.14	20.93	20.82	
		6	0	20.72	21.06	20.93	
		16QAM	1	0	21.36	21.24	20.88
				3	20.96	21.10	20.67
	5			21.08	20.96	21.41	
	3		0	20.58	20.88	21.03	
			2	20.74	20.54	20.94	
	3		3	21.26	21.39	20.95	
	6	0	20.46	21.25	21.07		
	Bandwidth	Modulation	RB size	RB offset	Channel	Channel	Channel
19965					20175	20385	
3MHz	QPSK	1	0	20.47	21.27	20.67	
			7	20.64	20.50	20.73	
			14	21.21	20.65	20.99	
		8	0	20.90	21.06	21.35	
			4	21.29	21.02	21.28	
			7	20.63	21.07	21.08	
		15	0	20.75	20.81	20.80	
		16QAM	1	0	20.85	21.27	20.54
				7	21.18	20.91	20.97
	14			20.54	20.68	20.92	
	8		0	20.96	20.96	21.23	
			4	21.15	21.06	21.45	
			7	21.43	21.00	21.02	
	15		0	20.79	21.33	20.63	

Conducted Power of LTE Band IV								
Bandwidth	Modulation	RB size	RB offset	Channel	Channel	Channel		
				19975	20175	20375		
5MHz	QPSK	1	0	21.18	20.69	20.55		
			13	21.32	20.87	20.51		
			24	20.82	20.75	21.05		
		12	0	21.00	20.60	20.75		
			6	21.41	21.03	20.66		
			13	20.69	20.54	21.10		
	25	0	21.24	20.87	20.56			
	16QAM	1	1	0	20.72	20.50	20.59	
				13	20.67	21.19	20.67	
				24	20.53	20.77	21.16	
		12	12	0	20.84	21.31	20.57	
				6	20.97	20.56	21.02	
13				20.97	21.18	20.93		
25		0	21.27	21.23	21.16			
Bandwidth		Modulation	RB size	RB offset	Channel	Channel	Channel	
					20000	20175	20350	
10MHz	QPSK	1	0	20.90	21.06	21.34		
			25	21.11	20.58	21.29		
			49	21.23	20.72	20.66		
		25	25	0	21.34	21.03	20.80	
				13	21.33	21.30	21.09	
				25	21.09	20.47	21.42	
		50	0	20.71	20.71	21.24		
		16QAM	1	1	0	20.62	20.82	20.87
					25	20.76	20.97	20.88
	49				21.34	21.42	21.07	
	25		25	0	20.90	20.64	21.05	
				13	20.79	20.72	20.66	
				25	21.17	20.72	20.82	
	50		0	20.53	21.37	20.55		

Conducted Power of LTE Band IV						
Bandwidth	Modulation	RB size	RB offset	Channel	Channel	Channel
				20025	20175	20325
15MHz	QPSK	1	0	20.80	21.06	20.64
			38	20.68	20.85	20.54
			74	20.73	20.48	20.77
		36	0	20.98	20.85	21.31
			18	20.86	21.15	20.94
			39	20.50	21.40	20.95
	75	0	21.29	20.76	20.89	
	16QAM	1	0	20.71	20.81	21.11
			38	20.67	21.04	20.77
			74	20.86	20.86	21.26
		36	0	20.95	21.14	20.69
			18	20.70	21.11	21.28
			39	20.84	20.83	20.53
		75	0	20.86	21.12	20.89

Conducted Power of LTE Band IV						
Bandwidth	Modulation	RB size	RB offset	Channel	Channel	Channel
				20050	20175	20300
20MHz	QPSK	1	0	20.63	20.82	20.91
			50	20.79	20.85	21.35
			99	20.53	20.95	21.42
		50	0	20.61	20.63	20.69
			25	21.31	21.13	21.34
			50	20.89	20.77	21.31
	100	0	21.04	20.63	20.84	
	16QAM	1	0	20.63	21.41	20.53
			50	21.23	20.96	21.39
			99	20.90	21.27	21.37
		50	0	20.53	20.67	21.17
			25	21.22	20.78	20.70
			50	21.03	20.67	20.75
		100	0	21.35	20.81	21.28

9.1.8 Conducted Power of LTE Band VII

Conducted Power of LTE Band VII							
Bandwidth	Modulation	RB size	RB offset	Channel	Channel	Channel	
				20775	21100	21425	
5MHz	QPSK	1	0	20.97	21.43	20.84	
			13	21.28	20.54	20.52	
			24	20.91	21.39	20.95	
		12	0	21.26	20.66	21.13	
			6	21.11	21.43	21.02	
			13	20.92	21.31	21.11	
	25	0	20.98	21.44	20.88		
	16QAM	1	0	21.32	20.53	20.86	
			13	20.62	21.40	21.08	
			24	20.78	20.62	20.55	
		12	0	21.06	21.26	20.87	
			6	20.89	20.76	21.03	
			13	20.95	21.03	20.98	
		25	0	20.78	21.28	20.48	
Bandwidth		Modulation	RB size	RB offset	Channel	Channel	21.43
					20800	21100	21400
10MHz	QPSK	1	0	20.61	20.90	20.71	
			25	21.28	20.74	21.31	
			49	20.95	21.21	21.00	
		25	0	21.27	20.87	20.90	
			13	20.94	20.52	20.87	
			25	21.08	21.30	20.97	
		50	0	21.30	20.59	20.69	
		16QAM	1	0	21.17	21.14	20.79
				25	21.01	21.32	20.92
	49			20.96	20.67	20.74	
	25		0	20.60	20.51	20.53	
			13	20.58	21.33	20.56	
			25	21.41	20.54	21.33	
	50		0	20.68	21.29	20.90	

Conducted Power of LTE Band VII						
Bandwidth	Modulation	RB size	RB offset	Channel	Channel	Channel
				20825	21100	21375
15MHz	QPSK	1	0	21.31	20.87	21.22
			38	21.00	20.93	20.84
			74	21.07	20.86	20.55
		36	0	21.27	20.75	20.53
			18	20.96	20.83	21.06
			39	20.88	21.20	20.85
	75	0	21.32	21.43	20.93	
	16QAM	1	0	20.54	20.79	20.95
			38	21.03	21.32	21.23
			74	21.37	20.66	20.90
		36	0	21.30	20.74	21.39
			18	20.59	20.79	21.19
			39	20.93	21.12	21.35
		75	0	21.44	20.87	21.30

Conducted Power of LTE Band VII						
Bandwidth	Modulation	RB size	RB offset	Channel	Channel	Channel
				20850	21100	21350
20MHz	QPSK	1	0	21.26	20.96	21.26
			50	21.03	20.94	21.22
			99	21.12	21.28	20.93
		50	0	20.48	20.46	20.81
			25	20.59	21.15	20.86
			50	20.99	20.70	21.10
	100	0	20.94	20.75	20.92	
	16QAM	1	0	21.34	21.00	21.40
			50	20.83	20.45	20.67
			99	20.88	20.60	20.44
		50	0	20.79	21.33	20.52
			25	20.47	20.98	20.82
			50	21.22	20.43	20.94
		100	0	21.06	21.42	20.80

9.1.9 Conducted Power of Wi-Fi 2.4G

Mode	802.11b		
Channel / Frequency (MHz)	1(2412)	6(2437)	11(2462)
Average Power(dBm)	14.52	14.58	14.46
Mode	802.11g		
Channel / Frequency (MHz)	1(2412)	6(2437)	11(2462)
Average Power(dBm)	13.54	13.64	14.42
Mode	802.11n(HT20)		
Channel / Frequency (MHz)	1(2412)	6(2437)	11(2462)
Average Power(dBm)	13.63	13.42	13.42
Mode	802.11n(HT40)		
Channel / Frequency (MHz)	1(2412)	6(2437)	11(2462)
Average Power(dBm)	12.38	12.45	12.34

9.1.10 Conducted Power of Wi-Fi 5G

Band	Mode	Channel	Frequency (MHz)	Data Rate (Mbps)	Power Setting	Tune-up	Average Power (dBm)	SAR Test (Yes/No)
5.2G	802.11a	36	5180	6	15.00	15.00±1.0	15.32	No
		40	5200		15.00	15.00±1.0	15.34	No
		44	5220		15.00	15.00±1.0	15.44	No
		48	5240		15.00	15.00±1.0	15.62	Yes
	802.11n HT20	36	5180	6.5	14.00	14.00±1.0	14.41	No
		40	5200		14.00	14.00±1.0	14.31	No
		44	5220		14.00	14.00±1.0	14.61	No
		48	5240		14.00	14.00±1.0	14.53	No
	802.11n HT40	38	5190	13.5	12.50	12.50±1.0	13.32	No
		46	5230		12.50	12.50±1.0	13.28	No
	802.11ac 20M	36	5180	6.5M	11.50	11.50±1.0	12.22	No
		40	5200		11.50	11.50±1.0	12.10	No
		44	5220		11.50	11.50±1.0	12.19	No
		48	5240		11.50	11.50±1.0	12.31	No
	802.11ac 40M	38	5190	13.5M	11.50	11.50±1.0	12.33	No
		46	5230		11.50	11.50±1.0	12.35	No
802.11ac	42	5210	29.3M	/	/	/	No	

Band	Mode	Channel	Frequency (MHz)	Data Rate (Mbps)	Power Setting	Tune-up	Average Power (dBm)	SAR Test (Yes/No)	
5.3G	802.11a	52	5260	6	/	/	/	No	
		56	5280		/	/	/	No	
		60	5300		/	/	/	No	
		64	5320		/	/	/	No	
	802.11n HT20	52	5260	6.5	/	/	/	No	
		56	5280		/	/	/	No	
		60	5300		/	/	/	No	
		64	5320		/	/	/	No	
	802.11n HT40	54	5270	13.5	/	/	/	No	
		62	5310		/	/	/	No	
		138	5690		/	/	/	No	
	802.11ac 20M	52	5260	6.5M	/	/	/	No	
		56	5280		/	/	/	No	
		60	5300		/	/	/	No	
		64	5320		/	/	/	No	
	802.11ac 40M	54	5270	13.5M	/	/	/	No	
		62	5310		/	/	/	No	
	802.11ac 80M	58	5290	29.3M	/	/	/	No	
	Band	Mode	Channel	Frequency (MHz)	Data Rate (Mbps)	Power Setting	Tune-up	Average Power (dBm)	SAR Test (Yes/No)
	5.8G	802.11a	149	5745	6	14.50	14.50±1.0	15.24	No
153			5765	14.50		14.50±1.0	15.20	No	
157			5785	14.50		14.50±1.0	15.21	No	
161			5805	14.50		14.50±1.0	15.28	No	
165			5825	14.50		14.50±1.0	15.39	Yes	
802.11n HT20		149	5745	6.5	13.50	13.50±1.0	14.38	No	
		153	5765		13.50	13.50±1.0	14.30	No	
		157	5785		13.50	13.50±1.0	14.33	No	
		161	5805		13.50	13.50±1.0	14.25	No	
		165	5825		13.50	13.50±1.0	14.34	No	
802.11n HT40		151	5755	13.5	13.00	13.00±1.0	13.64	No	
		159	5795		13.00	13.00±1.0	13.81	No	

	802.11ac 20M	149	5745	6.5M	12.00	12.00±1.0	12.74	No
		153	5765		12.00	12.00±1.0	12.55	No
		157	5785	6.5M	12.00	12.00±1.0	12.59	No
		161	5805		12.00	12.00±1.0	12.50	No
		165	5825		12.00	12.00±1.0	12.64	No
	802.11ac 40M	151	5755	13.5M	12.00	12.00±1.0	12.42	No
		159	5795		12.00	12.00±1.0	12.67	No
	802.11ac 80M	155	5775	29.3M	/	/	/	No

9.1.11 Conducted Power of BT

The maximum output power of BT is:

Mode	1Mbps		
Channel / Frequency (MHz)	0(2402)	39(2441)	78(2480)
Average Power(dBm)	5.44	4.73	3.89
Mode	2Mbps		
Channel / Frequency (MHz)	0(2402)	39(2441)	78(2480)
Average Power(dBm)	4.15	3.68	2.86
Mode	3Mbps		
Channel / Frequency (MHz)	0(2402)	39(2441)	78(2480)
Average Power(dBm)	3.85	4.42	3.89

9.1.12 Tune-up power tolerance

Band	Tune-up power tolerance(dBm)		
GSM850	GSM/GPRS (GMSK)	GSM	Max output power =32.5dBm±0.5dBm
		1TXslots	Max output power =32.0dBm±0.5dBm
		2TXslots	Max output power =31.5dBm±0.5dBm
		3TXslots	Max output power =30.0dBm±0.5dBm
		4TXslots	Max output power =29.5dBm±0.5dBm
GSM850	EGPRS (8-PSK)	1TXslots	Max output power =28.5dBm±0.5dBm
		2TXslots	Max output power =27.5dBm±0.5dBm
		3TXslots	Max output power =27.0dBm±0.5dBm
		4TXslots	Max output power =26.5dBm±0.5dBm
GSM1900	GSM/GPRS (GMSK)	GSM	Max output power =30.0dBm±0.5dBm
		1TXslots	Max output power =29.5dBm±0.5dBm
		2TXslots	Max output power =28.5dBm±0.5dBm
		3TXslots	Max output power =27.0dBm±0.5dBm
		4TXslots	Max output power =26.5dBm±0.5dBm
GSM1900	EGPRS (8-PSK)	1TXslots	Max output power =27.0dBm±0.5dBm
		2TXslots	Max output power =26.5dBm±0.5dBm
		3TXslots	Max output power =25.5dBm±0.5dBm
		4TXslots	Max output power =25.0dBm±0.5dBm
WCDMA 2	Max output power =21.0dbm±1.0dbm		
WCDMA 4	Max output power =21.5dbm±1.0dbm		
WCDMA 5	Max output power =21.5dbm±1.0dbm		
LTE B2	Max output power =20.5dbm±1.0dbm		
LTE B4	Max output power =20.5dbm±1.0dbm		
LTE B7	Max output power =20.5dbm±1.0dbm		
2.4G Wi-Fi	802.11b		Max output power =14.0±1dbm
	802.11g		Max output power =13.0±1dbm
	802.11n (HT20)		Max output power =13.0 ±1dbm
	802.11n (HT40)		Max output power =11.5±1dbm
5G Wi-Fi	Band1	802.11a	Max output power =15.0dbm±1.0dBm
		802.11n(HT20)	Max output power =14.0dbm±1.0dBm
		802.11n(HT40)	Max output power =12.5dbm±1.0dBm
		802.11ac20M	Max output power =11.5dbm±1.0dBm
		802.11ac40M	Max output power =11.5dbm±1.0dBm
	Band4	802.11a	Max output power =14.5dbm±1.0dBm
		802.11n(HT20)	Max output power =13.5dbm±1.0dBm
		802.11n(HT40)	Max output power =13.0dbm±1.0dBm
		802.11ac20M	Max output power =12.0 dbm±1.0dBm
		802.11ac40M	Max output power =12.0dbm±1.0dBm
BT	1Mbps Power		Max output power =4.5dBm±1dbm
	2Mbps Power		Max output power =3.5dBm±1dbm
	3Mbps Power		Max output power =4.0dBm±1dbm

9.2 SAR test results

Notes:

1) Per KDB447498 D01v05 r02, the SAR test shall be performed at the high, middle and low frequency channels of each operating mode. If the scaled SAR measured at mid-band channel for each test configuration is at least 3.0 dB lower than the SAR limit (< 0.8 W/kg), testing at the high and low channels is optional.

2) Per KDB447498 D01v05r02, testing of other required channels within the operating mode of a frequency band is not required when the reported 1-g or 10-g SAR for the mid-band or highest output power channel is: ≤ 0.8 W/kg or 2.0 W/kg, for 1-g or 10-g respectively, when the transmission band is ≤ 100 MHz. When the maximum output power variation across the required test channels is $> \frac{1}{2}$ dB, instead of the middle channel, the highest output power channel must be used.

3) Per KDB447498 D01v05r02, All measurement SAR result is scaled-up to account for tune-up tolerance is compliant.

4) Per KDB648474 D04v01r02, body-worn accessory testing is typically associated with voice operations. Therefore, GSM voice was evaluated for body-worn with headset SAR.

5) Per KDB248227 D01v01r02, the procedures required to establish specific device operating configurations for testing the SAR of 802.11 a/b/g transmitters.

(1) For Headsets operating next to ear, hotspot mode or mini-tablet configurations, the initial test position procedures were applied. The test position with the highest extrapolated peak SAR will be used as the initial test position. When the reported SAR of initial test position is ≤ 0.4 W/kg, SAR testing for remaining test positions is not required. Otherwise, SAR is evaluated at the subsequent highest peak SAR positions until the reported SAR result is ≤ 0.8 W/kg or all test positions are measured.

(2) For WLAN 2.4 GHz, the highest measured maximum output power channel for DSSS was selected for SAR measurement. When the reported SAR is ≤ 0.8 W/kg, no further SAR testing is required. Otherwise, SAR is evaluated at the next highest measured output power channel. When any reported SAR is > 1.2 W/kg, SAR is required for the third channel. For OFDM modes (802.11g/n), SAR is not required when the highest reported SAR for DSSS is adjusted by the ratio of OFDM to DSSS specified maximum output power and it is ≤ 1.2 W/kg.

(3) For WLAN 5 GHz, the initial test configuration was selected according to the transmission mode with the highest maximum output power. When the reported SAR of initial test configuration is > 0.8 W/kg, SAR is required for the subsequent highest measured output power channel until the reported SAR result is ≤ 1.2 W/kg or all required channels are measured. For other transmission modes, SAR

is not required when the highest reported SAR for initial test configuration is adjusted by the ratio of subsequent test configuration to initial test configuration specified maximum output power and it is ≤ 1.2 W/kg.

6) Per KDB865664 D01v01r04, for each frequency band, repeated SAR measurement is required only when the measured SAR is ≥ 0.8 W/Kg; if the deviation among the repeated measurement is $\leq 20\%$, and the measured SAR < 1.45 W/Kg, only one repeated measurement is required.

7) Per KDB865664 D02v01r01, SAR plot is only required for the highest measured SAR in each exposure configuration, wireless mode and frequency band combination; Plots are also required when the measured SAR is > 1.5 W/kg, or > 7.0 W/kg for occupational exposure. The published RF exposure KDB procedures may require additional plots; for example, to support SAR to peak location separation ratio test exclusion and/or volume scan post-processing (Refer to appendix B for details).

8) Per KDB941225 D06v01r01, the DUT Dimension is bigger than 9 cm x 5 cm, so 10mm is chosen as the test separation distance for Hotspot mode. When the antenna-to-edge distance is greater than 2.5cm, such position does not need to be tested.

9) Per KDB 941225 D01, 3G SAR Measurement Procedures, The mode tested for SAR is referred to as the primary mode. The equivalent modes considered for SAR test reduction are denoted as secondary modes. Both primary and secondary modes must be in the same frequency band. When the maximum output power and tune-up tolerance specified for production units in a secondary mode is $\leq 1/4$ dB higher than the primary mode or when the highest reported SAR of the primary mode is scaled by the ratio of specified maximum output power and tune-up tolerance of secondary to primary mode and the adjusted SAR is ≤ 1.2 W/kg, SAR measurement is not required for the secondary mode.

10) Per KDB 941225 D05, SAR Evaluation Considerations for LTE Devices

(1) QPSK with 1 RB and 50% RB allocation

Start with the largest channel bandwidth and measure SAR, using the RB offset and required test channel combination with the highest maximum output power among RB offsets at the upper edge, middle and lower edge of each required test channel. When the reported SAR is ≤ 0.8 W/kg, testing of the remaining RB offset configurations and required test channels is not required; otherwise, SAR is required for the remaining required test channels and only for the RB offset configuration with the highest output power for that channel. When the reported SAR of a required test channel is > 1.45 W/kg, SAR is required for all three RB offset configurations for that required test channel.

(2) QPSK with 100% RB allocation

SAR is not required when the highest maximum output power for 100% RB allocation is less than the highest maximum output power in 50% and 1 RB allocations and the highest reported SAR for 1 RB and 50% RB allocation are ≤ 0.8 W/kg. Otherwise, SAR is measured for the highest output power channel; and if the reported SAR is > 1.45 W/kg, the remaining required test channels must also be tested.

(3) Higher order modulations

SAR is required only when the highest maximum output power for the configuration in the higher order modulation is $> 1/2$ dB higher than the same configuration in QPSK or when the reported SAR for the QPSK configuration is > 1.45 W/kg.

(4) Other channel bandwidth

SAR is required when the highest maximum output power of the smaller channel bandwidth is $> 1/2$ dB higher than the equivalent channel configurations in the largest channel bandwidth configuration or the reported SAR of a configuration for the largest channel bandwidth is > 1.45 W/kg.

9.2.1 Results overview of GSM850

Test Position of Head	Test channel /Freq.(MHz)	Test Mode	SAR Value (W/kg)		Power Drift (%)	Conducted Power (dBm)	Tune-up Limit (dBm)	Scaled SAR _{1-g} (W/kg)	Scaling Factor
			1-g	10-g					
Left Head Touched	128/824.2	GPRS 4TS	0.300	0.216	0.670	29.880	30.000	0.308	1.028
Left Head Tilted 15°	128/824.2	GPRS 4TS	0.209	0.154	2.320	29.880	30.000	0.215	1.028
Right Head Touched	128/824.2	GPRS 4TS	0.272	0.203	-1.390	29.880	30.000	0.280	1.028
Right Head Tilted 15°	128/824.2	GPRS 4TS	0.192	0.143	1.210	29.880	30.000	0.197	1.028
Test Position of Body with 10mm	Test channel /Freq.(MHz)	Test Mode	SAR Value (W/kg)		Power Drift (%)	Conducted Power (dBm)	Tune-up Limit (dBm)	Scaled SAR _{1-g} (W/kg)	Scaling Factor
			1-g	10-g					
SAR Results for Hotspot Exposure Condition									
Front side	128/824.2	GPRS 4TS	0.292	0.212	-1.160	29.880	30.000	0.300	1.028
Rear side	128/824.2	GPRS 4TS	0.312	0.229	1.780	29.880	30.000	0.321	1.028
Bottom side	128/824.2	GPRS 4TS	0.282	0.146	-1.820	29.880	30.000	0.290	1.028
Left side	128/824.2	GPRS 4TS	0.111	0.075	0.010	29.880	30.000	0.114	1.028
Right side	128/824.2	GPRS 4TS	0.068	0.035	0.020	29.880	30.000	0.070	1.028

9.2.2 Results overview of GSM1900

Test Position of Head	Test channel /Freq.(MHz)	Test Mode	SAR Value (W/kg)		Power Drift (%)	Conducted Power (dBm)	Tune-up Limit (dBm)	Scaled SAR _{1-g} (W/kg)	Scalig Factor
			1-g	10-g					
Left Head Touched	661/1880	GPRS 4TS	0.134	0.086	-0.420	26.860	27.000	0.138	1.033
Left Head Tilted 15°	661/1880	GPRS 4TS	0.131	0.081	-1.240	26.860	27.000	0.135	1.033
Right Head Touched	661/1880	GPRS 4TS	0.093	0.057	1.440	26.860	27.000	0.096	1.033
Right Head Tilted 15°	661/1880	GPRS 4TS	0.114	0.066	2.310	26.860	27.000	0.118	1.033
Test Position of Body with 10mm	Test channel /Freq.(MHz)	Test Mode	SAR Value (W/kg)		Power Drift (%)	Conducted Power (dBm)	Tune-up Limit (dBm)	Scaled SAR _{1-g} (W/kg)	Scalig Factor
			1-g	10-g					
SAR Results for Hotspot Exposure Condition									
Front side	661/1880	GPRS 4TS	0.774	0.432	-2.480	26.860	27.000	0.799	1.033
Rear side	661/1880	GPRS 4TS	0.772	0.423	-1.520	26.860	27.000	0.797	1.033
Bottom side	661/1880	GPRS 4TS	0.482	0.236	-2.370	26.860	27.000	0.498	1.033
Left side	661/1880	GPRS 4TS	0.359	0.208	-2.910	26.860	27.000	0.371	1.033
Right side	661/1880	GPRS 4TS	0.129	0.088	-0.810	26.860	27.000	0.133	

9.2.3 Results overview of UMTS Band II

Test Position of Head	Test channel /Freq.(MHz)	Test Mode	SAR Value (W/kg)		Power Drift (%)	Conducted Power (dBm)	Tune-up Limit (dBm)	Scaled SAR _{1-g} (W/kg)	Scalig Factor
			1-g	10-g					
Left Head Touched	9538/1907.6	RMC	0.294	0.172	0.830	21.760	22.000	0.311	1.057
Left Head Tilted 15°	9538/1907.6	RMC	0.157	0.095	0.320	21.760	22.000	0.166	1.057
Right Head Touched	9538/1907.6	RMC	0.139	0.086	0.380	21.760	22.000	0.147	1.057
Right Head Tilted 15°	9538/1907.6	RMC	0.130	0.074	1.490	21.760	22.000	0.137	1.057
Test Position of Body with 10mm	Test channel /Freq.(MHz)	Test Mode	SAR Value (W/kg)		Power Drift (%)	Conducted Power (dBm)	Tune-up Limit (dBm)	Scaled SAR _{1-g} (W/kg)	Scalig Factor
			1-g	10-g					
SAR Results for Hotspot Exposure Condition									
Front side	9538/1907.6	RMC	0.526	0.264	-0.960	21.760	22.000	0.556	1.057
Rear side	9538/1907.6	RMC	0.525	0.271	-1.420	21.760	22.000	0.550	1.057
Bottom side	9538/1907.6	RMC	0.504	0.242	-1.180	21.760	22.000	0.533	1.057
Left side	9538/1907.6	RMC	0.337	0.193	-4.890	21.760	22.000	0.356	1.057
Right side	9538/1907.6	RMC	0.137	0.093	-1.210	21.760	22.000	0.145	1.057

9.2.4 Results overview of UMTS Band IV

Test Position of Head	Test channel /Freq.(MHz)	Test Mode	SAR Value (W/kg)		Power Drift (%)	Conducted Power (dBm)	Tune-up Limit (dBm)	Scaled SAR _{1-g} (W/kg)	Scalig Factor
			1-g	10-g					
Left Head Touched	1413/1732.5	RMC	0.298	0.179	0.890	22.180	22.500	0.321	1.076
Left Head Tilted 15°	1413/1732.5	RMC	0.126	0.076	-0.600	22.180	22.500	0.136	1.076
Right Head Touched	1413/1732.5	RMC	0.122	0.076	0.940	22.180	22.500	0.131	1.076
Right Head Tilted 15°	1413/1732.5	RMC	0.118	0.070	-0.200	22.180	22.500	0.127	1.076
Test Position of Body with 10mm	Test channel /Freq.(MHz)	Test Mode	SAR Value (W/kg)		Power Drift (%)	Conducted Power (dBm)	Tune-up Limit (dBm)	Scaled SAR _{1-g} (W/kg)	Scalig Factor
			1-g	10-g					
SAR Results for Hotspot Exposure Condition									
Front side	1413/1732.5	RMC	0.445	0.233	0.220	22.180	22.500	0.479	1.076
Rear side	1413/1732.5	RMC	0.417	0.222	-0.410	22.180	22.500	0.449	1.076
Bottom side	1413/1732.5	RMC	0.465	0.248	-0.200	22.180	22.500	0.501	1.076
Left side	1413/1732.5	RMC	0.346	0.205	2.740	22.180	22.500	0.372	1.076
Right side	1413/1732.5	RMC	0.146	0.055	1.140	22.180	22.500	0.157	1.076

9.2.5 Results overview of UMTS Band V

Test Position of Head	Test channel /Freq.(MHz)	Test Mode	SAR Value (W/kg)		Power Drift (%)	Conducted Power (dBm)	Tune-up Limit (dBm)	Scaled SAR _{1-g} (W/kg)	Scalig Factor
			1-g	10-g					
Left Head Touched	4132/826.4	RMC	0.203	0.150	1.660	22.490	22.500	0.203	1.002
Left Head Tilted 15°	4132/826.4	RMC	0.168	0.124	0.590	22.490	22.500	0.168	1.002
Right Head Touched	4132/826.4	RMC	0.216	0.157	2.240	22.490	22.500	0.216	1.002
Right Head Tilted 15°	4132/826.4	RMC	0.178	0.130	-0.140	22.490	22.500	0.178	1.002
Test Position of Body with 10mm	Test channel /Freq.(MHz)	Test Mode	SAR Value (W/kg)		Power Drift (%)	Conducted Power (dBm)	Tune-up Limit (dBm)	Scaled SAR _{1-g} (W/kg)	Scalig Factor
			1-g	10-g					
SAR Results for Hotspot Exposure Condition									
Front side	4132/826.4	RMC	0.205	0.152	2.130	22.490	22.500	0.205	1.002
Rear side	4132/826.4	RMC	0.228	0.168	0.370	22.490	22.500	0.229	1.002
Bottom side	4132/826.4	RMC	0.128	0.071	0.270	22.490	22.500	0.128	1.002
Left side	4132/826.4	RMC	0.100	0.066	0.110	22.490	22.500	0.100	1.002
Right side	4132/826.4	RMC	0.050	0.026	0.320	22.490	22.500	0.050	1.002

9.2.6 Results overview of LTE Band II

Test Position of Head	Test channel /Freq.(MHz)	Test Mode	SAR Value (W/kg)		Power Drift (%)	Conducted Power (dBm)	Tune-up Limit (dBm)	Scaled SAR _{1-g} (W/kg)	Scalig Factor
			1-g	10-g					
Left Head Touched	19100/1900	20M QPSK 1RB#99	0.077	0.043	1.100	21.450	21.500	0.078	1.012
Left Head Tilted 15°	19100/1900	20M QPSK 1RB#99	0.099	0.056	-1.200	21.450	21.500	0.100	1.012
Right Head Touched	19100/1900	20M QPSK 1RB#99	0.082	0.047	-0.030	21.450	21.500	0.083	1.012
Right Head Tilted 15°	19100/1900	20M QPSK 1RB#99	0.100	0.054	-0.540	21.450	21.500	0.101	1.012
Left Head Touched	19100/1900	20M QPSK 50%RB#25	0.063	0.026	2.320	21.460	21.500	0.064	1.009
Left Head Tilted 15°	19100/1900	20M QPSK 50%RB#25	0.081	0.052	-2.530	21.460	21.500	0.082	1.009
Right Head Touched	19100/1900	20M QPSK 50%RB#25	0.067	0.038	0.670	21.460	21.500	0.068	1.009
Right Head Tilted 15°	19100/1900	20M QPSK 50%RB#25	0.101	0.054	-0.480	21.460	21.500	0.102	1.009
Test Position of Body with 10mm	Test channel /Freq.(MHz)	Test Mode	SAR Value (W/kg)		Power Drift (%)	Conducted Power (dBm)	Tune-up Limit (dBm)	Scaled SAR _{1-g} (W/kg)	Scalig Factor
			1-g	10-g					
SAR Results for Hotspot Exposure Condition									
Front side	19100/1900	20M QPSK 1RB#99	0.420	0.214	-0.540	21.450	21.500	0.425	1.012
Rear side	19100/1900	20M QPSK 1RB#99	0.238	0.127	1.700	21.450	21.500	0.241	1.012
Bottom side	19100/1900	20M QPSK 1RB#99	0.313	0.152	1.680	21.450	21.500	0.317	1.012
Left side	19100/1900	20M QPSK 1RB#99	0.359	0.208	0.690	21.450	21.500	0.363	1.012
Right side	19100/1900	20M QPSK 1RB#99	0.159	0.098	0.091	21.450	21.500	0.161	1.012
Front side	19100/1900	20M QPSK 50%RB#25	0.330	0.163	-1.030	21.460	21.500	0.333	1.009
Rear side	19100/1900	20M QPSK 50%RB#25	0.245	0.130	-1.890	21.460	21.500	0.247	1.009
Bottom side	19100/1900	20M QPSK 50%RB#25	0.248	0.122	-1.090	21.460	21.500	0.250	1.009
Left side	19100/1900	20M QPSK 50%RB#25	0.233	0.135	-2.150	21.460	21.500	0.235	1.009
Right side	19100/1900	20M QPSK 50%RB#25	0.103	0.085	-0.160	21.460	21.500	0.104	1.009

9.2.7 Results overview of LTE Band IV

Test Position of Head	Test channel /Freq.(MHz)	Test Mode	SAR Value (W/kg)		Power Drift (%)	Conducted Power (dBm)	Tune-up Limit (dBm)	Scaled SAR _{1-g} (W/kg)	Scalig Factor
			1-g	10-g					
Left Head Touched	20300/1745	20M QPSK 1RB#99	0.132	0.079	0.150	21.420	21.500	0.134	1.012
Left Head Tilted 15°	20300/1745	20M QPSK 1RB#99	0.088	0.054	-0.170	21.420	21.500	0.090	1.012
Right Head Touched	20300/1745	20M QPSK 1RB#99	0.069	0.043	2.090	21.420	21.500	0.070	1.012
Right Head Tilted 15°	20300/1745	20M QPSK 1RB#99	0.087	0.051	-0.240	21.420	21.500	0.089	1.012
Left Head Touched	20300/1745	20M QPSK 50%RB#25	0.109	0.065	-0.270	21.340	21.500	0.113	1.009
Left Head Tilted 15°	20300/1745	20M QPSK 50%RB#25	0.074	0.045	-0.120	21.340	21.500	0.077	1.009
Right Head Touched	20300/1745	20M QPSK 50%RB#25	0.058	0.036	-1.700	21.340	21.500	0.060	1.009
Right Head Tilted 15°	20300/1745	20M QPSK 50%RB#25	0.074	0.043	0.150	21.340	21.500	0.077	1.009
Test Position of Body with 10mm	Test channel /Freq.(MHz)	Test Mode	SAR Value (W/kg)		Power Drift (%)	Conducted Power (dBm)	Tune-up Limit (dBm)	Scaled SAR _{1-g} (W/kg)	Scalig Factor
			1-g	10-g					
SAR Results for Hotspot Exposure Condition									
Front side	20300/1745	20M QPSK 1RB#99	0.304	0.158	-0.090	21.420	21.500	0.310	1.012
Rear side	20300/1745	20M QPSK 1RB#99	0.281	0.150	0.230	21.420	21.500	0.286	1.012
Bottom side	20300/1745	20M QPSK 1RB#99	0.311	0.167	-1.550	21.420	21.500	0.317	1.012
Left side	20300/1745	20M QPSK 1RB#99	0.328	0.192	-2.110	21.420	21.500	0.334	1.012
Right side	20300/1745	20M QPSK 1RB#99	0.128	0.093	-0.130	21.420	21.500	0.130	1.012
Front side	20300/1745	20M QPSK 50%RB#25	0.252	0.133	-0.680	21.340	21.500	0.261	1.009
Rear side	20300/1745	20M QPSK 50%RB#25	0.230	0.123	-0.080	21.340	21.500	0.239	1.009
Bottom side	20300/1745	20M QPSK 50%RB#25	0.272	0.147	-0.990	21.340	21.500	0.282	1.009
Left side	20300/1745	20M QPSK 50%RB#25	0.283	0.165	-1.720	21.340	21.500	0.294	1.009
Right side	20300/1745	20M QPSK 50%RB#25	0.133	0.095	-0.320	21.340	21.500	0.138	1.009

9.2.8 Results overview of LTE Band VII

Test Position of Head	Test channel /Freq.(MHz)	Test Mode	SAR Value (W/kg)		Power Drift (%)	Conducted Power (dBm)	Tune-up Limit (dBm)	Scaled SAR _{1-g} (W/kg)	Scalig Factor
			1-g	10-g					
Left Head Touched	21100/2535	20M QPSK 1RB#99	0.033	0.026	0.000	21.280	21.500	0.035	1.052
Left Head Tilted 15°	21100/2535	20M QPSK 1RB#99	0.032	0.023	0.000	21.280	21.500	0.034	1.052
Right Head Touched	21100/2535	20M QPSK 1RB#99	0.103	0.032	0.150	21.280	21.500	0.108	1.052
Right Head Tilted 15°	21100/2535	20M QPSK 1RB#99	0.048	0.015	3.200	21.280	21.500	0.050	1.052
Left Head Touched	21100/2535	20M QPSK 50%RB#25	0.035	0.021	0.000	21.150	21.500	0.038	1.084
Left Head Tilted 15°	21100/2535	20M QPSK 50%RB#25	0.031	0.025	0.000	21.150	21.500	0.034	1.084
Right Head Touched	21100/2535	20M QPSK 50%RB#25	0.056	0.022	-1.200	21.150	21.500	0.061	1.084
Right Head Tilted 15°	21100/2535	20M QPSK 50%RB#25	0.036	0.025	1.150	21.150	21.500	0.039	1.084
Test Position of Body with 10mm	Test channel /Freq.(MHz)	Test Mode	SAR Value (W/kg)		Power Drift (%)	Conducted Power (dBm)	Tune-up Limit (dBm)	Scaled SAR _{1-g} (W/kg)	Scalig Factor
			1-g	10-g					
SAR Results for Hotspot Exposure Condition									
Front side	21100/2535	20M QPSK 1RB#99	0.036	0.028	1.080	21.280	21.500	0.038	1.052
Rear side	21100/2535	20M QPSK 1RB#99	0.035	0.023	1.910	21.280	21.500	0.037	1.052
Bottom side	21100/2535	20M QPSK 1RB#99	0.033	0.021	0.000	21.280	21.500	0.035	1.052
Left side	21100/2535	20M QPSK 1RB#99	0.026	0.016	-1.410	21.280	21.500	0.027	1.052
Right side	21100/2535	20M QPSK 1RB#99	0.016	0.010	-1.320	21.280	21.500	0.017	1.052
Front side	21100/2535	20M QPSK 50%RB#25	0.028	0.015	-1.190	21.150	21.500	0.030	1.084
Rear side	21100/2535	20M QPSK 50%RB#25	0.032	0.023	-1.100	21.150	21.500	0.035	1.084
Bottom side	21100/2535	20M QPSK 50%RB#25	0.031	0.021	0.000	21.150	21.500	0.034	1.084
Left side	21100/2535	20M QPSK 50%RB#25	0.025	0.022	-2.770	21.150	21.500	0.027	1.084
Right side	21100/2535	20M QPSK 50%RB#25	0.020	0.009	-0.720	21.150	21.500	0.022	1.084

9.2.9 Results overview of Wi-Fi 2.4G

Test Position of Head	Test channel /Freq.(MHz)	Test Mode	SAR Value (W/kg)		Power Drift (%)	Conducted Power (dBm)	Tune-up Limit (dBm)	Scaled SAR _{1-g} (W/kg)	Scaling Factor
			1-g	10-g					
Left Head Touched	6/2437	802.11b	0.295	0.129	1.550	14.580	15.000	0.325	1.102
Left Head Tilted 15°	6/2437	802.11b	0.255	0.117	1.580	14.580	15.000	0.281	1.102
Right Head Touched	6/2437	802.11b	0.107	0.054	1.490	14.580	15.000	0.118	1.102
Right Head Tilted 15°	6/2437	802.11b	0.082	0.040	0.810	14.580	15.000	0.090	1.102
Test Position of Body with 10mm	Test channel /Freq.(MHz)	Test Mode	SAR Value (W/kg)		Power Drift (%)	Conducted Power (dBm)	Tune-up Limit (dBm)	Scaled SAR _{1-g} (W/kg)	Scaling Factor
			1-g	10-g					
SAR Results for Hotspot Exposure Condition									
Front side	6/2437	802.11b	0.075	0.039	-0.290	14.580	15.000	0.083	1.102
Rear side	6/2437	802.11b	0.064	0.035	-0.800	14.580	15.000	0.070	1.102
Top side	6/2437	802.11b	0.040	0.018	-1.240	14.580	15.000	0.044	1.102
Right side	6/2437	802.11b	0.104	0.052	1.680	14.580	15.000	0.115	1.102

9.2.10 Results overview of Wi-Fi 5G

Test Position of Head	Test channel /Freq.(MHz)	Test Mode	SAR Value (W/kg)		Power Drift (%)	Conducted Power (dBm)	Tune-up Limit (dBm)	Scaled SAR _{1-g} (W/kg)	Scaling Factor
			1-g	10-g					
5.2G U-NII-1 band (802.11a)									
Left Head Touched	48/5240	802.11a	0.148	0.112	-1.530	15.620	16.000	0.162	1.091
Left Head Tilted 15°	48/5240	802.11a	0.013	0.011	-2.120	15.620	16.000	0.014	1.091
Right Head Touched	48/5240	802.11a	0.178	0.086	-0.720	15.620	16.000	0.194	1.091
Right Head Tilted 15°	48/5240	802.11a	<0.001	<0.001	0.000	15.620	16.000	0.000	1.091
5.8G U-NII-3 Band (802.11a)									
Left Head Touched	165/5825	802.11a	0.108	0.050	1.300	15.390	15.500	0.111	1.026
Left Head Tilted 15°	165/5825	802.11a	0.012	0.008	-0.100	15.390	15.500	0.012	1.026
Right Head Touched	165/5825	802.11a	0.119	0.059	0.190	15.390	15.500	0.130	1.026
Right Head Tilted 15°	165/5825	802.11a	<0.001	<0.001	0.000	15.390	15.500	0.000	1.026
Test Position of Body with 10mm	Test channel /Freq.(MHz)	Test Mode	SAR Value (W/kg)		Power Drift (%)	Conducted Power (dBm)	Tune-up Limit (dBm)	Scaled SAR _{1-g} (W/kg)	Scaling Factor
			1-g	10-g					
SAR Results for Hotspot Exposure Condition with 10mm									
5.2G U-NII-1 band (802.11a)									
Front side	48/5240	802.11a	0.071	0.040	-0.860	15.620	16.000	0.077	1.091
Rear side	48/5240	802.11a	0.101	0.053	-1.350	15.620	16.000	0.110	1.091
Top side	48/5240	802.11a	0.059	0.036	-1.520	15.620	16.000	0.064	1.091
Right side	48/5240	802.11a	0.085	0.051	-0.590	15.620	16.000	0.093	1.091
5.8G U-NII-3 Band (802.11a)									
Front side	165/5825	802.11a	0.060	0.042	1.460	15.390	15.500	0.062	1.026
Rear side	165/5825	802.11a	0.092	0.048	-2.310	15.390	15.500	0.100	1.026
Top side	165/5825	802.11a	0.052	0.031	-1.900	15.390	15.500	0.053	1.026
Right side	165/5825	802.11a	0.061	0.048	0.710	15.390	15.500	0.063	1.026

10 Multiple Transmitter Information

The SAR measurement positions of each side are as below:

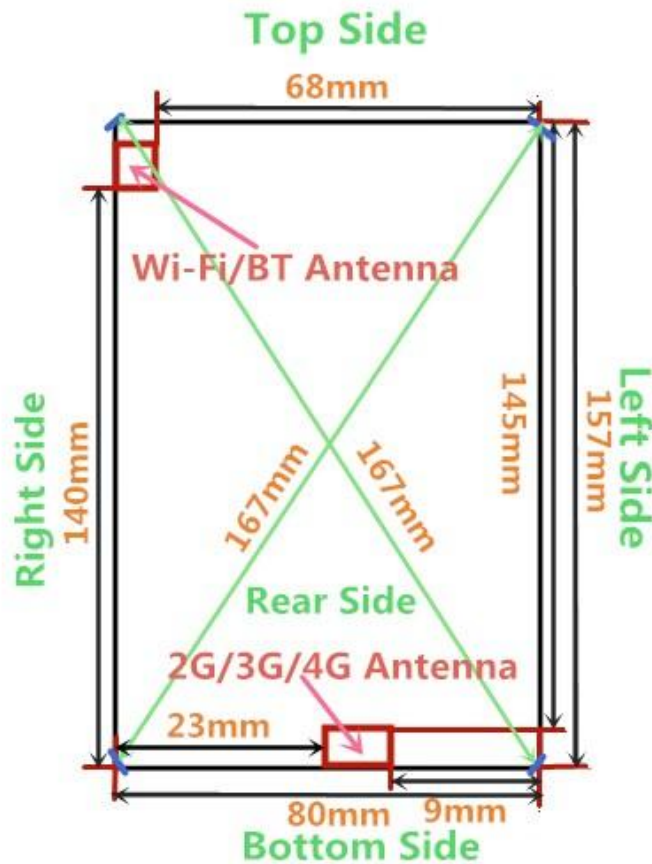

< Rear Side >

Mode	Front side	Rear side	Left side	Right side	Top side	Bottom side
2G/3G/4G Antenna	Yes	Yes	Yes	Yes	No	Yes
Wi-Fi/BT Antenna	Yes	Yes	No	Yes	Yes	No

1) Per KDB941225 D06v01r01, the DUT Dimension is bigger than 9 cm x 5 cm, so 10mm is chosen as the test separation distance for Hotspot mode. When the antenna-to-edge distance is greater than 2.5cm, such position does not need to be tested.

10.1.1 Stand-alone SAR test exclusion

The 1-g and 10-g SAR test exclusion thresholds for 100 MHz to 6 GHz at test separation distances \leq 50 mm are determined by:

$[(\text{max. power of channel, including tune-up tolerance, mW})/(\text{min. test separation distance, mm})] \cdot [\sqrt{f(\text{GHz})}] \leq 3.0$ for 1-g SAR and ≤ 7.5 for 10-g extremity SAR, where

- $f(\text{GHz})$ is the RF channel transmit frequency in GHz
- Power and distance are rounded to the nearest mW and mm before calculation
- The result is rounded to one decimal place for comparison

When the minimum test separation distance is < 5 mm, a distance of 5 mm is applied to determine SAR test exclusion.

a) Head position

Mode	Pmax(dBm)	Pmax(mW)	Distance(mm)	f(GHz)	Calculation Result	exclusion Threshold	SAR test exclusion
BT	5.5	3.55	5.00	2.45	1.11	3.00	Yes

Body-Worn position

Mode	Pmax(dBm)	Pmax(mW)	Distance(mm)	f(GHz)	Calculation Result	exclusion Threshold	SAR test exclusion
BT	5.5	3.55	10.00	2.45	0.56	3.00	Yes

When the standalone SAR test exclusion applies to an antenna that transmits simultaneously with other antennas, the standalone SAR must be estimated according to the following to determine simultaneous transmission SAR test exclusion

$(\text{max. power of channel, including tune-up tolerance, mW}) / (\text{min. test separation distance, mm}) \cdot [\sqrt{f(\text{GHz})} / x]$ W/kg for test separation distances ≤ 50 mm, where $x = 7.5$ for 1-g SAR.

When the minimum test separation distance is < 5 mm, a distance of 5 mm is applied to determine SAR test exclusion.

Mode	Position	Pmax(dBm)	Pmax(mW)	Distance(mm)	f(GHz)	X	Estimated SAR(W/Kg)
BT	Head	5.5	3.55	5.00	2.45	7.50	0.148
BT	Body	5.5	3.55	10.00	2.45	7.50	0.074

10.1.2 Simultaneous Transmission Possibilities

The Simultaneous Transmission Possibilities are as below:

Simultaneous Transmission Possibilities				
Simultaneous Tx Combination	Configuration	Head	Body	Hotspot
1	GSM/GPRS/UMTS/LTE +Wi-Fi	YES	YES	YES
2	GSM/GPRS/UMTS/LTE +BT	YES	NO	NO

Note: The device does not support simultaneous BT and Wi-Fi ,because the BT and Wi-Fi share the same antenna and can't transmit simultaneously.

10.1.3 SAR Summation Scenario

Test Position		Scaled SAR _{Max}		\sum_{1-g} SAR	Wi-Fi (5G)	\sum_{1-g} SAR	SPLSP
		GSM850	Wi-Fi (2.4G)				
Head	Left Head Touched	0.308	0.325	0.633	0.162	0.470	NA
	Left Head Tilted 15°	0.215	0.281	0.496	0.014	0.229	NA
	Right Head Touched	0.280	0.118	0.398	0.194	0.474	NA
	Right Head Tilted 15°	0.197	0.090	0.287	0.000	0.197	NA
Hotspot	Front side	0.300	0.083	0.383	0.077	0.377	NA
	Rear side	0.321	0.070	0.391	0.110	0.431	NA
	Bottom side	0.290	0.000	0.290	0.000	0.290	NA
	Left side	0.114	0.000	0.114	0.000	0.114	NA
	Right side	0.070	0.115	0.185	0.093	0.163	NA

Note: Simultaneous Tx Combination of GSM850 and Wi-Fi

Test Position		Scaled SAR _{Max}		\sum_{1-g} SAR	Wi-Fi (5G)	\sum_{1-g} SAR	SPLSP
		GSM1900	Wi-Fi (2.4G)				
Head	Left Head Touched	0.138	0.325	0.463	0.162	0.300	NA
	Left Head Tilted 15°	0.135	0.281	0.416	0.014	0.149	NA
	Right Head Touched	0.096	0.118	0.214	0.194	0.290	NA
	Right Head Tilted 15°	0.118	0.090	0.208	0.000	0.118	NA
Hotspot	Front side	0.799	0.083	0.882	0.077	0.876	NA
	Rear side	0.797	0.070	0.867	0.110	0.907	NA
	Bottom side	0.498	0.000	0.498	0.000	0.498	NA
	Left side	0.371	0.000	0.371	0.000	0.371	NA
	Right side	0.133	0.115	0.248	0.093	0.226	NA

Note: Simultaneous Tx Combination of GSM1900 and Wi-Fi

Test Position		Scaled SAR _{Max}		\sum_{1-g} SAR	Wi-Fi (5G)	\sum_{1-g} SAR	SPLSP
		UMTS Band II	Wi-Fi (2.4G)				
Head	Left Head Touched	0.311	0.325	0.636	0.162	0.473	NA
	Left Head Tilted 15°	0.166	0.281	0.447	0.014	0.180	NA
	Right Head Touched	0.147	0.118	0.265	0.194	0.341	NA
	Right Head Tilted 15°	0.137	0.090	0.227	0.000	0.137	NA
Hotspot	Front side	0.556	0.083	0.639	0.077	0.633	NA
	Rear side	0.550	0.070	0.620	0.110	0.660	NA
	Bottom side	0.533	0.000	0.533	0.000	0.533	NA
	Left side	0.356	0.000	0.356	0.000	0.356	NA
	Right side	0.145	0.115	0.260	0.093	0.238	NA

Note: Simultaneous Tx Combination of UMTS Band II and Wi-Fi

Test Position		Scaled SAR _{Max}		Σ_{1-g} SAR	Wi-Fi (5G)	Σ_{1-g} SAR	SPLSP
		UMTS Band IV	Wi-Fi (2.4G)				
Head	Left Head Touched	0.321	0.325	0.646	0.162	0.483	NA
	Left Head Tilted 15°	0.136	0.281	0.417	0.014	0.150	NA
	Right Head Touched	0.131	0.118	0.249	0.194	0.325	NA
	Right Head Tilted 15°	0.127	0.090	0.217	0.000	0.127	NA
Hotspot	Front side	0.479	0.083	0.562	0.077	0.556	NA
	Rear side	0.449	0.070	0.519	0.110	0.559	NA
	Bottom side	0.501	0.000	0.501	0.000	0.501	NA
	Left side	0.372	0.000	0.372	0.000	0.372	NA
	Right side	0.157	0.115	0.272	0.093	0.250	NA

Note: Simultaneous Tx Combination of UMTS Band IV and Wi-Fi

Test Position		Scaled SAR _{Max}		Σ_{1-g} SAR	Wi-Fi (5G)	Σ_{1-g} SAR	SPLSP
		UMTS Band V	Wi-Fi (2.4G)				
Head	Left Head Touched	0.203	0.325	0.528	0.162	0.365	NA
	Left Head Tilted 15°	0.168	0.281	0.449	0.014	0.182	NA
	Right Head Touched	0.216	0.118	0.334	0.194	0.410	NA
	Right Head Tilted 15°	0.178	0.090	0.268	0.000	0.178	NA
Hotspot	Front side	0.205	0.083	0.288	0.077	0.282	NA
	Rear side	0.229	0.070	0.299	0.110	0.339	NA
	Bottom side	0.128	0.000	0.128	0.000	0.128	NA
	Left side	0.100	0.000	0.100	0.000	0.100	NA
	Right side	0.050	0.115	0.165	0.093	0.143	NA

Note: Simultaneous Tx Combination of UMTS Band V and Wi-Fi

Test Position		Scaled SAR _{Max}		Σ_{1-g} SAR	Wi-Fi (5G)	Σ_{1-g} SAR	SPLSP
		LTE Band II	Wi-Fi (2.4G)				
Head	Left Head Touched	0.078	0.325	0.403	0.162	0.240	NA
	Left Head Tilted 15°	0.100	0.281	0.381	0.014	0.114	NA
	Right Head Touched	0.083	0.118	0.201	0.194	0.277	NA
	Right Head Tilted 15°	0.102	0.090	0.192	0.000	0.102	NA
Hotspot	Front side	0.425	0.083	0.508	0.077	0.502	NA
	Rear side	0.247	0.070	0.317	0.110	0.357	NA
	Bottom side	0.317	0.000	0.317	0.000	0.317	NA
	Left side	0.363	0.000	0.363	0.000	0.363	NA
	Right side	0.161	0.115	0.276	0.093	0.254	NA

Note: Simultaneous Tx Combination of LTE Band II and Wi-Fi

Test Position		Scaled SAR _{Max}		Σ _{1-g} SAR	Wi-Fi (5G)	Σ _{1-g} SAR	SPLSP
		LTE Band IV	Wi-Fi (2.4G)				
Head	Left Head Touched	0.134	0.325	0.459	0.162	0.296	NA
	Left Head Tilted 15°	0.090	0.281	0.371	0.014	0.104	NA
	Right Head Touched	0.070	0.118	0.188	0.194	0.264	NA
	Right Head Tilted 15°	0.089	0.090	0.179	0.000	0.089	NA
Hotspot	Front side	0.310	0.083	0.393	0.077	0.387	NA
	Rear side	0.286	0.070	0.356	0.110	0.396	NA
	Bottom side	0.317	0.000	0.317	0.000	0.317	NA
	Left side	0.334	0.000	0.334	0.000	0.334	NA
	Right side	0.138	0.115	0.253	0.093	0.231	NA

Note: Simultaneous Tx Combination of LTE Band IV and Wi-Fi

Test Position		Scaled SAR _{Max}		Σ _{1-g} SAR	Wi-Fi (5G)	Σ _{1-g} SAR	SPLSP
		LTE Band VII	Wi-Fi (2.4G)				
Head	Left Head Touched	0.038	0.325	0.363	0.162	0.200	NA
	Left Head Tilted 15°	0.034	0.281	0.315	0.014	0.048	NA
	Right Head Touched	0.108	0.118	0.226	0.194	0.302	NA
	Right Head Tilted 15°	0.050	0.090	0.140	0.000	0.050	NA
Hotspot	Front side	0.038	0.083	0.121	0.077	0.115	NA
	Rear side	0.037	0.070	0.107	0.110	0.147	NA
	Bottom side	0.035	0.000	0.035	0.000	0.035	NA
	Left side	0.027	0.000	0.027	0.000	0.027	NA
	Right side	0.022	0.115	0.137	0.093	0.115	NA

Note: Simultaneous Tx Combination of LTE Band VII and Wi-Fi

MAX.ΣSAR_{1g} = 0.907W/kg < 1.6 W/kg, so the Simultaneous SAR is not required for Wi-Fi and GSM&UMTS<E antenna.

Test Position		Scaled SAR _{Max}		\sum_{1-g} SAR	SPLSP
		GSM850	BT		
Head	Left Head Touched	0.308	0.148	0.456	NA
	Left Head Tilted 15°	0.215	0.148	0.363	NA
	Right Head Touched	0.280	0.148	0.428	NA
	Right Head Tilted 15°	0.197	0.148	0.345	NA

Note: Simultaneous Tx Combination of GSM850 and BT

Test Position		Scaled SAR _{Max}		\sum_{1-g} SAR	SPLSP
		GSM1900	BT		
Head	Left Head Touched	0.138	0.148	0.286	NA
	Left Head Tilted 15°	0.135	0.148	0.283	NA
	Right Head Touched	0.096	0.148	0.244	NA
	Right Head Tilted 15°	0.118	0.148	0.266	NA

Note: Simultaneous Tx Combination of GSM1900 and BT

Test Position		Scaled SAR _{Max}		\sum_{1-g} SAR	SPLSP
		UMTS Band II	BT		
Head	Left Head Touched	0.311	0.148	0.459	NA
	Left Head Tilted 15°	0.166	0.148	0.314	NA
	Right Head Touched	0.147	0.148	0.295	NA
	Right Head Tilted 15°	0.137	0.148	0.285	NA

Note: Simultaneous Tx Combination of UMTS Band II and BT

Test Position		Scaled SAR _{Max}		\sum_{1-g} SAR	SPLSP
		UMTS Band IV	BT		
Head	Left Head Touched	0.321	0.148	0.469	NA
	Left Head Tilted 15°	0.136	0.148	0.284	NA
	Right Head Touched	0.131	0.148	0.279	NA
	Right Head Tilted 15°	0.127	0.148	0.275	NA

Note: Simultaneous Tx Combination of UMTS Band IV and BT

Test Position		Scaled SAR _{Max}		\sum_{1-g} SAR	SPLSP
		UMTS Band V	BT		
Head	Left Head Touched	0.203	0.148	0.351	NA
	Left Head Tilted 15°	0.168	0.148	0.316	NA
	Right Head Touched	0.216	0.148	0.364	NA
	Right Head Tilted 15°	0.178	0.148	0.326	NA

Note: Simultaneous Tx Combination of UMTS Band V and BT

Test Position		Scaled SAR _{Max}		Σ _{1-g} SAR	SPLSP
		LTE Band II	BT		
Head	Left Head Touched	0.078	0.148	0.226	NA
	Left Head Tilted 15°	0.100	0.148	0.248	NA
	Right Head Touched	0.083	0.148	0.231	NA
	Right Head Tilted 15°	0.102	0.148	0.250	NA

Note: Simultaneous Tx Combination of LTE Band II and BT

Test Position		Scaled SAR _{Max}		Σ _{1-g} SAR	SPLSP
		LTE Band IV	BT		
Head	Left Head Touched	0.134	0.148	0.282	NA
	Left Head Tilted 15°	0.090	0.148	0.248	NA
	Right Head Touched	0.070	0.148	0.231	NA
	Right Head Tilted 15°	0.089	0.148	0.250	NA

Note: Simultaneous Tx Combination of LTE Band IV and BT

Test Position		Scaled SAR _{Max}		Σ _{1-g} SAR	SPLSP
		LTE Band VII	BT		
Head	Left Head Touched	0.038	0.148	0.186	NA
	Left Head Tilted 15°	0.034	0.148	0.182	NA
	Right Head Touched	0.108	0.148	0.256	NA
	Right Head Tilted 15°	0.050	0.148	0.198	NA

Note: Simultaneous Tx Combination of LTE Band VII and BT

MAX.ΣSAR_{1g} = 0.469W/kg < 1.6 W/kg, so the Simultaneous SAR is not required for BT and GSM&UMTS<E antenna.

11 Measurement uncertainty evaluation

11.1 Measurement uncertainty evaluation for SAR test

The following table includes the uncertainty table of the IEEE 1528. The values are determined by Satimo. The breakdown of the individual uncertainties is as follows:

Measurement Uncertainty evaluation for SAR test								
Uncertainty Component	Tol. (±%)	Prob. Dist.	Div.	C _i (1g)	C _i (10g)	1g U _i (±%)	10g U _i (±%)	V _i
measurement system								
Probe Calibration	5.8	N	1	1	1	5.8	5.8	∞
Axial Isotropy	3.5	R	$\sqrt{3}$	$(1-C_p)^{1/2}$	$(1-C_p)^{1/2}$	1.43	1.43	∞
Hemispherical Isotropy	5.9	R	$\sqrt{3}$	$\sqrt{C_p}$	$\sqrt{C_p}$	2.41	2.41	∞
Boundary Effect	1	R	$\sqrt{3}$	1	1	0.58	0.58	∞
Linearity	4.7	R	$\sqrt{3}$	1	1	2.71	2.71	∞
system Detection Limits	1	R	$\sqrt{3}$	1	1	0.58	0.58	∞
Modulation response	3	N	1	1	1	3.00	3.00	∞
Readout Electronics	0.5	N	1	1	1	0.50	0.50	∞
Response Time	0	R	$\sqrt{3}$	1	1	0.00	0.00	∞
Integration Time	1.4	R	$\sqrt{3}$	1	1	0.81	0.81	∞
RF Ambient Conditions-Noise	3	R	$\sqrt{3}$	1	1	1.73	1.73	∞
RF Ambient Conditions-Reflections	3	R	$\sqrt{3}$	1	1	1.73	1.73	∞
Probe Positioner Mechanical Tolerance	1.4	R	$\sqrt{3}$	1	1	0.81	0.81	∞
Probe positioning with respect to Phantom Shell	1.4	R	$\sqrt{3}$	1	1	0.81	0.81	∞
Extrapolation, interpolation and Integration Algorithms for Max.SAR Evaluation	2.3	R	$\sqrt{3}$	1	1	1.33	1.33	∞
Test sample Related								
Test Sample Positioning	2.6	N	1	1	1	2.60	2.60	11
Device Holder Uncertainty	3	N	1	1	1	3.00	3.00	7
Output Power Variation-SAR drift measurement	5	R	$\sqrt{3}$	1	1	2.89	2.89	∞
SAR scaling	2	R	$\sqrt{3}$	1	1	1.15	1.15	∞
Phantom and Tissue Parameters								
Phantom Uncertainty (shape and thickness tolerances)	4	R	$\sqrt{3}$	1	1	2.31	2.31	∞
Uncertainty in SAR correction for deviation (in permittivity and conductivity)	2	N	1	1	0.84	2.00	1.68	∞
Liquid conductivity (meas.)	2.5	N	1	0.64	0.43	1.60	1.08	5
Liquid conductivity (target.)	5	R	$\sqrt{3}$	0.64	0.43	1.85	1.24	5
Liquid Permittivity (meas.)	2.5	N	1	0.60	0.49	1.50	1.23	∞
Liquid Permittivity (target.)	5	R	$\sqrt{3}$	0.60	0.49	1.73	1.42	∞
Combined Standard Uncertainly		Rss				10.63	10.54	
Expanded Uncertainty{95% CONFIDENCE INTERVAL}		k				21.26	21.08	

11.2 Measurement uncertainty evaluation for system check

The following table includes the uncertainty table of the IEEE 1528. The values are determined by Satimo. The breakdown of the individual uncertainties is as follows:

Uncertainty For System Performance Check								
Uncertainty Component	Tol. (±%)	Prob. Dist.	Div.	C _i 1g	C _i 10g	1g U _i (±%)	10g U _i (±%)	V _i
measurement system								
Probe Calibration	5.8	N	1	1	1	5.80	5.80	∞
Axial Isotropy	3.5	R	$\sqrt{3}$	$(1-C_p)^{1/2}$	$(1-C_p)^{1/2}$	1.43	1.43	∞
Hemispherical Isotropy	5.9	R	$\sqrt{3}$	$\sqrt{C_p}$	$\sqrt{C_p}$	2.41	2.41	∞
Boundary Effect	1	R	$\sqrt{3}$	1	1	0.58	0.58	∞
Linearity	4.7	R	$\sqrt{3}$	1	1	2.71	2.71	∞
system detection Limits	1	R	$\sqrt{3}$	1	1	0.58	0.58	∞
Modulation response	0	N	1	1	1	0.00	0.00	∞
Readout Electronics	0.5	N	1	1	1	0.50	0.50	∞
Response Time	0	R	$\sqrt{3}$	1	1	0.00	0.00	∞
Integration Time	1.4	R	$\sqrt{3}$	1	1	0.81	0.81	∞
RF ambient Conditions - Noise	3	R	$\sqrt{3}$	1	1	1.73	1.73	∞
RF ambient Conditions – Reflections	3	R	$\sqrt{3}$	1	1	1.73	1.73	∞
Probe positioned Mechanical Tolerance	1.4	R	$\sqrt{3}$	1	1	0.81	0.81	∞
Probe positioning with respect to Phantom Shell	1.4	R	$\sqrt{3}$	1	1	0.81	0.81	∞
Extrapolation, interpolation and integration Algorithms for Max. SAR Evaluation	2.3	R	$\sqrt{3}$	1	1	1.33	1.33	∞
Dipole								
Deviation of experimental source from numerical source	4	N	1	1	1	4.00	4.00	∞
Input power and SAR drift measurement	5	R	$\sqrt{3}$	1	1	2.89	2.89	∞
Dipole axis to liquid Distance	2	R	$\sqrt{3}$	1	1	1.16	1.16	∞
Phantom and Tissue Parameters								
Phantom Uncertainty (shape and thickness tolerances)	4	R	$\sqrt{3}$	1	1	2.31	2.31	∞
Uncertainty in SAR correction for deviation (in permittivity and conductivity)	2	N	1	1	0.84	2.00	1.68	∞
Liquid conductivity (meas.)	2.5	N	1	0.64	0.43	1.60	1.08	5
Liquid conductivity (target.)	5	R	$\sqrt{3}$	0.64	0.43	1.85	1.24	5
Liquid Permittivity (meas.)	2.5	N	1	0.60	0.49	1.50	1.23	∞
Liquid Permittivity (target.)	5	R	$\sqrt{3}$	0.60	0.49	1.73	1.41	∞
Combined Standard Uncertainty		Rss				10.28	9.98	
Expanded Uncertainty (95% Confidence interval)		k				20.57	19.95	

12 Test equipment and ancillaries used for tests

To simplify the identification of the test equipment and/or ancillaries which were used, the reporting of the relevant test cases only refer to the test item number as specified in the table below.

	Manufacturer	Device Type	Type(Model)	Serial number	calibration	
					Last Cal.	Due Date
<input checked="" type="checkbox"/>	SATIMO	COMOSAR DOSIMETRIC E FIELD PROBE	SSE5	SN 07/15 EP252	2016-07-25	2017-07-24
<input checked="" type="checkbox"/>	SATIMO	COMOSAR DOSIMETRIC E FIELD PROBE	SSE2	SN 08/16 EPGO292	2016-12-09	2017-12-08
<input type="checkbox"/>	SATIMO	COMOSAR 750 MHz REFERENCE DIPOLE	SID750	SN 14/13 DIP 0G750-234	2016-07-25	2017-07-24
<input checked="" type="checkbox"/>	SATIMO	COMOSAR 835 MHz REFERENCE DIPOLE	SID835	SN 14/13 DIP0G835-235	2016-07-25	2017-07-24
<input type="checkbox"/>	SATIMO	COMOSAR 900 MHz REFERENCE DIPOLE	SID900	SN 14/13 DIP0G900-231	2016-07-25	2017-07-24
<input checked="" type="checkbox"/>	SATIMO	COMOSAR 1800 MHz REFERENCE DIPOLE	SID1800	SN 14/13 DIP1G800-232	2016-07-25	2017-07-24
<input checked="" type="checkbox"/>	SATIMO	COMOSAR 1900 MHz REFERENCE DIPOLE	SID1900	SN 14/13 DIP1G900-236	2016-07-25	2017-07-24
<input type="checkbox"/>	SATIMO	COMOSAR 2000 MHz REFERENCE DIPOLE	SID2000	SN 14/13 DIP2G000-237	2016-07-25	2017-07-24
<input checked="" type="checkbox"/>	SATIMO	COMOSAR 2450 MHz REFERENCE DIPOLE	SID2450	SN 14/13 DIP2G450-238	2016-07-25	2017-07-24
<input checked="" type="checkbox"/>	SATIMO	COMOSAR 2600 MHz REFERENCE DIPOLE	SID2600	SN 28/14 DIP2G600-327	2016-07-25	2017-07-24
<input checked="" type="checkbox"/>	SATIMO	COMOSAR 2600 MHz REFERENCE DIPOLE	SID5200	SN 14/13 EPG239	2016-07-25	2017-07-24
<input checked="" type="checkbox"/>	SATIMO	COMOSAR 2600 MHz REFERENCE DIPOLE	SID5800	SN 14/13 EPG239	2016-07-25	2017-07-24
<input checked="" type="checkbox"/>	SATIMO	Software	OPENSAR	N/A	N/A	N/A
<input checked="" type="checkbox"/>	SATIMO	Phantom	COMOSAR IEEE SAM PHANTOM	SN 14/13 SAM99	N/A	N/A
<input checked="" type="checkbox"/>	R & S	Universal Radio Communication Tester	CMU 200	117528	2016-08-19	2017-08-18
<input checked="" type="checkbox"/>	HP	Network Analyser	8753D	3410A08889	2016-08-19	2017-08-18
<input checked="" type="checkbox"/>	HP	Signal Generator	E4421B	GB39340770	2016-08-19	2017-08-18
<input checked="" type="checkbox"/>	Keithley	Multimeter	Keithley 2000	4014539	2016-08-19	2017-08-18
<input checked="" type="checkbox"/>	SATIMO	Amplifier	Power Amplifier	MODU-023-A- 0004	2016-10-13	2017-10-12
<input checked="" type="checkbox"/>	Agilent	Power Meter	E4418B	GB43312909	2016-10-13	2017-10-12
<input checked="" type="checkbox"/>	Agilent	Power Meter Sensor	E4412A	MY41500046	2016-10-13	2017-10-12
<input checked="" type="checkbox"/>	Agilent	Power Meter	E4417A	GB41291826	2016-10-13	2017-10-12
<input checked="" type="checkbox"/>	Agilent	Power Meter Sensor	8481H	MY41091215	2016-10-13	2017-10-12
<input checked="" type="checkbox"/>	SATIMO	DAE	SUPR72	SN 42/13	2016-07-25	2017-07-24

Annex A: System performance verification

(Please See the SAR Measurement Plots of annex A.)

Annex B: Measurement results

(Please See the SAR Measurement Plots of annex B.)

Annex C: Calibration reports

(Please See the Calibration reports of annex C.)

Annex D: Photo documentation

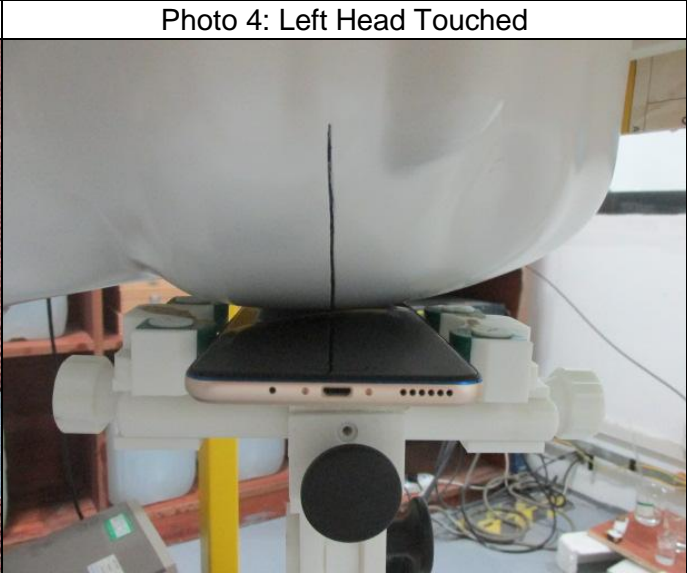
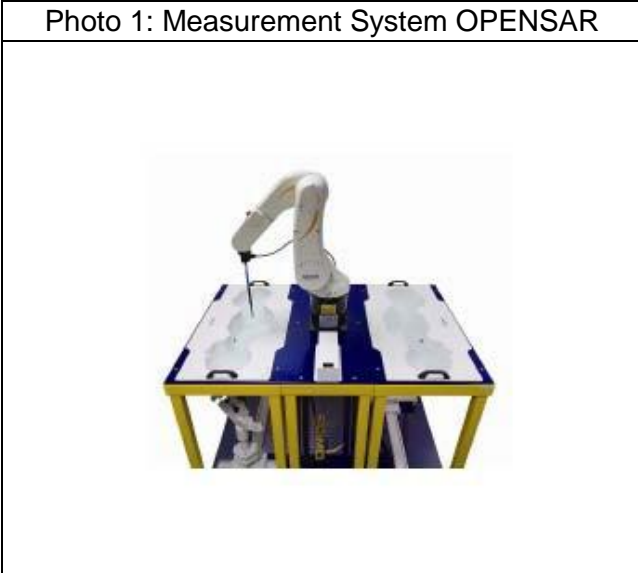







<p>Photo 5: Left Head Tilted 15°</p>	<p>Photo 6: Right Head Touched</p>
 A photograph showing a white mannequin head tilted to the left. The head is mounted on a white mechanical stand with yellow vertical supports. A smartphone is attached to the bottom of the stand. The background shows a laboratory setting with shelves and equipment.	 A photograph showing a white mannequin head tilted to the right. A smartphone is placed on the stand directly in front of the head, touching it. The background is the same laboratory setting.
<p>Photo 7: Right Head Tilted 15°</p>	<p>Photo 7: Towards Phantom 10mm</p>
 A photograph showing a white mannequin head tilted to the right. The smartphone is on the stand. The background is the laboratory setting.	 A close-up photograph of the smartphone on the stand, tilted towards the mannequin head. A yellow "10mm" scale bar is visible above the phone. The background shows the laboratory shelves.
<p>Photo 9: Towards Ground 10mm</p>	<p>Photo 10: Right Side 10mm</p>
 A close-up photograph of the smartphone on the stand, tilted downwards towards the ground. A yellow "10mm" scale bar is visible above the phone. The background shows the laboratory shelves.	 A close-up photograph of the smartphone on the stand, tilted to the right. A yellow "10mm" scale bar is visible above the phone. The background shows the laboratory shelves.

Photo 11: Left Side 10mm

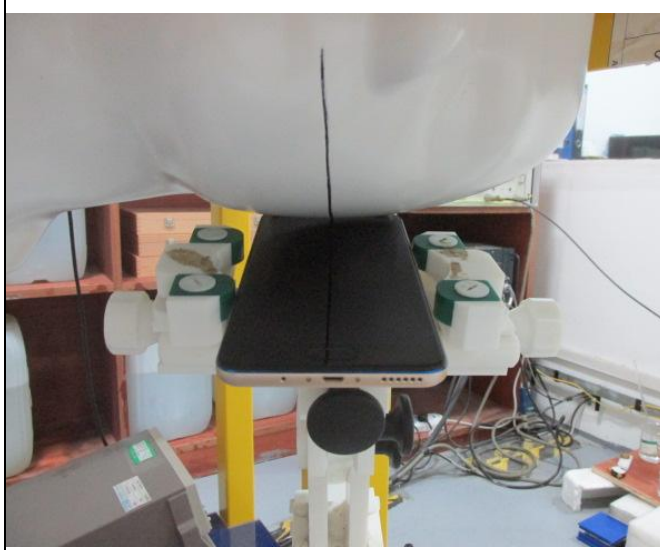

Photo 8: Top Side 10mm

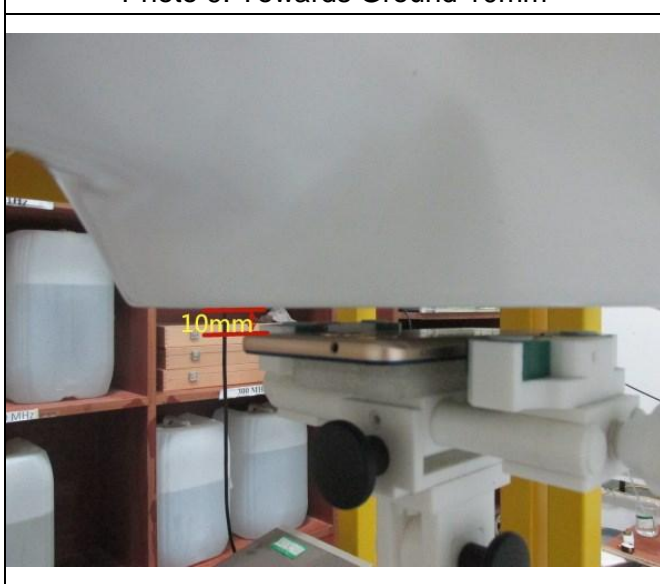

Photo 13: Bottom Side 10mm



Photo 14: 850MHz Liquid Depth $\geq 15.0\text{cm}$

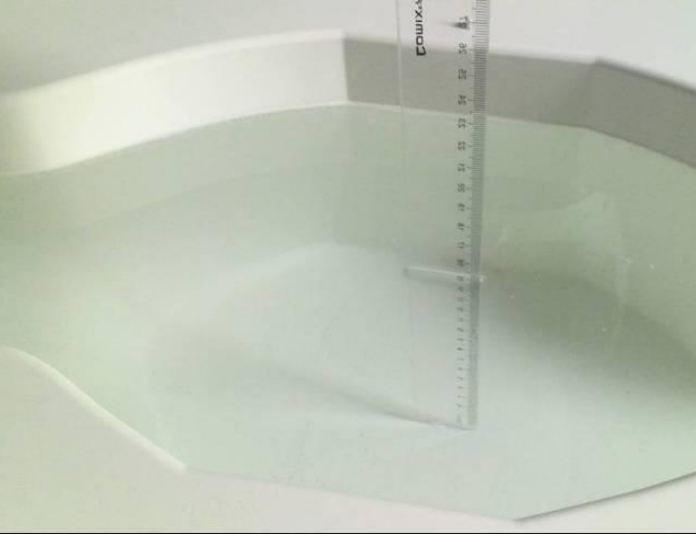



Photo 15: 1800~1900MHz Liquid Depth \geq 15.0cm	Photo 16: 2450MHz Liquid Depth \geq 15.0cm
	
Photo 17: N/A	Photo 18: N/A
N/A	N/A

End