

FCC Report

Application Purpose : Original grant

Applicant Name: : INFINIX MOBILITY LIMITED

FCC ID : 2AIZN-X557

Equipment Type : Mobile phone

Model Name : X557

Report Number : FCC16083920A-4

Standard(S) : FCC Part 15 Subpart C

Date Of Receipt : August 19, 2016

Date Of Issue : September 07, 2016

Test By : 

(Daisy Qin)

Reviewed By : 

(Sol Qin)

Authorized by : 

(Michal Ling)

Prepared by : **QTC Certification & Testing Co., Ltd.**
2nd Floor,Bl Building,Fengyeyuan Industrial Plant,,
Liuxian 2st. Road, Xin'an Street, Bao'an
District,,Shenzhen,518000
Registration Number: 588523

REPORT REVISE RECORD

Report Version	Revise Time	Issued Date	Valid Version	Notes
V1.0	/	September 07, 2016	Valid	Original Report

Table of Contents	Page
1. GENERAL INFORMATION	4
2. TEST DESCRIPTION	5
2.1 MEASUREMENT UNCERTAINTY	5
2.2 DESCRIPTION OF TEST MODES	6
2.3 CONFIGURATION OF SYSTEM UNDER TEST	7
2.4 DESCRIPTION OF SUPPORT UNITS (CONDUCTED MODE)	7
3. SUMMARY OF TEST RESULTS	9
4. MEASUREMENT INSTRUMENTS	10
5. EMC EMISSION TEST	11
5.1 CONDUCTED EMISSION MEASUREMENT	11
5.1.1 POWER LINE CONDUCTED EMISSION LIMITS	11
5.1.2 TEST PROCEDURE	12
5.1.3 DEVIATION FROM TEST STANDARD	12
5.1.4 TEST SETUP	12
5.1.5 EUT OPERATING CONDITIONS	12
5.1.6 TEST RESULTS	13
5.2 RADIATED EMISSION MEASUREMENT	19
5.2.1 RADIATED EMISSION LIMITS	19
5.2.2 TEST PROCEDURE	20
5.2.3 DEVIATION FROM TEST STANDARD	20
5.2.4 TEST SETUP	21
5.2.5 EUT OPERATING CONDITIONS	21
5.2.5.1 TEST RESULTS (BETWEEN 30M – 1000 MHZ)	22
5.2.5.2 TEST RESULTS(1GHZ TO 6GHZ)	28
6. EUT TEST PHOTO	31
7. PHOTOGRAPHS OF EUT	33

1. GENERAL INFORMATION

Test Model	X557
Applicant	INFINIX MOBILITY LIMITED
Address	RMS 05-15, 13A/F SOUTH TOWER WORLD FINANCE CTR HARBOUR CITY 17 CANTON RD TST KLN HONG KONG
Manufacturer	SHENZHEN TECNO TECHNOLOGY CO.,LTD.
Address	1-4th Floor,3rd Building,Pacific Industrial Park,No.2088,Shenyan Road,Yantian District,Shenzhen,Guangdong,China
Equipment Type	Mobile phone
Brand Name	Infinix
Hardware	V1.2
Software	X557-H807C1-M-160810V3
Battery information:	Li-Polymer Battery : BL-39AX Voltage: 3.85V Capacity: 3950mAh/ 4000mAh Limited Charge Voltage: 4.4V
Adapter Information:	Adapter: A88-502000 Input: 100-240V 50/60Hz 350mA Output: 5V 2A
Data of receipt	August 19, 2016
Date of test	August 19, 2016, to September 06, 2016
Deviation	None
Condition of Test Sample	Normal

We hereby certify that:

The above equipment was tested by QTC Certification & Testing Co., Ltd.

2nd Floor, BI Building, Fengyeyuan Industrial Plant, Liuxian 2st. Road, Xin'an Street, Bao'an District, Shenzhen, 518000

Registration Number: 588523

The data evaluation, test procedures, and equipment configurations shown in this report were made in accordance with the procedures given in ANSI C 63.4:2014. The sample tested as described in this report is in compliance with the FCC Rules Part 15 Subpart B.

The test results of this report relate only to the tested sample identified in this report.

2. TEST DESCRIPTION**2.1 MEASUREMENT UNCERTAINTY**

The reported uncertainty of measurement $y \pm U$, where expanded uncertainty U is based on a standard uncertainty multiplied by a coverage factor of $k=2$, providing a level of confidence of approximately **95%**.

No.	Item	Uncertainty
1	Conducted Emission Test	± 3.2 dB
2	RF power, conducted	± 0.16 dB
3	Spurious emissions, conducted	± 0.21 dB
4	All emissions, radiated(<1G)	± 4.7 dB
5	All emissions, radiated(>1G)	± 4.7 dB
6	Temperature	± 0.5 °C
7	Humidity	$\pm 2\%$

2.2 DESCRIPTION OF TEST MODES

To investigate the maximum EMI emission characteristics generates from EUT, the test system was pre-scanning tested base on the consideration of following EUT operation mode or test configuration mode which possible have effect on EMI emission level. Each of these EUT operation mode(s) or test configuration mode(s) mentioned above was evaluated respectively.

Pretest Mode	Description
Mode 1	Video Recording
Model 2	Video Playing
Mode 3	Exchange data with computer

For Conducted Emission	
Final Test Mode	Test with Keyboard and Mouse
Mode 1	Video Recording
Model 2	Video Playing
Mode 3	Exchange data with computer

For Radiated Emission	
Final Test Mode	Test with Keyboard and Mouse
Mode 1	Video Recording
Model 2	Video Playing
Mode 3	Exchange data with computer

2.3 CONFIGURATION OF SYSTEM UNDER TEST

Mode 1&2:

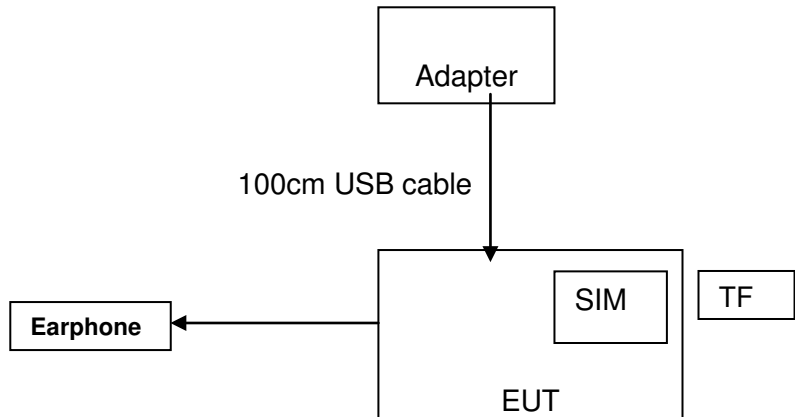

(EUT: Mobile phone)

Mode 3:

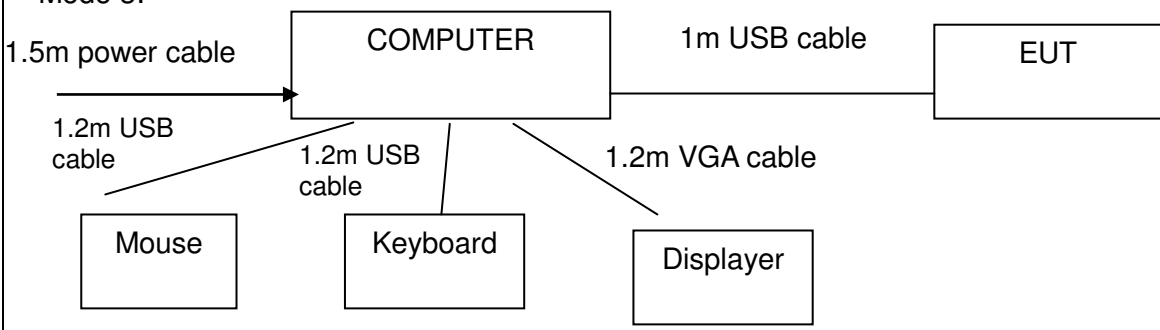

(EUT: Mobile phone)

I/O Port of EUT			
I/O Port Type	Q'TY	Cable	Tested with
Power	1	1m USB cable, unshielded	1
Earphone	1	1m USB cable, unshielded	1

2.4 DESCRIPTION OF SUPPORT UNITS (CONDUCTED MODE)

The EUT has been tested as an independent unit together with other necessary accessories or support units. The following support units or accessories were used to form a representative test configuration during the tests.

Item	Equipment	Mfr/Brand	Model/Type No.	Series No.	Note
1	Adapter	/	A88-502000	/	/
2	Keyboard	HP	SK-2880	435302-AA-	/
3	Mouse	DELL	MS111-1	/	/

Note:

- (1) The support equipment was authorized by Declaration of Confirmation.
- (2) For detachable type I/O cable should be specified the length in cm in 『Length』 column.

3. SUMMARY OF TEST RESULTS

Test procedures according to the technical standards:

FCC Part15 , Subpart B			
Standard Section	Test Item	Judgment	Remark
15.107	CONDUCTED EMISSION	PASS	
15.109	RADIATED EMISSION	PASS	

NOTE:

(1) "N/A" denotes test is not applicable in this test report.

4. MEASUREMENT INSTRUMENTS

Kind of Equipment	Manufacturer	Type No.	Serial No.	Last Calibrated	Calibrated until
ESCI Test Receiver	R&S	ESCI	100005	08/19/2016	08/18/2017
LISN	AFJ	LS16	16010222119	08/19/2016	08/18/2017
LISN(EUT)	Mestec	AN3016	04/10040	08/19/2016	08/18/2017
pre-amplifier	CDSI	PAP-1G18-38	--	08/19/2016	08/18/2017
System Controller	CT	SC100	-	08/19/2016	08/18/2017
Bi-log Antenna	Chase	CBL6111C	2576	08/19/2016	08/18/2017
Spectrum analyzer	R&S	FSU26	200409	08/19/2016	08/18/2017
Horn Antenna	SCHWARZBECK	9120D	1141	08/19/2016	08/18/2017
Bi-log Antenna	SCHWABEBECK	VULB9163	9163/340	08/19/2016	08/18/2017
Pre Amplifier	H.P.	HP8447E	2945A02715	10/13/2016	10/12/2017
9*6*6 Anechoic	--	--	--	08/21/2016	08/20/2017

5. EMC EMISSION TEST

5.1 CONDUCTED EMISSION MEASUREMENT

5.1.1 POWER LINE CONDUCTED EMISSION Limits (Frequency Range 150KHz-30MHz)

FREQUENCY (MHz)	Class A (dBuV)		Class B (dBuV)		Standard
	Quasi-peak	Average	Quasi-peak	Average	
0.15 -0.5	79.00	66.00	66 - 56 *	56 - 46 *	FCC
0.50 -5.0	73.00	60.00	56.00	46.00	FCC
5.0 -30.0	73.00	60.00	60.00	50.00	FCC

Note:

- (1) The tighter limit applies at the band edges.
- (2) The limit of " * " marked band means the limitation decreases linearly with the logarithm of the frequency in the range.

The following table is the setting of the receiver

Receiver Parameters	Setting
Attenuation	10 dB
Start Frequency	0.15 MHz
Stop Frequency	30 MHz
IF Bandwidth	9 kHz

5.1.2 TEST PROCEDURE

- The EUT was placed 0.4 meters from the horizontal ground plane with EUT being connected to the power mains through a line impedance stabilization network (LISN). All other support equipments powered from additional LISN(s). The LISN provide 50 Ohm/ 50uH of coupling impedance for the measuring instrument.
- Interconnecting cables that hang closer than 40 cm to the ground plane shall be folded back and forth in the center forming a bundle 30 to 40 cm long.
- I/O cables that are not connected to a peripheral shall be bundled in the center. The end of the cable may be terminated, if required, using the correct terminating impedance. The overall length shall not exceed 1 m.
- LISN at least 80 cm from nearest part of EUT chassis.
- For the actual test configuration, please refer to the related Item –EUT Test Photos.

5.1.3 DEVIATION FROM TEST STANDARD

No deviation

5.1.4 TEST SETUP

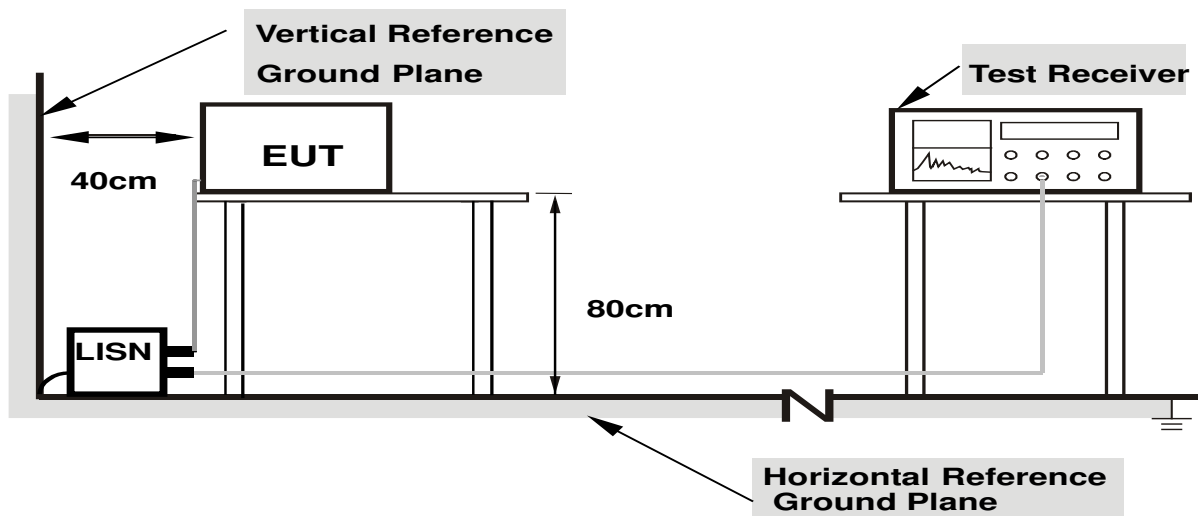

- Note: 1.Support units were connected to second LISN.
2.Both of LISNs (AMN) are 80 cm from EUT and at least 80 from other units and other metal planes**

5.1.5 EUT OPERATING CONDITIONS

The EUT was configured for testing in a typical fashion (as a customer would normally use it). The EUT has been programmed to continuously transmit during test. This operating condition was tested and used to collect the included data.

5.1.6 TEST RESULTS

EUT	Mobile phone	Model Name	X557
Temperature	26 °C	Relative Humidity	54%
Pressure	1010hPa	Phase	L
Test Date	August 22, 2016	Test Mode	Mode 1

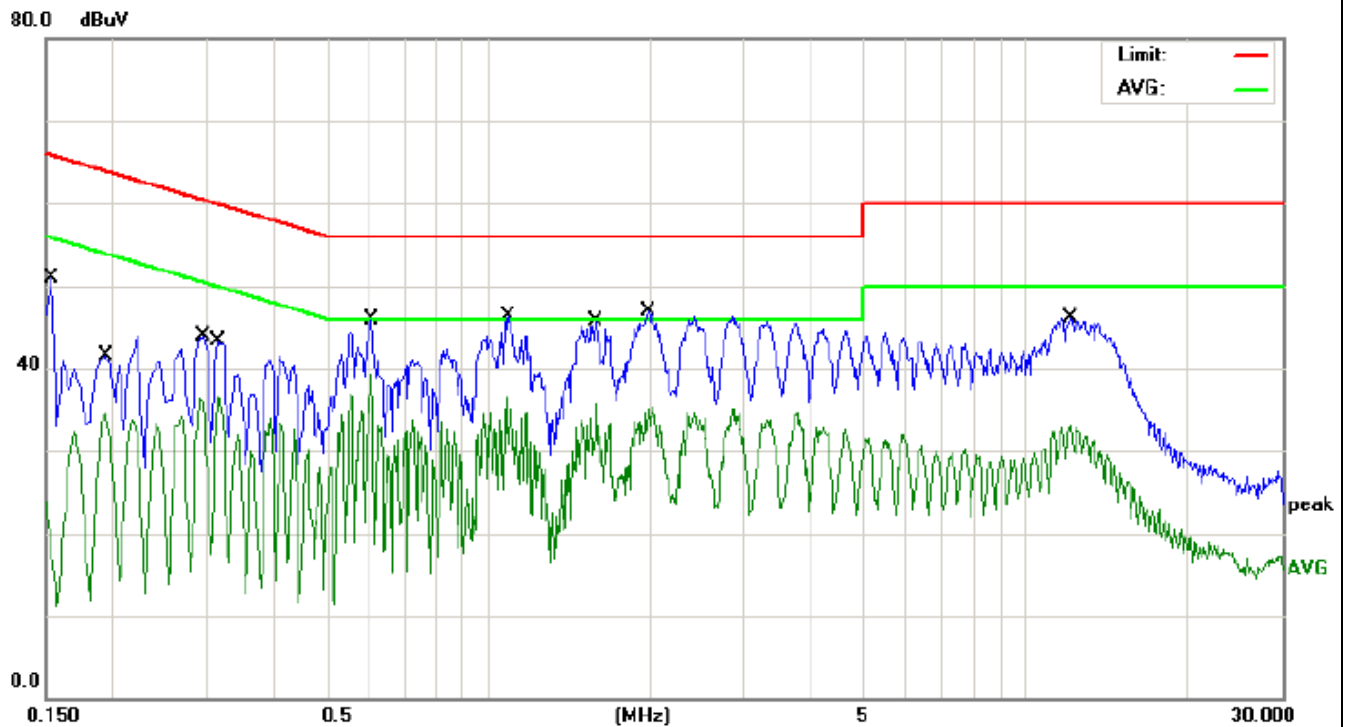

No.	Mk.	Freq. MHz	Reading Level dBuV	Correct Factor dB	Measure- ment dBuV	Limit dBuV	Over dB	Detector
1		0.1539	40.46	10.44	50.90	65.78	-14.88	QP
2		0.1940	24.15	10.43	34.58	53.86	-19.28	AVG
3		0.2940	33.42	10.42	43.84	60.41	-16.57	QP
4		0.3140	26.14	10.42	36.56	49.86	-13.30	AVG
5		0.6060	35.54	10.39	45.93	56.00	-10.07	QP
6	*	0.6060	28.82	10.39	39.21	46.00	-6.79	AVG
7		1.0820	26.21	10.34	36.55	46.00	-9.45	AVG
8		1.0900	36.02	10.34	46.36	56.00	-9.64	QP
9		1.5859	25.45	10.31	35.76	46.00	-10.24	AVG
10		1.9860	36.53	10.29	46.82	56.00	-9.18	QP
11		12.1140	22.94	10.17	33.11	50.00	-16.89	AVG
12		12.1380	35.97	10.17	46.14	60.00	-13.86	QP

EUT	Mobile phone	Model Name	X557
Temperature	26 °C	Relative Humidity	54%
Pressure	1010hPa	Phase	N
Test Date	August 22, 2016	Test Mode	Mode 1

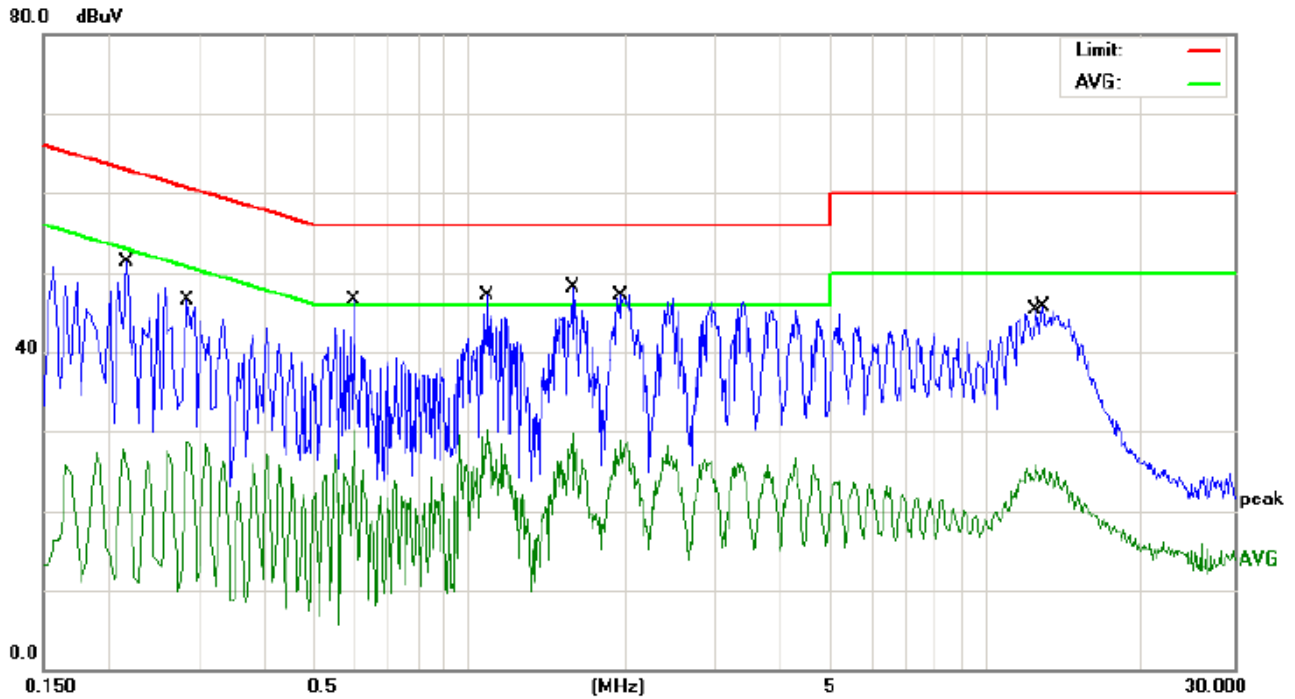

No.	Mk.	Freq. MHz	Reading Level dBuV	Correct Factor dB	Measure- ment dBuV	Limit dBuV	Over dB	Detector
1		0.2180	36.70	10.43	47.13	62.89	-15.76	QP
2		0.2860	18.31	10.42	28.73	50.64	-21.91	AVG
3		0.5980	31.86	10.39	42.25	56.00	-13.75	QP
4		0.5980	19.74	10.39	30.13	46.00	-15.87	AVG
5		1.0859	32.82	10.34	43.16	56.00	-12.84	QP
6		1.0859	19.91	10.34	30.25	46.00	-15.75	AVG
7	*	1.5780	33.61	10.31	43.92	56.00	-12.08	QP
8		1.5780	19.39	10.31	29.70	46.00	-16.30	AVG
9		1.9660	32.32	10.29	42.61	56.00	-13.39	QP
10		1.9660	18.60	10.29	28.89	46.00	-17.11	AVG
11		12.4420	15.58	10.17	25.75	50.00	-24.25	AVG
12		12.8100	31.59	10.17	41.76	60.00	-18.24	QP

EUT	Mobile phone	Model Name	X557
Temperature	26 °C	Relative Humidity	54%
Pressure	1010hPa	Phase	L
Test Date	August 22, 2016	Test Mode	Mode 2

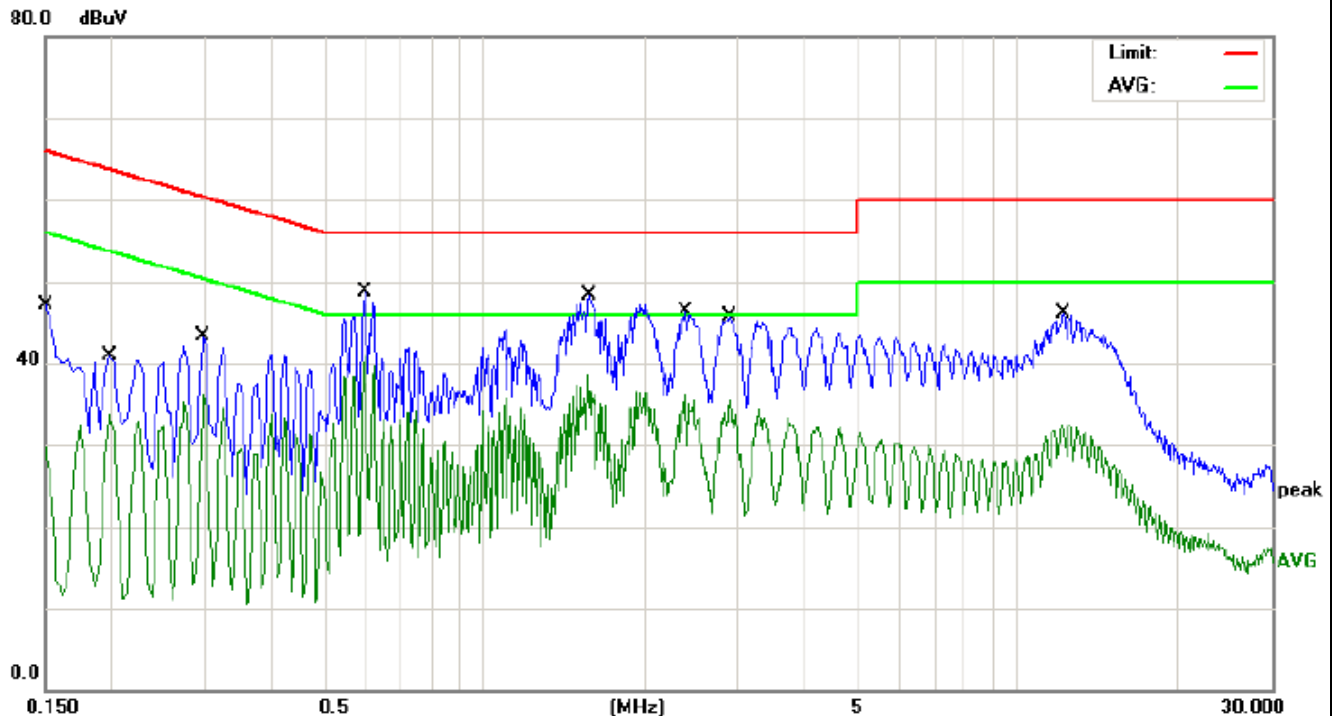

No.	Mk.	Freq. MHz	Reading Level dBuV	Correct Factor dB	Measure- ment dBuV	Limit dBuV	Over dB	Detector
1		0.1516	35.79	10.44	46.23	65.91	-19.68	QP
2		0.1980	23.20	10.43	33.63	53.69	-20.06	AVG
3		0.2980	32.93	10.42	43.35	60.30	-16.95	QP
4		0.2980	25.63	10.42	36.05	50.30	-14.25	AVG
5		0.5980	38.33	10.39	48.72	56.00	-7.28	QP
6	*	0.5980	30.57	10.39	40.96	46.00	-5.04	AVG
7		1.5660	28.28	10.31	38.59	46.00	-7.41	AVG
8		1.5700	37.97	10.31	48.28	56.00	-7.72	QP
9		2.3900	25.77	10.28	36.05	46.00	-9.95	AVG
10		2.8860	35.36	10.27	45.63	56.00	-10.37	QP
11		12.1180	22.23	10.17	32.40	50.00	-17.60	AVG
12		12.1940	35.99	10.17	46.16	60.00	-13.84	QP

EUT	Mobile phone	Model Name	X557
Temperature	26 °C	Relative Humidity	54%
Pressure	1010hPa	Phase	N
Test Date	August 22, 2016	Test Mode	Mode 2

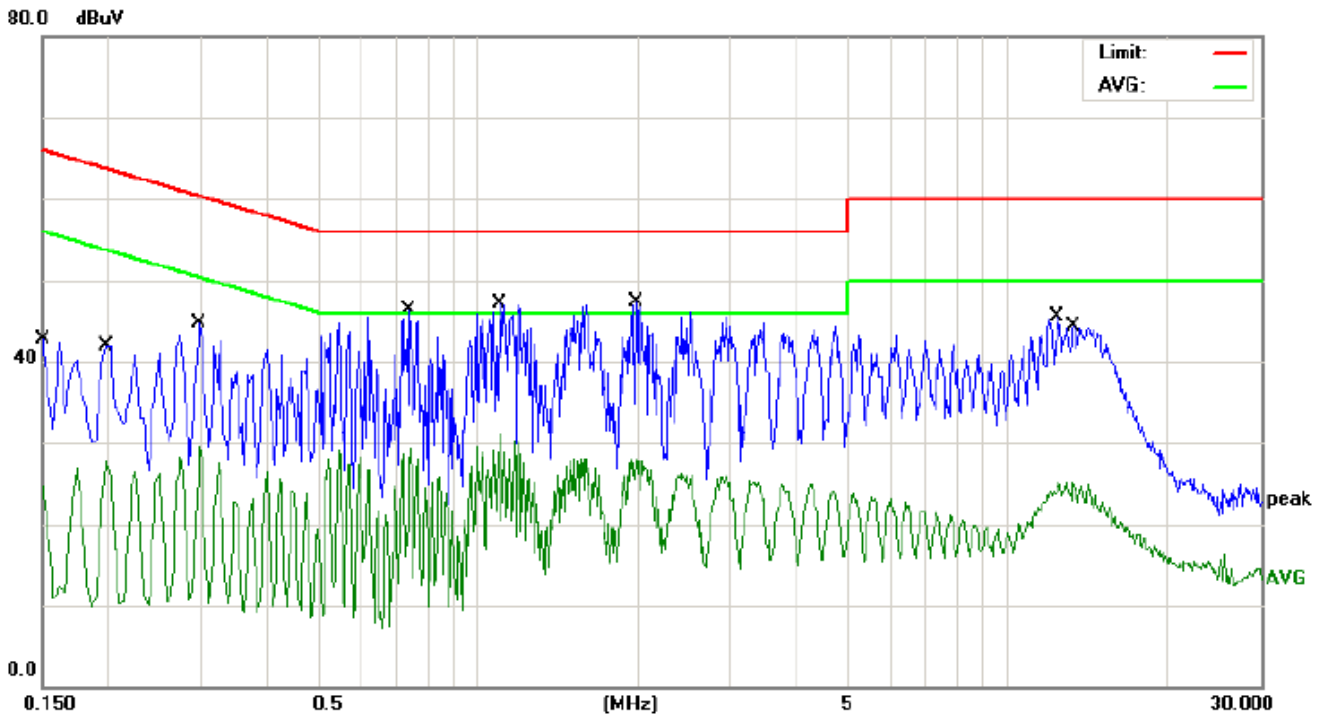

No.	Mk.	Freq. MHz	Reading Level dBuV	Correct Factor dB	Measure- ment dBuV	Limit dBuV	Over dB	Detector
1		0.1500	32.20	10.44	42.64	65.99	-23.35	QP
2		0.1980	17.28	10.43	27.71	53.69	-25.98	AVG
3		0.2980	34.23	10.42	44.65	60.30	-15.65	QP
4		0.2980	19.00	10.42	29.42	50.30	-20.88	AVG
5		0.7420	35.89	10.37	46.26	56.00	-9.74	QP
6		0.7460	18.93	10.37	29.30	46.00	-16.70	AVG
7		1.0940	36.76	10.34	47.10	56.00	-8.90	QP
8		1.0940	20.67	10.34	31.01	46.00	-14.99	AVG
9	*	1.9900	37.04	10.29	47.33	56.00	-8.67	QP
10		1.9900	17.69	10.29	27.98	46.00	-18.02	AVG
11		12.4020	35.34	10.17	45.51	60.00	-14.49	QP
12		13.2580	14.94	10.16	25.10	50.00	-24.90	AVG

EUT	Mobile phone	Model Name	X557
Temperature	26 °C	Relative Humidity	54%
Pressure	1010hPa	Phase	L
Test Date	August 22, 2016	Test Mode	Mode 3

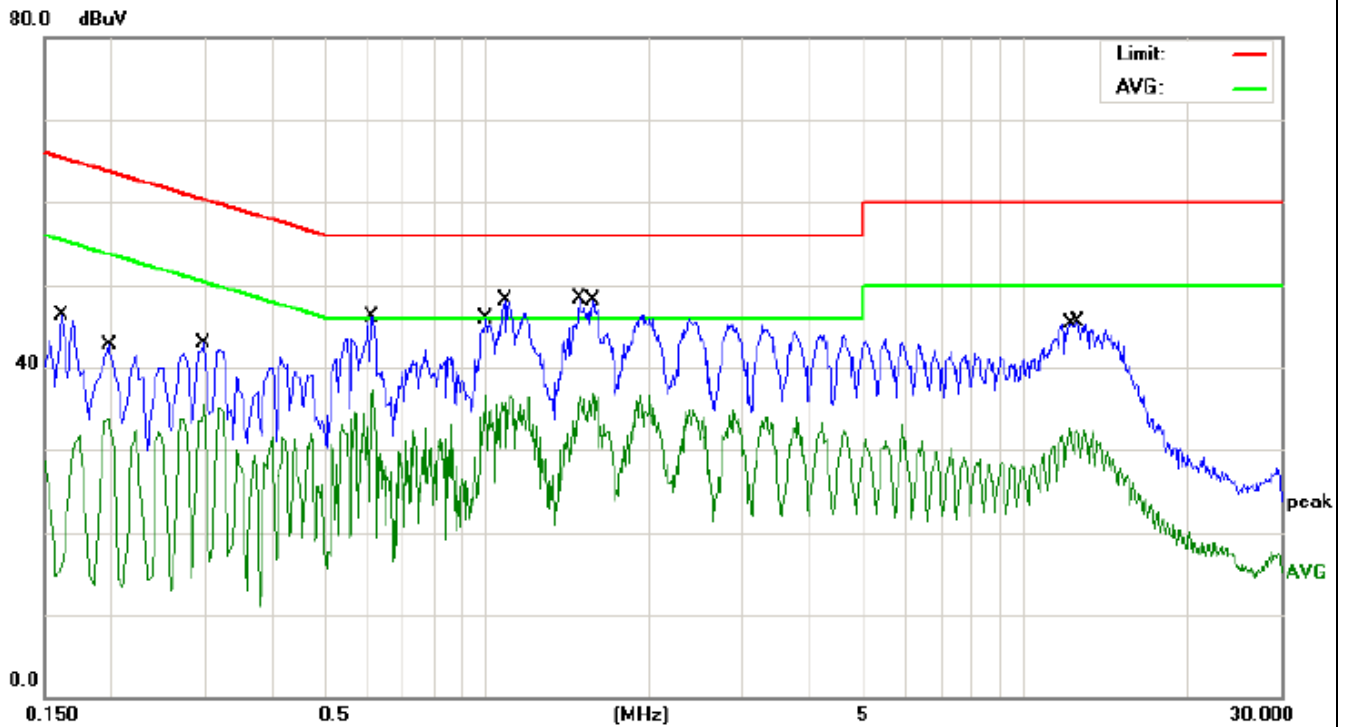

No.	Mk.	Freq. MHz	Reading Level dBuV	Correct Factor dB	Measure- ment dBuV	Limit dBuV	Over dB	Detector
1		0.1620	35.76	10.44	46.20	65.36	-19.16	QP
2		0.1980	23.30	10.43	33.73	53.69	-19.96	AVG
3		0.2980	32.50	10.42	42.92	60.30	-17.38	QP
4		0.2980	25.03	10.42	35.45	50.30	-14.85	AVG
5		0.6100	35.68	10.39	46.07	56.00	-9.93	QP
6		0.6140	26.94	10.39	37.33	46.00	-8.67	AVG
7		0.9980	26.30	10.34	36.64	46.00	-9.36	AVG
8		1.0820	37.80	10.34	48.14	56.00	-7.86	QP
9	*	1.4819	37.94	10.32	48.26	56.00	-7.74	QP
10		1.5740	26.51	10.31	36.82	46.00	-9.18	AVG
11		12.1540	22.59	10.17	32.76	50.00	-17.24	AVG
12		12.5820	35.25	10.17	45.42	60.00	-14.58	QP

EUT	Mobile phone	Model Name	X557
Temperature	26 °C	Relative Humidity	54%
Pressure	1010hPa	Phase	N
Test Date	August 22, 2016	Test Mode	Mode 3

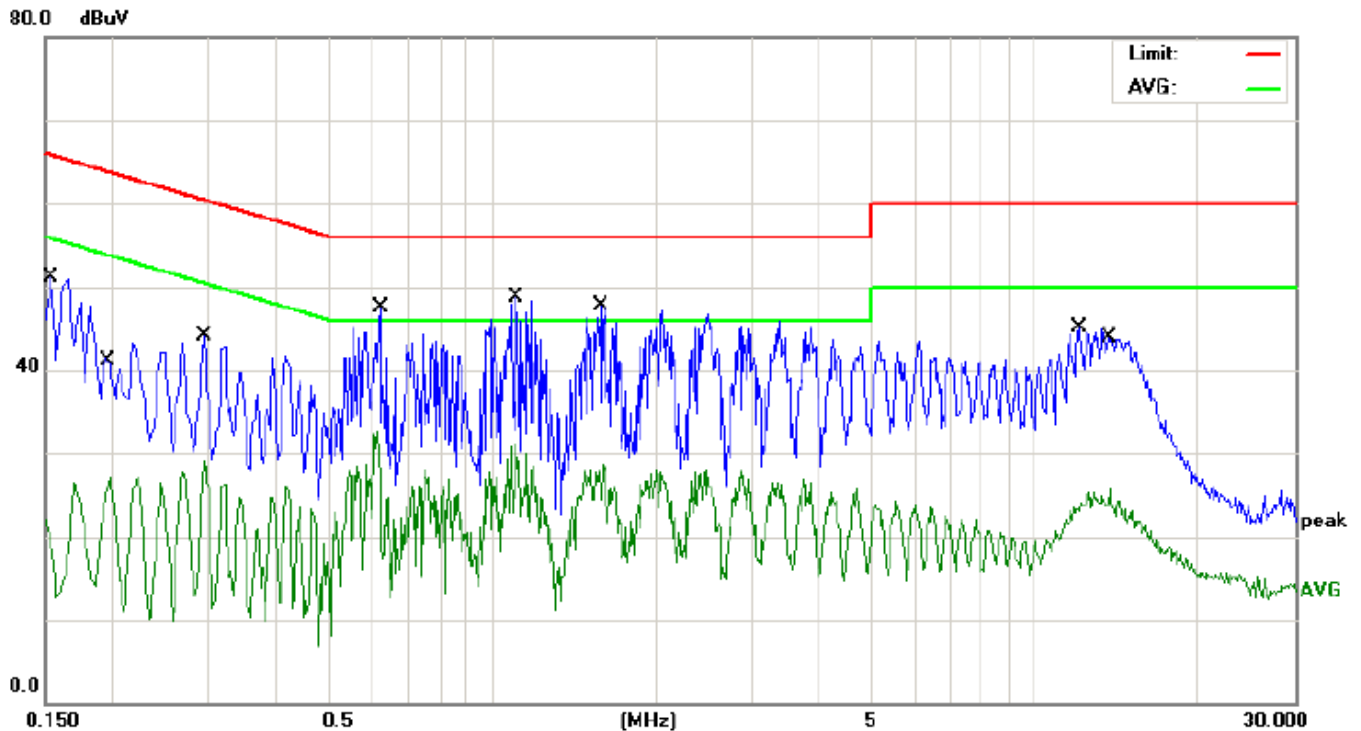

No.	Mk.	Freq. MHz	Reading Level dBuV	Correct Factor dB	Measure- ment dBuV	Limit dBuV	Over dB	Detector
1		0.1539	40.59	10.44	51.03	65.78	-14.75	QP
2		0.1980	16.67	10.43	27.10	53.69	-26.59	AVG
3		0.2940	33.75	10.42	44.17	60.41	-16.24	QP
4		0.2940	18.74	10.42	29.16	50.41	-21.25	AVG
5		0.6140	22.40	10.39	32.79	46.00	-13.21	AVG
6		0.6220	37.04	10.39	47.43	56.00	-8.57	QP
7	*	1.1060	38.39	10.33	48.72	56.00	-7.28	QP
8		1.1060	20.72	10.33	31.05	46.00	-14.95	AVG
9		1.5820	37.46	10.31	47.77	56.00	-8.23	QP
10		1.5980	18.33	10.31	28.64	46.00	-17.36	AVG
11		12.0380	34.95	10.17	45.12	60.00	-14.88	QP
12		13.7300	15.54	10.16	25.70	50.00	-24.30	AVG

5.2 RADIATED EMISSION MEASUREMENT

5.2.1 RADIATED EMISSION LIMITS (Frequency Range 9kHz-1000MHz)

20dBc in any 100 kHz bandwidth outside the operating frequency band. In case the emission fall within the restricted band specified on 15.205(a), then the 15.209(a) limit in the table below has to be followed.

Frequencies (MHz)	Field Strength (micorvolts/meter)	Measurement Distance (meters)
0.009~0.490	2400/F(KHz)	300
0.490~1.705	24000/F(KHz)	30
1.705~30.0	30	30
30~88	100	3
88~216	150	3
216~960	200	3
Above 960	500	3

LIMITS OF RADIATED EMISSION MEASUREMENT (Above 1000MHz)

FREQUENCY (MHz)	Limit (dBuV/m) (at 3M)	
	PEAK	AVERAGE
Above 1000	74	54

Notes:

- (1) The limit for radiated test was performed according to FCC PART 15C.
- (2) The tighter limit applies at the band edges.
- (3) Emission level (dBuV/m)=20log Emission level (uV/m).

Spectrum Parameter	Setting
Attenuation	Auto
Start Frequency	1000 MHz
Stop Frequency	10th carrier harmonic
RB / VB (emission in restricted band)	1 MHz / 1 MHz for Peak, 1 MHz / 1Hz for Average

Receiver Parameter	Setting
Attenuation	Auto
Start ~ Stop Frequency	9kHz~150kHz / RB 200Hz for QP
Start ~ Stop Frequency	150kHz~30MHz / RB 9kHz for QP
Start ~ Stop Frequency	30MHz~1000MHz / RB 120kHz for QP

5.2.2 TEST PROCEDURE

- a. The measuring distance of at 3 m shall be used for measurements at frequency up to 1GHz. For frequencies above 1GHz, any suitable measuring distance may be used.
- b. The EUT was placed on the top of a rotating table 0.8 meters above the ground at a 3 meter open area test site. The table was rotated 360 degrees to determine the position of the highest radiation.
- c. The height of the equipment or of the substitution antenna shall be 0.8 m; the height of the test antenna shall vary between 1 m to 4 m. Both horizontal and vertical polarizations of the antenna are set to make the measurement.
- d. The initial step in collecting conducted emission data is a spectrum analyzer peak detector mode pre-scanning the measurement frequency range. Significant peaks are then marked and then Quasi Peak detector mode re-measured.
- e. If the Peak Mode measured value compliance with and lower than Quasi Peak Mode Limit, the EUT shall be deemed to meet QP Limits and then no additional QP Mode measurement performed.
- f. For the actual test configuration, please refer to the related Item –EUT Test Photos.

Note:

Both horizontal and vertical antenna polarities were tested and performed pretest to three orthogonal axis. The worst case emissions were reported

5.2.3 DEVIATION FROM TEST STANDARD

No deviation

5.2.4 TEST SETUP

(A) Radiated Emission Test-Up Frequency 30MHz~1GHz

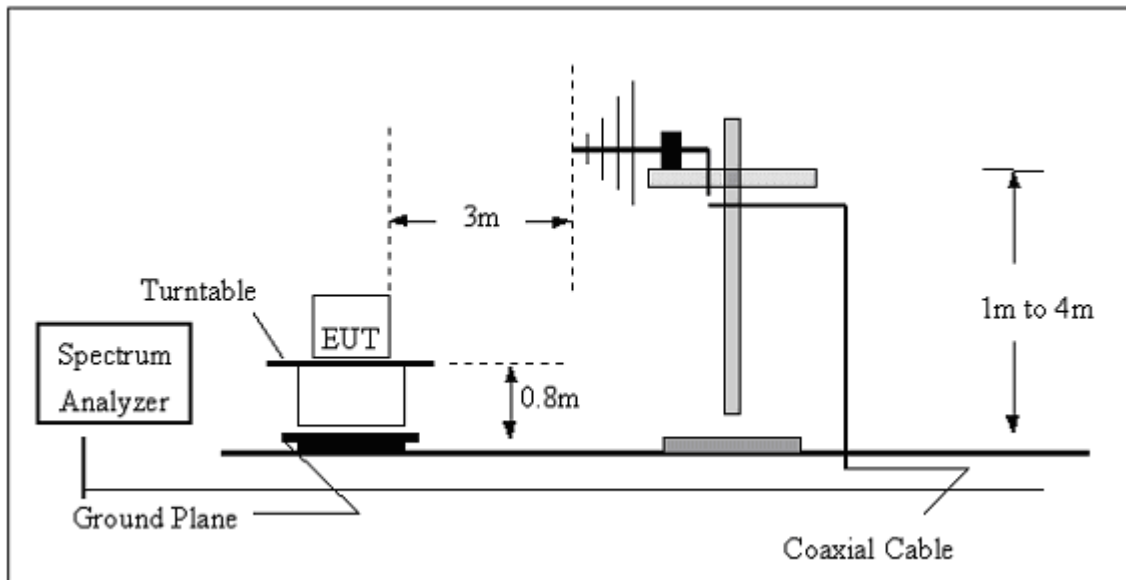

(B) Radiated Emission Test-Up Frequency Above 1GHz

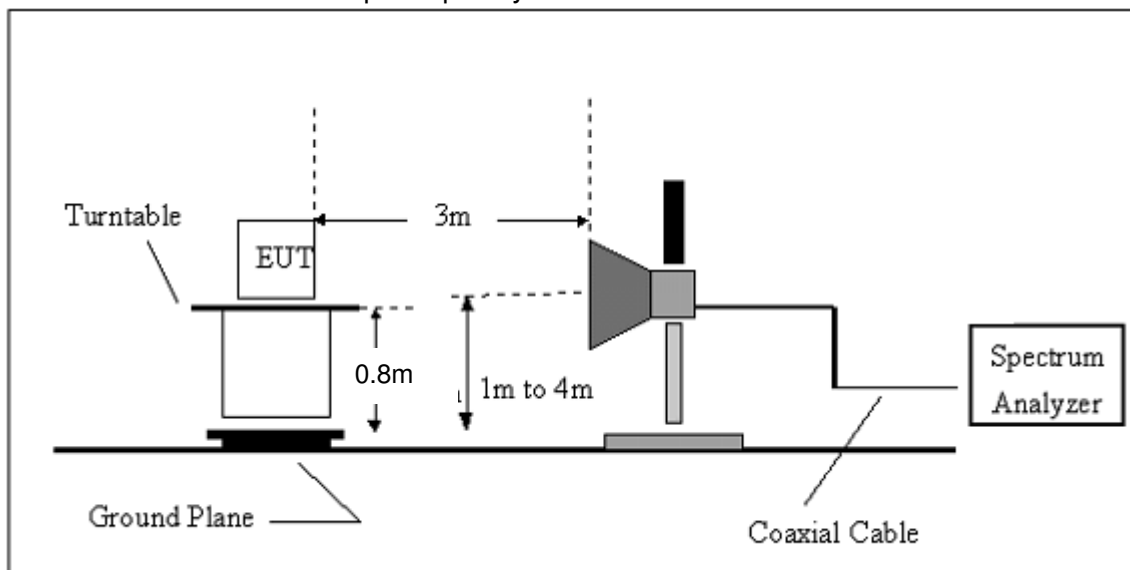

5.2.5 EUT OPERATING CONDITIONS

The EUT tested system was configured as the statements of 2.4 Unless otherwise a special operating condition is specified in the follows during the testing.

5.2.5.1 TEST RESULTS (BETWEEN 30M – 1000 MHZ)

EUT	Mobile phone	Model Name	X557
Temperature	20 °C	Relative Humidity	48%
Pressure	1010 hPa	Polarization :	Horizontal
Test Mode	Mode 1	Test Date	August 22, 2016

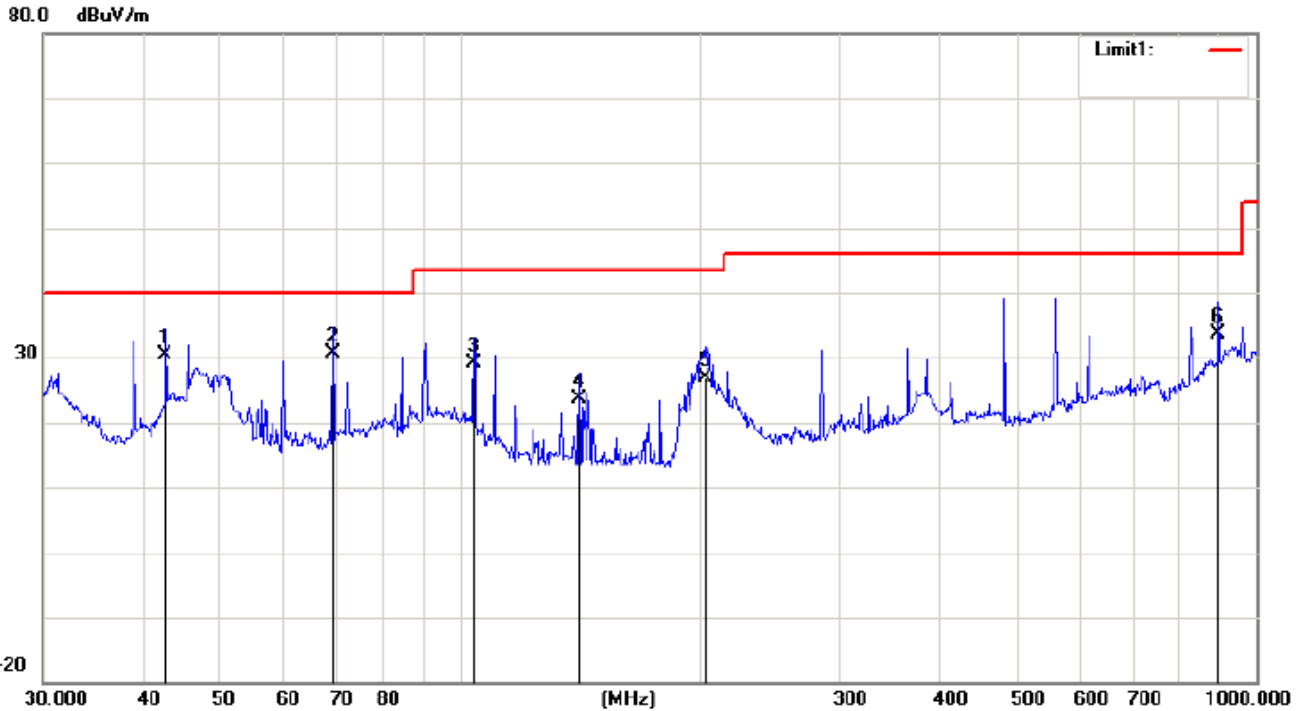

No.	Mk.	Freq. MHz	Reading Level dBuV	Correct Factor dB	Measure- ment dBuV/m	Limit dBuV/m	Over dB	Detector
1		42.7496	35.79	-5.39	30.40	40.00	-9.60	QP
2	*	69.3568	38.61	-7.95	30.66	40.00	-9.34	QP
3		104.1701	34.29	-5.18	29.11	43.50	-14.39	QP
4		141.3298	26.83	-3.16	23.67	43.50	-19.83	QP
5		203.5228	31.92	-4.95	26.97	43.50	-16.53	QP
6		896.9965	27.96	5.59	33.55	46.00	-12.45	QP

EUT	Mobile phone	Model Name	X557
Temperature	20 °C	Relative Humidity	48%
Pressure	1010 hPa	Polarization :	Vertical
Test Mode	Mode 1	Test Date	August 22, 2016

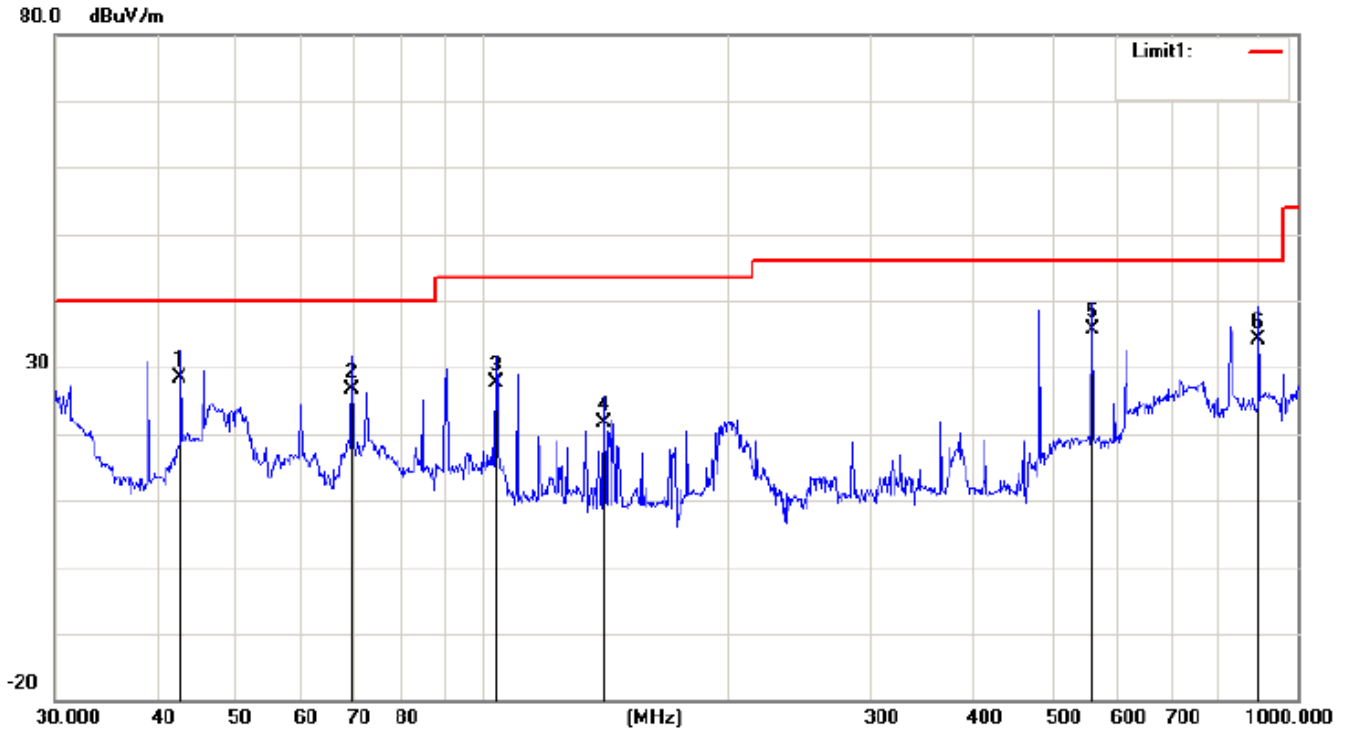

No.	Mk.	Freq. MHz	Reading Level dBuV	Correct Factor dB	Measure- ment dBuV/m	Limit dBuV/m	Over dB	Detector
1		42.7496	33.79	-5.39	28.40	40.00	-11.60	QP
2		69.3568	34.61	-7.95	26.66	40.00	-13.34	QP
3		104.1701	32.79	-5.18	27.61	43.50	-15.89	QP
4		141.3298	24.72	-3.16	21.56	43.50	-21.94	QP
5	*	560.6928	35.30	0.34	35.64	46.00	-10.36	QP
6		896.9965	28.46	5.59	34.05	46.00	-11.95	QP

EUT	Mobile phone	Model Name	X557
Temperature	20 °C	Relative Humidity	48%
Pressure	1010 hPa	Polarization :	Horizontal
Test Mode	Mode 2	Test Date	August 22, 2016

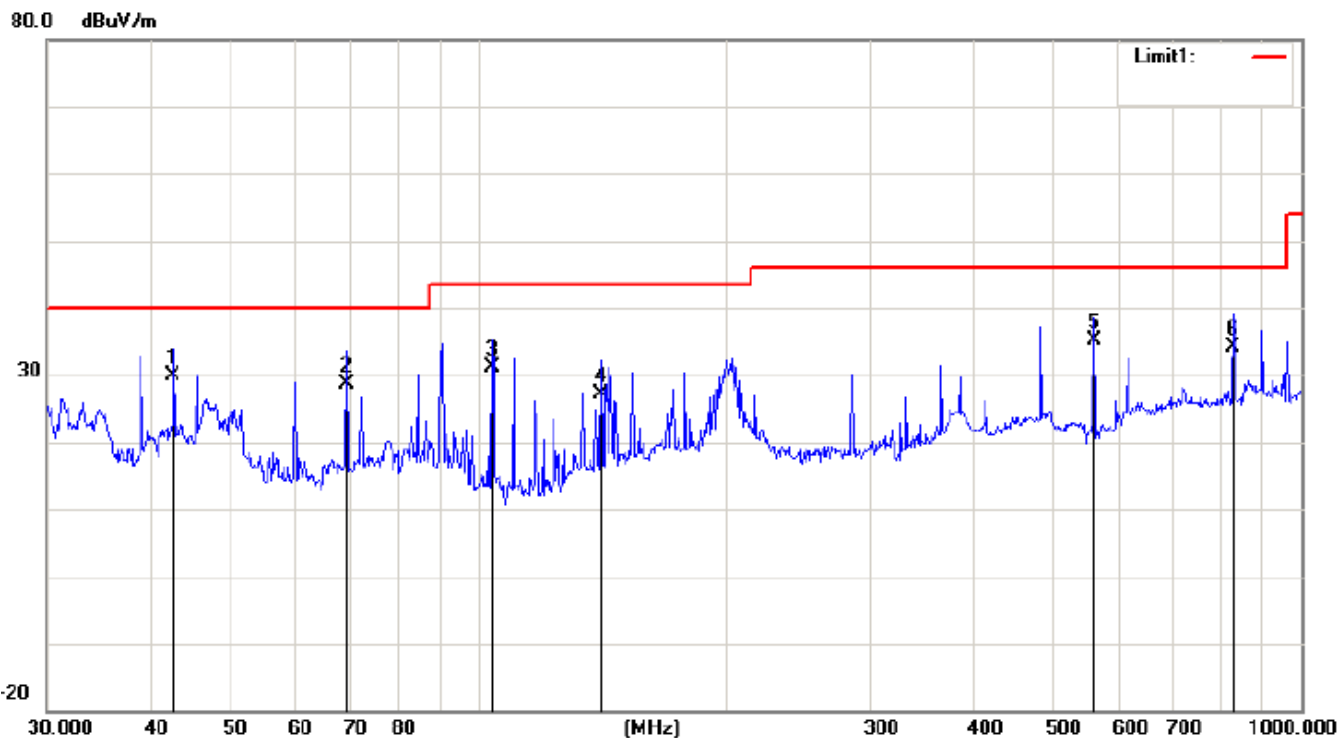

No.	Mk.	Freq. MHz	Reading Level dBuV	Correct Factor dB	Measure- ment dBuV/m	Limit dBuV/m	Over dB	Detect
1	*	42.7496	35.29	-5.39	29.90	40.00	-10.10	QP
2		69.3568	36.61	-7.95	28.66	40.00	-11.34	QP
3		104.1701	36.35	-5.18	31.17	43.50	-12.33	QP
4		141.3298	30.35	-3.16	27.19	43.50	-16.31	QP
5		560.6928	34.72	0.34	35.06	46.00	-10.94	QP
6		827.4934	28.96	5.18	34.14	46.00	-11.86	QP

EUT	Mobile phone	Model Name	X557
Temperature	20 °C	Relative Humidity	48%
Pressure	1010 hPa	Polarization :	Vertical
Test Mode	Mode 2	Test Date	August 22, 2016

90.0 dBuV/m

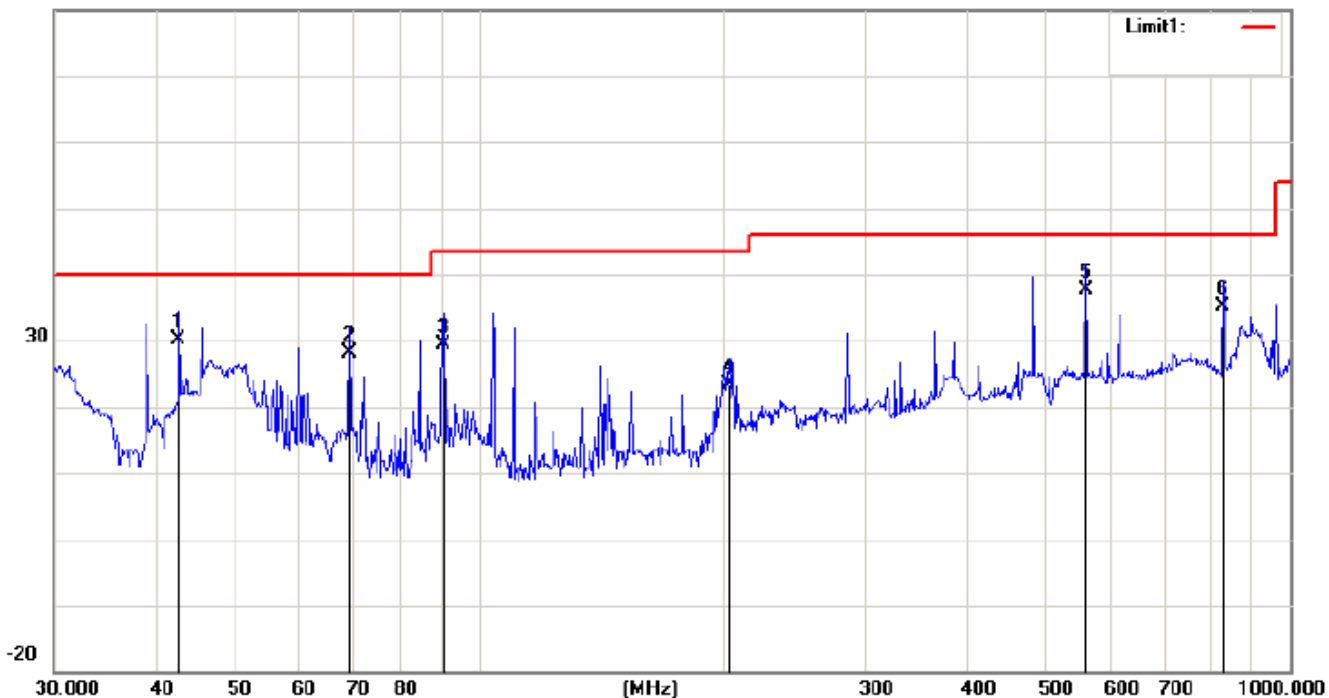

No.	Mk.	Freq. MHz	Reading Level dBuV	Correct Factor dB	Measure- ment dBuV/m	Limit dBuV/m	Over dB	Detector
1		42.7496	35.43	-5.39	30.04	40.00	-9.96	QP
2		69.3568	36.11	-7.95	28.16	40.00	-11.84	QP
3		90.5374	37.26	-7.92	29.34	43.50	-14.16	QP
4		203.5228	28.22	-4.95	23.27	43.50	-20.23	QP
5	*	560.6928	37.30	0.34	37.64	46.00	-8.36	QP
6		827.4934	29.96	5.18	35.14	46.00	-10.86	QP

EUT	Mobile phone	Model Name	X557
Temperature	20 °C	Relative Humidity	48%
Pressure	1010 hPa	Polarization :	Horizontal
Test Mode	Mode 3	Test Date	August 22, 2016

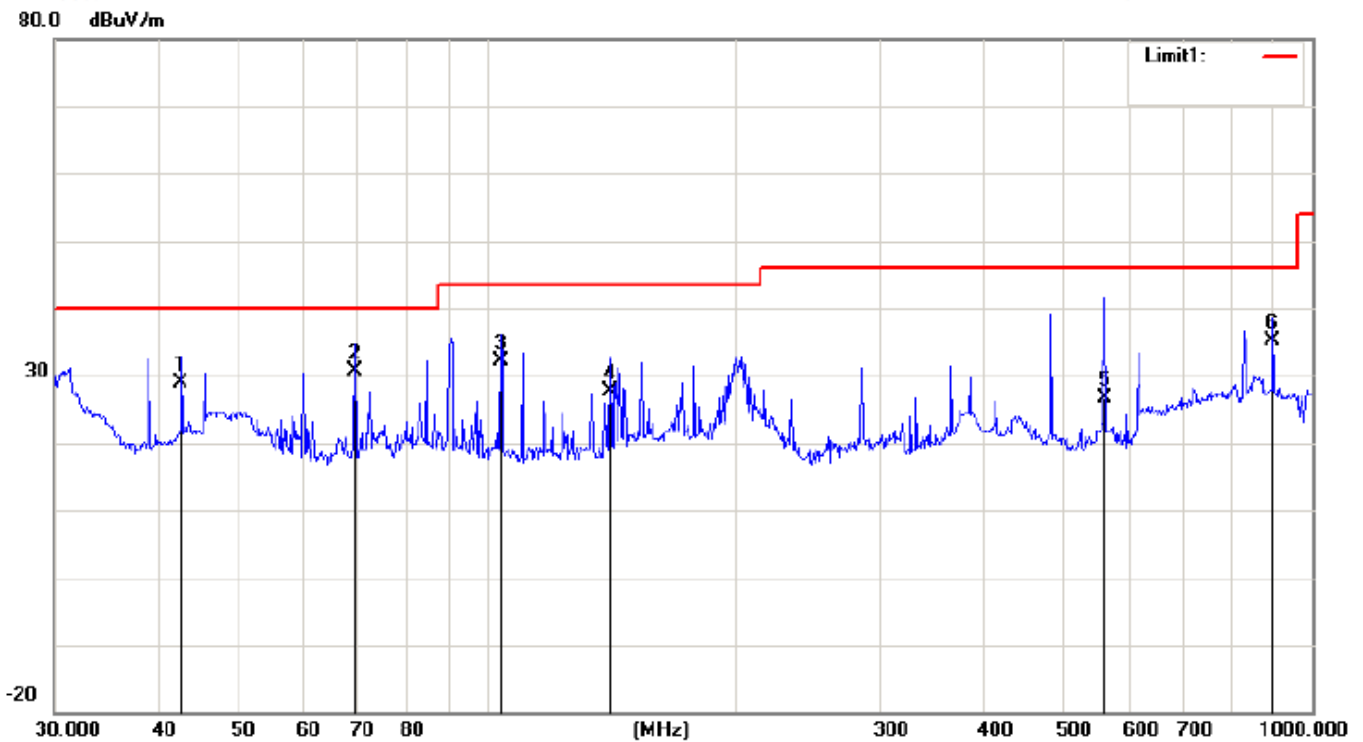

No.	Mk.	Freq. MHz	Reading Level dBuV	Correct Factor dB	Measure- ment dBuV/m	Limit dBuV/m	Over dB	Detector	A
1		42.7496	34.35	-5.39	28.96	40.00	-11.04	QP	
2	*	69.3568	38.61	-7.95	30.66	40.00	-9.34	QP	
3		104.1701	37.29	-5.18	32.11	43.50	-11.39	QP	
4		141.3298	30.83	-3.16	27.67	43.50	-15.83	QP	
5		560.6928	26.41	0.34	26.75	46.00	-19.25	QP	
6		896.9965	29.53	5.59	35.12	46.00	-10.88	QP	

EUT	Mobile phone	Model Name	X557
Temperature	20 °C	Relative Humidity	48%
Pressure	1010 hPa	Polarization :	Vertical
Test Mode	Mode 3	Test Date	August 22, 2016

80.0 dBuV/m

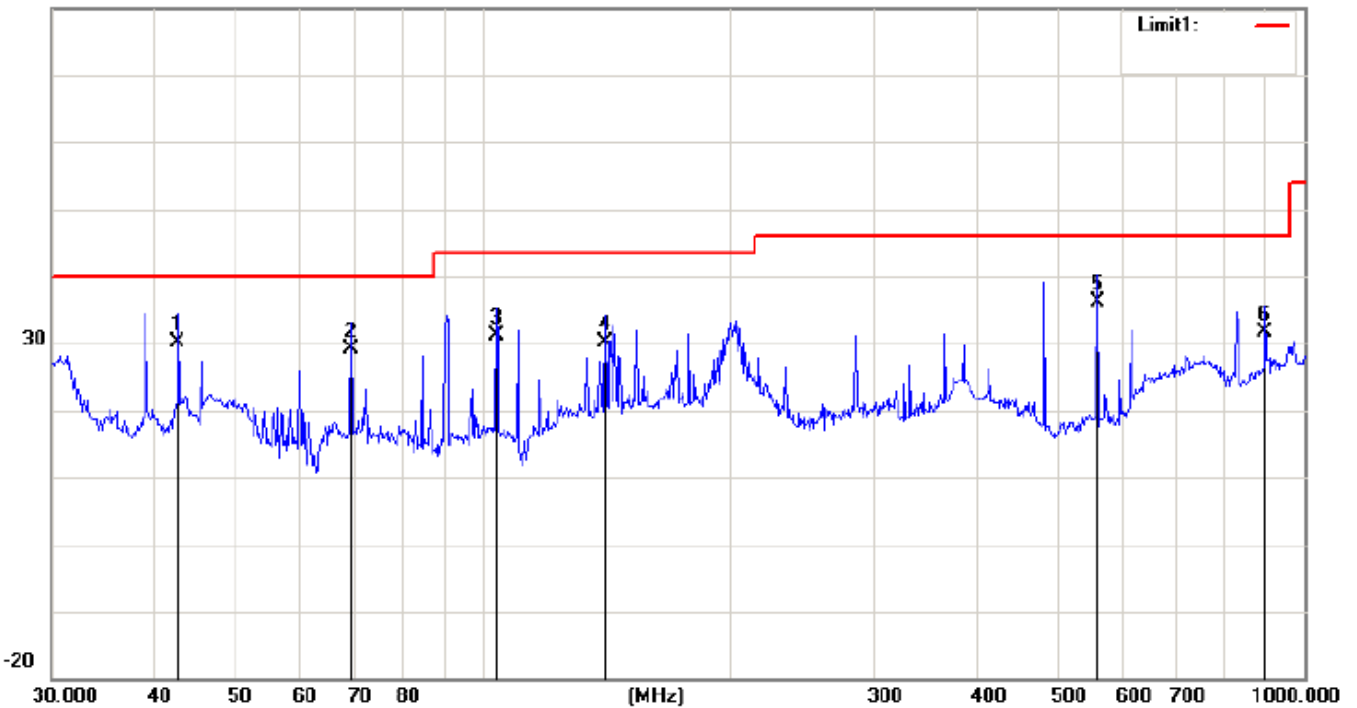

No.	Mk.	Freq. MHz	Reading Level dBuV	Correct Factor dB	Measure- ment dBuV/m	Limit dBuV/m	Over dB	Detector
1		42.7496	35.43	-5.39	30.04	40.00	-9.96	QP
2		69.3568	37.11	-7.95	29.16	40.00	-10.84	QP
3		104.1701	36.29	-5.18	31.11	43.50	-12.39	QP
4		141.3298	33.33	-3.16	30.17	43.50	-13.33	QP
5	*	560.6928	35.82	0.34	36.16	46.00	-9.84	QP
6		896.9965	25.96	5.59	31.55	46.00	-14.45	QP

5.2.5.2 TEST RESULTS(1GHZ TO 6GHZ)

EUT	Mobile phone	Model Name	X557
Temperature	20 °C	Relative Humidity	48%
Pressure	1010 hPa	Test Mode	Mode 1
Test Date	August 22, 2016		

Freq. (MHz)	Ant. Pol.	Emission Level(dBuV)		Limit 3m(dBuV/m)		Over(dB)	
		PK	AV	PK	AV	PK	AV
1632.45	V	60.03	40.57	74	54	-13.97	-13.43
2829.27	V	59.63	40.43	74	54	-14.37	-13.57
1684.52	H	58.07	39.81	74	54	-15.93	-14.19
2831.6	H	59.97	40.97	74	54	-14.03	-13.03

Remark:

All emissions not reported were more than 20dB below the specified limit or in the noise floor.

Factor = Antenna Factor + Cable Loss – Pre-amplifier.

All the x/y/z orientation has been investigated, and only worst case is presented in this report.

EUT	Mobile phone	Model Name	X557
Temperature	20 °C	Relative Humidity	48%
Pressure	1010 hPa	Test Mode	Mode 2
Test Date	August 22, 2016		

Freq. (MHz)	Ant. Pol.	Emission Level(dBuV)		Limit 3m(dBuV/m)		Over(dB)	
		PK	AV	PK	AV	PK	AV
1583.35	V	59.44	41.55	74	54	-14.56	-12.45
2641.52	V	59.49	40.80	74	54	-14.51	-13.20
1628.42	H	58.62	39.82	74	54	-15.38	-14.18
2810.39	H	58.20	39.20	74	54	-15.80	-14.80

Remark:

All emissions not reported were more than 20dB below the specified limit or in the noise floor.

Factor = Antenna Factor + Cable Loss – Pre-amplifier.

All the x/y/z orientation has been investigated, and only worst case is presented in this report.

EUT	Mobile phone	Model Name	X557
Temperature	20 °C	Relative Humidity	48%
Pressure	1010 hPa	Test Mode	Mode 3
Test Date	August 22, 2016		

Freq. (MHz)	Ant. Pol.	Emission Level(dBuV)		Limit 3m(dBuV/m)		Over(dB)	
		PK	AV	PK	AV	PK	AV
1577.35	V	59.31	40.18	74	54	-14.69	-13.82
2652.38	V	58.42	40.94	74	54	-15.58	-13.06
1699.33	H	59.49	40.41	74	54	-14.51	-13.59
2739.42	H	58.18	39.18	74	54	-15.82	-14.82

Remark:

All emissions not reported were more than 20dB below the specified limit or in the noise floor.

Factor = Antenna Factor + Cable Loss – Pre-amplifier.

All the x/y/z orientation has been investigated, and only worst case is presented in this report.

6. EUT TEST PHOTO

CONDUCTED EMISSION TEST



RADIATED EMISSION TEST

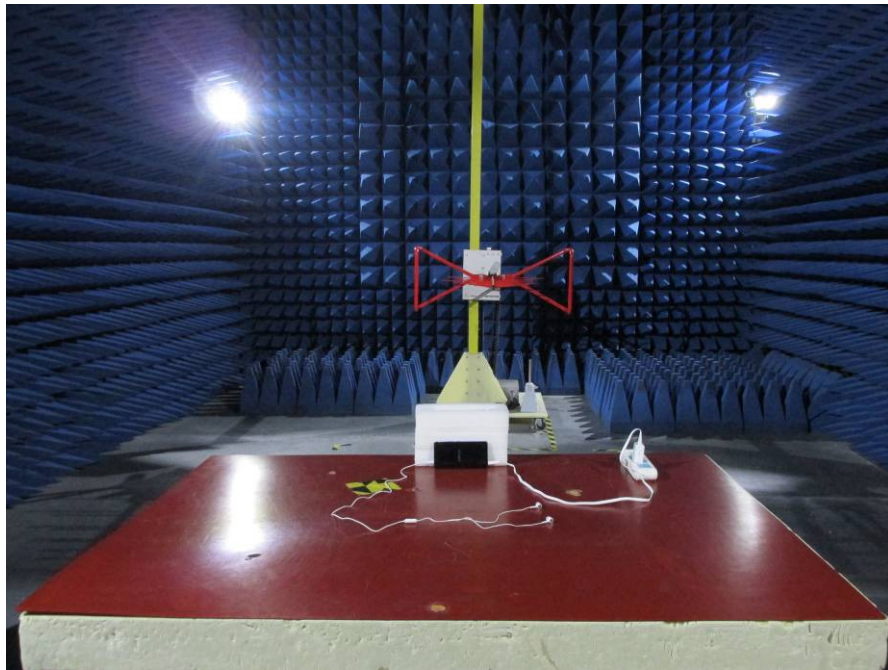

RADIATED EMISSION TEST

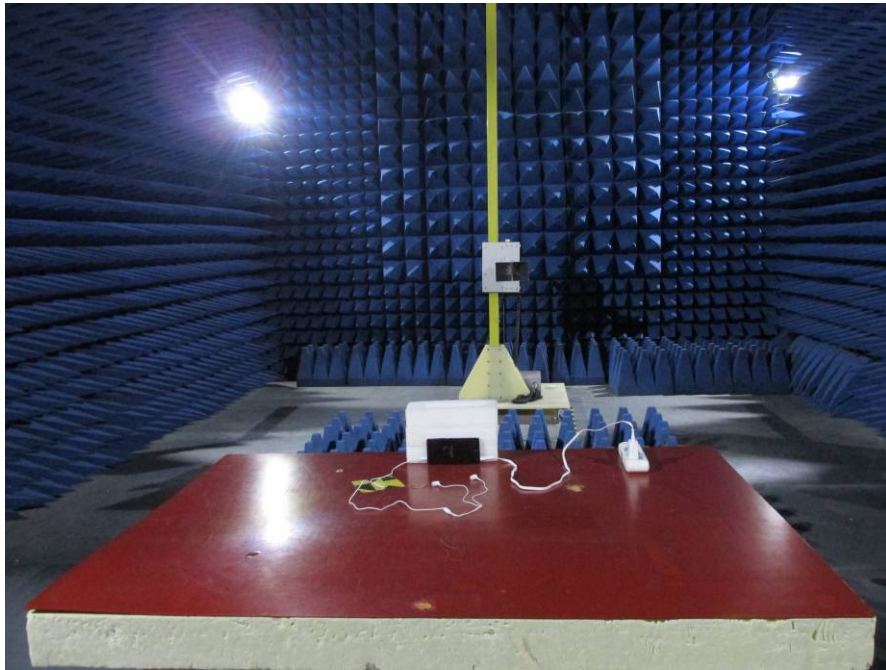

7. PHOTOGRAPHS OF EUT

Appearance photograph of EUT



Appearance photograph of EUT



Appearance photograph of EUT



Appearance photograph of EUT



Appearance photograph of EUT



Appearance photograph of EUT

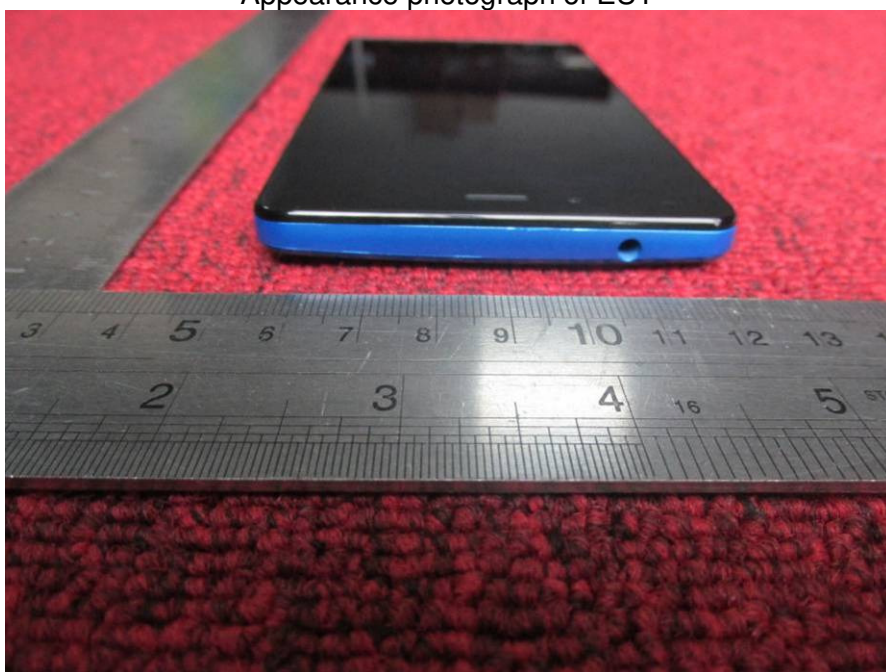

Appearance photograph of EUT

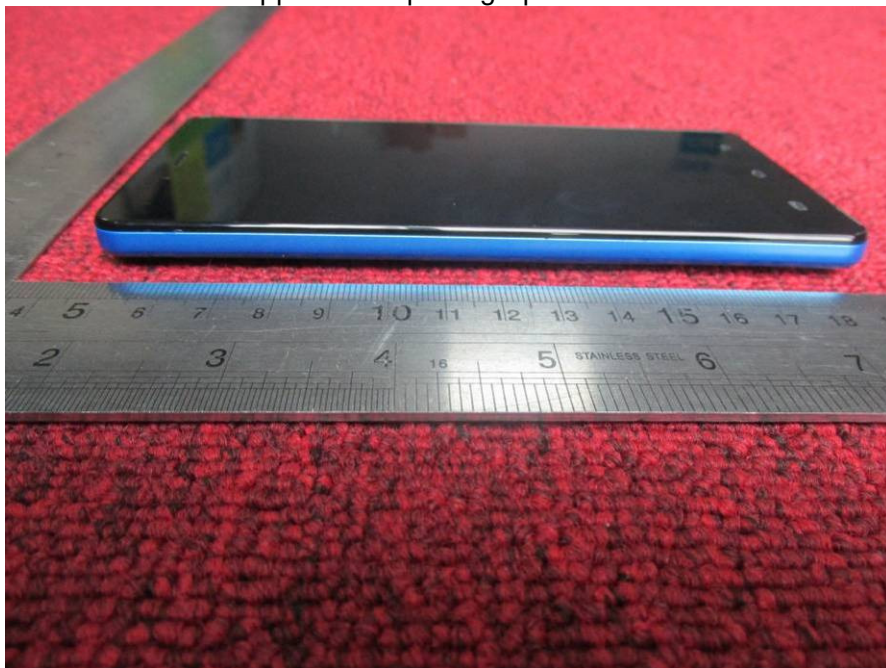

Appearance photograph of EUT



Internal photograph of EUT

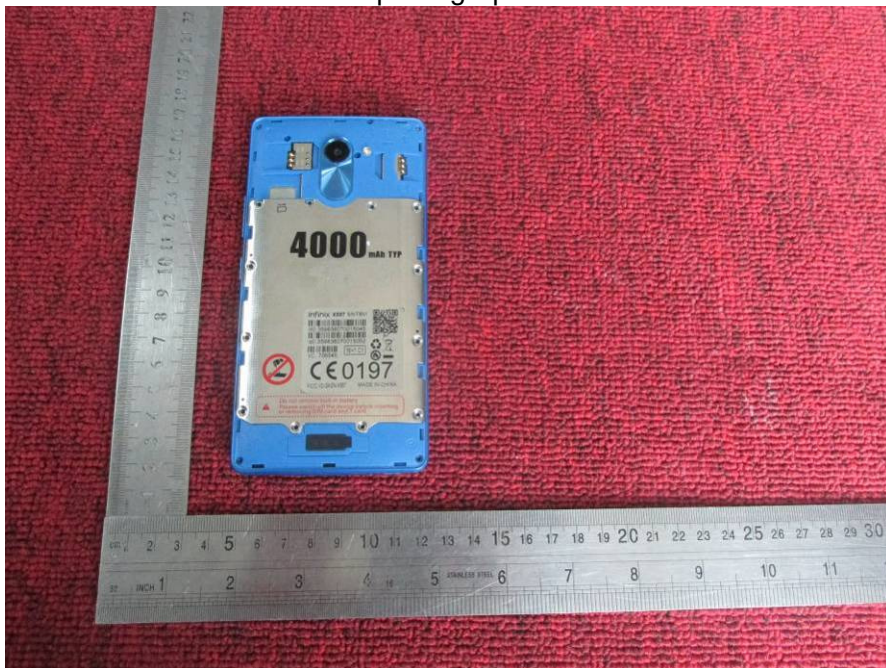

Internal photograph of EUT

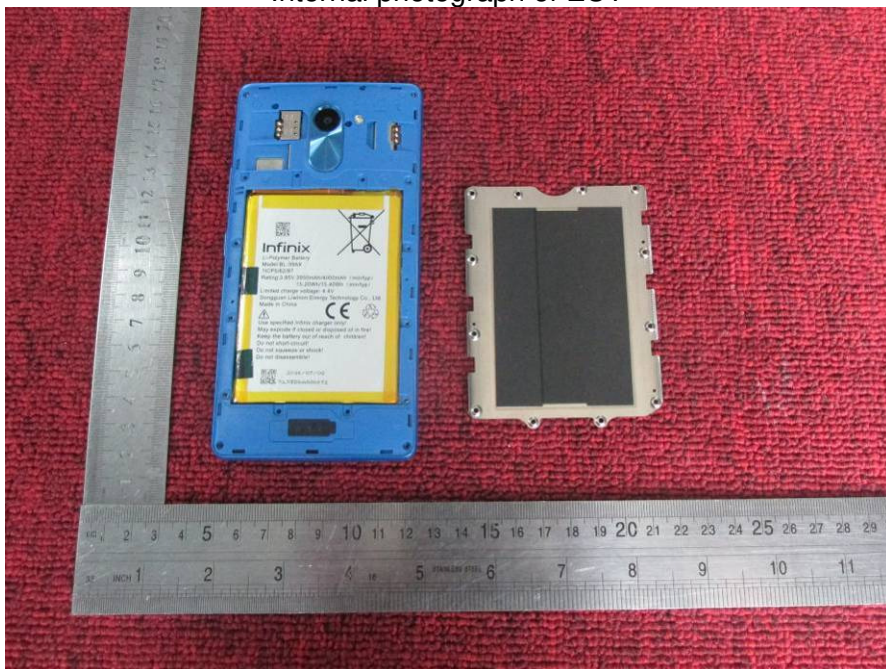

Internal photograph of EUT



Internal photograph of EUT

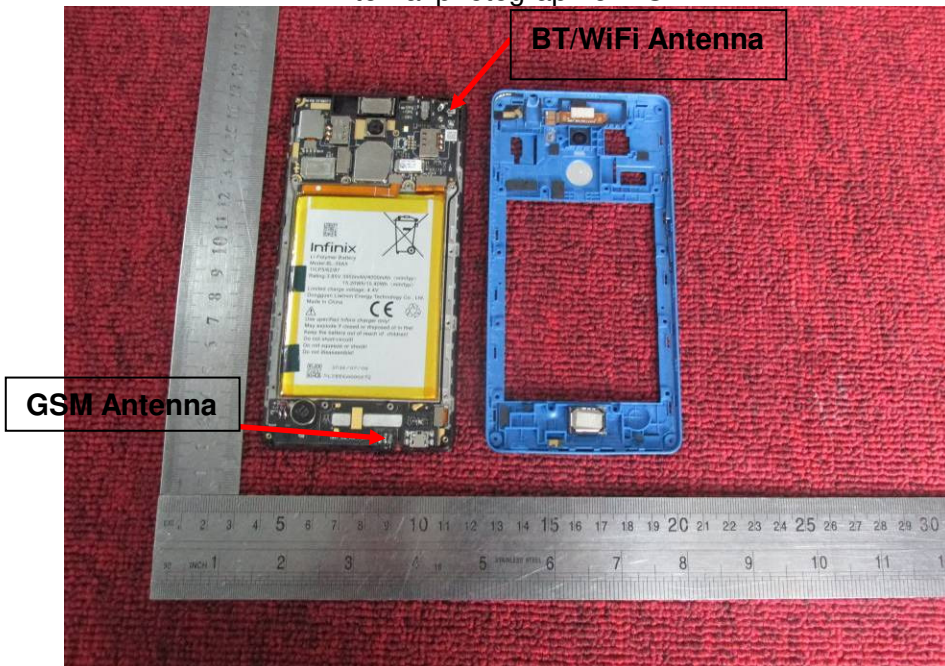

Internal photograph of EUT

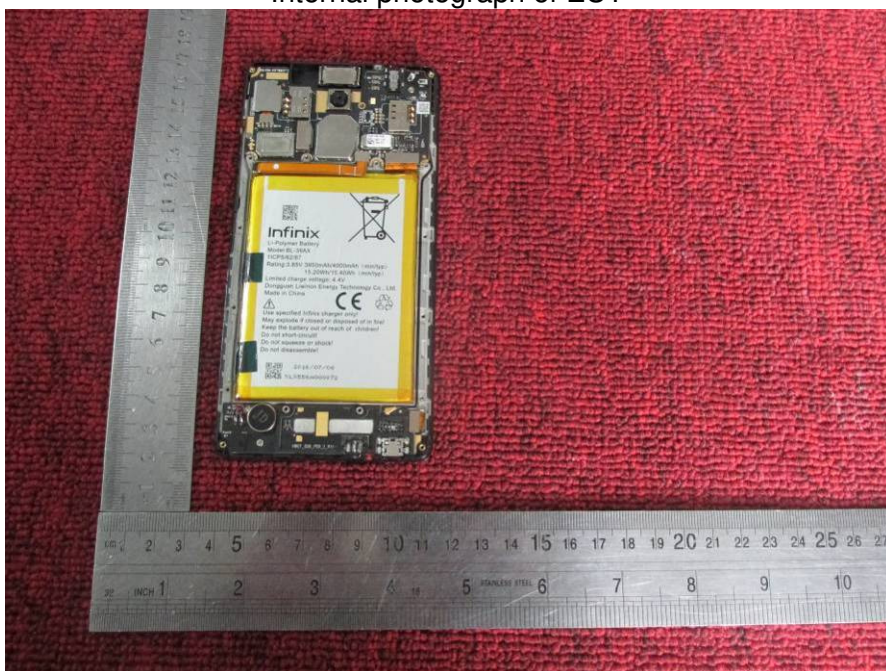

Internal photograph of EUT



Internal photograph of EUT

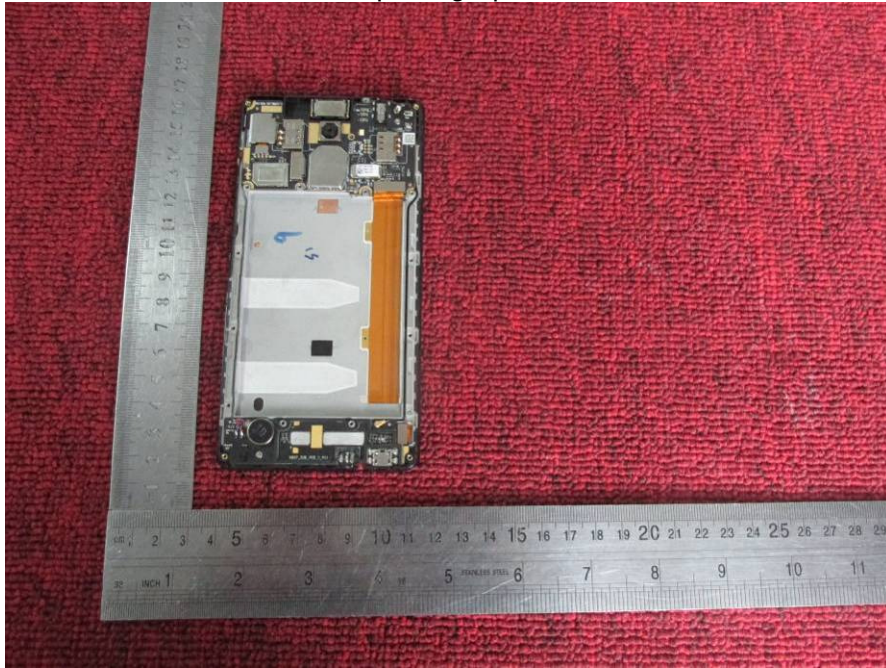

Internal photograph of EUT



Internal photograph of EUT

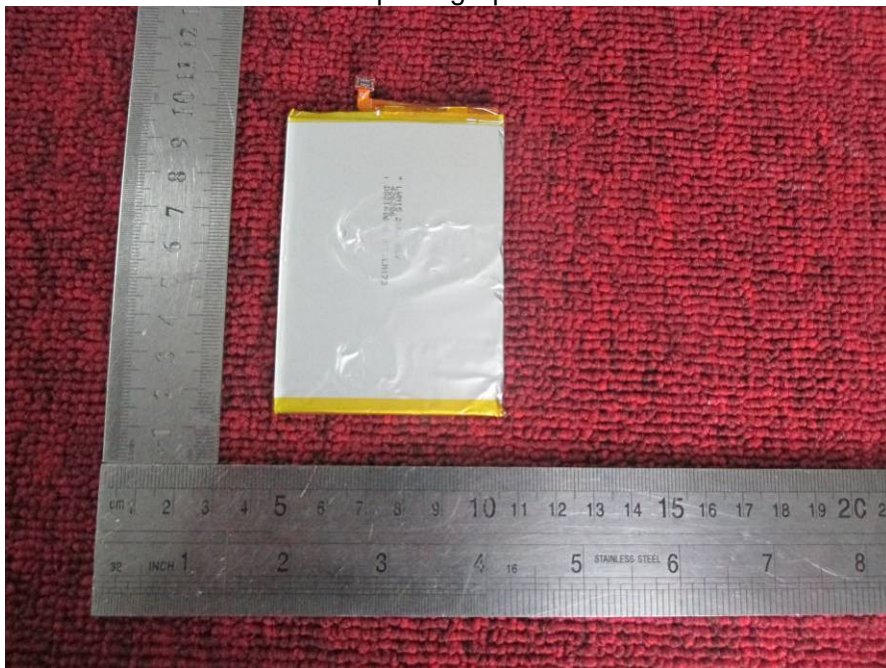

Internal photograph of EUT



Internal photograph of EUT

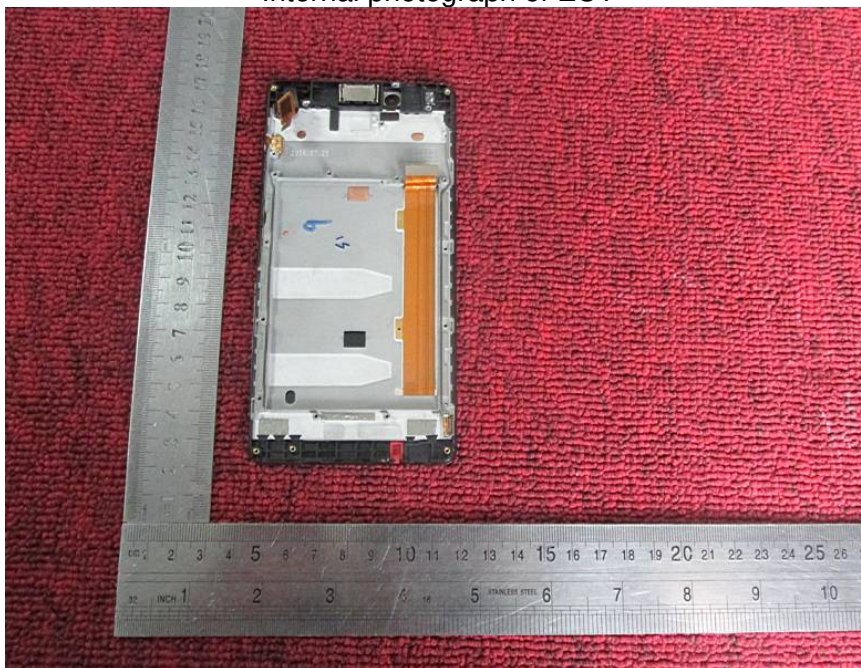

Internal photograph of EUT

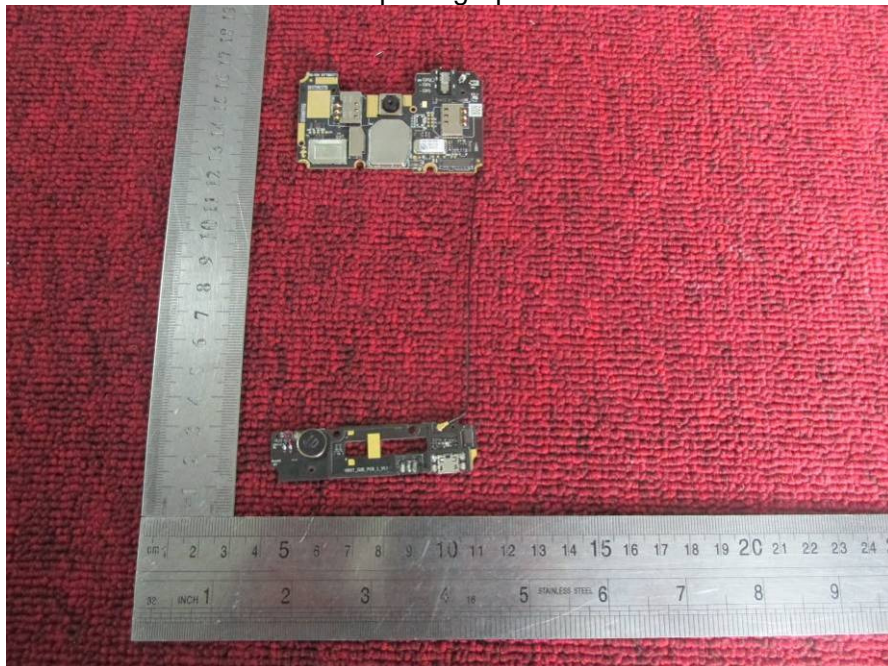

Internal photograph of EUT

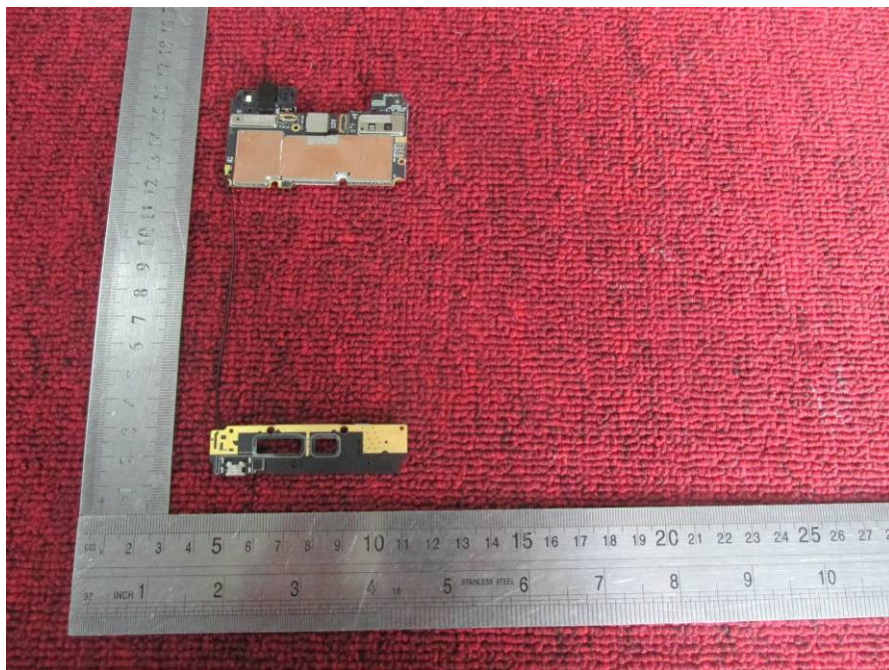

Internal photograph of EUT

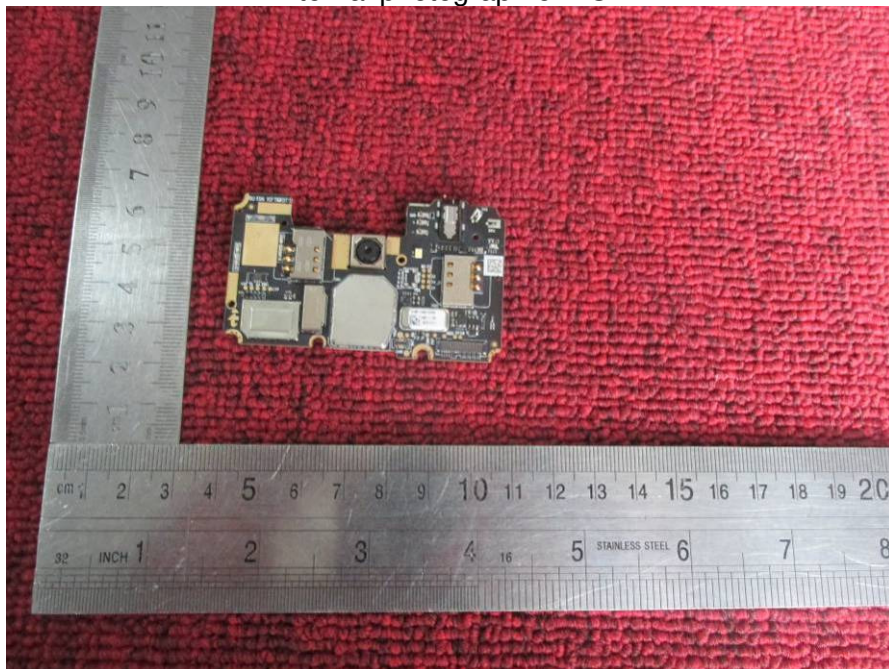

Internal photograph of EUT

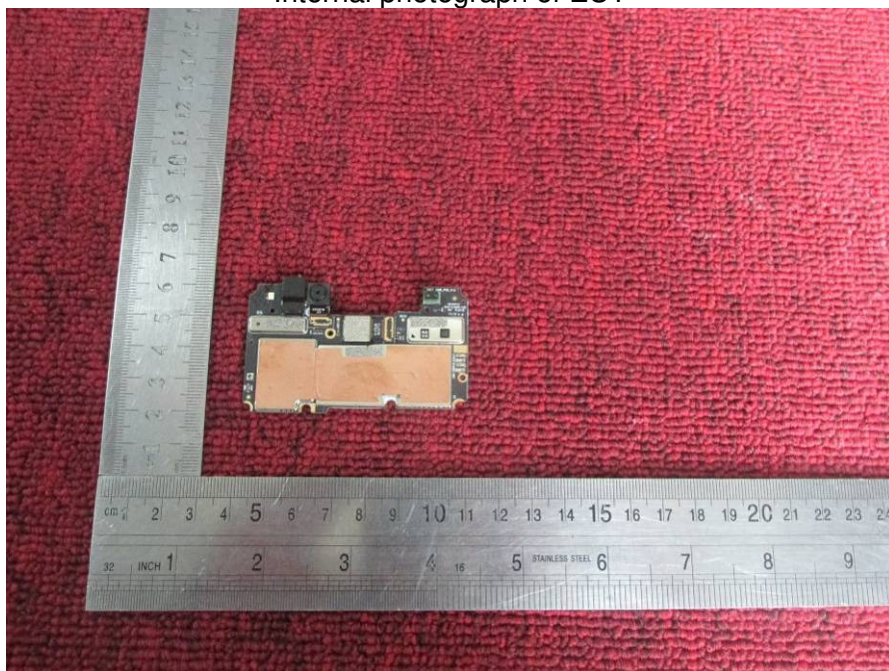

Internal photograph of EUT



Internal photograph of EUT

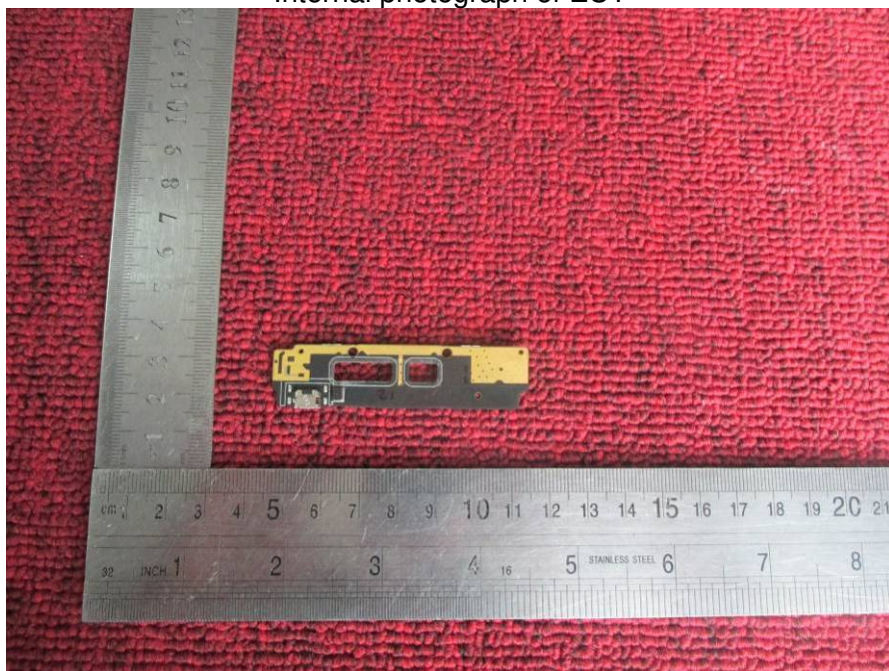

Internal photograph of EUT

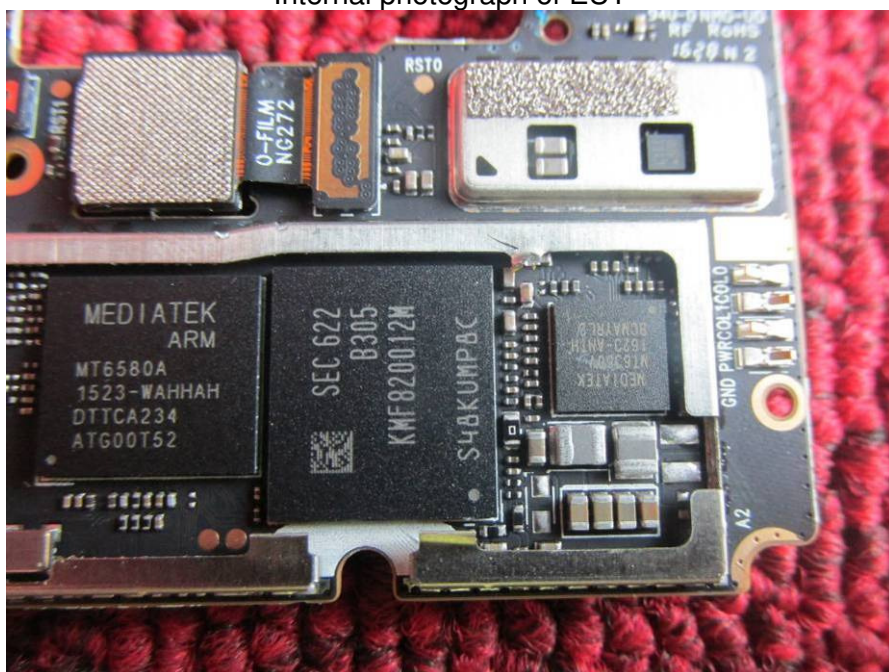

Internal photograph of EUT

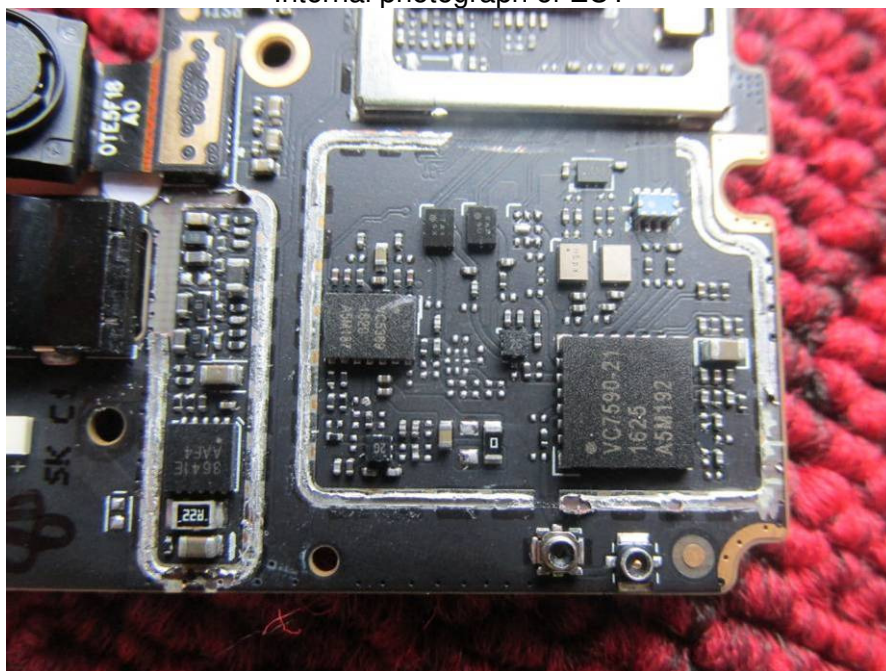

Internal photograph of EUT

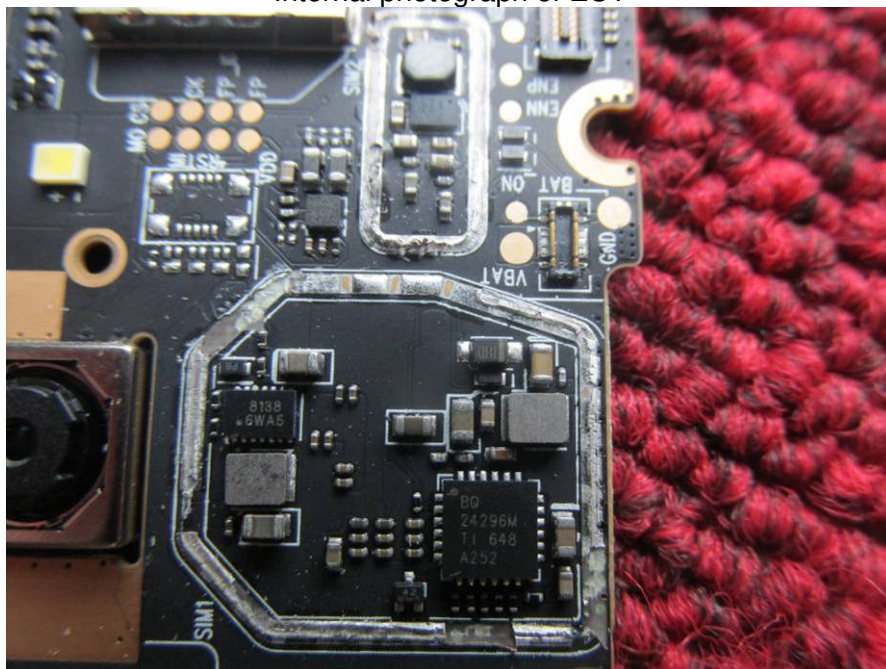

Internal photograph of EUT

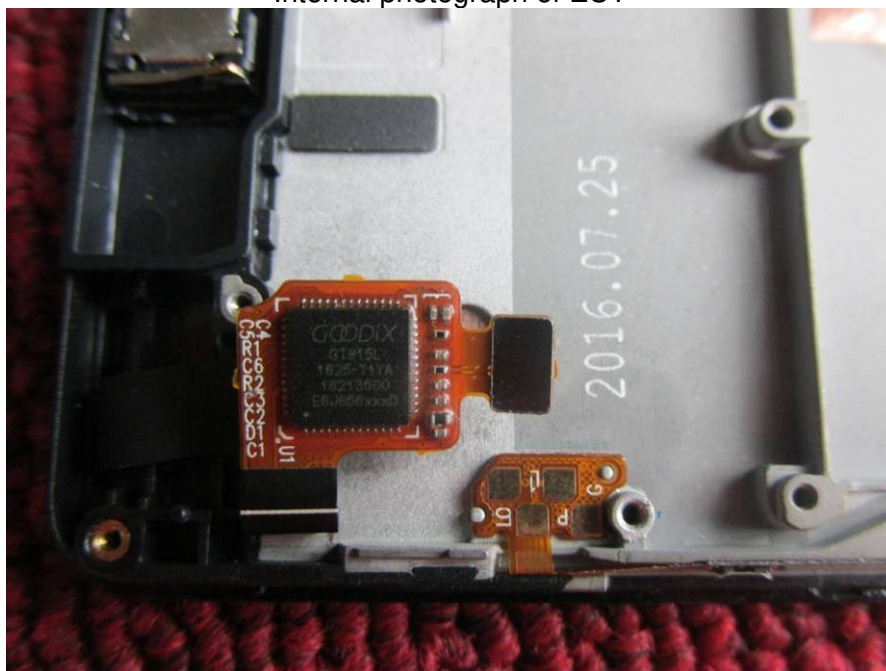

---END OF REPORT---