



# BT Test Report

**Application Purpose** : Original grant  
**Applicant Name:** : INFINIX MOBILITY LIMITED  
**FCC ID** : 2AIZN-X555  
**Equipment Type** : Mobile phone  
**Model Name** : X555  
**Report Number** : FCC16083918A-1  
**Standard(S)** : FCC Part 15 Subpart C  
**Date Of Receipt** : August 19, 2016  
**Date Of Issue** : September 29, 2016

**Test By** : 

(Daisy Qin)

**Reviewed By** : 

(Sol Qin)

**Authorized by** : 

(Michal Ling)

**Prepared by** : **QTC Certification & Testing Co., Ltd.**  
2nd Floor,Bl Building,Fengyeyuan Industrial Plant,,  
Liuxian 2st. Road, Xin'an Street, Bao'an  
District,,Shenzhen,518000  
**Registration Number: 588523**

**REPORT REVISE RECORD**

<b>Report Version</b>	<b>Revise Time</b>	<b>Issued Date</b>	<b>Valid Version</b>	<b>Notes</b>
V1.0	/	September 29, 2016	Valid	Original Report

Table of Contents	Page
<b>1. GENERAL INFORMATION</b>	<b>5</b>
<b>2. TEST DESCRIPTION</b>	<b>7</b>
2.1 MEASUREMENT UNCERTAINTY	7
2.2 DESCRIPTION OF TEST MODES	8
2.3 TABLE OF PARAMETERS OF TEXT SOFTWARE SETTING	9
2.4 CONFIGURATION OF SYSTEM UNDER TEST	9
2.5 DESCRIPTION OF SUPPORT UNITS (CONDUCTED MODE)	10
<b>3. SUMMARY OF TEST RESULTS</b>	<b>11</b>
<b>4. MEASUREMENT INSTRUMENTS</b>	<b>12</b>
<b>5. EMC EMISSION TEST</b>	<b>13</b>
5.1 CONDUCTED EMISSION MEASUREMENT	13
5.1.1 POWER LINE CONDUCTED EMISSION LIMITS	13
5.1.2 TEST PROCEDURE	14
5.1.3 DEVIATION FROM TEST STANDARD	14
5.1.4 TEST SETUP	14
5.1.5 EUT OPERATING CONDITIONS	14
5.1.6 TEST RESULTS	15
5.2 RADIATED EMISSION MEASUREMENT	17
5.2.1 RADIATED EMISSION LIMITS	17
5.2.2 TEST PROCEDURE	18
5.2.3 DEVIATION FROM TEST STANDARD	18
5.2.4 TEST SETUP	19
5.2.5 EUT OPERATING CONDITIONS	20
5.2.5.1 RESULTS (BELOW 30 MHZ)	21
5.2.5.2 TEST RESULTS (BETWEEN 30M – 1000 MHZ)	22
5.2.5.3 TEST RESULTS(1GHZ TO 25GHZ)	24
6.2 TEST PROCEDURE	34
6.3 DEVIATION FROM STANDARD	34
6.4 TEST SETUP	34
6.5 EUT OPERATION CONDITIONS	34
6.6 TEST RESULTS	35
<b>7. AVERAGE TIME OF OCCUPANCY</b>	
7.1 APPLIED PROCEDURES / LIMIT	36
7.2 TEST PROCEDURE	36
7.3 DEVIATION FROM STANDARD	36
7.4 TEST SETUP	37
7.5 EUT OPERATION CONDITIONS	37

<b>Table of Contents</b>	<b>Page</b>
7.6 TEST RESULTS	38
<b>8. HOPPING CHANNEL SEPARATION MEASUREMENT</b>	
8.1 APPLIED PROCEDURES / LIMIT	44
8.2 TEST PROCEDURE	44
8.3 DEVIATION FROM STANDARD	44
8.4 TEST SETUP	44
8.5 EUT OPERATION CONDITIONS	44
8.6 TEST RESULTS	45
<b>9. BANDWIDTH TEST</b>	
9.1 APPLIED PROCEDURES / LIMIT	51
9.2 TEST PROCEDURE	51
9.3 DEVIATION FROM STANDARD	51
9.4 TEST SETUP	51
9.5 EUT OPERATION CONDITIONS	51
9.6 TEST RESULTS	52
<b>10. PEAK OUTPUT POWER TEST</b>	
10.1 APPLIED PROCEDURES / LIMIT	58
10.2 TEST PROCEDURE	58
10.3 DEVIATION FROM STANDARD	58
10.4 TEST SETUP	58
10.5 EUT OPERATION CONDITIONS	58
10.6 TEST RESULTS	59
<b>11. 100KHZ BAND EDGES MEASUREMENT</b>	
11.1 APPLIED PROCEDURES / LIMIT	65
<b>12. ANTENNA APPLICATION</b>	76
<b>13. EUT TEST PHOTO</b>	77
<b>14. PHOTOGRAPHS OF EUT</b>	79

## 1. GENERAL INFORMATION

### GENERAL DESCRIPTION OF EUT

Test Model	X555
Applicant	INFINIX MOBILITY LIMITED
Address	RMS 05-15, 13A/F SOUTH TOWER WORLD FINANCE CTR HARBOUR CITY 17 CANTON RD TST KLN HONG KONG
Manufacturer	SHENZHEN TECNO TECHNOLOGY CO.,LTD.
Address	1-4th Floor,3rd Building,Pacific Industrial Park,No.2088,Shenyang Road,Yantian District,Shenzhen,Guangdong,China
Equipment Type	Mobile phone
Brand Name	<b>Infinix</b>
Hardware version:	V2.1
Software version:	X555-H538B1-M-160721V12
Extreme Temp. Tolerance	-10°C to +50°C
Battery information:	Li-ion Battery : BL-32AX Voltage: 3.85V Capacity: 3200mAh/3250mAh(min/typ) Limited Charge Voltage: 4.5V
Adapter Information:	Adapter: CQ-18KX Input: AC 100-240V 50/60Hz 600mA Output: DC 5V-6V 3A; 6V-9V 2A; 9V-12V 1.5A
Operating Frequency	2402-2480MHz
Channels	79
Channel Spacing	1MHz
Modulation Type	GFSK, $\pi/4$ -DQPSK, 8-DPSK
Version	3.0
Antenna Type:	Integral Antenna
Antenna gain:	-3dBi
Data of receipt	August 19, 2016
Date of test	August 19, 2016 to September 25, 2016
Deviation	None
Condition of Test Sample	Normal

**We hereby certify that:**

The above equipment was tested by QTC Certification & Testing Co., Ltd.

2nd Floor, BI Building, Fengyeyuan Industrial Plant, Liuxian 2st. Road, Xin'an Street, Bao'an District, Shenzhen, 518000

Registration Number: 588523

The data evaluation, test procedures, and equipment configurations shown in this report were made in accordance with the procedures given in ANSI C 63.4:2014. The sample tested as described in this report is in compliance with the FCC Rules Part 15 Subpart C.

ALL the testing were referenced KDB NO.453039

The test results of this report relate only to the tested sample identified in this report.

## 2. TEST DESCRIPTION

### 2.1 MEASUREMENT UNCERTAINTY

The reported uncertainty of measurement  $y \pm U$ , where expanded uncertainty  $U$  is based on a standard uncertainty multiplied by a coverage factor of  $k=2$ , providing a level of confidence of approximately 95%.

No.	Item	Uncertainty
1	Conducted Emission Test	$\pm 3.2$ dB
2	RF power, conducted	$\pm 0.16$ dB
3	Spurious emissions, conducted	$\pm 0.21$ dB
4	All emissions, radiated(<1G)	$\pm 4.7$ dB
5	All emissions, radiated(>1G)	$\pm 4.7$ dB
6	Temperature	$\pm 0.5$ °C
7	Humidity	$\pm 2$ %

## 2.2 DESCRIPTION OF TEST MODES

To investigate the maximum EMI emission characteristics generates from EUT, the test system was pre-scanning tested base on the consideration of following EUT operation mode or test configuration mode which possible have effect on EMI emission level. Each of these EUT operation mode(s) or test configuration mode(s) mentioned above was evaluated respectively.

Pretest Mode	Description
Mode 1	CH00
Mode 2	CH39
Mode 3	CH78
Mode 4	Normal Hopping

For Conducted Emission	
Final Test Mode	Description
Mode 4	Normal Hopping

For Radiated Emission	
Final Test Mode	Description
Mode 1	CH00
Mode 2	CH39
Mode 3	CH78
Mode 4	Normal Hopping

Note:

- (1) The measurements are performed at the highest, middle, lowest available channels.**
- (2) The data rate was set in 1Mbps, 2 Mbps, 3 Mbps for radiated emission due to the highest RF output power.**
- (3) Record the worst case of each test item in this report.**



### 2.3 TABLE OF PARAMETERS OF TEXT SOFTWARE SETTING

During testing channel & power controlling software provided by the customer was used to control the operating channel as well as the output power level. The RF output power selection is for the setting of RF output power expected by the customer and is going to be fixed on the firmware of the final end product power parameters of FHSS

Test software Version	N/A		
Frequency	2402 MHz	2441 MHz	2480 MHz
Parameters(1Mbps)	DEF	DEF	DEF
Parameters(2Mbps)	DEF	DEF	DEF
Parameters(3Mbps)	DEF	DEF	DEF

### 2.4 CONFIGURATION OF SYSTEM UNDER TEST

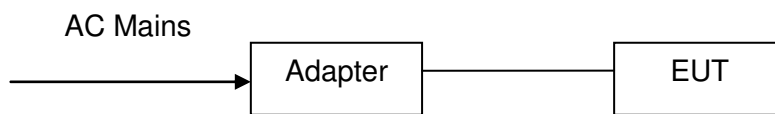

(EUT: Mobile phone)

**2.5 DESCRIPTION OF SUPPORT UNITS (CONDUCTED MODE)**

The EUT has been tested as an independent unit together with other necessary accessories or support units. The following support units or accessories were used to form a representative test configuration during the tests.

Item	Equipment	Mfr/Brand	Model/Type No.	Series No.	Note
1	Adapter	/	CQ-18KX	/	/
2	Earphone	/	/	/	/

**Note:**

- (1) The support equipment was authorized by Declaration of Confirmation.
- (2) For detachable type I/O cable should be specified the length in cm in 『Length』 column.
- (3) “YES” is means “shielded” “with core”; “NO” is means “unshielded” “without core”.

### 3. SUMMARY OF TEST RESULTS

Test procedures according to the technical standards:

<b>FCC Part15 (15.247) , Subpart C</b>			
Standard Section	Test Item	Judgment	Remark
15.207	Conducted Emission	PASS	
15.247(a)(1)	Hopping Channel Separation	PASS	
15.247(b)(1)	Peak Output Power	PASS	
15.247(c)	Radiated Spurious Emission	PASS	
15.247(a)(iii)	Number of Hopping Frequency	PASS	
15.247(a)(iii)	Dwell Time	PASS	
15.247(a)(1)	Bandwidth	PASS	
15.247(d)	100kHz Band Edges	PASS	
15.205	Band Edge Emission	PASS	
15.203	Antenna Requirement	PASS	

**NOTE:**

(1) "N/A" denotes test is not applicable in this test report.

**4. MEASUREMENT INSTRUMENTS**

NAME OF EQUIPMENT	MANUFACTURER	MODEL	SERIAL NUMBER	Calibration Date	Calibration Due.
EMI Test Receiver	R&S	ESCI	100005	08/19/2016	08/18/2017
LISN	AFJ	LS16	16010222119	08/19/2016	08/18/2017
LISN(EUT)	Mestec	AN3016	04/10040	08/19/2016	08/18/2017
Universal Radio Communication Tester	R&S	CMU 200	1100.0008.02	08/19/2016	08/18/2017
Coaxial cable	Megalon	LMR400	N/A	08/12/2016	08/11/2017
GPIB cable	Megalon	GPIB	N/A	08/12/2016	08/11/2017
Spectrum Analyzer	R&S	FSU	100114	08/19/2016	08/18/2017
Pre Amplifier	H.P.	HP8447E	2945A02715	10/13/2016	10/12/2017
Pre-Amplifier	CDSI	PAP-1G18-38	--	10/13/2016	10/12/2017
Bi-log Antenna	SUNOL Sciences	JB3	A021907	09/13/2016	09/12/2017
9*6*6 Anechoic	--	--	--	08/21/2016	08/20/2017
Horn Antenna	COMPLIANCE ENGINEERING	CE18000	--	09/13/2016	09/12/2017
Horn Antenna	SCHWARZBECK	BBHA9120D	9120D-631	08/23/2016	08/22/2017
Cable	TIME MICROWAVE	LMR-400	N-TYPE04	04/25/2016	04/24/2017
System-Controller	CCS	N/A	N/A	N.C.R	N.C.R
Turn Table	CCS	N/A	N/A	N.C.R	N.C.R
Antenna Tower	CCS	N/A	N/A	N.C.R	N.C.R
RF cable	Murata	MXHQ87WA3000	-	08/21/2016	08/20/2017
Loop Antenna	EMCO	6502	00042960	08/22/2016	08/21/2017
Horn Antenna	SCHWARZBECK	BBHA 9170	1123	08/19/2016	08/18/2017
Power meter	Anritsu	ML2487A	6K00003613	08/23/2016	08/22/2017
Power sensor	Anritsu	MX248XD	--	08/19/2016	08/18/2017

## 5. EMC EMISSION TEST

### 5.1 CONDUCTED EMISSION MEASUREMENT

#### 5.1.1 POWER LINE CONDUCTED EMISSION Limits (Frequency Range 150KHz-30MHz)

FREQUENCY (MHz)	Class A (dBuV)		Class B (dBuV)		Standard
	Quasi-peak	Average	Quasi-peak	Average	
0.15 -0.5	79.00	66.00	66 - 56 *	56 - 46 *	FCC
0.50 -5.0	73.00	60.00	56.00	46.00	FCC
5.0 -30.0	73.00	60.00	60.00	50.00	FCC

Note:

- (1) The tighter limit applies at the band edges.
- (2) The limit of " \* " marked band means the limitation decreases linearly with the logarithm of the frequency in the range.

The following table is the setting of the receiver

Receiver Parameters	Setting
Attenuation	10 dB
Start Frequency	0.15 MHz
Stop Frequency	30 MHz
IF Bandwidth	9 kHz

### 5.1.2 TEST PROCEDURE

- The EUT was placed 0.4 meters from the horizontal ground plane with EUT being connected to the power mains through a line impedance stabilization network (LISN). All other support equipments powered from additional LISN(s). The LISN provide 50 Ohm/ 50uH of coupling impedance for the measuring instrument.
- Interconnecting cables that hang closer than 40 cm to the ground plane shall be folded back and forth in the center forming a bundle 30 to 40 cm long.
- I/O cables that are not connected to a peripheral shall be bundled in the center. The end of the cable may be terminated, if required, using the correct terminating impedance. The overall length shall not exceed 1 m.
- LISN at least 80 cm from nearest part of EUT chassis.
- For the actual test configuration, please refer to the related Item –EUT Test Photos.

### 5.1.3 DEVIATION FROM TEST STANDARD

No deviation

### 5.1.4 TEST SETUP

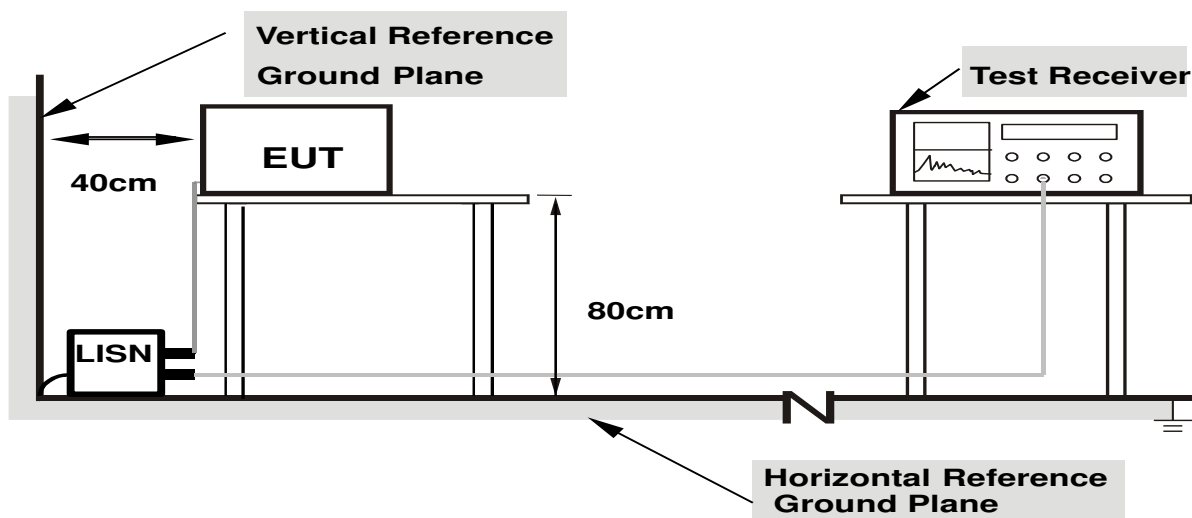

- Note: 1. Support units were connected to second LISN.**  
**2. Both of LISNs (AMN) are 80 cm from EUT and at least 80 cm from other units and other metal planes**

### 5.1.5 EUT OPERATING CONDITIONS

The EUT was configured for testing in a typical fashion (as a customer would normally use it). The EUT has been programmed to continuously transmit during test. This operating condition was tested and used to collect the included data.

### 5.1.6 TEST RESULTS

EUT	Mobile phone	Model Name	X555
Temperature	26 °C	Relative Humidity	54%
Pressure	1010hPa	Phase	L
Test Date	August 23, 2016	Test Mode	Mode 4
Voltage	120V/60Hz		

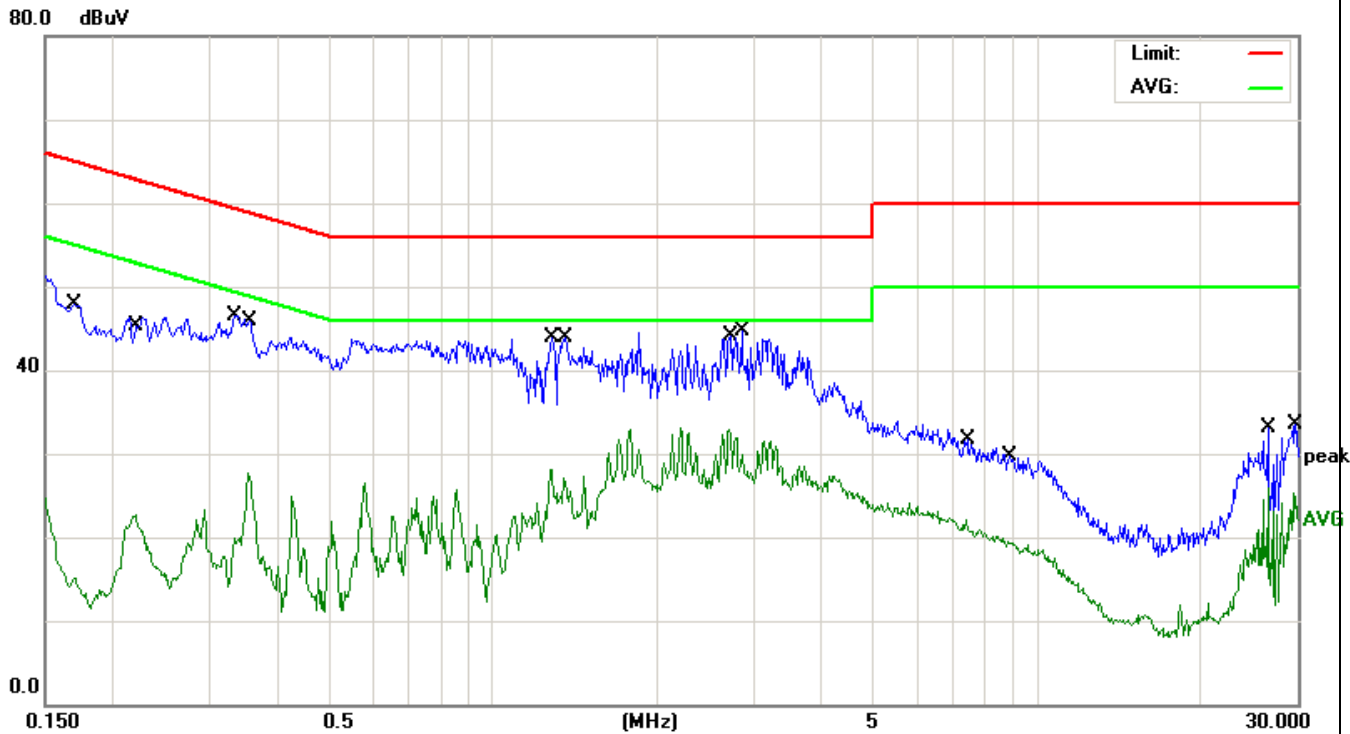

No.	Mk.	Freq. MHz	Reading Level dBuV	Correct Factor dB	Measure- ment dBuV	Limit dBuV	Over dB	Detector
1		0.1700	33.49	10.44	43.93	64.96	-21.03	QP
2		0.2197	12.22	10.43	22.65	52.83	-30.18	AVG
3		0.3339	32.50	10.42	42.92	59.35	-16.43	QP
4		0.3540	17.36	10.42	27.78	48.87	-21.09	AVG
5		1.2740	17.84	10.33	28.17	46.00	-17.83	AVG
6		1.3540	29.56	10.32	39.88	56.00	-16.12	QP
7	*	2.7100	22.63	10.28	32.91	46.00	-13.09	AVG
8		2.8620	30.09	10.27	40.36	56.00	-15.64	QP
9		7.3980	11.98	10.21	22.19	50.00	-27.81	AVG
10		8.9100	14.93	10.20	25.13	60.00	-34.87	QP
11		26.5260	15.79	10.10	25.89	50.00	-24.11	AVG
12		29.7620	19.45	10.11	29.56	60.00	-30.44	QP

Remark: All the modes have been investigated, and only worst mode is presented in this report.

EUT	Mobile phone	Model Name	X555
Temperature	26 °C	Relative Humidity	54%
Pressure	1010hPa	Phase	N
Test Date	August 23, 2016	Test Mode	Mode 4
Voltage	120V/60Hz		

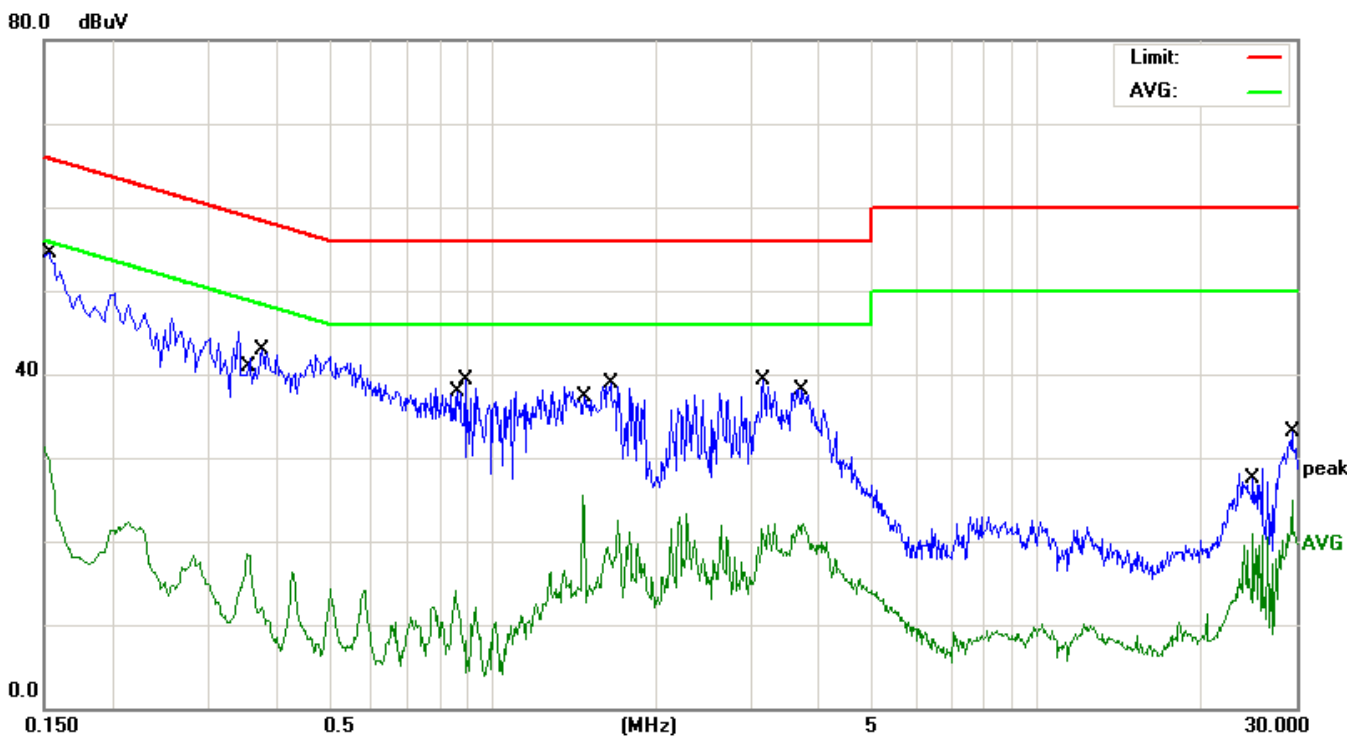

No.	Mk.	Freq. MHz	Reading Level dBuV	Correct Factor dB	Measure- ment dBuV	Limit dBuV	Over dB	Detector
1		0.1500	20.87	10.44	31.31	55.99	-24.68	AVG
2	*	0.1532	40.07	10.44	50.51	65.82	-15.31	QP
3		0.3540	8.07	10.42	18.49	48.87	-30.38	AVG
4		0.3780	28.51	10.41	38.92	58.32	-19.40	QP
5		0.8540	3.74	10.36	14.10	46.00	-31.90	AVG
6		0.8940	24.93	10.35	35.28	56.00	-20.72	QP
7		1.4700	15.23	10.32	25.55	46.00	-20.45	AVG
8		1.6460	24.67	10.31	34.98	56.00	-21.02	QP
9		3.1460	25.07	10.27	35.34	56.00	-20.66	QP
10		3.7340	11.82	10.26	22.08	46.00	-23.92	AVG
11		24.9460	10.77	10.10	20.87	50.00	-29.13	AVG
12		29.1620	17.80	10.11	27.91	60.00	-32.09	QP

Remark: All the modes have been investigated, and only worst mode is presented in this report.



## 5.2 RADIATED EMISSION MEASUREMENT

### 5.2.1 RADIATED EMISSION LIMITS (Frequency Range 9kHz-1000MHz)

20dBc in any 100 kHz bandwidth outside the operating frequency band. In case the emission fall within the restricted band specified on 15.205(a), then the 15.209(a) limit in the table below has to be followed.

Frequencies (MHz)	Field Strength (micorvolts/meter)	Measurement Distance (meters)
0.009~0.490	2400/F(KHz)	300
0.490~1.705	24000/F(KHz)	30
1.705~30.0	30	30
30~88	100	3
88~216	150	3
216~960	200	3
Above 960	500	3

#### LIMITS OF RADIATED EMISSION MEASUREMENT (Above 1000MHz)

FREQUENCY (MHz)	Limit (dBuV/m) (at 3M)	
	PEAK	AVERAGE
Above 1000	74	54

Notes:

- (1) The limit for radiated test was performed according to FCC PART 15C.
- (2) The tighter limit applies at the band edges.
- (3) Emission level (dBuV/m)=20log Emission level (uV/m).

Spectrum Parameter	Setting
Attenuation	Auto
Start Frequency	1000 MHz
Stop Frequency	10th carrier harmonic
RB / VB (emission in restricted band)	1 MHz / 1 MHz for Peak, 1 MHz / 10Hz for Average

Receiver Parameter	Setting
Attenuation	Auto
Start ~ Stop Frequency	9kHz~150kHz / RB 200Hz for QP
Start ~ Stop Frequency	150kHz~30MHz / RB 9kHz for QP
Start ~ Stop Frequency	30MHz~1000MHz / RB 120kHz for QP

### 5.2.2 TEST PROCEDURE

- a. The measuring distance of at 3 m shall be used for measurements at frequency up to 1GHz. For frequencies above 1GHz, any suitable measuring distance may be used.
- b. The EUT was placed on the top of a rotating table 0.8 meters above the ground at a 3 meter open area test site. The table was rotated 360 degrees to determine the position of the highest radiation.
- c. The height of the equipment or of the substitution antenna shall be 0.8 m; the height of the test antenna shall vary between 1 m to 4 m. Both horizontal and vertical polarizations of the antenna are set to make the measurement.
- d. The initial step in collecting conducted emission data is a spectrum analyzer peak detector mode pre-scanning the measurement frequency range. Significant peaks are then marked and then Quasi Peak detector mode re-measured.
- e. If the Peak Mode measured value compliance with and lower than Quasi Peak Mode Limit, the EUT shall be deemed to meet QP Limits and then no additional QP Mode measurement performed.
- f. For the actual test configuration, please refer to the related Item –EUT Test Photos.

Note:

***Both horizontal and vertical antenna polarities were tested and performed pretest to three orthogonal axis. The worst case emissions were reported***

### 5.2.3 DEVIATION FROM TEST STANDARD

No deviation

## 5.2.4 TEST SETUP

### (A) Radiated Emission Test-Up Frequency Below 30MHz

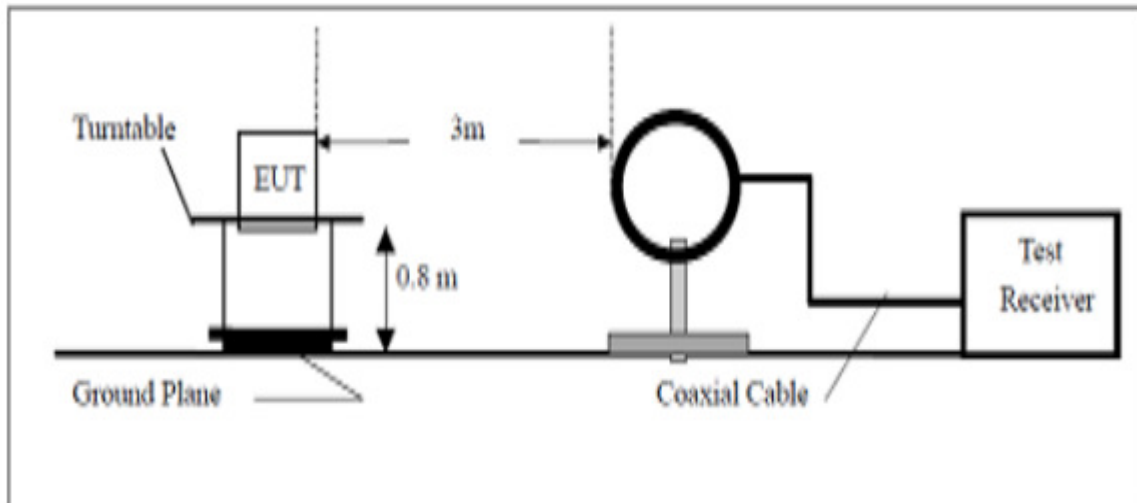

### (B) Radiated Emission Test-Up Frequency 30MHz~1GHz

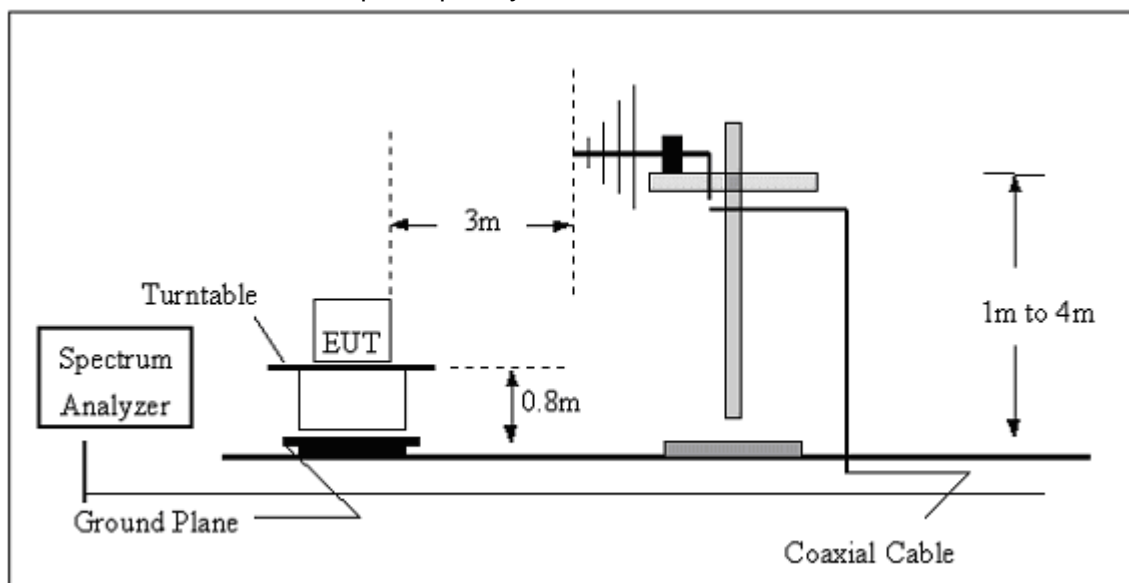

## (C) Radiated Emission Test-Up Frequency Above 1GHz

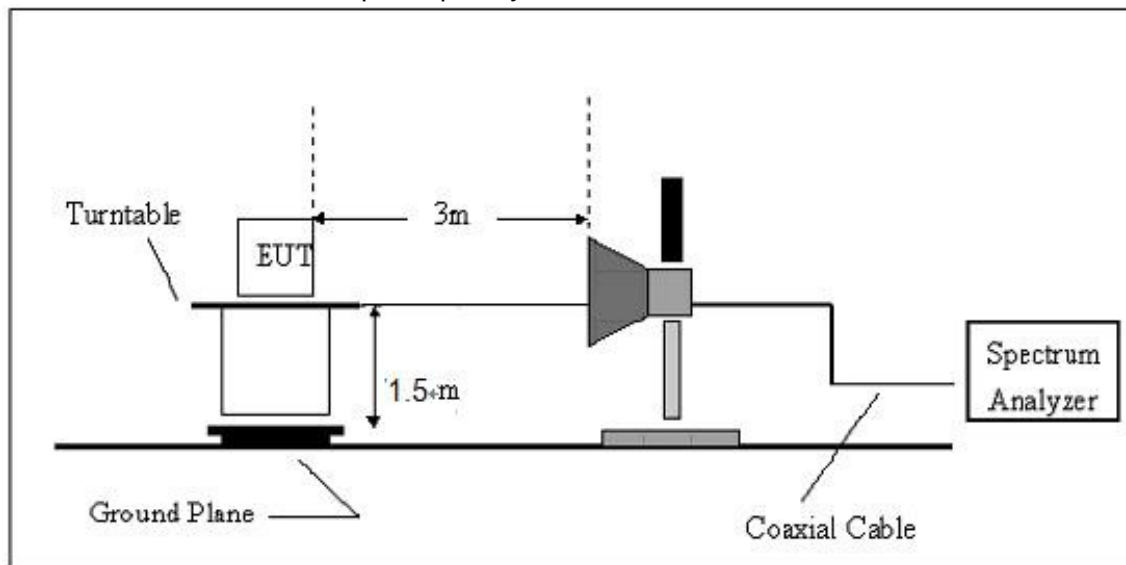
**5.2.5 EUT OPERATING CONDITIONS**

The EUT tested system was configured as the statements of 2.4 Unless otherwise a special operating condition is specified in the follows during the testing.

**5.2.5.1 RESULTS (BELOW 30 MHZ)**

EUT	Mobile phone	Model Name	X555
Temperature	20 °C	Relative Humidity	48%
Pressure	1010 hPa	Polarization	Horizontal / Vertical
Test Mode	Mode 1/ Mode 2/ Mode 3	Test Date	August 23, 2016

Freq.	Reading	Limit	Margin	State
(MHz)	(dBuV/m)	(dBuV/m)	(dB)	P/F
--	--	--	--	P
--	--	--	--	P

**NOTE:**

No result in this part for margin above 20dB.

Distance extrapolation factor =  $20 \log(\text{specific distance}/\text{test distance})$ (dB);

Limit line = specific limits (dBuV) + distance extrapolation factor.

All the x/y/z orientation has been investigated, and only worst case is presented in this report.

**5.2.5.2 TEST RESULTS (BETWEEN 30M – 1000 MHZ)**

EUT	Mobile phone	Model Name	X555
Temperature	20 °C	Relative Humidity	48%
Pressure	1010 hPa	Polarization :	Horizontal
Test Mode	Mode 1 with GFSK modulation	Test Date	August 23, 2016

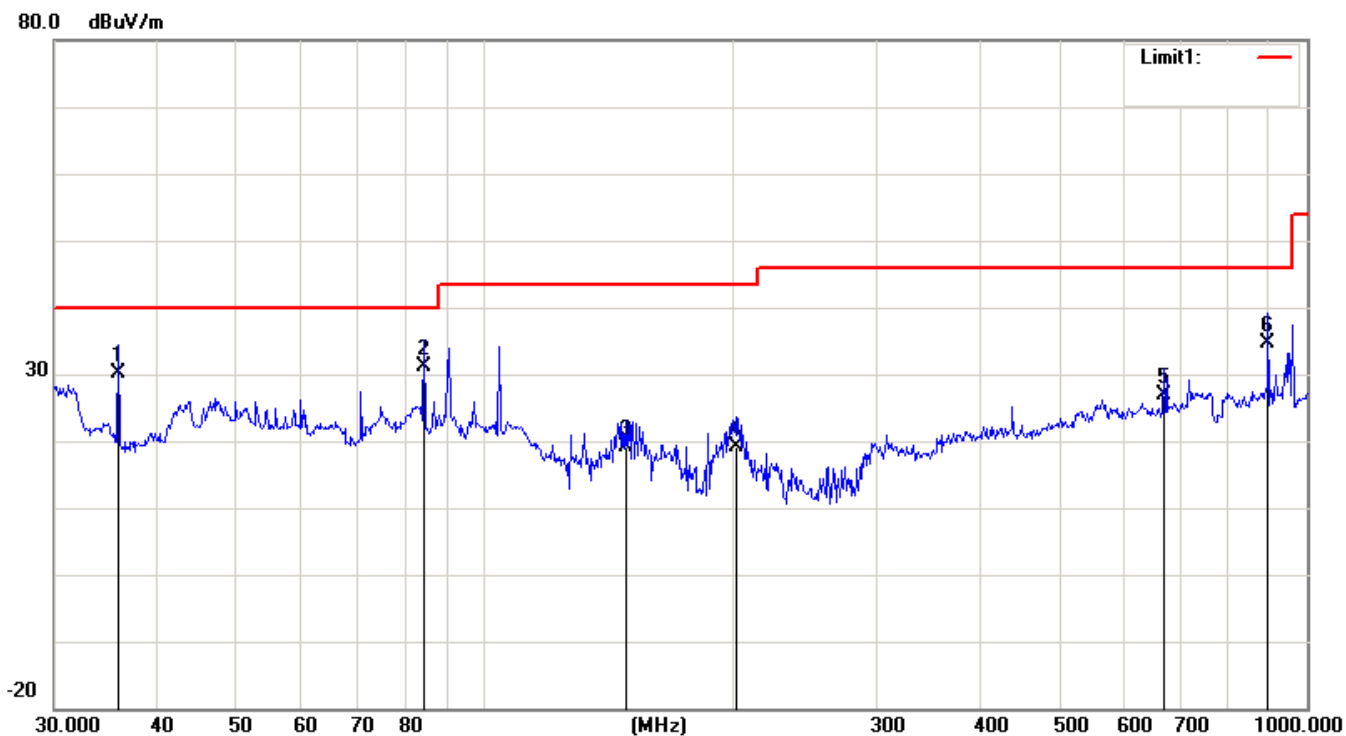

No.	Mk.	Freq. MHz	Reading Level dBuV	Correct Factor dB	Measure- ment dBuV/m	Limit dBuV/m	Over dB	Detector
1		35.8746	30.60	-0.51	30.09	40.00	-9.91	QP
2	*	84.4054	39.09	-7.94	31.15	40.00	-8.85	QP
3		148.4410	22.96	-3.71	19.25	43.50	-24.25	QP
4		202.1005	24.13	-4.90	19.23	43.50	-24.27	QP
5		670.4893	24.86	2.00	26.86	46.00	-19.14	QP
6		896.9965	28.93	5.59	34.52	46.00	-11.48	QP

Remark: All the modes have been investigated, and only worst mode is presented in this report.

EUT	Mobile phone	Model Name	X555
Temperature	20 °C	Relative Humidity	48%
Pressure	1010 hPa	Polarization :	Vertical
Test Mode	Mode 1 with GFSK modulation	Test Date	August 23, 2016

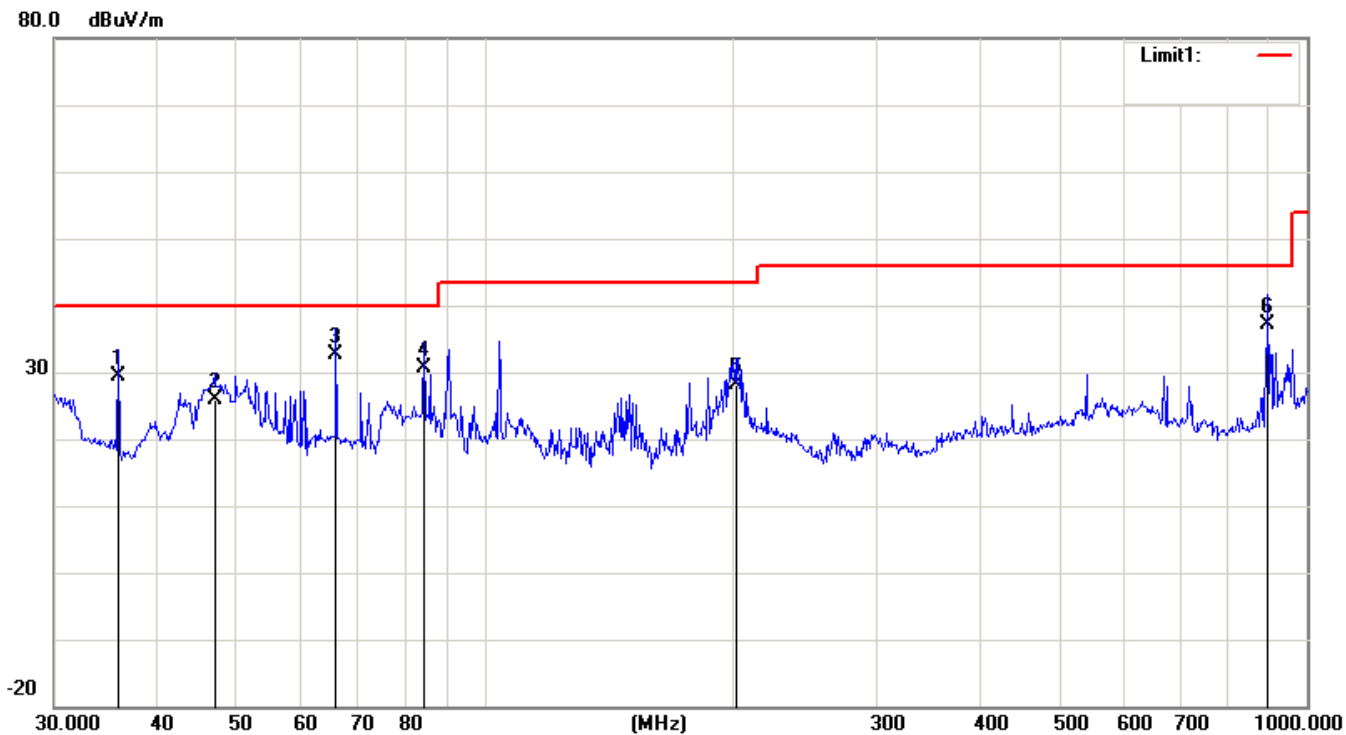

No.	Mk.	Freq. MHz	Reading Level dBuV	Correct Factor dB	Measure- ment dBuV/m	Limit dBuV/m	Over dB	Detector
1		35.8746	29.90	-0.51	29.39	40.00	-10.61	QP
2		46.9948	33.54	-7.77	25.77	40.00	-14.23	QP
3	*	66.0342	41.30	-8.59	32.71	40.00	-7.29	QP
4		84.4054	38.59	-7.94	30.65	40.00	-9.35	QP
5		202.1005	33.04	-4.90	28.14	43.50	-15.36	QP
6		896.9965	31.53	5.59	37.12	46.00	-8.88	QP

Remark: All the modes have been investigated, and only worst mode is presented in this report.

**5.2.5.3 TEST RESULTS(1GHZ TO 25GHZ)**

EUT	Mobile phone	Model Name	X555
Temperature	20 °C	Relative Humidity	48%
Pressure	1010 hPa	Test Mode	Mode 1 TX(1Mbps)

Freq. (MHz)	Ant. Pol.	Emission Level(dBuV)		Limit 3m(dBuV/m)		Over(dB)	
		PK	AV	PK	AV	PK	AV
4804	V	58.47	41.58	74	54	-15.53	-12.42
7206	V	59.47	40.05	74	54	-14.53	-13.95
4804	H	59.35	39.23	74	54	-14.65	-14.77
7206	H	59.00	40.00	74	54	-15.00	-14.00

**Remark:**

All emissions not reported were more than 20dB below the specified limit or in the noise floor.  
All the x/y/z orientation has been investigated, and only worst case is presented in this report.



EUT	Mobile phone	Model Name	X555
Temperature	20 °C	Relative Humidity	48%
Pressure	1010 hPa	Test Mode	Mode 2 TX(2Mbps)

Freq. (MHz)	Ant.Pol.	Emission Level(dBuV)		Limit 3m(dBuV/m)		Over(dB)	
		PK	AV	PK	AV	PK	AV
4882	V	60.13	40.99	74	54	-13.87	-13.01
7323	V	58.76	40.86	74	54	-15.24	-13.14
4882	H	58.62	39.79	74	54	-15.38	-14.21
7323	H	59.77	40.77	74	54	-14.23	-13.23

Remark:

All emissions not reported were more than 20dB below the specified limit or in the noise floor.  
All the x/y/z orientation has been investigated, and only worst case is presented in this report.

EUT	Mobile phone	Model Name	X555
Temperature	20 °C	Relative Humidity	48%
Pressure	1010 hPa	Test Mode	Mode 3 TX(3Mbps)

Freq. (MHz)	Ant.Pol.	Emission Level(dBuV)		Limit 3m(dBuV/m)		Over(dB)	
		PK	AV	PK	AV	PK	AV
4960	V	59.39	39.18	74	54	-14.61	-14.82
7440	V	58.00	40.25	74	54	-16.00	-13.75
4960	H	58.17	39.64	74	54	-15.83	-14.36
7440	H	59.21	40.21	74	54	-14.79	-13.79

Remark:

All emissions not reported were more than 20dB below the specified limit or in the noise floor.  
All the x/y/z orientation has been investigated, and only worst case is presented in this report.

**5.2.5.4 TEST RESULTS (Restricted Bands Requirements)****Test result for 1Mbps Mode:**

EUT	Mobile phone	Model Name	X555
Temperature	20 °C	Relative Humidity	48%
Pressure	1010 hPa	Test Date	August 23, 2016
Test Mode	TX /Mode1-1Mbps	Polarization	Vertical

Frequency	Meter Reading	Factor	Emission Level	Limits	Margin	Detector Type
(MHz)	(dBµV)	(dB)	(dBµV/m)	(dBµV/m)	(dB)	
2387	62.28	-8.76	53.52	74	20.48	peak
2387	55.80	-8.76	47.04	54	6.96	AVG
2390	62.17	-8.73	53.44	74	20.56	peak
2390	55.35	-8.73	46.62	54	7.38	AVG

Remark:

Factor = Antenna Factor + Cable Loss – Pre-amplifier.

All the x/y/z orientation has been investigated, and only worst case is presented in this report.

EUT	Mobile phone	Model Name	X555
Temperature	20 °C	Relative Humidity	48%
Pressure	1010 hPa	Test Date	August 23, 2016
Test Mode	TX /Mode1-1Mbps	Polarization	Horizontal

Frequency	Meter Reading	Factor	Emission Level	Limits	Margin	Detector Type
(MHz)	(dBµV)	(dB)	(dBµV/m)	(dBµV/m)	(dB)	
2384	60.04	-8.76	51.28	74	22.72	peak
2384	56.37	-8.76	47.61	54	6.39	AVG
2390	62.62	-8.73	53.89	74	20.11	peak
2390	57.61	-8.73	48.88	54	5.12	AVG

Remark:

Factor = Antenna Factor + Cable Loss – Pre-amplifier.

All the x/y/z orientation has been investigated, and only worst case is presented in this report.

EUT	Mobile phone	Model Name	X555
Temperature	20 °C	Relative Humidity	48%
Pressure	1010 hPa	Test Date	August 23, 2016
Test Mode	TX /Mode 1-1Mbps	Polarization	Vertical

Frequency	Meter Reading	Factor	Emission Level	Limits	Margin	Detector Type
(MHz)	(dBµV)	(dB)	(dBµV/m)	(dBµV/m)	(dB)	
2483.5	63.78	-8.17	55.61	74	18.39	peak
2483.5	53.22	-8.17	45.05	54	8.95	AVG

Remark:  
 Factor = Antenna Factor + Cable Loss – Pre-amplifier.  
 All the x/y/z orientation has been investigated, and only worst case is presented in this report.

EUT	Mobile phone	Model Name	X555
Temperature	20 °C	Relative Humidity	48%
Pressure	1010 hPa	Test Date	August 23, 2016
Test Mode	TX /Mode 1-1Mbps	Polarization	Horizontal

Frequency	Meter Reading	Factor	Emission Level	Limits	Margin	Detector Type
(MHz)	(dBµV)	(dB)	(dBµV/m)	(dBµV/m)	(dB)	
2483.5	64.15	-8.17	55.98	74	18.02	peak
2483.5	53.67	-8.17	45.50	54	8.50	AVG

Remark:  
 Factor = Antenna Factor + Cable Loss – Pre-amplifier.  
 All the x/y/z orientation has been investigated, and only worst case is presented in this report.

**Test result for 2Mbps Mode:**

EUT	Mobile phone	Model Name	X555
Temperature	20 °C	Relative Humidity	48%
Pressure	1010 hPa	Test Date	August 23, 2016
Test Mode	TX /Mode2-2Mbps	Polarization	Vertical

Frequency	Meter Reading	Factor	Emission Level	Limits	Margin	Detector Type
(MHz)	(dBµV)	(dB)	(dBµV/m)	(dBµV/m)	(dB)	
2387	62.46	-8.76	53.70	74	20.30	peak
2387	54.92	-8.76	46.16	54	7.84	AVG
2390	62.09	-8.73	53.36	74	20.64	peak
2390	54.84	-8.73	46.11	54	7.89	AVG

Remark:

Factor = Antenna Factor + Cable Loss – Pre-amplifier.

All the x/y/z orientation has been investigated, and only worst case is presented in this report.

EUT	Mobile phone	Model Name	X555
Temperature	20 °C	Relative Humidity	48%
Pressure	1010 hPa	Test Date	August 23, 2016
Test Mode	TX /Mode2-2Mbps	Polarization	Horizontal

Frequency	Meter Reading	Factor	Emission Level	Limits	Margin	Detector Type
(MHz)	(dBµV)	(dB)	(dBµV/m)	(dBµV/m)	(dB)	
2384	60.31	-8.76	51.55	74	22.45	peak
2384	55.30	-8.76	46.54	54	7.46	AVG
2390	61.89	-8.73	53.16	74	20.84	peak
2390	56.12	-8.73	47.39	54	6.61	AVG

Remark:

Factor = Antenna Factor + Cable Loss – Pre-amplifier.

All the x/y/z orientation has been investigated, and only worst case is presented in this report.

EUT	Mobile phone	Model Name	X555
Temperature	20 °C	Relative Humidity	48%
Pressure	1010 hPa	Test Date	August 23, 2016
Test Mode	TX /Mode2-2Mbps	Polarization	Vertical

Frequency	Meter Reading	Factor	Emission Level	Limits	Margin	Detector Type
(MHz)	(dBµV)	(dB)	(dBµV/m)	(dBµV/m)	(dB)	
2483.5	63.41	-8.17	55.24	74	18.76	peak
2483.5	54.34	-8.17	46.17	54	7.83	AVG

Remark:  
 Factor = Antenna Factor + Cable Loss – Pre-amplifier.  
 All the x/y/z orientation has been investigated, and only worst case is presented in this report.

EUT	Mobile phone	Model Name	X555
Temperature	20 °C	Relative Humidity	48%
Pressure	1010 hPa	Test Date	August 23, 2016
Test Mode	TX /Mode2-2Mbps	Polarization	Horizontal

Frequency	Meter Reading	Factor	Emission Level	Limits	Margin	Detector Type
(MHz)	(dBµV)	(dB)	(dBµV/m)	(dBµV/m)	(dB)	
2483.5	63.14	-8.17	54.97	74	19.03	peak
2483.5	54.22	-8.17	46.05	54	7.95	AVG

Remark:  
 Factor = Antenna Factor + Cable Loss – Pre-amplifier.  
 All the x/y/z orientation has been investigated, and only worst case is presented in this report.

**Test result for 3Mbps Mode:**

EUT	Mobile phone	Model Name	X555
Temperature	20 °C	Relative Humidity	48%
Pressure	1010 hPa	Test Date	August 23, 2016
Test Mode	TX /Model 3-3Mbps	Polarization	Vertical

Frequency	Meter Reading	Factor	Emission Level	Limits	Margin	Detector Type
(MHz)	(dB $\mu$ V)	(dB)	(dB $\mu$ V/m)	(dB $\mu$ V/m)	(dB)	
2387	62.22	-8.76	53.46	74	20.54	peak
2387	54.54	-8.76	45.78	54	8.22	AVG
2390	59.42	-8.73	50.69	74	23.31	peak
2390	55.00	-8.73	46.27	54	7.73	AVG

Remark:

Factor = Antenna Factor + Cable Loss – Pre-amplifier.

All the x/y/z orientation has been investigated, and only worst case is presented in this report.

EUT	Mobile phone	Model Name	X555
Temperature	20 °C	Relative Humidity	48%
Pressure	1010 hPa	Test Date	August 23, 2016
Test Mode	TX /Mode 3-3Mbps	Polarization	Horizontal

Frequency	Meter Reading	Factor	Emission Level	Limits	Margin	Detector Type
(MHz)	(dB $\mu$ V)	(dB)	(dB $\mu$ V/m)	(dB $\mu$ V/m)	(dB)	
2384	60.06	-8.76	51.30	74	22.70	peak
2384	56.50	-8.76	47.74	54	6.26	AVG
2390	60.32	-8.73	51.59	74	22.41	peak
2390	57.21	-8.73	48.48	54	5.52	AVG

Remark:

Factor = Antenna Factor + Cable Loss – Pre-amplifier.

All the x/y/z orientation has been investigated, and only worst case is presented in this report.

EUT	Mobile phone	Model Name	X555
Temperature	20 °C	Relative Humidity	48%
Pressure	1010 hPa	Test Date	August 23, 2016
Test Mode	TX /Model 3-3Mbps	Polarization	Vertical

Frequency	Meter Reading	Factor	Emission Level	Limits	Margin	Detector Type
(MHz)	(dB $\mu$ V)	(dB)	(dB $\mu$ V/m)	(dB $\mu$ V/m)	(dB)	
2483.5	64.53	-8.17	56.36	74	17.64	peak
2483.5	54.42	-8.17	46.25	54	7.75	AVG

Remark:

Factor = Antenna Factor + Cable Loss – Pre-amplifier.

All the x/y/z orientation has been investigated, and only worst case is presented in this report.

EUT	Mobile phone	Model Name	X555
Temperature	20 °C	Relative Humidity	48%
Pressure	1010 hPa	Test Date	August 23, 2016
Test Mode	TX /Model 3-3Mbps	Polarization	Horizontal

Frequency	Meter Reading	Factor	Emission Level	Limits	Margin	Detector Type
(MHz)	(dB $\mu$ V)	(dB)	(dB $\mu$ V/m)	(dB $\mu$ V/m)	(dB)	
2483.5	60.38	-8.17	52.21	74	21.79	peak
2483.5	53.12	-8.17	44.95	54	9.05	AVG

Remark:

Factor = Antenna Factor + Cable Loss – Pre-amplifier.

All the x/y/z orientation has been investigated, and only worst case is presented in this report.

**Test result for hopping mode:**

EUT	Mobile phone	Model Name	X555
Temperature	20 °C	Relative Humidity	48%
Pressure	1010 hPa	Test Date	August 23, 2016
Test Mode	hopping mode-1Mbps	Polarization	Vertical

Frequency (MHz)	Meter Reading (dB $\mu$ V)	Factor (dB)	Emission Level (dB $\mu$ V/m)	Limits (dB $\mu$ V/m)	Margin (dB)	Detector Type
2387	63.08	-8.76	54.32	74	19.68	peak
2387	54.66	-8.76	45.90	54	8.10	AVG
2390	59.38	-8.73	50.65	74	23.35	peak
2390	54.99	-8.73	46.26	54	7.74	AVG

Remark:

Factor = Antenna Factor + Cable Loss – Pre-amplifier.

All the x/y/z orientation has been investigated, and only worst case is presented in this report.

EUT	Mobile phone	Model Name	X555
Temperature	20 °C	Relative Humidity	48%
Pressure	1010 hPa	Test Date	August 23, 2016
Test Mode	Hopping mode-1Mbps	Polarization	Horizontal

Frequency (MHz)	Meter Reading (dB $\mu$ V)	Factor (dB)	Emission Level (dB $\mu$ V/m)	Limits (dB $\mu$ V/m)	Margin (dB)	Detector Type
2387	63.78	-8.76	55.02	74	18.98	peak
2387	54.67	-8.76	45.91	54	8.09	AVG
2390	63.88	-8.73	55.15	74	18.85	peak
2390	54.04	-8.73	45.31	54	8.69	AVG

Remark:

Factor = Antenna Factor + Cable Loss – Pre-amplifier.

All the x/y/z orientation has been investigated, and only worst case is presented in this report.



EUT	Mobile phone	Model Name	X555
Temperature	20 °C	Relative Humidity	48%
Pressure	1010 hPa	Test Date	August 23, 2016
Test Mode	Hopping mode-1Mbps	Polarization	Vertical

Frequency	Meter Reading	Factor	Emission Level	Limits	Margin	Detector Type
(MHz)	(dB $\mu$ V)	(dB)	(dB $\mu$ V/m)	(dB $\mu$ V/m)	(dB)	
2483.5	62.09	-8.17	53.92	74	20.08	peak
2483.5	54.79	-8.17	46.62	54	7.38	AVG

Remark:

Factor = Antenna Factor + Cable Loss – Pre-amplifier.

All the x/y/z orientation has been investigated, and only worst case is presented in this report.

EUT	Mobile phone	Model Name	X555
Temperature	20 °C	Relative Humidity	48%
Pressure	1010 hPa	Test Date	August 23, 2016
Test Mode	Hopping mode-1Mbps	Polarization	Horizontal

Frequency	Meter Reading	Factor	Emission Level	Limits	Margin	Detector Type
(MHz)	(dB $\mu$ V)	(dB)	(dB $\mu$ V/m)	(dB $\mu$ V/m)	(dB)	
2483.5	61.45	-8.17	53.28	74	20.72	peak
2483.5	54.85	-8.17	46.68	54	7.32	AVG

Remark:

Factor = Antenna Factor + Cable Loss – Pre-amplifier.

All the x/y/z orientation has been investigated, and only worst case is presented in this report.

**6. NUMBER OF HOPPING CHANNEL****6.1****Applied procedures / limit**

FCC Part15 (15.247) , Subpart C				
Section	Test Item	Limit	Frequency Range (MHz)	Result
15.247 (a)(1)(iii)	Number of Hopping Channel	≥15	2400-2483.5	PASS

Spectrum Parameters	Setting
Attenuation	Auto
Span Frequency	> Operating Frequency Range
RB	1MHz
VB	3MHz
Detector	Peak
Trace	Max Hold
Sweep Time	Auto

**6.2 TEST PROCEDURE**

- a. The EUT was directly connected to the spectrum analyzer and antenna output port as show in the block diagram below,
- b. Spectrum Setting: RBW= 1MHz, VBW=3MHz, Sweep time = Auto.

**6.3 DEVIATION FROM STANDARD**

No deviation.

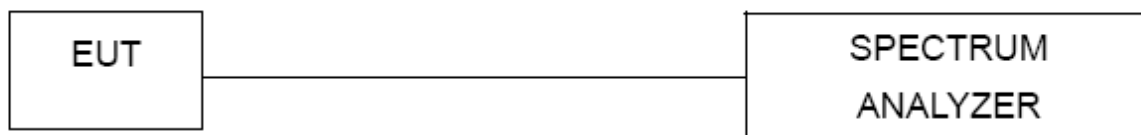
**6.4 TEST SETUP****6.5 EUT OPERATION CONDITIONS**

The EUT tested system was configured as the statements of 2.4 Unless otherwise a special operating condition is specified in the follows during the testing.

### 6.6 TEST RESULTS

EUT	Mobile phone	Model Name	X555
Temperature	25 °C	Relative Humidity	60%
Pressure	1015 hPa	Test Date	August 23, 2016
Test Mode	Hopping Mode	Number of Hopping Channel	79

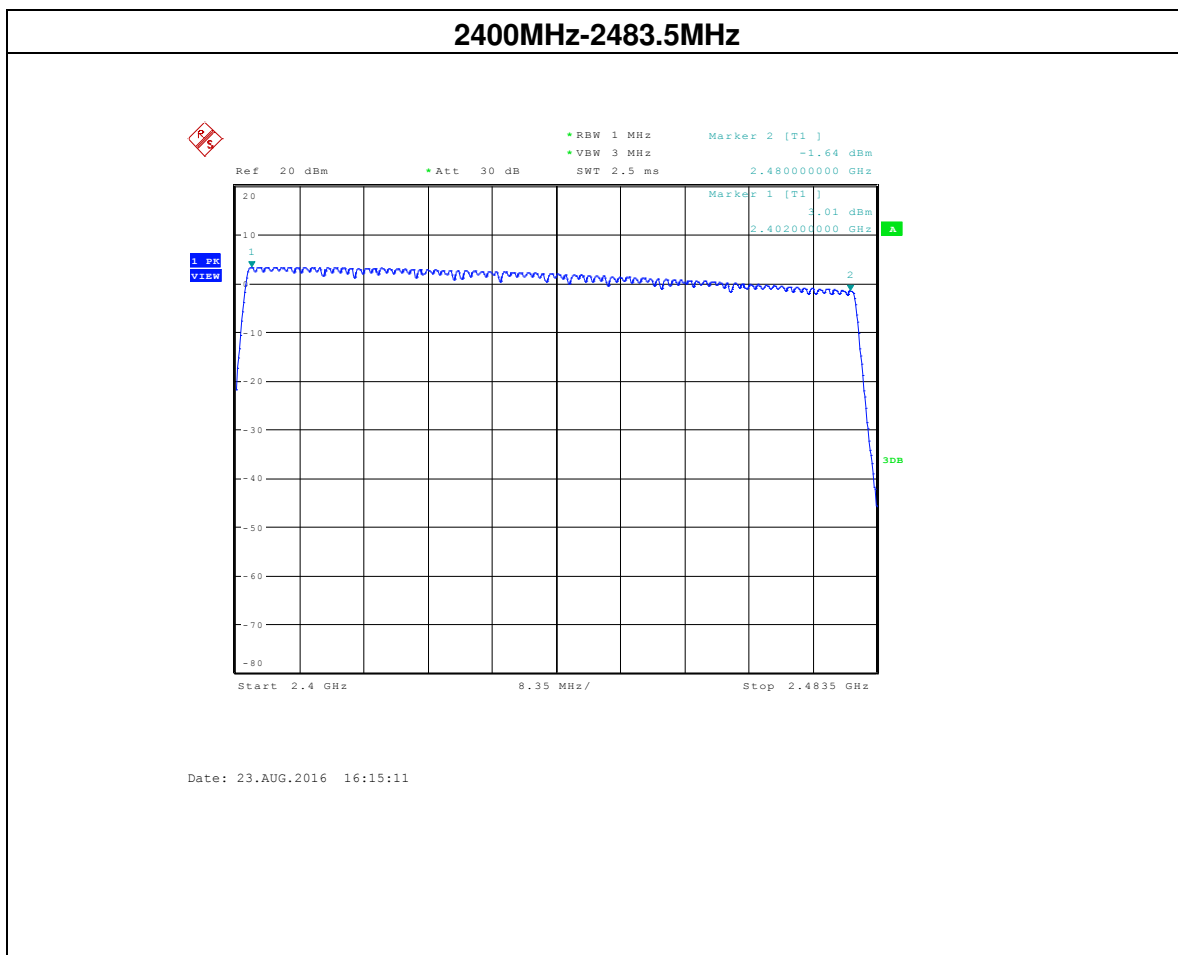

## 7. AVERAGE TIME OF OCCUPANCY

### 7.1 APPLIED PROCEDURES / LIMIT

FCC Part15 (15.247) , Subpart C				
Section	Test Item	Limit	Frequency Range (MHz)	Result
15.247 (a)(1)(iii)	Average Time of Occupancy	0.4sec	2400-2483.5	PASS

### 7.2 TEST PROCEDURE

- a. The EUT test port was connected to the spectrum analyzer with RF cable and antenna connector.
- b. Set RBW of spectrum analyzer to 1MHz and VBW to 3MHz.
- c. Use a video trigger with the trigger level set to enable triggering only on full pulses.
- d. Sweep Time is more than once pulse time.
- e. Set the center frequency on any frequency would be measure and set the frequency span to zero span.
- f. Measure the maximum time duration of one single pulse.
- g. Set the EUT for DH5, DH3 and DH1 packet transmitting.
- h. Measure the maximum time duration of one single pulse.
- i. DH1 Dwell time = Pulse time\*(1600/2/79)\*31.6S  
 DH3 Dwell time = Pulse time\*(1600/4/79)\*31.6S  
 DH5 Dwell time = Pulse time\*(1600/6/79)\*31.6S

### 7.3 DEVIATION FROM STANDARD

No deviation.

## 7.4 TEST SETUP



## 7.5 EUT OPERATION CONDITIONS

The EUT tested system was configured as the statements of 2.4 Unless otherwise a special operating condition is specified in the follows during the testing.

### 7.6 TEST RESULTS

Note: *the worst case is 1Mbps as result in this part.*

EUT	Mobile phone	Model Name	X555
Temperature	25 °C	Relative Humidity	60%
Pressure	1012 hPa	Test Date	August 23, 2016
Test Mode	DH1-1Mbps		

Data Packet	Frequency	Pulse time(ms)	Dwell Time(S)	Limits (S)
DH1	2402MHz	0.553	0.177	0.4
DH1	2441MHz	0.553	0.177	0.4
DH1	2480MHz	0.553	0.177	0.4

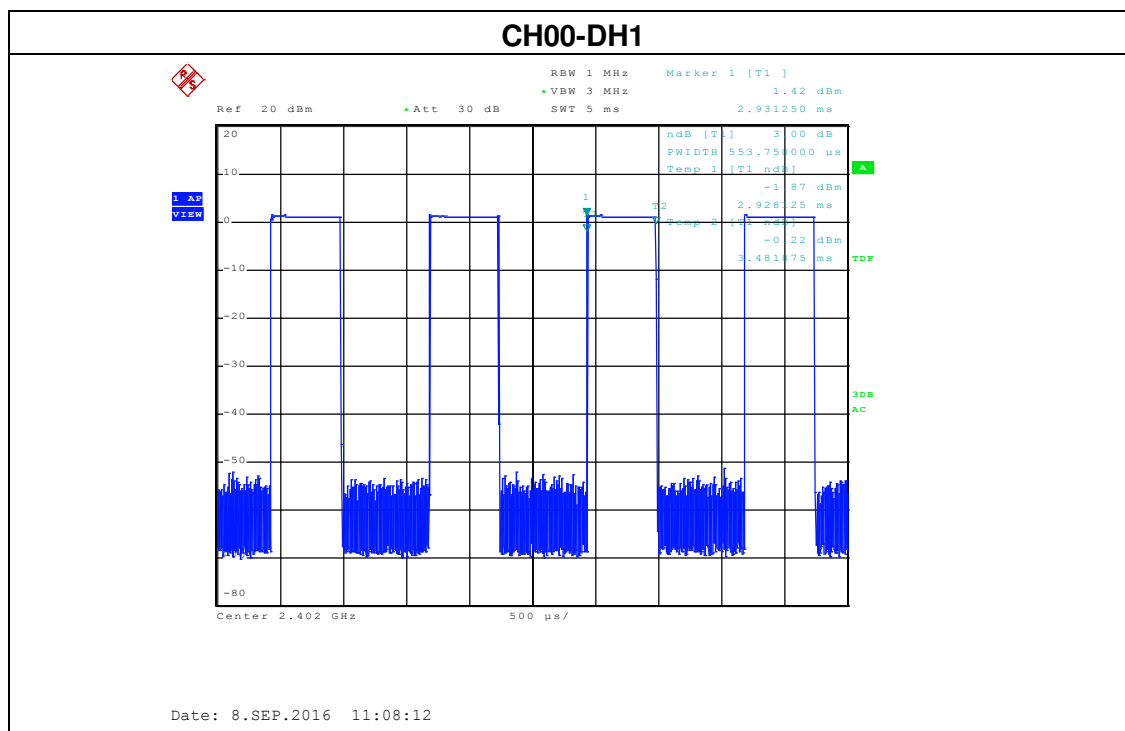

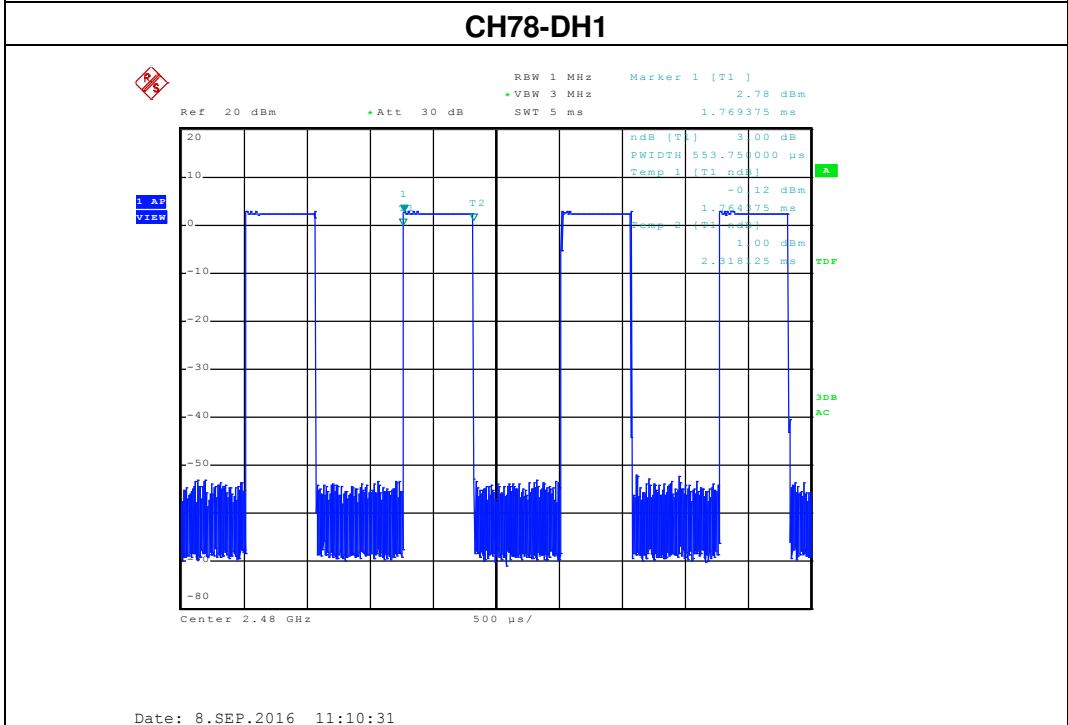
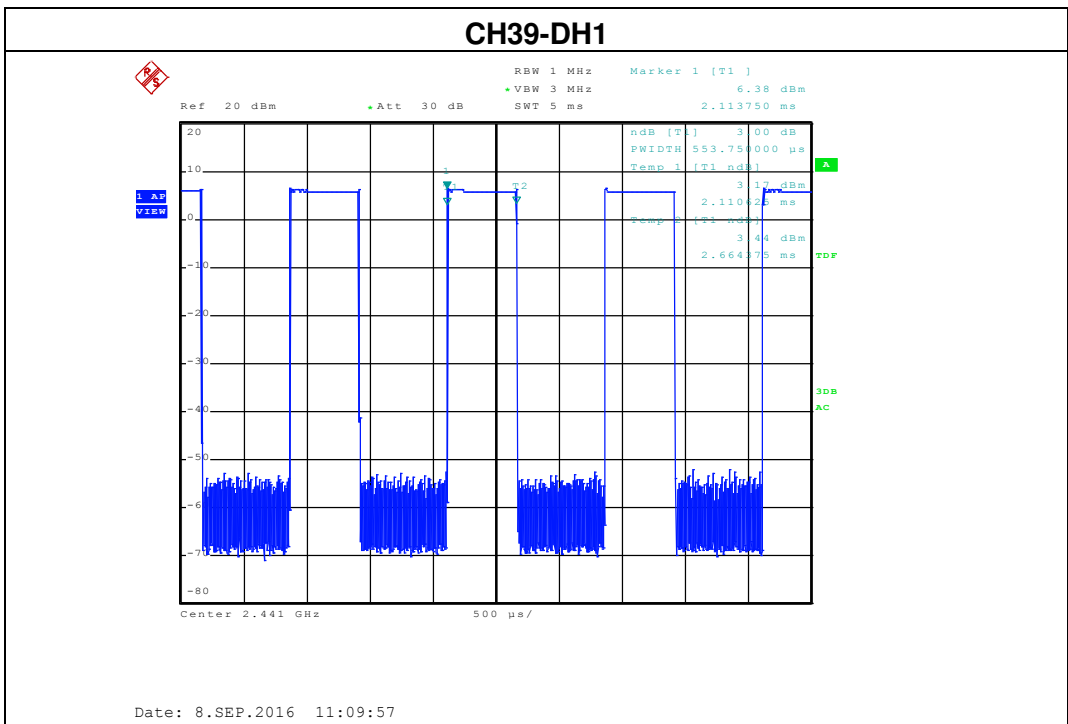

EUT	Mobile phone	Model Name	X555
Temperature	25 °C	Relative Humidity	60%
Pressure	1012 hPa	Test Date	August 23, 2016
Test Mode	DH3-1Mbps		

Data Packet	Frequency	Pulse time(ms)	Dwell Time(S)	Limits (S)
DH3	2402MHz	1.76	0.281	0.4
DH3	2441MHz	1.76	0.281	0.4
DH3	2480MHz	1.76	0.281	0.4

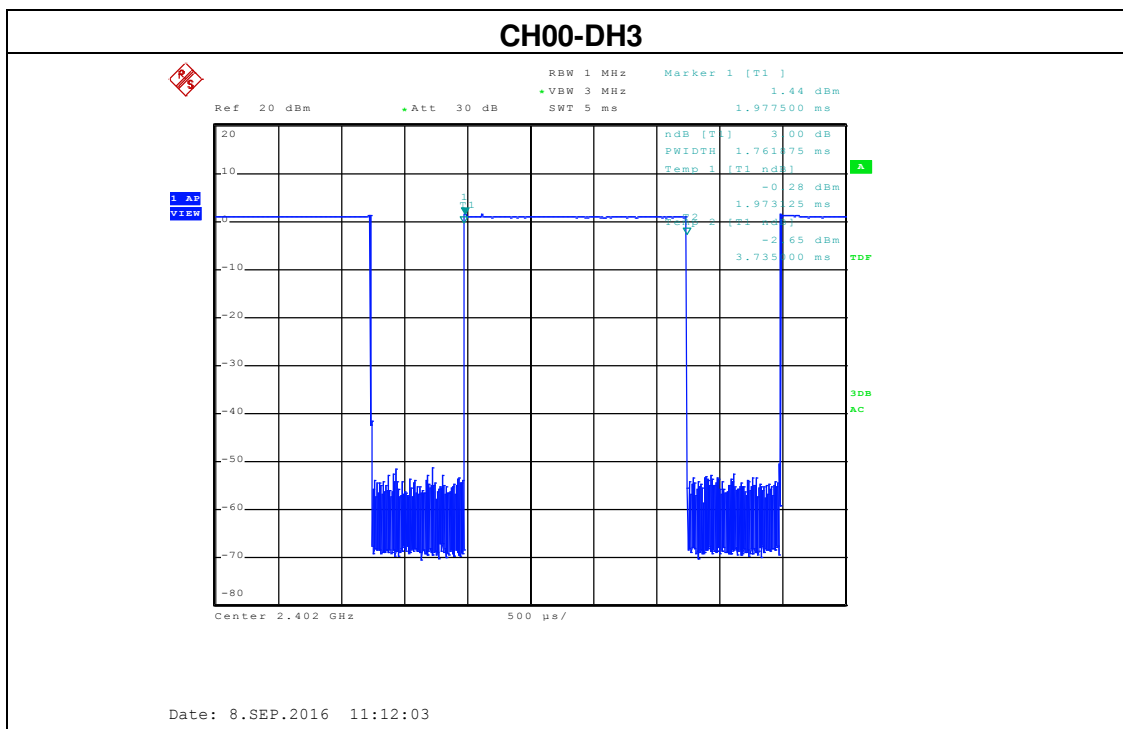



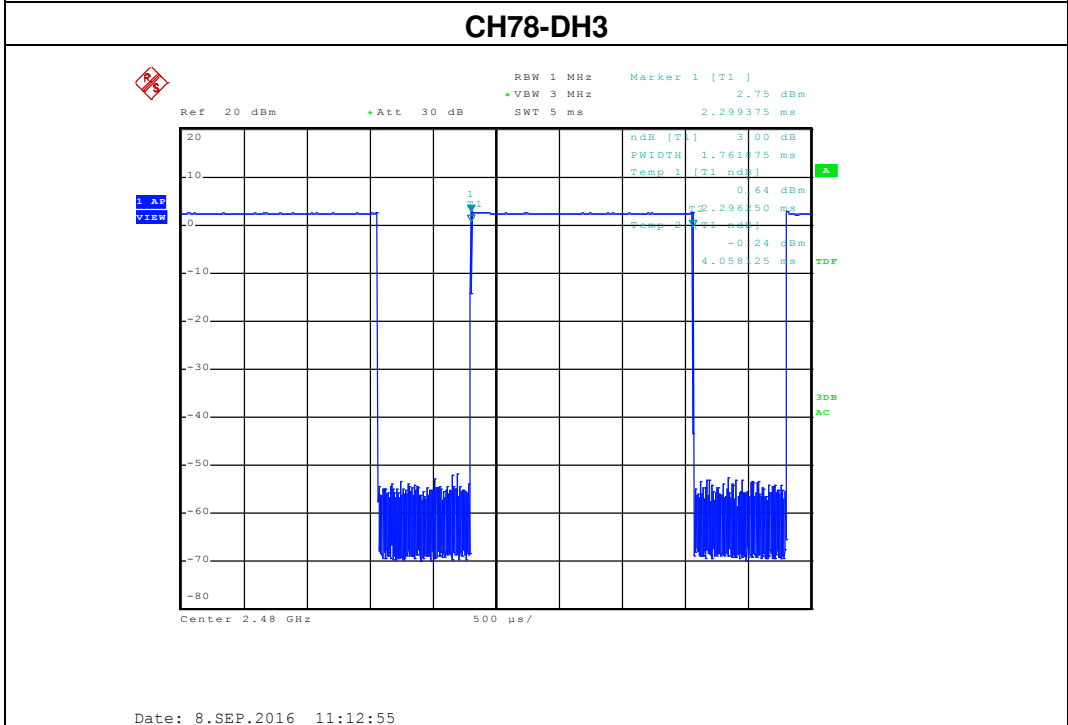
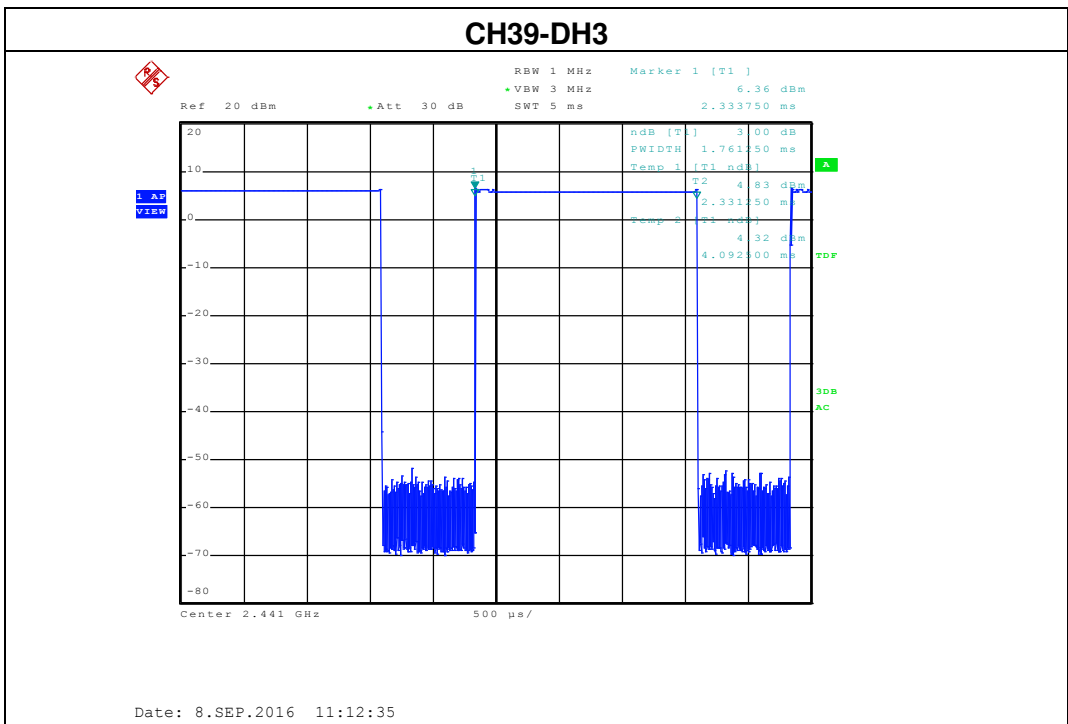

EUT	Mobile phone	Model Name	X555
Temperature	25 °C	Relative Humidity	60%
Pressure	1012 hPa	Test Date	August 23, 2016
Test Mode	DH5-1Mbps		

Data Packet	Frequency	Pulse time(ms)	Dwell Time(S)	Limits (S)
DH5	2402MHz	2.87	0.306	0.4
DH5	2441MHz	2.87	0.306	0.4
DH5	2480MHz	2.87	0.306	0.4

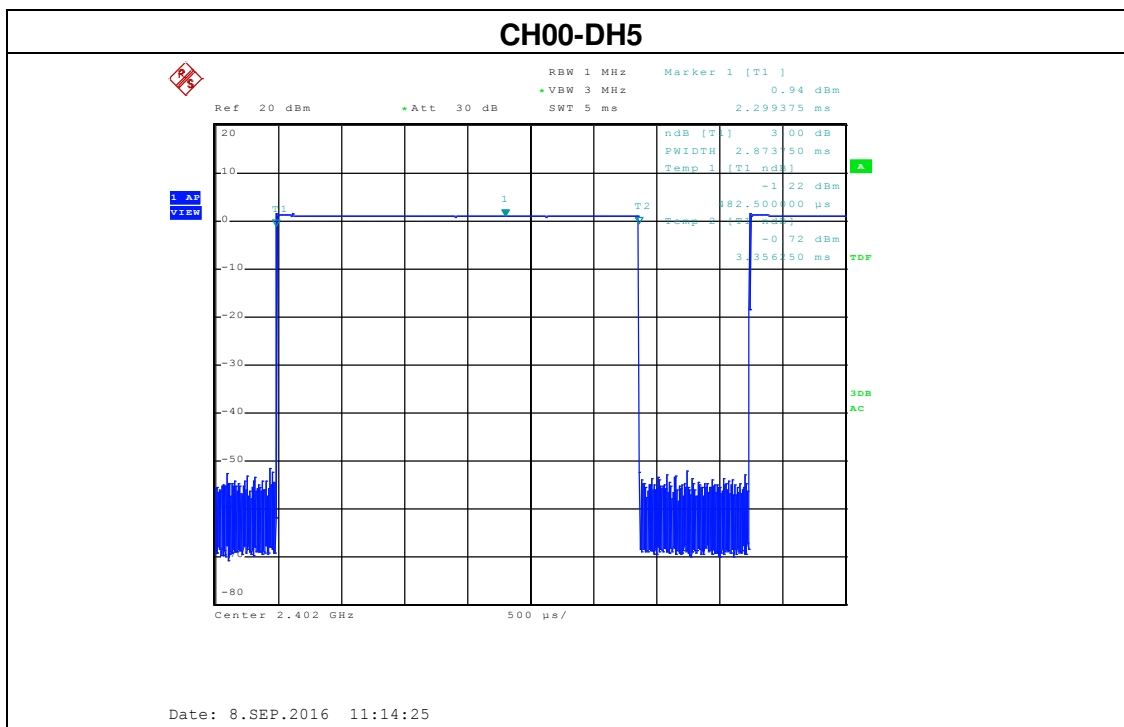

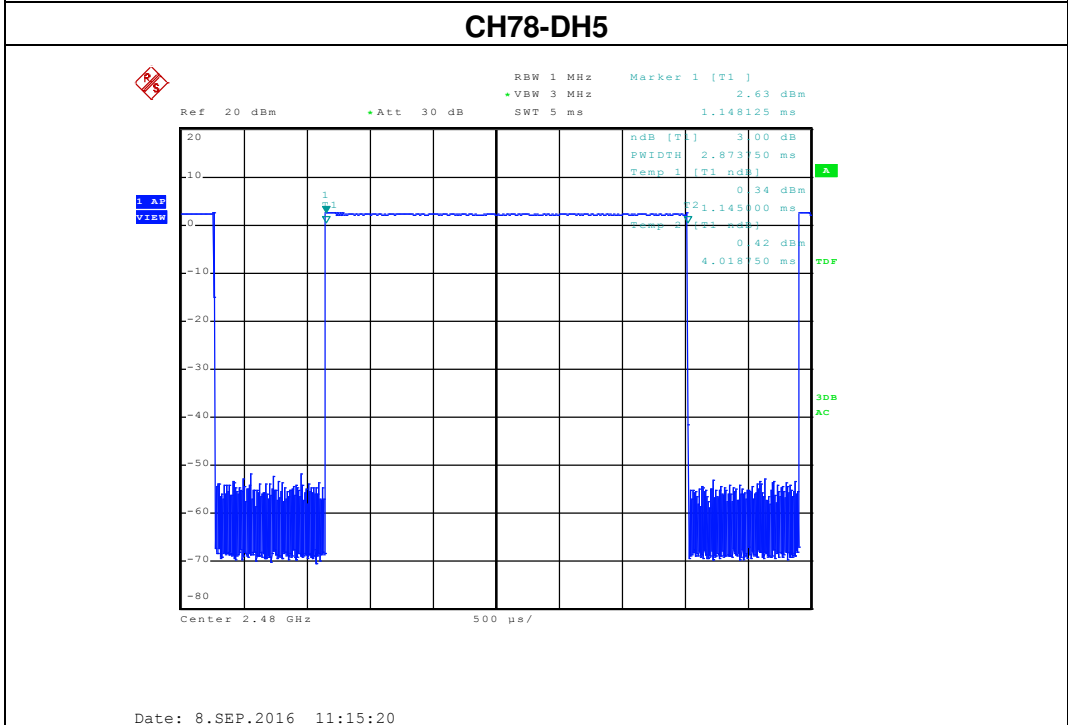
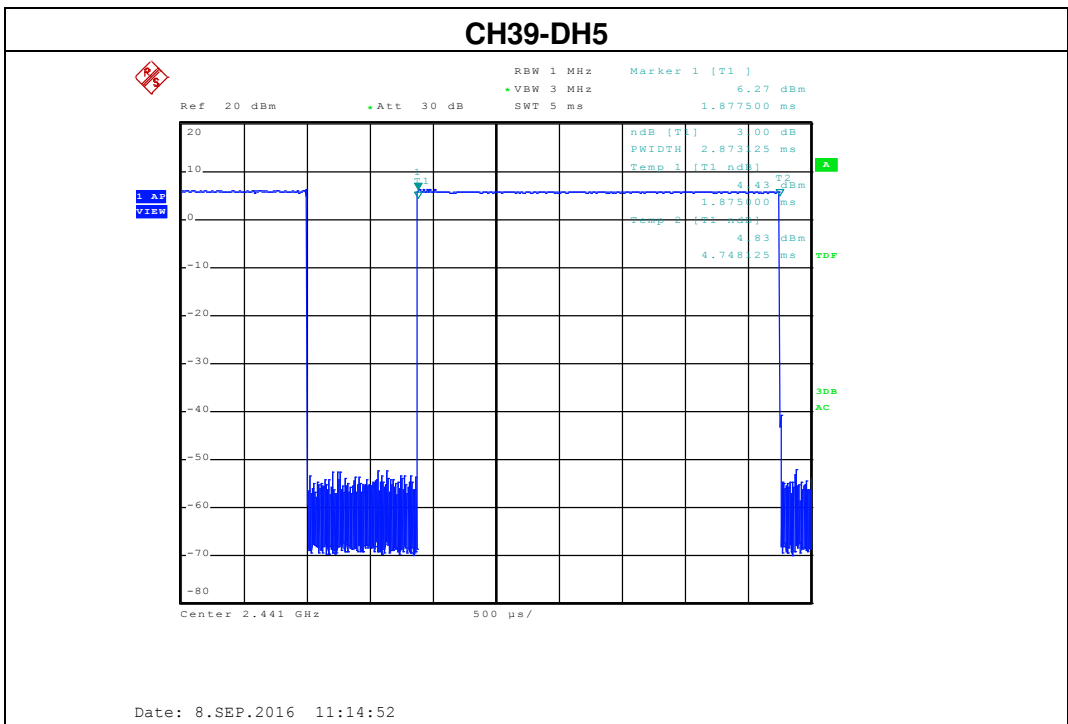

## 8. HOPPING CHANNEL SEPARATION MEASUREMENT

### 8.1 APPLIED PROCEDURES / LIMIT

Frequency hopping systems operating in the 2400-2483.5 MHz band may have hopping channel carrier frequencies that are separated by 25 kHz or two-thirds of the 20 dB bandwidth of the hopping channel, whichever is greater.

Spectrum Parameter	Setting
Attenuation	Auto
Span Frequency	> Measurement Bandwidth or Channel Separation
RB	Resolution (or IF) Bandwidth (RBW) $\geq$ 1% of the span
VB	Video (or Average) Bandwidth (VBW) $\geq$ RBW
Detector	Peak
Trace	Max hold
Sweep Time	Auto

### 8.2 TEST PROCEDURE

1. Check the calibration of the measuring instrument using either an internal calibrator or a known signal from an external generator.
2. Set the spectrum analyzer as follows: Span = wide enough to capture the peaks of two adjacent channels: Resolution (or IF) Bandwidth (RBW)  $\geq$  1% of the span; Video (or Average) Bandwidth (VBW)  $\geq$  RBW; Sweep = auto; Detector function = peak; Trace = max hold
3. Measure the separation between the peaks of the adjacent channels using the marker-delta function.
4. Repeat above procedures until all frequencies measured were complete.

### 8.3 DEVIATION FROM STANDARD

No deviation.

### 8.4 TEST SETUP

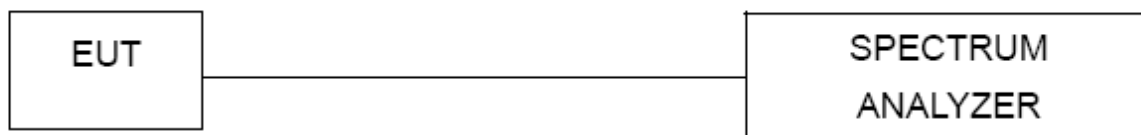

### 8.5 EUT OPERATION CONDITIONS

The EUT was programmed to be in continuously transmitting mode.

**8.6 TEST RESULTS**

EUT	Mobile phone	Model Name	X555
Temperature	25 °C	Relative Humidity	60%
Pressure	1012 hPa	Test Result	Pass
Test Mode	CH00 / CH39 /CH78 (1Mbps Mode)	Test Date	August 23, 2016

Channel number	Channel frequency (MHz)	Separation Read value (KHz)	Separation limit (KHz)
00	2402	1000	1000
39	2441	1000	1000
78	2480	1000	1000

Note: 20db bandwidth refer to section 6.1.5

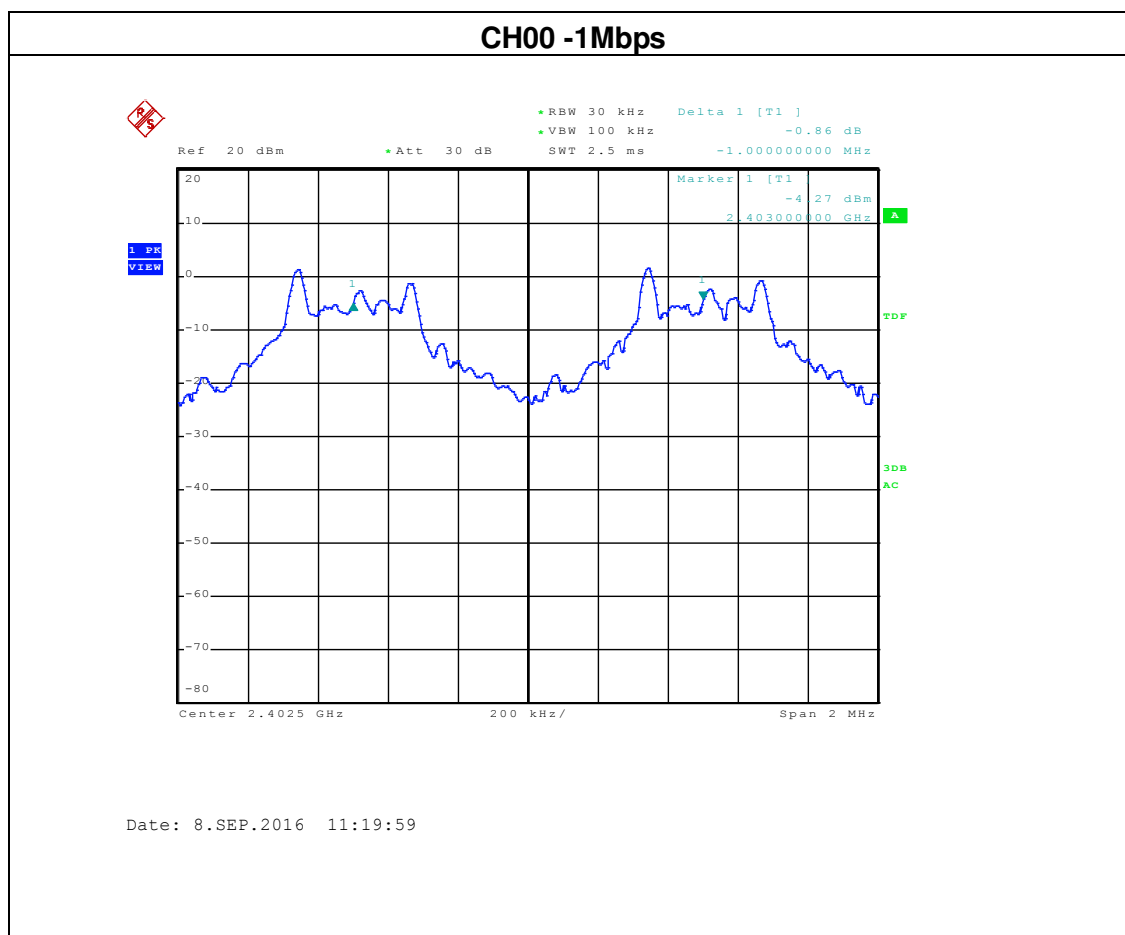

### CH39 -1Mbps

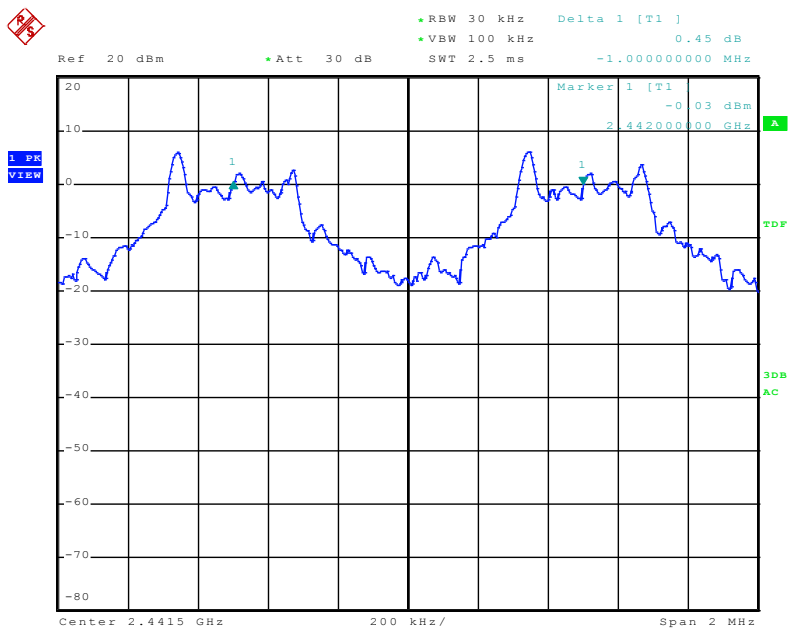

Date: 8.SEP.2016 11:21:58

### CH78 -1Mbps

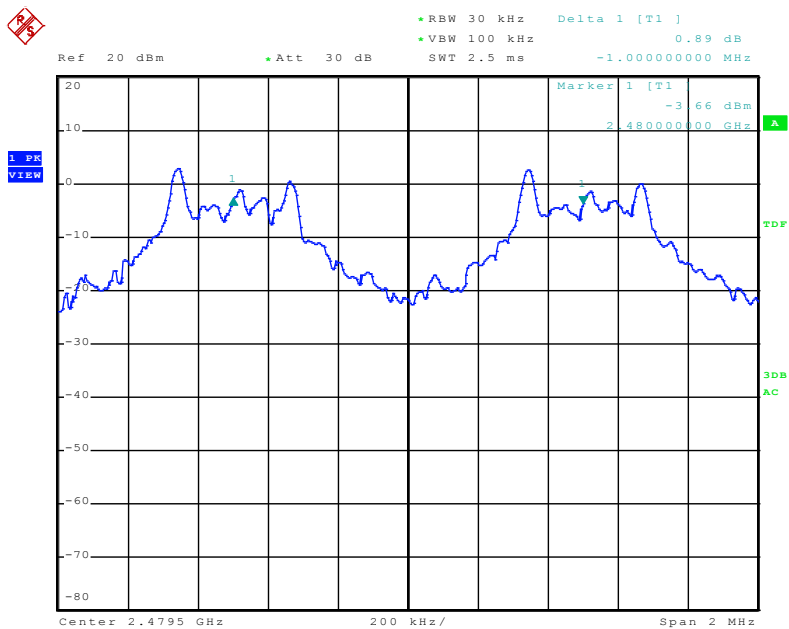

Date: 8.SEP.2016 11:22:53

EUT	Mobile phone	Model Name	X555
Temperature	25 °C	Relative Humidity	60%
Pressure	1012 hPa	Test Result	Pass
Test Mode	CH00 / CH39 /CH78 (2Mbps Mode)	Test Date	August 23, 2016

Channel number	Channel frequency (MHz)	Separation Read value (KHz)	Separation limit (KHz)
00	2402	1000	1000
39	2441	1000	1000
78	2480	1000	1000

Note: 20db bandwidth refer to section 6.1.5

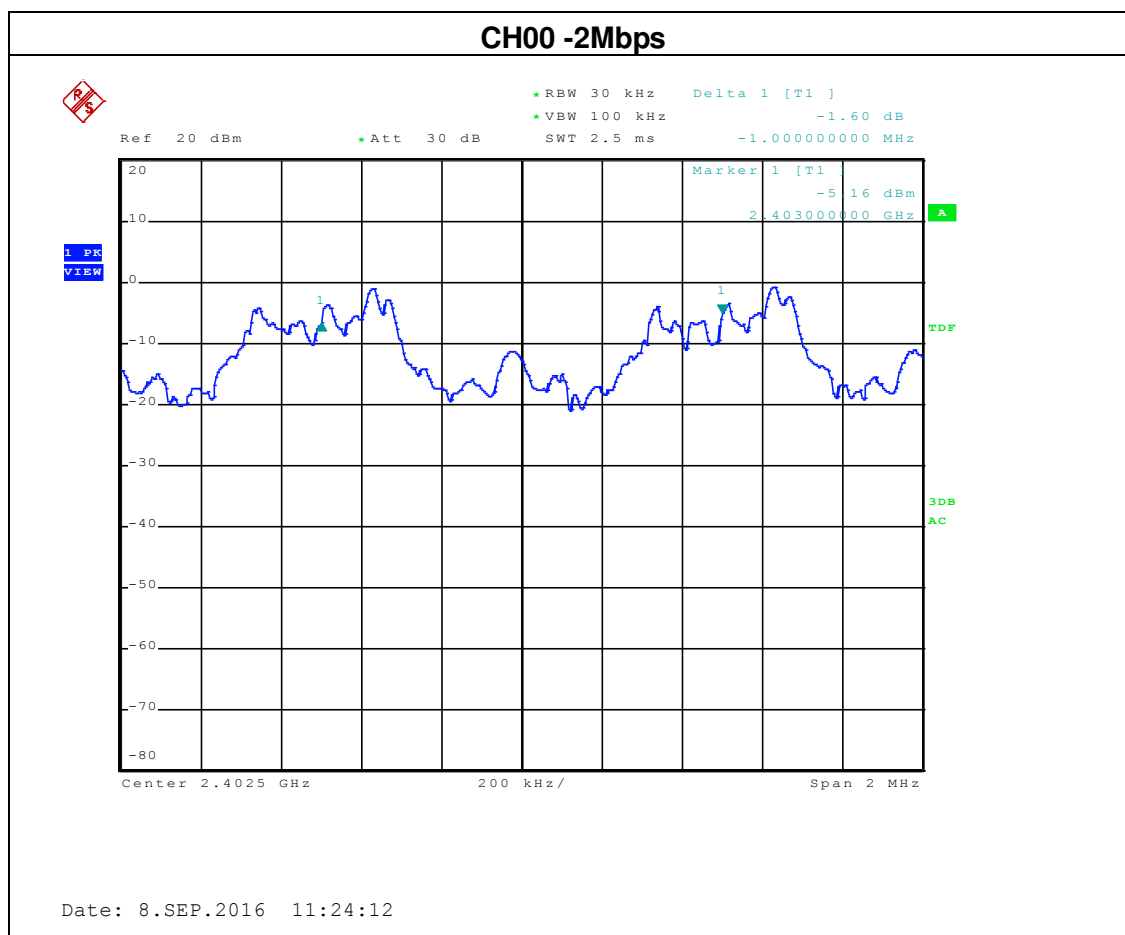

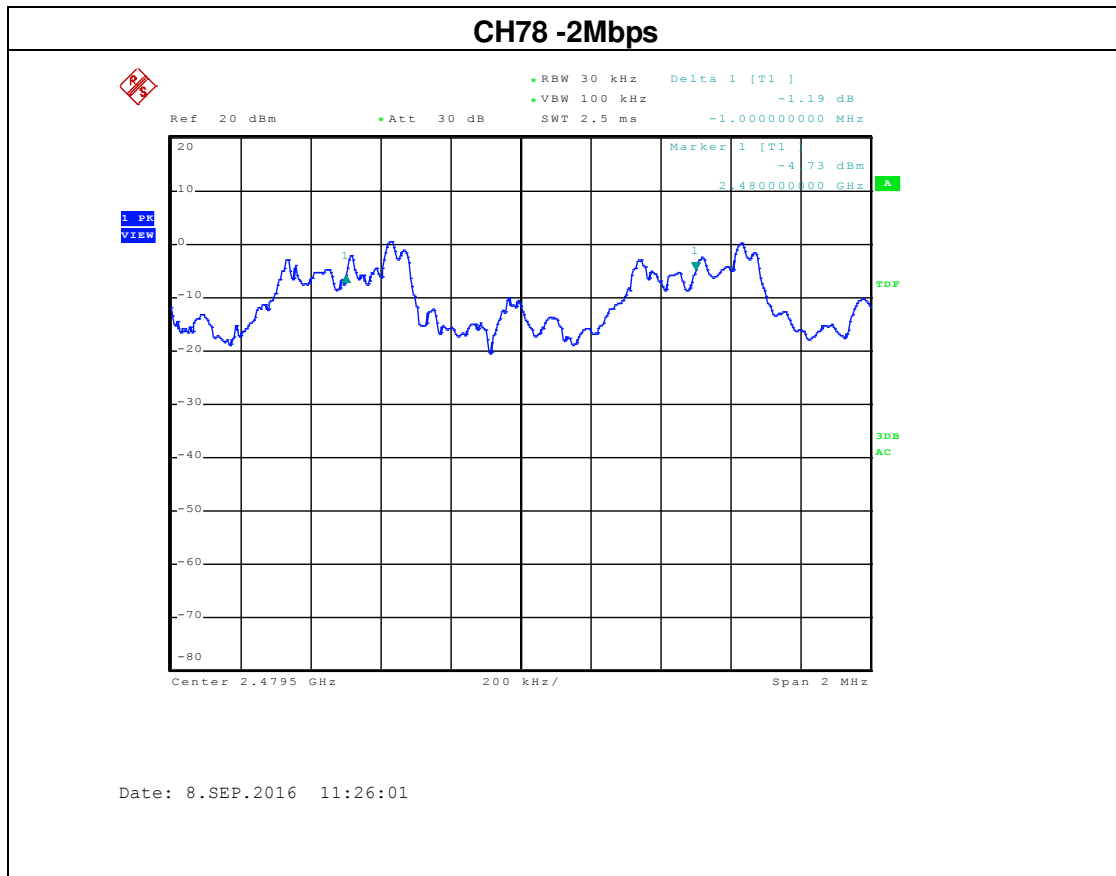
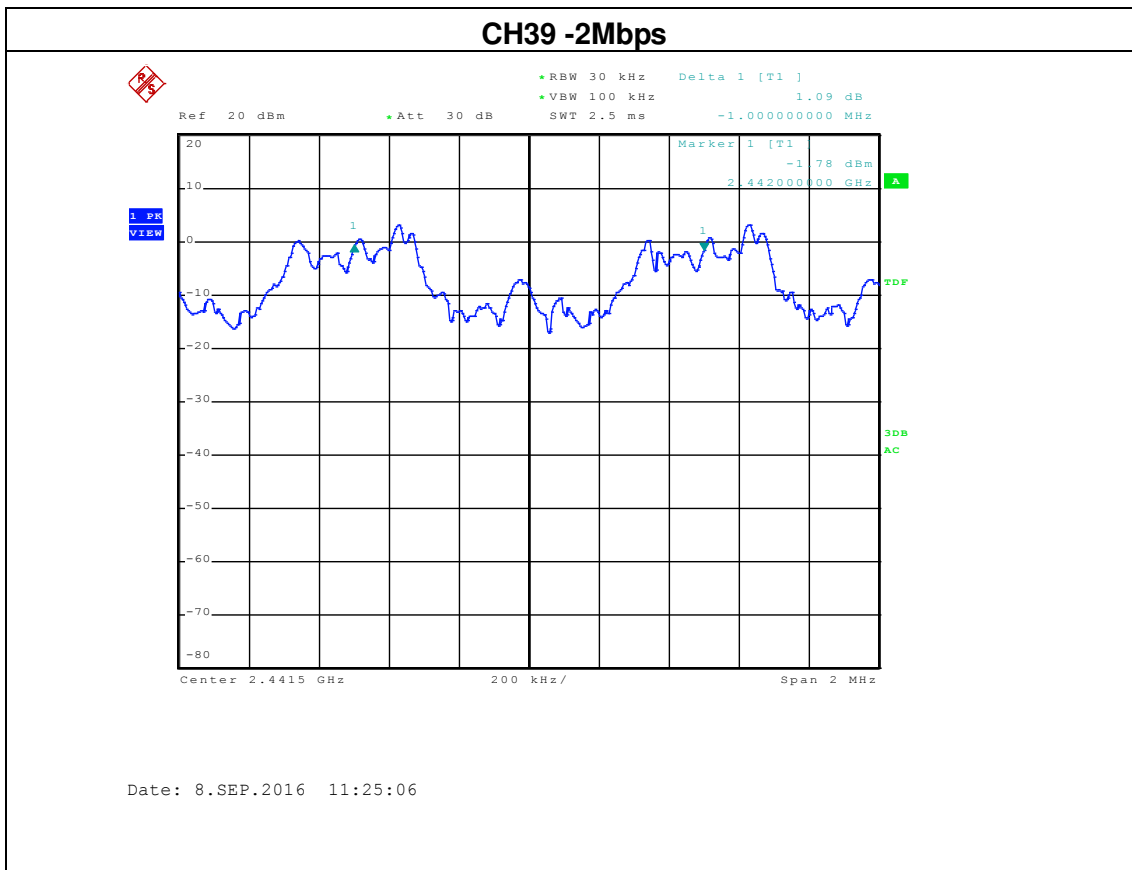



EUT	Mobile phone	Model Name	X555
Temperature	25 °C	Relative Humidity	60%
Pressure	1012 hPa	Test Result	Pass
Test Mode	CH00 / CH39 /CH78 (3Mbps Mode)	Test Date	August 23, 2016

Channel number	Channel frequency (MHz)	Separation Read value (KHz)	Separation limit (KHz)
00	2402	1000	1000
39	2441	1000	1000
78	2480	1000	1000

Note: 20db bandwidth refer to section 6.1.5

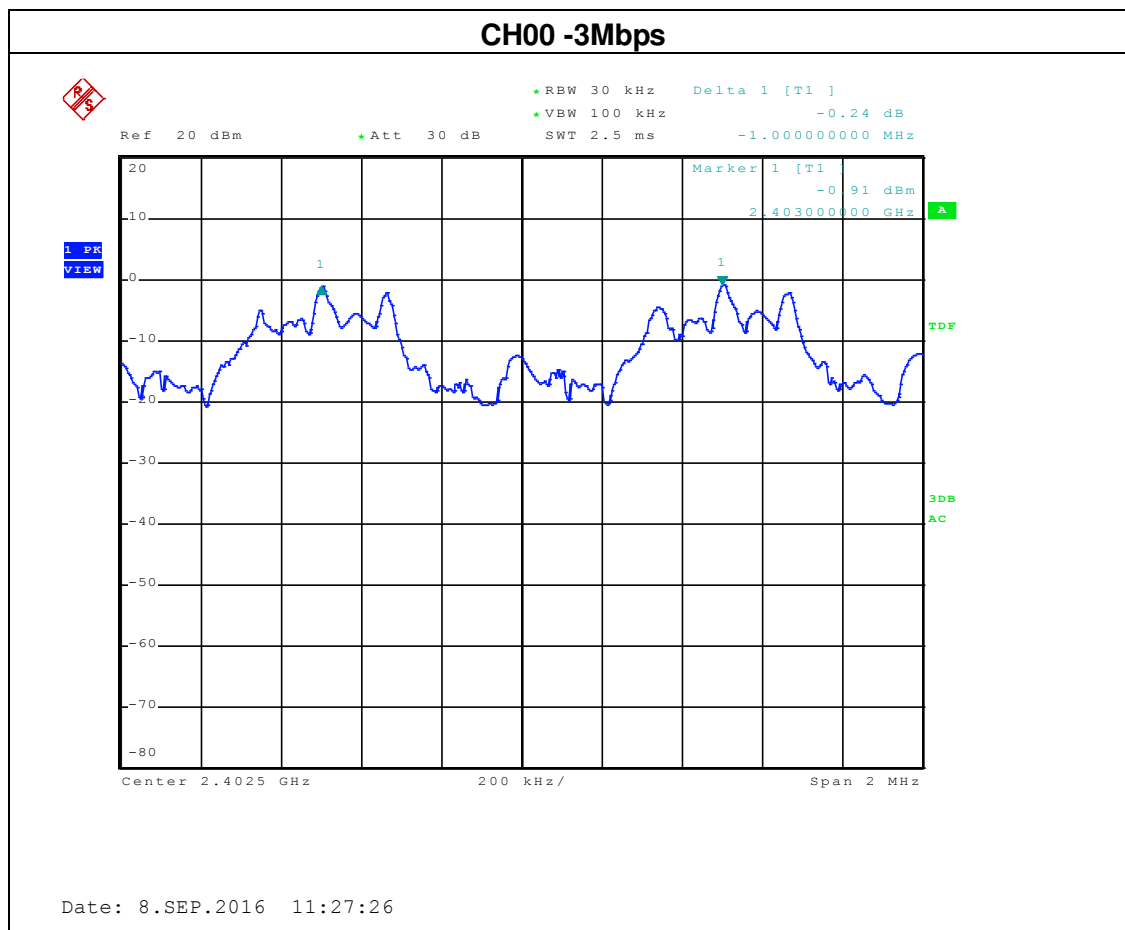

### CH39 -3Mbps

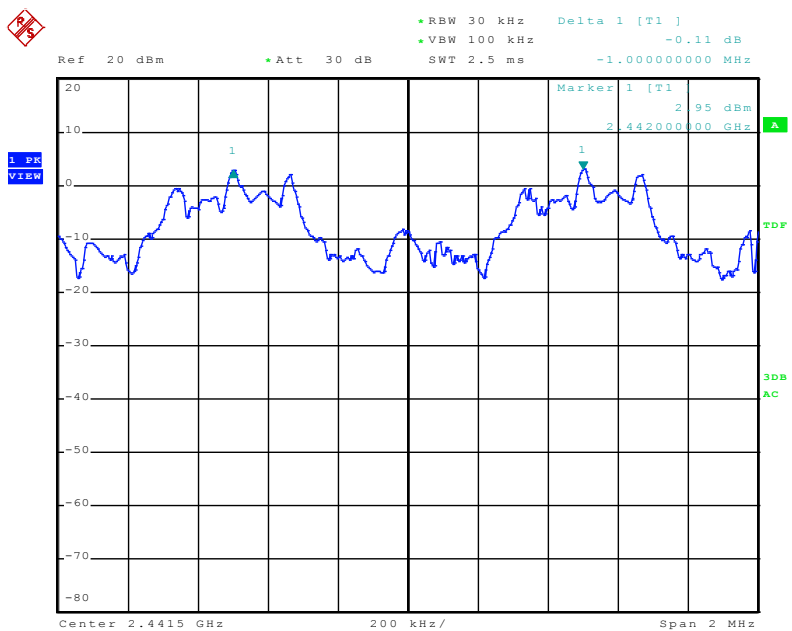

Date: 8.SEP.2016 11:28:15

### CH78 -3Mbps

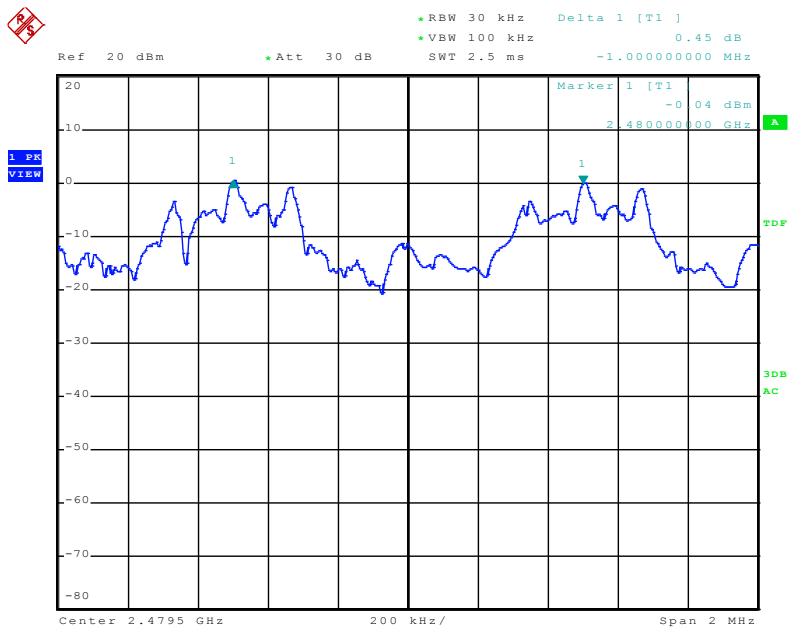

Date: 8.SEP.2016 11:29:32

**9. BANDWIDTH TEST****9.1 APPLIED PROCEDURES / LIMIT**

FCC Part15 (15.247) , Subpart C				
Section	Test Item	Limit	Frequency Range (MHz)	Result
15.247 (a)(1)	Bandwidth	(20dB bandwidth)	2400-2483.5	PASS

Spectrum Parameter	Setting
Attenuation	Auto
Span Frequency	> Measurement Bandwidth or Channel Separation
RB	30kHz
VB	100 kHz
Detector	Peak
Trace	Max hold
Sweep Time	Auto

**9.2 TEST PROCEDURE**

1. Check the calibration of the measuring instrument (spectrum analyzer) using either an internal calibrator or a known signal from an external generator.
2. Set the spectrum analyzer as follows: VBW =30kHz, RBW=100kHz, Sweep = auto Detector function = peak ,Trace = max hold
3. Measure the highest amplitude appearing on spectral display and record the level to calculate results.
4. Repeat above procedures until all frequencies measured were complete.

**9.3 DEVIATION FROM STANDARD**

No deviation.

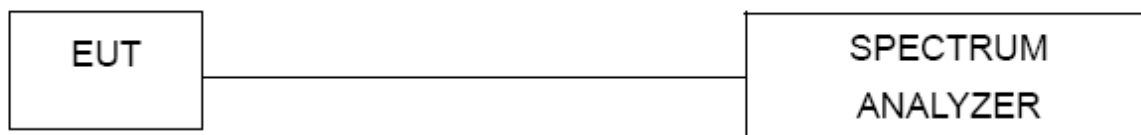
**9.4 TEST SETUP****9.5 EUT OPERATION CONDITIONS**

The EUT tested system was configured as the statements of 2.4 Unless otherwise a special operating condition is specified in the follows during the testing.

### 9.6 TEST RESULTS

Note: *the worst case is DH5 as result in this part.*

EUT	Mobile phone	Model Name	X555
Temperature	25 °C	Relative Humidity	60%
Pressure	1012 hPa	Test Mode	CH00/CH39/C78(1Mbps)
Test Date	August 23, 2016		

Frequency	20dB Bandwidth (kHz)	Result
2402 MHz	828	PASS
2441 MHz	834	PASS
2480 MHz	816	PASS

#### CH00 -1Mbps

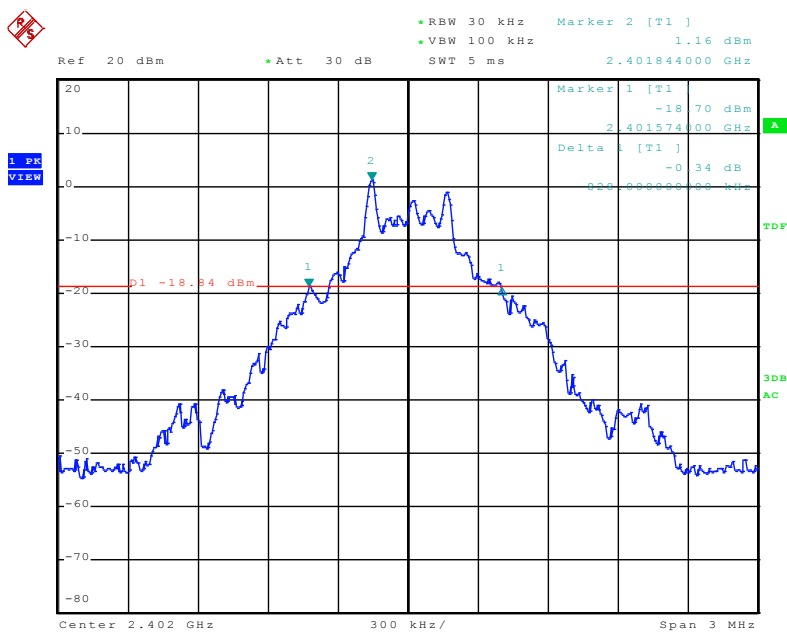

Date: 8.SEP.2016 11:33:25

### CH39 -1Mbps

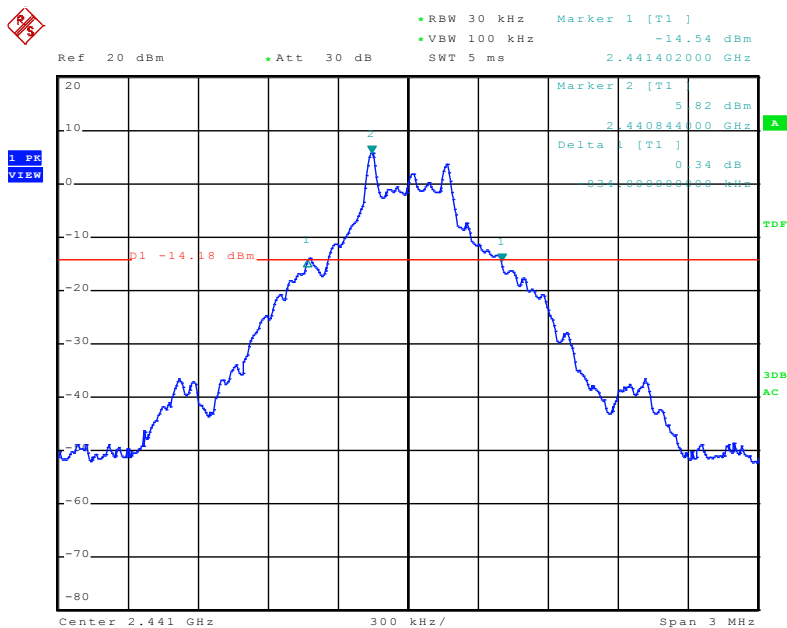

Date: 8.SEP.2016 11:35:02

### CH78 -1Mbps

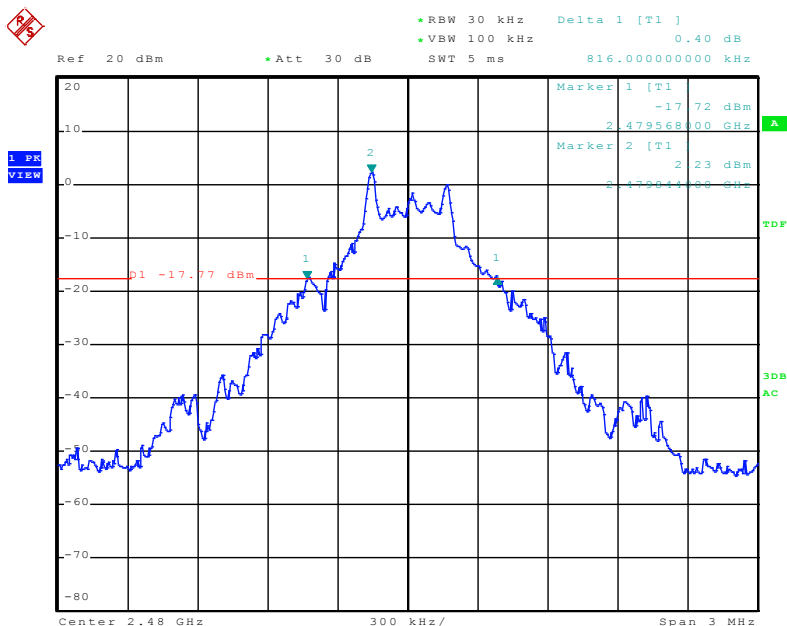

Date: 8.SEP.2016 11:35:55

Note: *the worst case is DH5 as result in this part.*

EUT	Mobile phone	Model Name	X555
Temperature	25 °C	Relative Humidity	60%
Pressure	1012 hPa	Test Mode	CH00/CH39/C78(2Mbps)
Test Date	August 23, 2016		

Frequency	20dB Bandwidth (kHz)	Result
2402 MHz	1122	PASS
2441 MHz	1122	PASS
2480 MHz	1122	PASS

**CH00 -2Mbps**

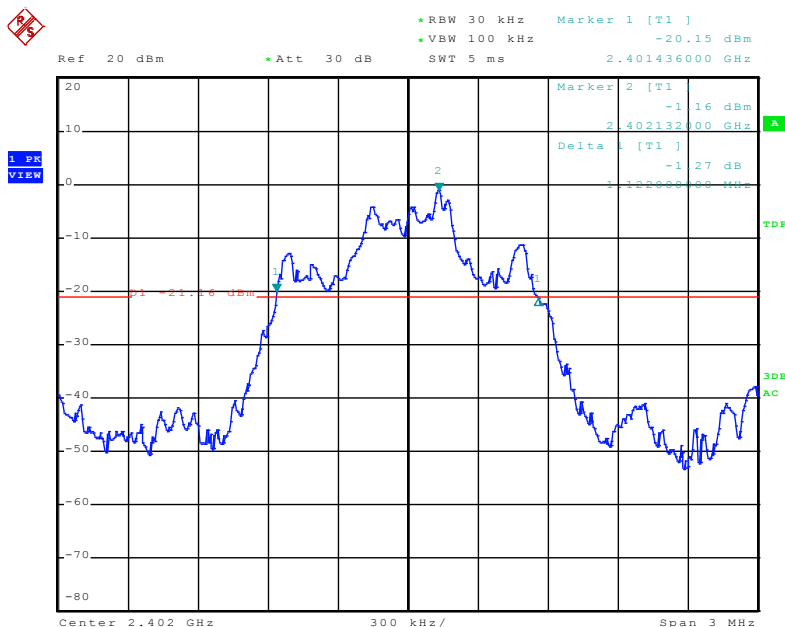

Date: 8.SEP.2016 11:37:16

### CH39 -2Mbps

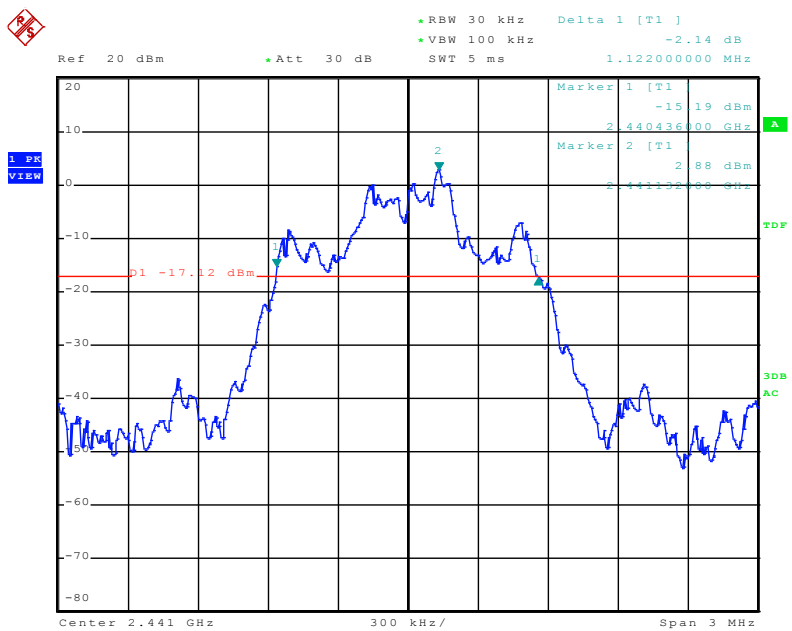

Date: 8.SEP.2016 11:38:09

### CH78 -2Mbps

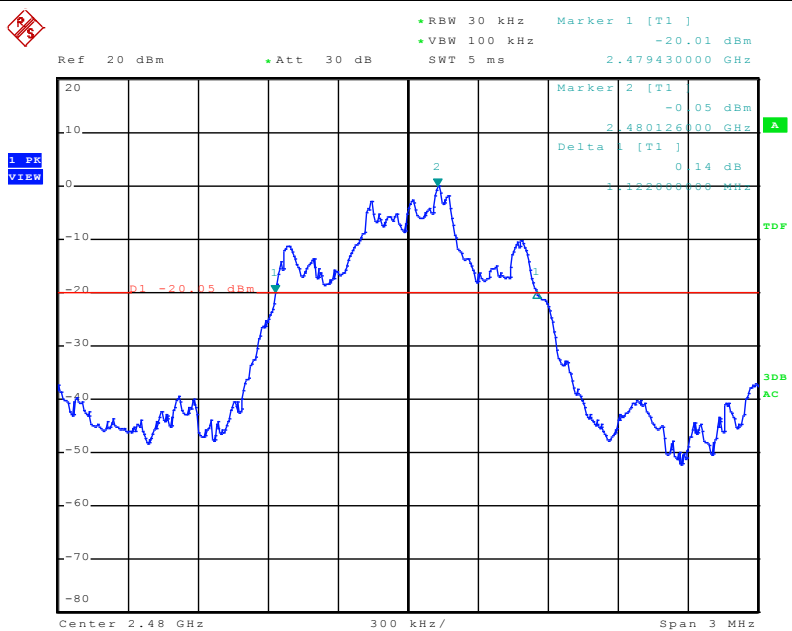

Date: 8.SEP.2016 11:39:01

Note: *the worst case is DH5 as result in this part.*

EUT	Mobile phone	Model Name	X555
Temperature	25 °C	Relative Humidity	60%
Pressure	1012 hPa	Test Mode	CH00/CH39/C78(3Mbps)
Test Date	August 23, 2016		

Frequency	20dB Bandwidth (kHz)	Result
2402 MHz	1122	PASS
2441 MHz	1104	PASS
2480 MHz	1116	PASS

### CH00 -3Mbps

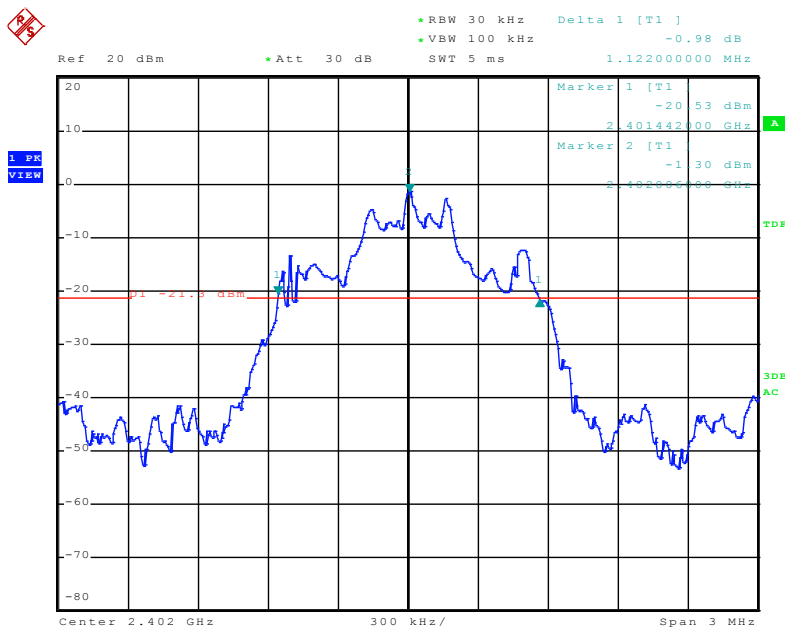

Date: 8.SEP.2016 11:40:04



### CH39 -3Mbps

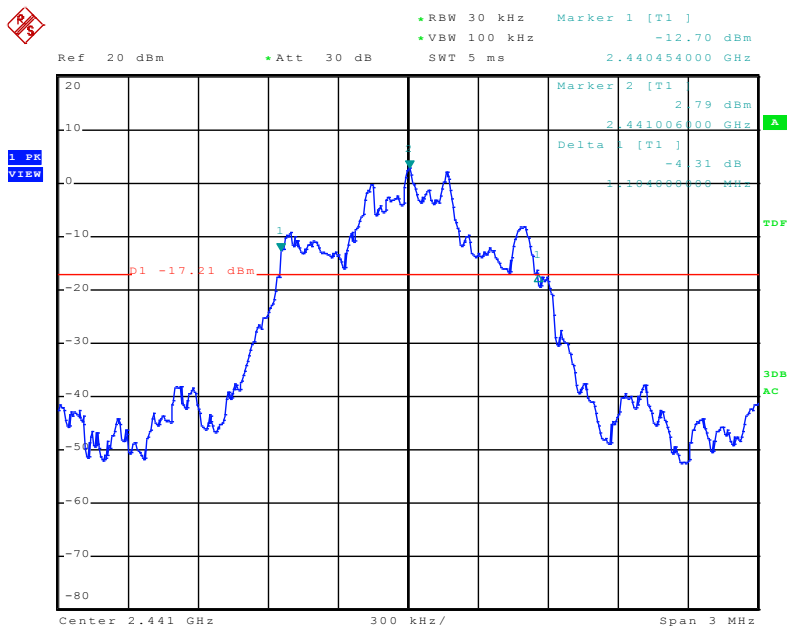

Date: 8.SEP.2016 11:41:31

### CH78 -3Mbps

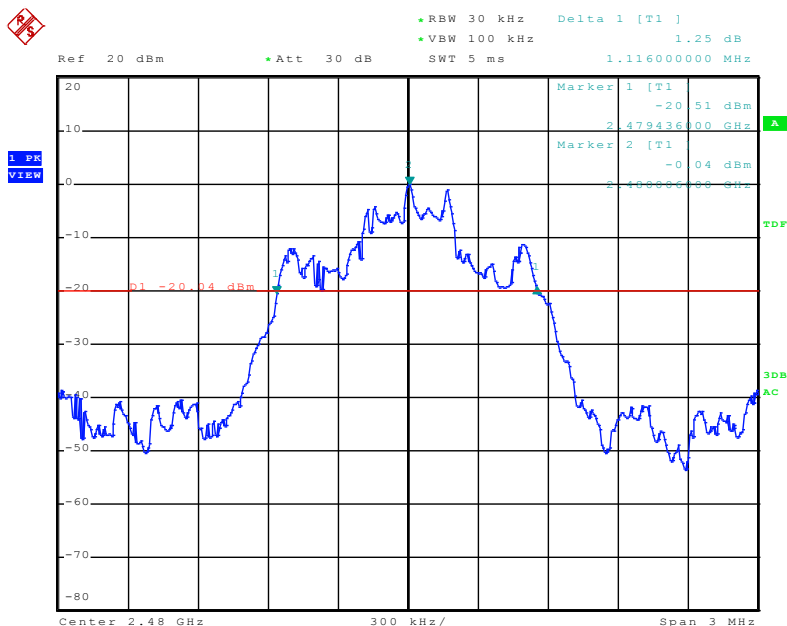

Date: 8.SEP.2016 11:42:49

**10. PEAK OUTPUT POWER TEST****10.1 APPLIED PROCEDURES / LIMIT**

FCC Part15 (15.247) , Subpart C				
Section	Test Item	Limit	Frequency Range (MHz)	Result
15.247 (b)(i)	Peak Output Power	1W for 1Mbps 0.125W for 2/3Mbps	2400-2483.5	PASS

**10.2 TEST PROCEDURE**

- a. The EUT was directly connected to the spectrum analyzer and antenna output port as show in the block diagram below,
- b. Setting : RBW  $\geq$  the 20 dB bandwidth of the emission being measured
  - Span  $\geq$  approximately 3 times the 20 dB bandwidth, centered on a hopping channel
  - VBW  $\geq$  RBW
  - Sweep = auto
  - Detector function = peak
  - Trace = max hold

**10.3 DEVIATION FROM STANDARD**

No deviation.

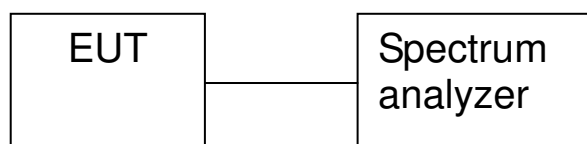
**10.4 TEST SETUP****10.5 EUT OPERATION CONDITIONS**

The EUT tested system was configured as the statements of 2.4 Unless otherwise a special operating condition is specified in the follows during the testing.

**10.6 TEST RESULTS**

EUT	Mobile phone	Model Name	X555
Temperature	25 °C	Relative Humidity	60%
Pressure	1012 hPa	Test Mode	CH00/ CH39 /CH78 (1M/2M/3Mbps Mode)
Test Date	August 23, 2015		

Test Channel	Frequency (MHz)	Peak Output Power (dBm)	LIMIT(dBm)	Result
<b>1Mbps</b>				
CH00	2402	1.16	30	Pass
CH39	2441	<b>6.22</b>	30	Pass
CH78	2480	2.58	30	Pass
<b>2Mbps</b>				
CH00	2402	0.07	20.97	Pass
CH39	2441	<b>4.84</b>	20.97	Pass
CH78	2480	1.57	20.97	Pass
<b>3Mbps</b>				
CH00	2402	0.04	20.97	Pass
CH39	2441	<b>4.72</b>	20.97	Pass
CH78	2480	1.56	20.97	Pass

### 1Mbps Channel: Low

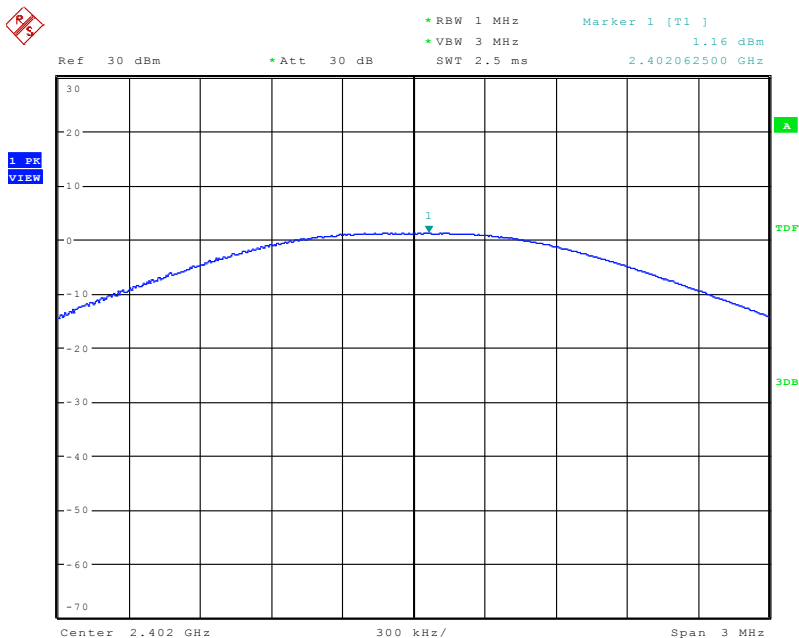

Date: 7.SEP.2016 15:59:18

### Channel: Middle

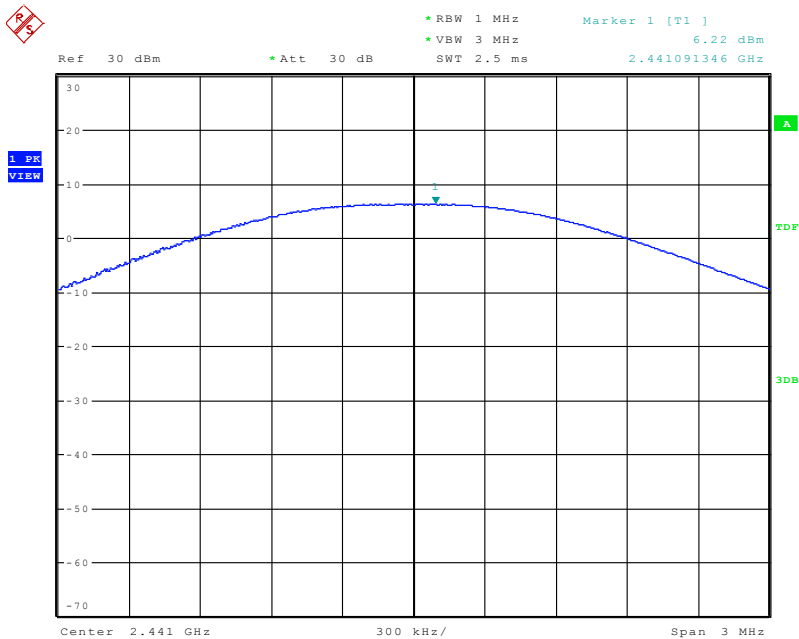

Date: 7.SEP.2016 16:01:25

### Channel: High

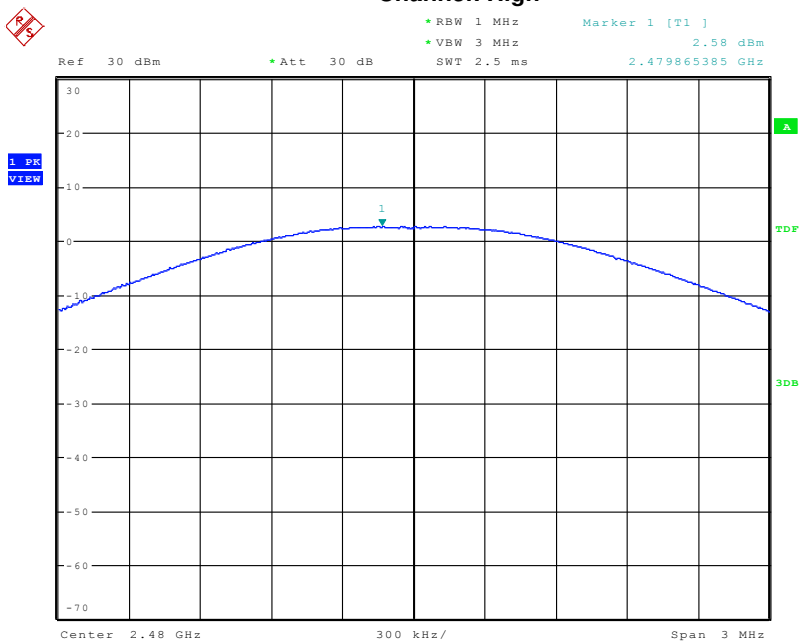

Date: 7.SEP.2016 16:03:26

### 2Mbps Channel: Low

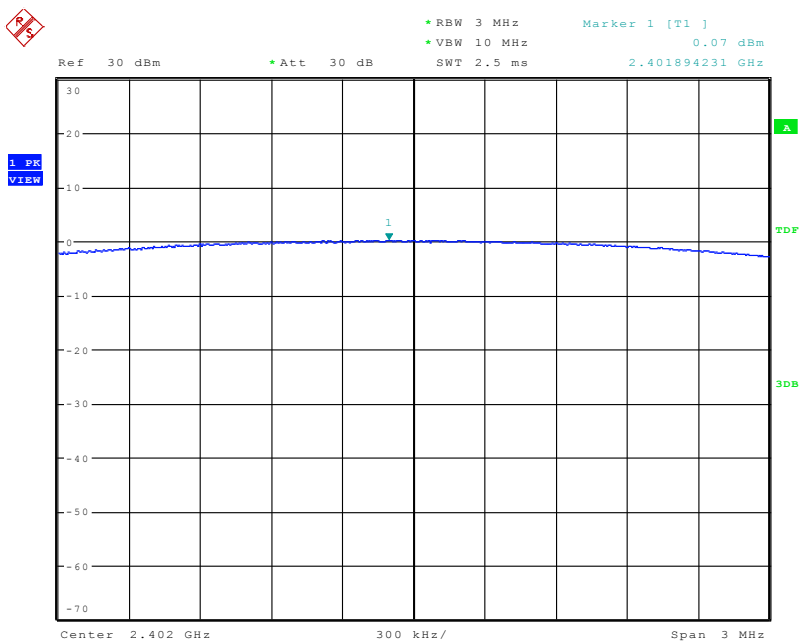

Date: 7.SEP.2016 16:04:01

### Channel: Middle

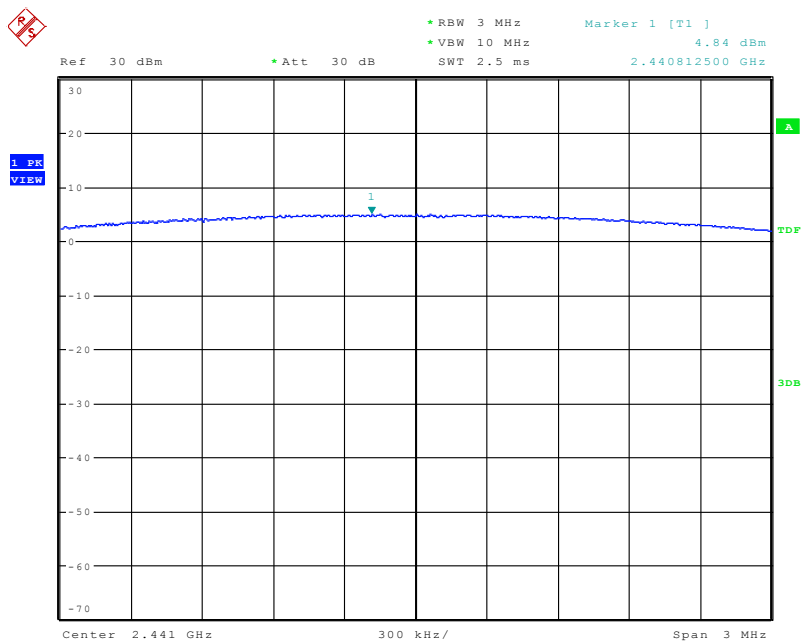

Date: 7.SEP.2016 16:04:16

### Channel: High

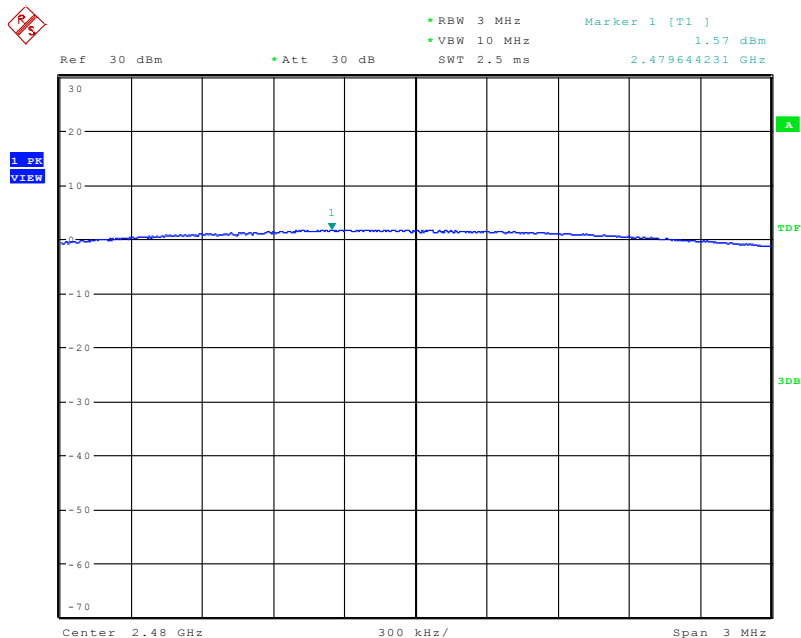

Date: 7.SEP.2016 16:04:29

### 3Mbps Channel: Low

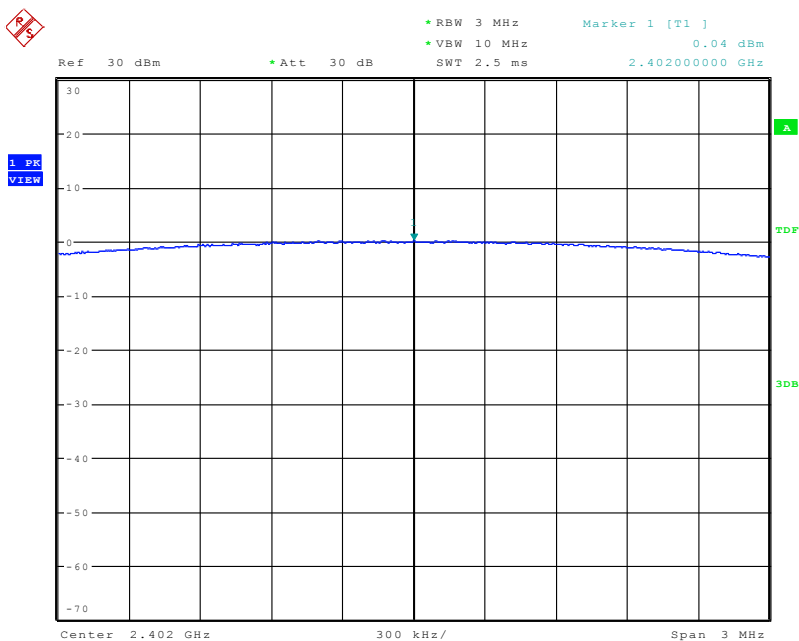

Date: 7.SEP.2016 16:04:56

### Channel: Middle

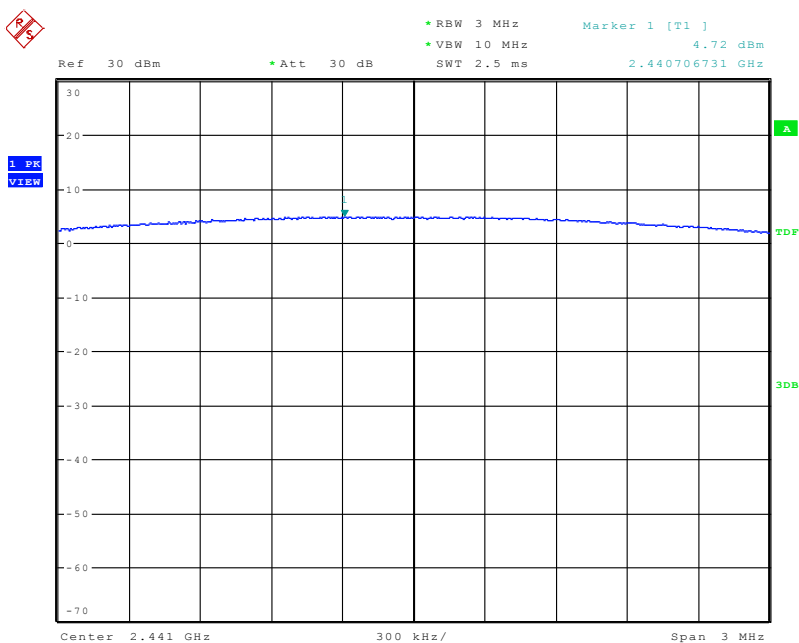

Date: 7.SEP.2016 16:05:11

### Channel: High

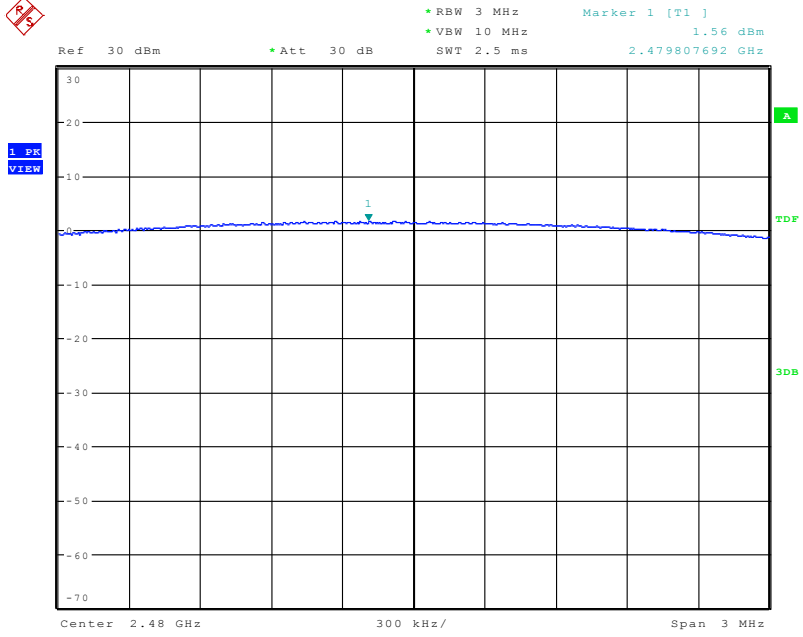

Date: 7.SEP.2016 16:05:23



### 11. 100KHZ BAND EDGES MEASUREMENT

#### 11.1 APPLIED PROCEDURES / LIMIT

FCC Part15 (15.247) , Subpart C				
Section	Test Item	Limit	Frequency Range (MHz)	Result
15.247 (d)	Band Edges Measurement	(20dB bandwidth)	2400-2483.5	PASS

**1Mbps  
Channel: Low**

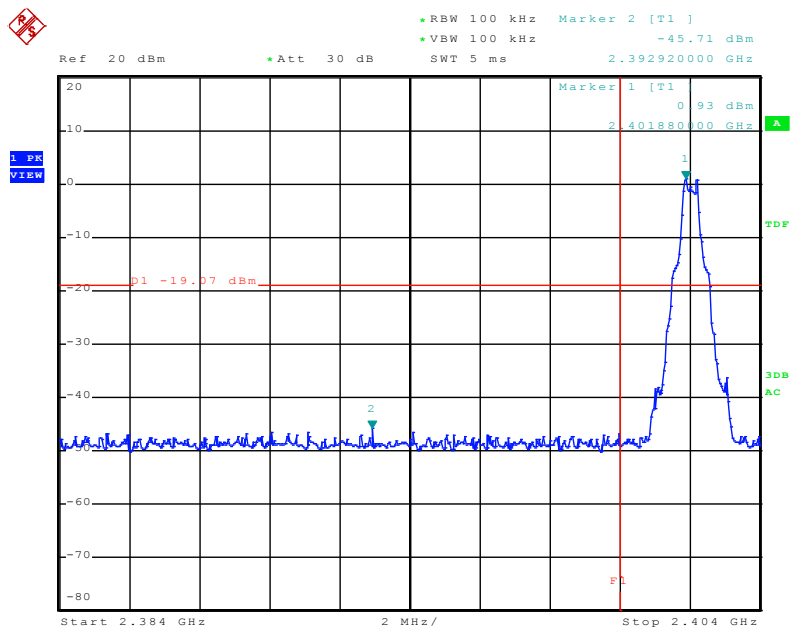

Date: 8.SEP.2016 11:47:04

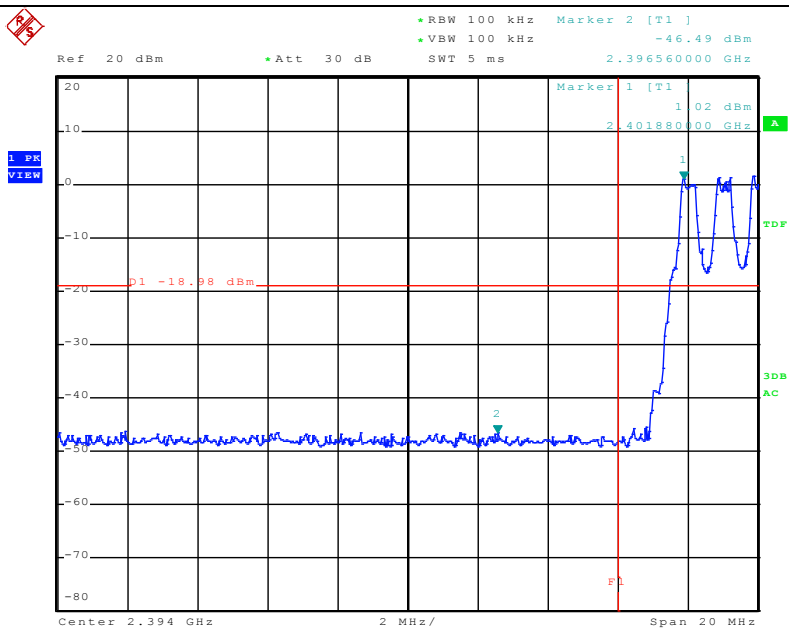

Date: 8.SEP.2016 11:49:46

**Channel: High**

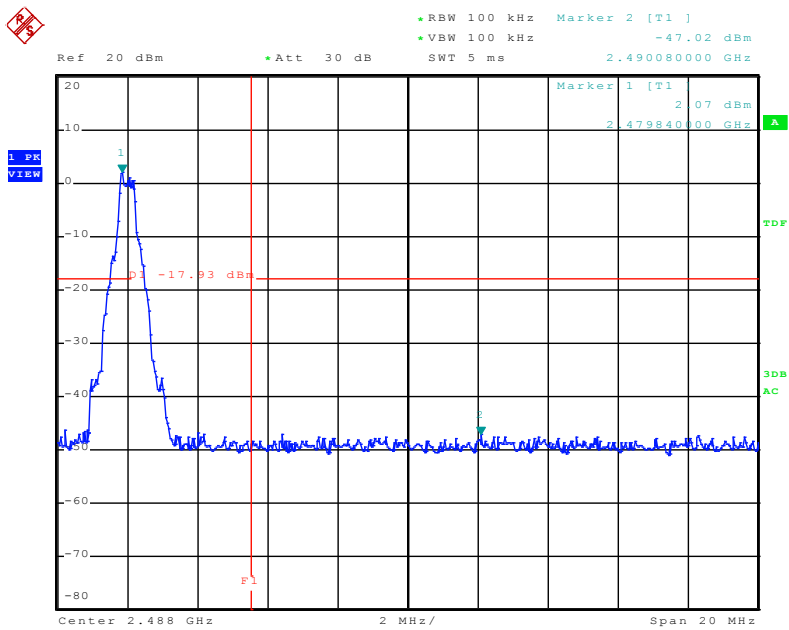

Date: 8.SEP.2016 12:04:19

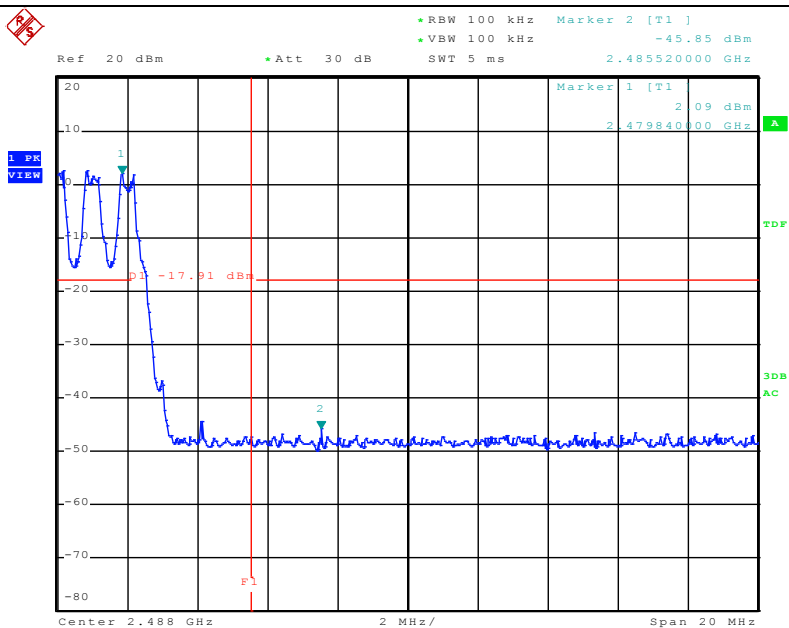

Date: 8.SEP.2016 12:05:09

### 2Mbps Channel: Low

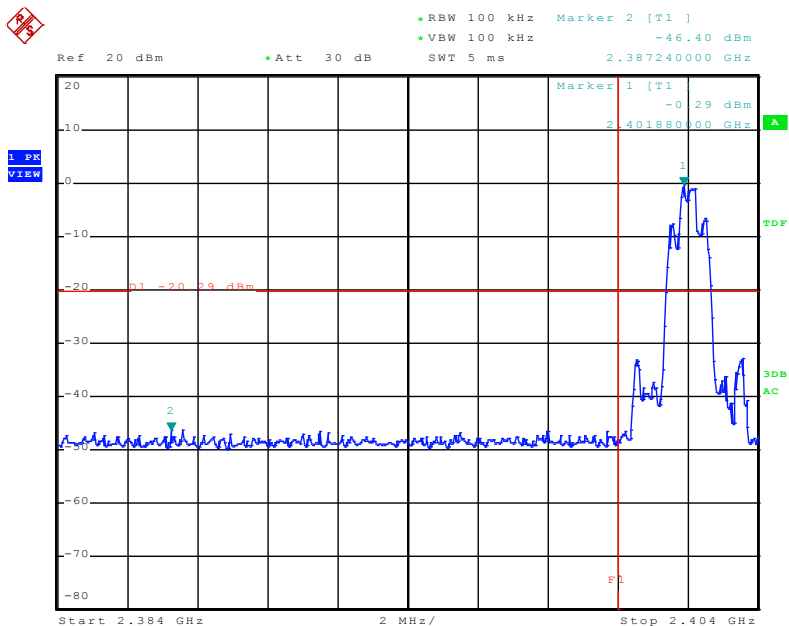

Date: 8.SEP.2016 11:50:40

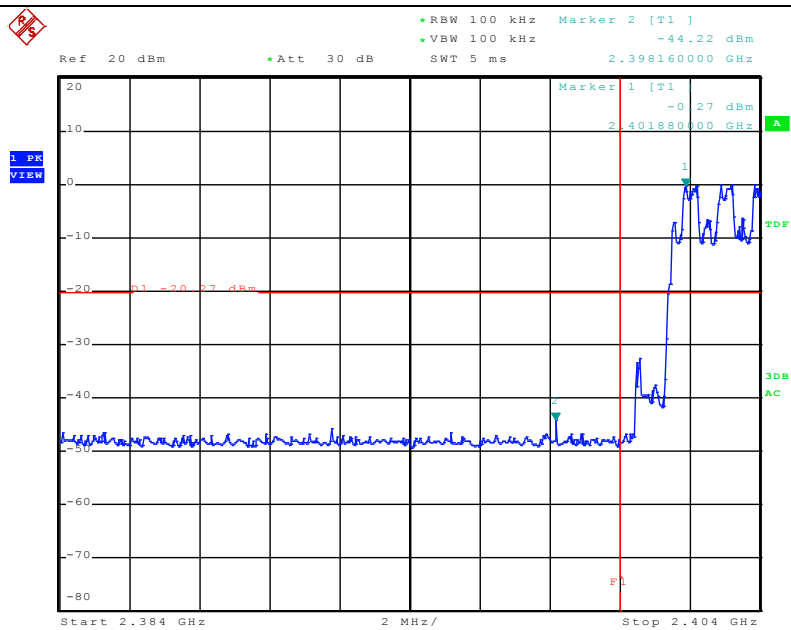

Date: 8.SEP.2016 11:51:49

### Channel: High

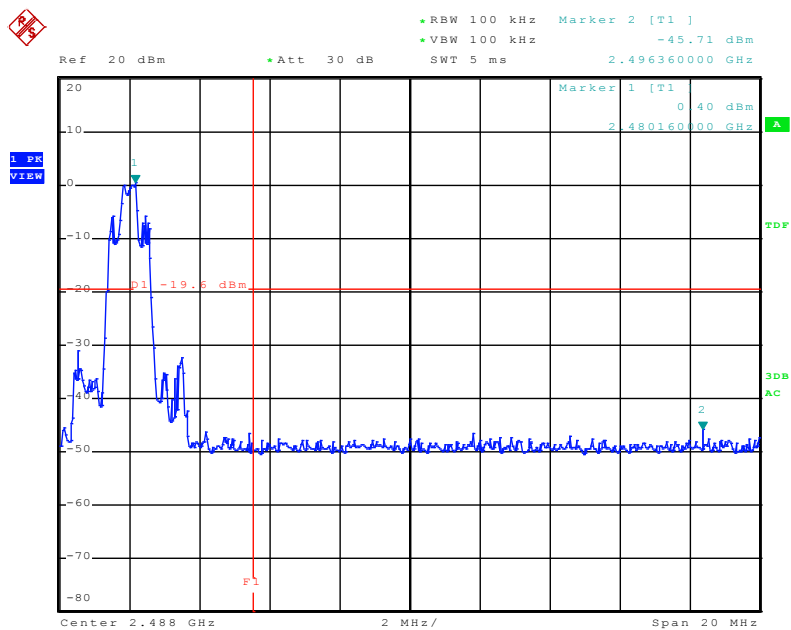

Date: 8.SEP.2016 12:03:16

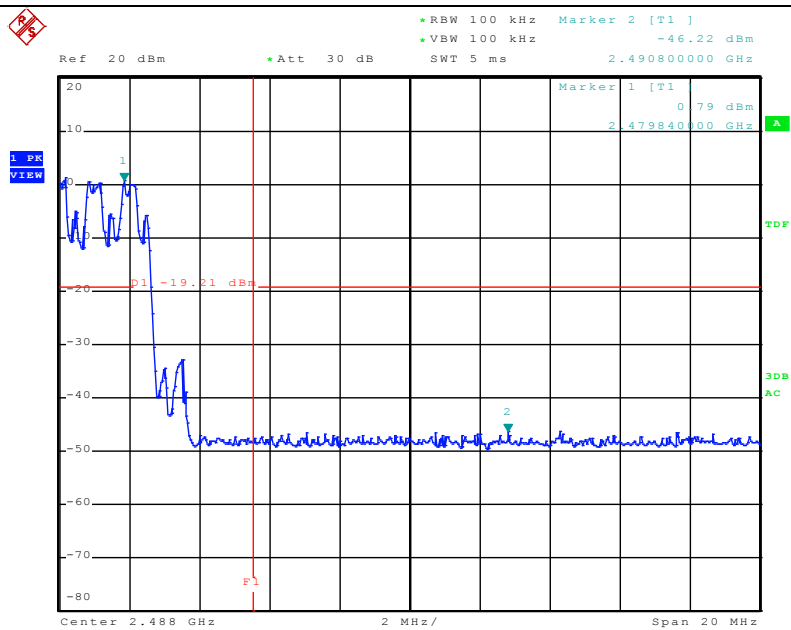

Date: 8.SEP.2016 12:02:27

### 3Mbps Channel: Low

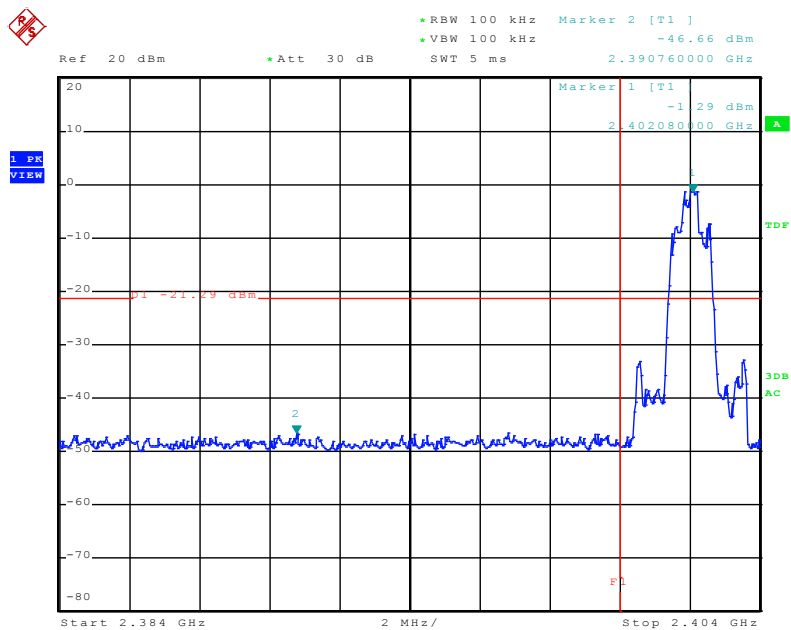

Date: 8.SEP.2016 11:52:47

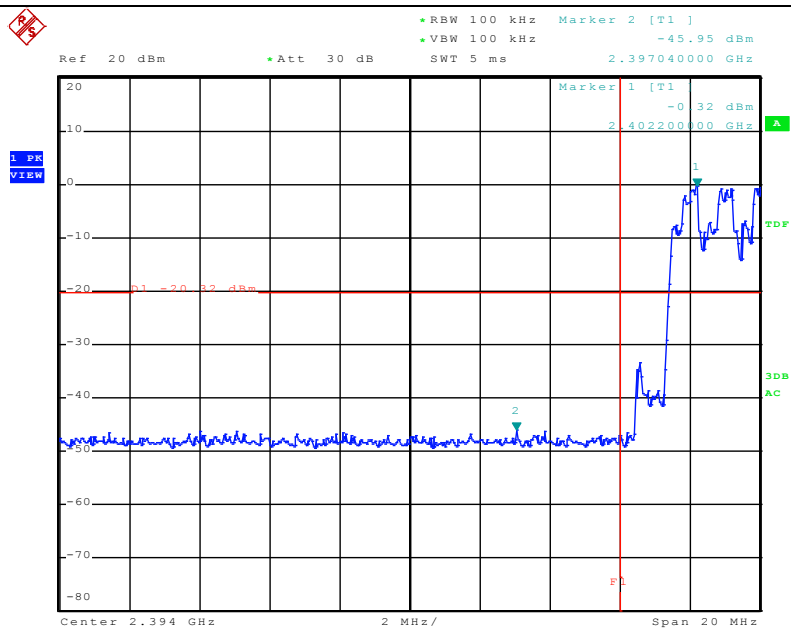

Date: 8.SEP.2016 11:53:50

### Channel: High

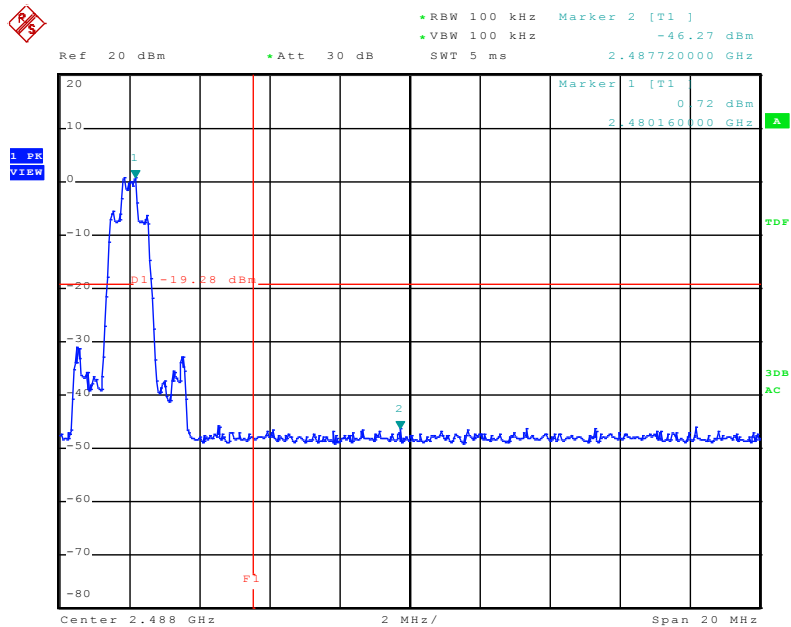

Date: 8.SEP.2016 11:55:32

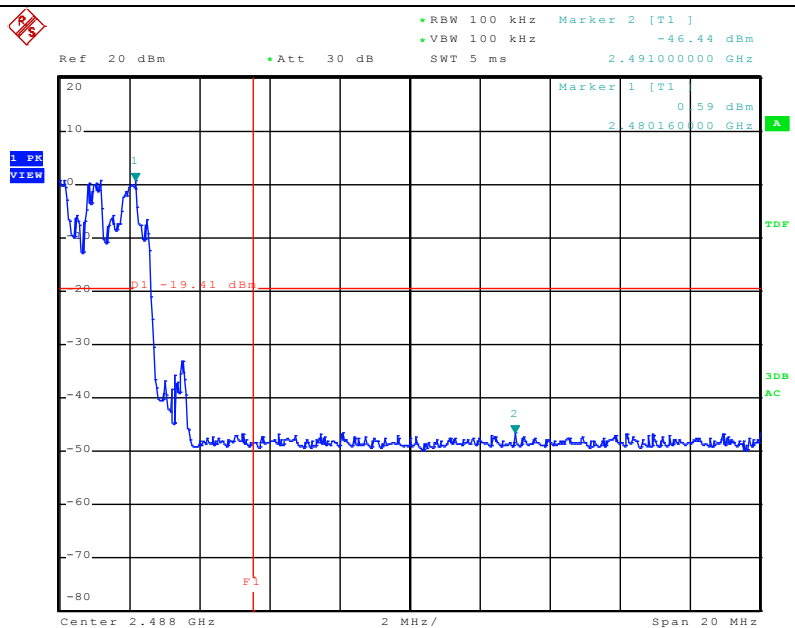

Date: 8.SEP.2016 11:56:48

### 1Mbps Channel: Low

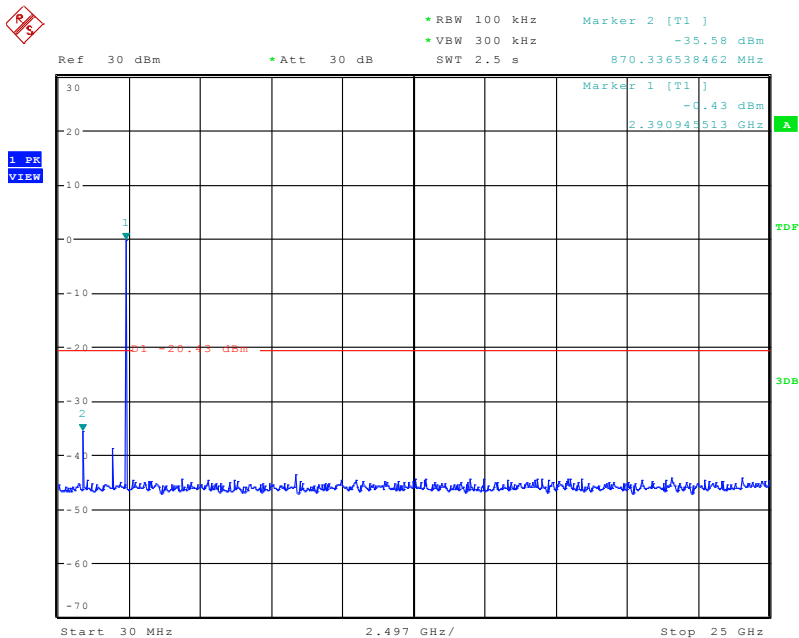

Date: 8.SEP.2016 17:53:51



### Channel: Middle

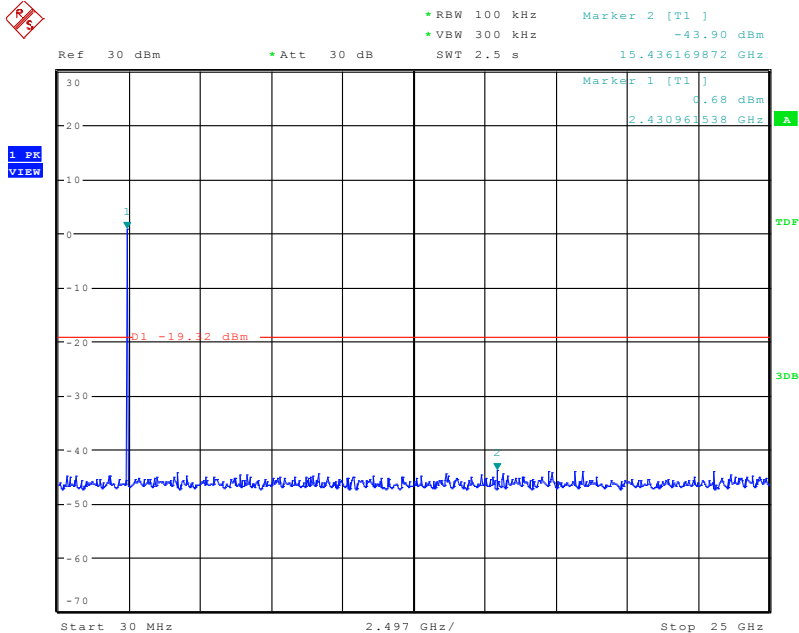

Date: 8.SEP.2016 17:56:51



### Channel: High

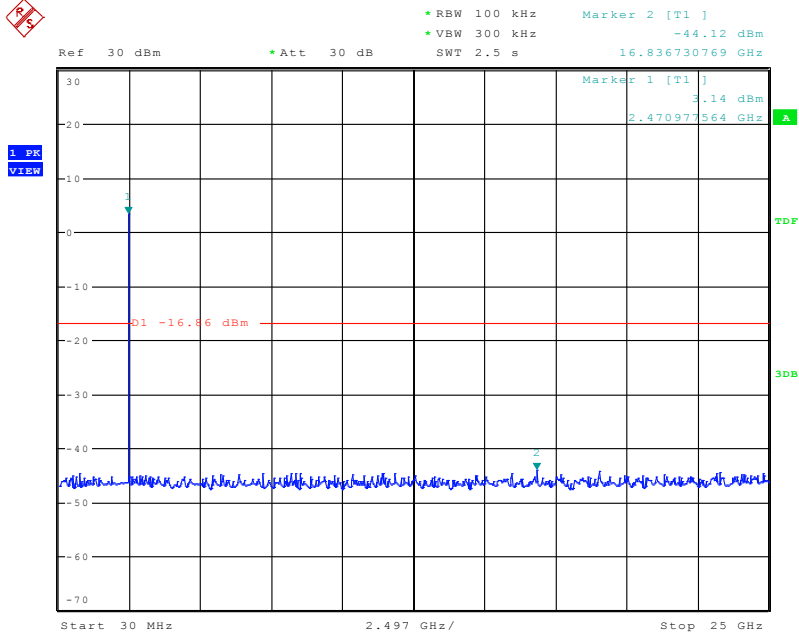

Date: 8.SEP.2016 17:58:02



2Mbps

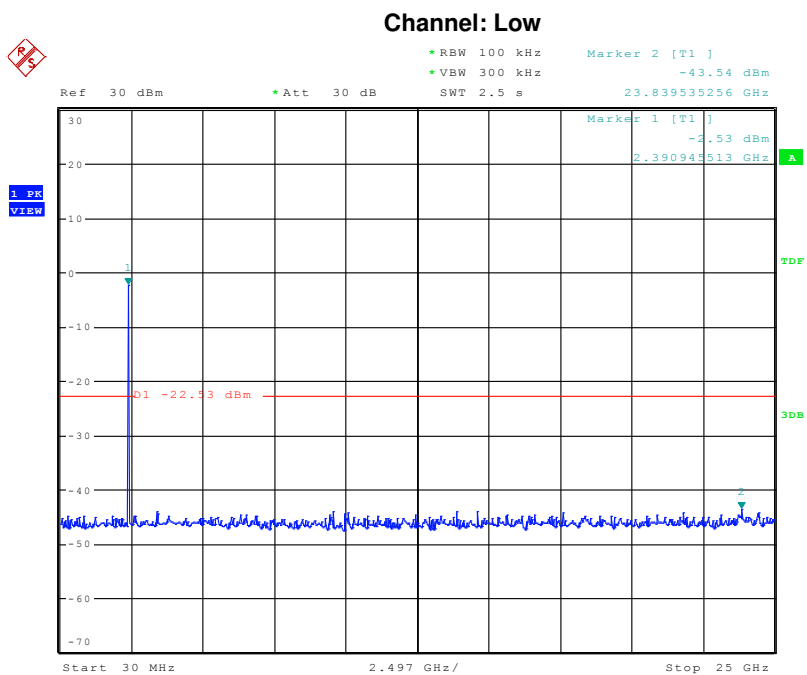

Date: 8.SEP.2016 18:00:13

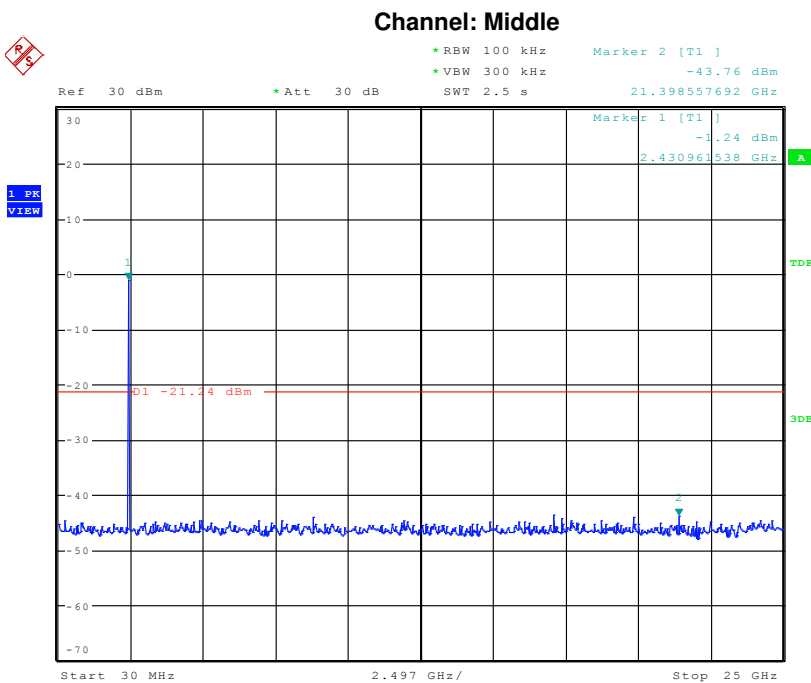

Date: 8.SEP.2016 18:01:18

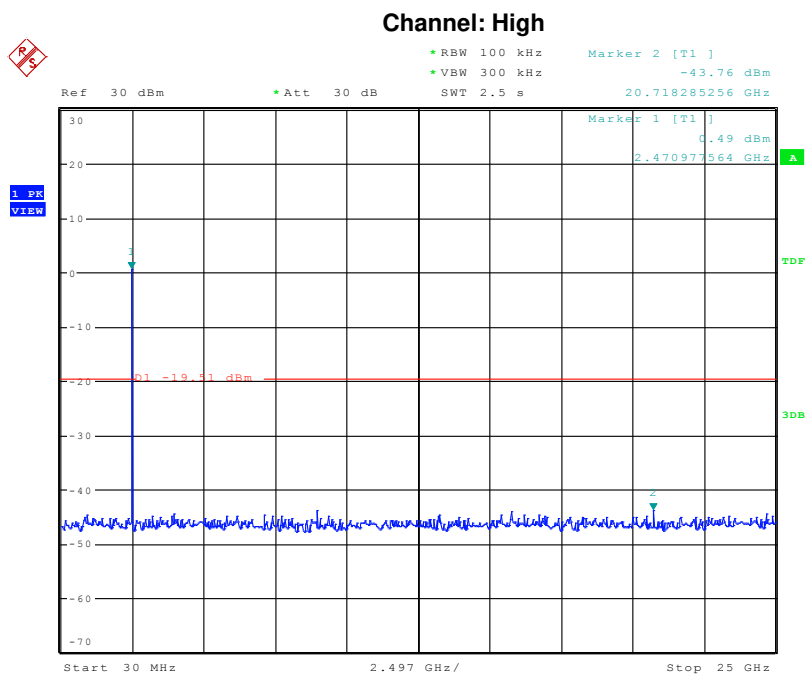

Date: 8.SEP.2016 18:02:40

### 3Mbps

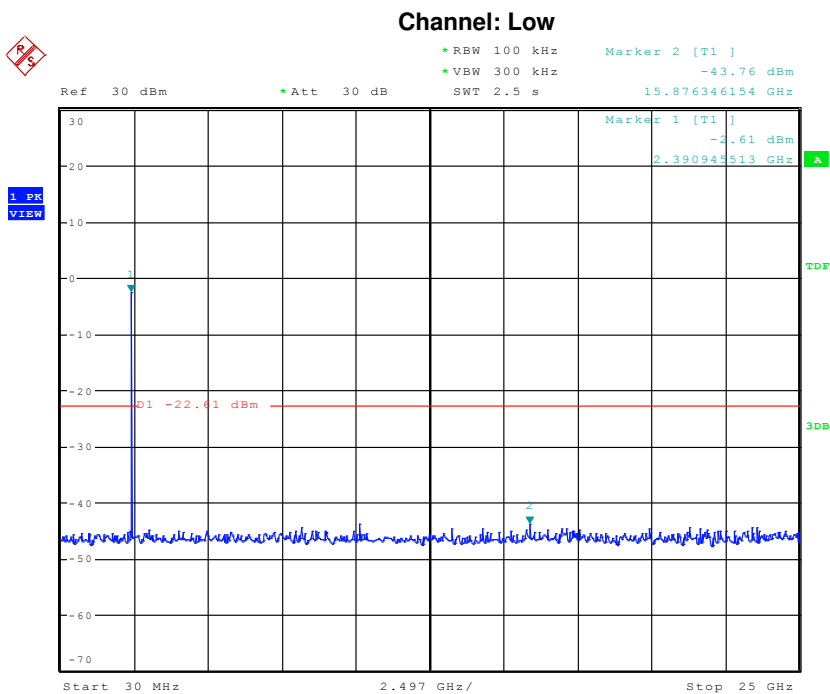

Date: 8.SEP.2016 18:03:47

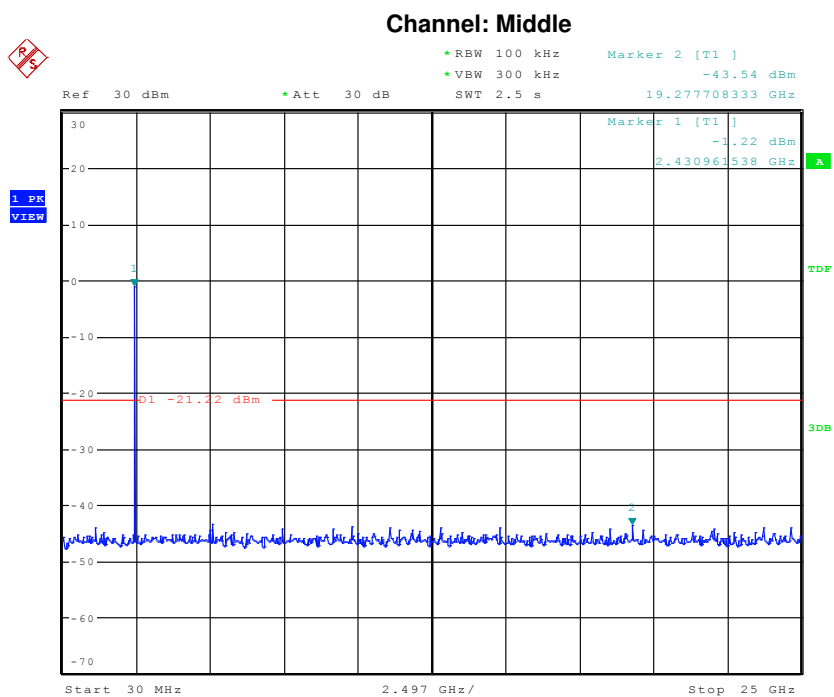

Date: 8.SEP.2016 18:05:04

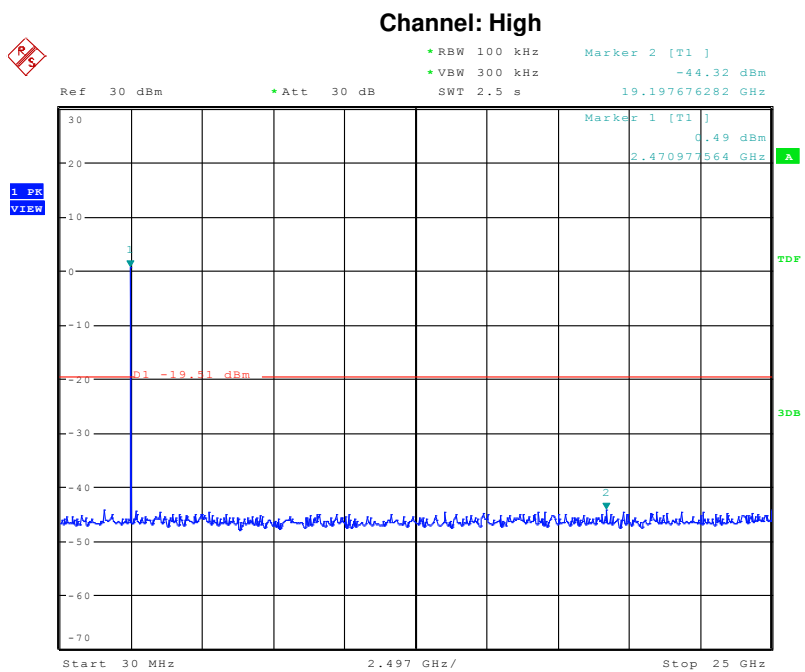

Date: 8.SEP.2016 18:05:59

## **12. ANTENNA APPLICATION**

### **12.1 Antenna requirement**

The EUT'S antenna is met the requirement of FCC part 15C section 15.203 and 15.247

FCC part 15C section 15.247 requirements: Systems operating in the 2402-2480MHz band that are used exclusively for fixed.

### **12.2 Result**

The EUT's antenna integrated on PCB, The antenna's gain is -1.8dBi and meets the requirement.

### 13. EUT TEST PHOTO

CONDUCTED EMISSION TEST

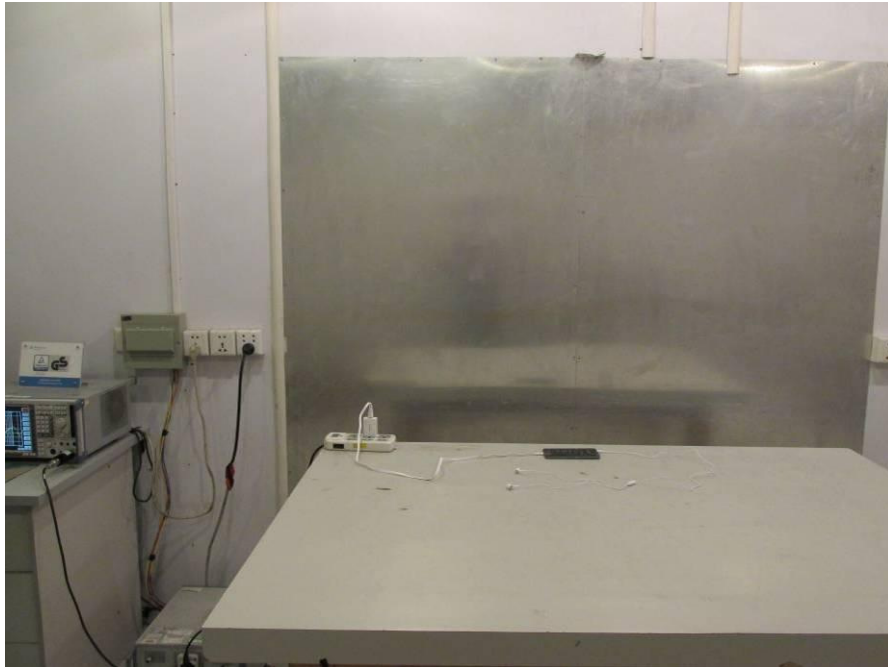

RADIATED EMISSION TEST  
(Frequency from 30MHz to 1GHz)

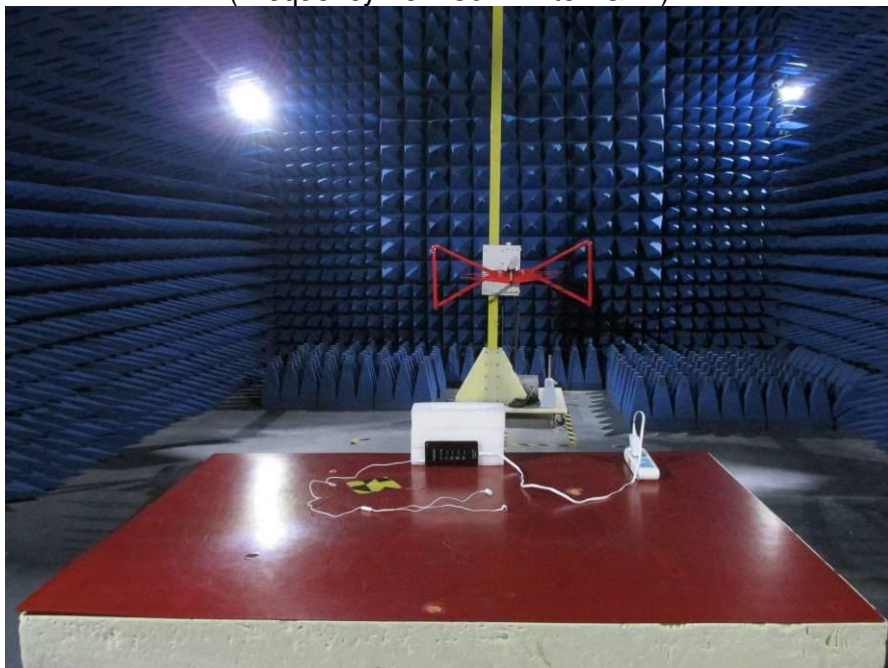

RADIATED EMISSION TEST  
(Frequency above 1GHz)

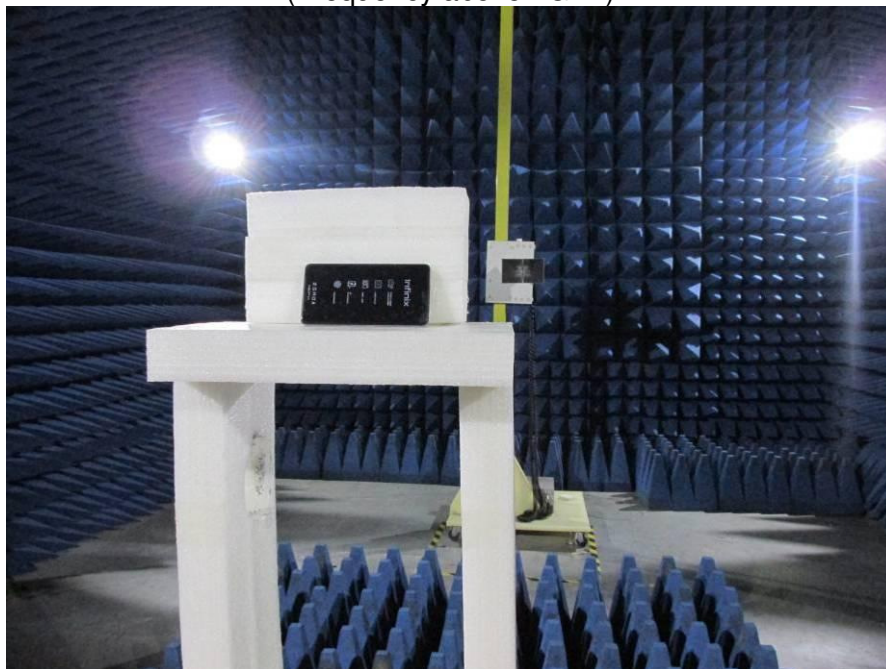

### 14. PHOTOGRAPHS OF EUT

Appearance photograph of EUT



Appearance photograph of EUT



Appearance photograph of EUT



Appearance photograph of EUT





Appearance photograph of EUT



Appearance photograph of EUT



Appearance photograph of EUT



Appearance photograph of EUT



Internal photograph of EUT



Internal photograph of EUT



Internal photograph of EUT



Internal photograph of EUT



Internal photograph of EUT

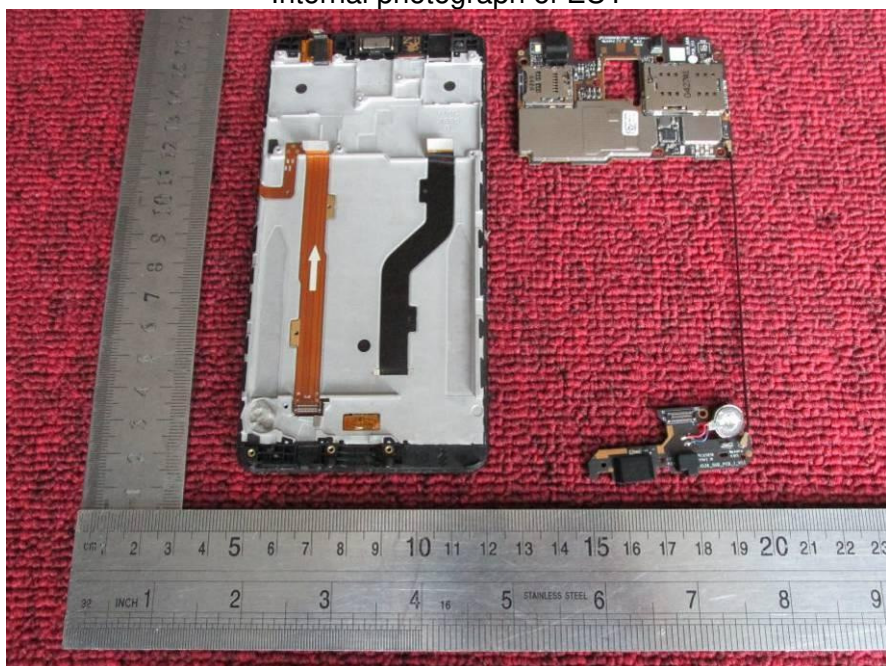

Internal photograph of EUT

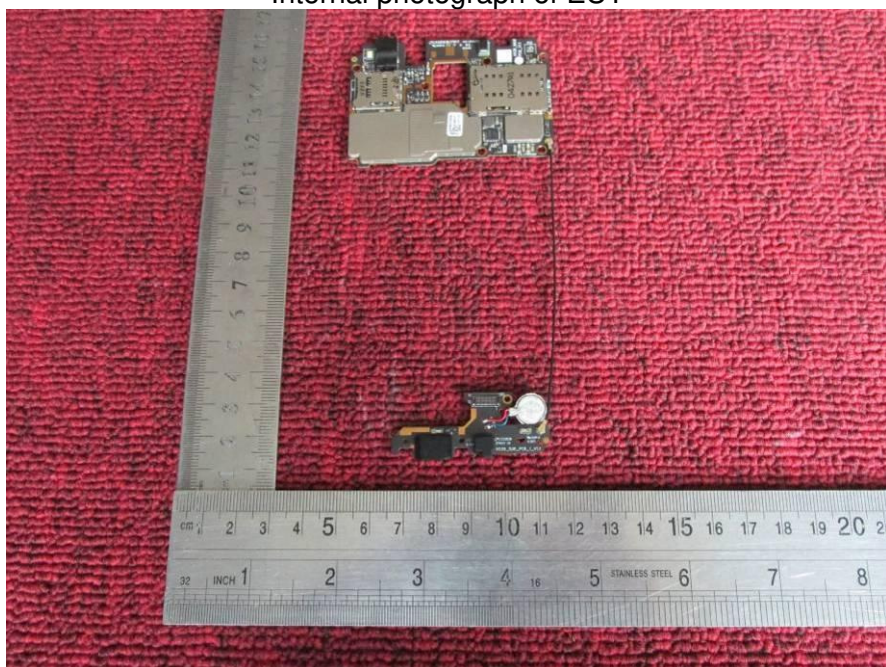

Internal photograph of EUT

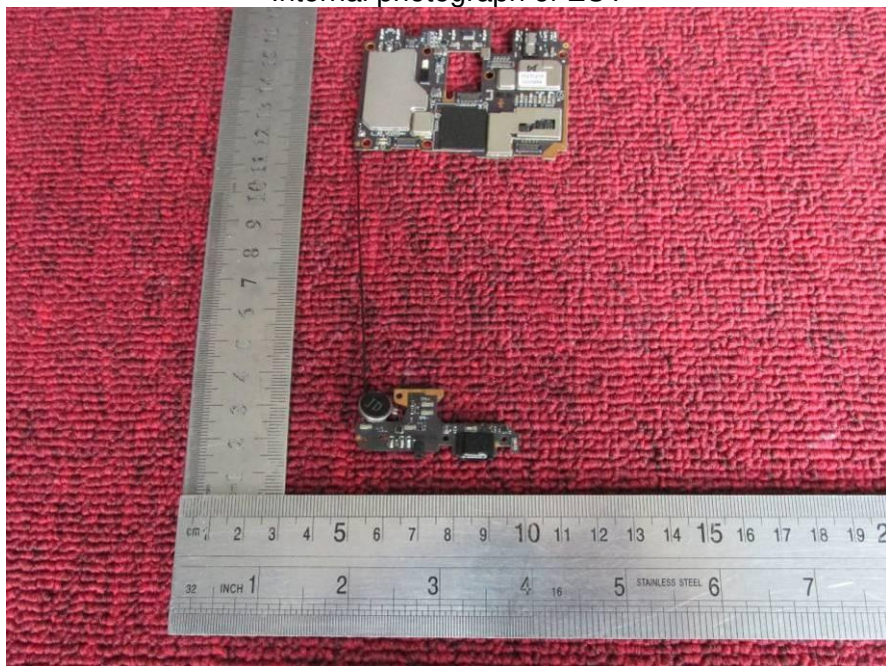

Internal photograph of EUT

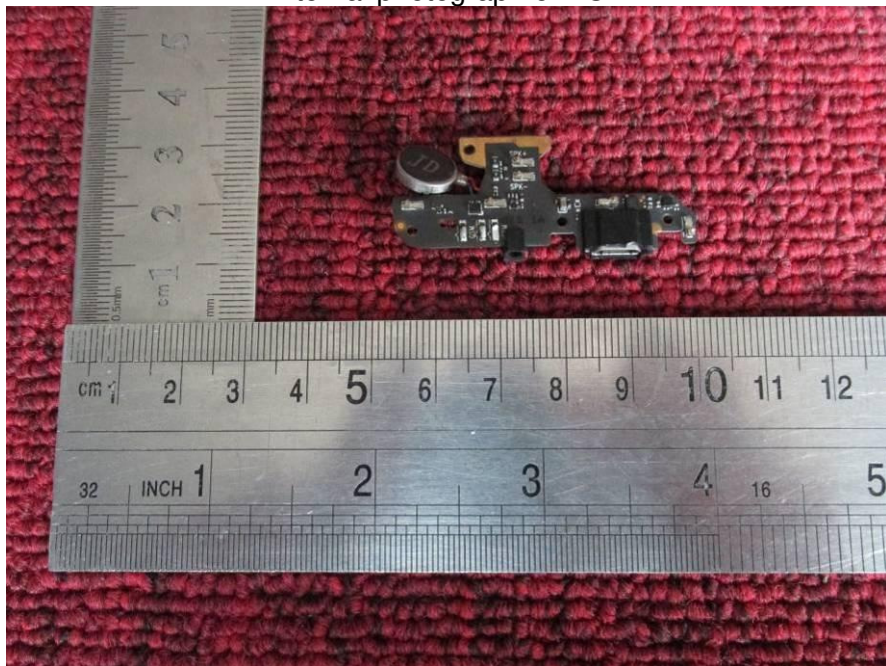

Internal photograph of EUT

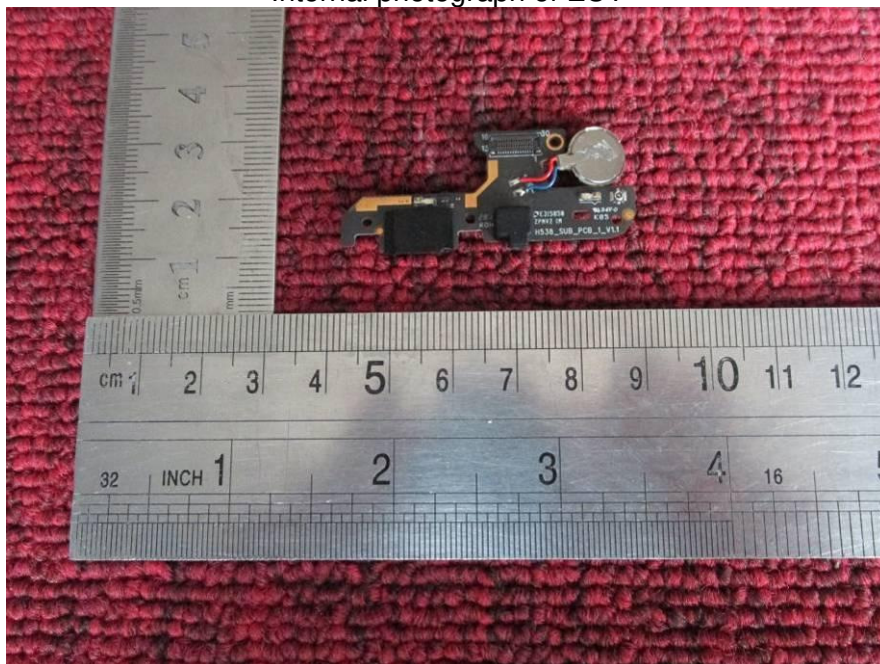

Internal photograph of EUT

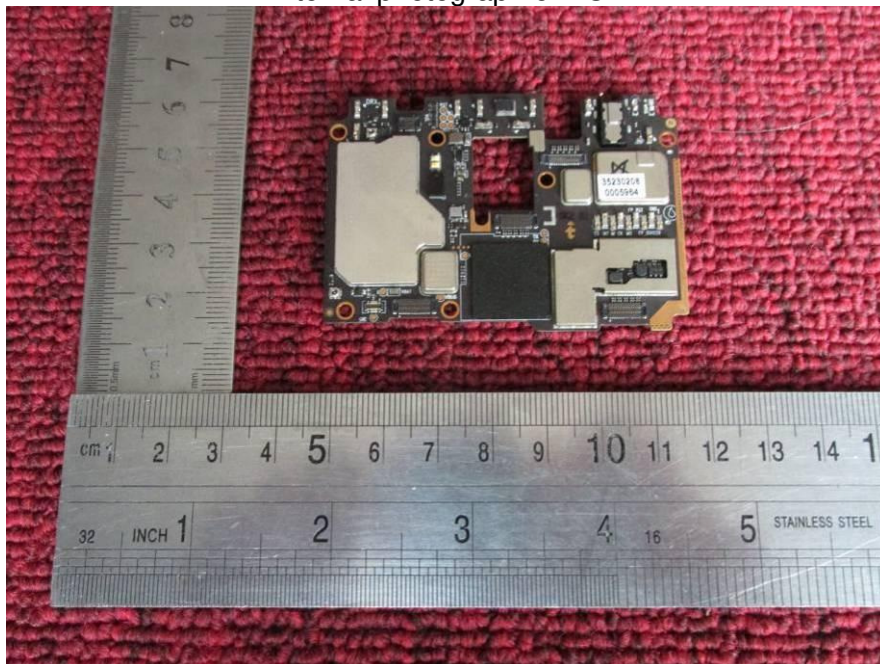

Internal photograph of EUT

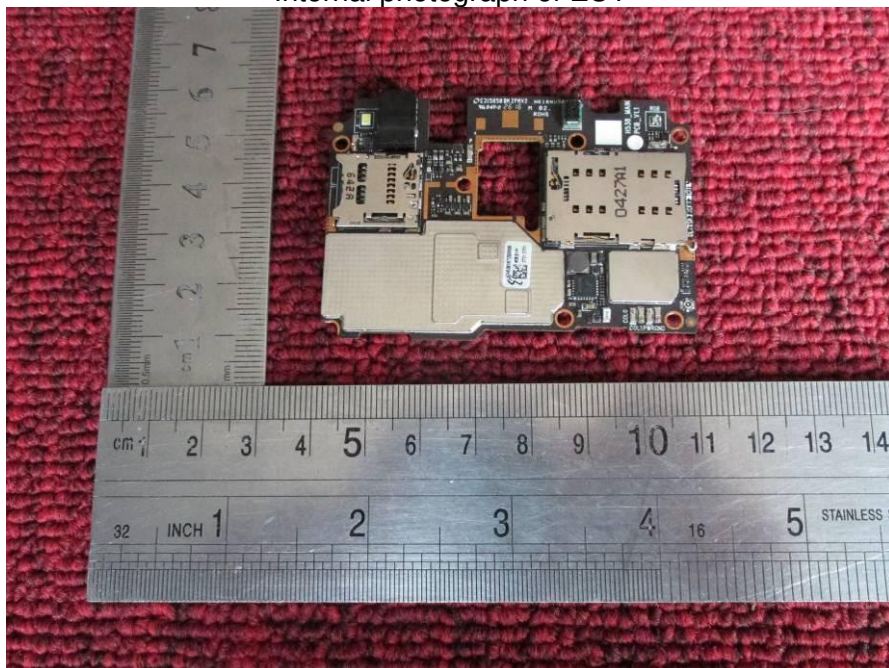

Internal photograph of EUT

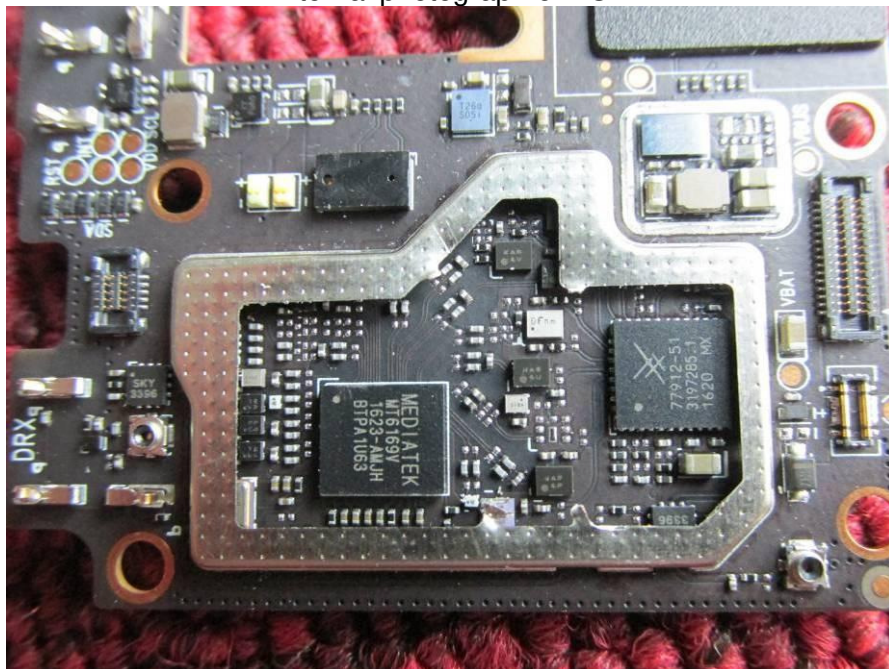



Internal photograph of EUT

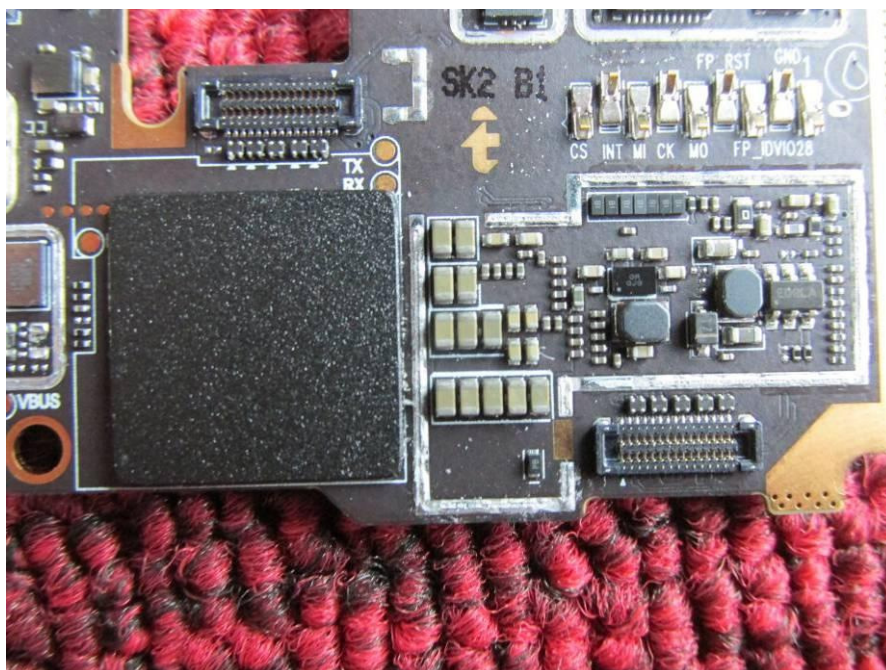

Internal photograph of EUT

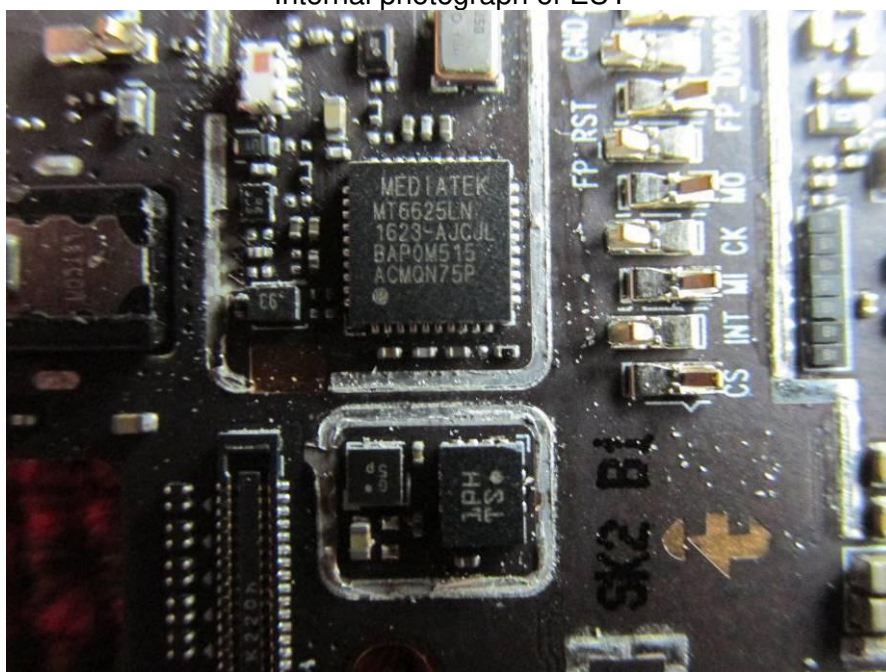

Internal photograph of EUT



Internal photograph of EUT

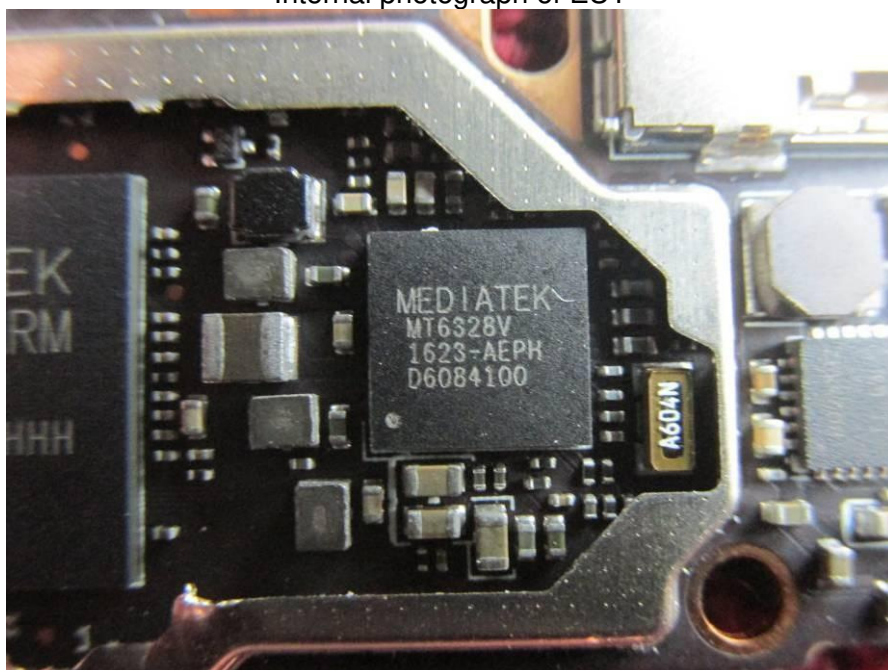

Internal photograph of EUT



Internal photograph of EUT

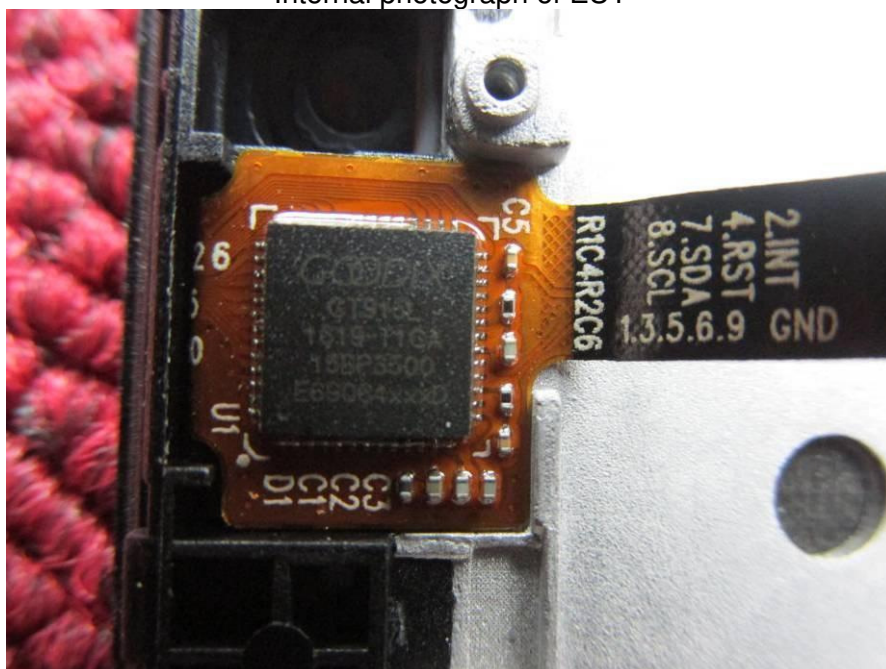

---END OF REPORT---