



FCC Report

Application Purpose : Original grant
Applicant Name: : INFINIX MOBILITY LIMITED
FCC ID : 2AIZN-X522
Equipment Type : Mobile phone
Model Name : X522
Report Number : FCC17010001A-4
Standard(S) : FCC Part 15 Subpart B
Date Of Receipt : January 04, 2017
Date Of Issue : February 15, 2017

Test By : 

(Daisy Qin)

Reviewed By : 

(Sol Qin)

Authorized by : 

(Michal Ling)

Prepared by : **QTC Certification & Testing Co., Ltd.**
2nd Floor,Bl Building,Fengyeyuan Industrial Plant,,
Liuxian 2st. Road, Xin'an Street, Bao'an
District,,Shenzhen,518000
Registration Number: 588523

REPORT REVISE RECORD

Report Version	Revise Time	Issued Date	Valid Version	Notes
V1.0	/	February 15, 2017	Valid	Original Report

Table of Contents	Page
1. GENERAL INFORMATION	4
2. TEST DESCRIPTION	6
2.1 MEASUREMENT UNCERTAINTY	6
2.2 DESCRIPTION OF TEST MODES	7
2.3 CONFIGURATION OF SYSTEM UNDER TEST	8
2.4 DESCRIPTION OF SUPPORT UNITS (CONDUCTED MODE)	9
3. SUMMARY OF TEST RESULTS	10
4. MEASUREMENT INSTRUMENTS	11
5. EMC EMISSION TEST	12
5.1 CONDUCTED EMISSION MEASUREMENT	12
5.1.1 POWER LINE CONDUCTED EMISSION LIMITS	12
5.1.2 TEST PROCEDURE	13
5.1.3 DEVIATION FROM TEST STANDARD	13
5.1.4 TEST SETUP	13
5.1.5 EUT OPERATING CONDITIONS	13
5.1.6 TEST RESULTS	14
5.2 RADIATED EMISSION MEASUREMENT	24
5.2.1 RADIATED EMISSION LIMITS	24
5.2.2 TEST PROCEDURE	25
5.2.3 DEVIATION FROM TEST STANDARD	25
5.2.4 TEST SETUP	26
5.2.5 EUT OPERATING CONDITIONS	26
5.2.5.1 TEST RESULTS (BETWEEN 30M – 1000 MHZ)	27
5.2.5.2 TEST RESULTS (1GHZ TO 6GHZ)	37
6. EUT TEST PHOTO	40
7. PHOTOGRAPHS OF EUT	44

1. GENERAL INFORMATION

Test Model	X522
Applicant	INFINIX MOBILITY LIMITED
Address	RMS 05-15, 13A/F SOUTH TOWER WORLD FINANCE CTR HARBOUR CITY 17 CANTON RD TST KLN HONG KONG
Manufacturer	SHENZHEN TECNO TECHNOLOGY CO.,LTD.
Address	1-4th Floor,3rd Building,Pacific Industrial Park,No.2088,Shenyan Road,Yantian District,Shenzhen,Guangdong,China
Equipment Type	Mobile phone
Brand Name	Infinix
Hardware	H539_B1_V1.2
Software	X522-H539D1-M-161206V23
Battery information:	Li-Polymer Battery : BL-30SX Voltage: 3.85V Capacity: 3000mAh Limited Charge Voltage: 4.4V
Adapter Information:	Adapter: A88-502000 Input: 100~240V 50/60Hz 350mA Output: 5V~2A
Data of receipt	January 04, 2017
Date of test	January 05, 2017 to February 14 , 2017
Deviation	None
Condition of Test Sample	Normal

We hereby certify that:

The above equipment was tested by QTC Certification & Testing Co., Ltd.

2nd Floor, BI Building, Fengyeyuan Industrial Plant, Liuxian 2st. Road, Xin'an Street, Bao'an District, Shenzhen, 518000

Registration Number: 588523

The data evaluation, test procedures, and equipment configurations shown in this report were made in accordance with the procedures given in ANSI C 63.4:2014. The sample tested as described in this report is in compliance with the FCC Rules Part 15 Subpart B.

The test results of this report relate only to the tested sample identified in this report.

2. TEST DESCRIPTION

2.1 MEASUREMENT UNCERTAINTY

The reported uncertainty of measurement $y \pm U$, where expanded uncertainty U is based on a standard uncertainty multiplied by a coverage factor of $k=2$, providing a level of confidence of approximately 95%.

No.	Item	Uncertainty
1	Conducted Emission Test	$\pm 3.2\text{dB}$
2	RF power, conducted	$\pm 0.16\text{dB}$
3	Spurious emissions, conducted	$\pm 0.21\text{dB}$
4	All emissions, radiated(<1G)	$\pm 4.7\text{dB}$
5	All emissions, radiated(>1G)	$\pm 4.7\text{dB}$
6	Temperature	$\pm 0.5^\circ\text{C}$
7	Humidity	$\pm 2\%$

2.2 DESCRIPTION OF TEST MODES

To investigate the maximum EMI emission characteristics generates from EUT, the test system was pre-scanning tested base on the consideration of following EUT operation mode or test configuration mode which possible have effect on EMI emission level. Each of these EUT operation mode(s) or test configuration mode(s) mentioned above was evaluated respectively.

Pretest Mode	Description
Mode 1	Video Recording
Model 2	Video Playing
Mode 3	Exchange data with computer
Mode 4	GPS
Mode 5	FM

For Conducted Emission	
Final Test Mode	Test with Keyboard and Mouse
Mode 1	Video Recording
Model 2	Video Playing
Mode 3	Exchange data with computer
Mode 4	GPS
Mode 5	FM

For Radiated Emission	
Final Test Mode	Test with Keyboard and Mouse
Mode 1	Video Recording
Model 2	Video Playing
Mode 3	Exchange data with computer
Mode 4	GPS
Mode 5	FM

2.3 CONFIGURATION OF SYSTEM UNDER TEST

Mode 1&2&4&5:

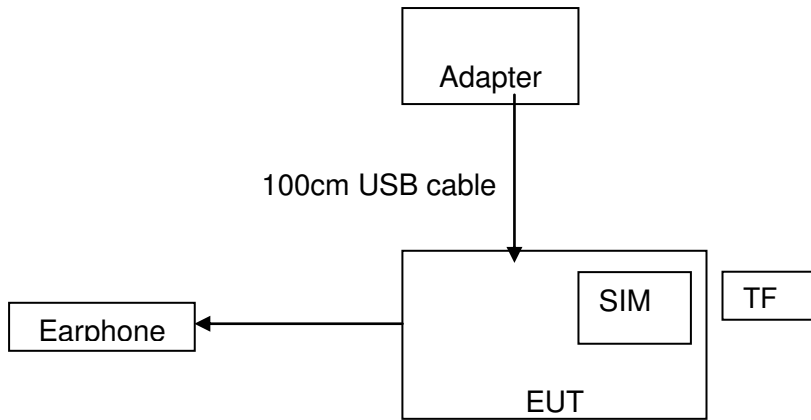

(EUT: Mobile phone)

Mode 3:

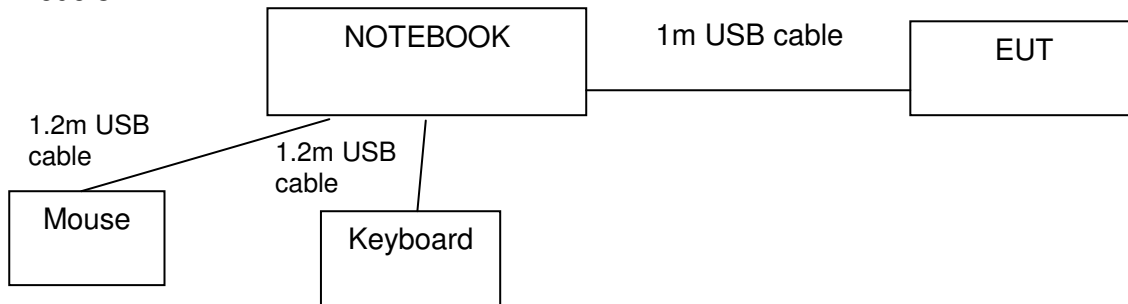

(EUT: Mobile phone)

I/O Port of EUT			
I/O Port Type	Q'TY	Cable	Tested with
Power	1	1m USB cable, unshielded	1
Earphone	1	1m USB cable, unshielded	1

2.4 DESCRIPTION OF SUPPORT UNITS (CONDUCTED MODE)

The EUT has been tested as an independent unit together with other necessary accessories or support units. The following support units or accessories were used to form a representative test configuration during the tests.

Item	Equipment	Mfr/Brand	Model/Type No.	Series No.	Note
1	Adapter	/	A88-502000	/	/
2	Keyboard	HP	SK-2880	435302-AA-	/
3	Mouse	DELL	MS111-1	/	/

Note:

- (1) The support equipment was authorized by Declaration of Confirmation.
- (2) For detachable type I/O cable should be specified the length in cm in 『Length』 column.

3. SUMMARY OF TEST RESULTS

Test procedures according to the technical standards:

FCC Part15 , Subpart B			
Standard Section	Test Item	Judgment	Remark
15.107	CONDUCTED EMISSION	PASS	
15.109	RADIATED EMISSION	PASS	

NOTE:

(1) "N/A" denotes test is not applicable in this test report.

4. MEASUREMENT INSTRUMENTS

Kind of Equipment	Manufacturer	Type No.	Serial No.	Last Calibrated	Calibrated until
ESCI Test Receiver	R&S	ESCI	100005	08/19/2016	08/18/2017
LISN	AFJ	LS16	16010222119	08/19/2016	08/18/2017
LISN(EUT)	Mestec	AN3016	04/10040	08/19/2016	08/18/2017
pre-amplifier	CDSI	PAP-1G18-38	--	08/19/2016	08/18/2017
System Controller	CT	SC100	-	08/19/2016	08/18/2017
Bi-log Antenna	Chase	CBL6111C	2576	08/19/2016	08/18/2017
Spectrum analyzer	R&S	FSU26	200409	08/19/2016	08/18/2017
Horn Antenna	SCHWARZBECK	9120D	1141	08/19/2016	08/18/2017
Bi-log Antenna	SCHWABEBECK	VULB9163	9163/340	08/19/2016	08/18/2017
Pre Amplifier	H.P.	HP8447E	2945A02715	10/13/2016	10/12/2017
9*6*6 Anechoic	--	--	--	08/21/2016	08/20/2017

5. EMC EMISSION TEST

5.1 CONDUCTED EMISSION MEASUREMENT

5.1.1 POWER LINE CONDUCTED EMISSION Limits (Frequency Range 150KHz-30MHz)

FREQUENCY (MHz)	Class A (dBuV)		Class B (dBuV)		Standard
	Quasi-peak	Average	Quasi-peak	Average	
0.15 -0.5	79.00	66.00	66 - 56 *	56 - 46 *	FCC
0.50 -5.0	73.00	60.00	56.00	46.00	FCC
5.0 -30.0	73.00	60.00	60.00	50.00	FCC

Note:

- (1) The tighter limit applies at the band edges.
- (2) The limit of " * " marked band means the limitation decreases linearly with the logarithm of the frequency in the range.

The following table is the setting of the receiver

Receiver Parameters	Setting
Attenuation	10 dB
Start Frequency	0.15 MHz
Stop Frequency	30 MHz
IF Bandwidth	9 kHz

5.1.2 TEST PROCEDURE

- The EUT was placed 0.4 meters from the horizontal ground plane with EUT being connected to the power mains through a line impedance stabilization network (LISN). All other support equipments powered from additional LISN(s). The LISN provide 50 Ohm/ 50uH of coupling impedance for the measuring instrument.
- Interconnecting cables that hang closer than 40 cm to the ground plane shall be folded back and forth in the center forming a bundle 30 to 40 cm long.
- I/O cables that are not connected to a peripheral shall be bundled in the center. The end of the cable may be terminated, if required, using the correct terminating impedance. The overall length shall not exceed 1 m.
- LISN at least 80 cm from nearest part of EUT chassis.
- For the actual test configuration, please refer to the related Item –EUT Test Photos.

5.1.3 DEVIATION FROM TEST STANDARD

No deviation

5.1.4 TEST SETUP

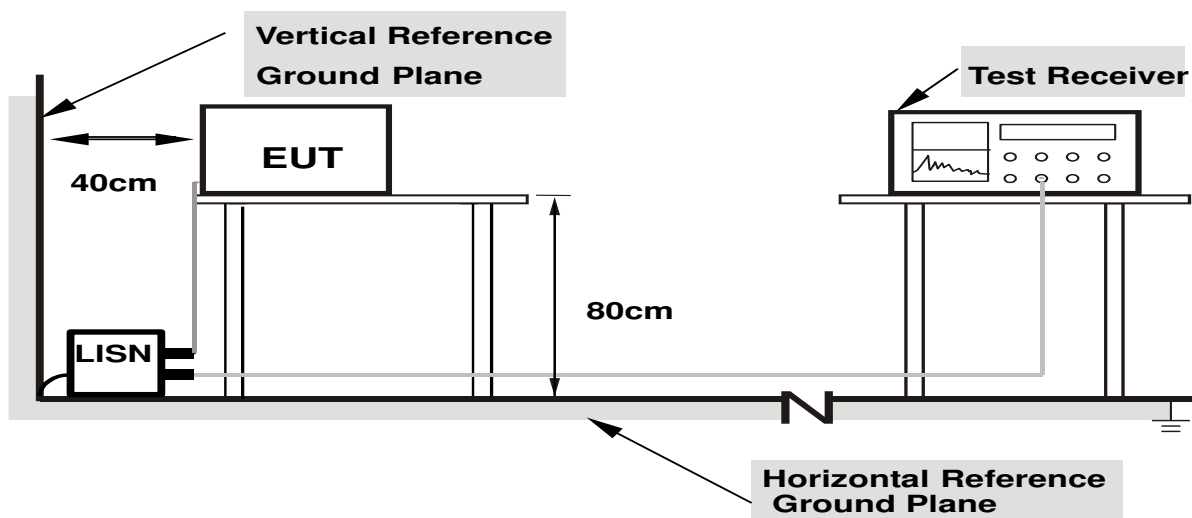

- Note: 1.Support units were connected to second LISN.
2.Both of LISNs (AMN) are 80 cm from EUT and at least 80 from other units and other metal planes**

5.1.5 EUT OPERATING CONDITIONS

The EUT was configured for testing in a typical fashion (as a customer would normally use it). The EUT has been programmed to continuously transmit during test. This operating condition was tested and used to collect the included data.

5.1.6 TEST RESULTS

EUT	Mobile phone	Model Name	X522
Temperature	26 °C	Relative Humidity	54%
Pressure	1010hPa	Phase	L
Test Date	January 06, 2017	Test Mode	Mode 1

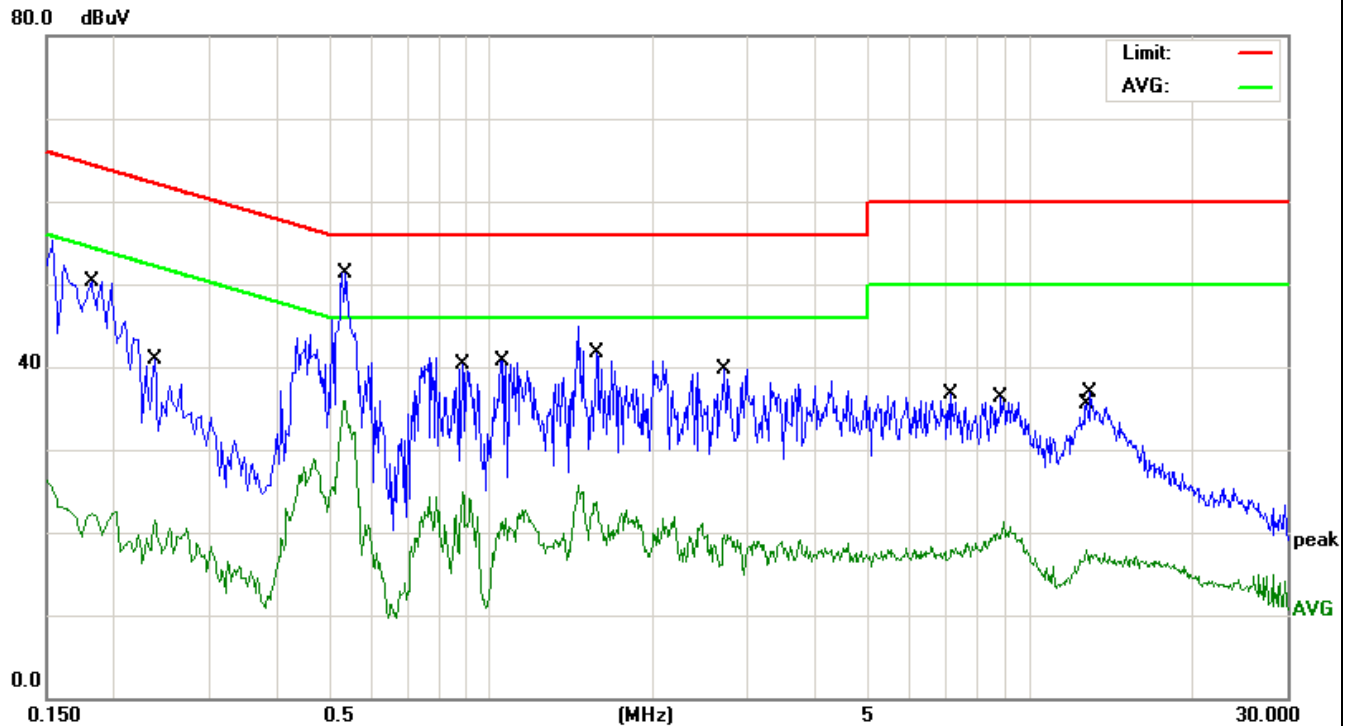

No.	Mk.	Freq. MHz	Reading Level dBuV	Correct Factor dB	Measure- ment dBuV	Limit dBuV	Over dB	Detector
1		0.1819	38.89	11.50	50.39	64.39	-14.00	QP
2		0.2380	10.41	11.16	21.57	52.16	-30.59	AVG
3		0.5340	25.12	10.70	35.82	46.00	-10.18	AVG
4	*	0.5380	40.65	10.70	51.35	56.00	-4.65	QP
5		0.8860	14.20	10.69	24.89	46.00	-21.11	AVG
6		1.0500	30.09	10.68	40.77	56.00	-15.23	QP
7		1.5700	13.13	10.63	23.76	46.00	-22.24	AVG
8		2.7100	29.19	10.60	39.79	56.00	-16.21	QP
9		7.1460	26.11	10.57	36.68	60.00	-23.32	QP
10		8.9540	10.62	10.60	21.22	50.00	-28.78	AVG
11		12.7420	7.34	10.63	17.97	50.00	-32.03	AVG
12		12.9660	26.22	10.63	36.85	60.00	-23.15	QP

EUT	Mobile phone	Model Name	X522
Temperature	26 °C	Relative Humidity	54%
Pressure	1010hPa	Phase	N
Test Date	January 06, 2017	Test Mode	Mode 1

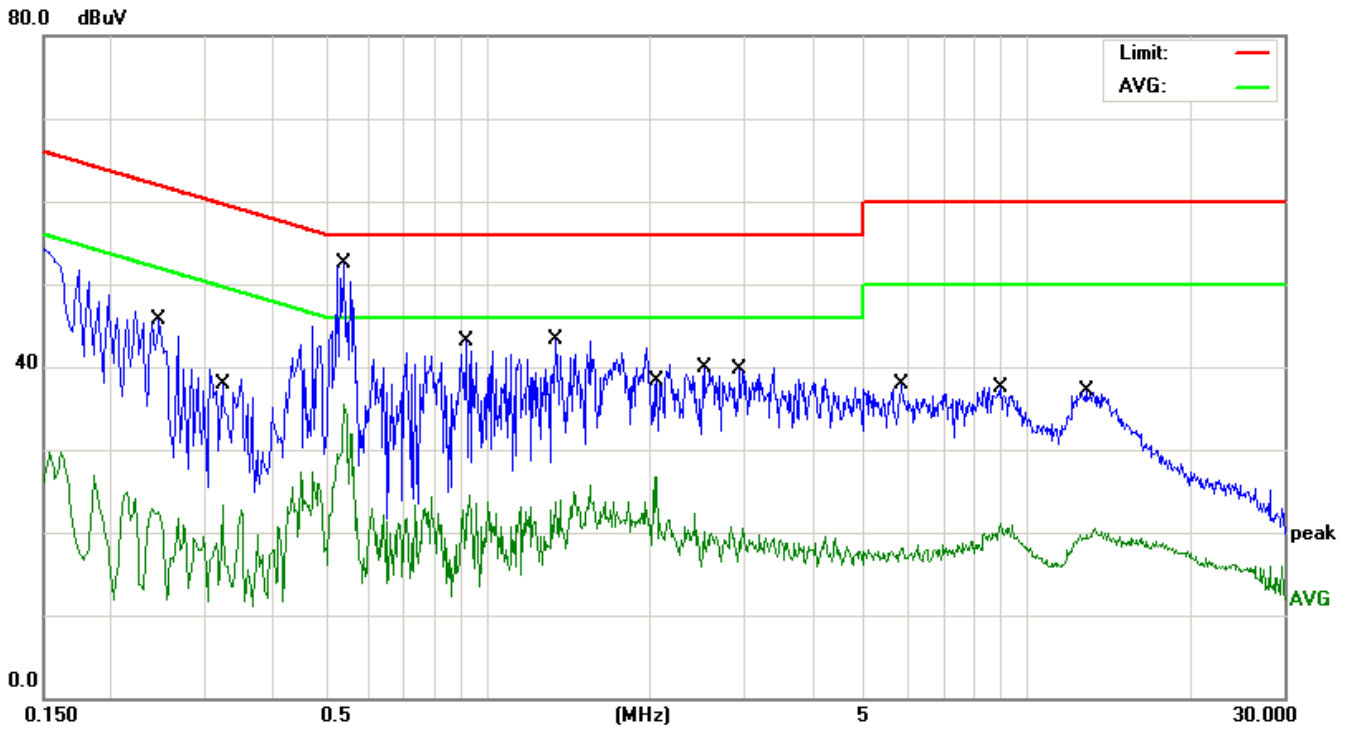

No.	Mk.	Freq. MHz	Reading Level dBuV	Correct Factor dB	Measure- ment dBuV	Limit dBuV	Over dB	Detector
1		0.2460	34.57	11.15	45.72	61.89	-16.17	QP
2		0.3220	12.33	11.02	23.35	49.65	-26.30	AVG
3	*	0.5420	36.86	10.69	47.55	56.00	-8.45	QP
4		0.5420	24.81	10.69	35.50	46.00	-10.50	AVG
5		0.9260	13.77	10.69	24.46	46.00	-21.54	AVG
6		1.3340	32.54	10.66	43.20	56.00	-12.80	QP
7		2.0340	16.15	10.61	26.76	46.00	-19.24	AVG
8		2.5220	29.27	10.60	39.87	56.00	-16.13	QP
9		2.9700	9.91	10.57	20.48	46.00	-25.52	AVG
10		5.8500	27.34	10.54	37.88	60.00	-22.12	QP
11		8.9220	10.44	10.60	21.04	50.00	-28.96	AVG
12		12.8780	26.56	10.63	37.19	60.00	-22.81	QP

EUT	Mobile phone	Model Name	X522
Temperature	26 °C	Relative Humidity	54%
Pressure	1010hPa	Phase	L
Test Date	January 06, 2017	Test Mode	Mode 2

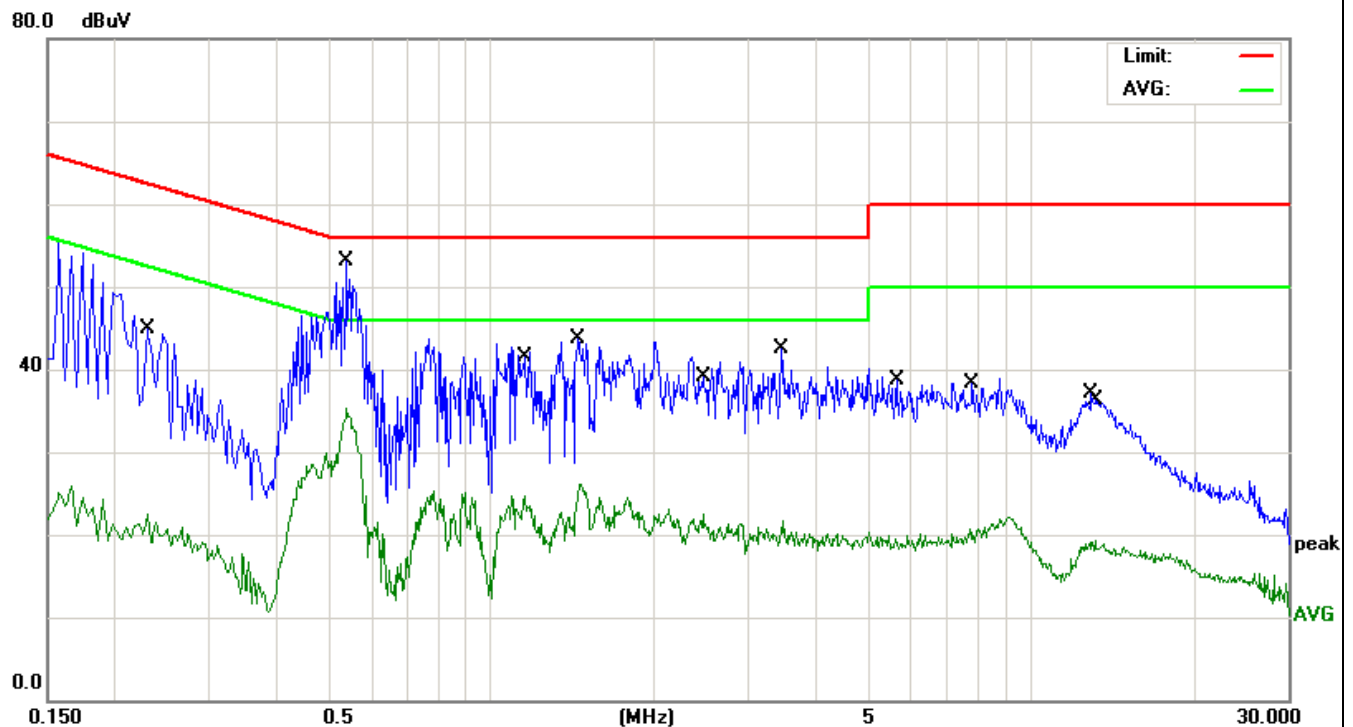

No.	Mk.	Freq.	Reading Level	Correct Factor	Measurement	Limit	Over	Detector
		MHz	dBuV	dB	dBuV	dBuV	dB	
1		0.2300	33.74	11.18	44.92	62.45	-17.53	QP
2		0.2300	11.27	11.18	22.45	52.45	-30.00	AVG
3	*	0.5380	35.17	10.70	45.87	56.00	-10.13	QP
4		0.5380	24.61	10.70	35.31	46.00	-10.69	AVG
5		1.1500	14.08	10.67	24.75	46.00	-21.25	AVG
6		1.4460	33.12	10.66	43.78	56.00	-12.22	QP
7		2.4700	11.95	10.60	22.55	46.00	-23.45	AVG
8		3.4500	31.86	10.56	42.42	56.00	-13.58	QP
9		5.6460	28.16	10.52	38.68	60.00	-21.32	QP
10		7.7020	10.05	10.59	20.64	50.00	-29.36	AVG
11		12.9700	26.50	10.63	37.13	60.00	-22.87	QP
12		13.1460	8.69	10.62	19.31	50.00	-30.69	AVG

EUT	Mobile phone	Model Name	X522
Temperature	26 °C	Relative Humidity	54%
Pressure	1010hPa	Phase	N
Test Date	January 06, 2017	Test Mode	Mode 2

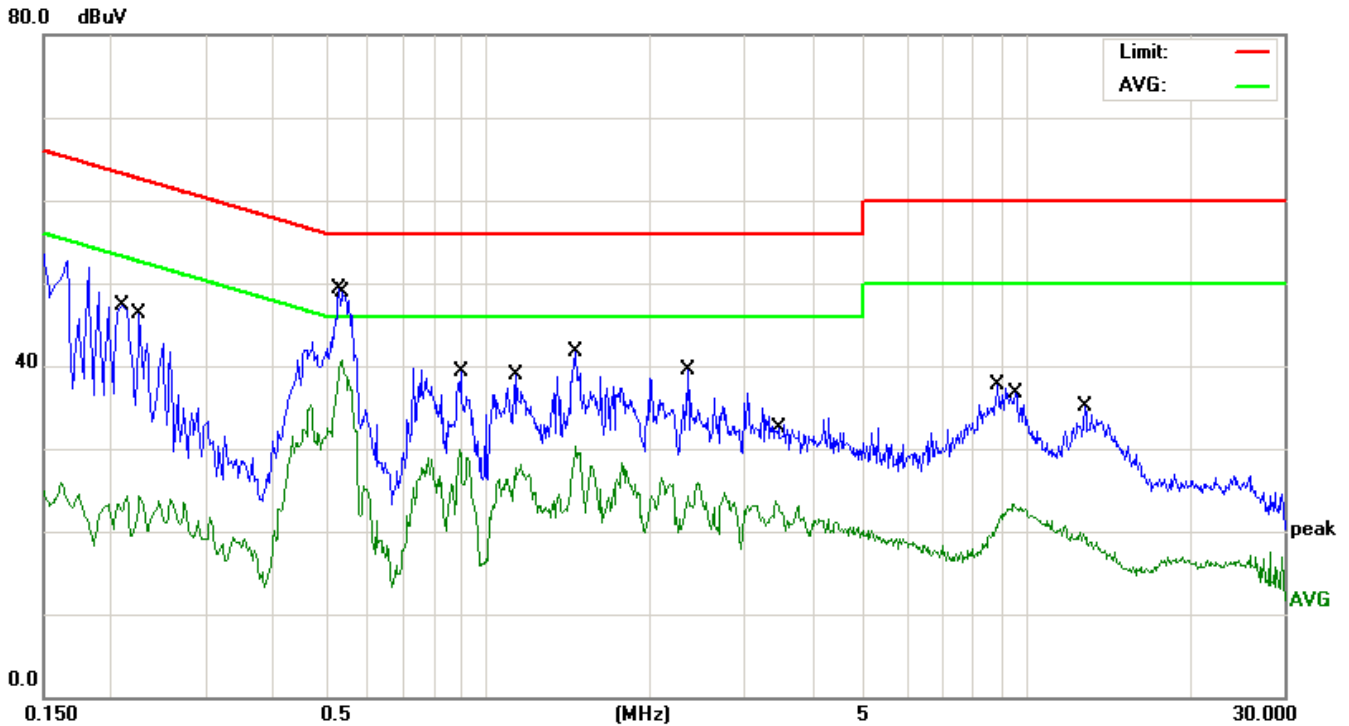

No.	Mk.	Freq. MHz	Reading Level dBuV	Correct Factor dB	Measure- ment dBuV	Limit dBuV	Over dB	Detector
1		0.2100	36.16	11.21	47.37	63.20	-15.83	QP
2		0.2260	13.13	11.18	24.31	52.59	-28.28	AVG
3		0.5299	38.70	10.70	49.40	56.00	-6.60	QP
4	*	0.5380	29.95	10.70	40.65	46.00	-5.35	AVG
5		0.8860	19.31	10.69	30.00	46.00	-16.00	AVG
6		1.1340	28.18	10.67	38.85	56.00	-17.15	QP
7		1.4580	19.62	10.66	30.28	46.00	-15.72	AVG
8		2.3500	28.82	10.60	39.42	56.00	-16.58	QP
9		3.4300	13.10	10.56	23.66	46.00	-22.34	AVG
10		8.8299	27.17	10.60	37.77	60.00	-22.23	QP
11		9.4539	12.76	10.59	23.35	50.00	-26.65	AVG
12		12.8499	24.46	10.63	35.09	60.00	-24.91	QP

EUT	Mobile phone	Model Name	X522
Temperature	26 °C	Relative Humidity	54%
Pressure	1010hPa	Phase	L
Test Date	January 06, 2017	Test Mode	Mode 3

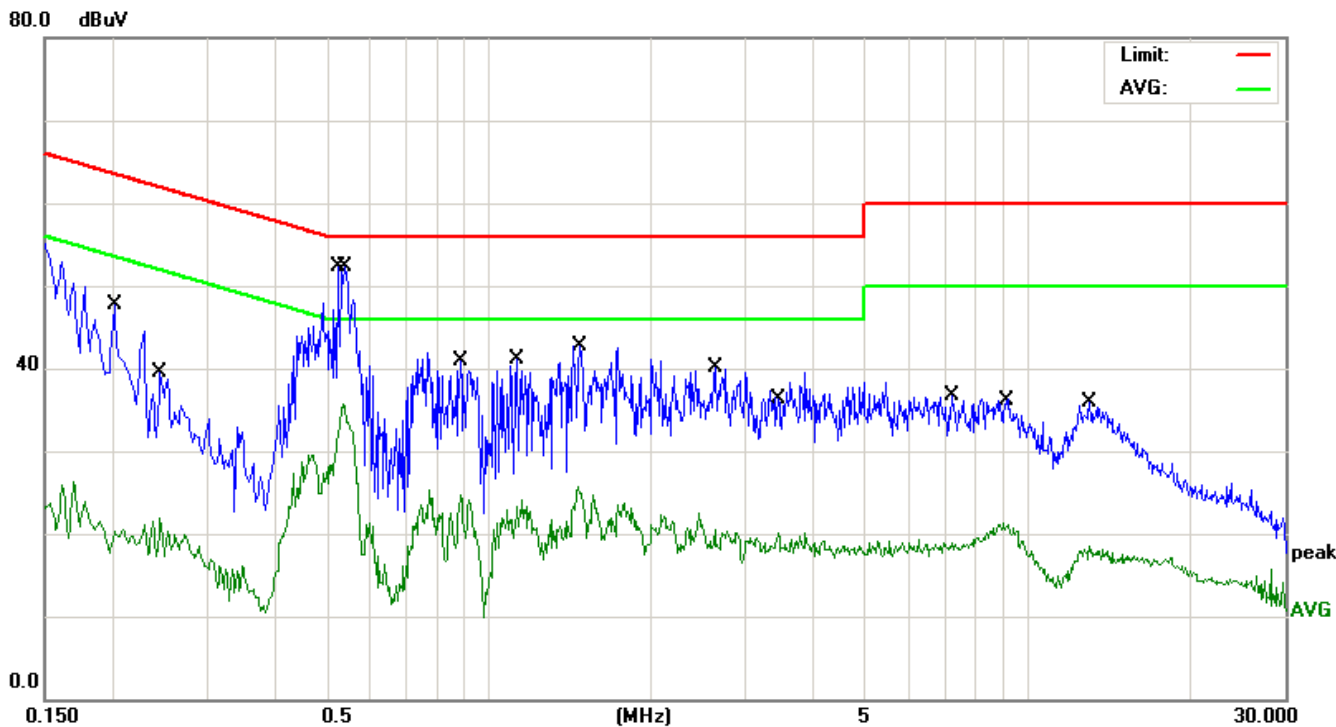

No.	Mk.	Freq. MHz	Reading Level dBuV	Correct Factor dB	Measure- ment dBuV	Limit dBuV	Over dB	Detector
1		0.2020	36.51	11.23	47.74	63.52	-15.78	QP
2		0.2460	10.72	11.15	21.87	51.89	-30.02	AVG
3		0.5260	33.55	10.70	44.25	56.00	-11.75	QP
4	*	0.5380	25.10	10.70	35.80	46.00	-10.20	AVG
5		0.8860	14.06	10.69	24.75	46.00	-21.25	AVG
6		1.1260	30.41	10.67	41.08	56.00	-14.92	QP
7		1.4660	14.98	10.66	25.64	46.00	-20.36	AVG
8		2.6340	29.56	10.60	40.16	56.00	-15.84	QP
9		3.4380	9.63	10.56	20.19	46.00	-25.81	AVG
10		7.2140	26.19	10.57	36.76	60.00	-23.24	QP
11		9.0140	10.65	10.60	21.25	50.00	-28.75	AVG
12		13.0500	25.26	10.63	35.89	60.00	-24.11	QP

EUT	Mobile phone	Model Name	X522
Temperature	26 °C	Relative Humidity	54%
Pressure	1010hPa	Phase	N
Test Date	January 06, 2017	Test Mode	Mode 3

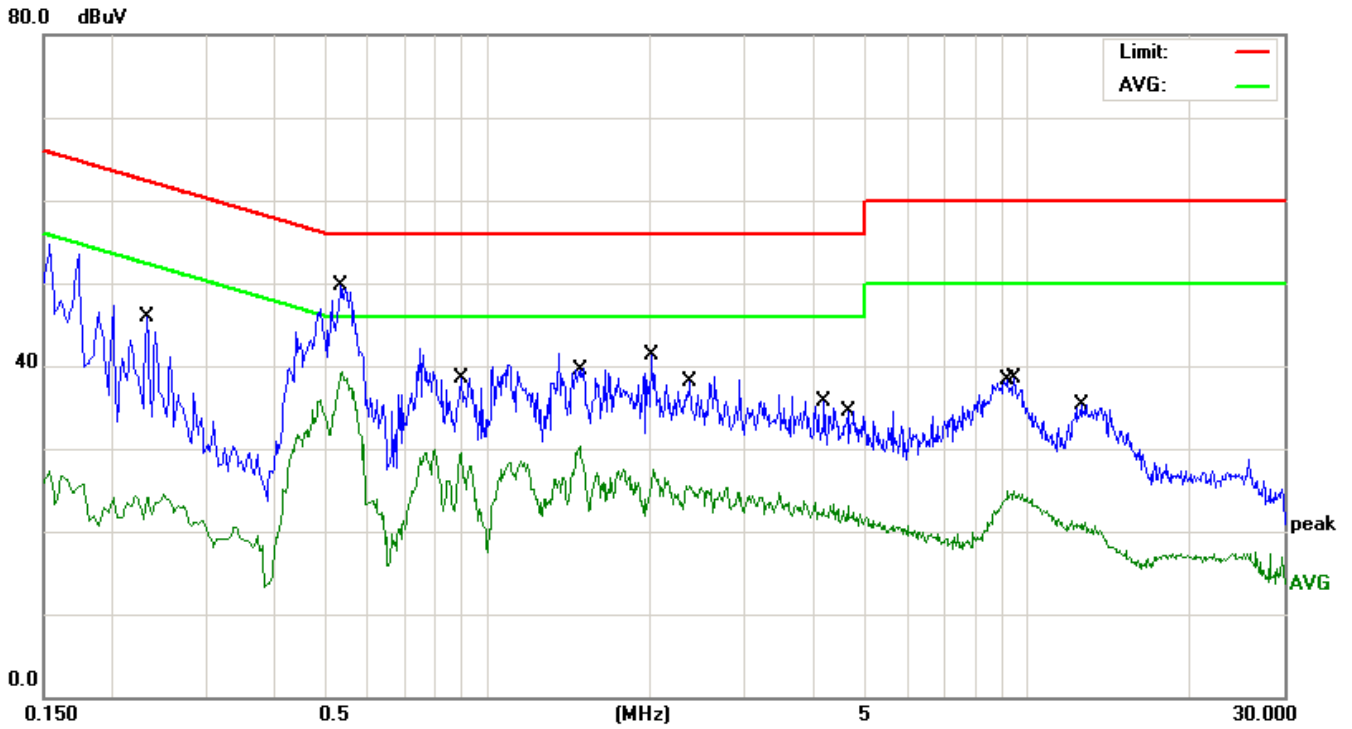

No.	Mk.	Freq.	Reading Level	Correct Factor	Measurement	Limit	Over	Detector
		MHz	dBuV	dB	dBuV	dBuV	dB	
1		0.2340	34.80	11.17	45.97	62.30	-16.33	QP
2	*	0.5340	38.91	10.70	49.61	56.00	-6.39	QP
3		0.5380	28.68	10.70	39.38	46.00	-6.62	AVG
4		0.8980	18.86	10.69	29.55	46.00	-16.45	AVG
5		1.4819	19.58	10.66	30.24	46.00	-15.76	AVG
6		2.0140	30.77	10.61	41.38	56.00	-14.62	QP
7		2.3780	14.99	10.60	25.59	46.00	-20.41	AVG
8		4.2060	25.05	10.55	35.60	56.00	-20.40	QP
9		4.6620	12.50	10.52	23.02	46.00	-22.98	AVG
10		9.2100	14.26	10.60	24.86	50.00	-25.14	AVG
11		9.4860	27.90	10.59	38.49	60.00	-21.51	QP
12		12.6140	24.77	10.63	35.40	60.00	-24.60	QP

EUT	Mobile phone	Model Name	X522
Temperature	26 °C	Relative Humidity	54%
Pressure	1010hPa	Phase	L
Test Date	January 06, 2017	Test Mode	Mode 4

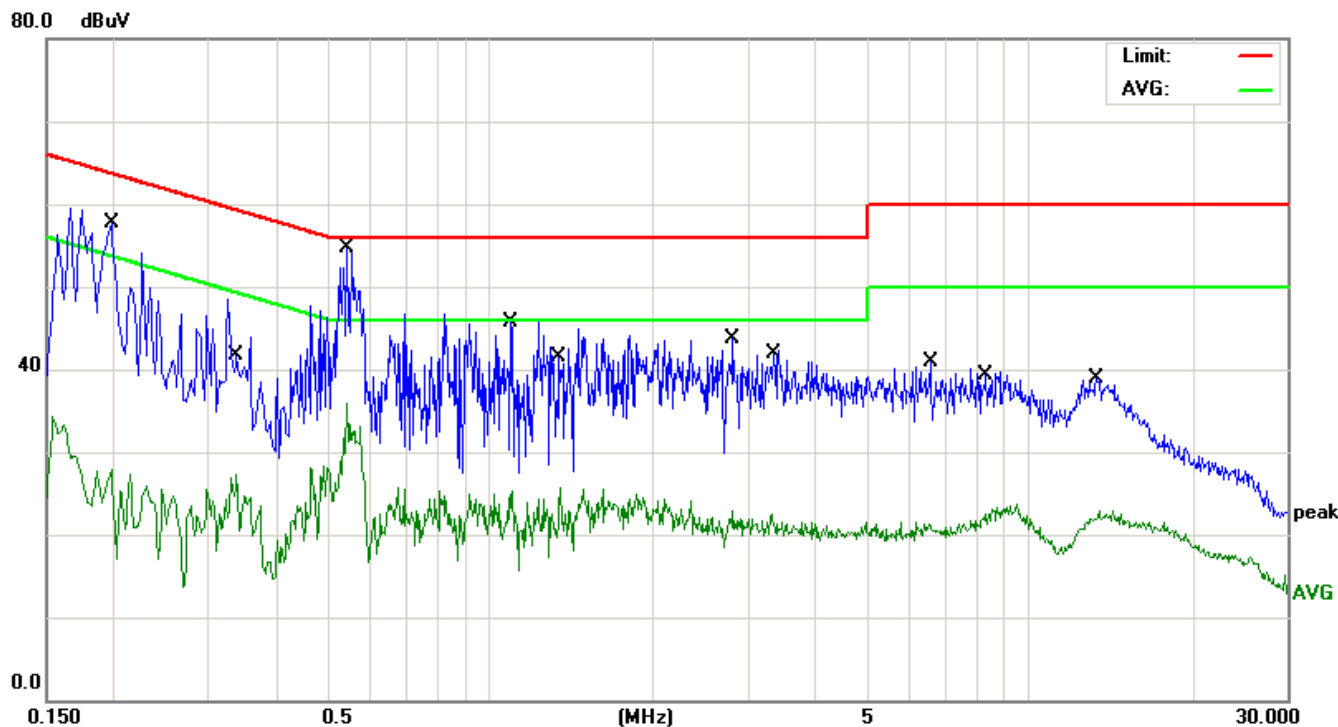

No.	Mk.	Freq. MHz	Reading Level dBuV	Correct Factor dB	Measure- ment dBuV	Limit dBuV	Over dB	Detector
1	*	0.1980	46.51	11.26	57.77	63.69	-5.92	QP
2		0.3379	16.30	10.99	27.29	49.25	-21.96	AVG
3		0.5420	35.54	10.69	46.23	56.00	-9.77	QP
4		0.5420	25.24	10.69	35.93	46.00	-10.07	AVG
5		1.0900	35.10	10.68	45.78	56.00	-10.22	QP
6		1.3500	15.08	10.66	25.74	46.00	-20.26	AVG
7		2.8179	33.18	10.57	43.75	56.00	-12.25	QP
8		3.3180	12.00	10.56	22.56	46.00	-23.44	AVG
9		6.5260	30.31	10.56	40.87	60.00	-19.13	QP
10		8.2540	12.00	10.58	22.58	50.00	-27.42	AVG
11		13.2860	28.19	10.62	38.81	60.00	-21.19	QP
12		13.4460	12.31	10.62	22.93	50.00	-27.07	AVG

EUT	Mobile phone	Model Name	X522
Temperature	26 °C	Relative Humidity	54%
Pressure	1010hPa	Phase	N
Test Date	January 06, 2017	Test Mode	Mode 4

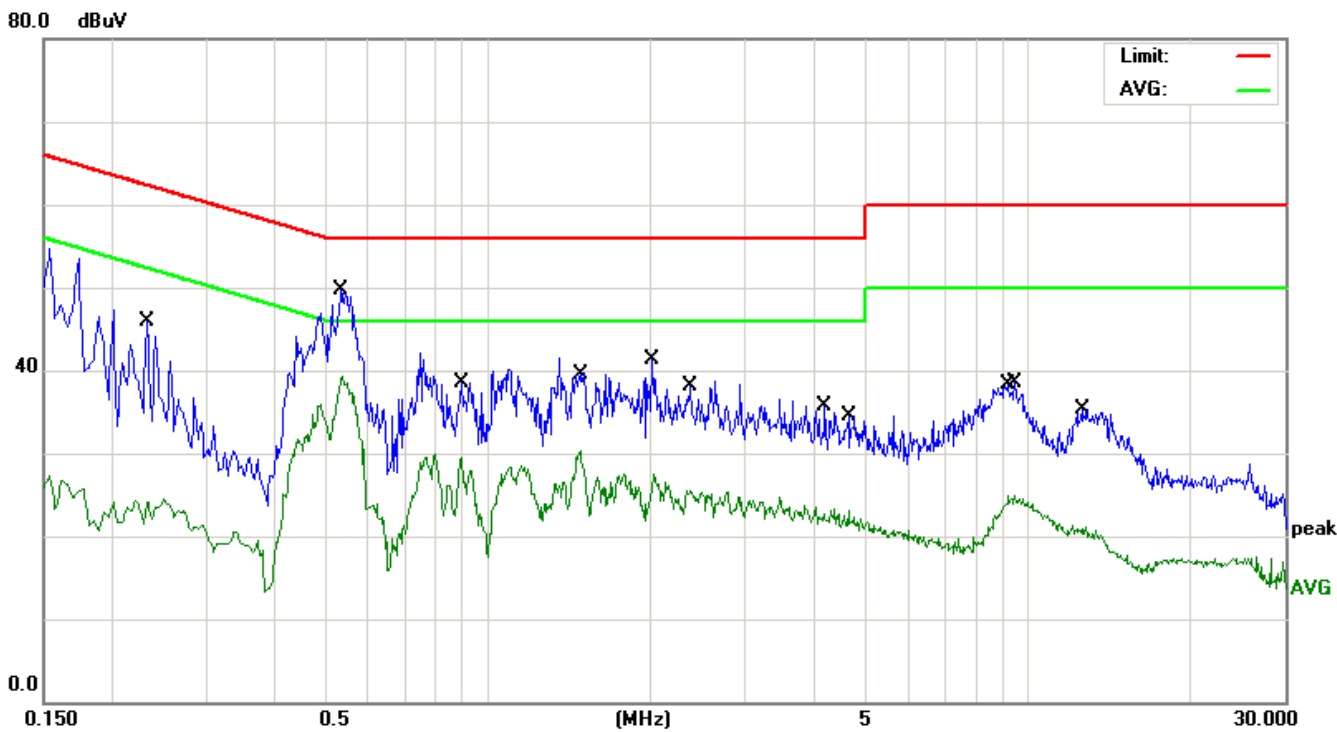

No.	Mk.	Freq. MHz	Reading Level dBuV	Correct Factor dB	Measure- ment dBuV	Limit dBuV	Over dB	Detector
1		0.2340	34.80	11.17	45.97	62.30	-16.33	QP
2	*	0.5340	38.91	10.70	49.61	56.00	-6.39	QP
3		0.5380	28.68	10.70	39.38	46.00	-6.62	AVG
4		0.8980	18.86	10.69	29.55	46.00	-16.45	AVG
5		1.4819	19.58	10.66	30.24	46.00	-15.76	AVG
6		2.0140	30.77	10.61	41.38	56.00	-14.62	QP
7		2.3780	14.99	10.60	25.59	46.00	-20.41	AVG
8		4.2060	25.05	10.55	35.60	56.00	-20.40	QP
9		4.6620	12.50	10.52	23.02	46.00	-22.98	AVG
10		9.2100	14.26	10.60	24.86	50.00	-25.14	AVG
11		9.4860	27.90	10.59	38.49	60.00	-21.51	QP
12		12.6140	24.77	10.63	35.40	60.00	-24.60	QP

EUT	Mobile phone	Model Name	X522
Temperature	26 °C	Relative Humidity	54%
Pressure	1010hPa	Phase	L
Test Date	January 06, 2017	Test Mode	Mode 5

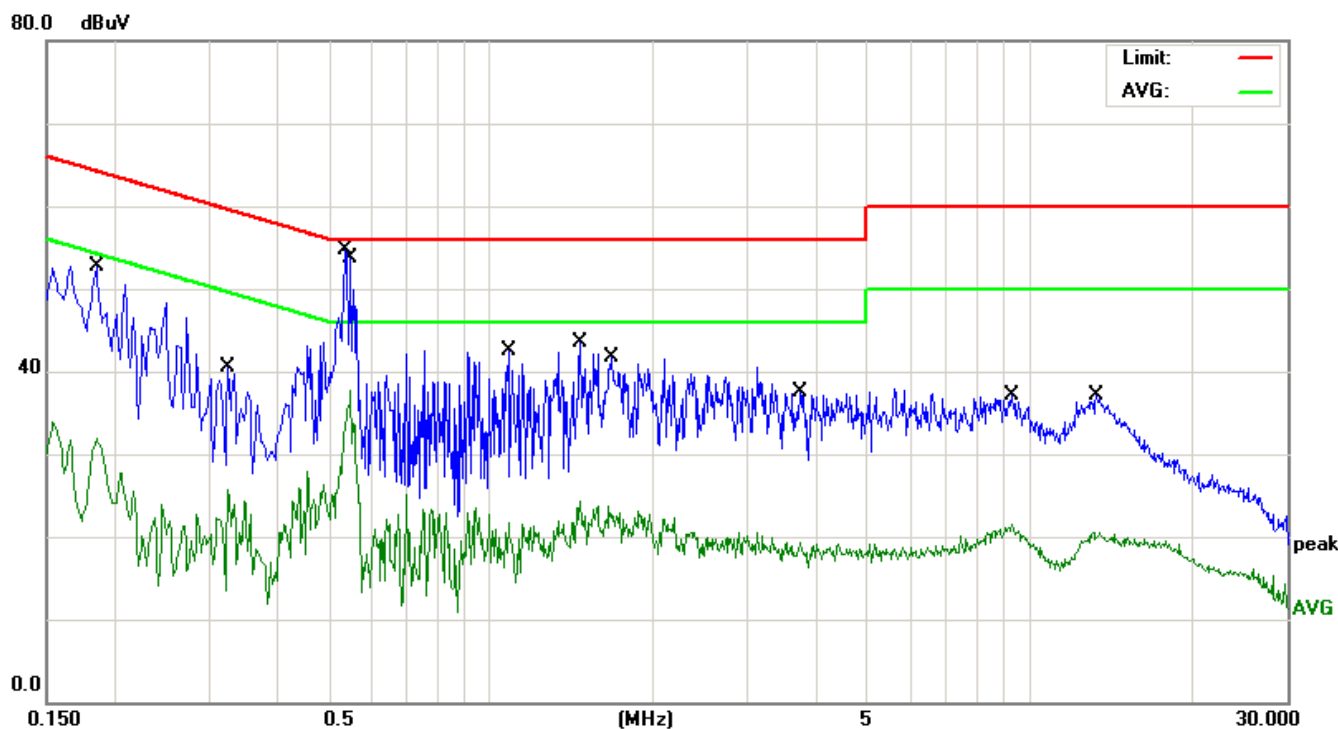

No.	Mk.	Freq. MHz	Reading Level dBuV	Correct Factor dB	Measure- ment dBuV	Limit dBuV	Over dB	Detector
1		0.1860	41.35	11.44	52.79	64.21	-11.42	QP
2		0.1860	20.39	11.44	31.83	54.21	-22.38	AVG
3		0.3260	14.78	11.01	25.79	49.55	-23.76	AVG
4		0.5380	34.89	10.70	45.59	56.00	-10.41	QP
5	*	0.5500	26.95	10.69	37.64	46.00	-8.36	AVG
6		1.0820	31.78	10.68	42.46	56.00	-13.54	QP
7		1.4700	13.55	10.66	24.21	46.00	-21.79	AVG
8		1.6780	31.04	10.63	41.67	56.00	-14.33	QP
9		3.7540	27.01	10.55	37.56	56.00	-18.44	QP
10		3.7540	8.78	10.55	19.33	46.00	-26.67	AVG
11		9.2860	10.86	10.60	21.46	50.00	-28.54	AVG
12		13.3140	26.48	10.62	37.10	60.00	-22.90	QP

EUT	Mobile phone	Model Name	X522
Temperature	26 °C	Relative Humidity	54%
Pressure	1010hPa	Phase	N
Test Date	January 06, 2017	Test Mode	Mode 5

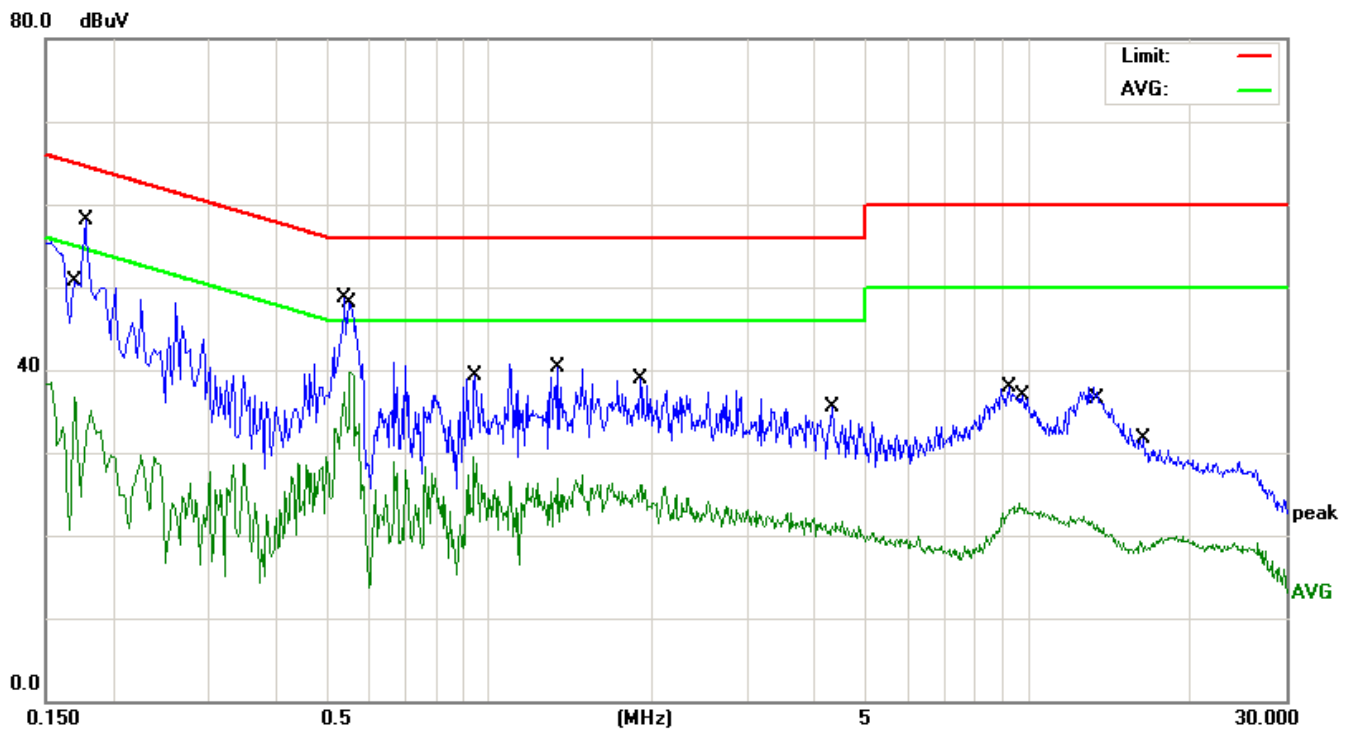

No.	Mk.	Freq. MHz	Reading Level dBuV	Correct Factor dB	Measure- ment dBuV	Limit dBuV	Over dB	Detector
1		0.1700	24.97	11.67	36.64	54.96	-18.32	AVG
2		0.1780	46.63	11.56	58.19	64.57	-6.38	QP
3		0.5380	38.05	10.70	48.75	56.00	-7.25	QP
4	*	0.5540	29.02	10.71	39.73	46.00	-6.27	AVG
5		0.9340	18.78	10.69	29.47	46.00	-16.53	AVG
6		1.3420	29.60	10.66	40.26	56.00	-15.74	QP
7		1.9180	15.58	10.61	26.19	46.00	-19.81	AVG
8		4.3180	24.91	10.52	35.43	56.00	-20.57	QP
9		9.2340	27.24	10.60	37.84	60.00	-22.16	QP
10		9.6020	13.22	10.61	23.83	50.00	-26.17	AVG
11		13.5180	10.29	10.62	20.91	50.00	-29.09	AVG
12		16.3819	21.01	10.64	31.65	60.00	-28.35	QP

5.2 RADIATED EMISSION MEASUREMENT

5.2.1 RADIATED EMISSION LIMITS (Frequency Range 9kHz-1000MHz)

The field strength of radiated emissions from unintentional radiators at a distance of 3 meters shall not exceed the following values:

Frequencies (MHz)	Field Strength (micorvolts/meter)	Measurement Distance (meters)
0.009~0.490	2400/F(KHz)	300
0.490~1.705	24000/F(KHz)	30
1.705~30.0	30	30
30~88	100	3
88~216	150	3
216~960	200	3
Above 960	500	3

LIMITS OF RADIATED EMISSION MEASUREMENT (Above 1000MHz)

FREQUENCY (MHz)	Limit (dBuV/m) (at 3M)	
	PEAK	AVERAGE
Above 1000	74	54

Notes:

- (1) The limit for radiated test was performed according to FCC PART 15B.
- (2) The tighter limit applies at the band edges.
- (3) Emission level (dBuV/m)=20log Emission level (uV/m).

Spectrum Parameter	Setting
Attenuation	Auto
Start Frequency	1000 MHz
Stop Frequency	10th carrier harmonic
RB / VB (emission in restricted band)	1 MHz / 1 MHz for Peak, 1 MHz / 1Hz for Average

Receiver Parameter	Setting
Attenuation	Auto
Start ~ Stop Frequency	9kHz~150kHz / RB 200Hz for QP
Start ~ Stop Frequency	150kHz~30MHz / RB 9kHz for QP
Start ~ Stop Frequency	30MHz~1000MHz / RB 120kHz for QP

5.2.2 TEST PROCEDURE

- a. The measuring distance of at 3 m shall be used for measurements at frequency up to 1GHz. For frequencies above 1GHz, any suitable measuring distance may be used.
- b. The EUT was placed on the top of a rotating table 0.8 meters above the ground at a 3 meter open area test site. The table was rotated 360 degrees to determine the position of the highest radiation.
- c. The height of the equipment or of the substitution antenna shall be 0.8 m; the height of the test antenna shall vary between 1 m to 4 m. Both horizontal and vertical polarizations of the antenna are set to make the measurement.
- d. The initial step in collecting conducted emission data is a spectrum analyzer peak detector mode pre-scanning the measurement frequency range. Significant peaks are then marked and then Quasi Peak detector mode re-measured.
- e. If the Peak Mode measured value compliance with and lower than Quasi Peak Mode Limit, the EUT shall be deemed to meet QP Limits and then no additional QP Mode measurement performed.
- f. For the actual test configuration, please refer to the related Item –EUT Test Photos.

Note:

Both horizontal and vertical antenna polarities were tested and performed pretest to three orthogonal axis. The worst case emissions were reported

5.2.3 DEVIATION FROM TEST STANDARD

No deviation

5.2.4 TEST SETUP

(A) Radiated Emission Test-Up Frequency 30MHz~1GHz

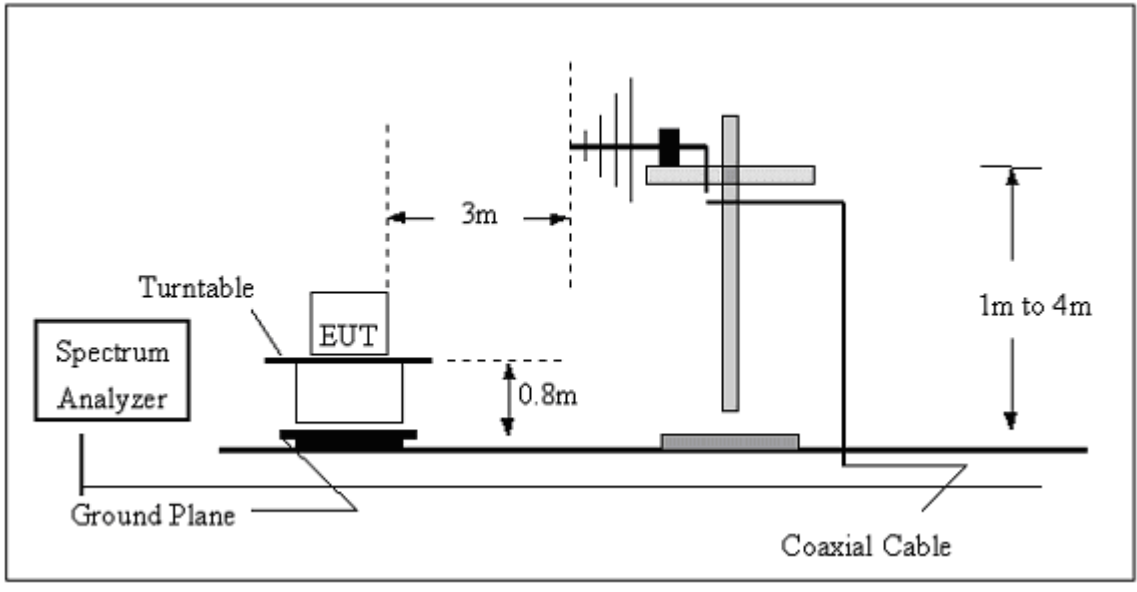

(B) Radiated Emission Test-Up Frequency Above 1GHz

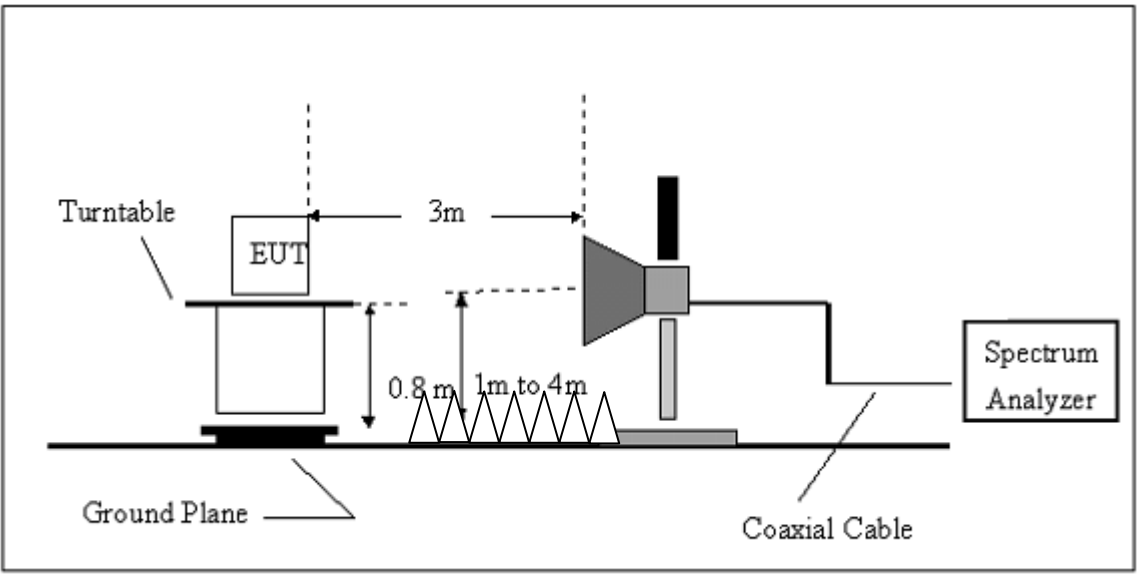

5.2.5 EUT OPERATING CONDITIONS

The EUT tested system was configured as the statements of 2.4 Unless otherwise a special operating condition is specified in the follows during the testing.

5.2.5.1 TEST RESULTS (BETWEEN 30M – 1000 MHZ)

EUT	Mobile phone	Model Name	X522
Temperature	20 °C	Relative Humidity	48%
Pressure	1010 hPa	Polarization :	Horizontal
Test Mode	Mode 1	Test Date	January 06, 2017

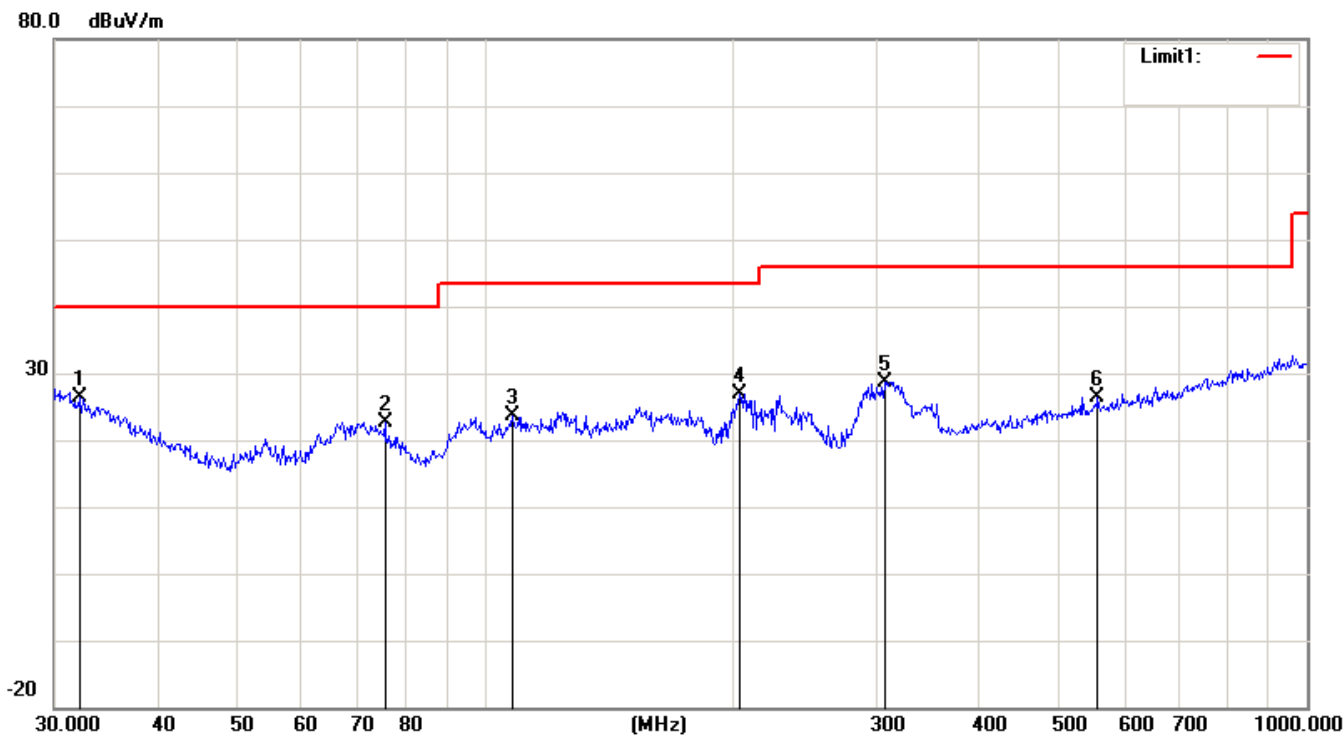

No.	Mk.	Freq. MHz	Reading Level dBuV	Correct Factor dB	Measure- ment dBuV/m	Limit dBuV/m	Over dB	Detector
1	*	32.1795	24.32	2.03	26.35	40.00	-13.65	QP
2		75.7114	30.25	-7.56	22.69	40.00	-17.31	QP
3		108.2667	27.59	-4.06	23.53	43.50	-19.97	QP
4		204.2377	31.87	-4.97	26.90	43.50	-16.60	QP
5		306.7537	33.41	-4.78	28.63	46.00	-17.37	QP
6		556.7744	26.13	0.37	26.50	46.00	-19.50	QP

EUT	Mobile phone	Model Name	X522
Temperature	20 °C	Relative Humidity	48%
Pressure	1010 hPa	Polarization :	Vertical
Test Mode	Mode 1	Test Date	January 06, 2017

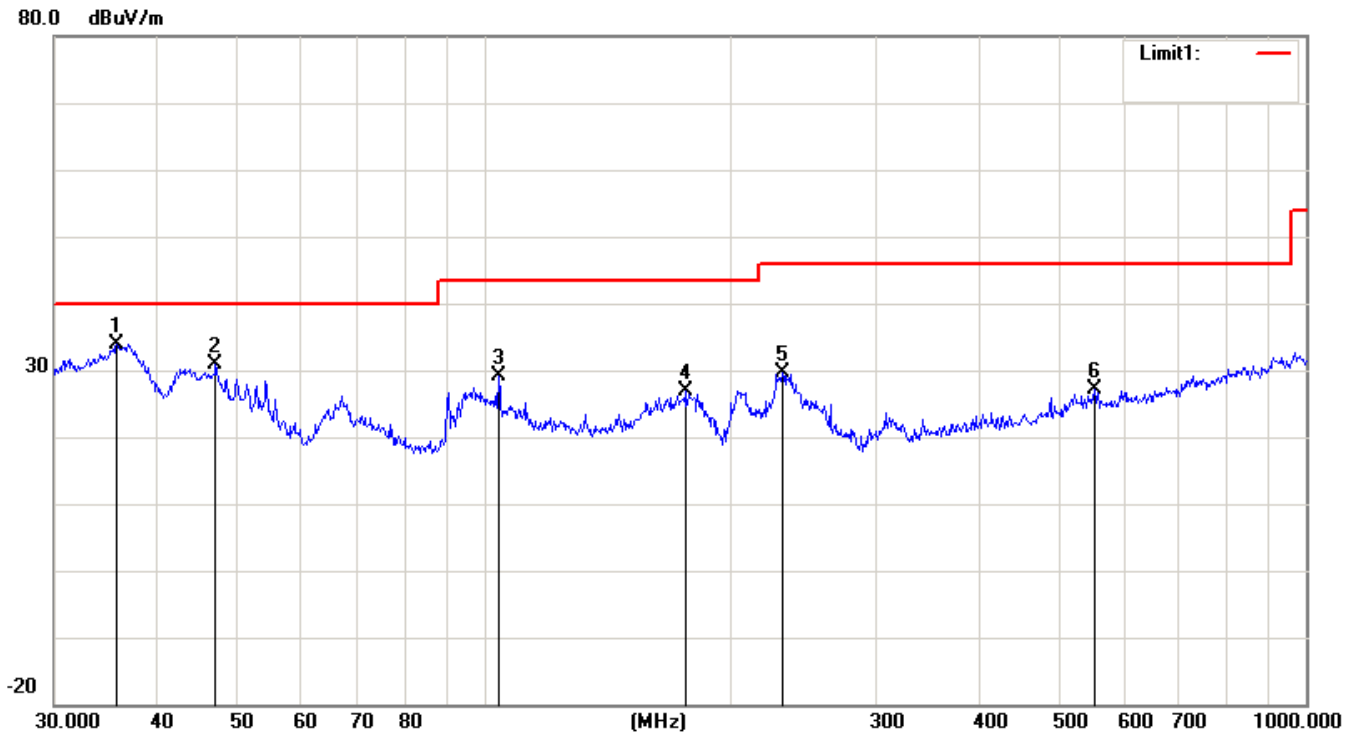

No.	Mk.	Freq. MHz	Reading Level dBuV	Correct Factor dB	Measure- ment dBuV/m	Limit dBuV/m	Over dB	Detector
1	*	35.7490	34.23	-0.41	33.82	40.00	-6.18	QP
2		47.1599	38.63	-7.71	30.92	40.00	-9.08	QP
3		104.1701	34.27	-5.18	29.09	43.50	-14.41	QP
4		176.2686	31.85	-4.99	26.86	43.50	-16.64	QP
5		230.9068	35.63	-5.92	29.71	46.00	-16.29	QP
6		552.8832	26.77	0.43	27.20	46.00	-18.80	QP

EUT	Mobile phone	Model Name	X522
Temperature	20 °C	Relative Humidity	48%
Pressure	1010 hPa	Polarization :	Horizontal
Test Mode	Mode 2	Test Date	January 06, 2017

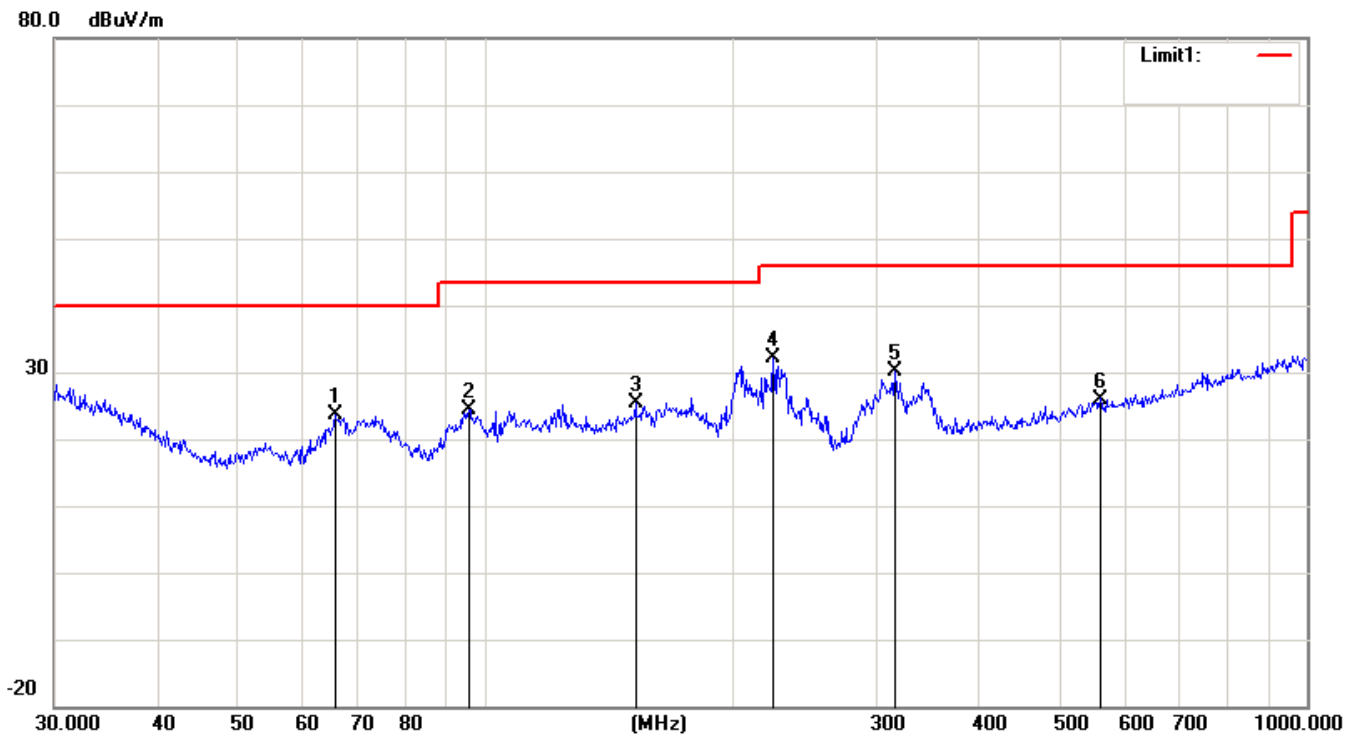

No.	Mk.	Freq. MHz	Reading Level dBuV	Correct Factor dB	Measure- ment dBuV/m	Limit dBuV/m	Over dB	Detector
1		65.8031	32.14	-8.63	23.51	40.00	-16.49	QP
2		95.7622	31.58	-7.19	24.39	43.50	-19.11	QP
3		152.6641	29.41	-4.05	25.36	43.50	-18.14	QP
4	*	224.5193	37.93	-5.70	32.23	46.00	-13.77	QP
5		315.4808	34.47	-4.42	30.05	46.00	-15.95	QP
6		560.6928	25.66	0.34	26.00	46.00	-20.00	QP

EUT	Mobile phone	Model Name	X522
Temperature	20 °C	Relative Humidity	48%
Pressure	1010 hPa	Polarization :	Vertical
Test Mode	Mode 2	Test Date	January 06, 2017

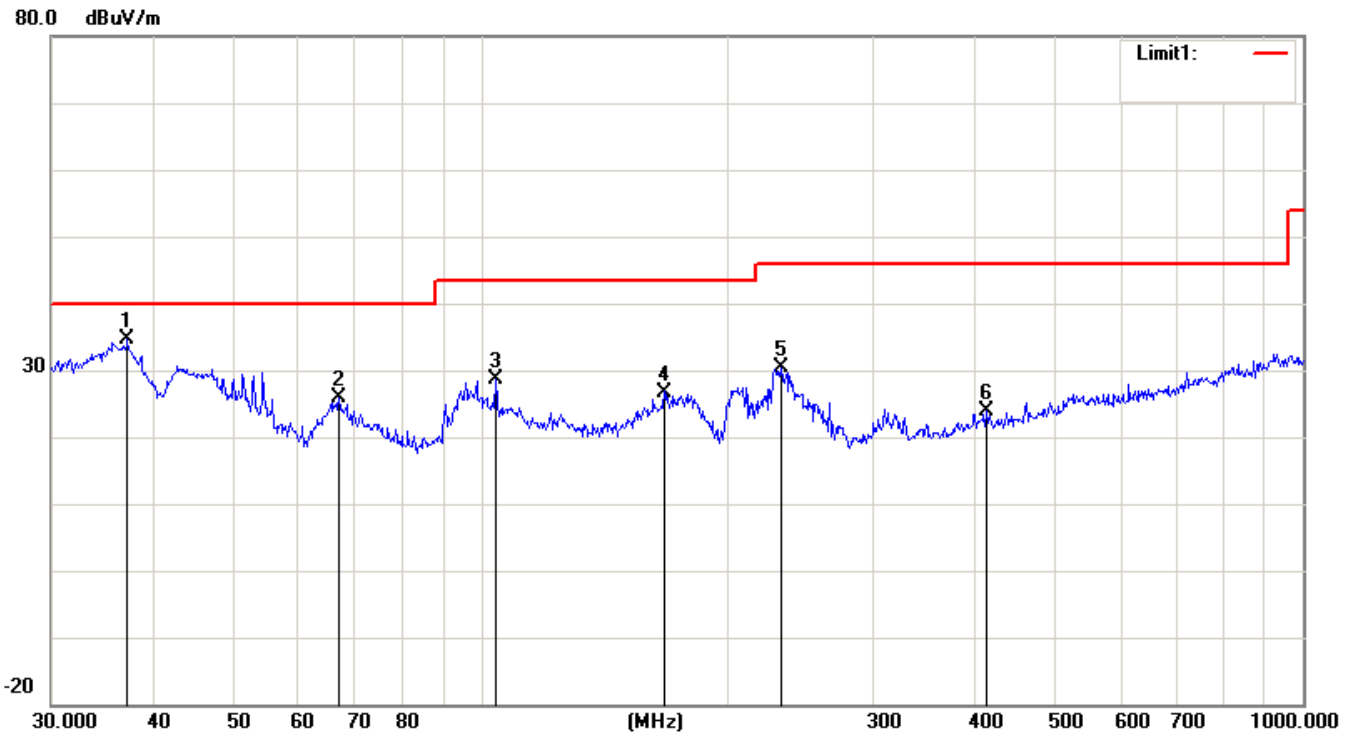

No.	Mk.	Freq. MHz	Reading Level dBuV	Correct Factor dB	Measure- ment dBuV/m	Limit dBuV/m	Over dB	Detector
1	*	37.1550	36.05	-1.43	34.62	40.00	-5.38	QP
2		67.2022	34.15	-8.36	25.79	40.00	-14.21	QP
3		104.1701	33.87	-5.18	28.69	43.50	-14.81	QP
4		167.2368	31.35	-4.60	26.75	43.50	-16.75	QP
5		231.7179	36.22	-5.95	30.27	46.00	-15.73	QP
6		411.8240	25.86	-2.02	23.84	46.00	-22.16	QP

EUT	Mobile phone	Model Name	X522
Temperature	20 °C	Relative Humidity	48%
Pressure	1010 hPa	Polarization :	Horizontal
Test Mode	Mode 3	Test Date	January 06, 2017

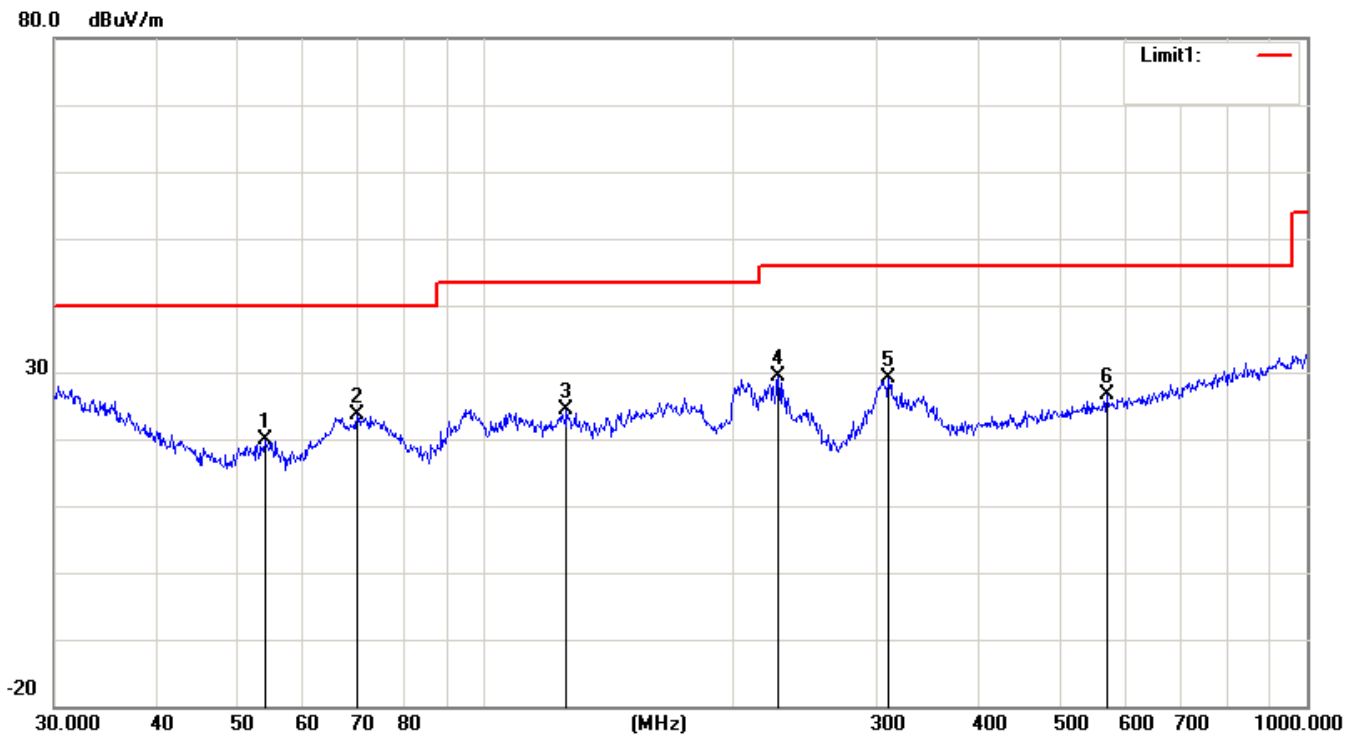

No.	Mk.	Freq. MHz	Reading Level dBuV	Correct Factor dB	Measure- ment dBuV/m	Limit dBuV/m	Over dB	Detector
1		54.0711	29.19	-9.41	19.78	40.00	-20.22	QP
2	*	70.0903	31.54	-7.81	23.73	40.00	-16.27	QP
3		125.8864	26.54	-2.14	24.40	43.50	-19.10	QP
4		227.6906	35.09	-5.80	29.29	46.00	-16.71	QP
5		309.9977	33.57	-4.32	29.25	46.00	-16.75	QP
6		570.6100	26.17	0.49	26.66	46.00	-19.34	QP

EUT	Mobile phone	Model Name	X522
Temperature	20 °C	Relative Humidity	48%
Pressure	1010 hPa	Polarization :	Vertical
Test Mode	Mode 3	Test Date	January 06, 2017

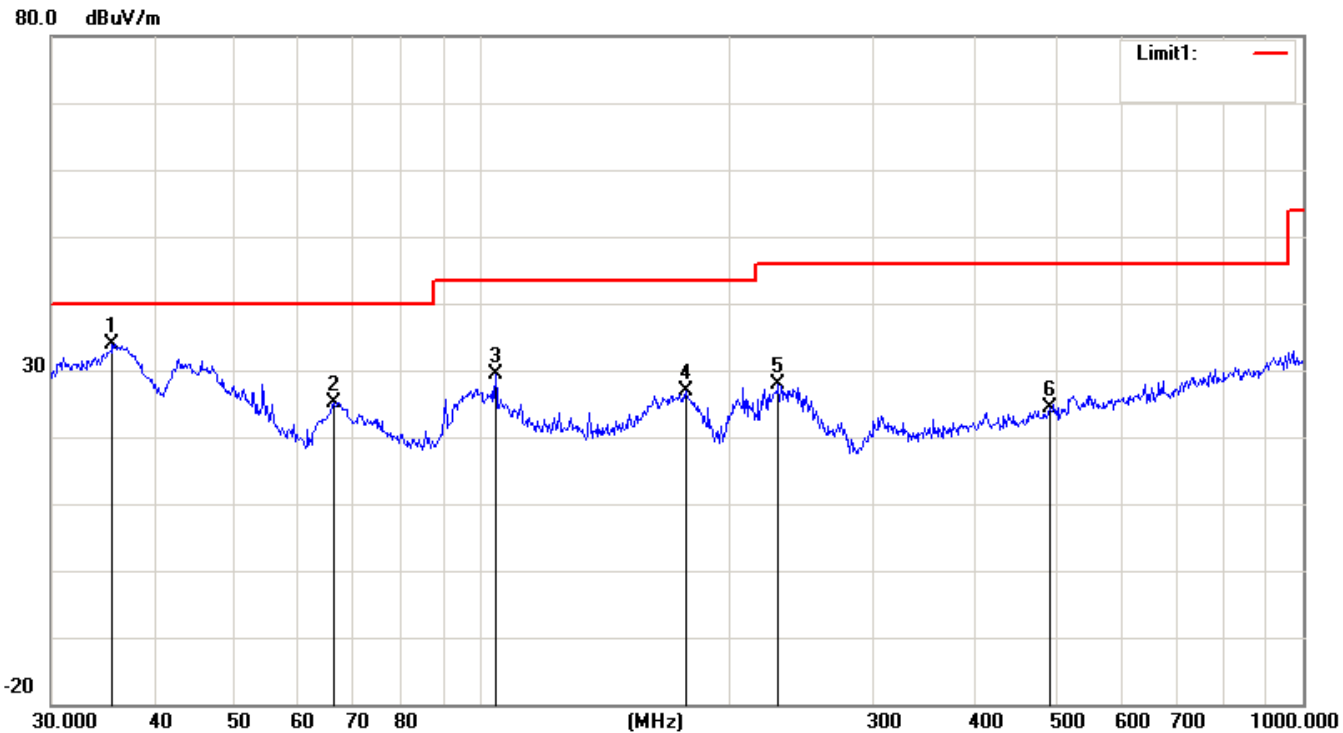

No.	Mk.	Freq. MHz	Reading Level dBuV	Correct Factor dB	Measure- ment dBuV/m	Limit dBuV/m	Over dB	Detector
1	*	35.6240	34.27	-0.32	33.95	40.00	-6.05	QP
2		66.2662	33.73	-8.54	25.19	40.00	-14.81	QP
3		104.1701	34.59	-5.18	29.41	43.50	-14.09	QP
4		177.5092	31.88	-5.05	26.83	43.50	-16.67	QP
5		230.0985	33.70	-5.89	27.81	46.00	-18.19	QP
6		492.4685	25.19	-0.92	24.27	46.00	-21.73	QP

EUT	Mobile phone	Model Name	X522
Temperature	20 °C	Relative Humidity	48%
Pressure	1010 hPa	Polarization :	Horizontal
Test Mode	Mode 4	Test Date	January 06, 2017

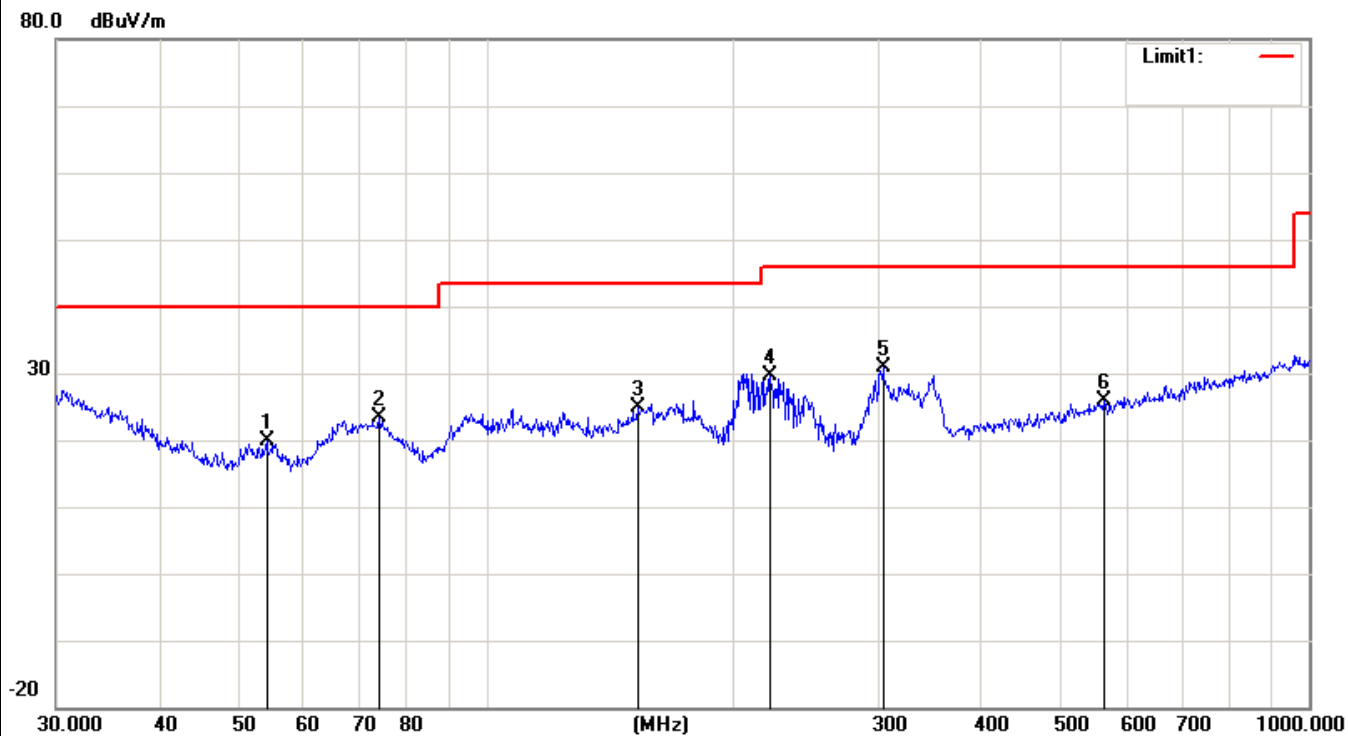

No.	Mk.	Freq. MHz	Reading Level dBuV	Correct Factor dB	Measure- ment dBuV/m	Limit dBuV/m	Over dB	Detector
1		54.0711	29.37	-9.41	19.96	40.00	-20.04	QP
2		74.1351	30.93	-7.58	23.35	40.00	-16.65	QP
3		152.6641	28.83	-4.05	24.78	43.50	-18.72	QP
4		221.3921	35.28	-5.58	29.70	46.00	-16.30	QP
5	*	303.5437	36.12	-5.23	30.89	46.00	-15.11	QP
6		562.6624	25.60	0.37	25.97	46.00	-20.03	QP

EUT	Mobile phone	Model Name	X522
Temperature	20 °C	Relative Humidity	48%
Pressure	1010 hPa	Polarization :	Vertical
Test Mode	Mode 4	Test Date	January 06, 2017

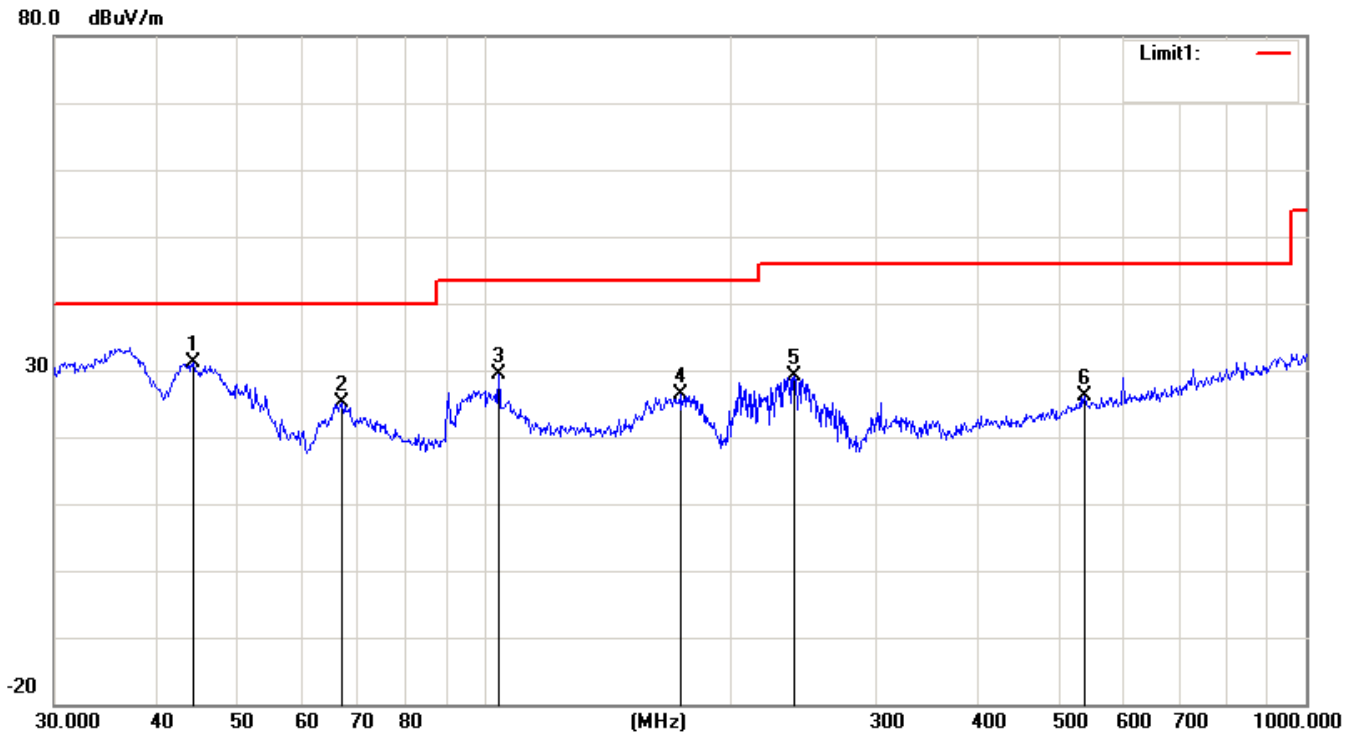

No.	Mk.	Freq. MHz	Reading Level dBuV	Correct Factor dB	Measure- ment dBuV/m	Limit dBuV/m	Over dB	Detector
1	*	44.2752	37.35	-6.25	31.10	40.00	-8.90	QP
2		67.2022	33.45	-8.36	25.09	40.00	-14.91	QP
3		104.1701	34.65	-5.18	29.47	43.50	-14.03	QP
4		173.2051	31.28	-4.85	26.43	43.50	-17.07	QP
5		238.3102	35.23	-6.19	29.04	46.00	-16.96	QP
6		537.5891	26.30	-0.20	26.10	46.00	-19.90	QP

EUT	Mobile phone	Model Name	X522
Temperature	20 °C	Relative Humidity	48%
Pressure	1010 hPa	Polarization :	Horizontal
Test Mode	Mode 5	Test Date	January 06, 2017

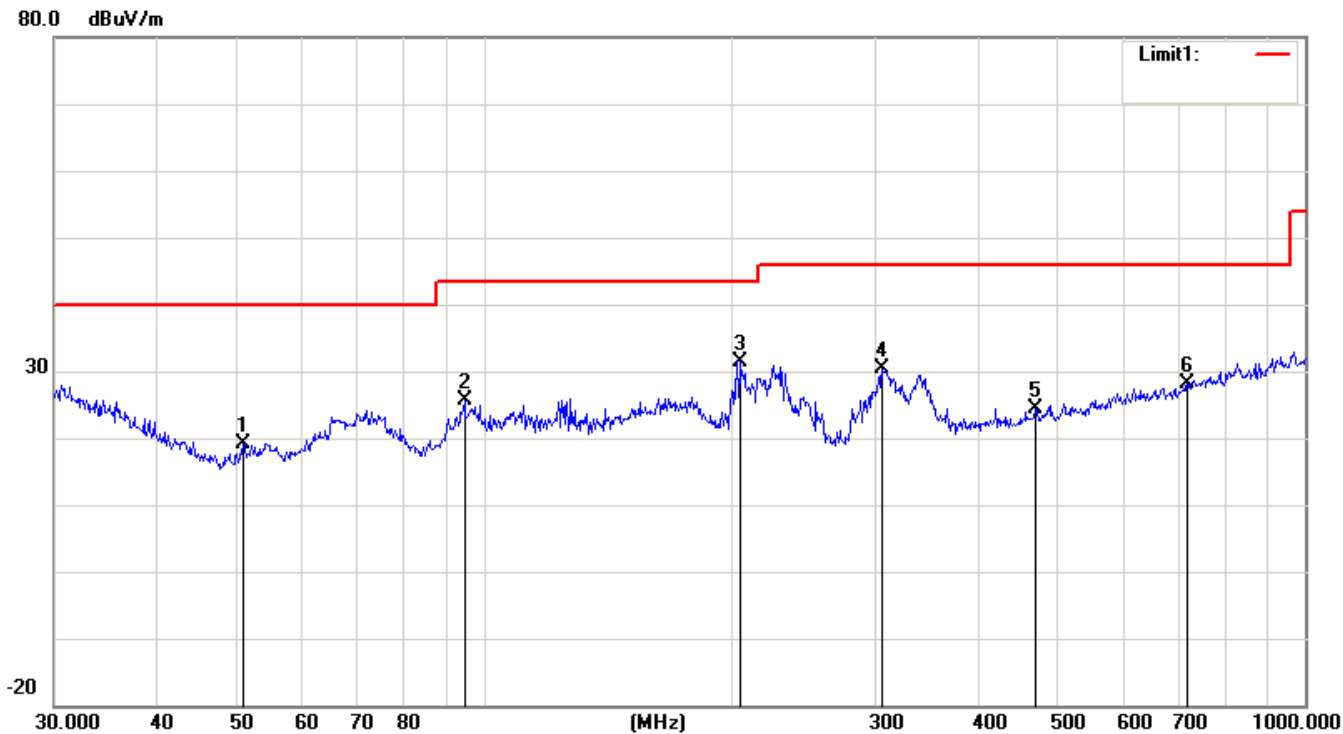

No.	Mk.	Freq. MHz	Reading Level dBuV	Correct Factor dB	Measure- ment dBuV/m	Limit dBuV/m	Over dB	Detector
1		50.9420	28.32	-9.10	19.22	40.00	-20.78	QP
2		94.7601	33.11	-7.38	25.73	43.50	-17.77	QP
3	*	204.9551	36.50	-5.00	31.50	43.50	-12.00	QP
4		305.6800	35.21	-4.93	30.28	46.00	-15.72	QP
5		468.8762	25.77	-1.41	24.36	46.00	-21.64	QP
6		719.1995	25.16	2.94	28.10	46.00	-17.90	QP

EUT	Mobile phone	Model Name	X522
Temperature	20 °C	Relative Humidity	48%
Pressure	1010 hPa	Polarization :	Vertical
Test Mode	Mode 5	Test Date	January 06, 2017

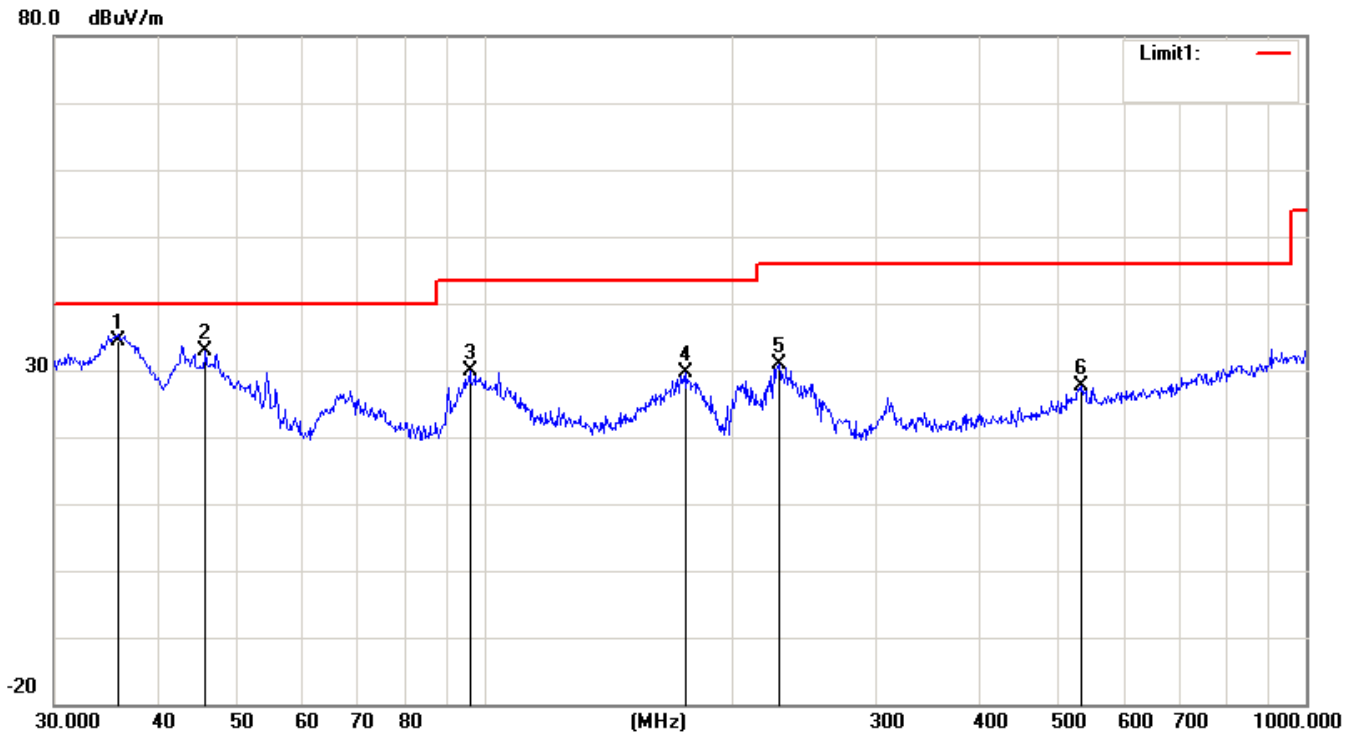

No.	Mk.	Freq. MHz	Reading Level dBuV	Correct Factor dB	Measure- ment dBuV/m	Limit dBuV/m	Over dB	Detector
1	*	35.8746	34.87	-0.51	34.36	40.00	-5.64	QP
2		45.8553	40.02	-7.11	32.91	40.00	-7.09	QP
3		96.0986	36.96	-7.12	29.84	43.50	-13.66	QP
4		176.2686	34.73	-4.99	29.74	43.50	-13.76	QP
5		228.4904	36.61	-5.84	30.77	46.00	-15.23	QP
6		533.8321	27.81	-0.25	27.56	46.00	-18.44	QP

5.2.5.2 TEST RESULTS (1GHZ TO 6GHZ)

EUT	Mobile phone	Model Name	X522
Temperature	20 °C	Relative Humidity	48%
Pressure	1010 hPa	Test Mode	Mode 1
Test Date	January 06, 2017		

Freq. (MHz)	Ant. Pol.	Emission Level(dBuV)		Limit 3m(dBuV/m)		Over(dB)	
		PK	AV	PK	AV	PK	AV
1632.45	V	58.68	41.15	74	54	-15.32	-12.85
2829.27	V	58.32	40.50	74	54	-15.68	-13.50
1684.52	H	58.23	40.39	74	54	-15.77	-13.61
2831.6	H	59.11	40.11	74	54	-14.89	-13.89

Remark:

All emissions not reported were more than 20dB below the specified limit or in the noise floor.
Factor = Antenna Factor + Cable Loss – Pre-amplifier.
All the x/y/z orientation has been investigated, and only worst case is presented in this report.

EUT	Mobile phone	Model Name	X522
Temperature	20 °C	Relative Humidity	48%
Pressure	1010 hPa	Test Mode	Mode 2
Test Date	January 06, 2017		

Freq. (MHz)	Ant. Pol.	Emission Level(dBuV)		Limit 3m(dBuV/m)		Over(dB)	
		PK	AV	PK	AV	PK	AV
1583.35	V	60.26	40.90	74	54	-13.74	-13.10
2641.52	V	59.80	40.94	74	54	-14.20	-13.06
1628.42	H	59.22	40.30	74	54	-14.78	-13.70
2810.39	H	59.75	40.75	74	54	-14.25	-13.25

Remark:

All emissions not reported were more than 20dB below the specified limit or in the noise floor.
Factor = Antenna Factor + Cable Loss – Pre-amplifier.
All the x/y/z orientation has been investigated, and only worst case is presented in this report.

EUT	Mobile phone	Model Name	X522
Temperature	20 °C	Relative Humidity	48%
Pressure	1010 hPa	Test Mode	Mode 3
Test Date	January 06, 2017		

Freq. (MHz)	Ant. Pol.	Emission Level(dBuV)		Limit 3m(dBuV/m)		Over(dB)	
		PK	AV	PK	AV	PK	AV
1577.35	V	60.98	39.03	74	54	-13.02	-14.97
2652.38	V	58.63	39.35	74	54	-15.37	-14.65
1699.33	H	58.05	39.28	74	54	-15.95	-14.72
2739.42	H	59.73	40.73	74	54	-14.27	-13.27

Remark:

All emissions not reported were more than 20dB below the specified limit or in the noise floor.

Factor = Antenna Factor + Cable Loss – Pre-amplifier.

All the x/y/z orientation has been investigated, and only worst case is presented in this report.

EUT	Mobile phone	Model Name	X522
Temperature	20 °C	Relative Humidity	48%
Pressure	1010 hPa	Test Mode	Mode 4
Test Date	January 06, 2017		

Freq. (MHz)	Ant. Pol.	Emission Level(dBuV)		Limit 3m(dBuV/m)		Over(dB)	
		PK	AV	PK	AV	PK	AV
1583.35	V	58.12	39.56	74	54	-15.88	-14.44
2641.52	V	59.15	39.54	74	54	-14.85	-14.46
1628.42	H	58.61	39.32	74	54	-15.39	-14.68
2810.39	H	58.87	39.87	74	54	-15.13	-14.13

Remark:

All emissions not reported were more than 20dB below the specified limit or in the noise floor.

Factor = Antenna Factor + Cable Loss – Pre-amplifier.

All the x/y/z orientation has been investigated, and only worst case is presented in this report.

EUT	Mobile phone	Model Name	X522
Temperature	20 °C	Relative Humidity	48%
Pressure	1010 hPa	Test Mode	Mode 5
Test Date	January 06, 2017		

Freq. (MHz)	Ant. Pol.	Emission Level(dBuV)		Limit 3m(dBuV/m)		Over(dB)	
		PK	AV	PK	AV	PK	AV
1577.35	V	59.04	39.41	74	54	-14.96	-14.59
2652.38	V	58.43	39.70	74	54	-15.57	-14.30
1699.33	H	58.45	39.99	74	54	-15.55	-14.01
2739.42	H	58.25	39.25	74	54	-15.75	-14.75

Remark:

All emissions not reported were more than 20dB below the specified limit or in the noise floor.
Factor = Antenna Factor + Cable Loss – Pre-amplifier.

All the x/y/z orientation has been investigated, and only worst case is presented in this report.

6. EUT TEST PHOTO

CONDUCTED EMISSION TEST



CONDUCTED EMISSION TEST

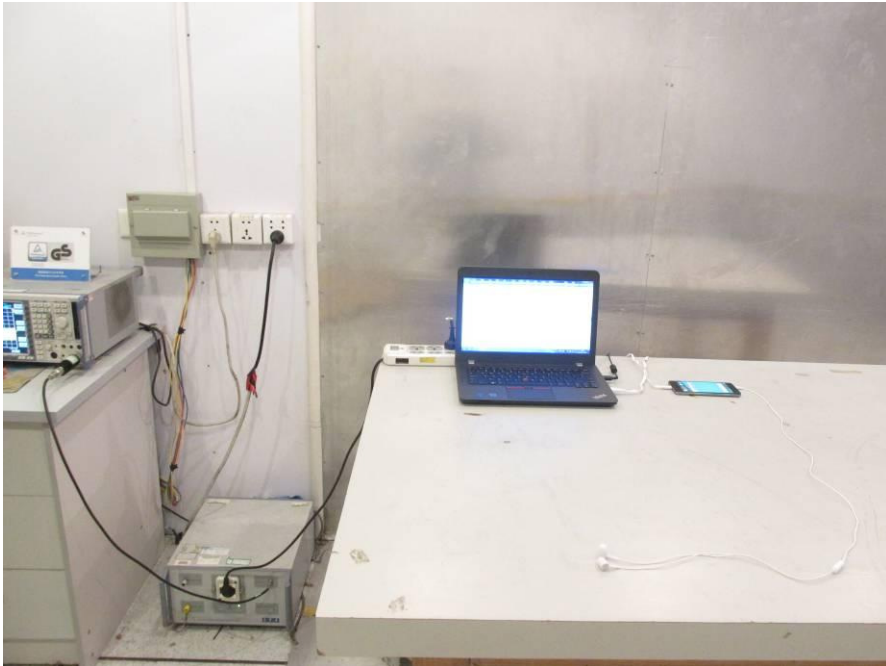

RADIATED EMISSION TEST

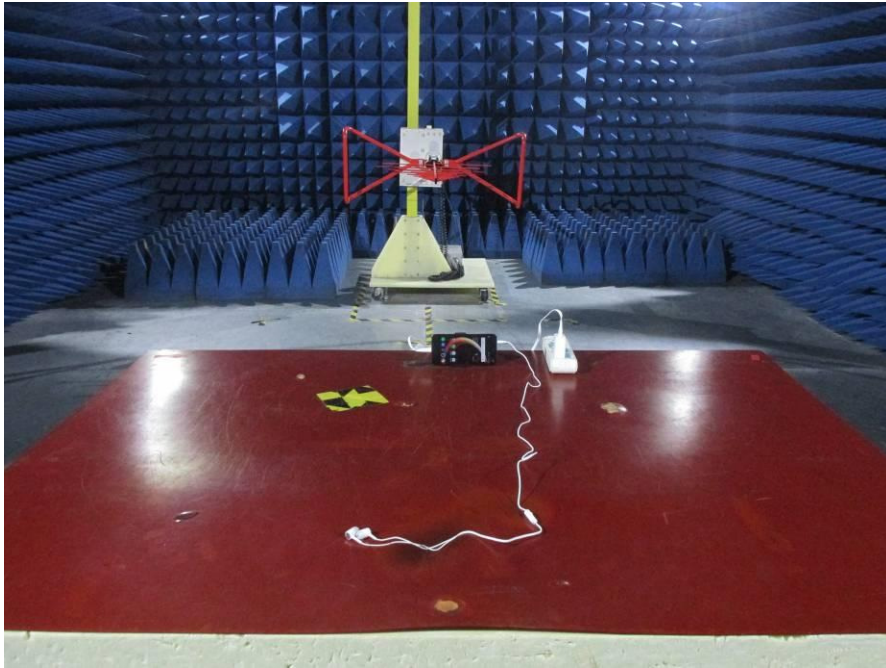

RADIATED EMISSION TEST

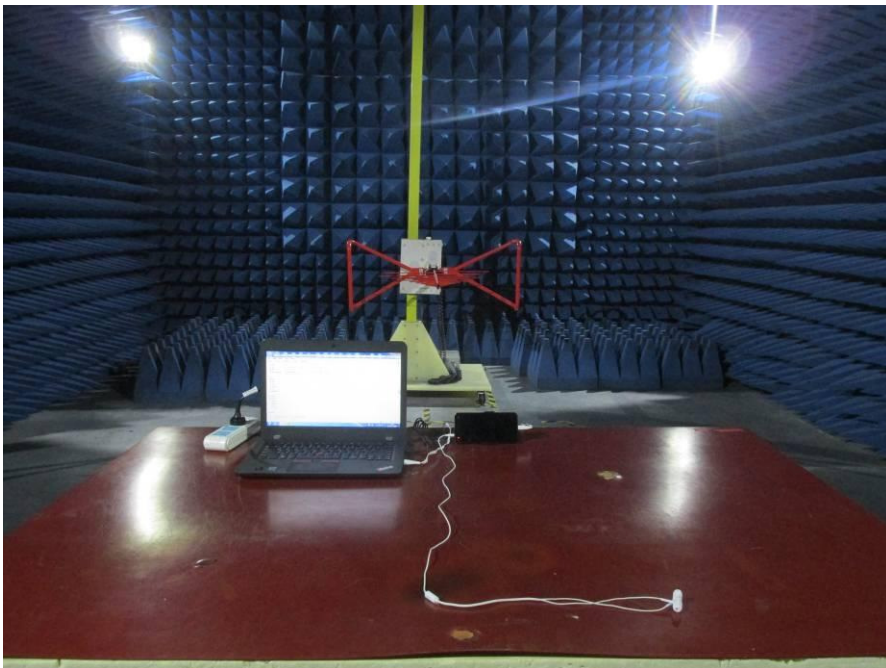

RADIATED EMISSION TEST

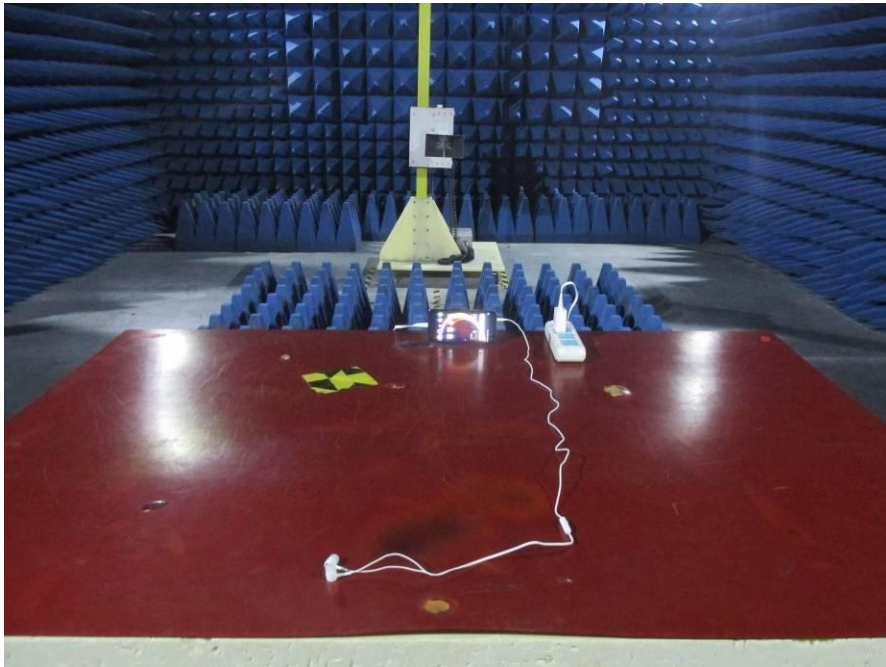

RADIATED EMISSION TEST

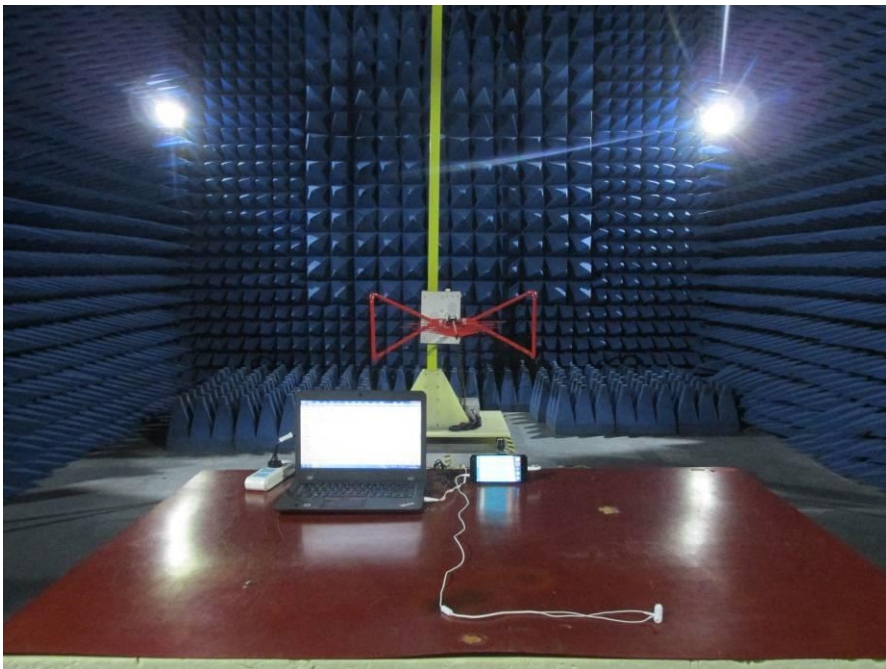

RADIATED EMISSION TEST

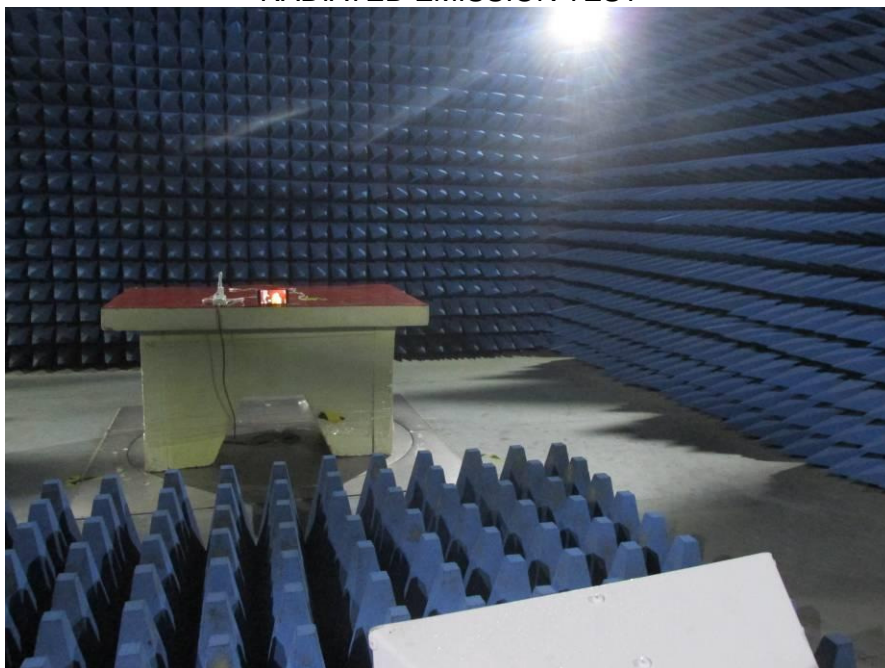

RADIATED EMISSION TEST

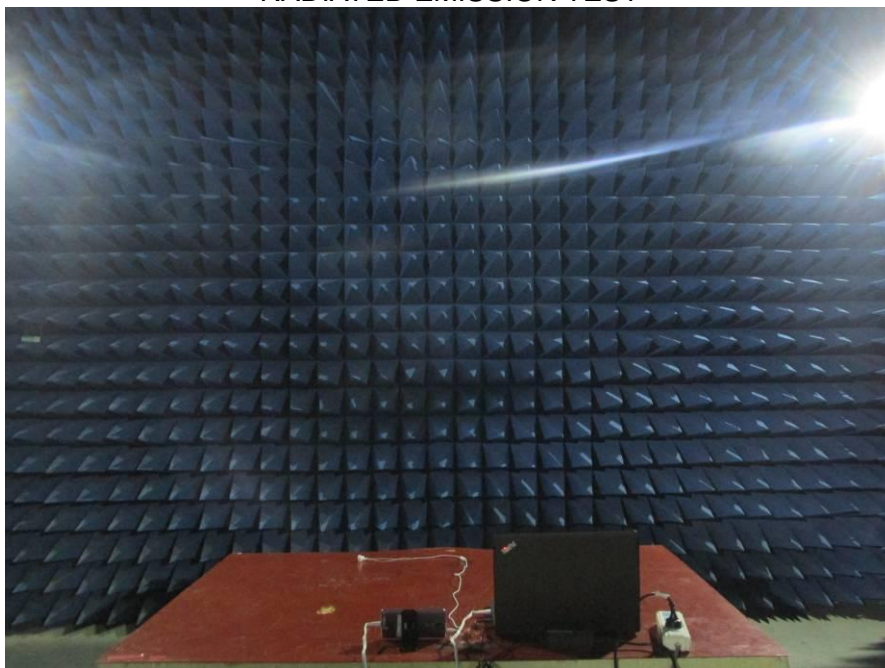

7. PHOTOGRAPHS OF EUT

Appearance photograph of EUT



Appearance photograph of EUT



Appearance photograph of EUT



Appearance photograph of EUT



Appearance photograph of EUT



Appearance photograph of EUT



Appearance photograph of EUT



Internal photograph of EUT



Internal photograph of EUT



Internal photograph of EUT



Internal photograph of EUT



Internal photograph of EUT

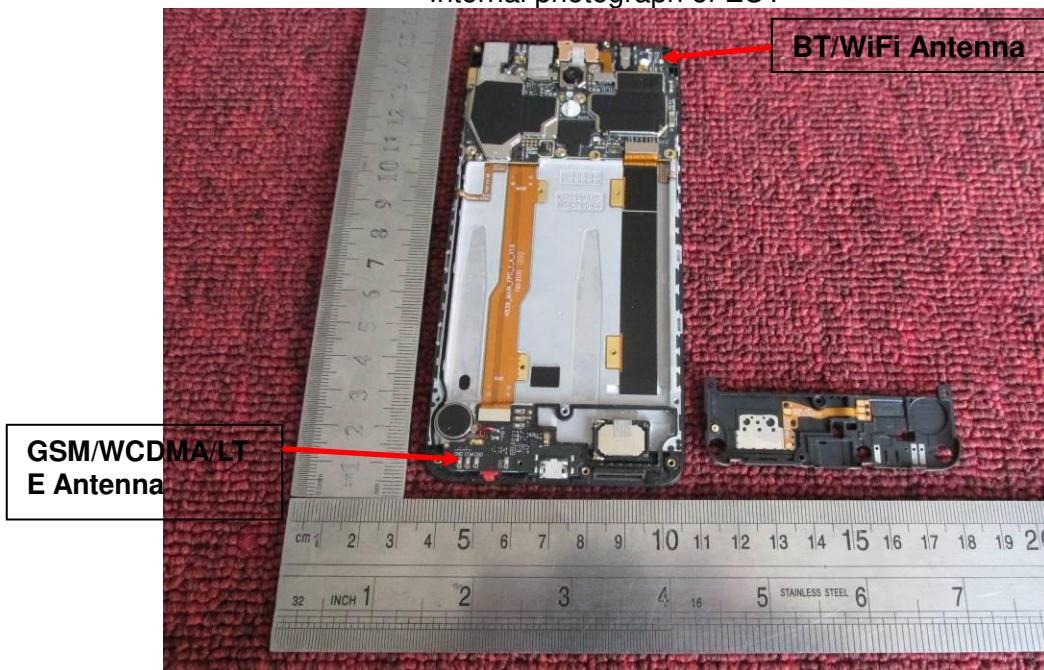

Internal photograph of EUT

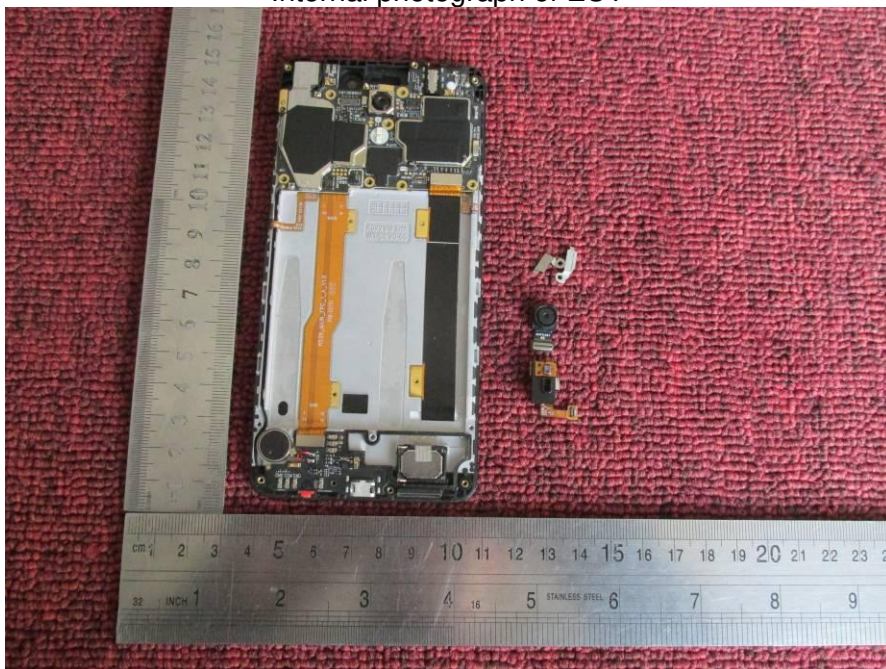

Internal photograph of EUT

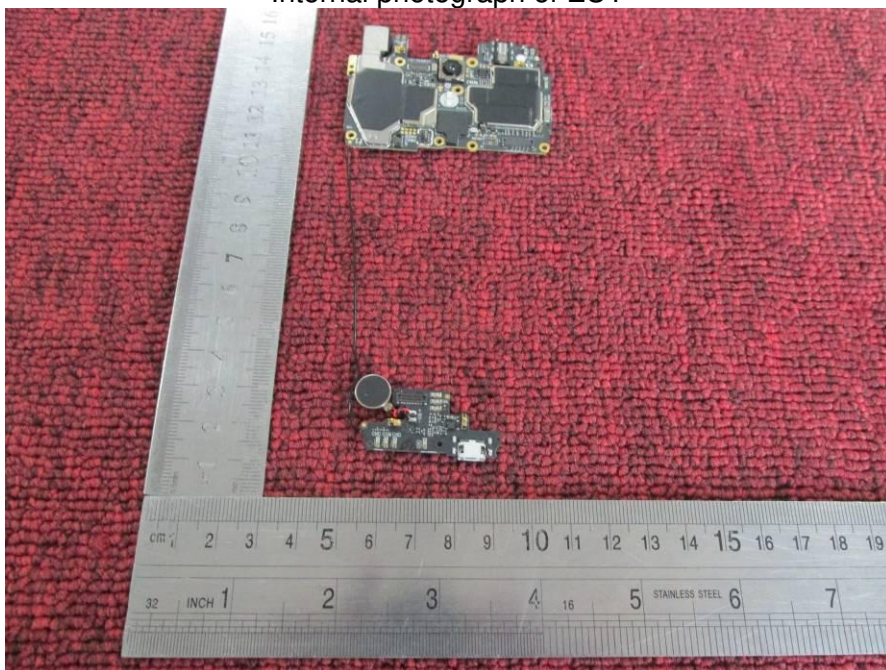

Internal photograph of EUT

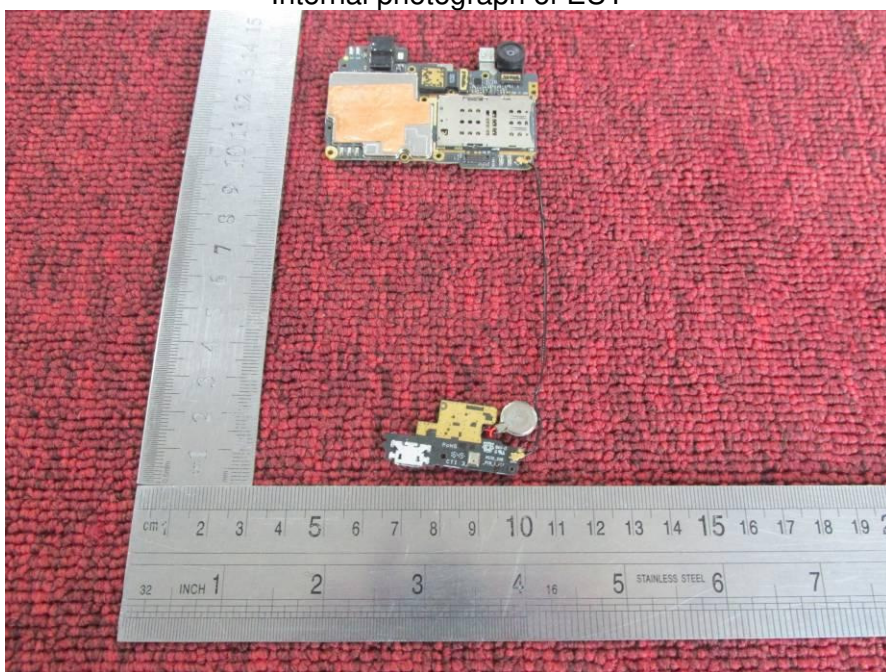

Internal photograph of EUT

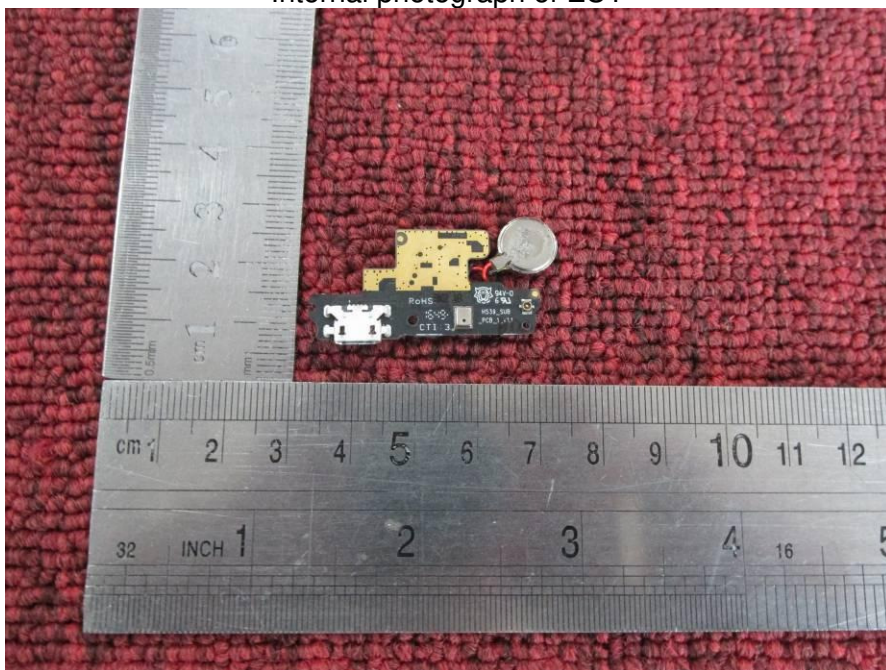

Internal photograph of EUT

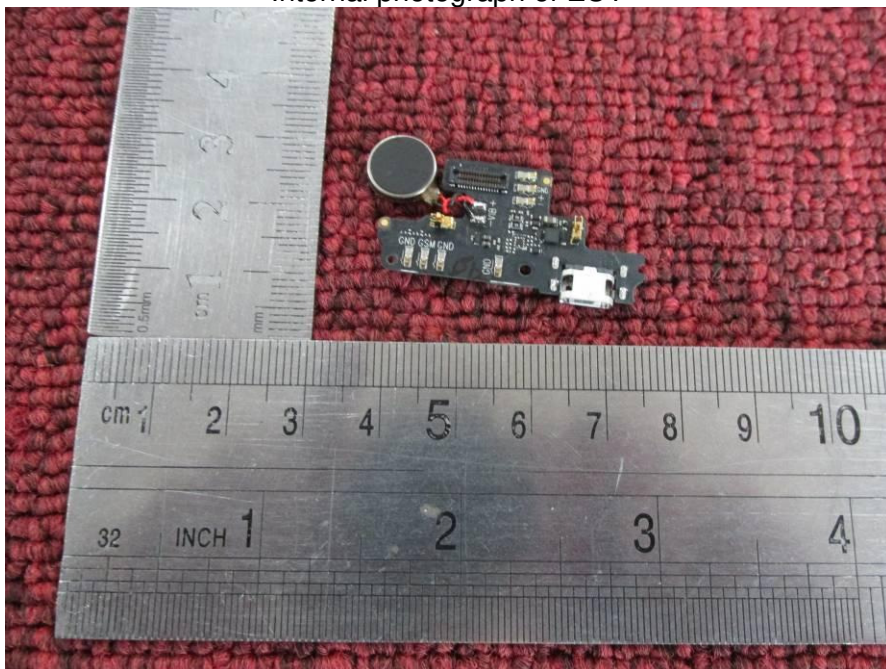

Internal photograph of EUT

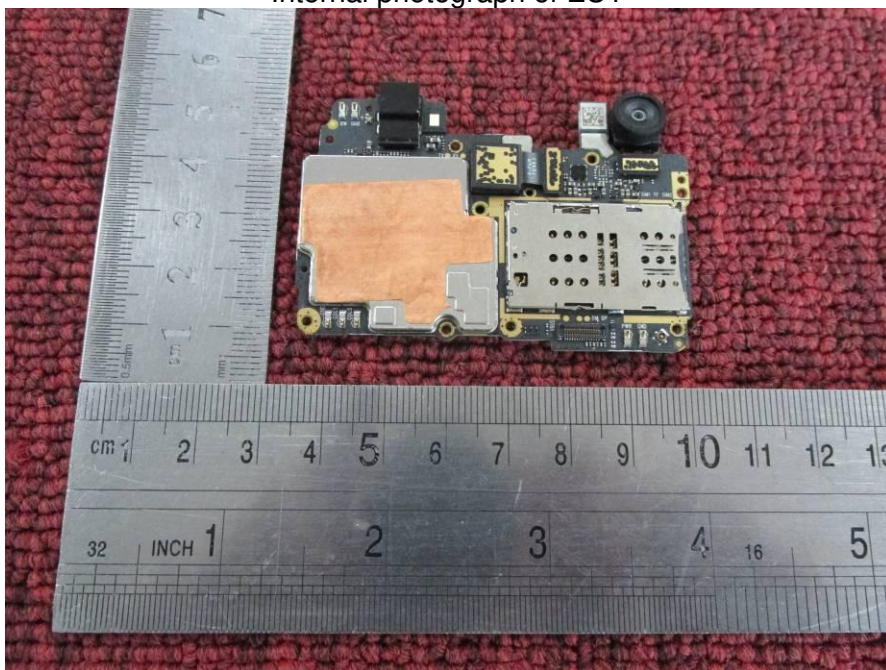

Internal photograph of EUT

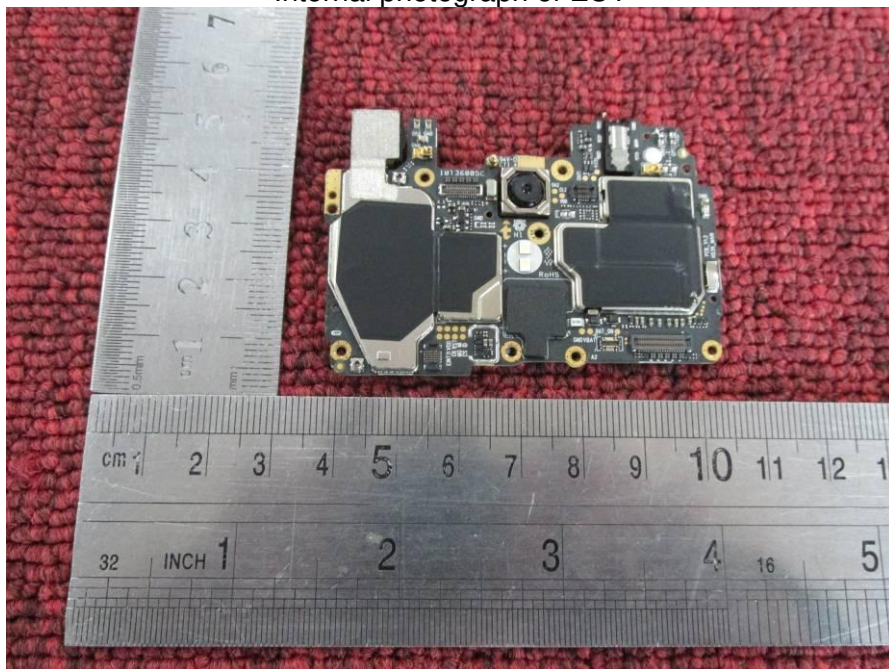

Internal photograph of EUT

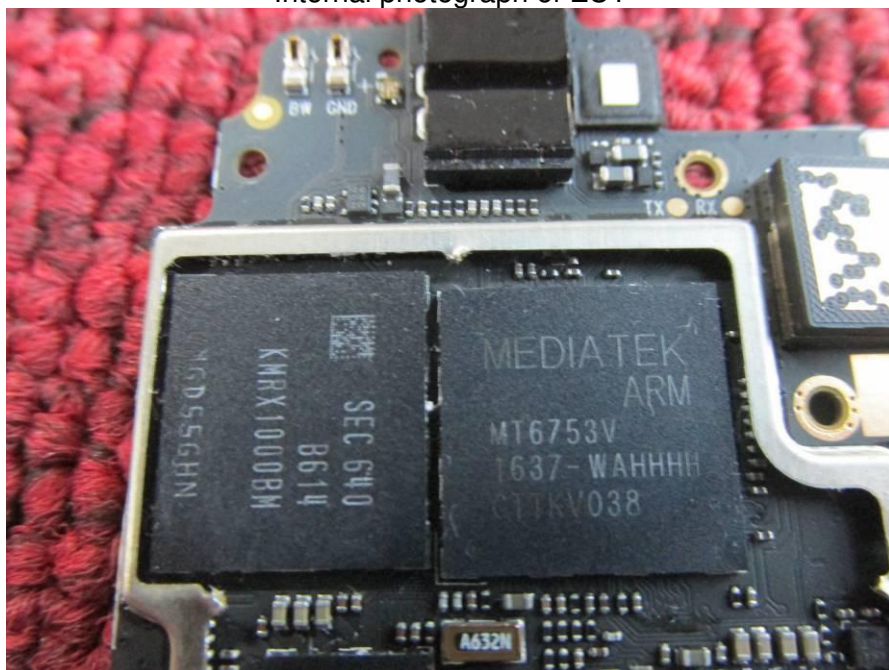

Internal photograph of EUT

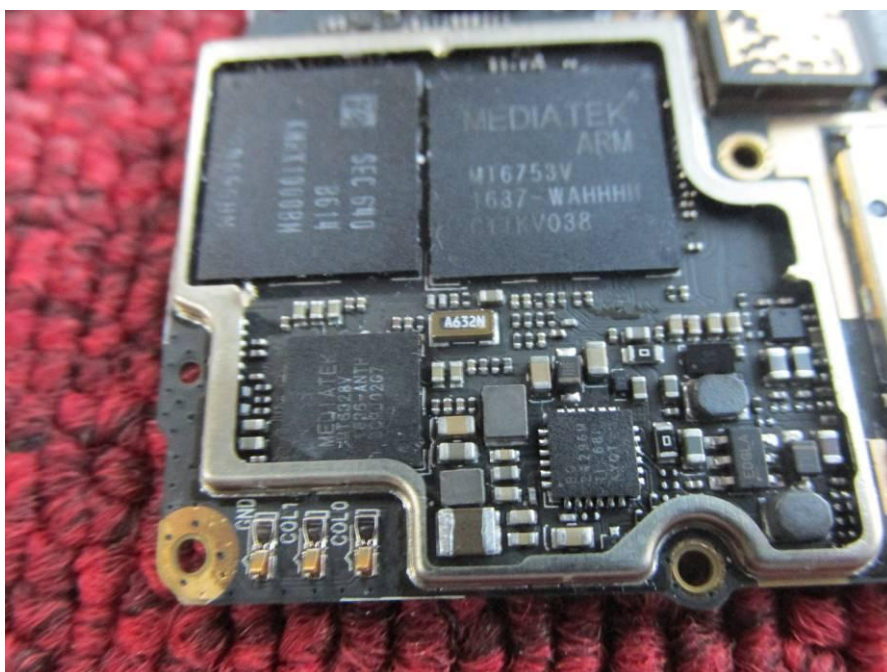

Internal photograph of EUT

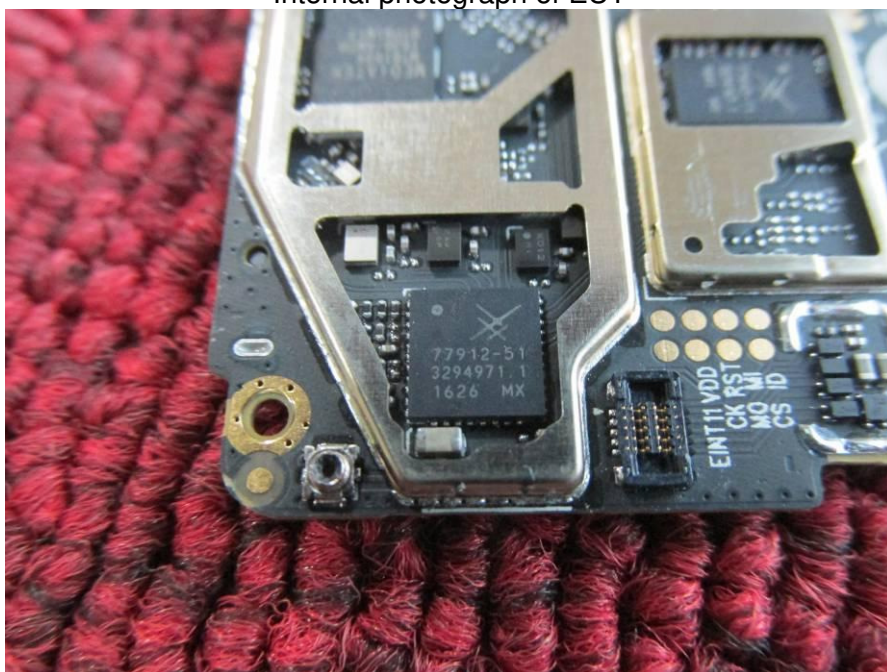

Internal photograph of EUT

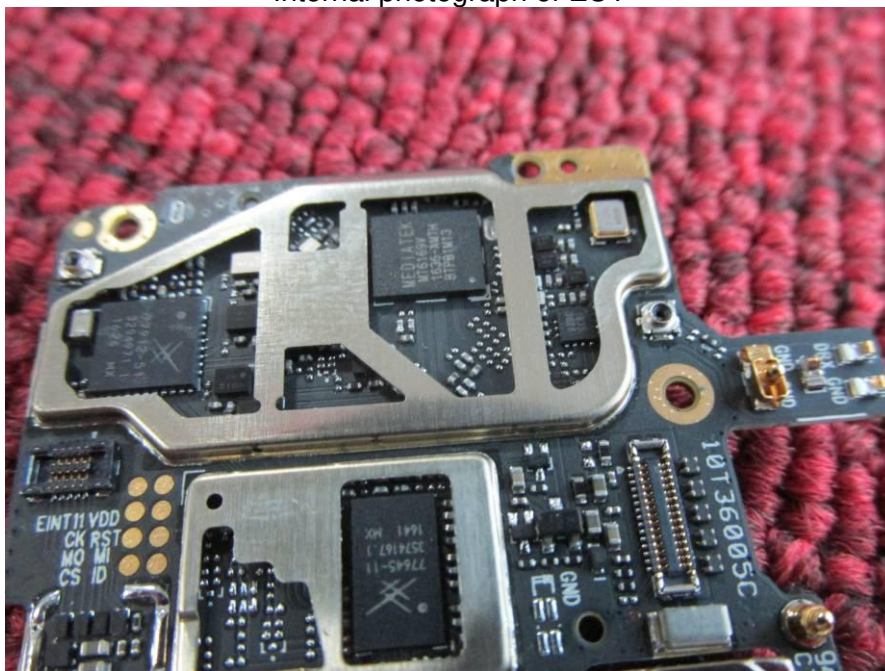

---END OF REPORT---