

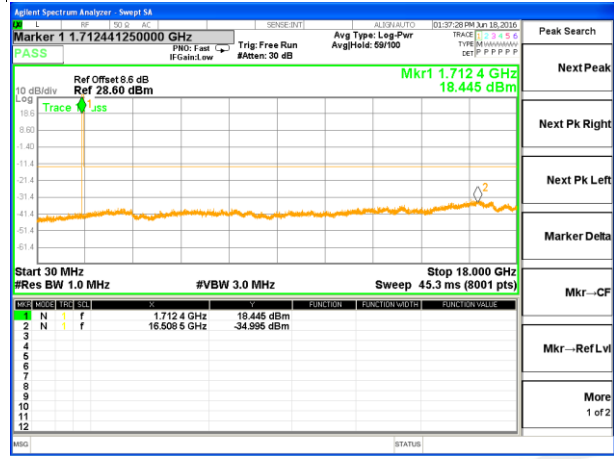

LTE BAND 4

LTE Band 4 / 3MHz /Emission

Lowest Channel / QPSK



Lowest Channel / 16QAM

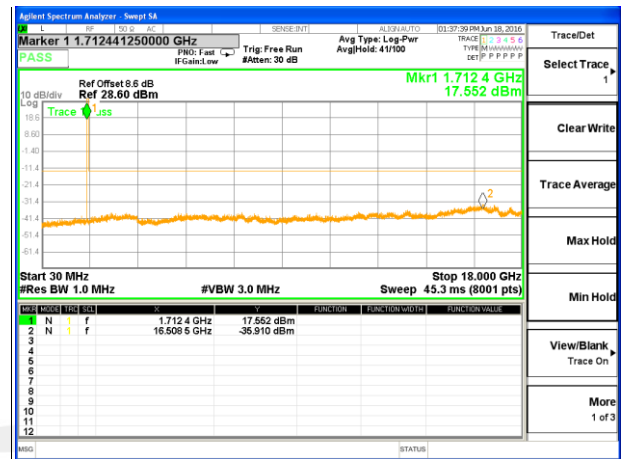

Middle Channel / QPSK

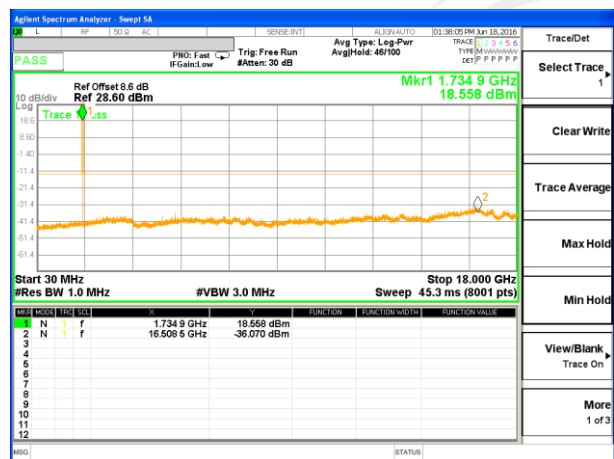

Middle Channel / 16QAM

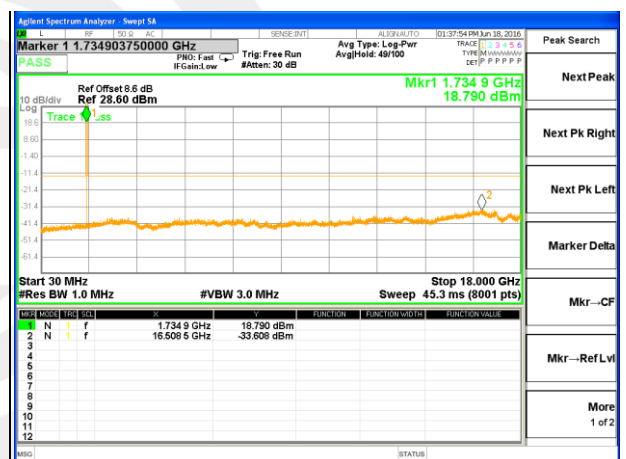

Highest Channel / QPSK

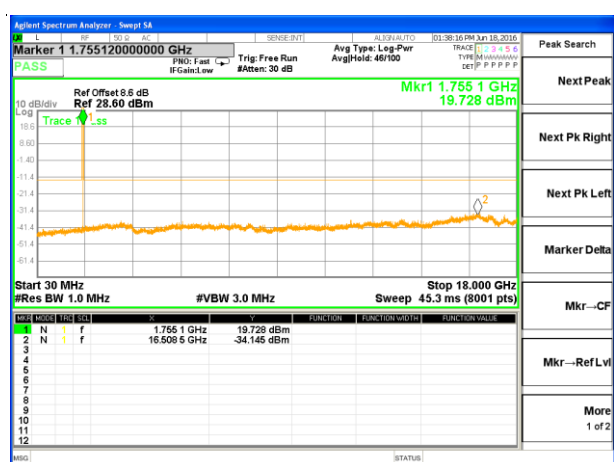

Highest Channel / 16QAM

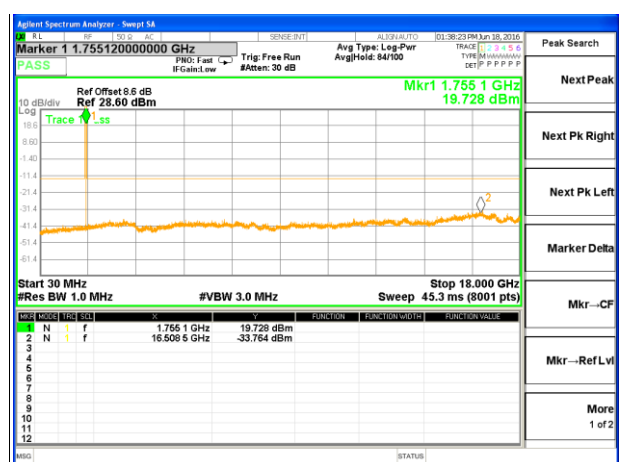



LTE BAND 4

LTE Band 4 / 5MHz /Emission

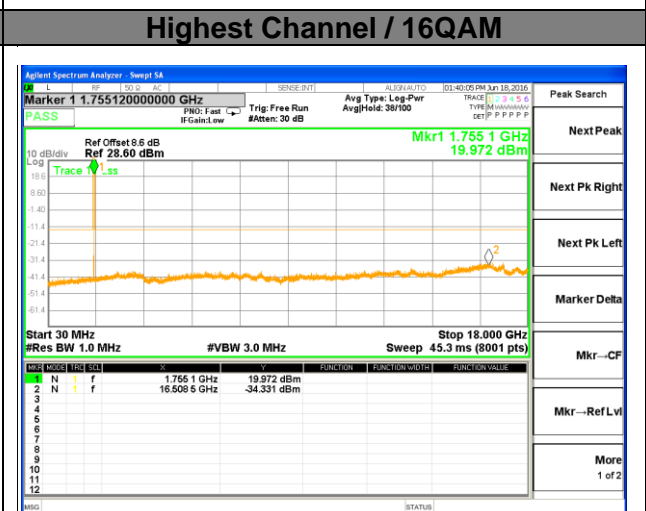
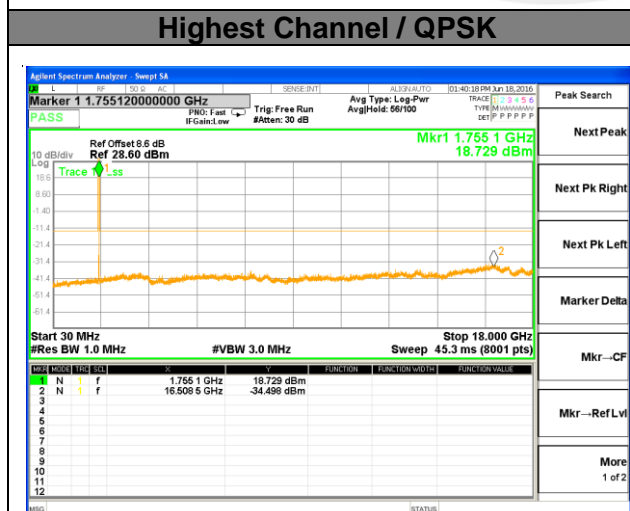
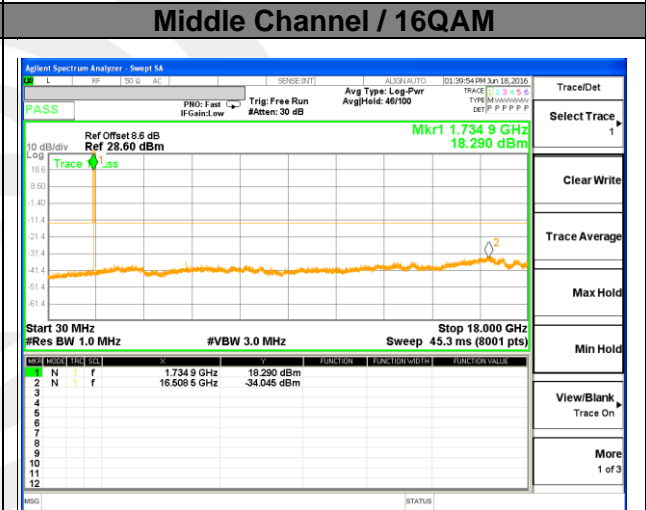
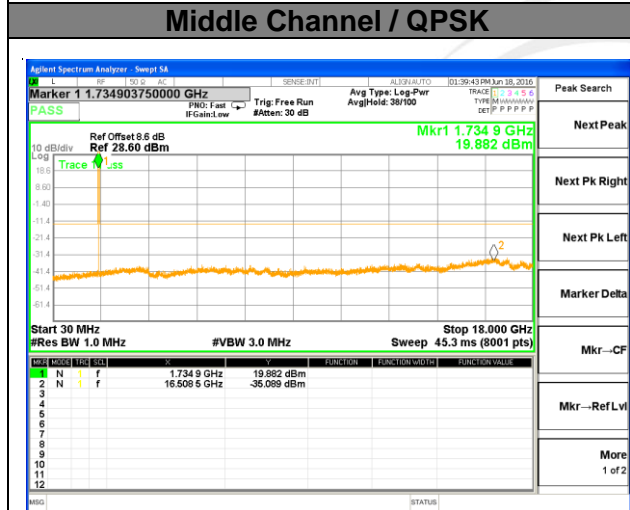
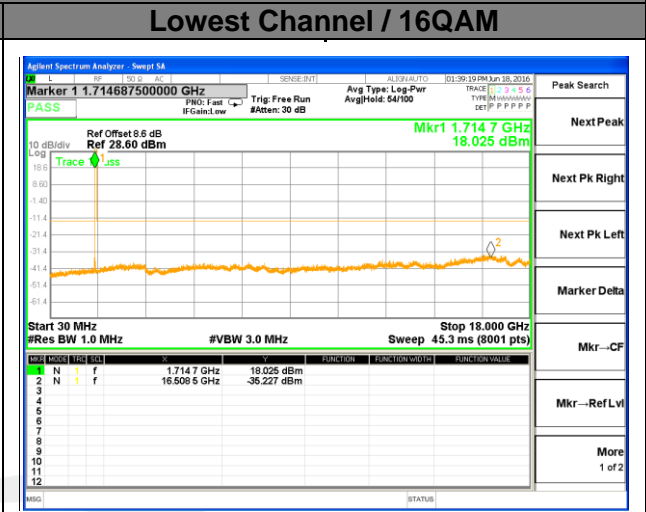
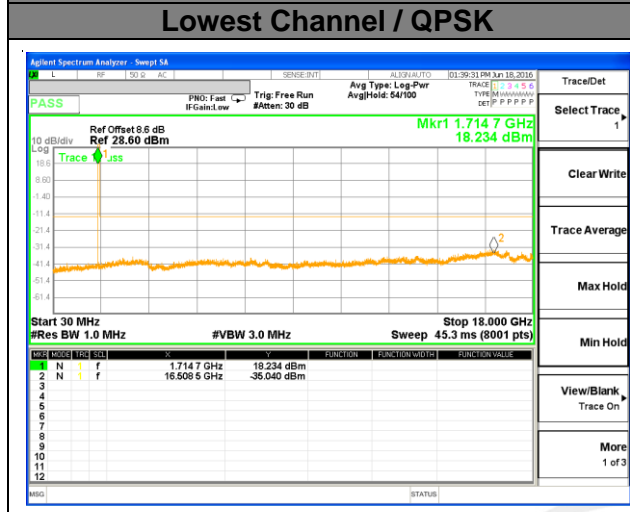



LTE BAND 4

LTE Band 4 / 10MHz /Emission

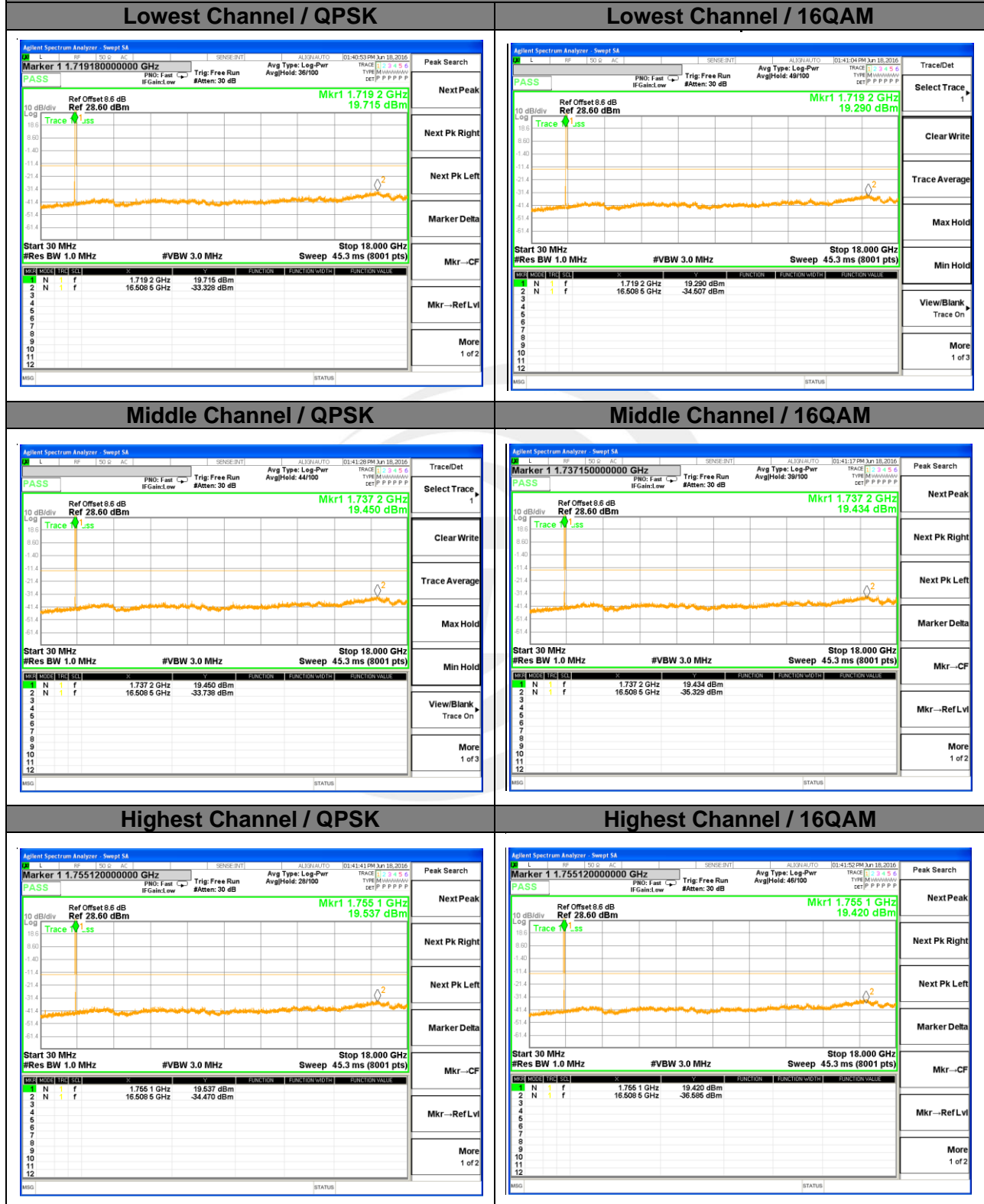



LTE BAND 4

LTE Band 4 / 15MHz /Emission

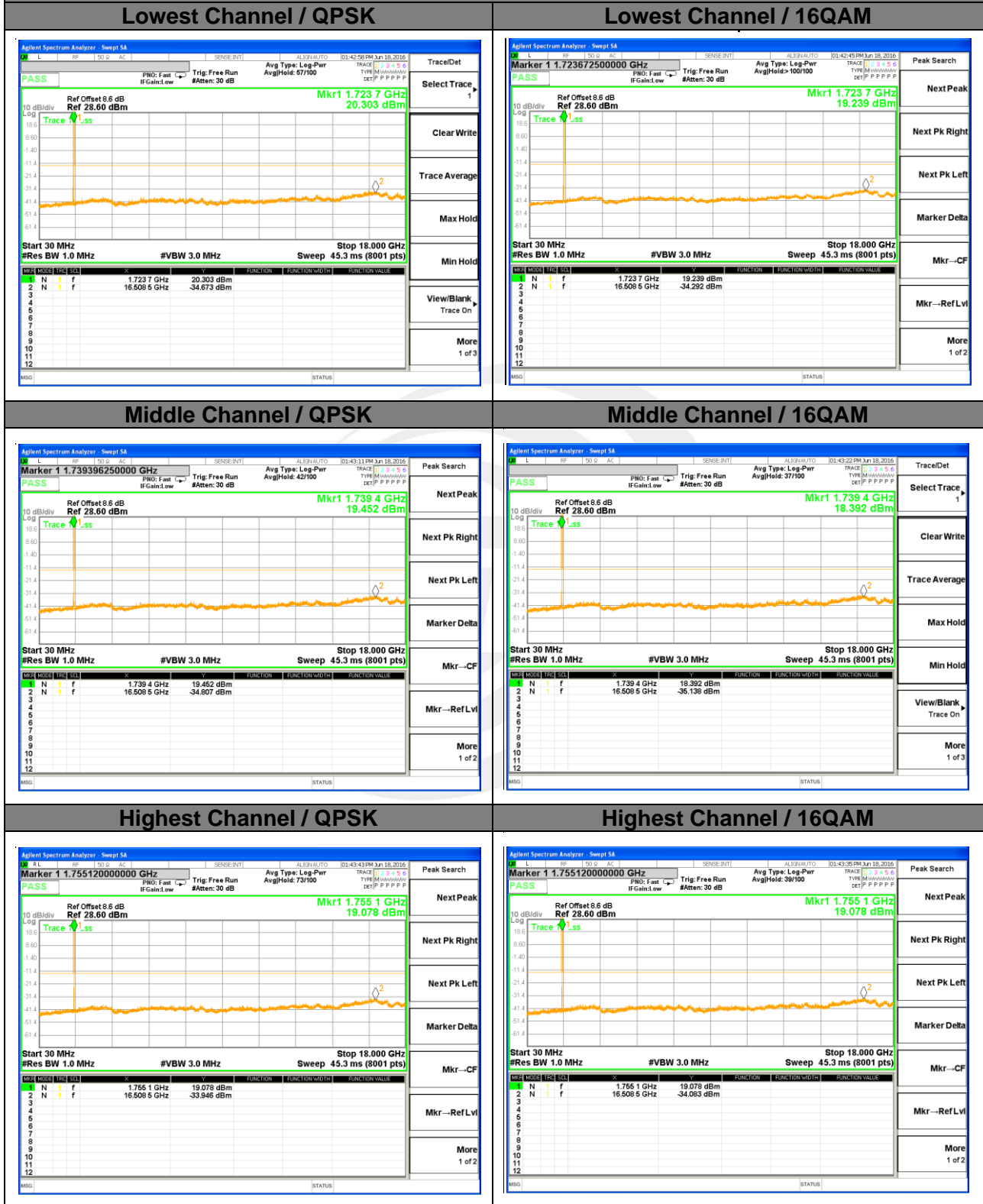



LTE BAND 4

LTE Band 4 / 20MHz /Emission

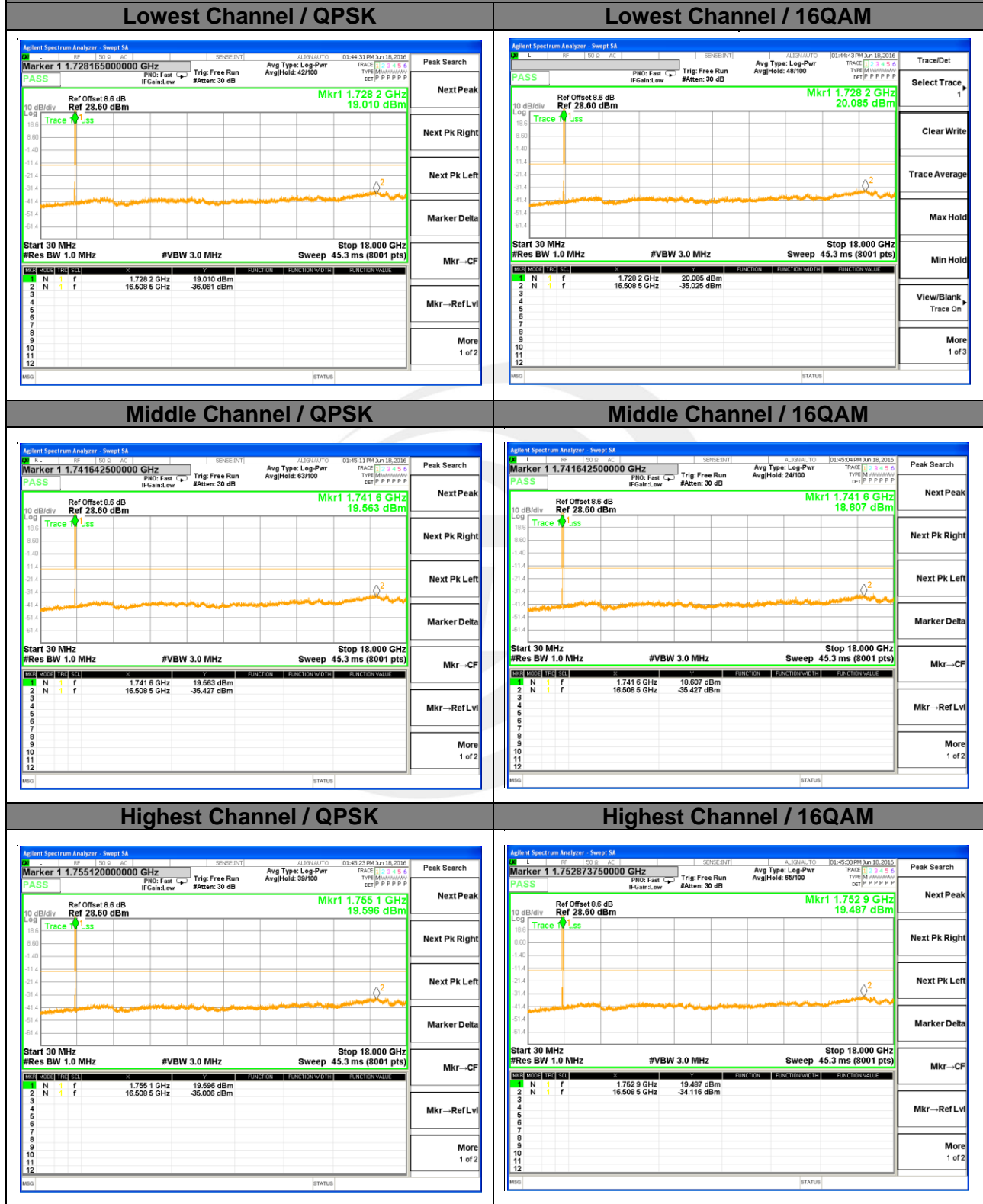



LTE BAND 17

LTE Band 17 / 5MHz /Emission

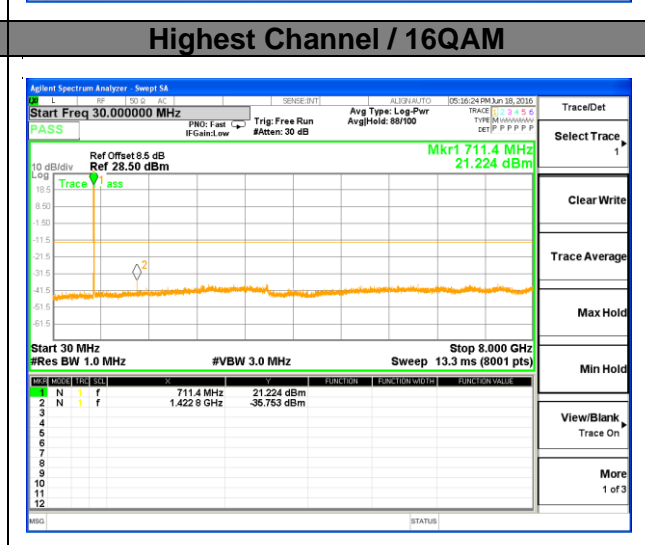
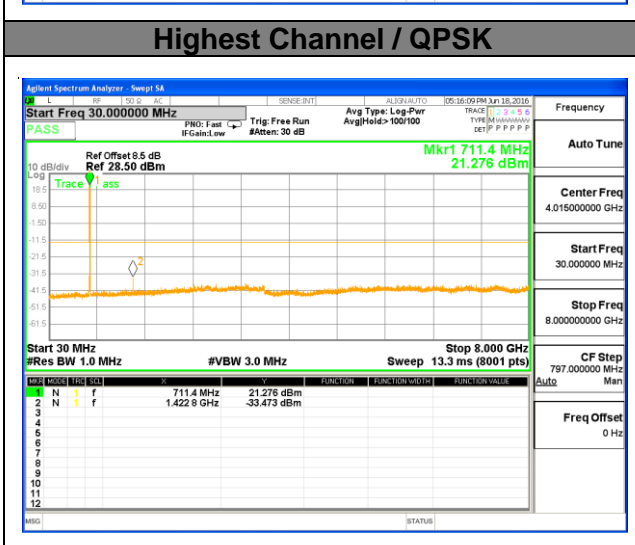
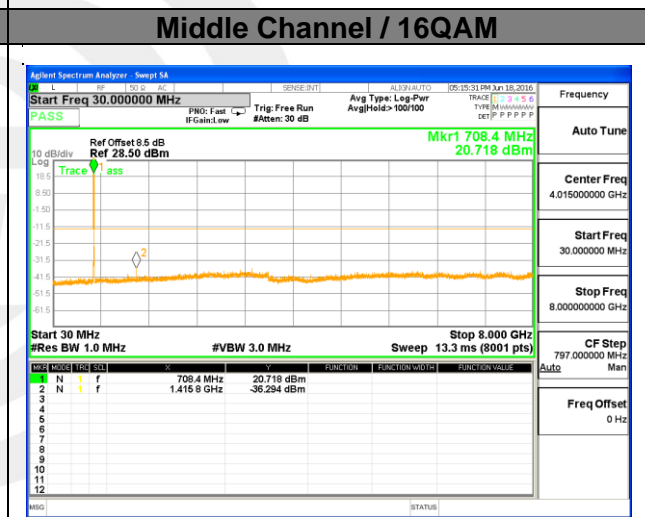
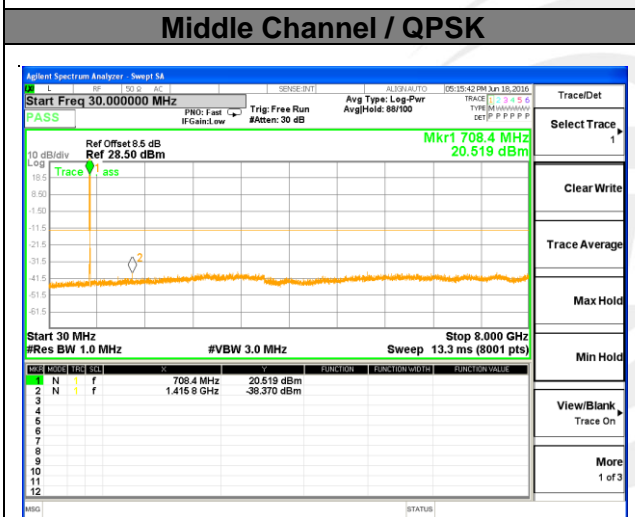
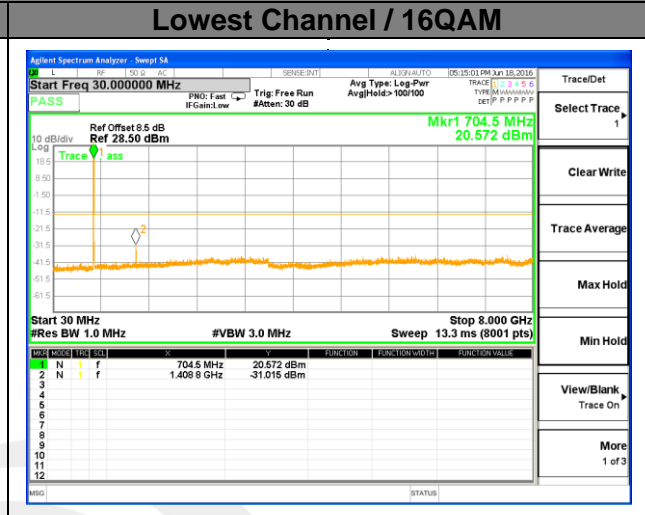
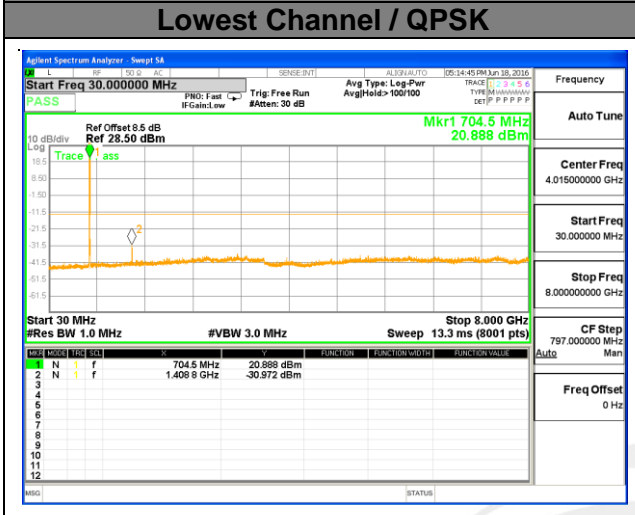



LTE BAND 17

LTE Band 17 / 10MHz /Emission

Lowest Channel / QPSK

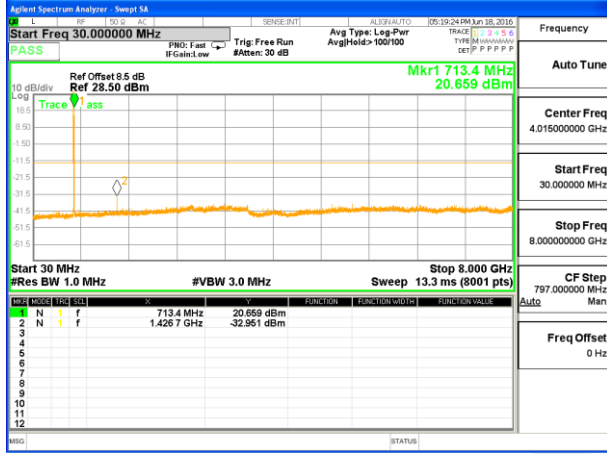

Lowest Channel / 16QAM

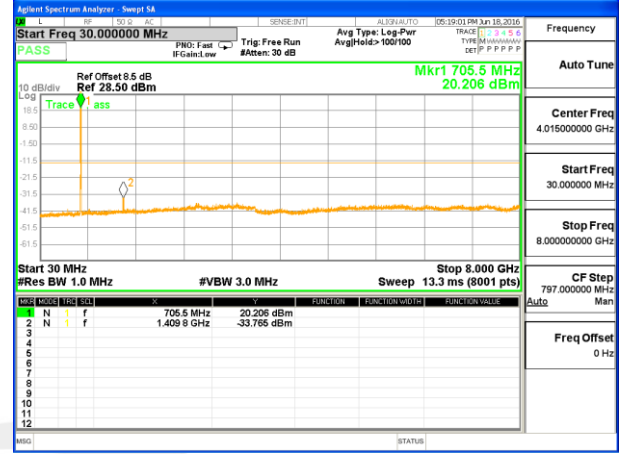

Middle Channel / QPSK

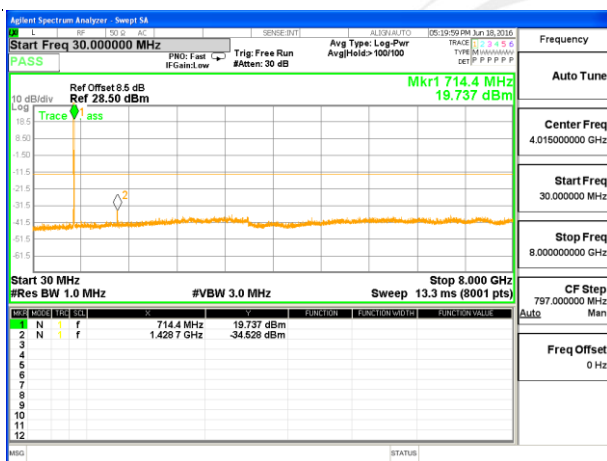

Middle Channel / 16QAM

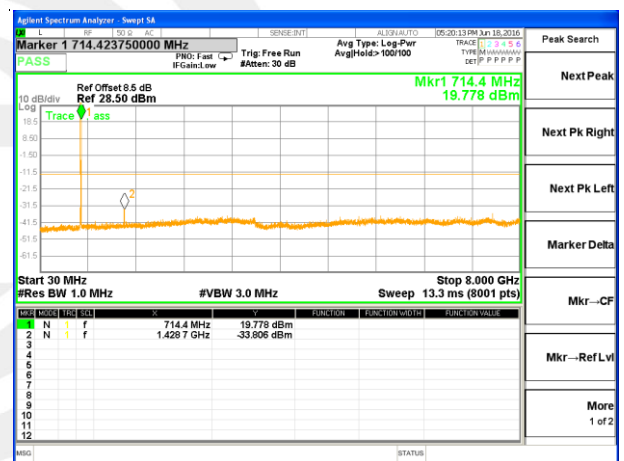

Highest Channel / QPSK

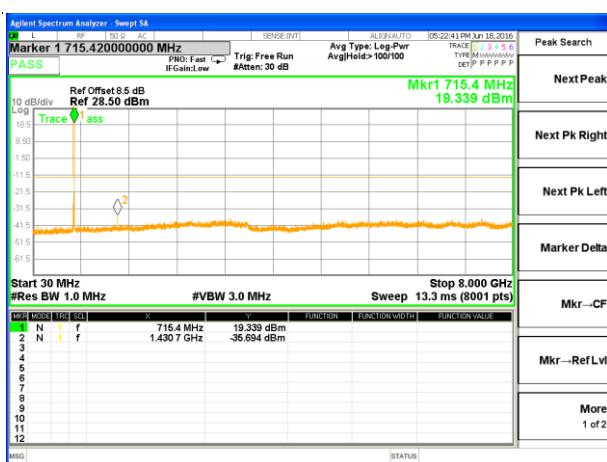

Highest Channel / 16QAM

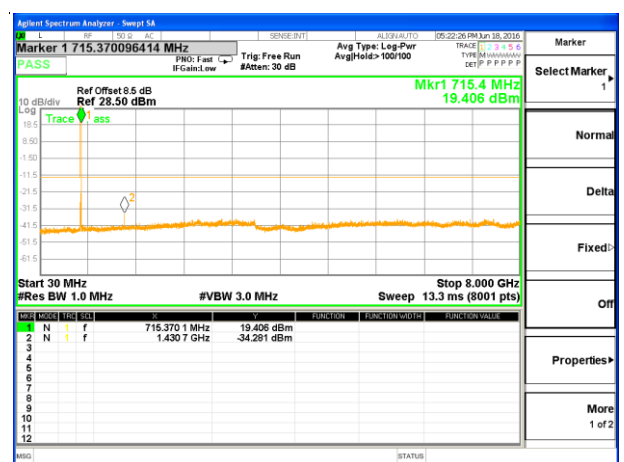

9. RADIATED SPURIOUS EMISSION

9.1 DESCRIPTION OF RADIATED SPURIOUS EMISSION

9.1.1 MEASUREMENT METHOD

The radiated spurious emission was measured by substitution method according to ANSI / TIA / EIA-603-C-2004. The power of any emission outside of the authorized operating frequency ranges must be attenuated below the transmitter power (P) by a factor of at least $43 + 10 \log (P)$ dB. For Band 7 The power of any emission outside of the authorized operating frequency ranges must be attenuated below the transmitter power (P) by a factor of at least $55 + 10 \log (P)$ dB. For Band. The spectrum is scanned from 30 MHz up to a frequency including its 10th harmonic.

5.1.2 Test Setup

The procedure of radiated spurious emissions is as follows:

a) Pre-calibration With pre-calibration method, the Radiated Spurious Emissions(RSE) is calculated as, $RSE = R_x (dBuV) + CL (dB) + SA (dB) + Gain (dBi) - 107 (dBuV \text{ to } dBm)$ The SA is calibrated using following setup.

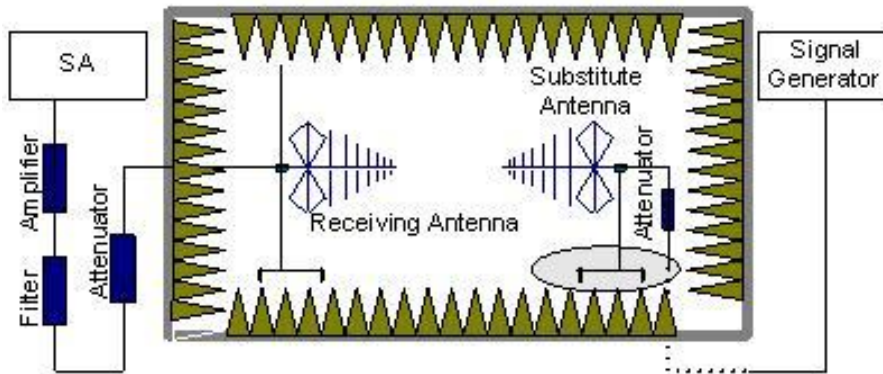

b) EUT was placed on a 0.8 meter high non-conductive stand at a 3 meter test distance from the receive antenna. A receiving antenna was placed on the antenna mast 3 meters from the test item for emission measurements. The height of receiving antenna is 0.8m. The test setup refers to figure below. Detected emissions were maximized at each frequency by rotating the test item and adjusting the receiving antenna polarization. The radiated emission measurements of all non-harmonic and harmonics of the transmit frequency through the 10th harmonic were measured with peak detector and 1MHz bandwidth.

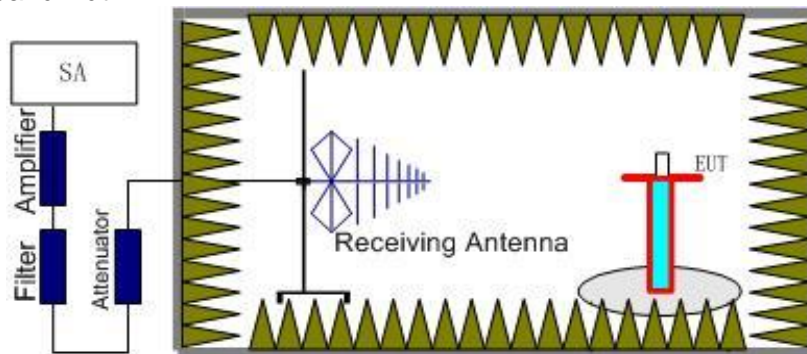

Radiated emissions measurements were made only at the upper, middle, and lower carrier frequencies It was decided that measurements at these three carrier frequencies would be sufficient to demonstrate compliance with emissions limits because it was seen that all the significant spurs occur well outside the band and no radiation was seen from a carrier in one block of any band into



any of the other blocks.

The substitution method is used. Substitution values at each frequency are measured before and saved to the test software. A "reference path loss" is established and the ARpl is the attenuation of "reference path loss", and including the gain of receive antenna, the gain of the preamplifier, the cable loss and the air loss. The measurement results are obtained as described below: Power=PMea+ARpl

9.1.3 TEST PROCEDURES

1. The testing follows FCC KDB 971168 v02r02 Section 5.8 and ANSI / TIA-603-C-2009 Section 2.2.12.
2. The EUT was placed on a rotatable wooden table with 0.8 meter above ground.
3. The EUT was set 3 meters from the receiving antenna, which was mounted on the antenna tower.
4. The table was rotated 360 degrees to determine the position of the highest spurious emission.
5. The height of the receiving antenna is varied between one meter and four meters to search the maximum spurious emission for both horizontal and vertical polarizations
6. Make the measurement with the spectrum analyzer's RBW = 1MHz, VBW = 3MHz, taking the record of maximum spurious emission.
7. A horn antenna was substituted in place of the EUT and was driven by a signal generator.
8. Tune the output power of signal generator to the same emission level with EUT maximum spurious emission.
9. Taking the record of output power at antenna port.
10. Repeat step 7 to step 8 for another polarization.
11. The RF fundamental frequency should be excluded against the limit line in the operating frequency band.

The limit line is derived from $43 + 10\log(P)$ dB below the transmitter power P(Watts)
= P(W)- [43 + 10log(P)] (dB)
= [30 + 10log(P)] (dBm) - [43 + 10log(P)] (dB)
= -13dBm

For Band 7:

The limit line is derived from $55 + 10\log(P)$ dB below the transmitter power P(Watts)
= [30 + 10log(P)] (dBm) - [55 + 10log(P)] (dB)
= -25dBm

EIRP (dBm) = S.G. Power – Tx Cable Loss + Tx Antenna Gain

ERP (dBm) = EIRP - 2.15



9.1.4 TEST RESULTS

LTE BAND 2

LTE Band 2 / 1.4MHz / QPSK / RB Size 1 Offset 0/ The Worst Test Results for Lowest						
Frequency(MHz)	Power(dBm)	A _{Rpl} (dBm)	P _{Mea} (dBm)	Limit (dBm)	Margin	Polarity
3700.398	-32.69	0.33	-32.36	-13	-19.36	Horizontal
5550.600	-34.14	4.01	-30.13	-13	-17.13	Horizontal
7400.811	-42.54	10.7	-31.84	-13	-18.84	Horizontal
3700.396	-34.93	0.33	-34.6	-13	-21.6	Vertical
5550.596	-34.57	4.01	-30.56	-13	-17.56	Vertical
7400.804	-42.43	10.7	-31.73	-13	-18.73	Vertical
LTE Band 2 / 1.4MHz / QPSK / RB Size 1 Offset 0/ The Worst Test Results for Middle						
Frequency(MHz)	Power(dBm)	A _{Rpl} (dBm)	P _{Mea} (dBm)	Limit (dBm)	Margin	Polarity
3764.104	-36.76	0.33	-36.43	-13	-23.43	Horizontal
5644.217	-32.71	4.01	-28.7	-13	-15.7	Horizontal
7524.195	-42.82	10.7	-32.12	-13	-19.12	Horizontal
3764.109	-31.47	0.33	-31.14	-13	-18.14	Vertical
5644.215	-36.64	4.01	-32.63	-13	-19.63	Vertical
7524.196	-37.34	10.7	-26.64	-13	-13.64	Vertical
LTE Band 2 / 1.4MHz / QPSK / RB Size 1 Offset 0/ The Worst Test Results for Highest						
Frequency(MHz)	Power(dBm)	A _{Rpl} (dBm)	P _{Mea} (dBm)	Limit (dBm)	Margin	Polarity
3820.605	-32.83	0.33	-32.5	-13	-19.5	Horizontal
5732.397	-35.84	4.01	-31.83	-13	-18.83	Horizontal
7640.203	-37.62	10.7	-26.92	-13	-13.92	Horizontal
3820.606	-32.92	0.33	-32.59	-13	-19.59	Vertical
5732.397	-41.62	4.01	-37.61	-13	-24.61	Vertical
7640.208	-38.43	10.7	-27.73	-13	-14.73	Vertical

Remark: Spurious emissions within 30-1000MHz were found more than 20dB below limit line..

Test is divided into three directions, X/Y/Z. X pattern for the worst.

**LTE BAND 2**

LTE Band 2 / 3MHz / QPSK / RB Size 1 Offset 0/ The Worst Test Results for Lowest						
Frequency(MHz)	Power(dBm)	A _{Rpl} (dBm)	P _{Mea} (dBm)	Limit (dBm)	Margin	Polarity
3704.390	-32.62	0.33	-32.29	-13	-19.29	Horizontal
5556.593	-34.46	4.01	-30.45	-13	-17.45	Horizontal
7404.808	-42.86	10.7	-32.16	-13	-19.16	Horizontal
3704.396	-34.62	0.33	-34.29	-13	-21.29	Vertical
5556.599	-34.51	4.01	-30.5	-13	-17.5	Vertical
7404.809	-42.67	10.7	-31.97	-13	-18.97	Vertical
LTE Band 2 / 3MHz / QPSK / RB Size 1 Offset 0/ The Worst Test Results for Middle						
Frequency(MHz)	Power(dBm)	A _{Rpl} (dBm)	P _{Mea} (dBm)	Limit (dBm)	Margin	Polarity
3760.103	-36.74	0.33	-36.41	-13	-23.41	Horizontal
5640.219	-32.31	4.01	-28.3	-13	-15.3	Horizontal
7520.197	-42.73	10.7	-32.03	-13	-19.03	Horizontal
3760.108	-31.46	0.33	-31.13	-13	-18.13	Vertical
5640.212	-36.92	4.01	-32.91	-13	-19.91	Vertical
7520.202	-37.94	10.7	-27.24	-13	-14.24	Vertical
LTE Band 2 / 3MHz / QPSK / RB Size 1 Offset 0/ The Worst Test Results for Highest						
Frequency(MHz)	Power(dBm)	A _{Rpl} (dBm)	P _{Mea} (dBm)	Limit (dBm)	Margin	Polarity
3820.604	-32.83	0.33	-32.5	-13	-19.5	Horizontal
5724.397	-35.76	4.01	-31.75	-13	-18.75	Horizontal
7632.199	-37.56	10.7	-26.86	-13	-13.86	Horizontal
3820.608	-32.31	0.33	-31.98	-13	-18.98	Vertical
5724.397	-41.23	4.01	-37.22	-13	-24.22	Vertical
7632.207	-38.16	10.7	-27.46	-13	-14.46	Vertical

Remark: Spurious emissions within 30-1000MHz were found more than 20dB below limit line.

Test is divided into three directions, X/Y/Z. X pattern for the worst.

**LTE BAND 2**

LTE Band 2 / 5MHz / QPSK / RB Size 1 Offset 0/ The Worst Test Results for Lowest						
Frequency(MHz)	Power(dBm)	ARpl (dBm)	P _{Mea} (dBm)	Limit (dBm)	Margin	Polarity
3704.394	-32.76	0.33	-32.43	-13	-19.43	Horizontal
5556.599	-34.43	4.01	-30.42	-13	-17.42	Horizontal
7404.806	-42.54	10.7	-31.84	-13	-18.84	Horizontal
3704.392	-34.82	0.33	-34.49	-13	-21.49	Vertical
5556.596	-34.67	4.01	-30.66	-13	-17.66	Vertical
7404.811	-42.72	10.7	-32.02	-13	-19.02	Vertical
LTE Band 2 / 5MHz / QPSK / RB Size 1 Offset 0/ The Worst Test Results for Middle						
Frequency(MHz)	Power(dBm)	ARpl (dBm)	P _{Mea} (dBm)	Limit (dBm)	Margin	Polarity
3760.111	-36.71	0.33	-36.38	-13	-23.38	Horizontal
5636.214	-32.56	4.01	-28.55	-13	-15.55	Horizontal
7516.196	-42.68	10.7	-31.98	-13	-18.98	Horizontal
3760.107	-31.81	0.33	-31.48	-13	-18.48	Vertical
5636.217	-36.84	4.01	-32.83	-13	-19.83	Vertical
7516.196	-37.95	10.7	-27.25	-13	-14.25	Vertical
LTE Band 2 / 5MHz / QPSK / RB Size 1 Offset 0/ The Worst Test Results for Highest						
Frequency(MHz)	Power(dBm)	ARpl (dBm)	P _{Mea} (dBm)	Limit (dBm)	Margin	Polarity
3816.603	-32.62	0.33	-32.29	-13	-19.29	Horizontal
5720.406	-35.59	4.01	-31.58	-13	-18.58	Horizontal
7624.201	-37.97	10.7	-27.27	-13	-14.27	Horizontal
3816.606	-32.44	0.33	-32.11	-13	-19.11	Vertical
5720.399	-41.07	4.01	-37.06	-13	-24.06	Vertical
7624.205	-38.16	10.7	-27.46	-13	-14.46	Vertical

Remark: Spurious emissions within 30-1000MHz were found more than 20dB below limit line.

Test is divided into three directions, X/Y/Z. X pattern for the worst.

**LTE BAND 2**

LTE Band 2 / 10MHz / QPSK / RB Size 1 Offset 0/ The Worst Test Results for Lowest						
Frequency(MHz)	Power(dBm)	A _{Rpl} (dBm)	P _{Mea} (dBm)	Limit (dBm)	Margin	Polarity
3704.391	-32.76	0.33	-32.43	-13	-19.43	Horizontal
5556.596	-34.57	4.01	-30.56	-13	-17.56	Horizontal
7408.809	-42.56	10.7	-31.86	-13	-18.86	Horizontal
3704.392	-34.89	0.33	-34.56	-13	-21.56	Vertical
5556.601	-34.43	4.01	-30.42	-13	-17.42	Vertical
7408.808	-42.32	10.7	-31.62	-13	-18.62	Vertical
LTE Band 2 / 10MHz / QPSK / RB Size 1 Offset 0/ The Worst Test Results for Middle						
Frequency(MHz)	Power(dBm)	A _{Rpl} (dBm)	P _{Mea} (dBm)	Limit (dBm)	Margin	Polarity
3756.102	-36.61	0.33	-36.28	-13	-23.28	Horizontal
5632.219	-32.52	4.01	-28.51	-13	-15.51	Horizontal
7512.197	-42.24	10.7	-31.54	-13	-18.54	Horizontal
3756.101	-31.69	0.33	-31.36	-13	-18.36	Vertical
5632.211	-36.01	4.01	-32	-13	-19	Vertical
7512.204	-37.67	10.7	-26.97	-13	-13.97	Vertical
LTE Band 2 / 10MHz / QPSK / RB Size 1 Offset 0/ The Worst Test Results for Highest						
Frequency(MHz)	Power(dBm)	A _{Rpl} (dBm)	P _{Mea} (dBm)	Limit (dBm)	Margin	Polarity
3804.611	-32.29	0.33	-31.96	-13	-18.96	Horizontal
5704.400	-35.33	4.01	-31.32	-13	-18.32	Horizontal
7608.201	-37.32	10.7	-26.62	-13	-13.62	Horizontal
3804.603	-32.64	0.33	-32.31	-13	-19.31	Vertical
5704.397	-41.42	4.01	-37.41	-13	-24.41	Vertical
7608.201	-38.18	10.7	-27.48	-13	-14.48	Vertical

Remark: Spurious emissions within 30-1000MHz were found more than 20dB below limit line.

Test is divided into three directions, X/Y/Z. X pattern for the worst.

**LTE BAND 2**

LTE Band 2 / 15MHz / QPSK / RB Size 1 Offset 0/ The Worst Test Results for Lowest						
Frequency(MHz)	Power(dBm)	A _{Rpl} (dBm)	P _{Mea} (dBm)	Limit (dBm)	Margin	Polarity
3704.395	-32.74	0.33	-32.41	-13	-19.41	Horizontal
5556.597	-34.52	4.01	-30.51	-13	-17.51	Horizontal
7408.811	-42.52	10.7	-31.82	-13	-18.82	Horizontal
3704.399	-34.43	0.33	-34.1	-13	-21.1	Vertical
5556.596	-67.93	4.01	-63.92	-13	-50.92	Vertical
7408.806	-33.26	10.7	-22.56	-13	-9.56	Vertical
LTE Band 2 / 15MHz / QPSK / RB Size 1 Offset 0/ The Worst Test Results for Middle						
Frequency(MHz)	Power(dBm)	A _{Rpl} (dBm)	P _{Mea} (dBm)	Limit (dBm)	Margin	Polarity
3752.109	-36.37	0.33	-36.04	-13	-23.04	Horizontal
5624.220	-32.17	4.01	-28.16	-13	-15.16	Horizontal
7496.195	-42.76	10.7	-32.06	-13	-19.06	Horizontal
3752.110	-31.85	0.33	-31.52	-13	-18.52	Vertical
5624.216	-36.64	4.01	-32.63	-13	-19.63	Vertical
7496.196	-37.56	10.7	-26.86	-13	-13.86	Vertical
LTE Band 2 / 15MHz / QPSK / RB Size 1 Offset 0/ The Worst Test Results for Highest						
Frequency(MHz)	Power(dBm)	A _{Rpl} (dBm)	P _{Mea} (dBm)	Limit (dBm)	Margin	Polarity
3796.605	-32.91	0.33	-32.58	-13	-19.58	Horizontal
5692.400	-35.83	4.01	-31.82	-13	-18.82	Horizontal
7588.201	-37.52	10.7	-26.82	-13	-13.82	Horizontal
3796.604	-32.75	0.33	-32.42	-13	-19.42	Vertical
5692.405	-41.56	4.01	-37.55	-13	-24.55	Vertical
7588.199	-38.67	10.7	-27.97	-13	-14.97	Vertical

Remark: Spurious emissions within 30-1000MHz were found more than 20dB below limit line.

Test is divided into three directions, X/Y/Z. X pattern for the worst.

**LTE BAND 2**

LTE Band 2 / 20MHz / QPSK / RB Size 1 Offset 0/ The Worst Test Results for Lowest						
Frequency(MHz)	Power(dBm)	A _{Rpl} (dBm)	P _{Mea} (dBm)	Limit (dBm)	Margin	Polarity
3708.396	-31.66	0.33	-31.33	-13	-18.33	Horizontal
5556.599	-36.43	4.01	-32.42	-13	-19.42	Horizontal
7408.804	-41.47	10.7	-30.77	-13	-17.77	Horizontal
3708.399	-35.57	0.33	-35.24	-13	-22.24	Vertical
5556.600	-34.23	4.01	-30.22	-13	-17.22	Vertical
7408.811	-42.21	10.7	-31.51	-13	-18.51	Vertical
LTE Band 2 / 20MHz / QPSK / RB Size 1 Offset 0/ The Worst Test Results for Middle						
Frequency(MHz)	Power(dBm)	A _{Rpl} (dBm)	P _{Mea} (dBm)	Limit (dBm)	Margin	Polarity
3748.106	-36.59	0.33	-36.26	-13	-23.26	Horizontal
5616.213	-32.61	4.01	-28.6	-13	-15.6	Horizontal
7488.196	-42.17	10.7	-31.47	-13	-18.47	Horizontal
3748.106	-31.57	0.33	-31.24	-13	-18.24	Vertical
5616.213	-36.27	4.01	-32.26	-13	-19.26	Vertical
7488.204	-37.34	10.7	-26.64	-13	-13.64	Vertical
LTE Band 2 / 20MHz / QPSK / RB Size 1 Offset 0/ The Worst Test Results for Highest						
Frequency(MHz)	Power(dBm)	A _{Rpl} (dBm)	P _{Mea} (dBm)	Limit (dBm)	Margin	Polarity
3788.613	-32.82	0.33	-32.49	-13	-19.49	Horizontal
5676.401	-35.74	4.01	-31.73	-13	-18.73	Horizontal
7568.207	-37.52	10.7	-26.82	-13	-13.82	Horizontal
3788.605	-32.51	0.33	-32.18	-13	-19.18	Vertical
5676.400	-41.82	4.01	-37.81	-13	-24.81	Vertical
7568.200	-38.75	10.7	-28.05	-13	-15.05	Vertical

Remark: Spurious emissions within 30-1000MHz were found more than 20dB below limit line.

Test is divided into three directions, X/Y/Z. X pattern for the worst.

**LTE BAND 4**

LTE Band 4 / 1.4MHz / QPSK / RB Size 1 Offset 0/ The Worst Test Results for Lowest						
Frequency(MHz)	Power(dBm)	ARpl (dBm)	P _{Mea} (dBm)	Limit (dBm)	Margin	Polarity
3420.392	-31.53	0.31	-31.22	-13	-18.22	Horizontal
5130.597	-33.92	3.98	-29.94	-13	-16.94	Horizontal
6843.804	-41.41	10.50	-30.91	-13	-17.91	Horizontal
3420.392	-35.56	0.30	-35.26	-13	-22.26	Vertical
5130.592	-34.64	3.98	-30.66	-13	-17.66	Vertical
6843.810	-42.69	10.50	-32.19	-13	-19.19	Vertical
LTE Band 4 / 1.4MHz / QPSK / RB Size 1 Offset 0/ The Worst Test Results for Middle						
Frequency(MHz)	Power(dBm)	ARpl (dBm)	P _{Mea} (dBm)	Limit (dBm)	Margin	Polarity
3462.104	-36.51	0.31	-36.2	-13	-23.2	Horizontal
5198.213	-32.53	3.98	-28.55	-13	-15.55	Horizontal
6927.198	-42.25	10.50	-31.75	-13	-18.75	Horizontal
3462.106	-31.69	0.30	-31.39	-13	-18.39	Vertical
5198.215	-36.74	3.98	-32.76	-13	-19.76	Vertical
6927.201	-37.67	10.50	-27.17	-13	-14.17	Vertical
LTE Band 4 / 1.4MHz / QPSK / RB Size 1 Offset 0/ The Worst Test Results for Highest						
Frequency(MHz)	Power(dBm)	ARpl (dBm)	P _{Mea} (dBm)	Limit (dBm)	Margin	Polarity
3511.403	-32.83	0.31	-32.52	-13	-19.52	Horizontal
5261.397	-35.87	3.98	-31.89	-13	-18.89	Horizontal
7018.204	-37.91	10.50	-27.41	-13	-14.41	Horizontal
3511.396	-32.86	0.30	-32.56	-13	-19.56	Vertical
5261.405	-41.27	3.98	-37.29	-13	-24.29	Vertical
7018.201	-38.29	10.50	-27.79	-13	-14.79	Vertical

Remark: Spurious emissions within 30-1000MHz were found more than 20dB below limit line.

Test is divided into three directions, X/Y/Z. X pattern for the worst.

**LTE BAND 4**

LTE Band 4 / 3MHz / QPSK / RB Size 1 Offset 0/ The Worst Test Results for Lowest						
Frequency(MHz)	Power(dBm)	ARpl (dBm)	PMea(dBm)	Limit (dBm)	Margin	Polarity
3420.397	-31.67	0.31	-31.36	-13	-18.36	Horizontal
5128.594	-33.85	3.98	-29.87	-13	-16.87	Horizontal
6843.803	-41.52	10.50	-31.02	-13	-18.02	Horizontal
3420.400	-35.84	0.30	-35.54	-13	-22.54	Vertical
5128.595	-34.56	3.98	-30.58	-13	-17.58	Vertical
6843.805	-42.41	10.50	-31.91	-13	-18.91	Vertical
LTE Band 4 / 3MHz / QPSK / RB Size 1 Offset 0/ The Worst Test Results for Middle						
Frequency(MHz)	Power(dBm)	ARpl (dBm)	PMea(dBm)	Limit (dBm)	Margin	Polarity
3462.105	-36.47	0.31	-36.16	-13	-23.16	Horizontal
5191.216	-32.72	3.98	-28.74	-13	-15.74	Horizontal
6927.200	-42.58	10.50	-32.08	-13	-19.08	Horizontal
3462.110	-31.52	0.30	-31.22	-13	-18.22	Vertical
5191.220	-36.87	3.98	-32.89	-13	-19.89	Vertical
6927.200	-37.69	10.50	-27.19	-13	-14.19	Vertical
LTE Band 4 / 3MHz / QPSK / RB Size 1 Offset 0/ The Worst Test Results for Highest						
Frequency(MHz)	Power(dBm)	ARpl (dBm)	PMea(dBm)	Limit (dBm)	Margin	Polarity
3504.611	-32.86	0.31	-32.55	-13	-19.55	Horizontal
5254.404	-35.97	3.98	-31.99	-13	-18.99	Horizontal
7011.207	-37.17	10.50	-26.67	-13	-13.67	Horizontal
3504.612	-32.35	0.30	-32.05	-13	-19.05	Vertical
5254.405	-41.24	3.98	-37.26	-13	-24.26	Vertical
7011.202	-38.23	10.50	-27.73	-13	-14.73	Vertical

Remark: Spurious emissions within 30-1000MHz were found more than 20dB below limit line.

Test is divided into three directions, X/Y/Z. X pattern for the worst.

**LTE BAND 4**

LTE Band 4 / 5MHz / QPSK / RB Size 1 Offset 0/ The Worst Test Results for Lowest						
Frequency(MHz)	Power(dBm)	A _{Rpl} (dBm)	P _{Mea} (dBm)	Limit (dBm)	Margin	Polarity
3420.392	-31.91	0.31	-31.6	-13	-18.6	Horizontal
5128.597	-33.97	3.98	-29.99	-13	-16.99	Horizontal
6843.809	-41.67	10.50	-31.17	-13	-18.17	Horizontal
3420.392	-35.37	0.30	-35.07	-13	-22.07	Vertical
5128.592	-34.57	3.98	-30.59	-13	-17.59	Vertical
6843.808	-42.19	10.50	-31.69	-13	-18.69	Vertical
LTE Band 4 / 5MHz / QPSK / RB Size 1 Offset 0/ The Worst Test Results for Middle						
Frequency(MHz)	Power(dBm)	A _{Rpl} (dBm)	P _{Mea} (dBm)	Limit (dBm)	Margin	Polarity
3464.105	-36.85	0.31	-36.54	-13	-23.54	Horizontal
5190.213	-32.56	3.98	-28.58	-13	-15.58	Horizontal
6928.201	-42.42	10.50	-31.92	-13	-18.92	Horizontal
3464.105	-31.95	0.30	-31.65	-13	-18.65	Vertical
5190.221	-36.52	3.98	-32.54	-13	-19.54	Vertical
6928.199	-37.67	10.50	-27.17	-13	-14.17	Vertical
LTE Band 4 / 5MHz / QPSK / RB Size 1 Offset 0/ The Worst Test Results for Highest						
Frequency(MHz)	Power(dBm)	A _{Rpl} (dBm)	P _{Mea} (dBm)	Limit (dBm)	Margin	Polarity
3462.608	-32.69	0.31	-32.38	-13	-19.38	Horizontal
5191.398	-35.63	3.98	-31.65	-13	-18.65	Horizontal
6920.207	-37.52	10.50	-27.02	-13	-14.02	Horizontal
3462.610	-32.44	0.30	-32.14	-13	-19.14	Vertical
5191.404	-41.83	3.98	-37.85	-13	-24.85	Vertical
6920.203	-38.74	10.50	-28.24	-13	-15.24	Vertical

Remark: Spurious emissions within 30-1000MHz were found more than 20dB below limit line.

Test is divided into three directions, X/Y/Z. X pattern for the worst.

**LTE BAND 4**

LTE Band 4 / 10MHz / QPSK / RB Size 1 Offset 0/ The Worst Test Results for Lowest						
Frequency(MHz)	Power(dBm)	A _{Rpl} (dBm)	P _{Mea} (dBm)	Limit (dBm)	Margin	Polarity
3420.399	-31.62	0.31	-31.31	-13	-18.31	Horizontal
5132.598	-33.54	3.98	-29.56	-13	-16.56	Horizontal
6843.809	-41.7	10.50	-31.2	-13	-18.2	Horizontal
3420.396	-35.94	0.30	-35.64	-13	-22.64	Vertical
5132.601	-34.59	3.98	-30.61	-13	-17.61	Vertical
6843.804	-42.37	10.50	-31.87	-13	-18.87	Vertical
LTE Band 4 / 10MHz / QPSK / RB Size 1 Offset 0/ The Worst Test Results for Middle						
Frequency(MHz)	Power(dBm)	A _{Rpl} (dBm)	P _{Mea} (dBm)	Limit (dBm)	Margin	Polarity
3455.109	-36.53	0.31	-36.22	-13	-23.22	Horizontal
5184.217	-32.42	3.98	-28.44	-13	-15.44	Horizontal
6928.196	-42.67	10.50	-32.17	-13	-19.17	Horizontal
3455.111	-31.56	0.30	-31.26	-13	-18.26	Vertical
5184.212	-36.37	3.98	-32.39	-13	-19.39	Vertical
6913.200	-37.43	10.50	-26.93	-13	-13.93	Vertical
LTE Band 4 / 10MHz / QPSK / RB Size 1 Offset 0/ The Worst Test Results for Highest						
Frequency(MHz)	Power(dBm)	A _{Rpl} (dBm)	P _{Mea} (dBm)	Limit (dBm)	Margin	Polarity
3490.606	-32.42	0.31	-32.11	-13	-19.11	Horizontal
5240.397	-35.36	3.98	-31.38	-13	-18.38	Horizontal
6983.204	-37.53	10.50	-27.03	-13	-14.03	Horizontal
3490.609	-32.56	0.30	-32.26	-13	-19.26	Vertical
5240.405	-41.44	3.98	-37.46	-13	-24.46	Vertical
6983.200	-38.36	10.50	-27.86	-13	-14.86	Vertical

Remark: Spurious emissions within 30-1000MHz were found more than 20dB below limit line.

Test is divided into three directions, X/Y/Z. X pattern for the worst.

**LTE BAND 4**

LTE Band 4 / 15MHz / QPSK / RB Size 1 Offset 0/ The Worst Test Results for Lowest						
Frequency(MHz)	Power(dBm)	ARpl (dBm)	P _{Mea} (dBm)	Limit (dBm)	Margin	Polarity
3420.393	-31.72	0.31	-31.41	-13	-18.41	Horizontal
5135.597	-33.68	3.98	-29.7	-13	-16.7	Horizontal
6843.806	-41.43	10.50	-30.93	-13	-17.93	Horizontal
3420.392	-35.74	0.30	-35.44	-13	-22.44	Vertical
5135.597	-34.67	3.98	-30.69	-13	-17.69	Vertical
6843.800	-42.85	10.50	-32.35	-13	-19.35	Vertical
LTE Band 4 / 15MHz / QPSK / RB Size 1 Offset 0/ The Worst Test Results for Middle						
Frequency(MHz)	Power(dBm)	ARpl (dBm)	P _{Mea} (dBm)	Limit (dBm)	Margin	Polarity
3455.106	-36.52	0.31	-36.21	-13	-23.21	Horizontal
5177.214	-32.84	3.98	-28.86	-13	-15.86	Horizontal
6906.200	-42.54	10.50	-32.04	-13	-19.04	Horizontal
3455.109	-31.75	0.30	-31.45	-13	-18.45	Vertical
5177.216	-36.67	3.98	-32.69	-13	-19.69	Vertical
6906.203	-37.65	10.50	-27.15	-13	-14.15	Vertical
LTE Band 4 / 15MHz / QPSK / RB Size 1 Offset 0/ The Worst Test Results for Highest						
Frequency(MHz)	Power(dBm)	ARpl (dBm)	P _{Mea} (dBm)	Limit (dBm)	Margin	Polarity
3483.607	-32.67	0.31	-32.36	-13	-19.36	Horizontal
5226.403	-35.62	3.98	-31.64	-13	-18.64	Horizontal
6962.199	-37.53	10.50	-27.03	-13	-14.03	Horizontal
3508.610	-32.74	0.30	-32.44	-13	-19.44	Vertical
5226.397	-41.42	3.98	-37.44	-13	-24.44	Vertical
6962.205	-38.51	10.50	-28.01	-13	-15.01	Vertical

Remark: Spurious emissions within 30-1000MHz were found more than 20dB below limit line.

Test is divided into three directions, X/Y/Z. X pattern for the worst.

**LTE BAND 4**

LTE Band 4 / 20MHz / QPSK / RB Size 1 Offset 0/ The Worst Test Results for Lowest						
Frequency(MHz)	Power(dBm)	A _{Rpl} (dBm)	P _{Mea} (dBm)	Limit (dBm)	Margin	Polarity
3420.391	-31.69	0.31	-31.38	-13	-18.38	Horizontal
5135.598	-33.72	3.98	-29.74	-13	-16.74	Horizontal
6843.810	-41.54	10.50	-31.04	-13	-18.04	Horizontal
3420.394	-35.52	0.30	-35.22	-13	-22.22	Vertical
5135.593	-34.54	3.98	-30.56	-13	-17.56	Vertical
6843.809	-42.83	10.50	-32.33	-13	-19.33	Vertical
LTE Band 4 / 20MHz / QPSK / RB Size 1 Offset 0/ The Worst Test Results for Middle						
Frequency(MHz)	Power(dBm)	A _{Rpl} (dBm)	P _{Mea} (dBm)	Limit (dBm)	Margin	Polarity
3448.101	-36.87	0.31	-36.56	-13	-23.56	Horizontal
5170.211	-32.65	3.98	-28.67	-13	-15.67	Horizontal
6892.203	-42.53	10.50	-32.03	-13	-19.03	Horizontal
3448.104	-31.57	0.30	-31.27	-13	-18.27	Vertical
5170.212	-36.44	3.98	-32.46	-13	-19.46	Vertical
6892.201	-37.22	10.50	-26.72	-13	-13.72	Vertical
LTE Band 4 / 20MHz / QPSK / RB Size 1 Offset 0/ The Worst Test Results for Highest						
Frequency(MHz)	Power(dBm)	A _{Rpl} (dBm)	P _{Mea} (dBm)	Limit (dBm)	Margin	Polarity
3476.612	-32.17	0.31	-31.86	-13	-18.86	Horizontal
5212.396	-35.75	3.98	-31.77	-13	-18.77	Horizontal
6948.207	-37.59	10.50	-27.09	-13	-14.09	Horizontal
3476.603	-32.45	0.30	-32.15	-13	-19.15	Vertical
5212.405	-41.67	3.98	-37.69	-13	-24.69	Vertical
6948.207	-38.19	10.50	-27.69	-13	-14.69	Vertical

Remark: Spurious emissions within 30-1000MHz were found more than 20dB below limit line.

Test is divided into three directions, X/Y/Z. X pattern for the worst.

**LTE BAND 17**

LTE Band 17 / 5MHz / QPSK / RB Size 1 Offset 0/ The Worst Test Results for Lowest						
Frequency(MHz)	Power(dBm)	A _{Rpl} (dBm)	P _{Mea} (dBm)	Limit (dBm)	Margin	Polarity
1408.400	-31.34	-4.88	-36.22	-13	-23.22	Horizontal
2112.596	-32.79	-2.58	-35.37	-13	-22.37	Horizontal
2816.806	-34.61	0.18	-34.43	-13	-21.43	Horizontal
1408.396	-32.65	-4.88	-37.53	-13	-24.53	Vertical
2112.601	-34.82	-2.58	-37.4	-13	-24.4	Vertical
2816.805	-34.53	0.18	-34.35	-13	-21.35	Vertical
LTE Band 17 / 5MHz / QPSK / RB Size 1 Offset 0/ The Worst Test Results for Middle						
Frequency(MHz)	Power(dBm)	A _{Rpl} (dBm)	P _{Mea} (dBm)	Limit (dBm)	Margin	Polarity
1416.610	-31.97	-4.88	-36.85	-13	-23.85	Horizontal
2122.402	-31.69	-2.58	-34.27	-13	-21.27	Horizontal
2830.206	-33.52	0.18	-33.34	-13	-20.34	Horizontal
1416.612	-32.67	-4.88	-37.55	-13	-24.55	Vertical
2122.403	-32.43	-2.58	-35.01	-13	-22.01	Vertical
2830.201	-33.84	0.18	-33.66	-13	-20.66	Vertical
LTE Band 17 / 5MHz / QPSK / RB Size 1 Offset 0/ The Worst Test Results for Highest						
Frequency(MHz)	Power(dBm)	A _{Rpl} (dBm)	P _{Mea} (dBm)	Limit (dBm)	Margin	Polarity
1422.608	-32.54	-4.88	-37.42	-13	-24.42	Horizontal
2136.401	-35.71	-2.58	-38.29	-13	-25.29	Horizontal
2848.207	-33.97	0.18	-33.79	-13	-20.79	Horizontal
1422.605	-32.65	-4.88	-37.53	-13	-24.53	Vertical
2136.399	-34.66	-2.58	-37.24	-13	-24.24	Vertical
2848.204	-33.47	0.18	-33.29	-13	-20.29	Vertical

Remark: Spurious emissions within 30-1000MHz were found more than 20dB below limit line.

Test is divided into three directions, X/Y/Z. X pattern for the worst.

**LTE BAND 17**

LTE Band 17 / 10MHz / QPSK / RB Size 1 Offset 0/ The Worst Test Results for Lowest						
Frequency(MHz)	Power(dBm)	A _{Rpl} (dBm)	P _{Mea} (dBm)	Limit (dBm)	Margin	Polarity
1408.393	-31.52	-4.88	-36.4	-13	-23.4	Horizontal
2112.597	-32.75	-2.58	-35.33	-13	-22.33	Horizontal
2816.810	-34.74	0.18	-34.56	-13	-21.56	Horizontal
1408.391	-32.43	-4.88	-37.31	-13	-24.31	Vertical
2112.601	-34.71	-2.58	-37.29	-13	-24.29	Vertical
2816.807	-34.95	0.18	-34.77	-13	-21.77	Vertical
LTE Band 17 / 10MHz / QPSK / RB Size 1 Offset 0/ The Worst Test Results for Middle						
Frequency(MHz)	Power(dBm)	A _{Rpl} (dBm)	P _{Mea} (dBm)	Limit (dBm)	Margin	Polarity
1408.608	-31.61	-4.88	-36.49	-13	-23.49	Horizontal
2120.399	-31.47	-2.58	-34.05	-13	-21.05	Horizontal
2820.208	-33.52	0.18	-33.34	-13	-20.34	Horizontal
1408.608	-32.86	-4.88	-37.74	-13	-24.74	Vertical
2120.397	-32.75	-2.58	-35.33	-13	-22.33	Vertical
2820.207	-33.19	0.18	-33.01	-13	-20.01	Vertical
LTE Band 17 / 10MHz / QPSK / RB Size 1 Offset 0/ The Worst Test Results for Highest						
Frequency(MHz)	Power(dBm)	A _{Rpl} (dBm)	P _{Mea} (dBm)	Limit (dBm)	Margin	Polarity
1416.606	-32.87	-4.88	-37.75	-13	-24.75	Horizontal
2118.398	-33.52	-2.58	-36.1	-13	-23.1	Horizontal
2824.202	-34.63	0.18	-34.45	-13	-21.45	Horizontal
1416.606	-34.12	-4.88	-39	-13	-26	Vertical
2118.402	-34.51	-2.58	-37.09	-13	-24.09	Vertical
2824.207	-33.75	0.18	-33.57	-13	-20.57	Vertical

Remark: Spurious emissions within 30-1000MHz were found more than 20dB below limit line.

Test is divided into three directions, X/Y/Z. X pattern for the worst.

10. FREQUENCY STABILITY

10.1 DESCRIPTION OF FREQUENCY STABILITY MEASUREMENT

10.1.1 MEASUREMENT METHOD

The frequency stability shall be measured by variation of ambient temperature and variation of primary supply voltage to ensure that the fundamental emission stays within the authorized frequency block. The frequency stability of the transmitter shall be maintained within $\pm 0.00025\%$ ($\pm 2.5\text{ppm}$) of the center frequency.

10.1.2 Test Setup

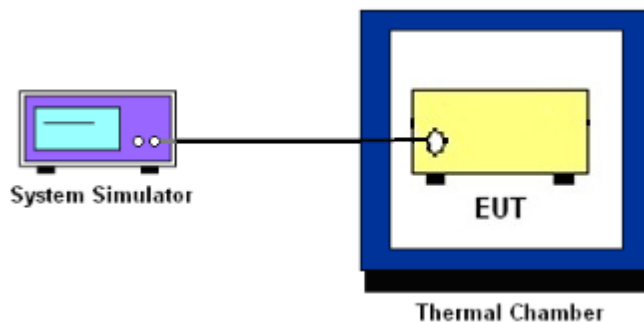

10.1.3 TEST PROCEDURES FOR TEMPERATURE VARIATION

1. The EUT was set up in the thermal chamber and connected with the system simulator.
2. With power OFF, the temperature was decreased to -30°C and the EUT was stabilized before testing. Power was applied and the maximum change in frequency was recorded within one minute.
3. With power OFF, the temperature was raised in 10°C step up to 50°C . The EUT was stabilized at each step for at least half an hour. Power was applied and the maximum frequency change was recorded within one minute.

10.1.4 TEST PROCEDURES FOR VOLTAGE VARIATION

1. The testing follows FCC KDB 971168 v02r02 Section 9.0.
2. The EUT was placed in a temperature chamber at $25\pm 5^{\circ}\text{C}$ and connected with the system simulator.
3. The power supply voltage to the EUT was varied from 85% to 115% of the nominal value measured at the input to the EUT.
4. The variation in frequency was measured for the worst case.



10.1.4 MEASUREMENT RESULT

LTE BAND 2

Test Conditions		LTE Band 2 (QPSK) / Middle Channel 1880MHz		Limit
Temperature (°C)	Voltage (Volt)	BW 10MHz		Note 2.
		Deviation (Hz)	Deviation (ppm)	Result
50°C	Normal Votage	23	0.012	PASS
30°C	Normal Votage	27	0.014	
20°C	Normal Votage	35	0.019	
10°C	Normal Votage	-27	-0.014	
0°C	Normal Votage	-21	-0.011	
-10°C	Normal Votage	29	0.015	
-20°C	Normal Votage	31	0.016	
-30°C	Normal Votage	39	0.021	
20°C	Maximum Votage	-32	-0.017	
20°C	Normal Votage	-27	-0.014	
20°C	Battery End Point	-29	-0.015	

Note:

1. Normal Voltage = 3.8V. ; Battery End Point (BEP) = 3.5 V. ; Maximum Voltage = 4.2 V
2. Note: The frequency fundamental emissions stay within the authorized frequency block based on the frequency deviation measured is small.



LTE BAND 4

Test Conditions		LTE Band 4 (QPSK) / Middle Channel 1732.5MHz		Limit
Temperature (°C)	Voltage (Volt)	BW 10MHz		Note 2.
		Deviation (Hz)	Deviation (ppm)	Result
50°C	Normal Votage	25	0.014	PASS
30°C	Normal Votage	37	0.021	
20°C	Normal Votage	21	0.012	
10°C	Normal Votage	-29	-0.017	
0°C	Normal Votage	-36	-0.021	
-10°C	Normal Votage	22	0.013	
-20°C	Normal Votage	18	0.010	
-30°C	Normal Votage	27	0.016	
20°C	Maximum Votage	-29	-0.017	
20°C	Normal Votage	-24	-0.014	
20°C	Battery End Point	29	0.017	

Note:

1. Normal Voltage = 3.8V. ; Battery End Point (BEP) = 3.5 V. ; Maximum Voltage = 4.2 V
2. Note: The frequency fundamental emissions stay within the authorized frequency block based on the frequency deviation measured is small.

**LTE BAND 17**

Test Conditions		LTE Band 17 (QPSK) / Middle Channel 707.5MHz		Limit
Temperature (°C)	Voltage (Volt)	BW 10MHz		Note 2.
		Deviation (Hz)	Deviation (ppm)	Result
50°C	Normal Votage	29	0.041	PASS
30°C	Normal Votage	-26	-0.037	
20°C	Normal Votage	33	0.047	
10°C	Normal Votage	-27	-0.038	
0°C	Normal Votage	-21	-0.030	
-10°C	Normal Votage	27	0.038	
-20°C	Normal Votage	35	0.049	
-30°C	Normal Votage	24	0.034	
20°C	Maximum Votage	-29	-0.041	
20°C	Normal Votage	-28	-0.040	
20°C	Battery End Point	-22	-0.031	

Note:

1. Normal Voltage = 3.8V. ; Battery End Point (BEP) = 3.5 V. ; Maximum Voltage = 4.2 V
2. Note: The frequency fundamental emissions stay within the authorized frequency block based on the frequency deviation measured is small.

PHOTOS OF TEST SETUP

RADIATED SPURIOUS EMISSION



※※※※END OF THE REPORT※※※※