

FCC RADIO TEST REPORT

FCC ID: 2AIY2-HIVE

Product: Bluetooth Speaker

Trade Name: origaudio

Model Name: Hive

Serial Model: N/A

Report No.: UNIA19062722FR-01

Prepared for

Fortyfour group LLC

16351 Gothard Ave, #B, Huntington Beach California 925 997 12 United States

Prepared by

Shenzhen United Testing Technology Co., Ltd.

2F, Annex Bldg, Jiahuangyuan Tech Park, #365 Baotian 1 Rd, Tiegang
Community, Xixiang Str, Bao'an District, Shenzhen, China

TEST RESULT CERTIFICATION

Applicant's name.....: Fortyfour group LLC
 Address.....: 16351 Gothard Ave, #B,Huntington Beach California 925
 997 12 United States
Manufacture's Name.....: Winnershine Technology Co.,Ltd
 Address.....: 5 Floor,D3 Bldg,8# Zaohekeng industrial
 park(YuXiang),JiXia,Bu Ji Town,Long Gang ,Shenzhen
 China 518114

Product description

Product name.....: Bluetooth Speaker
 Trade Mark.....: origaudio
 Model and/or type reference .: Hive
Standards.....: FCC Rules and Regulations Part 15 Subpart C Section 15.247
 ANSI C63.10: 2013

This device described above has been tested by Shenzhen United Testing Technology Co., Ltd., and the test results show that the equipment under test (EUT) is in compliance with the FCC requirements. And it is applicable only to the tested sample identified in the report.

This report shall not be reproduced except in full, without the written approval of UNI, this document may be altered or revised by Shenzhen United Testing Technology Co., Ltd., personnel only, and shall be noted in the revision of the document.

Date of Test.....:
 Date (s) of performance of tests.....: Jun. 25 ~ Jul. 01, 2019
 Date of Issue.....: Jul. 2, 2019
 Test Result.....: Pass

Prepared by:

Kahn Yang

Kahn yang/Editor

Reviewer:

Sherwin Qian

Sherwin Qian/Supervisor

Approved & Authorized Signer:

Liuze

Liuze/Manager

Table of Contents	Page
1. TEST SUMMARY.....	5
2. GENERAL INFORMATION.....	6
2.1 GENERAL DESCRIPTION OF EUT.....	6
2.2 Carrier Frequency of Channels.....	7
2.3 Operation of EUT during testing.....	7
2.4 DESCRIPTION OF TEST SETUP.....	7
2.5 MEASUREMENT INSTRUMENTS LIST.....	8
3. CONDUCTED EMISSIONS TEST.....	9
3.1 Conducted Power Line Emission Limit.....	9
3.2 Test Setup.....	9
3.3 Test Procedure.....	9
3.4 Test Result.....	9
4. RADIATED EMISSION TEST.....	12
4.1 Radiation Limit.....	12
4.2 Test Setup.....	12
4.3 Test Procedure.....	13
4.4 Test Result.....	13
5. BAND EDGE.....	20
5.1 Limits.....	20
5.2 Test Procedure.....	20
5.3 Test Result.....	20
6. OCCUPIED BANDWIDTH MEASUREMENT.....	23
6.1 Test Setup.....	23
6.2 Test Procedure.....	23
6.3 Measurement Equipment Used.....	23
6.4 Test Result.....	23
7. MAXIMUM PEAK OUTPUT POWER.....	28
7.1 Test Setup.....	28
7.2 Test Procedure.....	28
7.3 Limit.....	28
7.4 Test Result.....	28
8. FREQUENCY SEPARATION.....	29
8.1 Test Setup.....	29
8.2 Test Procedure.....	29

Table of Contents	Page
8.3 Limit.....	29
8.4 Test Result.....	29
9. CONDUCTED BANDEGE MEASUREMENT.....	34
9.1 Test Setup.....	34
9.2 Test Procedure.....	34
9.3 Limit.....	34
9.4 Test Result.....	34
10. SPURIOUS RF CONDUCTED EMISSION.....	38
10.1 Test Limit.....	38
10.2 Test Procedure.....	38
10.3 Test Setup.....	38
10.4 Test Result.....	38
11. NUMBER OF HOPPING FREQUENCY.....	43
11.1 Test Limit.....	43
11.2 Test Procedure.....	43
11.3 Test Setup.....	43
11.4 Test Result.....	43
12. TIME OF OCCUPANCY(DWELL TIME).....	45
12.1 Test Limit.....	45
12.2 Test Procedure.....	45
12.3 Test Setup.....	45
12.4 Test Result.....	45
13. PSEUDORANDOM FREQUENCY HPPPING SEQUENCE.....	50
For 47 CFR Part 15C section 15.247 (a)(1) requirement.....	50
14. ANTENNA REQUIREMENT.....	51
15. PHOTOGRAPH OF TEST.....	52

1. TEST SUMMARY

TEST PROCEDURES AND RESULTS

DESCRIPTION OF TEST	RESULT
CONDUCTED EMISSIONS TEST	COMPLIANT
RADIATED EMISSION TEST	COMPLIANT
BAND EDGE	COMPLIANT
OCCUPIED BANDWIDTH MEASUREMENT	COMPLIANT
MAXIMUM PEAK OUTPUT POWER	COMPLIANT
FREQUENCY SEPARATION	COMPLIANT
CONDUCTED BANDEGE MEASUREMENT	COMPLIANT
SPURIOUS RF CONDUCTED EMISSION	COMPLIANT
NUMBER OF HOPPING FREQUENCY	COMPLIANT
TIME OF OCCUPANCY(DWELL TIME)	COMPLIANT
ANTENNA REQUIREMENT	COMPLIANT

TEST FACILITY

Test Firm : Shenzhen United Testing Technology Co., Ltd.
 Address : 2F, Annex Bldg, Jiahuangyuan Tech Park, #365 Baotian 1 Rd, Tiegang
 Community, Xixiang Str, Bao'an District, Shenzhen, China

The testing quality ability of our laboratory meet with "Quality Law of People's Republic of China" Clause 19. The testing quality system of our laboratory meets with ISO/IEC-17025 requirements, which is approved by CNAS. This approval result is accepted by MRA of APLAC.

Our test facility is recognized, certified, or accredited by the following organizations:

CNAS-LAB Code: L6494

The EMC Laboratory has been assessed and in compliance with CNAS-CL01 accreditation criteria for testing Laboratories (identical to ISO/IEC 17025:2017 General Requirements) for the Competence of testing Laboratories.

Designation Number: CN1227

Test Firm Registration Number: 674885

The EMC Laboratory has been registered and fully described in a report filed with the (FCC) Federal Communications commission. The acceptance letter from the FCC is maintained in our files.

MEASUREMENT UNCERTAINTY

Measurement Uncertainty	
Conducted Emission Expanded Uncertainty	= 2.23dB, k=2
Radiated emission expanded uncertainty(9kHz-30MHz)	= 3.08dB, k=2
Radiated emission expanded uncertainty(30MHz-1000MHz)	= 4.42dB, k=2
Radiated emission expanded uncertainty(Above 1GHz)	= 4.06dB, k=2

2. GENERAL INFORMATION

2.1 GENERAL DESCRIPTION OF EUT

Equipment	Bluetooth Speaker
Trade Mark	origaudio
Model Name	Hive
Serial No.	N/A
Model Difference	N/A
FCC ID	2AIY2-HIVE
Antenna Type	PCB Antenna
Antenna Gain	1dBi
Frequency Range	2402-2480MHz
Number of Channels	79 channels for BR+EDR
Modulation Type	GFSK, Pi/4 QPSK, 8DPSK for BR+EDR
Power Source	Micro USB 5V or 3.7V from battery(2000mAh)

Table for auxiliary equipment:

Equipment Description	Manufacturer	Model	Calibration Due Date	Remark
Notebook	Lenovo	Lenovo G475	GB14477457	N/A
Adapter	BI	BI05-050100U	N/A	DC 5V/1A

2.2 Carrier Frequency of Channels

Channel List							
Channel	Frequency (MHz)	Channel	Frequency (MHz)	Channel	Frequency (MHz)	Channel	Frequency (MHz)
00	2402	21	2423	42	2444	63	2465
01	2403	22	2424	43	2445	64	2466
02	2404	23	2425	44	2446	65	2467
03	2405	24	2426	45	2447	66	2468
04	2406	25	2427	46	2448	67	2469
05	2407	26	2428	47	2449	68	2470
06	2408	27	2429	48	2450	69	2471
07	2409	28	2430	49	2451	70	2472
08	2410	29	2431	50	2452	71	2473
09	2411	30	2432	51	2453	72	2474
10	2412	31	2433	52	2454	73	2475
11	2413	32	2434	53	2455	74	2476
12	2414	33	2435	54	2456	75	2477
13	2415	34	2436	55	2457	76	2478
14	2416	35	2437	56	2458	77	2479
15	2417	36	2438	57	2459	78	2480
16	2418	37	2439	58	2460		
17	2419	38	2440	59	2461		
18	2420	39	2441	60	2462		
19	2421	40	2442	61	2463		
20	2422	41	2443	62	2464		

2.3 Operation of EUT during testing

Operating Mode

The mode is used: Transmitting mode

Low Channel: 2402MHz

Middle Channel: 2441MHz

High Channel: 2480MHz

Test SW Version: Blue MP Tool

2.4 DESCRIPTION OF TEST SETUP

Operation of EUT during Conducted testing:

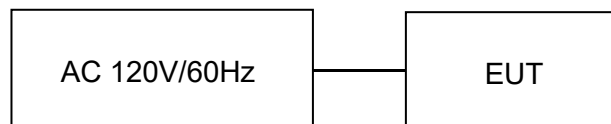

Operation of EUT during Radiation testing:

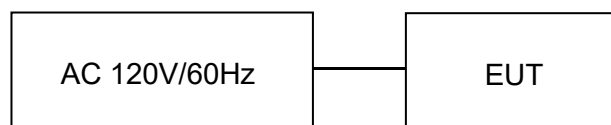

2.5 MEASUREMENT INSTRUMENTS LIST

Item	Equipment	Manufacturer	Model No.	Serial No.	Calibrated until
CONDUCTED EMISSIONS TEST					
1	AMN	Schwarzbeck	NNLK8121	8121370	2019.9.9
2	AMN	ETS	3810/2	00020199	2019.9.9
3	EMI TEST RECEIVER	Rohde&Schwarz	ESCI	101210	2019.9.9
4	AAN	TESEQ	T8-Cat6	38888	2019.9.9
RADIATED EMISSION TEST					
1	Horn Antenna	Sunol	DRH-118	A101415	2019.9.29
2	BicoNILog Antenna	Sunol	JB1 Antenna	A090215	2019.9.29
3	PREAMP	HP	8449B	3008A00160	2019.9.9
4	PREAMP	HP	8447D	2944A07999	2019.9.9
5	EMI TEST RECEIVER	Rohde&Schwarz	ESR3	101891	2019.9.9
6	VECTOR Signal Generator	Rohde&Schwarz	SMU200A	101521	2019.9.28
7	Signal Generator	Agilent	E4421B	MY4335105	2019.9.28
8	MXA Signal Analyzer	Agilent	N9020A	MY50510140	2019.9.28
9	MXA Signal Analyzer	Agilent	N9020A	MY51110104	2019.9.9
10	ANT Tower&Turn table Controller	Champro	EM 1000	60764	2019.9.28
11	Anechoic Chamber	Taihe Maorui	9m*6m*6m	966A0001	2019.9.9
12	Shielding Room	Taihe Maorui	6.4m*4m*3m	643A0001	2019.9.9
13	RF Power sensor	DARE	RPR3006W	15I00041SNO88	2020.3.14
14	RF Power sensor	DARE	RPR3006W	15I00041SNO89	2020.3.14
15	RF power divider	Anritsu	K241B	992289	2019.9.28
16	Wideband radio communication tester	Rohde&Schwarz	CMW500	154987	2019.9.28
17	Biconical antenna	Schwarzbeck	VHA 9103	91032360	2019.9.8
18	Biconical antenna	Schwarzbeck	VHA 9103	91032361	2019.9.8
19	Broadband Hybrid Antennas	Schwarzbeck	VULB9163	VULB9163#958	2019.9.8
20	Horn Antenna	Schwarzbeck	BBHA9120D	9120D-1680	2020.1.12
21	Active Receive Loop Antenna	Schwarzbeck	FMZB 1919B	00023	2019.11.02
22	Horn Antenna	Schwarzbeck	BBHA 9170	BBHA9170651	2020.03.14
23	Microwave Broadband PreBluetooth Speaker	Schwarzbeck	BBV 9721	100472	2019.10.24
24	Active Loop Antenna	Com-Power	AL-130R	10160009	2019.9.8
25	Power Meter	KEYSIGHT	N1911A	MY50520168	2019.9.8
26	Frequency Meter	VICTOR	VC2000	997406086	2019.9.8
27	DC Power Source	HYELEC	HY5020E	055161818	2019.9.8
Test software					
1	E3	Audix	6.101223a	N/A	N/A

3. CONDUCTED EMISSIONS TEST

3.1 Conducted Power Line Emission Limit

For unintentional device, according to § 15.107(a) Line Conducted Emission Limits is as following

Frequency (MHz)	Maximum RF Line Voltage(dB μ V)			
	CLASS A		CLASS B	
	Q.P.	Ave.	Q.P.	Ave.
0.15~0.50	79	66	66~56*	56~46*
0.50~5.00	73	60	56	46
5.00~30.0	73	60	60	50

* Decreasing linearly with the logarithm of the frequency

For intentional device, according to §15.207(a) Line Conducted Emission Limit is same as above table.

3.2 Test Setup

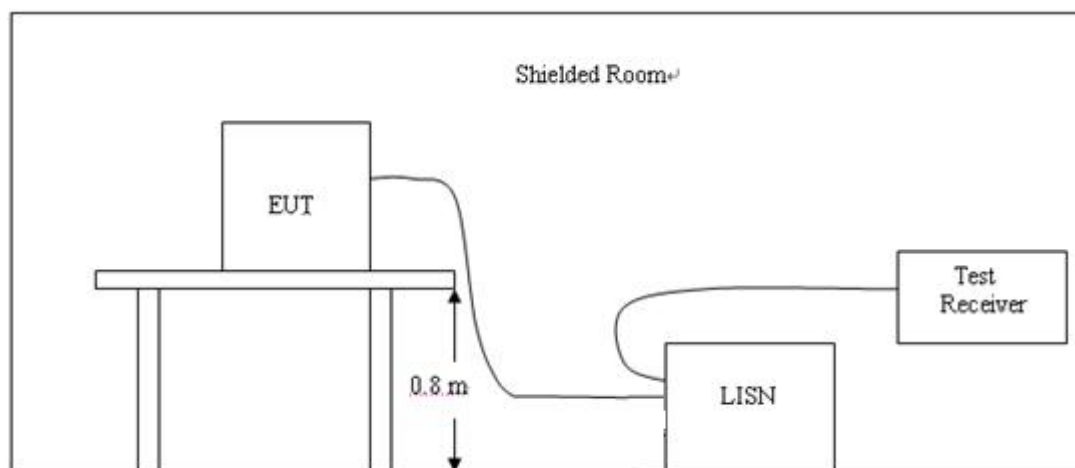

3.3 Test Procedure

- 1, The equipment was set up as per the test configuration to simulate typical actual usage per the user's manual. The EUT is a tabletop system, a wooden table with a height of 0.8 meters is used and is placed on the ground plane as per ANSI C63.10.
- 2, Support equipment, if needed, was placed as per ANSI C63.10.
- 3, All I/O cables were positioned to simulate typical actual usage as per ANSI C63.10.
- 4, If a EUT received DC power from the USB Port of Notebook PC, the PC's adapter received AC120V/60Hz power through a Line Impedance Stabilization Network (LISN) which supplied power source and was grounded to the ground plane.
- 5, All support equipments received AC power from a second LISN, if any.
- 6, The EUT test program was started. Emissions were measured on each current carrying line of the EUT using a spectrum Analyzer / Receiver connected to the LISN powering the EUT. The LISN has two monitoring points: Line 1 (Hot Side) and Line 2 (Neutral Side). Two scans were taken: one with Line 1 connected to Analyzer / Receiver and Line 2 connected to a 50 ohm load; the second scan had Line 1 connected to a 50 ohm load and Line 2 connected to the Analyzer / Receiver.
- 7, Analyzer / Receiver scanned from 150 KHz to 30MHz for emissions in each of the test modes.

3.4 Test Result

Pass

Remark:

1. All modes were tested at AC 120V and 240V, only the worst result of AC 120V was reported.
2. All modes of Low, Middle, and High channel were tested, only the worst result of High Channel was reported as below:

Temperature:	26°C	Relative Humidity:	48%
Test Date:	Jun. 27, 2019	Pressure:	1010hPa
Test Voltage:	AC 120V, 60Hz	Phase:	Line
Test Mode:	Transmitting mode of GFSK 2480MHz		

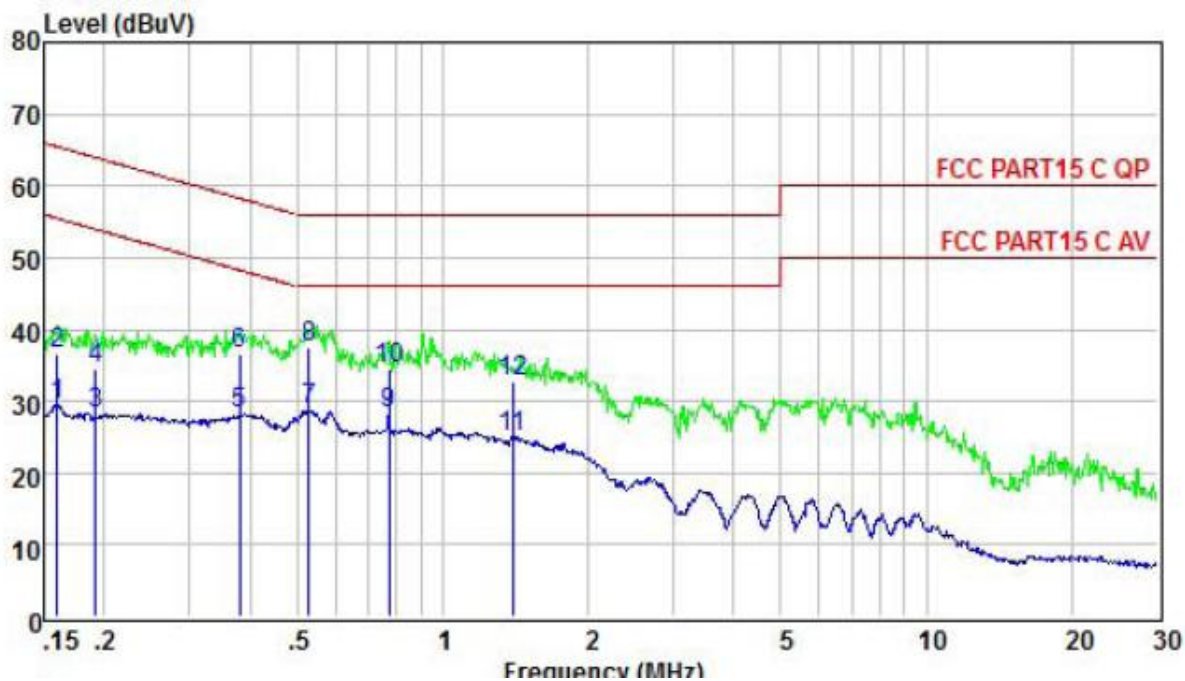

	Freq	Level	Limit	Over	Remark
	MHz	dBuV	dBuV	dB	
1	0.160	29.59	55.47	-25.88	Average
2	0.160	36.69	65.47	-28.78	QP
3	0.191	28.26	53.98	-25.72	Average
4	0.191	34.59	63.98	-29.39	QP
5	0.381	28.34	48.25	-19.91	Average
6	0.381	36.69	58.25	-21.56	QP
7	0.529	28.70	46.00	-17.30	Average
8	0.529	37.58	56.00	-18.42	QP
9	0.775	28.20	46.00	-17.80	Average
10	0.775	34.59	56.00	-21.41	QP
11	1.396	25.03	46.00	-20.97	Average
12	1.396	32.68	56.00	-23.32	QP

Remark: Factor = Insertion Loss + Cable Loss, Result = Reading + Factor, Margin = Result – Limit.

Temperature:	26°C	Relative Humidity:	48%
Test Date:	Jun. 27, 2019	Pressure:	1010hPa
Test Voltage:	AC 120V, 60Hz	Phase:	Neutral
Test Mode:	Transmitting mode of GFSK 2480MHz		

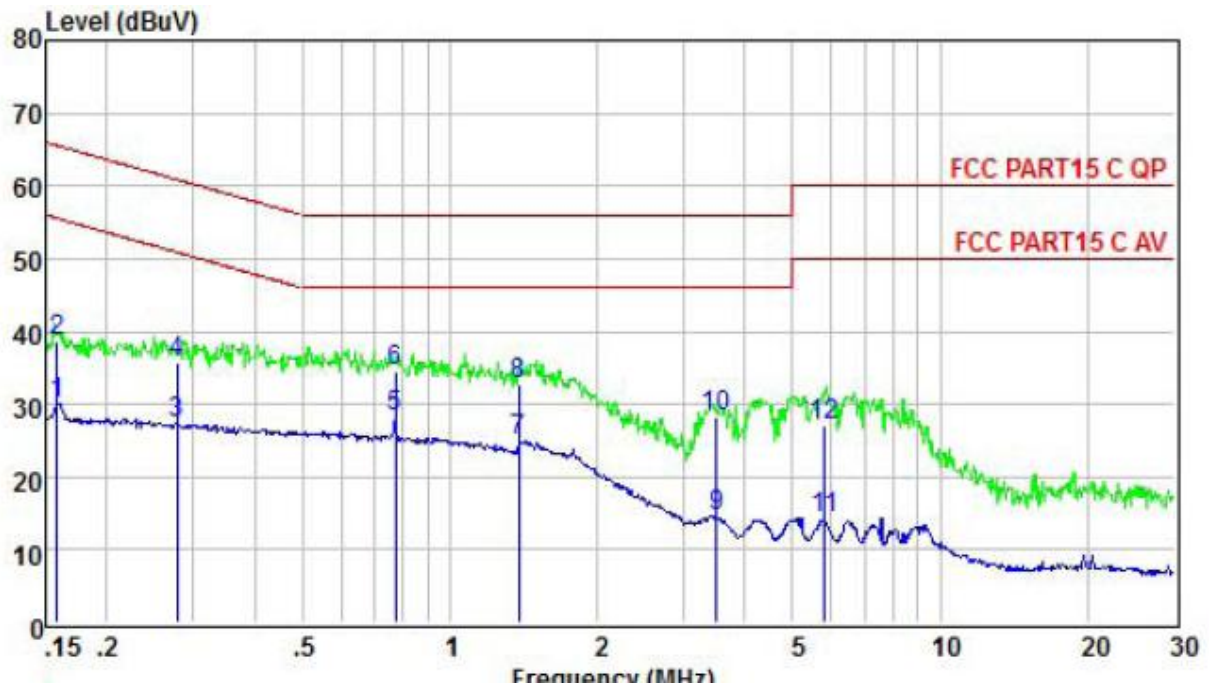

	Freq	Level	Limit	Over	Remark
	MHz	dBuV	dBuV	dB	
1	0.158	30.17	55.56	-25.39	Average
2	0.158	38.55	65.56	-27.01	QP
3	0.277	27.31	50.90	-23.59	Average
4	0.277	35.69	60.90	-25.21	QP
5	0.775	28.17	46.00	-17.83	Average
6	0.775	34.58	56.00	-21.42	QP
7	1.381	24.88	46.00	-21.12	Average
8	1.381	32.69	56.00	-23.31	QP
9	3.491	14.60	46.00	-31.40	Average
10	3.491	28.12	56.00	-27.88	QP
11	5.805	14.33	50.00	-35.67	Average
12	5.805	26.99	60.00	-33.01	QP

Remark: Factor = Insertion Loss + Cable Loss, Result = Reading + Factor, Margin = Result – Limit.

4. RADIATED EMISSION TEST

4.1 Radiation Limit

For unintentional device, according to § 15.109(a), except for Class A digital devices, the field strength of radiated emissions from unintentional radiators at a distance of 3 meters shall not exceed the following values:

Frequency (MHz)	Distance (Meters)	Radiated (dBµV/m)	Radiated (µV/m)
30-88	3	40	100
88-216	3	43.5	150
216-960	3	46	200
Above 960	3	54	500

For intentional device, according to § 15.209(a), the general requirement of field strength of radiated emissions from intentional radiators at a distance of 3 meters shall not exceed the above table.

4.2 Test Setup

1. Radiated Emission Test-Up Frequency Below 30MHz

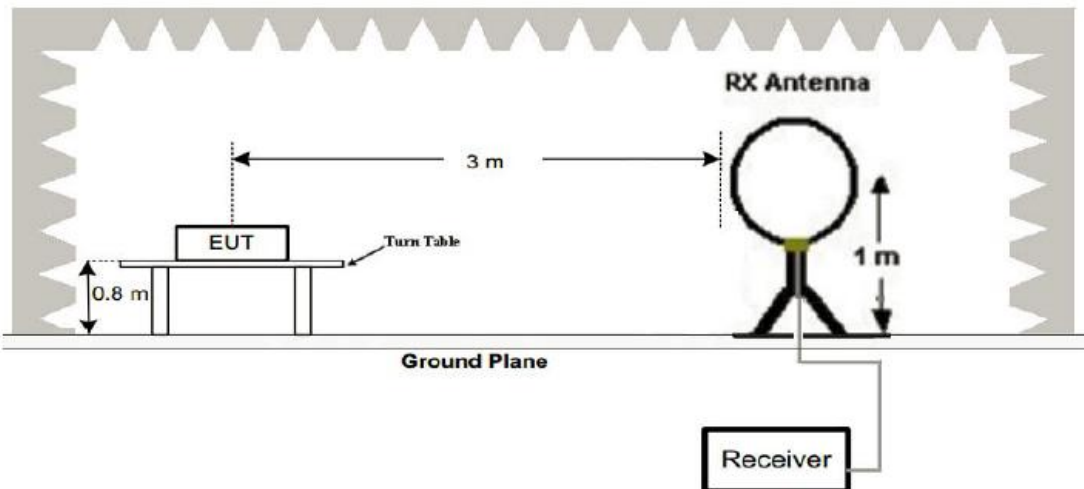

2. Radiated Emission Test-Up Frequency 30MHz~1GHz

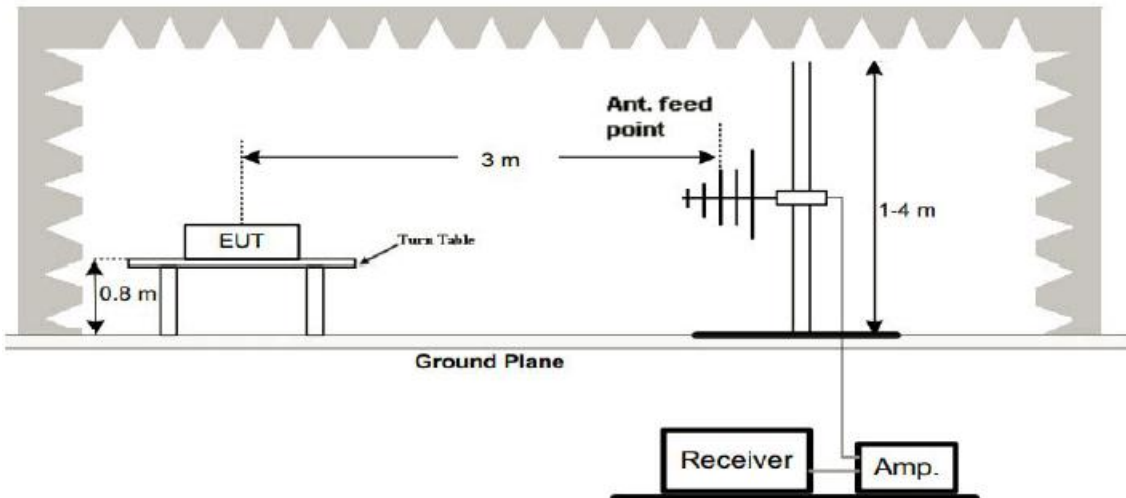

3. Radiated Emission Test-Up Frequency Above 1GHz

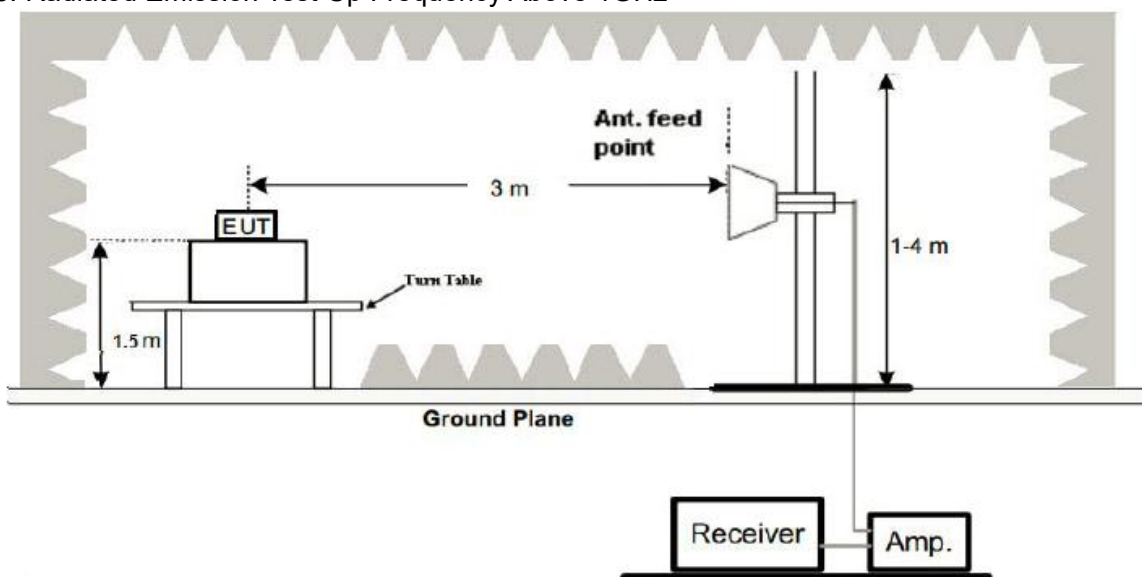

4.3 Test Procedure

1. Below 1GHz measurement the EUT is placed on turntable which is 0.8m above ground plane. And above 1GHz measurement EUT was placed on low permittivity and low tangent turn table which is 1.5m above ground plane.
2. The turntable shall be rotated for 360 degrees to determine the position of maximum emission level.
3. EUT is set 3m away from the receiving antenna, which is varied from 1m to 4m to find out the highest emissions.
4. Maximum procedure was performed on the six highest emissions to ensure EUT compliance.
5. And also, each emission was to be maximized by changing the polarization of receiving antenna both horizontal and vertical.
6. Repeat above procedures until the measurements for all frequencies are complete.
7. The test frequency range from 9KHz to 25GHz per FCC PART 15.33(a).
8. The distance between test antenna and EUT as following table states:

Test Frequency range	Test Antenna Type	Test Distance
9KHz-30MHz	Active Loop Antenna	3
30MHz-1GHz	Bilog Antenna	3
1GHz-18GHz	Horn Antenna	3
18GHz-25GHz	Horn Antenna	1

Note:

For battery operated equipment, the equipment tests shall be performed using a new battery.

4.4 Test Result

PASS

Remark:

1. All modes of GFSK, $\pi/4$ DQPSK, 8DPSK were test at Low, Middle, and High channel, only the worst result of GFSK High Channel was reported for below 1GHz test.
2. For BT3.0 above 1GHz test all modes of GFSK, $\pi/4$ DQPSK, and 8DPSK were test at Low, Middle, and High channel, only the worst result of GFSK DH5 was reported.
3. By preliminary testing and verifying three axis (X, Y and Z) position of EUT transmitted status, it was found that "Z axis" position was the worst, and test data recorded in this report.
4. Radiated emission test from 9KHz to 10th harmonic of fundamental was verified, and no emission found except system noise floor in 9KHz to 30MHz and not recorded in this report.

Temperature:	22°C	Relative Humidity:	48%
Test Date:	Jun. 27, 2019	Pressure:	1010hPa
Test Voltage:	DC 3.7V	Polarization:	Horizontal
Test Mode:	Transmitting mode of GFSK 2480MHz		

Below 30MHz

Freq.	Reading	Limit	Margin	State
(MHz)	(dBuV/m)	(dBuV/m)	(dB)	P/F
--	--	--	--	P
--	--	--	--	P

Note:

The amplitude of spurious emissions which are attenuated by more than 20dB below the permissible value has no need to be reported.

Distance extrapolation factor = $40 \log(\text{specific distance}/\text{test distance})(\text{dB})$;
 Limit line = specific limits(dBuv) + distance extrapolation factor.

Below 1GHz Test Results:

Temperature:	22°C	Relative Humidity:	48%
Test Date:	Jun. 27, 2019	Pressure:	1010hPa
Test Voltage:	DC 3.7V	Polarization:	Horizontal
Test Mode:	Transmitting mode of GFSK 2480MHz		

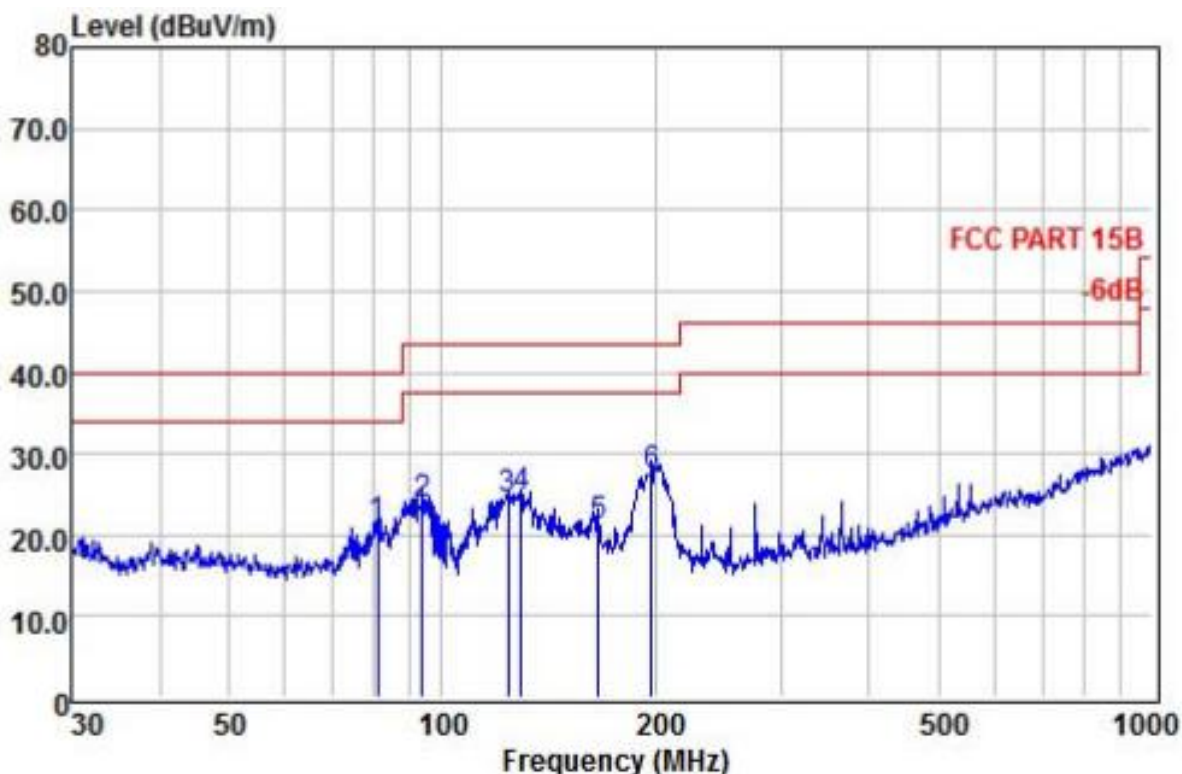

	Freq	Level	Antenna Factor	Cable Loss	Limit Line	Over Limit	Remark
	MHz	dBuV/m	dB/m	dB	dBuV/m	dB	
1	80.927	21.05	13.04	0.15	40.00	-18.95	QP
2	93.768	23.72	11.92	0.16	43.50	-19.78	QP
3	123.699	24.29	12.89	0.21	43.50	-19.21	QP
4	129.468	24.63	13.75	0.22	43.50	-18.87	QP
5	166.068	21.22	14.73	0.23	43.50	-22.28	QP
6	197.200	27.23	11.57	0.31	43.50	-16.27	QP

Remark: Absolute Level = Reading Level + Factor, Margin = Absolute Level – Limit
 Factor = Ant. Factor + Cable Loss

Temperature:	22°C	Relative Humidity:	48%
Test Date:	Jun. 27, 2019	Pressure:	1010hPa
Test Voltage:	DC 3.7V	Polarization:	Vertical
Test Mode:	Transmitting mode of GFSK 2480MHz		

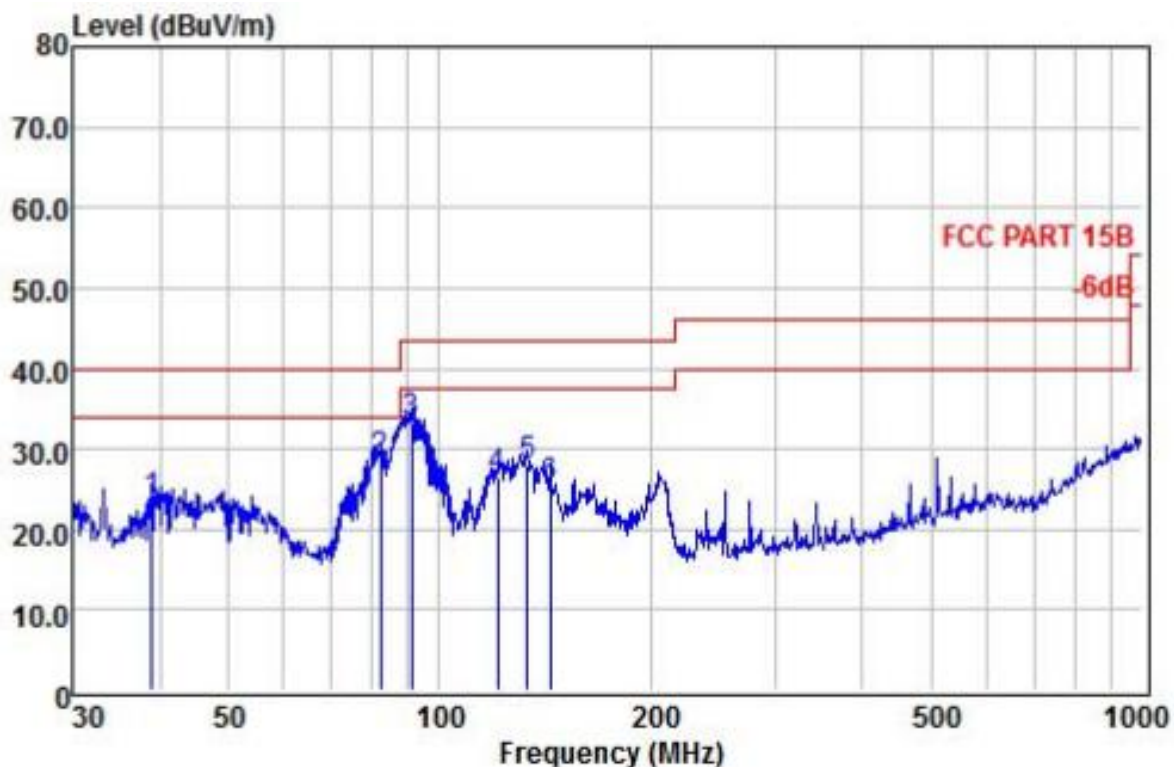

	Freq	Antenna Level	Cable Factor	Limit	Over	Remark
	MHz	dBuV/m	dB/m	dB	dBuV/m	dB
1	38.888	23.60	13.35	0.15	40.00	-16.40 QP
2	82.359	28.49	11.17	0.15	40.00	-11.51 QP
3	91.175	33.24	11.37	0.16	43.50	-10.26 QP
4	121.123	26.60	12.50	0.20	43.50	-16.90 QP
5	133.619	27.82	14.34	0.22	43.50	-15.68 QP
6	143.830	25.14	15.31	0.23	43.50	-18.36 QP

Remark: Absolute Level = Reading Level + Factor, Margin = Absolute Level – Limit
 Factor = Ant. Factor + Cable Loss

Remark:

- (1) Measuring frequencies from 9 KHz to the 1 GHz, Radiated emission test from 9KHz to 30MHz was verified, and no any emission was found except system noise floor.
- (2) * denotes emission frequency which appearing within the Restricted Bands specified in provision of 15.205, then the general radiated emission limits in 15.209 apply.
- (3) The IF bandwidth of EMI Test Receiver between 30MHz to 1GHz was 120KHz, 1 MHz for measuring above 1 GHz, below 30MHz was 10KHz.

Above 1 GHz Test Results (GFSK Worst Case):
CH Middle (2402MHz)

Horizontal:

Frequency	Reading Result	Factor	Emission Level	Limits	Margin	Detector
(MHz)	(dB μ V)	(dB)	(dB μ V/m)	(dB μ V/m)	(dB)	Type
2402	106.38	-5.84	100.54	114.00	-13.46	PK
2402	82.35	-5.84	76.51	94.00	-17.49	AV
4804	61.66	-3.64	58.02	74.00	-15.98	PK
4804	48.34	-3.64	44.7	54.00	-9.3	AV
7206	60.25	-0.95	59.3	74.00	-14.7	PK
7206	47.97	-0.95	47.02	54.00	-6.98	AV

Remark: Factor = Antenna Factor + Cable Loss – Pre-Bluetooth Speaker. Margin = Absolute Level – Limit

Vertical:

Frequency	Reading Result	Factor	Emission Level	Limits	Margin	Detector
(MHz)	(dB μ V)	(dB)	(dB μ V/m)	(dB μ V/m)	(dB)	Type
2402	106.44	-5.84	100.6	114.00	-13.4	PK
2402	83.49	-5.84	77.65	94.00	-16.35	AV
4804	64.68	-3.64	61.04	74.00	-12.96	PK
4804	47.19	-3.64	43.55	54.00	-10.45	AV
7206	61.33	-0.95	60.38	74.00	-13.62	PK
7206	45.28	-0.95	44.33	54.00	-9.67	AV

Remark: Factor = Antenna Factor + Cable Loss – Pre-Bluetooth Speaker. Margin = Absolute Level – Limit

CH Middle (2441MHz)

Horizontal:

Frequency	Reading Result	Factor	Emission Level	Limits	Margin	Detector
(MHz)	(dB μ V)	(dB)	(dB μ V/m)	(dB μ V/m)	(dB)	Type
2441	105.46	-5.84	99.62	114.00	-14.38	PK
2441	87.53	-5.84	81.69	94.00	-12.31	AV
4882	66.49	-3.64	62.85	74.00	-11.15	PK
4882	50.96	-3.64	47.32	54.00	-6.68	AV
7323	57.19	-0.95	56.24	74.00	-17.76	PK
7323	43.18	-0.95	42.23	54.00	-11.77	AV

Remark: Factor = Antenna Factor + Cable Loss – Pre-Bluetooth Speaker. Margin = Absolute Level – Limit

Vertical:

Frequency	Reading Result	Factor	Emission Level	Limits	Margin	Detector
(MHz)	(dB μ V)	(dB)	(dB μ V/m)	(dB μ V/m)	(dB)	Type
2441	104.38	-5.84	98.54	114.00	-15.46	PK
2441	82.53	-5.84	76.69	94.00	-17.31	AV
4882	59.43	-3.64	55.79	74.00	-18.21	PK
4882	46.18	-3.64	42.54	54.00	-11.46	AV
7323	61.24	-0.95	60.29	74.00	-13.71	PK
7323	44.53	-0.95	43.58	54.00	-10.42	AV

Remark: Factor = Antenna Factor + Cable Loss – Pre-Bluetooth Speaker. Margin = Absolute Level – Limit

CH High (2480MHz)

Horizontal:

Frequency (MHz)	Reading Result (dB μ V)	Factor (dB)	Emission Level (dB μ V/m)	Limits (dB μ V/m)	Margin (dB)	Detector Type
2480	108.49	-5.84	102.65	114.00	-11.35	PK
2480	85.66	-5.84	79.82	94.00	-14.18	AV
4960	61.35	-3.64	57.71	74.00	-16.29	PK
4960	49.63	-3.64	45.99	54.00	-8.01	AV
7440	62.44	-0.95	61.49	74.00	-12.51	PK
7440	47.82	-0.95	46.87	54.00	-7.13	AV

Remark: Factor = Antenna Factor + Cable Loss – Pre-Bluetooth Speaker. Margin = Absolute Level – Limit

Vertical:

Frequency (MHz)	Reading Result (dB μ V)	Factor (dB)	Emission Level (dB μ V/m)	Limits (dB μ V/m)	Margin (dB)	Detector Type
2480	107.14	-5.84	101.3	114.00	-12.7	PK
2480	83.86	-5.84	78.02	94.00	-15.98	AV
4960	62.49	-3.64	58.85	74.00	-15.15	PK
4960	50.43	-3.64	46.79	54.00	-7.21	AV
7440	60.86	-0.95	59.91	74.00	-14.09	PK
7440	46.38	-0.95	45.43	54.00	-8.57	AV

Remark: Factor = Antenna Factor + Cable Loss – Pre-Bluetooth Speaker. Margin = Absolute Level – Limit

Remark:

- (1) Measuring frequencies from 1 GHz to the 25 GHz.
- (2) "F" denotes fundamental frequency; "H" denotes spurious frequency. "E" denotes band edge frequency.
- (3) * denotes emission frequency which appearing within the Restricted Bands specified in provision of 15.205, then the general radiated emission limits in 15.209 apply.
- (4) Data of measurement within this frequency range shown "---" in the table above means the reading of emissions are attenuated more than 20dB below the permissible limits or the field strength is too small to be measured.
- (5) The IF bandwidth of EMI Test Receiver between 30MHz to 1GHz was 120KHz, 1 MHz for measuring above 1 GHz, below 30MHz was 10KHz. The resolution bandwidth of test receiver/spectrum analyzer is 1MHz and video bandwidth is 3MHz for peak measurement with peak detector at frequency above 1GHz. The resolution bandwidth of test receiver/spectrum analyzer is 1MHz and video bandwidth is 10Hz for Average measurement with peak detection at frequency above 1GHz.
- (6) When the test results of Peak Detected below the limits of Average Detected, the Average Detected is not need completed. For example: Top Channel at Fundamental 73.16dBuV/m(PK Value) <93.98(AV Limit), at harmonic 53.20 dBuV/m(PK Value) <54 dBuV/m(AV Limit), the Average Detected not need to completed.
- (7) All modes of operation were investigated and the worst-case emissions are reported.

5. BAND EDGE

5.1 Limits

FCC PART 15.247 Emissions radiated outside of the specified frequency bands, except for harmonics, shall be attenuated by at least 20 dB below the level of the fundamental or to the general radiated emission limits in §15.209, whichever is the lesser attenuation.

5.2 Test Procedure

The band edge compliance of RF radiated emission should be measured by following the guidance in ANSI C63.10 with respect to maximizing the emission by rotating the EUT, measuring the emission while the EUT is situated in three orthogonal planes (if appropriate), adjusting the measurement antenna height and polarization etc. Set RBW to 1MHz and VBW to 3MHz to measure the peak field strength and set RBW to 1MHz and VBW to 10kHz to measure the average radiated field strength. The conducted RF band edge was measured by using a spectrum analyzer. Set span wide enough to capture the highest in-band emission and the emission at the band edge. Set RBW to 100 KHz and VBW to 300 KHz, to measure the conducted peak band edge.

5.3 Test Result

PASS

Remark: All modes of GFSK, $\pi/4$ DQPSK, 8DPSK were tested, only the worst result of GFSK was reported as below:

Radiated Band Edge Test:

Worst case on GFSK

Operation Mode: TX CH Low (2402MHz)

Horizontal:

Frequency	Reading Result	Factor	Emission Level	Limits	Margin	Detector Type
(MHz)	(dB μ V)	(dB)	(dB μ V/m)	(dB μ V/m)	(dB)	
2310	53.47	-5.81	47.66	74.00	-26.34	PK
2310	/	-5.81	/	54.00	/	AV
2390	52.66	-5.84	46.82	74.00	-27.18	PK
2390	/	-5.84	/	54.00	/	AV
2400	52.34	-5.84	46.5	74.00	-27.5	PK
2400	/	-5.84	/	54.00	/	AV

Remark: Factor = Antenna Factor + Cable Loss – Pre-Bluetooth Speaker.

Vertical:

Frequency	Reading Result	Factor	Emission Level	Limits	Margin	Detector Type
(MHz)	(dB μ V)	(dB)	(dB μ V/m)	(dB μ V/m)	(dB)	
2310	52.68	-5.81	46.87	74.00	-27.13	PK
2310	/	-5.81	/	54.00	/	AV
2390	52.68	-5.84	46.84	74.00	-27.16	PK
2390	/	-5.84	/	54.00	/	AV
2400	51.46	-5.84	45.62	74.00	-28.38	PK
2400	/	-5.84	/	54.00	/	AV

Remark: Factor = Antenna Factor + Cable Loss – Pre-Bluetooth Speaker.

Operation Mode: TX CH High (2480MHz)

Horizontal :

Frequency	Reading Result	Factor	Emission Level	Limits	Margin	Detector Type
(MHz)	(dB μ V)	(dB)	(dB μ V/m)	(dB μ V/m)	(dB)	
2483.5	51.63	-5.65	45.98	74.00	-28.02	PK
2483.5	/	-5.65	/	54.00	/	AV
2500	52.34	-5.72	46.62	74.00	-27.38	PK
2500	/	-5.72	/	54.00	/	AV
Remark: Factor = Antenna Factor + Cable Loss – Pre-Bluetooth Speaker.						

Vertical:

Frequency	Reading Result	Factor	Emission Level	Limits	Margin	Detector Type
(MHz)	(dB μ V)	(dB)	(dB μ V/m)	(dB μ V/m)	(dB)	
2483.5	51.43	-5.65	45.78	74.00	-28.22	PK
2483.5	/	-5.65	/	54.00	/	AV
2500	52.38	-5.72	46.66	74.00	-27.34	PK
2500	/	-5.72	/	54.00	/	AV
Remark: Factor = Antenna Factor + Cable Loss – Pre-Bluetooth Speaker.						

6. OCCUPIED BANDWIDTH MEASUREMENT

6.1 Test Setup

Same as Radiated Emission Measurement

6.2 Test Procedure

1. The EUT was placed on a turn table which is 0.8m above ground plane.
2. Set EUT as normal operation.
3. Based on ANSI C63.10 section 6.9.2: RBW=30KHz, VBW=100KHz, Span=3MHz.
4. The useful radiated emission from the EUT was detected by the spectrum analyser with peak detector.

6.3 Measurement Equipment Used

Same as Radiated Emission Measurement

6.4 Test Result

PASS

GFSK Modulation:

Frequency (MHz)	20dB Bandwidth (MHz)	Result
2402	0.889	PASS
2441	0.867	PASS
2480	0.887	PASS

CH: 2402MHz

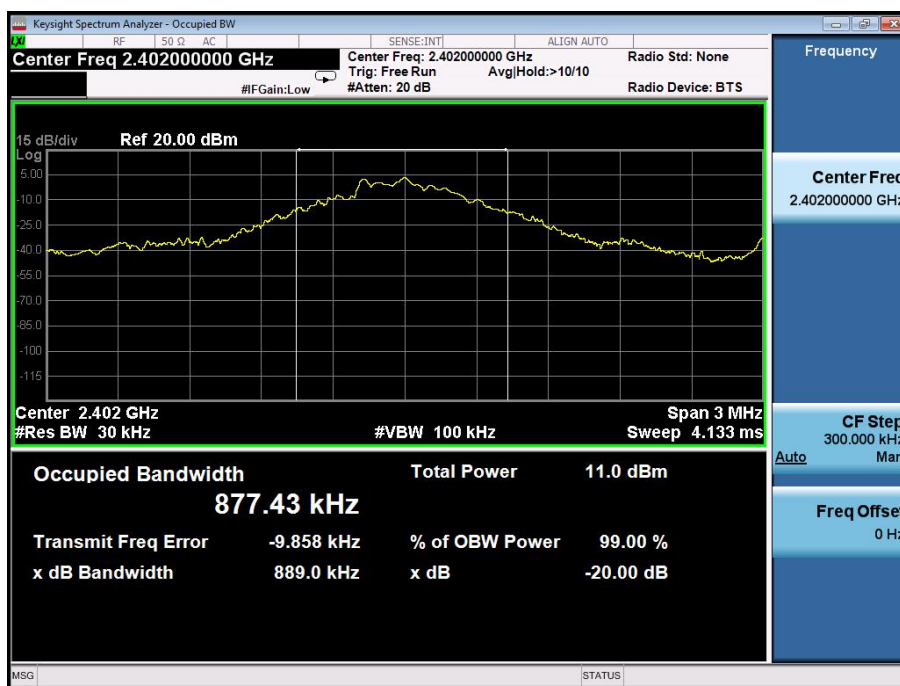

CH: 2441MHz

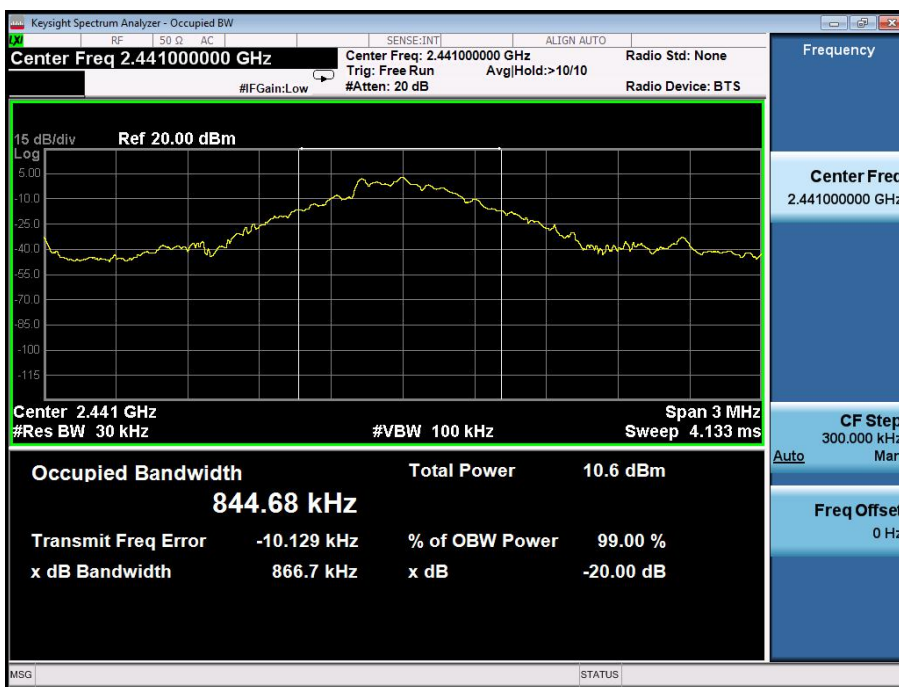

CH: 2480MHz



$\pi/4$ DQPSK Modulation:

Frequency (MHz)	20dB Bandwidth (MHz)	Result
2402	1.220	PASS
2441	1.222	PASS
2480	1.219	PASS

CH: 2402MHz

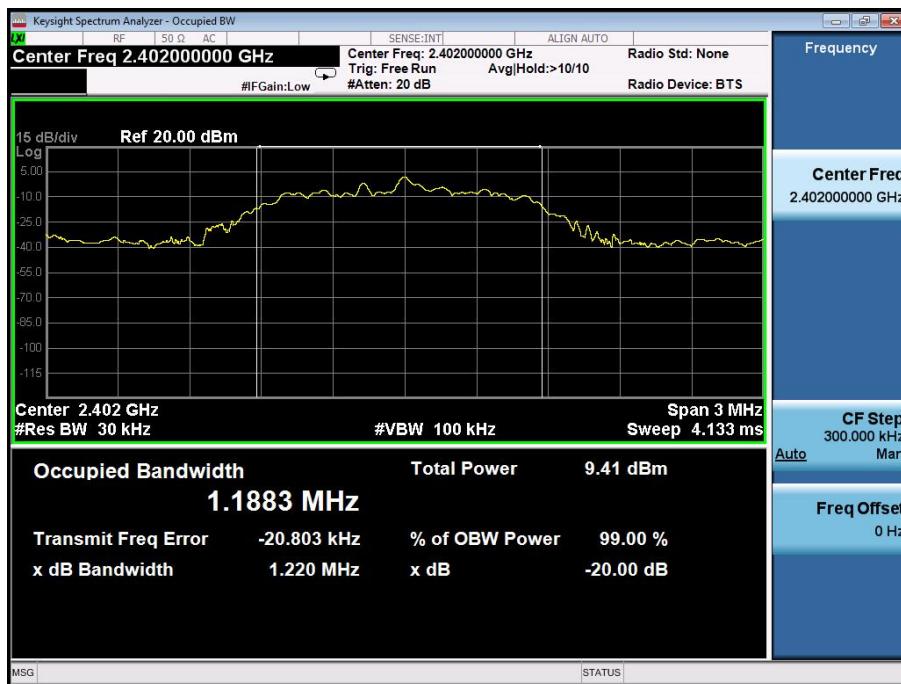

CH: 2441MHz

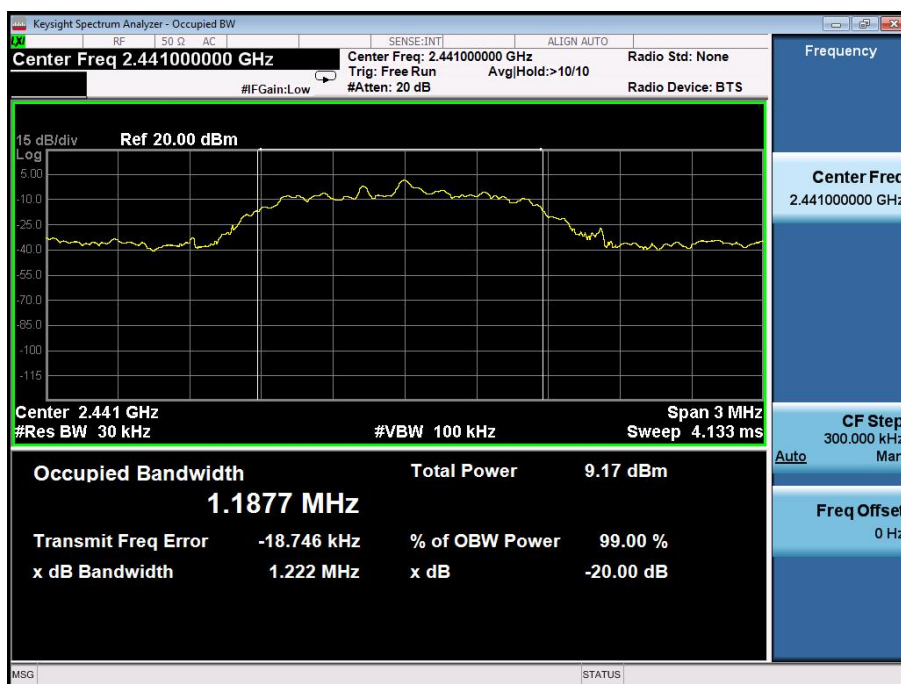

CH: 2480MHz

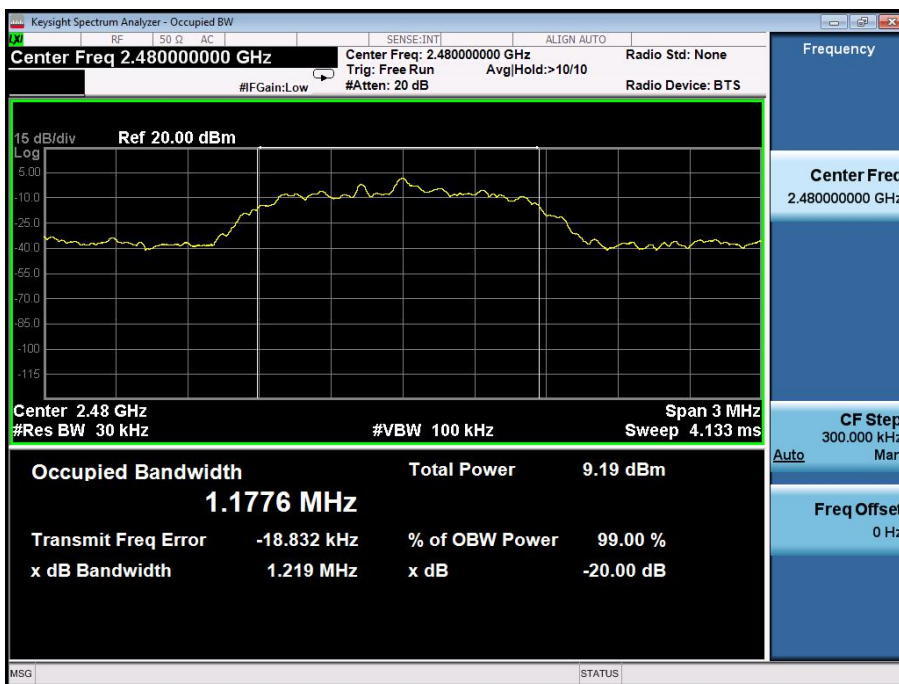

8DPSK Modulation:

Frequency (MHz)	20dB Bandwidth (MHz)	Result
2402	1.207	PASS
2441	1.212	PASS
2480	1.211	PASS

CH: 2402MHz

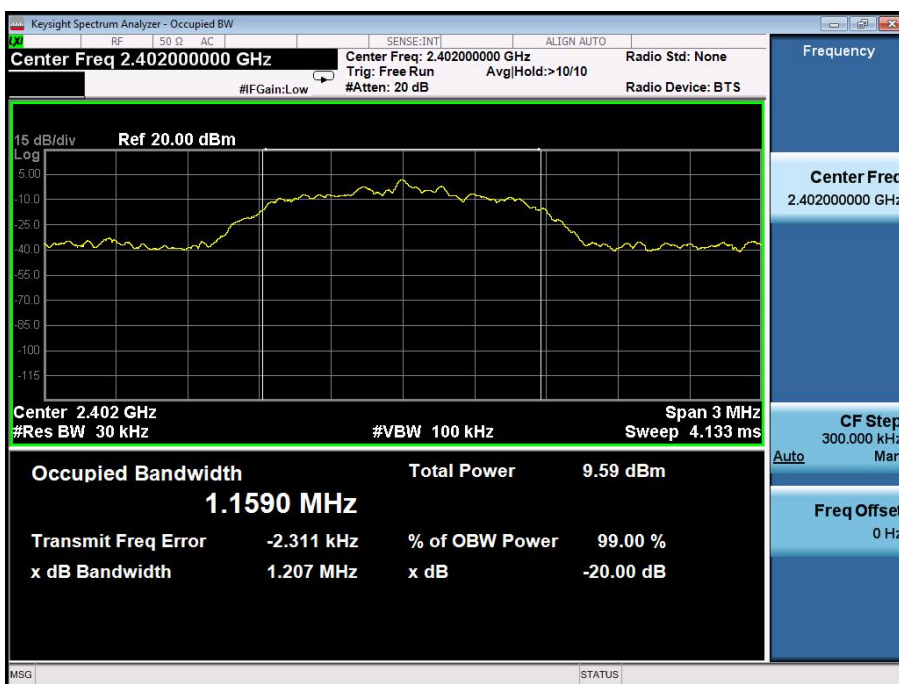

CH: 2441MHz

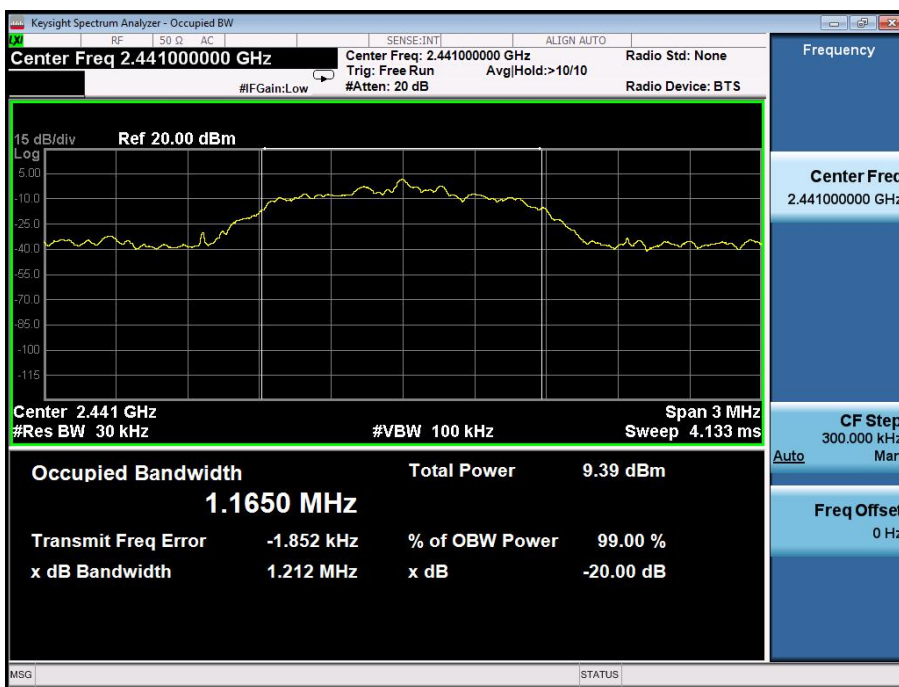

CH: 2480MHz

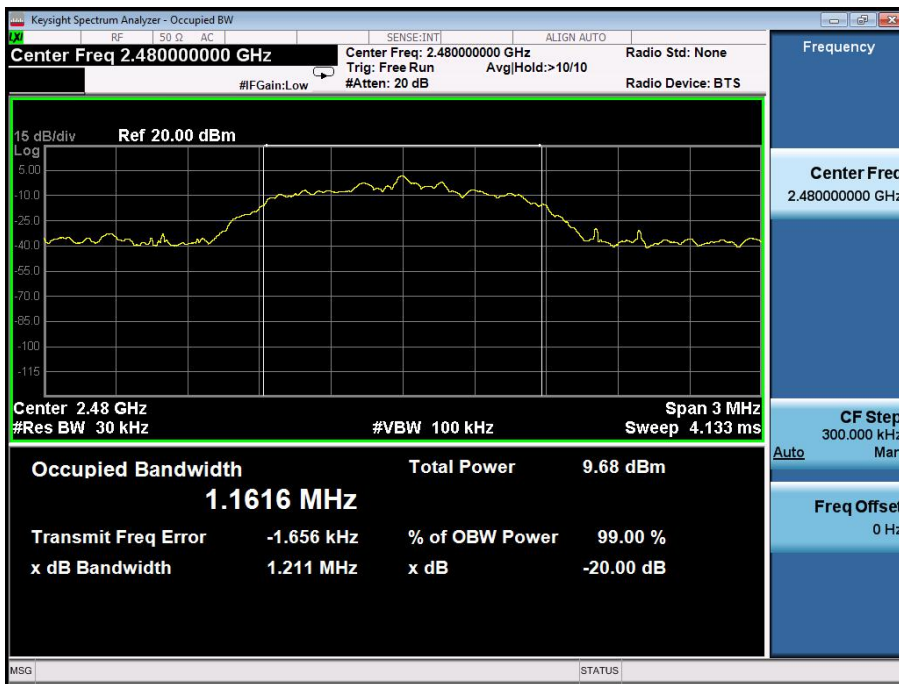

7. MAXIMUM PEAK OUTPUT POWER

7.1 Test Setup



7.2 Test Procedure

According to ANSI C63.10:2013 Maximum peak conducted output power for HFSS devices:
 The maximum peak conducted output power may be measured using a broadband peak RF power meter. The power meter shall have a video bandwidth that is greater than or equal to the HFSS bandwidth and shall utilize a fast-responding diode detector.
 The maximum Average conducted output power may be measured using a wideband RF power meter with a thermocouple detector or equivalent. The power meter shall have a video bandwidth that is greater than or equal to the HFSS bandwidth and shall utilize a fast-responding diode detector.

7.3 Limit

For frequency hopping systems operating in the 2400–2483.5 MHz band employing at least 75 non-overlapping hopping channels, and all frequency hopping systems in the 5725–5850 MHz band: 1 watt. For all other frequency hopping systems in the 2400–2483.5 MHz band: 0.125 watts.

7.4 Test Result

PASS

Type	Channel	Peak Output power (dBm)	Limit (dBm)	Result
GFSK	Low	3.846	30	Pass
	Mid	3.186		
	High	3.872		
$\pi/4$ DQPSK	Low	2.474	21	Pass
	Mid	2.439		
	High	2.358		
8DPSK	Low	2.149	21	Pass
	Mid	2.442		
	High	2.654		

8. FREQUENCY SEPARATION

8.1 Test Setup



8.2 Test Procedure

The transmitter output was connected to the spectrum analyzer through an attenuator. The bandwidth of the fundamental frequency was measured by spectrum analyzer with RBW=30KHz and VBW=100KHz.

8.3 Limit

According to 15.247(a)(1), frequency hopping systems shall have hopping channel carrier frequencies separated by minimum of 25KHz or the 2/3*20dB bandwidth of the hopping channel, whichever is greater.

8.4 Test Result

PASS

Type/Modulation	CH	CH Frequency (MHz)	CH Separation (MHz)	Limit (MHz)	Result
CH Separation GFSK	Low Channel	2402	0.998	0.889	pass
	Adjacency Channel	2403			
	Mid Channel	2441	0.994	0.867	pass
	Adjacency Channel	2442			
	High Channel	2480	1.002	0.887	pass
	Adjacency Channel	2479			

CH: 2402MHz



CH: 2441MHz



CH: 2480MHz



Type/Modulation	CH	CH Frequency (MHz)	CH Separation (MHz)	Limit (MHz)	Result
CH Separation $\pi/4$ DQPSK	Low Channel	2402	0.996	0.813	pass
	Adjacency Channel	2403			
	Mid Channel	2441	0.998	0.815	pass
	Adjacency Channel	2442			
	High Channel	2480	0.998	0.813	pass
	Adjacency Channel	2479			

CH: 2402MHz



CH: 2441MHz

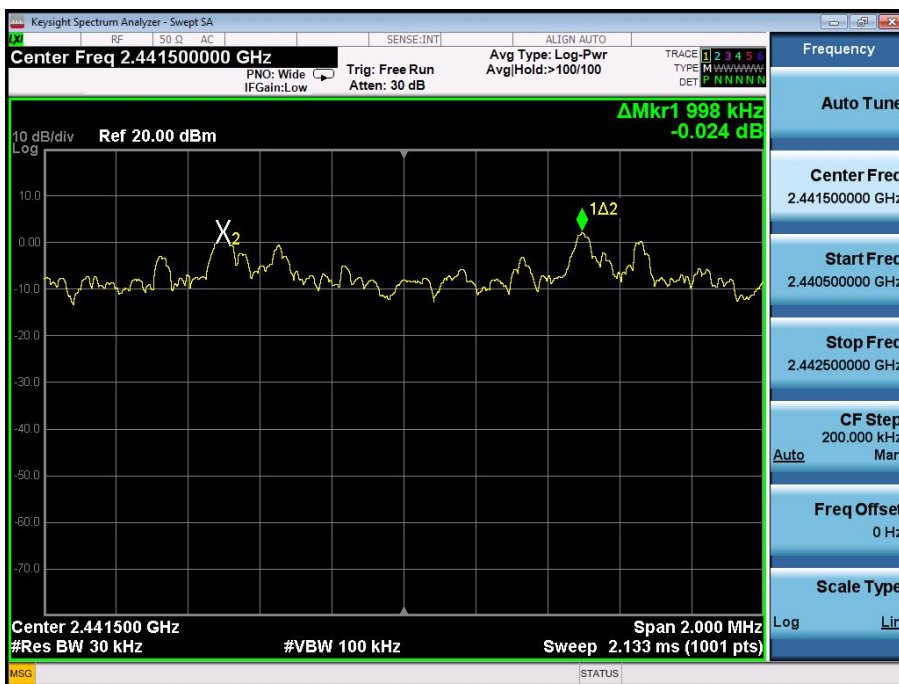

CH: 2480MHz



Type/Modulation	CH	CH Frequency (MHz)	CH Separation (MHz)	Limit (MHz)	Result
CH Separation 8DPSK	Low Channel	2402	0.994	0.805	pass
	Adjacency Channel	2403			
	Mid Channel	2441	0.992	0.808	pass
	Adjacency Channel	2442			
	High Channel	2480	0.998	0.807	pass
	Adjacency Channel	2479			

CH: 2402MHz



CH: 2441MHz



CH: 2480MHz



9. CONDUCTED BANDEGE MEASUREMENT

9.1 Test Setup



9.2 Test Procedure

1. The EUT was placed on a turn table which is 0.8m above ground plane.
2. Set EUT as TX operation and connect directly to the spectrum analyzer.
3. Based on FCC Part15 C Section 15.247: RBW=100KHz, VBW=300KHz.
4. Set detected by the spectrum analyzer with peak detector.

9.3 Limit

In any 100 kHz bandwidth outside the frequency band in which the spread spectrum or digitally modulated intentional radiator is operating, the radio frequency power that is produced by the intentional radiator shall be at least 20 dB below that in the 100 kHz bandwidth within the band that contains the highest level of the desired power, based on either an RF conducted or a radiated measurement, provided the transmitter demonstrates compliance with the peak conducted power limits. If the transmitter complies with the conducted power limits based on the use of RMS averaging over a time interval, as permitted under paragraph (b)(3) of this section, the attenuation required under this paragraph shall be 30 dB instead of 20dB.

9.4 Test Result

PASS

Modulation		Frequency Band	Delta Peak to band emission (dBc)	>Limit (dBc)	Result
GFSK	Non-hopping	Left Band	41.94	20	Pass
		Right Band	61.51	20	Pass
	hopping	Left Band	38.28	20	Pass
		Right Band	60.18	20	Pass
$\pi/4$ DQPSK	Non-hopping	Left Band	38.05	20	Pass
		Right Band	54.84	20	Pass
	hopping	Left Band	38.24	20	Pass
		Right Band	61.72	20	Pass
8DPSK	Non-hopping	Left Band	37.76	20	Pass
		Right Band	55.53	20	Pass
	hopping	Left Band	38.74	20	Pass
		Right Band	61.25	20	Pass

GFSK

2402MHz

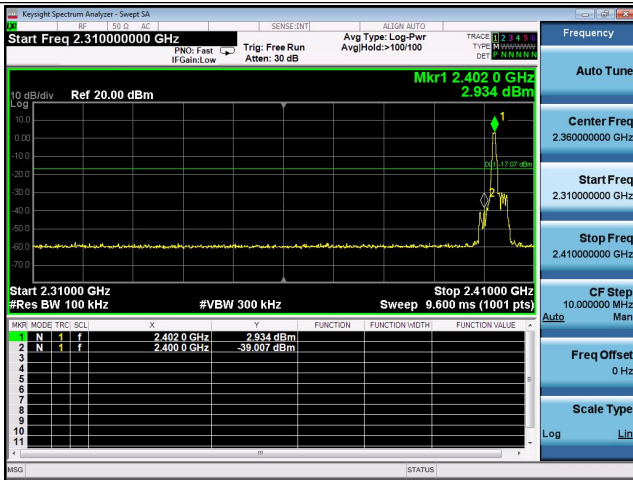

2480MHz

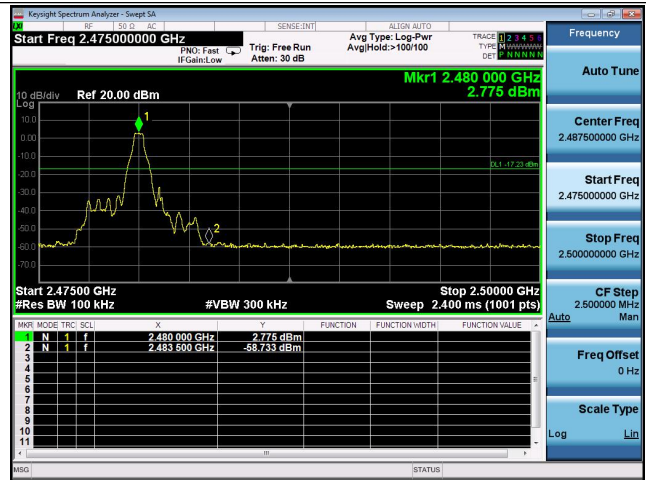

Hopping Off

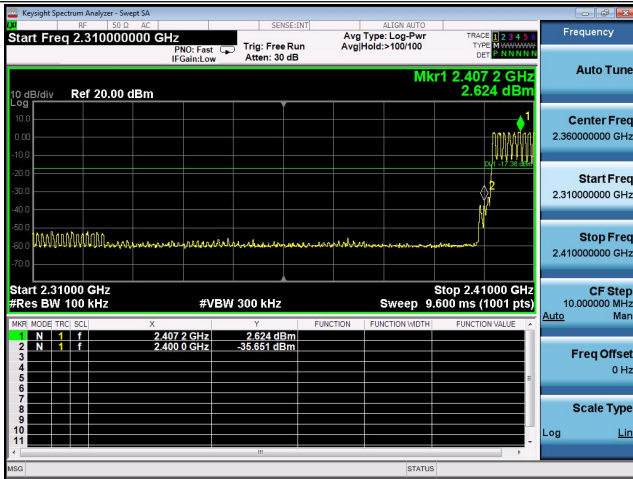

Hopping Off

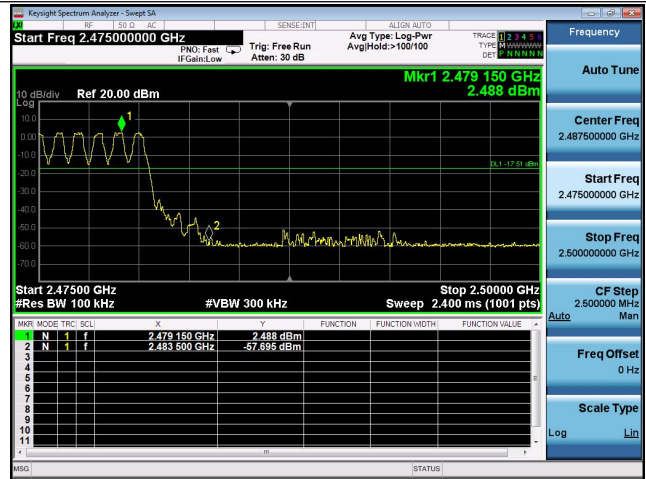

Hopping On

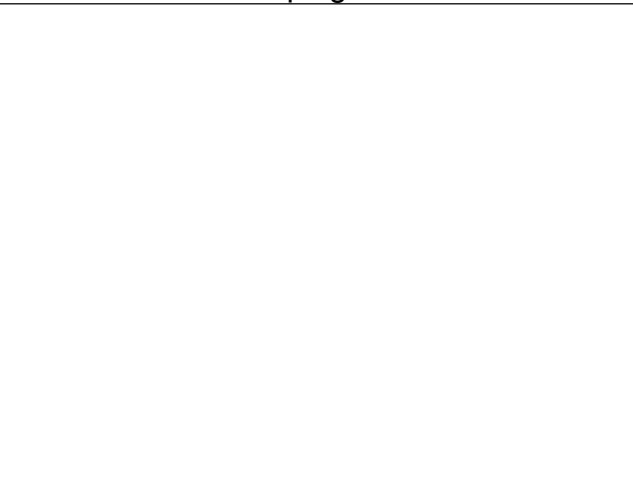

Hopping On

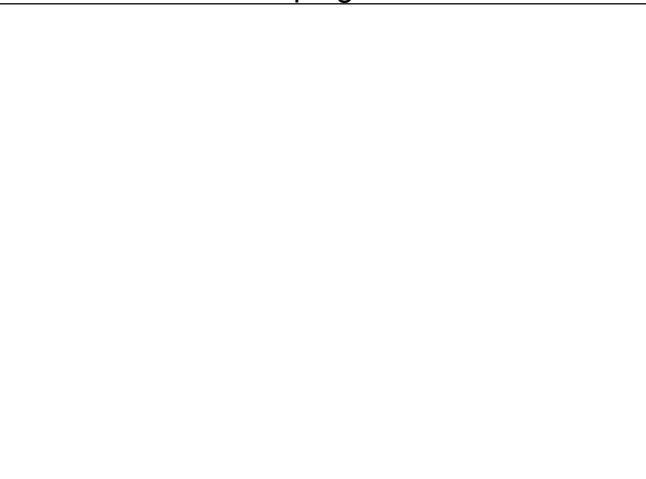

π /4DQPSK

2402MHz

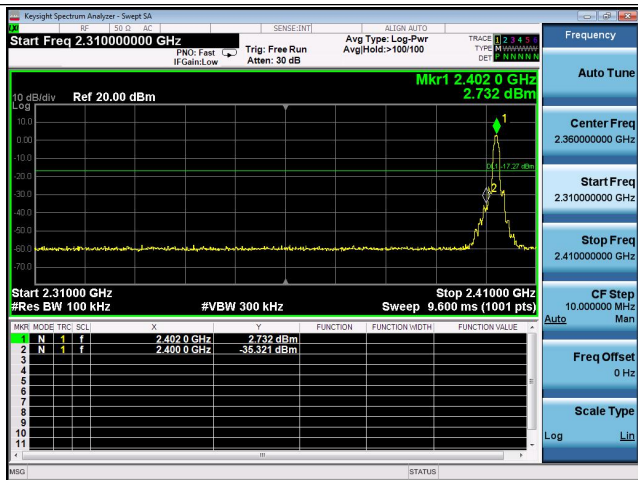

2480MHz



Hopping Off

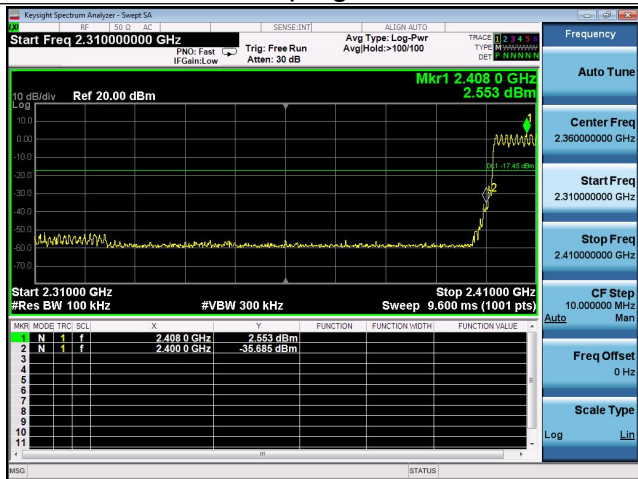

Hopping Off



Hopping On

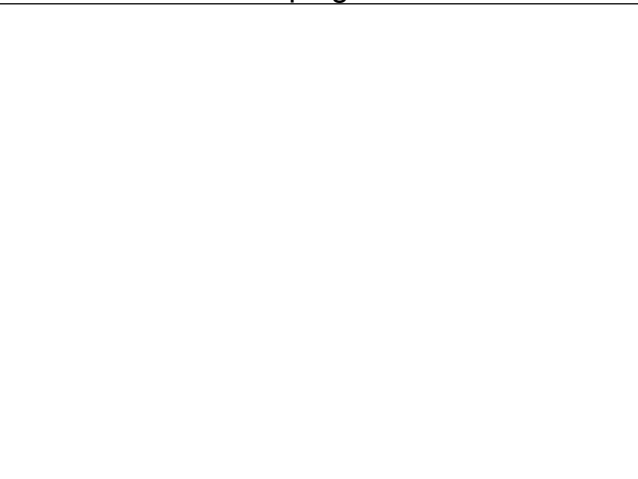

Hopping On

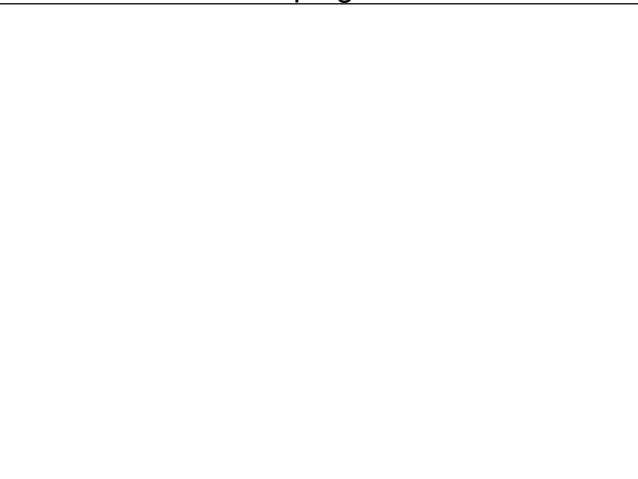

8DPSK

2402MHz

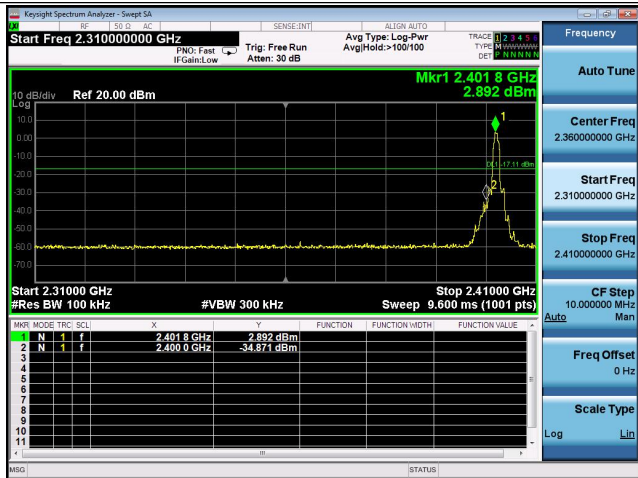

2480MHz



Hopping Off

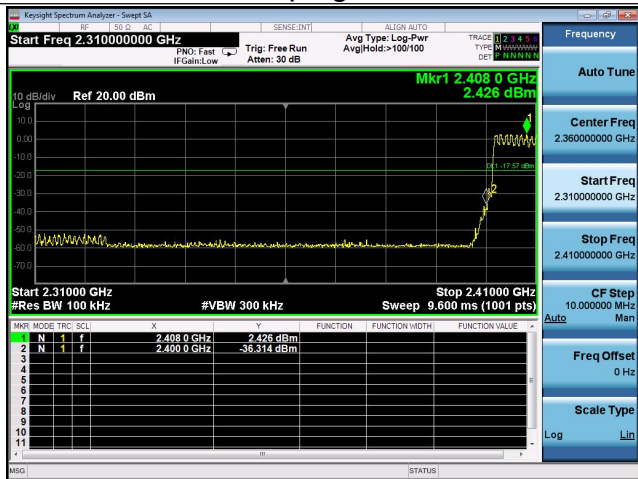

Hopping Off



Hopping On

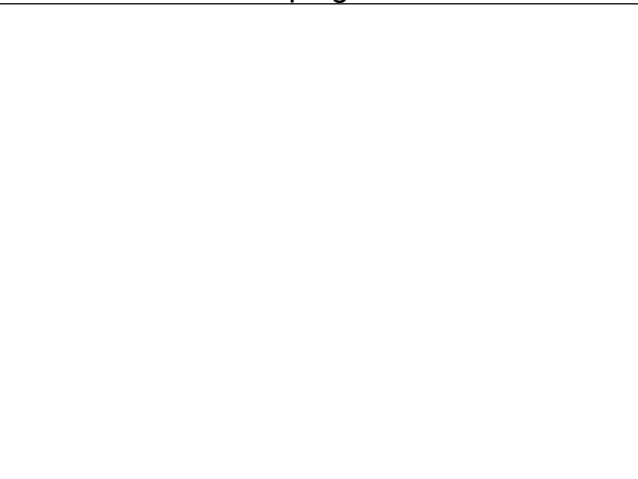

Hopping On

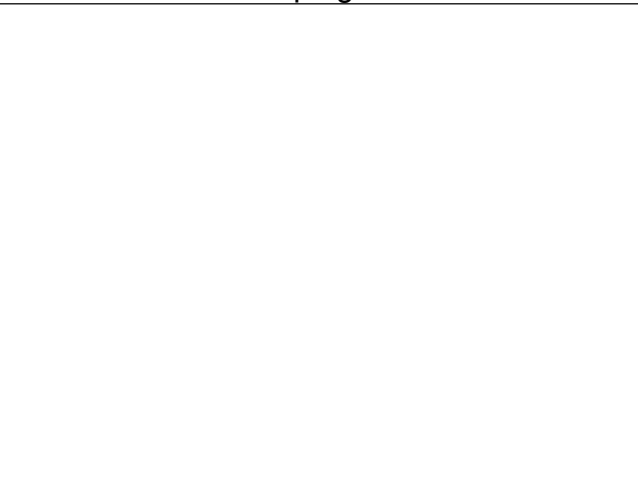

10. SPURIOUS RF CONDUCTED EMISSION

10.1 Test Limit

- 1. Below -20dB of the highest emission level in operating band.
- 2. Fall in the restricted bands listed in section 15.205. The maximum permitted average field strength is listed in section 15.209.
- 3. For below 30MHz, For 9KHz-150kHz, 150K-10MHz, We use the RBW 1KHz, 10KHz, So the limit need to be calculated by $10\lg(BW1/BW2)$. for example For 9KHz-150kHz, RBW 1KHz, The Limit= the highest emission level-20-10log(100/1)= the highest emission level-40.

10.2 Test Procedure

The Spurious RF conducted emissions compliance of RF radiated emission should be measured by following the guidance in ANSI C63.10-2013, For 9KHz-150kHz, Set RBW=1kHz and VBW= 3KHz; For 150KHz-10MHz, Set RBW=10kHz and VBW= 30KHz; For 10MHz-25GHz, Set RBW=100kHz and VBW= 300KHz in order to measure the peak field strength, and measure frequency range from 9KHz to 25GHz.

10.3 Test Setup

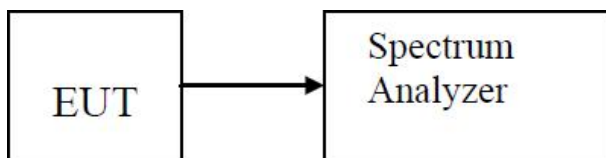

10.4 Test Result

PASS

Remark: All modes of GFSK, $\pi/4$ DQPSK, 8DPSK were tested, only the worst result of GFSK was reported as below:

GFSK

CH: 2402MHz

