



# **FCC TEST REPORT**

## **FCC PART 15 SUBPART C 15.249**

**Test report**  
**On Behalf of**  
**GUANGZHOU U&I TECHNOLOGY COMPANY LIMITED**  
**For**  
**TWS Bluetooth Headset**  
**Model No.: BS228GB**  
  
**FCC ID: 2AIXN-BS228GB**

**Prepared for :** **GUANGZHOU U&I TECHNOLOGY COMPANY LIMITED**  
**4th Floor, 15th Building, Vtrek Innovation Industrial Park, No. 644 Shibe**  
**Road, Panyu District, Guangzhou, China**

**Prepared By :** **Shenzhen HUAKE Testing Technology Co., Ltd.**  
**1F, B2 Building, Junfeng Zhongcheng Zhizao Innovation Park, Fuhai**  
**Street, Bao'an District, Shenzhen City, China**

**Date of Test:** **Feb. 15, 2019 ~ Mar. 22, 2019**  
**Date of Report:** **Mar. 22, 2019**  
**Report Number:** **HK1902250305E**



### TEST RESULT CERTIFICATION

**Applicant's name**..... GUANGZHOU U&I TECHNOLOGY COMPANY LIMITED  
Address ..... 4th Floor, 15th Building, Vtrek Innovation Industrial Park, No. 644 Shibei Road, Panyu District, Guangzhou, China

**Manufacture's Name** ..... GUANGZHOU U&I TECHNOLOGY COMPANY LIMITED  
Address ..... 4th Floor, 15th Building, Vtrek Innovation Industrial Park, No. 644 Shibei Road, Panyu District, Guangzhou, China

**Factory's Name**..... GUANGZHOU U&I TECHNOLOGY COMPANY LIMITED  
Address ..... 4th Floor, 15th Building, Vtrek Innovation Industrial Park, No. 644 Shibei Road, Panyu District, Guangzhou, China

**Product description**

Trade Mark ..... N/A  
Product name ..... TWS Bluetooth Headset  
Model and/or type reference ... BS228GB  
Series Model ..... BS224GB, BS223GB, BS226GB, BS225GB, BS121GB, BS209GB, BS205GB, BS250GB  
Difference Description ..... All the same except for the model name  
**Standards** ..... FCC Rules and Regulations Part 15 Subpart C Section 15.249  
ANSI C63.10: 2013

This publication may be reproduced in whole or in part for non-commercial purposes as long as the Shenzhen HUAK Testing Technology Co., Ltd. is acknowledged as copyright owner and source of the material. Shenzhen HUAK Testing Technology Co., Ltd. takes no responsibility for and will not assume liability for damages resulting from the reader's interpretation of the reproduced material due to its placement and context.

**Date of Test**..... :  
Date (s) of performance of tests ..... : Feb. 15, 2019 ~ Mar. 22, 2019  
Date of Issue ..... : Mar. 22, 2019  
Test Result ..... : **Pass**

Testing Engineer :   
\_\_\_\_\_  
(Gary Qian)

Technical Manager :   
\_\_\_\_\_  
(Eden Hu)

Authorized Signatory :   
\_\_\_\_\_  
(Jason Zhou)



<b>Table of Contents</b>	<b>Page</b>
1 . TEST SUMMARY	4
2 . GENERAL INFORMATION	5
2.1 GENERAL DESCRIPTION OF EUT	5
2.2 OPERATION OF EUT DURING TESTING	6
2.3 DESCRIPTION OF TEST SETUP	7
2.4 MEASUREMENT INSTRUMENTS LIST	8
3. RADIATED EMISSION	9
3.1. MEASUREMENT PROCEDURE	9
3.2. TEST SETUP	11
3.3. TEST RESULT	12
4. BAND EDGE EMISSION	20
4.1. MEASUREMENT PROCEDURE	20
4.2 TEST SETUP	20
4.3 RADIATED TEST RESULT	21
5. BANDWIDTH	25
5.1. MEASUREMENT PROCEDURE	25
5.2. TEST SETUP	25
5.3. TEST RESULT	26
6. FCC LINE CONDUCTED EMISSION TEST	32
6.1. LIMITS OF LINE CONDUCTED EMISSION TEST	32
6.2. BLOCK DIAGRAM OF LINE CONDUCTED EMISSION TEST	32
6.3. PRELIMINARY PROCEDURE OF LINE CONDUCTED EMISSION TEST	33
6.4. FINAL PROCEDURE OF LINE CONDUCTED EMISSION TEST	33
6.5. TEST RESULT OF LINE CONDUCTED EMISSION TEST	33
APPENDIX A: PHOTOGRAPHS OF TEST SETUP	34
APPENDIX B: PHOTOGRAPHS OF EUT	36



## 1. TEST SUMMARY

### 1.1 TEST PROCEDURES AND RESULTS

FCC RULES	DESCRIPTION OF TEST	RESULT
§15.249&15.209	Radiated Emission	Compliant
§15.249&15.209	Band Edges Emission	Compliant
§15.215	20dB bandwidth	Compliant
§15.207	Conducted Emission	N/A

Note: N/A means it's not applicable to this item.

### 1.2 TEST FACILITY

Test Firm : Shenzhen HUAKE Testing Technology Co., Ltd.

Address : 1F, B2 Building, Junfeng Zhongcheng Zhizao Innovation Park,  
Fuhai Street, Bao'an District, Shenzhen City, China

Designation Number: : CN1229

Test Firm Registration Number : 616276

### 1.3 MEASUREMENT UNCERTAINTY

Measurement Uncertainty

Conducted Emission Expanded Uncertainty = 2.23dB, k=2

Radiated emission expanded uncertainty(9kHz-30MHz) = 3.08dB, k=2

Radiated emission expanded uncertainty(30MHz-1000MHz) = 4.42dB, k=2

Radiated emission expanded uncertainty(Above 1GHz) = 4.06dB, k=2



## 2. GENERAL INFORMATION

### 2.1 GENERAL DESCRIPTION OF EUT

<b>Operation Frequency</b>	2.402 GHz to 2.480GHz
<b>Maximum field strength</b>	99.56dBuV/m(Peak)@3m
<b>Bluetooth Version</b>	V5.0
<b>Modulation</b>	GFSK, $\pi/4$ -DQPSK, 8DPSK for BR/EDR
<b>Number of channels</b>	79 for BR/EDR
<b>Antenna Gain</b>	3.39dBi
<b>Antenna Designation</b>	Fixed Antenna (Met 15.203 Antenna requirement)
<b>Hardware Version</b>	V2
<b>Software Version</b>	V01
<b>Power Supply</b>	DC 3.7V by battery

Note: 1. The USB port only used for charging and can't be used to transfer data with PC.  
2. The BT function of EUT doesn't work when charging.  
3. The EUT doesn't support BLE.  
4. The EUT comprises left and right channel headsets, both are the same and have been tested. Only the test data of left headset recorded in this report.

#### BR/EDR channel List

Frequency Band	Channel Number	Frequency
2400~2483.5MHZ	00	2402MHZ
	01	2403MHZ
	:	:
	38	2440 MHZ
	39	2441 MHZ
	40	2442 MHZ
	:	:
	77	2479 MHZ
	78	2480 MHZ



## 2.2 OPERATION OF EUT DURING TESTING

NO.	TEST MODE DESCRIPTION
1	Low channel GFSK
2	Middle channel GFSK
3	High channel GFSK
4	Low channel $\pi/4$ -DQPSK
5	Middle channel $\pi/4$ -DQPSK
6	High channel $\pi/4$ -DQPSK
7	Low channel 8DPSK
8	Middle channel 8DPSK
9	High channel 8DPSK

Note:1. Only the data of the worst case recorded in the test report.

2. For Radiated Emission, 3axis were chosen for testing for each applicable mode.



### 2.3 DESCRIPTION OF TEST SETUP

Configure 1: (Normal hopping)



Configure 2: (Control continuous TX)

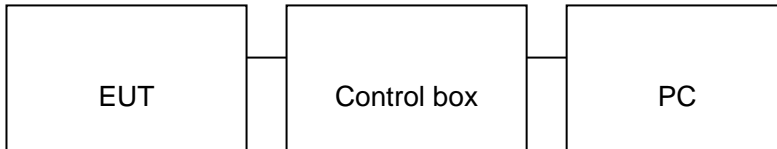

Item	Equipment	Mfr/Brand	Model/Type No.	Remark
1	TWS Bluetooth Headset	N/A	BS228GB	EUT
2	Battery	Golden	551213	Accessory
3	IPOD	APPLE	A1367	A.E
4	PC	APPLE	A1465	A.E
5	Control box	DOFLY	N/A	A.E
6	USB Cable	N/A	1m unshielded	A.E



## 2.4 MEASUREMENT INSTRUMENTS LIST

### TEST EQUIPMENT OF RADIATED EMISSION TEST

Item	Equipment	Manufacturer	Model No.	Lab Equipment No.	Last Cal.	Cal. Interval
1.	Spectrum analyzer	Agilent	N9020A	HKE-048	Dec. 27, 2018	1 Year
2.	Preamplifier	Schwarzbeck	BBV 9743	HKE-006	Dec. 27, 2018	1 Year
3.	EMI Test Receiver	Rohde & Schwarz	ESCI 7	HKE-010	Dec. 27, 2018	1 Year
4.	Bilog Broadband Antenna	Schwarzbeck	VULB9163	HKE-012	Dec. 27, 2018	1 Year
5.	Loop Antenna	Schwarzbeck	FMZB 1519 B	HKE-014	Dec. 27, 2018	1 Year
6.	Horn Antenna	Schwarzbeck	9120D	HKE-013	Dec. 27, 2018	1 Year
7.	Broad-band Horn Antenna	A-INFOMW	LB-180400-KF	HKE-031	Dec. 27, 2018	1 Year
8.	Pre-amplifier	EMCI	EMC051845SE	HKE-015	Dec. 27, 2018	1 Year
9.	Pre-amplifier	Agilent	83051A	HKE-016	Dec. 27, 2018	1 Year
10.	Filter (2.4-2.483GHz)	Micro-tronics	087	--	N/A	N/A
11.	Radiation Cable 1	MXT	HK1	R05	N/A	N/A
12.	Radiation Cable 2	MXT	HK1	R06	N/A	N/A





### 3. RADIATED EMISSION

#### 3.1. MEASUREMENT PROCEDURE

1. The EUT was placed on the top of the turntable 0.8 or 1.5 meter above ground. The phase center of the receiving antenna mounted on the top of a height-variable antenna tower was placed 3 meters far away from the turntable.
2. Power on the EUT and all the supporting units. The turntable was rotated by 360 degrees to determine the position of the highest radiation.
3. The height of the broadband receiving antenna was varied between one meter and four meters above ground to find the maximum emissions field strength of both horizontal and vertical polarization.
4. For each suspected emissions, the antenna tower was scan (from 1 M to 4 M) and then the turntable was rotated (from 0 degree to 360 degrees) to find the maximum reading.
5. Set the test-receiver system to Peak or CISPR quasi-peak Detect Function with specified bandwidth under Maximum Hold Mode.
6. For emissions above 1GHz, use 1MHz VBW and RBW for peak reading. Then 1MHz RBW and 10Hz VBW for average reading in spectrum analyzer. Place the measurement antenna away from each area of the EUT determined to be a source of emissions at the specified measurement distance, while keeping the measurement antenna aimed at the source of emissions at each frequency of significant emissions, with polarization oriented for maximum response. The measurement antenna may have to be higher or lower than the EUT, depending on the radiation pattern of the emission and staying aimed at the emission source for receiving the maximum signal. The final measurement antenna elevation shall be that which maximizes the emissions. The measurement antenna elevation for maximum emissions shall be restricted to a range of heights of from 1 m to 4 m above the ground or reference ground plane.
7. When the radiated emissions limits are expressed in terms of the average value of the emissions, and pulsed operation is employed, the measurement field strength shall be determined by averaging over one complete pulse train, including blanking intervals, as long as the pulse train does not exceed 0.1 seconds. As an alternative (provided the transmitter operates for longer than 0.1 seconds) or in cases where the pulse train exceeds 0.1 seconds, the measured field strength shall be determined from the average absolute voltage during a 0.1 second interval during which the field strength is at its maximum values.
8. If the emissions level of the EUT in peak mode was 3 dB lower than the average limit specified, then testing will be stopped and peak values of EUT will be reported, otherwise, the emissions which do not have 3 dB margin will be repeated one by one using the quasi-peak method for below 1GHz.
9. For testing above 1GHz, the emissions level of the EUT in peak mode was lower than average limit (that means the emissions level in peak mode also complies with the limit in average mode), then testing will be stopped and peak values of EUT will be reported, otherwise, the emissions will be measured in average mode again and reported.
10. In case the emission is lower than 30MHz, loop antenna has to be used for measurement and the recorded data should be QP measured by receiver. High - Low scan is not required in this case.



The following table is the setting of spectrum analyzer and receiver.

Spectrum Parameter	Setting
Start ~Stop Frequency	9KHz~150KHz/RBW 200Hz for QP
Start ~Stop Frequency	150KHz~30MHz/RBW 9KHz for QP
Start ~Stop Frequency	30MHz~1000MHz/RBW 120KHz for QP
Start ~Stop Frequency	1GHz~26.5GHz 1.5MHz/5MHz for Peak, 1.5MHz/10Hz for Average

Receiver Parameter	Setting
Start ~Stop Frequency	9KHz~150KHz/RBW 200Hz for QP
Start ~Stop Frequency	150KHz~30MHz/RBW 9KHz for QP
Start ~Stop Frequency	30MHz~1000MHz/RBW 120KHz for QP

**Test limit for Standard FCC15.249**

Fundamental Frequency	Field Strength of Fundamental (millivolts/meter)	Field Strength of Harmonics (microvolts/meter)
900-928MHz	50	500
2400-2483.5MHz	50	500
5725-5875MHz	50	500
24.0-24.25GHz	250	2500

**Test limit for Standard FCC 15.209**

Frequency (MHz)	Distance Meters	Field Strengths Limit	
		$\mu$ V/m	dB( $\mu$ V)/m
0.009 ~ 0.490	300	2400/F(kHz)	---
0.490 ~ 1.705	30	24000/F(kHz)	---
1.705 ~ 30	30	30	---
30 ~ 88	3	100	40.0
88 ~ 216	3	150	43.5
216 ~ 960	3	200	46.0
960 ~ 1000	3	500	54.0
Above 1000	3	Other:74.0 dB( $\mu$ V)/m (Peak) 54.0 dB( $\mu$ V)/m (Average)	

Remark: (1) Emission level dB  $\mu$  V = 20 log Emission level  $\mu$  V/m  
 (2) The smaller limit shall apply at the cross point between two frequency bands.  
 (3) Distance is the distance in meters between the measuring instrument, antenna and the closest point of any part of the device or system.

### 3.2. TEST SETUP

Radiated Emission Test-Setup Frequency Below 30MHz

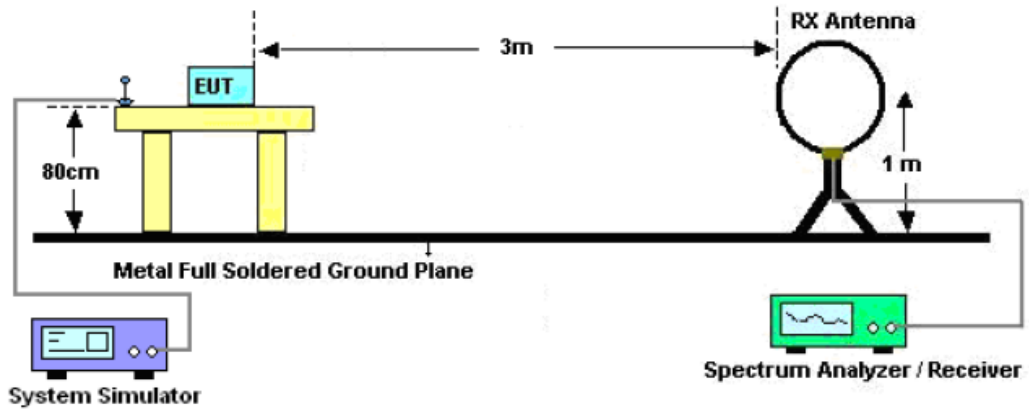

RADIATED EMISSION TEST SETUP 30MHz-1000MHz

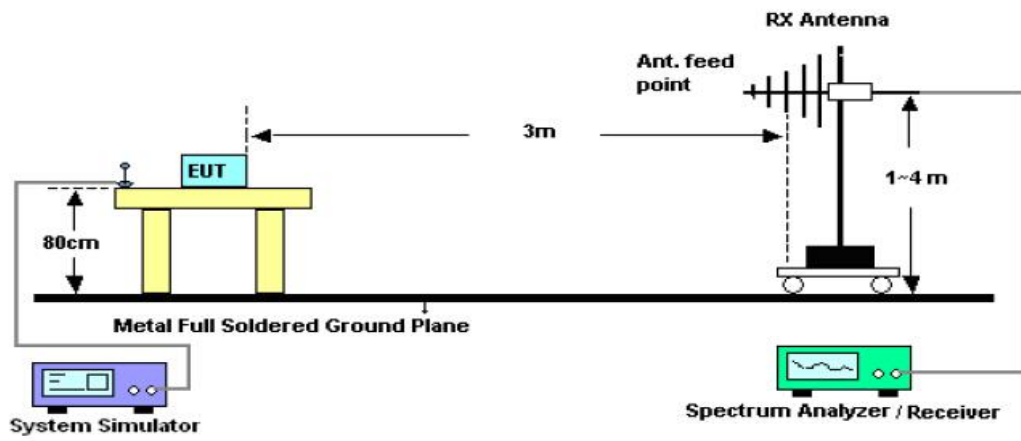

RADIATED EMISSION TEST SETUP ABOVE 1000MHz

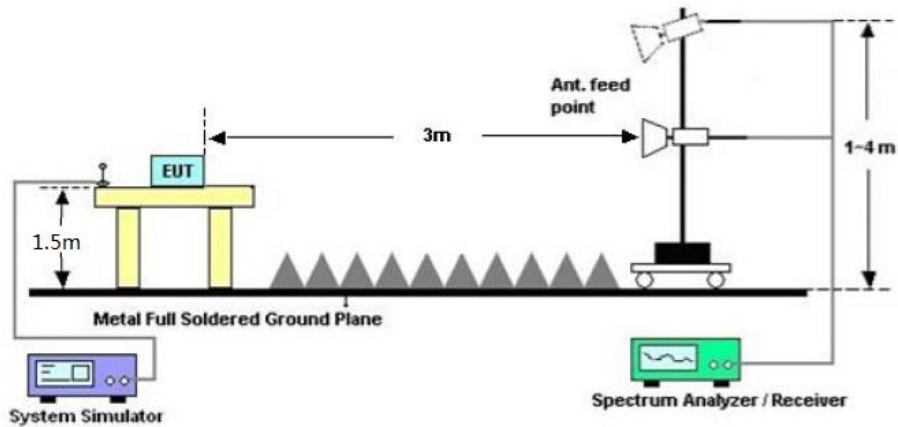



### 3.3. TEST RESULT

#### RADIATED EMISSION BELOW 30MHZ

No emission found between lowest internal used/generated frequencies to 30MHz.

#### RADIATED EMISSION 30MHZ- 1GHZ FOR BR/EDR

EUT :	TWS Bluetooth Headset	Model Name. :	BS228GB
Temperature :	20 °C	Relative Humidity :	48%
Pressure :	1010 hPa	Test Voltage :	DC 3.7V
Test Mode :	Mode 7	Polarization :	Horizontal

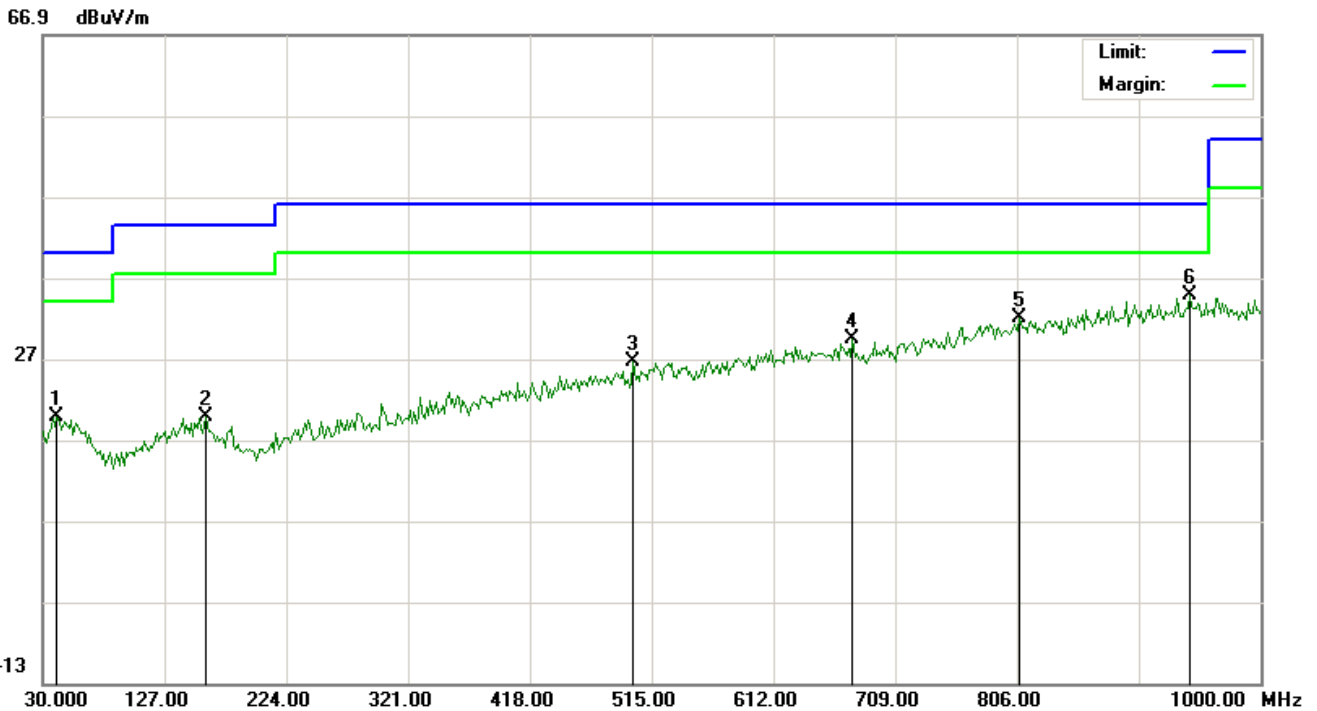

No.	Mk	Freq.	Reading	Factor	Measurement	Limit	Over	Detector	Antenna Height	Table Degree	Comment
		MHz	dBuV	dB/m	dBuV/m	dBuV/m	dB		cm	degree	
1		41.3167	-0.16	20.04	19.88	40.00	-20.12	peak			
2		159.3333	0.69	19.19	19.88	43.50	-23.62	peak			
3		500.4500	1.55	25.00	26.55	46.00	-19.45	peak			
4		675.0500	1.53	27.85	29.38	46.00	-16.62	peak			
5		807.6167	1.53	30.51	32.04	46.00	-13.96	peak			
6	*	943.4167	2.82	32.07	34.89	46.00	-11.11	peak			



EUT :	TWS Bluetooth Headset	Model Name. :	BS228GB
Temperature :	20 °C	Relative Humidity :	48%
Pressure :	1010 hPa	Test Voltage :	DC 3.7V
Test Mode :	Mode 7	Polarization :	Vertical

66.9 dBuV/m

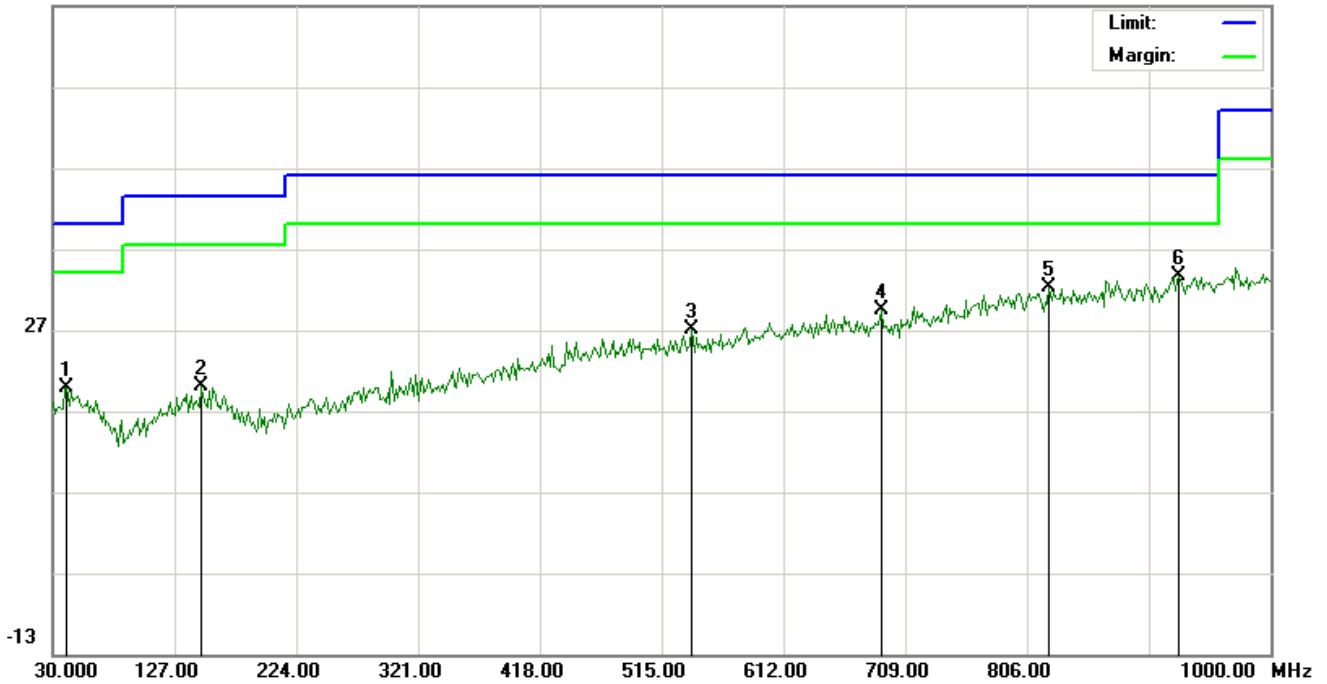

No.	Mk	Freq.	Reading	Factor	Measurement	Limit	Over	Detector	Antenna Height	Table Degree	Comment
		MHz	dBuV	dB/m	dBuV/m	dBuV/m	dB		cm	degree	
1		41.3167	-0.27	20.04	19.77	40.00	-20.23	peak			
2		148.0167	0.70	19.21	19.91	43.50	-23.59	peak			
3		539.2500	1.19	25.76	26.95	46.00	-19.05	peak			
4		689.6000	1.38	28.03	29.41	46.00	-16.59	peak			
5		823.7833	1.55	30.72	32.27	46.00	-13.73	peak			
6	*	927.2500	1.71	31.93	33.64	46.00	-12.36	peak			

**RESULT: PASS**

**Note:**

Factor=Antenna Factor + Cable loss, Margin=Result-Limit.

The "Factor" value can be calculated automatically by software of measurement system.

The mode 7 is the worst case, and only the data of the worst case recorded in this test report.

**FIELD STRENGTH OF FUNDAMENTAL FOR BR/EDR**

EUT :	TWS Bluetooth Headset	Model Name. :	BS228GB
Temperature :	20 °C	Relative Humidity :	48%
Pressure :	1010 hPa	Test Voltage :	DC 3.7V
Test Modulation :	GFSK	Polarization :	Horizontal

Frequency (MHz)	Meter Reading (dB $\mu$ V)	Factor (dB)	Emission Level (dB $\mu$ V/m)	Limits (dB $\mu$ V/m)	Margin (dB)	Value Type
2402.021	82.98	13.46	96.44	114.00	-17.56	peak
2402.021	75.20	13.46	88.66	94.00	-5.34	AVG
2441.021	83.40	13.88	97.28	114.00	-16.72	peak
2441.021	75.25	13.88	89.13	94.00	-4.87	AVG
2480.021	82.37	14.11	96.48	114.00	-17.52	peak
2480.021	74.63	14.11	88.74	94.00	-5.26	AVG

Remark:

Factor = Antenna Factor + Cable Loss – Pre-amplifier.

EUT :	TWS Bluetooth Headset	Model Name. :	BS228GB
Temperature :	20 °C	Relative Humidity :	48%
Pressure :	1010 hPa	Test Voltage :	DC 3.7V
Test Modulation :	GFSK	Polarization :	Vertical

Frequency (MHz)	Meter Reading (dB $\mu$ V)	Factor (dB)	Emission Level (dB $\mu$ V/m)	Limits (dB $\mu$ V/m)	Margin (dB)	Value Type
2402.021	82.15	13.46	95.61	114.00	-18.39	peak
2402.021	73.85	13.46	87.31	94.00	-6.69	AVG
2441.021	82.20	13.88	96.08	114.00	-17.92	peak
2441.021	74.55	13.88	88.43	94.00	-5.57	AVG
2480.021	81.59	14.11	95.70	114.00	-18.30	peak
2480.021	73.33	14.11	87.44	94.00	-6.56	AVG

Remark:

Factor = Antenna Factor + Cable Loss – Pre-amplifier.



EUT :	TWS Bluetooth Headset	Model Name. :	BS228GB
Temperature :	20 °C	Relative Humidity :	48%
Pressure :	1010 hPa	Test Voltage :	DC 3.7V
Test Modulation :	$\pi$ /4-DQPSK	Polarization :	Horizontal

Frequency (MHz)	Meter Reading (dB $\mu$ V)	Factor (dB)	Emission Level (dB $\mu$ V/m)	Limits (dB $\mu$ V/m)	Margin (dB)	Value Type
2402.021	84.97	13.46	98.43	114.00	-15.57	peak
2402.021	76.74	13.46	90.20	94.00	-3.80	AVG
2441.021	85.43	13.88	99.31	114.00	-14.69	peak
2441.021	77.30	13.88	91.18	94.00	-2.82	AVG
2480.021	85.49	14.11	99.60	114.00	-14.40	peak
2480.021	77.38	14.11	91.49	94.00	-2.51	AVG
Remark:						
Factor = Antenna Factor + Cable Loss – Pre-amplifier.						

EUT :	TWS Bluetooth Headset	Model Name. :	BS228GB
Temperature :	20 °C	Relative Humidity :	48%
Pressure :	1010 hPa	Test Voltage :	DC 3.7V
Test Modulation :	$\pi$ /4-DQPSK	Polarization :	Vertical

Frequency (MHz)	Meter Reading (dB $\mu$ V)	Factor (dB)	Emission Level (dB $\mu$ V/m)	Limits (dB $\mu$ V/m)	Margin (dB)	Value Type
2402.021	84.49	13.46	97.95	114.00	-16.05	peak
2402.021	76.44	13.46	89.90	94.00	-4.10	AVG
2441.021	84.71	13.88	98.59	114.00	-15.41	peak
2441.021	76.82	13.88	90.70	94.00	-3.30	AVG
2480.021	84.78	14.11	98.89	114.00	-15.11	peak
2480.021	77.05	14.11	91.16	94.00	-2.84	AVG
Remark:						
Factor = Antenna Factor + Cable Loss – Pre-amplifier.						



EUT :	TWS Bluetooth Headset	Model Name. :	BS228GB
Temperature :	20 °C	Relative Humidity :	48%
Pressure :	1010 hPa	Test Voltage :	DC 3.7V
Test Modulation :	8DPSK	Polarization :	Horizontal

Frequency (MHz)	Meter Reading (dBμV)	Factor (dB)	Emission Level (dBμV/m)	Limits (dBμV/m)	Margin (dB)	Value Type
2402.021	85.96	13.46	99.42	114.00	-14.58	peak
2402.021	77.52	13.46	90.98	94.00	-3.02	AVG
2441.021	85.52	13.88	99.40	114.00	-14.60	peak
2441.021	77.22	13.88	91.10	94.00	-2.90	AVG
2480.021	85.45	14.11	99.56	114.00	-14.44	peak
2480.021	77.71	14.11	91.82	94.00	-2.18	AVG
Remark:						
Factor = Antenna Factor + Cable Loss – Pre-amplifier.						

EUT :	TWS Bluetooth Headset	Model Name. :	BS228GB
Temperature :	20 °C	Relative Humidity :	48%
Pressure :	1010 hPa	Test Voltage :	DC 3.7V
Test Modulation :	8DPSK	Polarization :	Vertical

Frequency (MHz)	Meter Reading (dBμV)	Factor (dB)	Emission Level (dBμV/m)	Limits (dBμV/m)	Margin (dB)	Value Type
2402.021	84.22	13.46	97.68	114.00	-16.32	peak
2402.021	76.27	13.46	89.73	94.00	-4.27	AVG
2441.021	84.69	13.88	98.57	114.00	-15.43	peak
2441.021	76.96	13.88	90.84	94.00	-3.16	AVG
2480.021	84.91	14.11	99.02	114.00	-14.98	peak
2480.021	77.09	14.11	91.20	94.00	-2.80	AVG
Remark:						
Factor = Antenna Factor + Cable Loss – Pre-amplifier.						



**RADIATED EMISSION ABOVE 1GHZ FOR BR/EDR**

EUT :	TWS Bluetooth Headset	Model Name. :	BS228GB
Temperature :	20 °C	Relative Humidity :	48%
Pressure :	1010 hPa	Test Voltage :	DC 3.7V
Test Mode :	Mode 7	Polarization :	Horizontal

Frequency (MHz)	Meter Reading (dBμV)	Factor (dB)	Emission Level (dBμV/m)	Limits (dBμV/m)	Margin (dB)	Value Type
4804.026	43.93	7.12	51.05	74	-22.95	peak
4804.026	41.16	7.12	48.28	54	-5.72	AVG
7206.039	38.62	9.84	48.46	74	-25.54	peak
7206.039	35.26	9.84	45.1	54	-8.9	AVG

Remark:

Factor = Antenna Factor + Cable Loss – Pre-amplifier.

EUT :	TWS Bluetooth Headset	Model Name. :	BS228GB
Temperature :	20 °C	Relative Humidity :	48%
Pressure :	1010 hPa	Test Voltage :	DC 3.7V
Test Mode :	Mode 7	Polarization :	Vertical

Frequency (MHz)	Meter Reading (dBμV)	Factor (dB)	Emission Level (dBμV/m)	Limits (dBμV/m)	Margin (dB)	Value Type
4804.026	43.2	7.12	50.32	74	-23.68	peak
4804.026	40.08	7.12	47.2	54	-6.8	AVG
7206.039	38.31	9.84	48.15	74	-25.85	peak
7206.039	34.61	9.84	44.45	54	-9.55	AVG

Remark:

Factor = Antenna Factor + Cable Loss – Pre-amplifier.



EUT :	TWS Bluetooth Headset	Model Name. :	BS228GB
Temperature :	20 °C	Relative Humidity :	48%
Pressure :	1010 hPa	Test Voltage :	DC 3.7V
Test Mode :	Mode 8	Polarization :	Horizontal

Frequency	Meter Reading	Factor	Emission Level	Limits	Margin	Value Type
(MHz)	(dB $\mu$ V)	(dB)	(dB $\mu$ V/m)	(dB $\mu$ V/m)	(dB)	
4882.032	43.81	7.12	50.93	74	-23.07	peak
4882.032	40.76	7.12	47.88	54	-6.12	AVG
7323.048	38.35	9.84	48.19	74	-25.81	peak
7323.048	35.27	9.84	45.11	54	-8.89	AVG
Remark:						
Factor = Antenna Factor + Cable Loss – Pre-amplifier.						

EUT :	TWS Bluetooth Headset	Model Name. :	BS228GB
Temperature :	20 °C	Relative Humidity :	48%
Pressure :	1010 hPa	Test Voltage :	DC 3.7V
Test Mode :	Mode 8	Polarization :	Vertical

Frequency	Meter Reading	Factor	Emission Level	Limits	Margin	Value Type
(MHz)	(dB $\mu$ V)	(dB)	(dB $\mu$ V/m)	(dB $\mu$ V/m)	(dB)	
4882.032	43.5	7.12	50.62	74	-23.38	peak
4882.032	39.68	7.12	46.8	54	-7.2	AVG
7323.048	39.48	9.84	49.32	74	-24.68	peak
7323.048	36.39	9.84	46.23	54	-7.77	AVG
Remark:						
Factor = Antenna Factor + Cable Loss – Pre-amplifier.						



EUT :	TWS Bluetooth Headset	Model Name. :	BS228GB
Temperature :	20 °C	Relative Humidity :	48%
Pressure :	1010 hPa	Test Voltage :	DC 3.7V
Test Mode :	Mode 9	Polarization :	Horizontal

Frequency	Meter Reading	Factor	Emission Level	Limits	Margin	Value Type
(MHz)	(dBμV)	(dB)	(dBμV/m)	(dBμV/m)	(dB)	
4960.042	44.87	7.12	51.99	74	-22.01	peak
4960.042	41.59	7.12	48.71	54	-5.29	AVG
7440.063	39.93	9.84	49.77	74	-24.23	peak
7440.063	36.7	9.84	46.54	54	-7.46	AVG
Remark:						
Factor = Antenna Factor + Cable Loss – Pre-amplifier.						

EUT :	TWS Bluetooth Headset	Model Name. :	BS228GB
Temperature :	20 °C	Relative Humidity :	48%
Pressure :	1010 hPa	Test Voltage :	DC 3.7V
Test Mode :	Mode 9	Polarization :	Vertical

Frequency	Meter Reading	Factor	Emission Level	Limits	Margin	Value Type
(MHz)	(dBμV)	(dB)	(dBμV/m)	(dBμV/m)	(dB)	
4960.042	44.3	7.12	51.42	74	-22.58	peak
4960.042	39.87	7.12	46.99	54	-7.01	AVG
7440.063	39.1	9.84	48.94	74	-25.06	peak
7440.063	35.68	9.84	45.52	54	-8.48	AVG
Remark:						
Factor = Antenna Factor + Cable Loss – Pre-amplifier.						

**Note:** Other emissions from 8G to 25 GHz are considered as ambient noise. No recording in the test report.  
Factor=Antenna Factor + Cable loss - Amplifier gain, Margin=Measurement-Limit.  
The “Factor” value can be calculated automatically by software of measurement system.  
The 8DPSK modulation was the worst case and only the data of worst recorded in this report.

## 4. BAND EDGE EMISSION

### 4.1. MEASUREMENT PROCEDURE

1. The EUT operates at hopping-off test mode. The lowest or highest channels are tested to verify the largest transmission and spurious emissions power at the continuous transmission mode.
2. Max hold the trace of the setup 1, and the EUT operates at hopping-on test mode to verify the largest spurious emissions power.
3. Set the spectrum analyzer in the following setting in order to capture the lower and upper band-edges of the emission.

Start frequency(MHz)	Stop frequency(MHz)
2370	2405
2475	2500

### 4.2 TEST SETUP

RADIATED EMISSION TEST SETUP

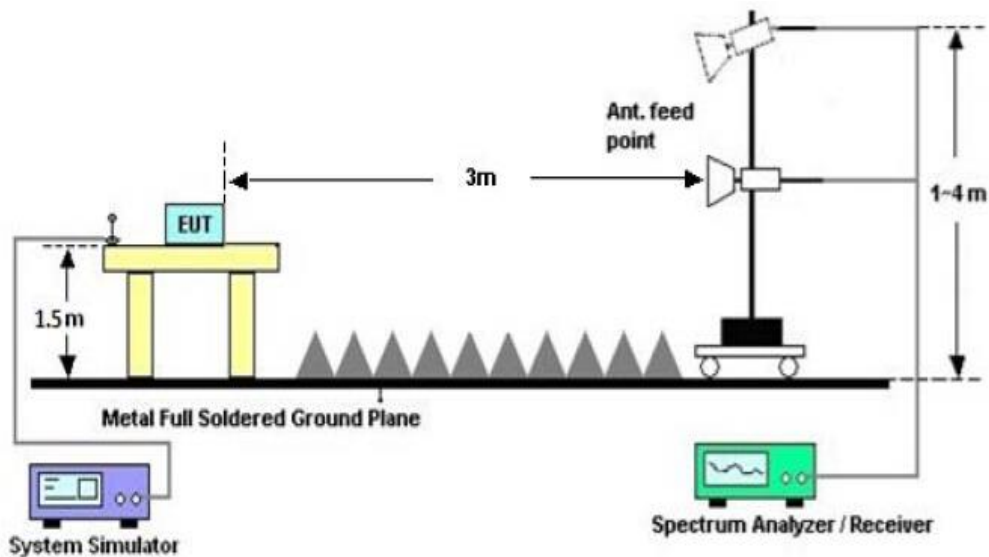



### 4.3 RADIATED TEST RESULT

#### TEST RESULT FOR RESTRICTED BANDS REQUIREMENTS

EUT :	TWS Bluetooth Headset	Model Name. :	BS228GB
Temperature :	20 °C	Relative Humidity:	48%
Pressure :	1010 hPa	Test Voltage :	DC 3.7V
Test Mode :	Mode 7	Polarization :	Horizontal

PK

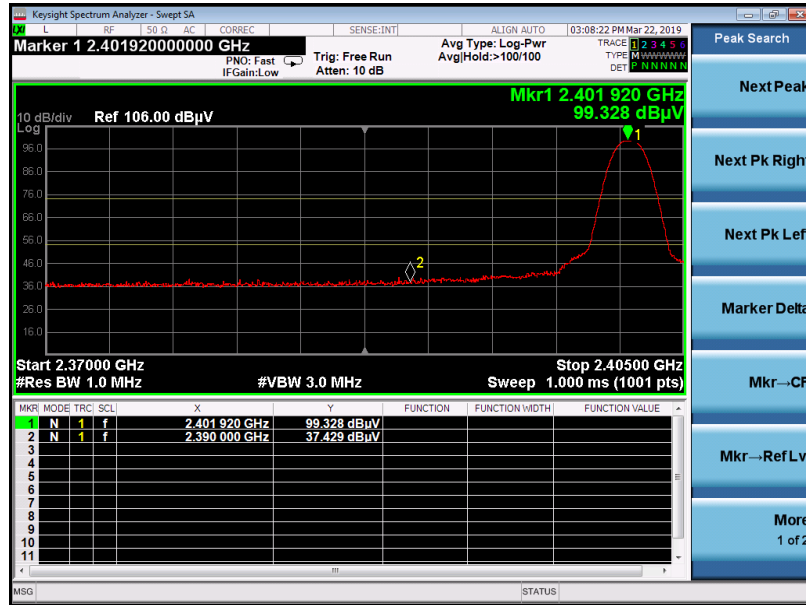

AV

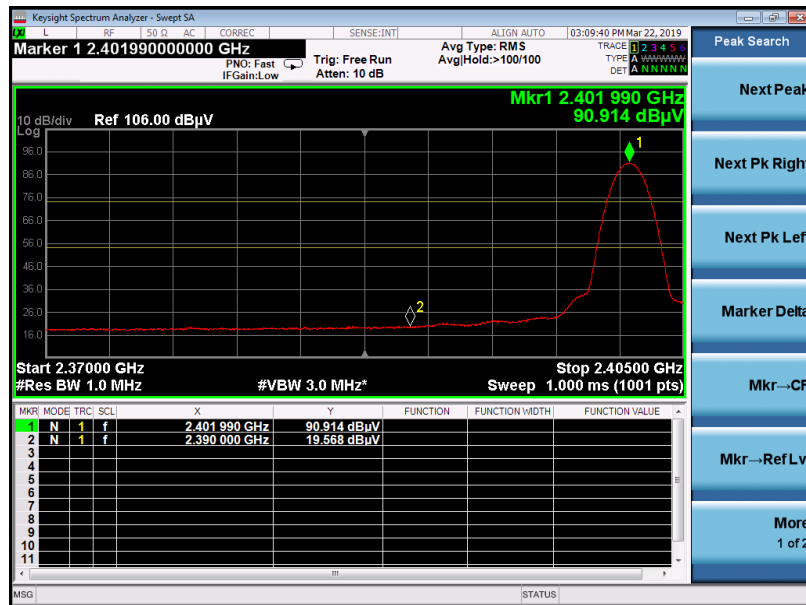

RESULT: PASS



EUT :	TWS Bluetooth Headset	Model Name. :	BS228GB
Temperature :	20 °C	Relative Humidity:	48%
Pressure :	1010 hPa	Test Voltage :	DC 3.7V
Test Mode :	Mode 7	Polarization :	Vertical

PK

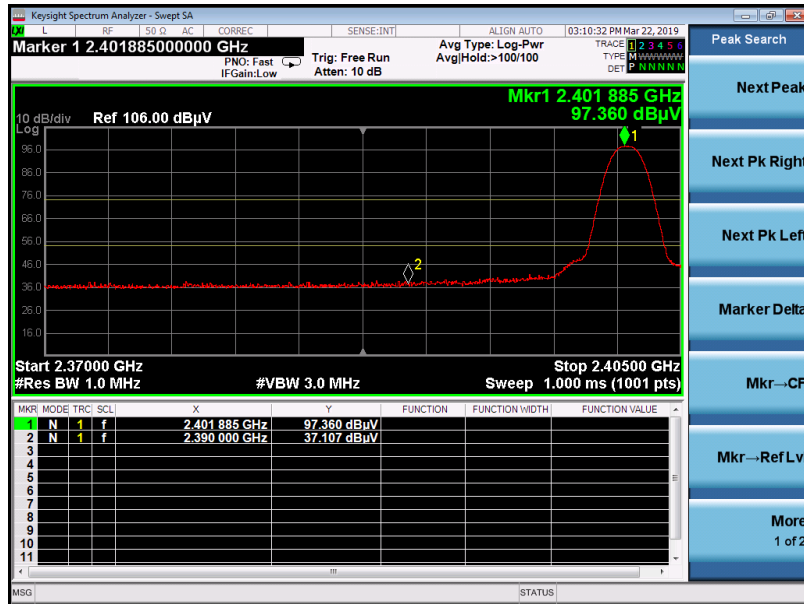

AV

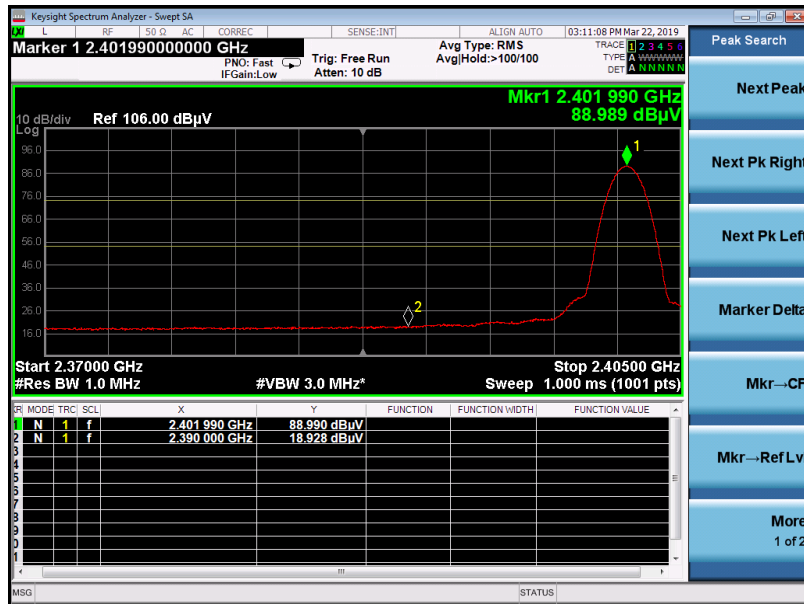

RESULT: PASS



EUT :	TWS Bluetooth Headset	Model Name. :	BS228GB
Temperature :	20 °C	Relative Humidity:	48%
Pressure :	1010 hPa	Test Voltage :	DC 3.7V
Test Mode :	Mode 9	Polarization :	Horizontal

PK

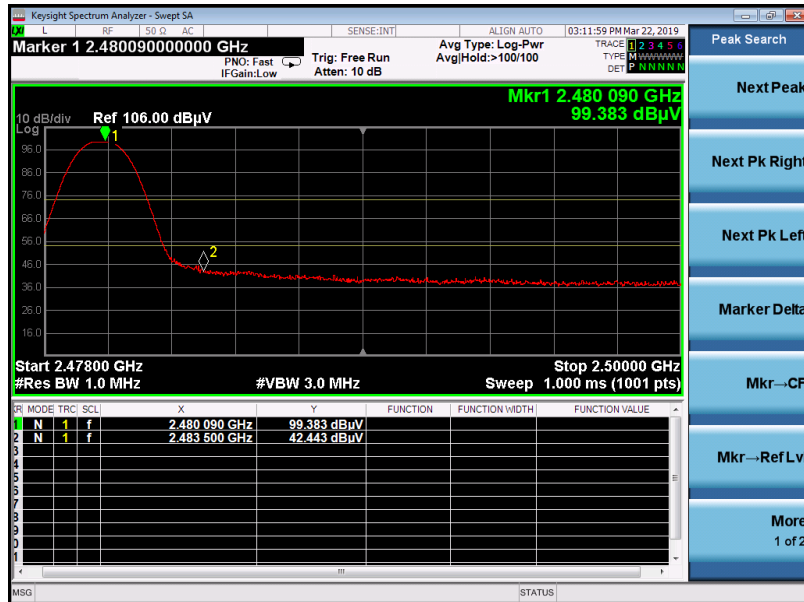

AV

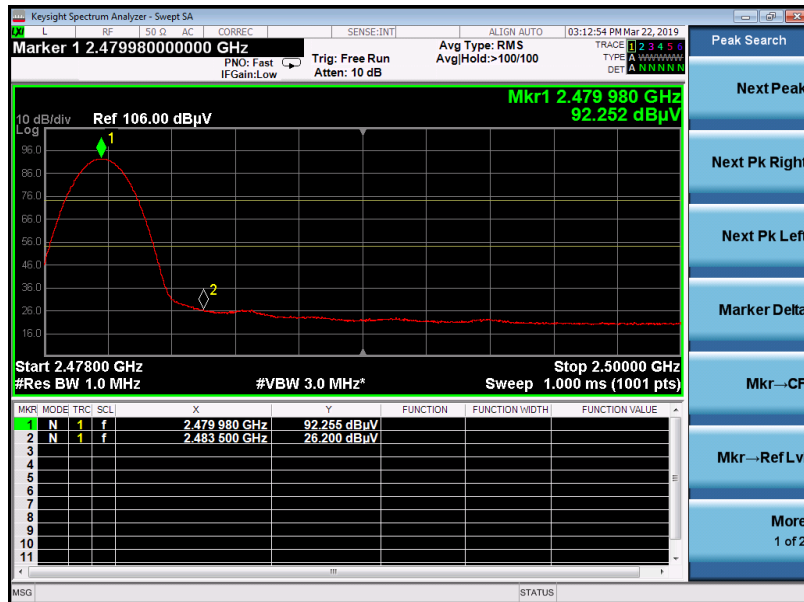

RESULT: PASS



EUT :	TWS Bluetooth Headset	Model Name. :	BS228GB
Temperature :	20 °C	Relative Humidity:	48%
Pressure :	1010 hPa	Test Voltage :	DC 3.7V
Test Mode :	Mode 9	Polarization :	Vertical

PK

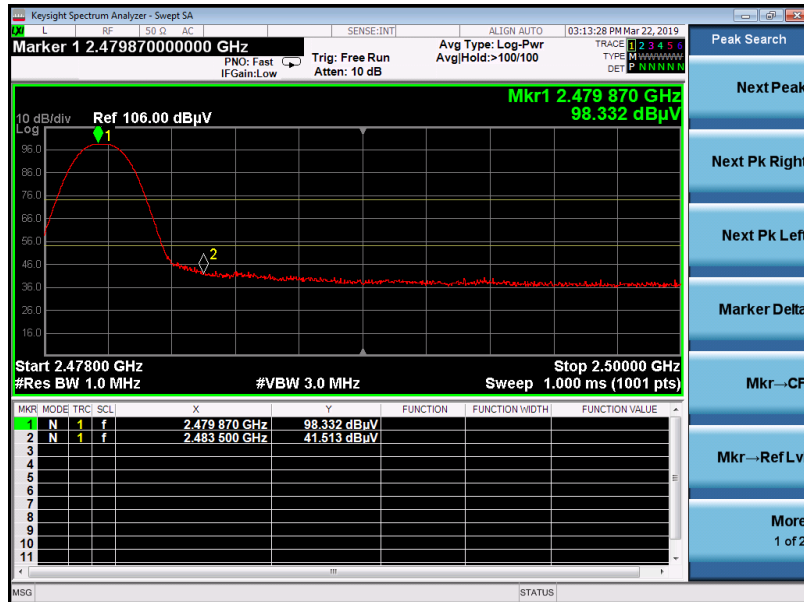

AV

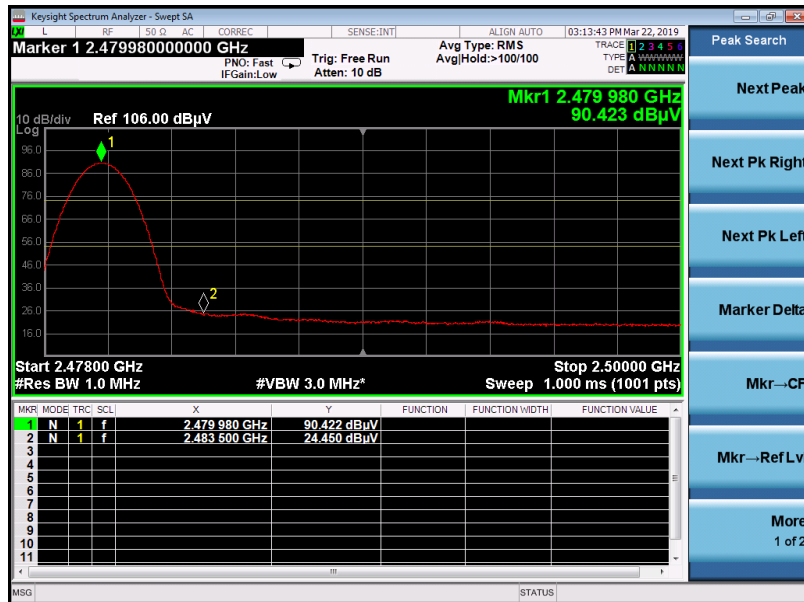

RESULT: PASS

**Note:** The factor had been edited in the “Input Correction” of the Spectrum Analyzer. So the Amplitude of test plots is equal to Reading level plus the Factor in dB. Use the A dB(µV) to represent the Amplitude. Use the F dB(µV/m) to represent the Field Strength. So A=F. All test modes had been pre-tested. The 8DPSK modulation is the worst case and recorded in the report.





## 5. BANDWIDTH

### 5.1. MEASUREMENT PROCEDURE

1. The EUT was placed on the top of the turntable 1.5 meter above ground. The phase center of the receiving antenna mounted on the top of a height-variable antenna tower was placed 3 meters far away from the turntable.
2. Set the EUT Work on the operation frequency individually.
3. Set Span = approximately 2 to 5 times the OBW, centered on a hopping channel  
The nominal IF filter bandwidth (3 dB RBW) shall be in the range of 1% to 5% of the OBW and video bandwidth (VBW) shall be approximately 3\* RBW; Sweep = auto; Detector function = peak
4. Set SPA Trace 1 Max hold, then View.

### 5.2. TEST SETUP

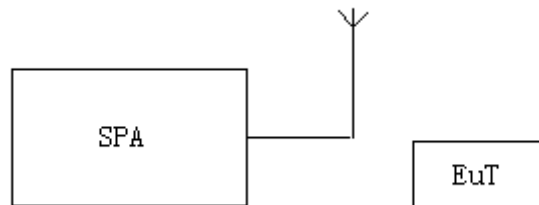



### 5.3. TEST RESULT

<b>TEST ITEM</b>	20DB BANDWIDTH
<b>TEST MODULATION</b>	GFSK for BR/EDR

Test Data (MHz)		Criteria
Low Channel	0.930	PASS
Middle Channel	0.929	PASS
High Channel	0.929	PASS

TEST PLOT OF BANDWIDTH FOR LOW CHANNEL





### TEST PLOT OF BANDWIDTH FOR MIDDLE CHANNEL

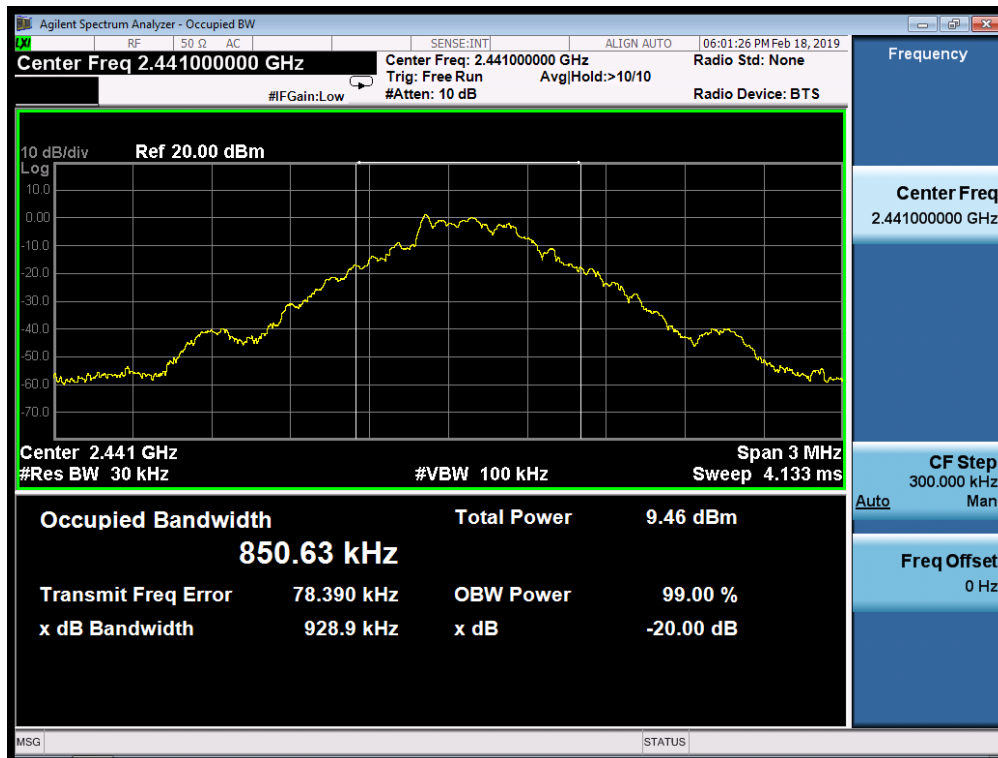

### TEST PLOT OF BANDWIDTH FOR HIGH CHANNEL

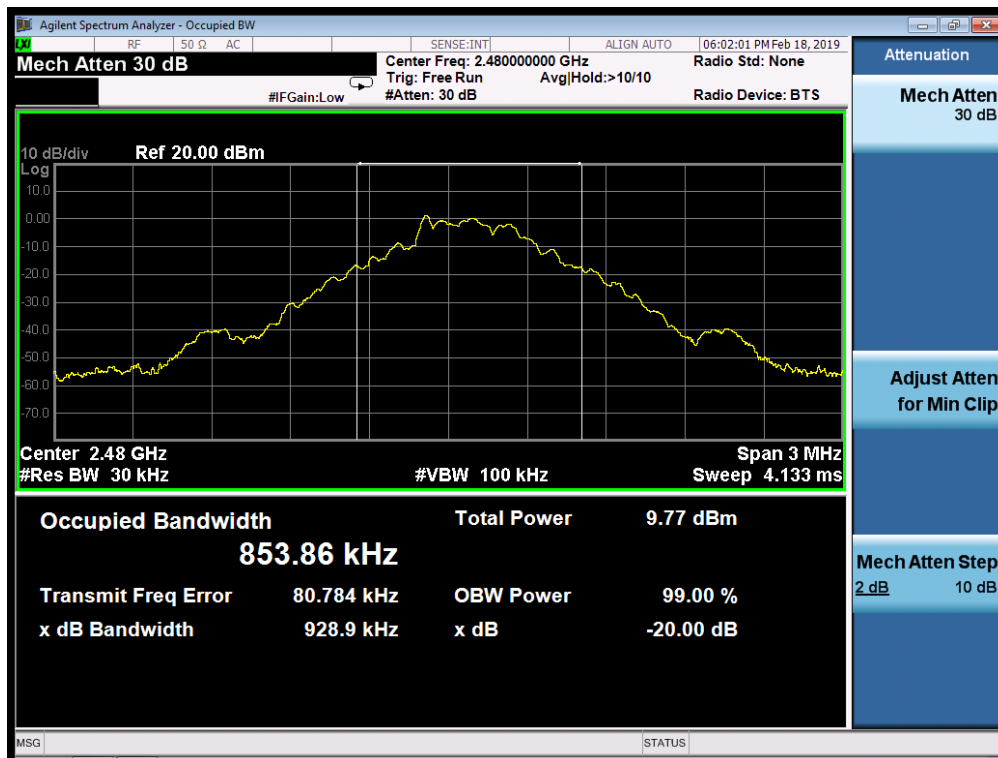



<b>TEST ITEM</b>	20DB BANDWIDTH
<b>TEST MODULATION</b>	$\pi$ /4-DQPSK for BR/EDR

Test Data (MHz)		Criteria
Low Channel	1.272	PASS
Middle Channel	1.276	PASS
High Channel	1.281	PASS

TEST PLOT OF BANDWIDTH FOR LOW CHANNEL

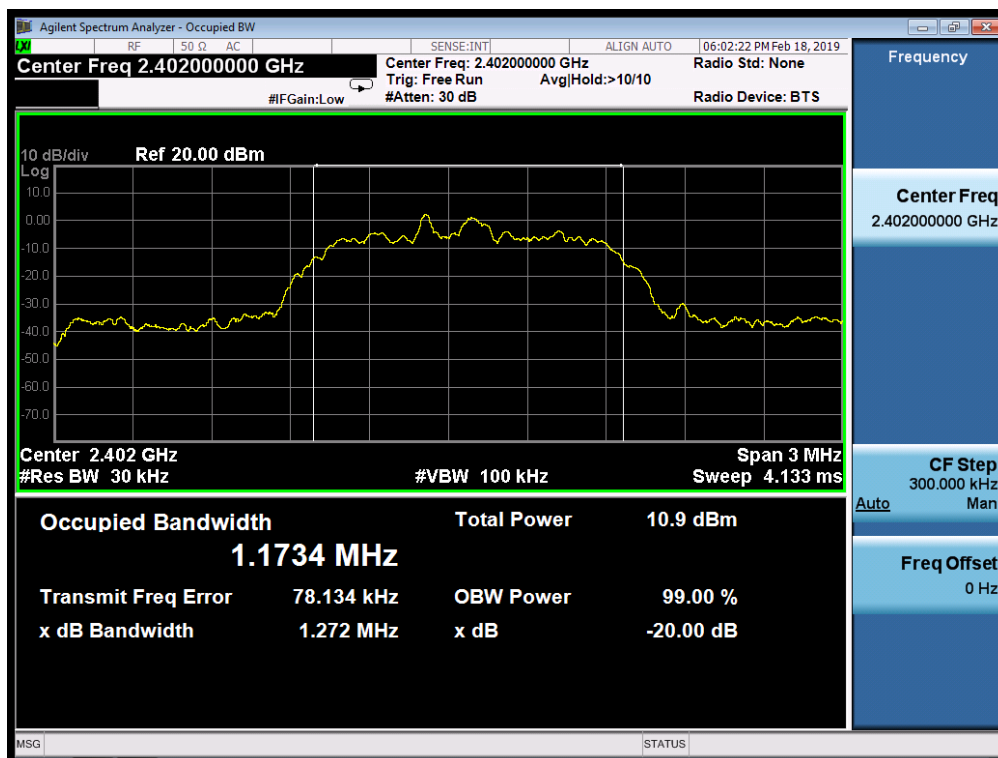



### TEST PLOT OF BANDWIDTH FOR MIDDLE CHANNEL

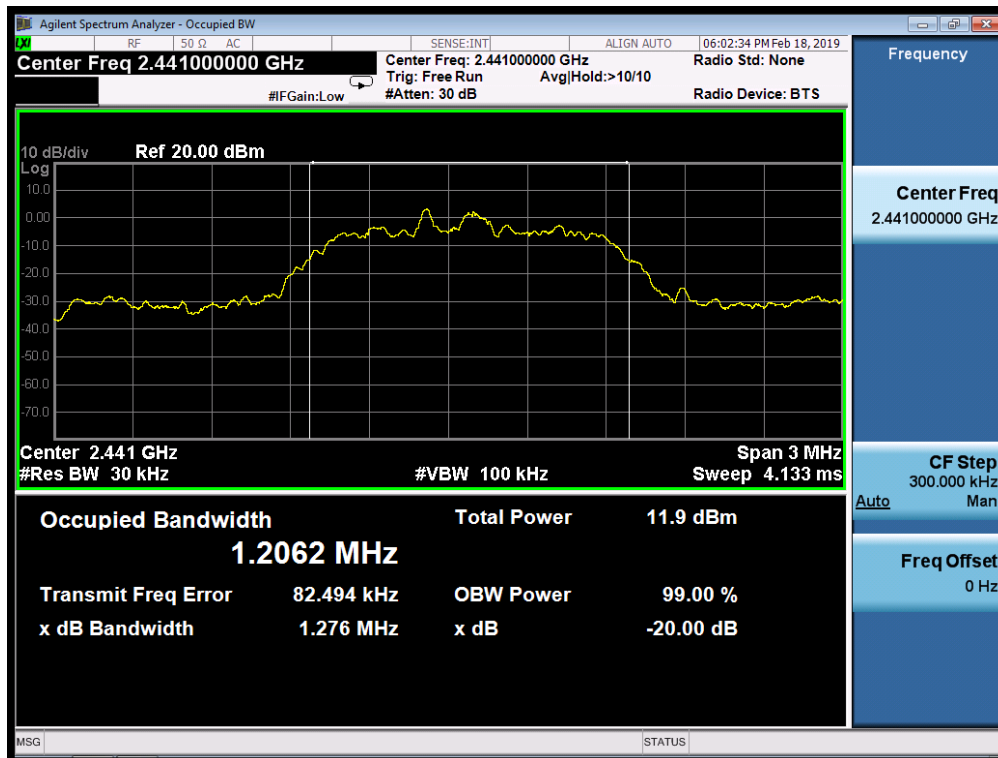

### TEST PLOT OF BANDWIDTH FOR HIGH CHANNEL





<b>TEST ITEM</b>	20DB BANDWIDTH
<b>TEST MODULATION</b>	8DPSK for BR/EDR

Test Data (MHz)		Criteria
Low Channel	1.289	PASS
Middle Channel	1.284	PASS
High Channel	1.291	PASS

TEST PLOT OF BANDWIDTH FOR LOW CHANNEL

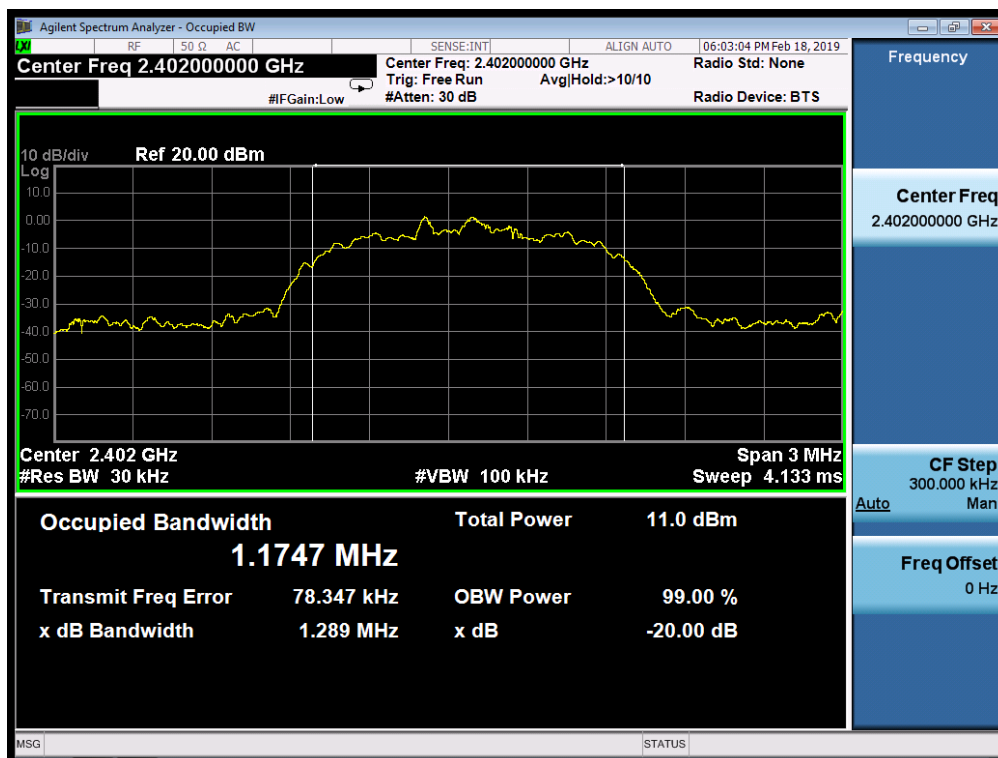



### TEST PLOT OF BANDWIDTH FOR MIDDLE CHANNEL

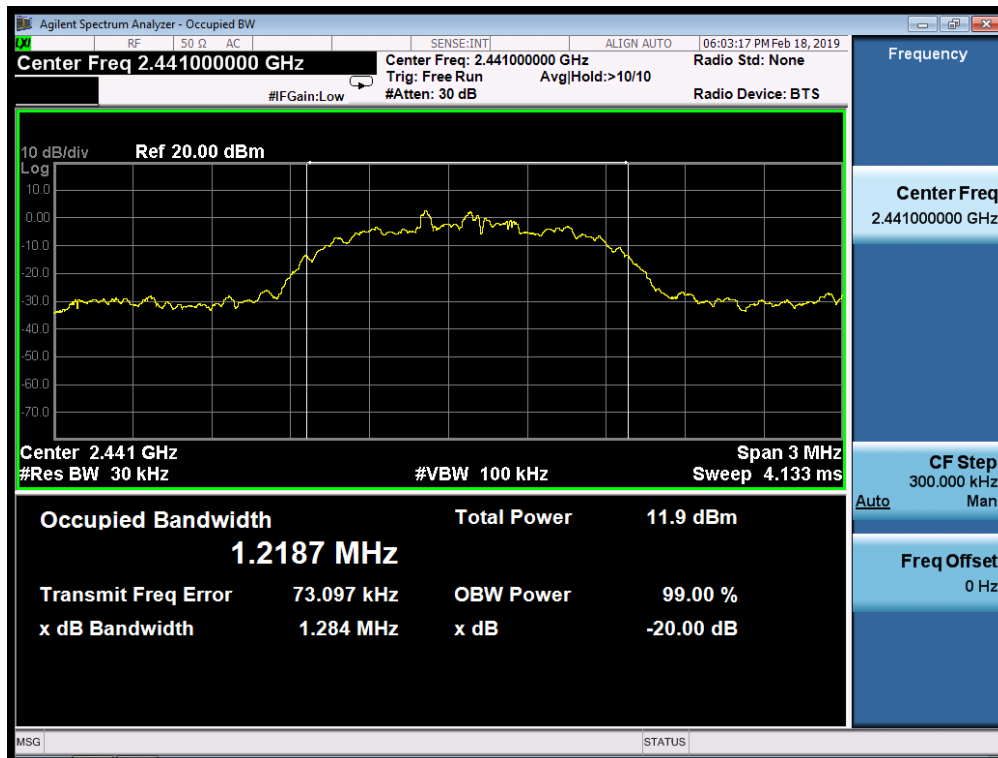

### TEST PLOT OF BANDWIDTH FOR HIGH CHANNEL

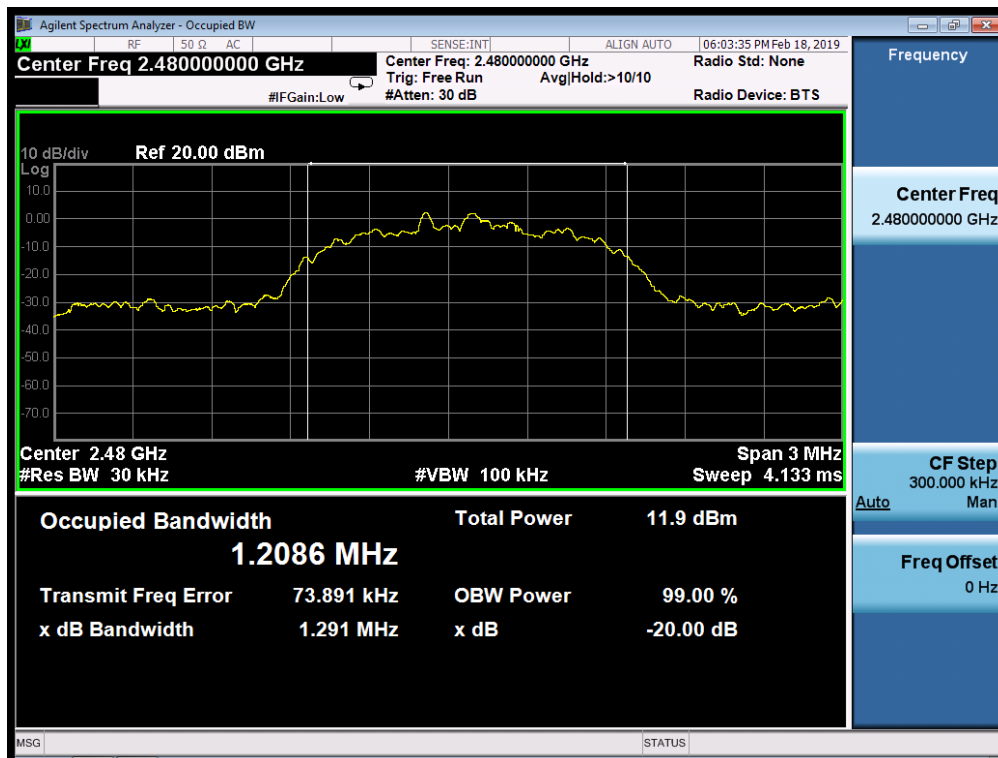

## 6. FCC LINE CONDUCTED EMISSION TEST

### 6.1. LIMITS OF LINE CONDUCTED EMISSION TEST

Frequency	Maximum RF Line Voltage	
	Q.P.( dBuV)	Average( dBuV)
150kHz~500kHz	66-56	56-46
500kHz~5MHz	56	46
5MHz~30MHz	60	50

Note:

1. The lower limit shall apply at the transition frequency.
2. The limit decreases linearly with the logarithm of the frequency in the range 0.15 MHz to 0.50 MHz.

### 6.2. BLOCK DIAGRAM OF LINE CONDUCTED EMISSION TEST

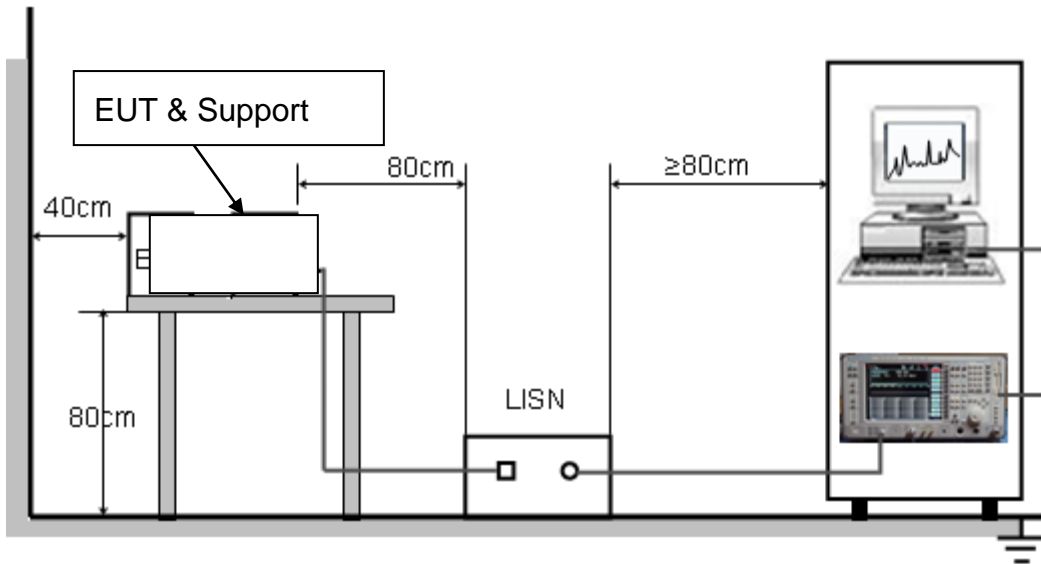





### **6.3. PRELIMINARY PROCEDURE OF LINE CONDUCTED EMISSION TEST**

1. The equipment was set up as per the test configuration to simulate typical actual usage per the user's manual. When the EUT is a tabletop system, a wooden table with a height of 0.8 meters is used and is placed on the ground plane as per ANSI C63.10 (see Test Facility for the dimensions of the ground plane used). When the EUT is a floor-standing equipment, it is placed on the ground plane which has a 3-12 mm non-conductive covering to insulate the EUT from the ground plane.
2. Support equipment, if needed, was placed as per ANSI C63.10.
3. All I/O cables were positioned to simulate typical actual usage as per ANSI C63.10.
4. All support equipments received AC120V/60Hz power from a LISN, if any.
5. The EUT received DC charging voltage by adapter or PC which received 120V/60Hz power by a LISN.
6. The test program was started. Emissions were measured on each current carrying line of the EUT using a spectrum Analyzer / Receiver connected to the LISN powering the EUT. The LISN has two monitoring points: Line 1 (Hot Side) and Line 2 (Neutral Side). Two scans were taken: one with Line 1 connected to Analyzer / Receiver and Line 2 connected to a 50 ohm load; the second scan had Line 1 connected to a 50 ohm load and Line 2 connected to the Analyzer / Receiver.
7. Analyzer / Receiver scanned from 150 kHz to 30MHz for emissions in each of the test modes.
8. During the above scans, the emissions were maximized by cable manipulation.
9. The test mode(s) were scanned during the preliminary test.

Then, the EUT configuration and cable configuration of the above highest emission level were recorded for reference of final testing.

### **6.4. FINAL PROCEDURE OF LINE CONDUCTED EMISSION TEST**

1. EUT and support equipment was set up on the test bench as per step 2 of the preliminary test.
2. A scan was taken on both power lines, Line 1 and Line 2, recording at least the six highest emissions. Emission frequency and amplitude were recorded into a computer in which correction factors were used to calculate the emission level and compare reading to the applicable limit. If EUT emission level was less  $-2\text{dB}$  to the A.V. limit in Peak mode, then the emission signal was re-checked using Q.P and Average detector.
3. The test data of the worst case condition(s) was reported on the Summary Data page.

### **6.5. TEST RESULT OF LINE CONDUCTED EMISSION TEST**

N/A

Note: The BT function of EUT doesn't work when charging.

## APPENDIX A: PHOTOGRAPHS OF TEST SETUP

### FCC RADIATED EMISSION TEST SETUP

