

BS220HA

TWS Bluetooth Headset

User Manual

Bluetooth headset should be used with the compatible devices which support Bluetooth wireless technology. This allows you to make two calls and enjoy the music streaming at any time freely. Please read this user manual carefully before using the headset, and also read your device's user manual regarding the Bluetooth function, and pay attention to those important safety and maintenance information.

Please keep the headset away from children.

Structure Sketch

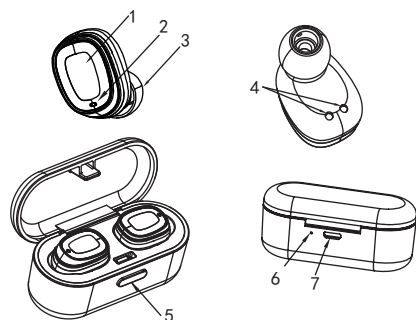

- 1) MFB(multifunction button)
- 2) Indicator light and MIC
- 3) Speaker
- 4) The charging contact point
- 5) ON/OFF
- 6) Charging indicator
- 7) Micro USB charging port

Specifications

Bluetooth Version :	V4.2
Bluetooth Profiles Supported :	HSP, HFP, A2DP, AVRCP
Audio Decoding Protocol :	SBC
Transmission Power :	Class 2
Operation Range :	Up to 10 meters
Frequency Range :	2.4GHz-2.48GHz
Battery of Headset :	45mAh Li-polymer Battery
Charging Voltage of Headset :	5V
Charging Time of Headset :	About 1.5 hours
Battery of Base :	460mAh Li-polymer Battery
Charging Voltage of Base :	5V
Charging Time of Base :	About 2 hours
Charging Headset Times from Charging Base :	2-3 times
Music Playing Time :	Up to 1.9 hours
Talk Time :	Up to 2 hours
Standby Time :	Up to 37 hours
Driver :	φ6mm
Driver sensitivity :	90±3dB
Driver impedance :	16Ω±15%
Driver frequency range :	20-20kHz
Dimensions of Charging Base(mm) :	L69×W30×H29.5
Dimensions of Headset(mm) :	L23.5×W17.1×H22.4
Weight(one headset) :	About 4.6g
Total Weight :	About 41g

*The time mentioned above may vary due to user's operation mode and device settings.

Status No.	Status	Charging Base Performance
1	The Single Pairing headset(R)	The indicator light of headset(R) flashes red and blue alternately
2	TWS Pairing	After TWS pairing succeeded, the indicator light of right headset alternately flashing red and blue, when the right headset pairing successful with mobile phone, the indicator light flashes blue once every 10 seconds
3	Standby Mode	The indicator light of the right headset flashes blue once every 10 seconds
4	Call Mode	When in a call, the indicator light of the right headset flashes red every 10 seconds
5	Headset Charging Mode	The indicator light of the headset is red when being charged, and will turn off automatically after being fully charged
6	Power Off State	The indicator light flashes red for three times.
7	Low Voltage Alarm State	The indicator light flashes red once every 20 seconds

Status No.	Status	Headset Performance
1	Charging Mode of the Charging Base	The indicator will be red during charging and will turn off after being fully charged

Identify according to L&R and wear the headset (R) and headset (L) respectively

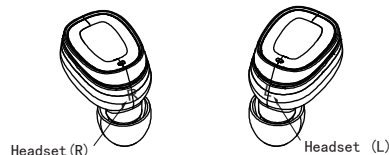

Wearing Steps:

Step ①

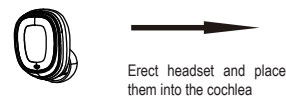

Erect headset and place them into the cochlea



Step ②

Slightly rotate headset until it firm



Step ③

Make the headset to cochlear edge tightly.

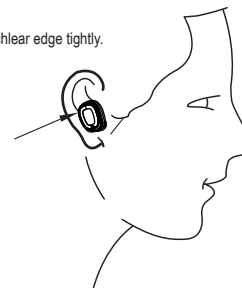

Charging Ways of Headset

The indicator light of headset is red when being charged, and will turn off automatically after being fully charged

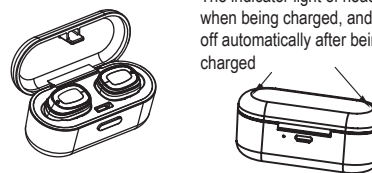

Put the headset (L) (R) to the corresponding position in the bottom of the charging base.

Charging Ways of Charging Base

Use the USB charging cable to charge

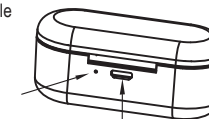

USB charging port

The indicator light of charging base is red when being charged, and will turn off automatically after being fully charged

Use the USB cable to connect with computer

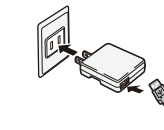
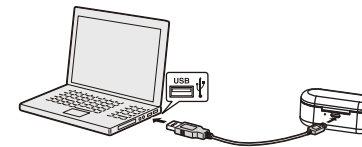

Use the USB cable to connect with mobile phone charger

- Note 1: Check the charging device is suit to the headset or not.
- Note 2: Use only the supplied charger to charge the headset, if use other device may violate the validation or the maintenance article of this product and may cause danger.
- Note 3: Do not attempt to force open the built-in battery as this could damage the headset.
- Note 4: A fully charged headset will lose its power automatically if left unused. It is recommended to charge the headset each three months.
- Note 5: Do not leave the headset in a too hot or too cold condition (best between -10°C and 50°C) which may affect the headset's operations although it is fully charged.
- Note 6: Do not dispose of the headset into fire or water.

Turning ON/OFF

1 Method

In OFF MODE, press and hold headset(R) or headset(L) MFB for 2 seconds to turn on.
In ON MODE, press and hold headset(R) or headset(L) MFB for 5 seconds to turn off.

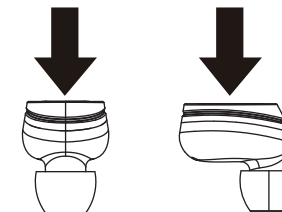

2 Method

Pick up the headsets from the charging base to turn on automatically. Put them back and close the case cover to power off.

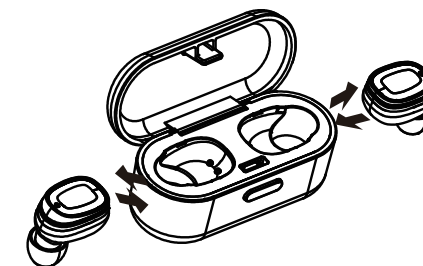

TWS Pairing

1

Pick up the two headsets from the charging base to power on and waiting for 10 seconds, the two headsets will enter auto-pairing mode. The two headsets connect



with each other after few seconds, the headset (R) alternately flashing red and blue, and then open the phone's bluetooth function to search.

2

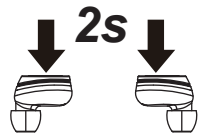

In OFF state, press MFB key for 2 seconds to power on and waiting for 10 seconds, the two headsets will enter auto-pairing mode. The two headsets connect with each other after few seconds, the headset (R) alternately flashing red and blue, and then open the phone's bluetooth function to search "BS220HA".

Do as the above ways: 1 or 2, after TWS successfully paired: left headset prompts "left channel" and right headset prompts "right channel-pairing"

Cell phone begins to search for bluetooth devices (see the user guide of your phone for instructions), and select "BS220HA" from bluetooth device list.

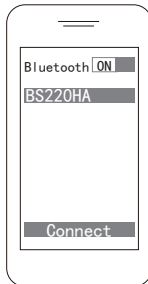

TWS Reconnected

Method1: Press and hold MFB of headset(R) or headset(L) for 2 seconds to power on—wait for few seconds, the two headsets connect automatically—the headset(R) pairs with the mobile phone that has ever paired after few seconds →reconnected successfully.

Method2: Pick up the headsets from charging base to power on—wait for few seconds, the two headsets connect automatically—the headset(R) pairs with the mobile phone that has ever paired after few seconds →reconnected successfully.

Note: The headset(R)(L)will prompt "connected", left headset prompts "left channel", the right headset prompts "right channel". After connected with mobile phone successfully, the right headset prompts "second device connected".

Answer /End a Call

When call incoming, short press MFB of headset (R) or headset (L) to answer the call when you hear "Du" once; In call mode, long press MFB of headset (R) or headset (L) for 2 seconds to end the call when you hear "Du" twice.



Reject a call



Press and hold MFB of headset(R) or headset(L) for 2 seconds to reject the call, the speaker prompts "Du" twice and "call reject".

Voice Dialing



On standby mode or music playing state, double click the MFB of headset(L) and you can hear "du" once.(This feature only supports phone with voice dialing function)

Two-call Handling

(Only support the mobile phone which has the function of handling two phones.)

When you are answering a call, there is another call coming:

1. Long press and hold MFB of headset(R) for 2 seconds to end the current call and answer the incoming call;
2. Short press MFB of headset(R) to hold the current call and answer the incoming call;
3. After the second implementation, double press MFB of headset(R) to switch between two calls;
4. After the second implementation, long press MFB of headset(R) for 2 seconds to end the current call, and long press MFB of headset(R) for 2 seconds to end the other call.

Note:

All the above operations have to respect the precondition that Phone supported Bluetooth hands free profile V1.5 and Phones are running under call holding function (Network services) from telecom.

Music Pause/Playing



In standby mode, shortly press MFB of headset(R) or headset(L) to play music. On music playing state, double-click MFB of headset(R) to PAUSE music. But headset(L) can not pause music independently.



Volume +/-

In call mode or music playing mode, short press MFB of headset(R) to volume up; short press MFB of headset(L) to volume down, when maximum or minimum volume, the speaker will prompt "Du".

Pre/Next Song

In music playing mode, long press MFB of headset(R) for 2 seconds to next song; long press MFB of headset(L) for 2 seconds to previous song.

Delete Pairing Records on the Headset

In OFF mode, press MFB of headset(R) or headset(L) for 10 seconds(OFF MODE→On Mode when 2nd second→Delete Pairing Records when 10th second) until hearing "du" 3 times and indicators flash red and blue twice at the same time.

Maintenance

- Do not use abrasive cleaning solvents to clean the headset.
- Do not allow the headset to touch with any sharp objects as this will cause scratching and damages.
- Please keep headset away from high-temperature, humidity and dust.

Trouble Shooting

Trouble	Reasons	Solutions
Can not turn on	low battery protection	Charging headsets for 1-2 hours
Can not turn on by picking up the headset/No indicator light when headset being charged	Charging base low battery protection	Charging both the headsets and charging base for 1-2 hours
No sounds after pairing	Wrong pairing	Pairing again
The two headsets TWS pairing failure/TWS paired successful but can not find the headset(R)	Too many pairing records	Delete pairing records
Charging base without indicator light when charging	DC power supply doesn't output power	Check whether the micro USB charging line is plugged well or not
Headsets without indicator light when charging	The headsets couldn't being charged in charging base	1)Checking headset charging interface whether has touched to POSO PIN of charging base and the location is correct or not. 2)Charging for charging base
Turning off automatically	Low battery	Charging headset for 1-2 hours
Headset echo	Volume is too loud or environment is noisy	Adjust the volume at phone or change a place
Noise in call	Environmental interference caused or distance between headset and mobile is too far	Change a place or move the headset close to the mobile phone
Low voice of the calling party	Wearing headset is wrong	Adjusting wearing position of headset

FCC Caution:

This device complies with part 15 of the FCC Rules. Operation is subject to the following two conditions: (1) This device may not cause harmful interference, and (2) this device must accept any interference received, including interference that may cause undesired operation.

Any changes or modifications not expressly approved by the party responsible for compliance could void the user's authority to operate the equipment.

NOTE: This equipment has been tested and found to comply with the limits for a Class B digital device, pursuant to Part 15 of the FCC Rules. These limits are designed to provide reasonable protection against harmful interference in a residential installation. This equipment generates, uses and can radiate radio frequency energy and, if not installed and used in accordance with the instructions, may cause harmful interference to radio communications. However, there is no guarantee that interference will not occur in a particular installation.

If this equipment does cause harmful interference to radio or television reception, which can be determined by turning the equipment off and on, the user is encouraged to try to correct the interference by one or more of the following measures:

- Reorient or relocate the receiving antenna.
- Increase the separation between the equipment and receiver.
- Connect the equipment into an outlet on a circuit different from that to which the receiver is connected.
- Consult the dealer or an experienced radio/TV technician for help.

The device has been evaluated to meet general RF exposure requirement. The device can be used in portable exposure condition without restriction.

FCC ID: 2AIXN-BS220HA