



# FCC RADIO TEST REPORT

**APPLICANT** : Udisense Inc. DBA: Nanit  
**EQUIPMENT** : Nanit Pro Baby Monitor  
**BRAND NAME** : Nanit  
**MODEL NAME** : N301  
**FCC ID** : 2AIWVN301  
**STANDARD** : FCC Part 15 Subpart C §15.247  
**CLASSIFICATION** : (DSS) Spread Spectrum Transmitter

The product was received on Aug. 15, 2020 and testing was completed on Sep. 10, 2020. We, Sporton International (Shenzhen) Inc., would like to declare that the tested sample has been evaluated in accordance with the test procedures and has been in compliance with the applicable technical standards.

The test results in this report apply exclusively to the tested model / sample. Without written approval of Sporton International (Shenzhen) Inc., the test report shall not be reproduced except in full.

Reviewed by: Derreck Chen / Supervisor

Approved by: Eric Shih / Manager

**Sporton International (ShenZhen) Inc.**



# TABLE OF CONTENTS

**REVISION HISTORY.....3**

**SUMMARY OF TEST RESULT .....4**

**1 GENERAL DESCRIPTION.....5**

1.1 Applicant .....5

1.2 Manufacturer.....5

1.3 Product Feature of Equipment Under Test.....5

1.4 Product Specification of Equipment Under Test.....5

1.5 Modification of EUT .....6

1.6 Testing Location .....6

1.7 Test Software.....6

1.8 Applicable Standards.....7

**2 TEST CONFIGURATION OF EQUIPMENT UNDER TEST.....8**

2.1 Carrier Frequency Channel .....8

2.2 Test Mode.....9

2.3 Connection Diagram of Test System.....10

2.4 EUT Operation Test Setup .....11

2.5 Measurement Results Explanation Example.....11

**3 TEST RESULT .....12**

3.1 Number of Channel Measurement .....12

3.2 Hopping Channel Separation Measurement .....14

3.3 Dwell Time Measurement.....20

3.4 20dB and 99% Bandwidth Measurement .....22

3.5 Output Power Measurement.....33

3.6 Conducted Band Edges Measurement .....34

3.7 Conducted Spurious Emission Measurement .....41

3.8 Radiated Band Edges and Spurious Emission Measurement .....51

3.9 AC Conducted Emission Measurement.....55

3.10 Antenna Requirements.....57

**4 LIST OF MEASURING EQUIPMENT.....58**

**5 UNCERTAINTY OF EVALUATION.....59**

**APPENDIX A. CONDUCTED TEST RESULTS**

**APPENDIX B. AC CONDUCTED EMISSION TEST RESULT**

**APPENDIX C. RADIATED SPURIOUS EMISSION**

**APPENDIX D. DUTY CYCLE PLOTS**

**APPENDIX E. SETUP PHOTOGRAPHS**



### **REVISION HISTORY**

<b>REPORT NO.</b>	<b>VERSION</b>	<b>DESCRIPTION</b>	<b>ISSUED DATE</b>
FR081502A	Rev. 01	Initial issue of report	Sep. 18, 2020



### SUMMARY OF TEST RESULT

Report Section	FCC Rule	Description	Limit	Result	Remark
3.1	15.247(a)(1)	Number of Channels	≥ 15Chs	Pass	-
3.2	15.247(a)(1)	Hopping Channel Separation	≥ 2/3 of 20dB BW	Pass	-
3.3	15.247(a)(1)	Dwell Time of Each Channel	≤ 0.4sec in 31.6sec period	Pass	-
3.4	15.247(a)(1)	20dB Bandwidth	NA	Pass	-
3.4	-	99% Bandwidth	-	Pass	-
3.5	15.247(b)(1)	Peak Output Power	≤ 125 mW	Pass	-
3.6	15.247(d)	Conducted Band Edges	≤ 20dBc	Pass	-
3.7	15.247(d)	Conducted Spurious Emission	≤ 20dBc	Pass	-
3.8	15.247(d)	Radiated Band Edges and Radiated Spurious Emission	15.209(a) & 15.247(d)	Pass	Under limit 8.82 dB at 79.47 MHz
3.9	15.207	AC Conducted Emission	15.207(a)	Pass	Under limit 16.80 dB at 0.617 MHz
3.10	15.203 & 15.247(b)	Antenna Requirement	N/A	Pass	-

**Declaration of Conformity:**

The test results with all measurement uncertainty excluded are presented in accordance with the regulation limits or requirements declared by manufacturers.

**Comments and Explanations:**

The declared of product specification for EUT presented in the report are provided by the manufacturer, and the manufacturer takes all the responsibilities for the accuracy of product specification.



# 1 General Description

## 1.1 Applicant

Udisense Inc. DBA: Nanit

244 Fifth Avenue Suite #2702, New York, NY, United States 10001

## 1.2 Manufacturer

WISTRON CORPORATION

21F, No. 88, Sec. 1, Hsin Tai Wu Rd., Hsichih Dist, New Taipei City 221, Taiwan (R.O.C.)

## 1.3 Product Feature of Equipment Under Test

Product Feature	
Equipment	Nanit Pro Baby Monitor
Brand Name	Nanit
Model Name	N301
FCC ID	2AIWVN301
EUT supports Radios application	WLAN 2.4GHz 802.11b/g/n HT20/HT40 WLAN 5GHz 802.11a/n HT20/HT40 WLAN 5GHz 802.11ac VHT20/VHT40/VHT80 Bluetooth BR/EDR/LE
HW Version	20H000-1A
SW Version	Linux Ambarella 4.9.202
EUT Stage	Production Unit

Remark: The above EUT's information was declared by manufacturer. Please refer to the specifications or user's manual for more detailed description.

## 1.4 Product Specification of Equipment Under Test

Standards-related Product Specification	
Tx/Rx Frequency Range	2402 MHz ~ 2480 MHz
Number of Channels	79
Carrier Frequency of Each Channel	2402+n*1 MHz; n=0~78
Maximum Output Power to Antenna	Bluetooth BR(1Mbps) : 7.7 dBm (0.0059 W) Bluetooth EDR (2Mbps) : 9.8 dBm (0.0095 W) Bluetooth EDR (3Mbps) : 10.4 dBm (0.0110 W)
99% Occupied Bandwidth	Bluetooth BR(1Mbps) : 0.845MHz Bluetooth EDR (2Mbps) : 1.152MHz Bluetooth EDR (3Mbps) : 1.129MHz
Antenna Type / Gain	Dipole Antenna type with gain 3.9 dBi
Type of Modulation	Bluetooth BR (1Mbps) : GFSK Bluetooth EDR (2Mbps) : π/4-DQPSK Bluetooth EDR (3Mbps) : 8-DPSK



### 1.5 Modification of EUT

No modifications are made to the EUT during all test items.

### 1.6 Testing Location

This report contains data that were produced under subcontract by Sporton International (Kunshan) Inc. Sporton International (Kunshan) Inc. is accredited to ISO/IEC 17025:2017 by American Association for Laboratory Accreditation with Certificate Number 5145.02.

<b>Test Firm</b>	Sporton International (Kunshan) Inc.		
<b>Test Site Location</b>	No. 1098, Pengxi North Road, Kunshan Economic Development Zone Jiangsu Province 215300 People's Republic of China TEL : +86-512-57900158 FAX : +86-512-57900958		
<b>Test Site No.</b>	<b>Sporton Site No.</b>	<b>FCC Designation No.</b>	<b>FCC Test Firm Registration No.</b>
	CO01-KS 03CH05-KS	CN1257	314309

Sporton International (Shenzhen) Inc. is accredited to ISO/IEC 17025:2017 by American Association for Laboratory Accreditation with Certificate Number 5145.01.

<b>Test Firm</b>	Sporton International (Shenzhen) Inc.		
<b>Test Site Location</b>	1/F, 2/F, Bldg 5, Shiling Industrial Zone, Xinwei Village, Xili, Nanshan, Shenzhen, 518055 People's Republic of China TEL: +86-755-86379589 FAX: +86-755-86379595		
<b>Test Site No.</b>	<b>Sporton Site No.</b>	<b>FCC Designation No.</b>	<b>FCC Test Firm Registration No.</b>
	TH01-SZ	CN1256	421272

### 1.7 Test Software

Item	Site	Manufacture	Name	Version
1.	03CH05-KS	AUDIX	E3	6.2009-8-24al
2.	CO01-KS	AUDIX	E3	6.2009-8-24



## **1.8 Applicable Standards**

According to the specifications of the manufacturer, the EUT must comply with the requirements of the following standards:

- ♦ 47 CFR Part 15 Subpart C §15.247
- ♦ FCC KDB 558074 D01 15.247 Meas Guidance v05r02
- ♦ ANSI C63.10-2013

### **Remark:**

1. All test items were verified and recorded according to the standards and without any deviation during the test.
2. This EUT has also been tested and complied with the requirements of FCC Part 15, Subpart B, recorded in a separate test report.



## 2 Test Configuration of Equipment Under Test

### 2.1 Carrier Frequency Channel

Frequency Band	Channel	Freq. (MHz)	Channel	Freq. (MHz)	Channel	Freq. (MHz)
2400-2483.5 MHz	0	2402	27	2429	54	2456
	1	2403	28	2430	55	2457
	2	2404	29	2431	56	2458
	3	2405	30	2432	57	2459
	4	2406	31	2433	58	2460
	5	2407	32	2434	59	2461
	6	2408	33	2435	60	2462
	7	2409	34	2436	61	2463
	8	2410	35	2437	62	2464
	9	2411	36	2438	63	2465
	10	2412	37	2439	64	2466
	11	2413	38	2440	65	2467
	12	2414	39	2441	66	2468
	13	2415	40	2442	67	2469
	14	2416	41	2443	68	2470
	15	2417	42	2444	69	2471
	16	2418	43	2445	70	2472
	17	2419	44	2446	71	2473
	18	2420	45	2447	72	2474
	19	2421	46	2448	73	2475
	20	2422	47	2449	74	2476
	21	2423	48	2450	75	2477
	22	2424	49	2451	76	2478
	23	2425	50	2452	77	2479
	24	2426	51	2453	78	2480
	25	2427	52	2454	-	-
	26	2428	53	2455	-	-





## 2.2 Test Mode

- a. The EUT has been associated with peripherals and configuration operated in a manner tended to maximize its emission characteristics in a typical application. Frequency range investigated: conduction emission (150 kHz to 30 MHz), radiation emission (9 kHz to the 10th harmonic of the highest fundamental frequency or to 40 GHz, whichever is lower). For radiated measurement, pre-scanned in three orthogonal panels, X, Y, Z. The worst cases (X plane) were recorded in this report, and the worst mode of radiated spurious emissions is Bluetooth 3Mbps mode, and recorded in this report.
- b. AC power line Conducted Emission was tested under maximum output power.

The following summary table is showing all test modes to demonstrate in compliance with the standard.

Summary table of Test Cases			
Test Item	Data Rate / Modulation		
	Bluetooth BR 1Mbps GFSK	Bluetooth EDR 2Mbps π/4-DQPSK	Bluetooth EDR 3Mbps 8-DPSK
Conducted Test Cases	Mode 1: CH00_2402 MHz	Mode 4: CH00_2402 MHz	Mode 7: CH00_2402 MHz
	Mode 2: CH39_2441 MHz	Mode 5: CH39_2441 MHz	Mode 8: CH39_2441 MHz
	Mode 3: CH78_2480 MHz	Mode 6: CH78_2480 MHz	Mode 9: CH78_2480 MHz
Radiated Test Cases	Bluetooth EDR 3Mbps 8-DPSK		
	Mode 1: CH00_2402 MHz		
	Mode 2: CH39_2441 MHz		
Mode 3: CH78_2480 MHz			
AC Conducted Emission	Mode 1 : WLAN ( 2.4G ) Link + Bluetooth Link +Multi Stand		
	Mode 2 : WLAN ( 2.4G ) Link + Bluetooth Link + Floor Stand		
	Mode 3 : WLAN ( 2.4G ) Link + Bluetooth Link + Wall Mount		
<b>Remark:</b> <ol style="list-style-type: none"> <li>1. For radiated test cases, the worst mode data rate 3Mbps was reported only, because this data rate has the highest RF output power at preliminary tests, and no other significantly frequencies found in conducted spurious emission.</li> <li>2. For Radiated Test Cases, The tests were performed with notebook.</li> <li>3. For AC Conducted Test Cases, The tests were performed with Adapter and USB Cable, and the worst mode is mode 1.</li> </ol>			

## 2.3 Connection Diagram of Test System

For Radiation

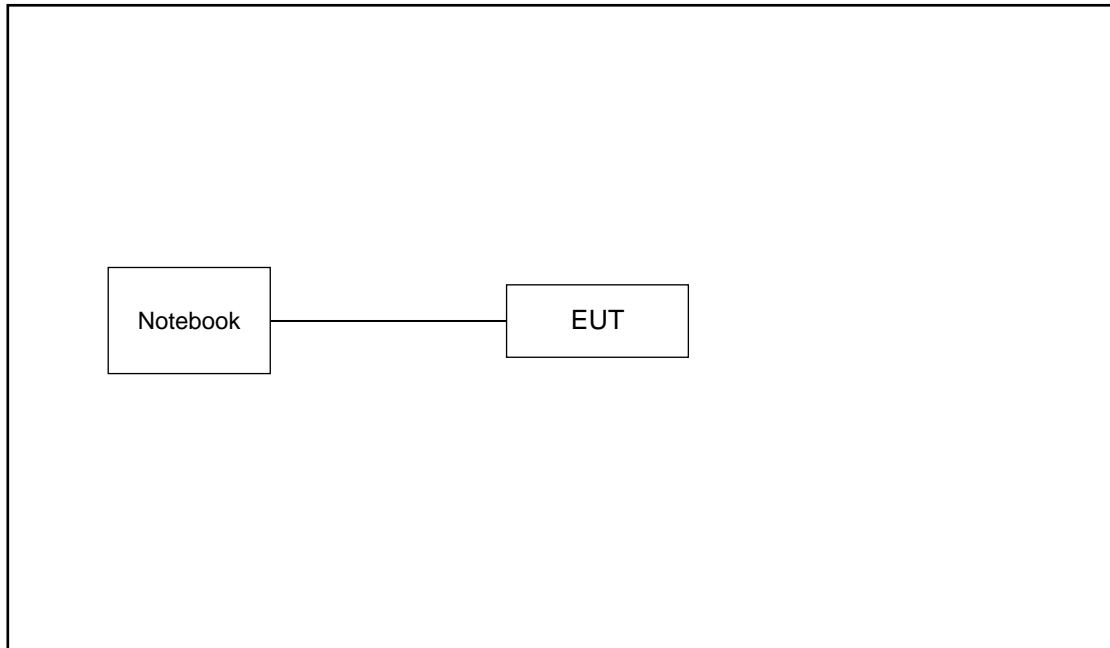

For Conducted Emission

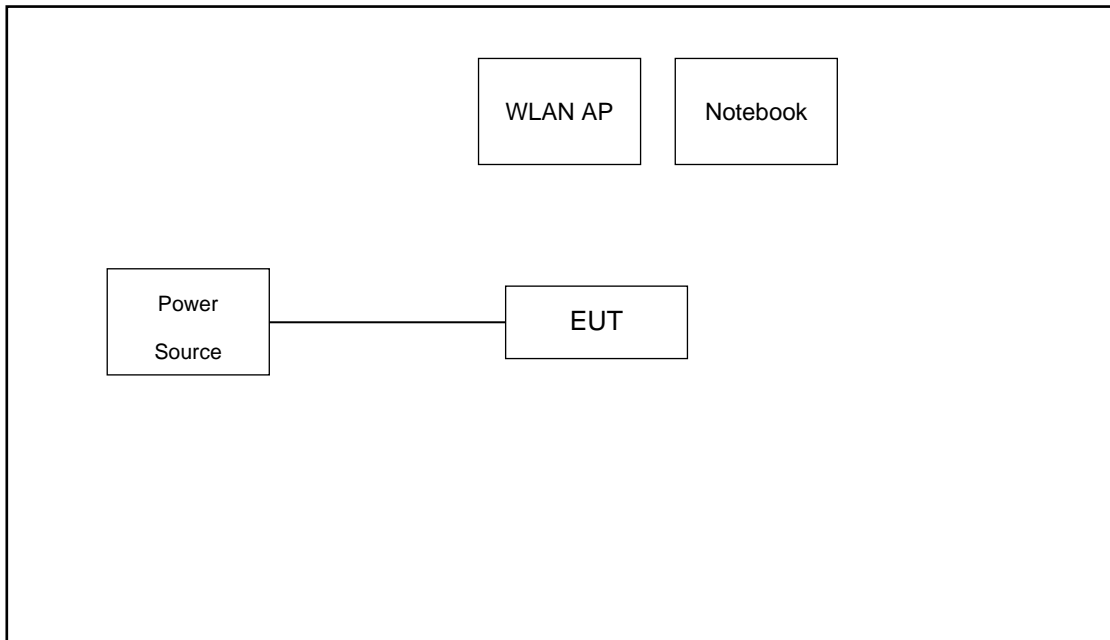



## 2.4 EUT Operation Test Setup

For Bluetooth function, the engineering test program was provided and enabled to make EUT connect with Bluetooth base station to continuous transmit/receive.

For AC power line conducted emissions, the EUT was set to connect with the WLAN AP under large package sizes transmission.

## 2.5 Measurement Results Explanation Example

The offset level is set in the spectrum analyzer to compensate the RF cable loss and attenuator factor between EUT conducted output port and spectrum analyzer. With the offset compensation, the spectrum analyzer reading level is exactly the EUT RF output level.

Example:

The spectrum analyzer offset is derived from RF cable loss and attenuator factor.

*Offset = RF cable loss + attenuator factor.*

Following shows an offset computation example with cable loss 2.8dB and attenuator factor 20 dB.

$$\begin{aligned} \text{Offset(dB)} &= \text{RF cable loss(dB)} + \text{attenuator factor(dB)}. \\ &= 2.8(\text{dB}) + 20 (\text{dB}) \\ &= 22.8(\text{dB}) \end{aligned}$$

### 3 Test Result

#### 3.1 Number of Channel Measurement

##### 3.1.1 Limits of Number of Hopping Frequency

Frequency hopping systems in the 2400-2483.5 MHz band shall use at least 15 channels.

##### 3.1.2 Measuring Instruments

The measuring equipment is listed in the section 4 of this test report.

##### 3.1.3 Test Procedure

1. The testing follows ANSI C63.10-2013 clause 7.8.3.
2. The RF output of EUT was connected to the spectrum analyzer by RF cable and attenuator. The path loss was compensated to the results for each measurement.
3. Set to the maximum power setting and enable the EUT transmit continuously.
4. Enable the EUT hopping function.
5. Use the following spectrum analyzer settings: Span = the frequency band of operation; RBW = 300kHz; VBW  $\geq$  RBW; Sweep = auto; Detector function = peak; Trace = max hold.
6. The number of hopping frequency used is defined as the number of total channel.
7. Record the measurement data derived from spectrum analyzer.

##### 3.1.4 Test Setup

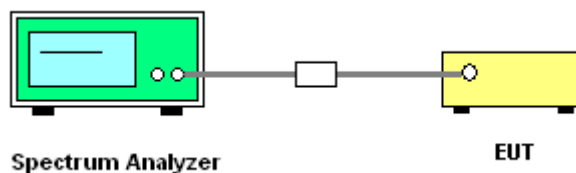

##### 3.1.5 Test Result of Number of Hopping Frequency

Please refer to Appendix A.



Number of Hopping Channel Plot on Channel 00 - 78

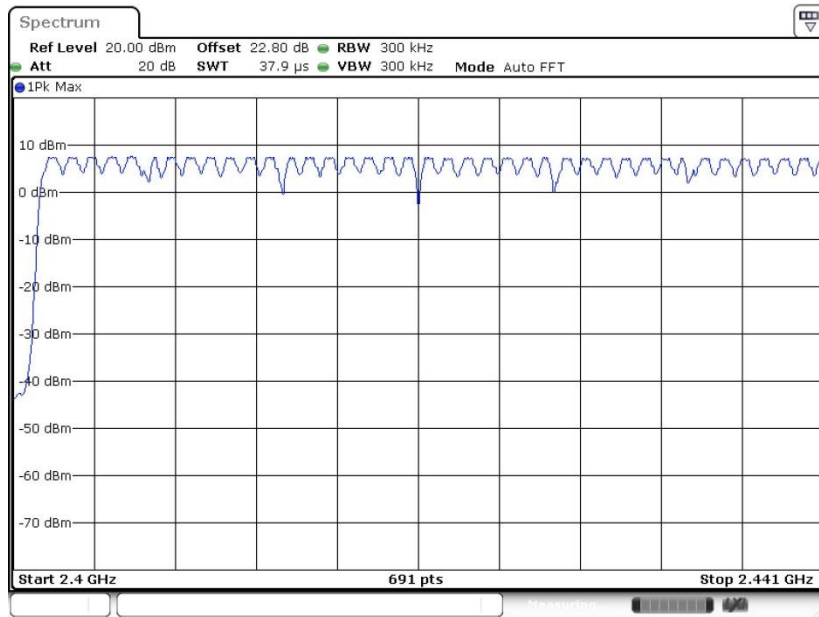

Date: 5.SEP.2020 21:13:08

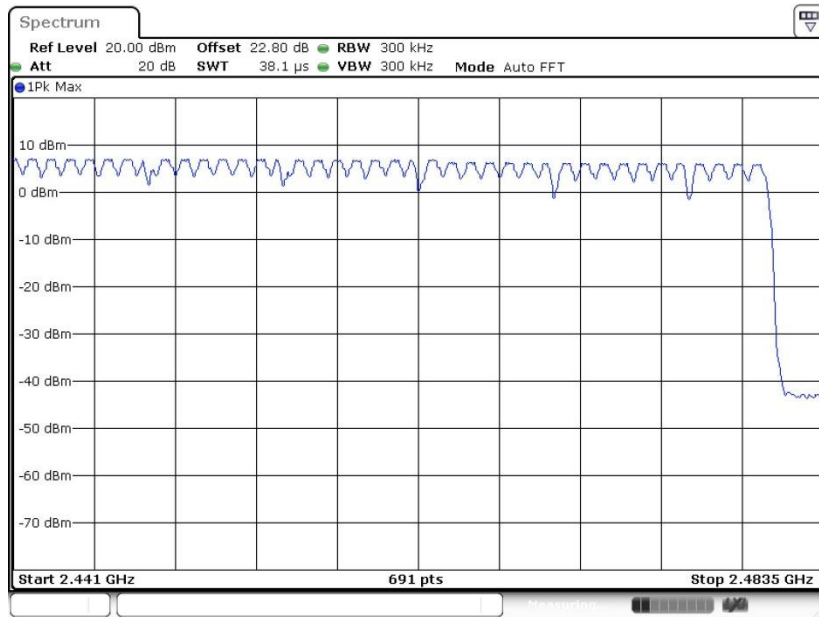

Date: 5.SEP.2020 21:20:35

## 3.2 Hopping Channel Separation Measurement

### 3.2.1 Limit of Hopping Channel Separation

Frequency hopping systems operating in the 2400-2483.5 MHz band may have hopping channel carrier frequencies that are separated by 25 kHz or two-thirds of the 20 dB bandwidth of the hopping channel, whichever is greater.

### 3.2.2 Measuring Instruments

The measuring equipment is listed in the section 4 of this test report.

### 3.2.3 Test Procedures

1. The testing follows ANSI C63.10-2013 clause 7.8.2.
2. The RF output of EUT was connected to the spectrum analyzer by RF cable and attenuator. The path loss was compensated to the results for each measurement.
3. Set to the maximum power setting and enable the EUT transmit continuously.
4. Enable the EUT hopping function.
5. Use the following spectrum analyzer settings:  
Span = wide enough to capture the peaks of two adjacent channels;  
RBW = 300kHz; VBW  $\geq$  RBW; Sweep = auto; Detector function = peak; Trace = max hold.
6. Measure and record the results in the test report.

### 3.2.4 Test Setup



### 3.2.5 Test Result of Hopping Channel Separation

Please refer to Appendix A.



<1Mbps>

Channel Separation Plot on Channel 00 - 01

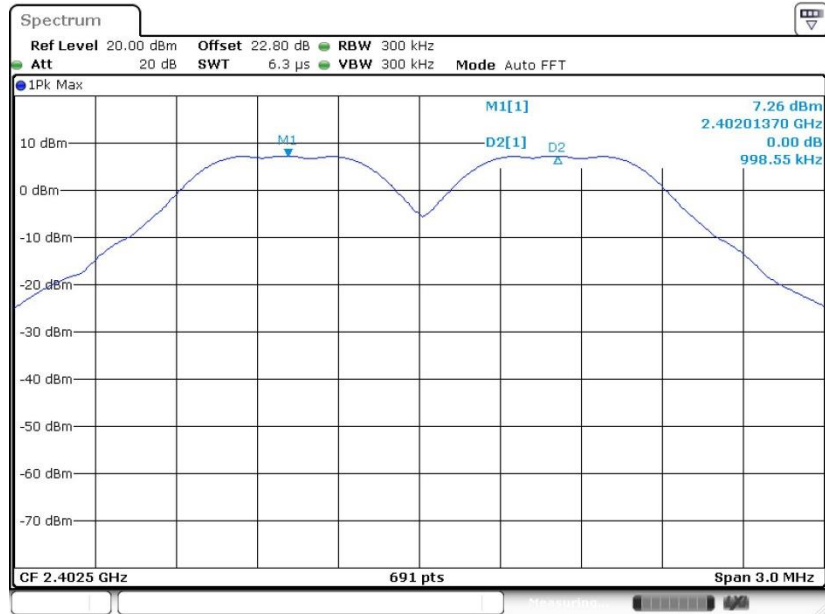

Date: 5.SEP.2020 19:36:35

Channel Separation Plot on Channel 39 - 40

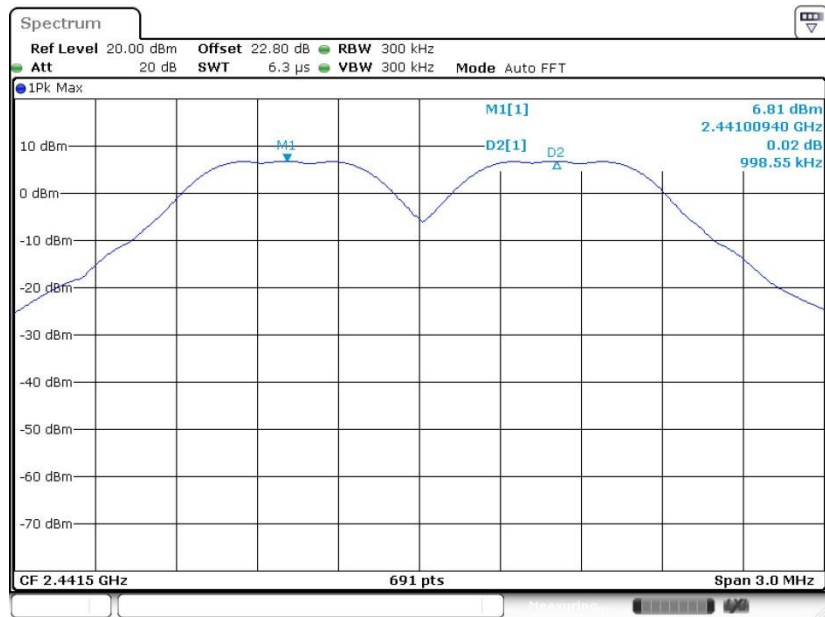

Date: 5.SEP.2020 19:38:10



Channel Separation Plot on Channel 77 - 78

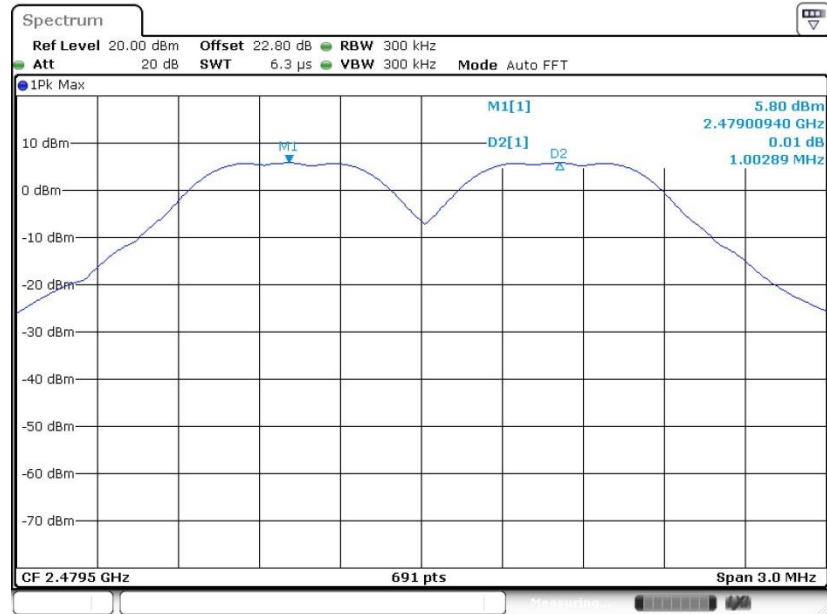

Date: 5.SEP.2020 19:39:54

<2Mbps>

Channel Separation Plot on Channel 00 - 01

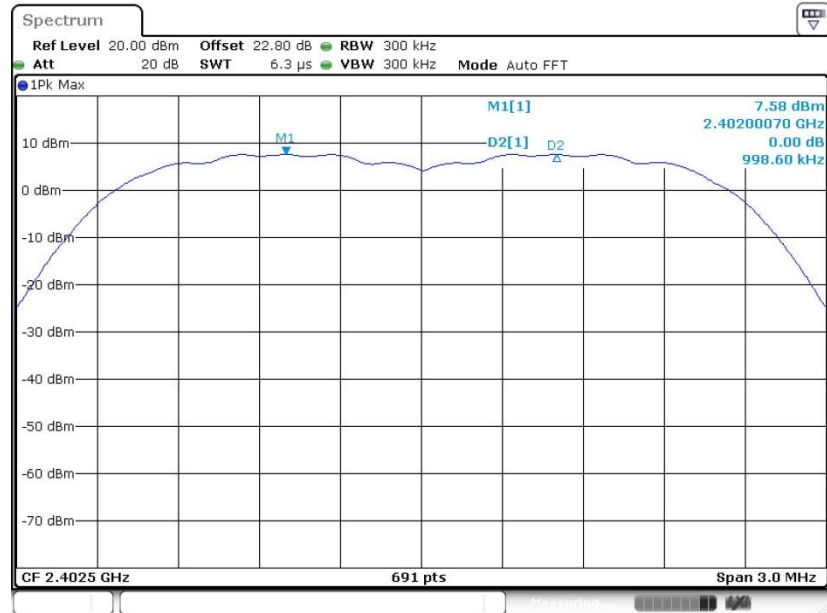

Date: 5.SEP.2020 20:22:01





### Channel Separation Plot on Channel 39 - 40

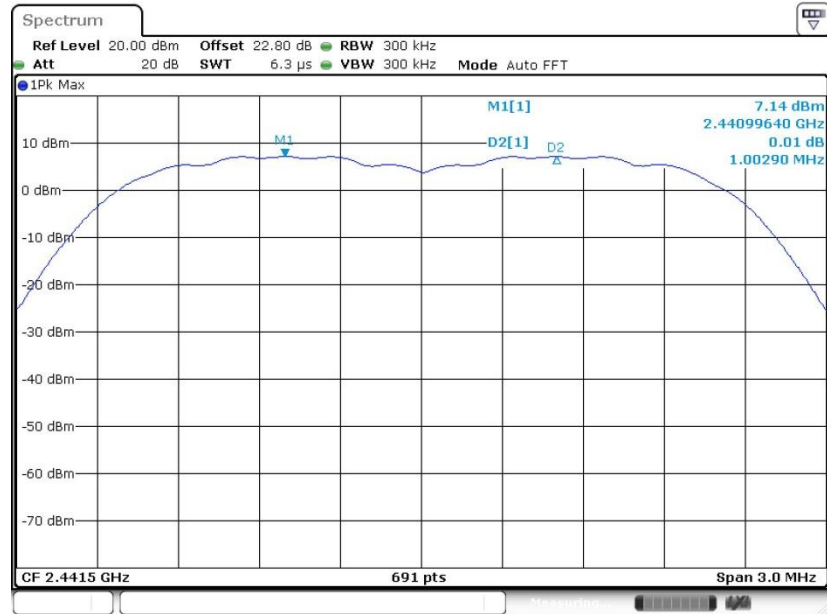

Date: 5.SEP.2020 20:23:41

### Channel Separation Plot on Channel 77 - 78

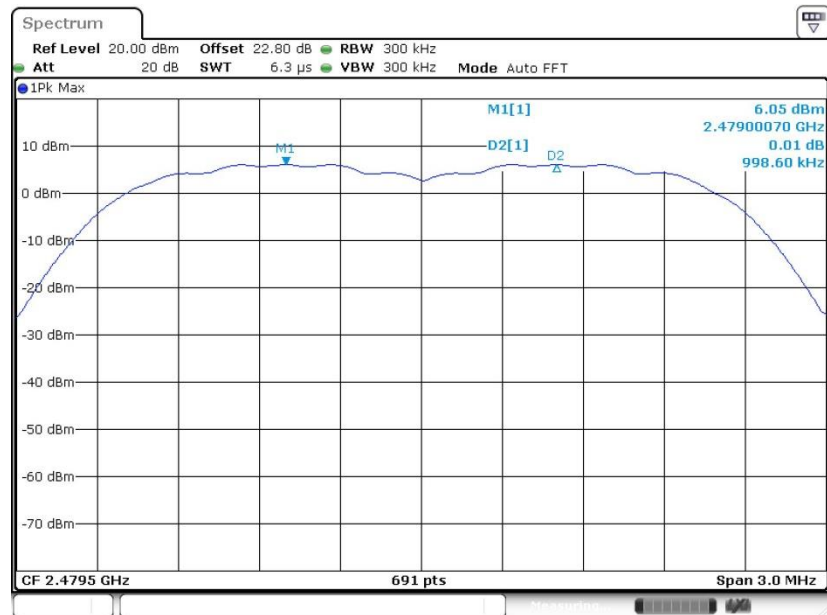

Date: 5.SEP.2020 20:25:04



<3Mbps>

Channel Separation Plot on Channel 00 - 01

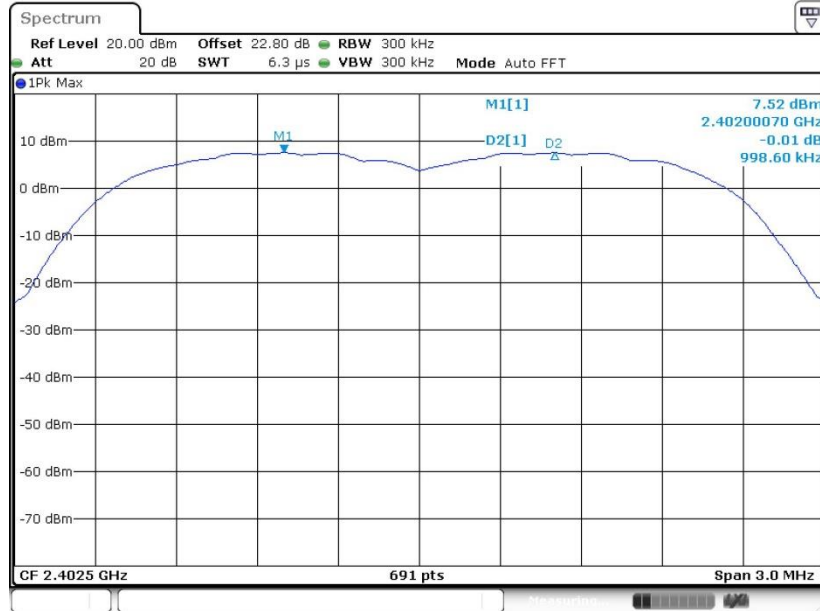

Date: 5.SEP.2020 20:44:11

Channel Separation Plot on Channel 39 - 40

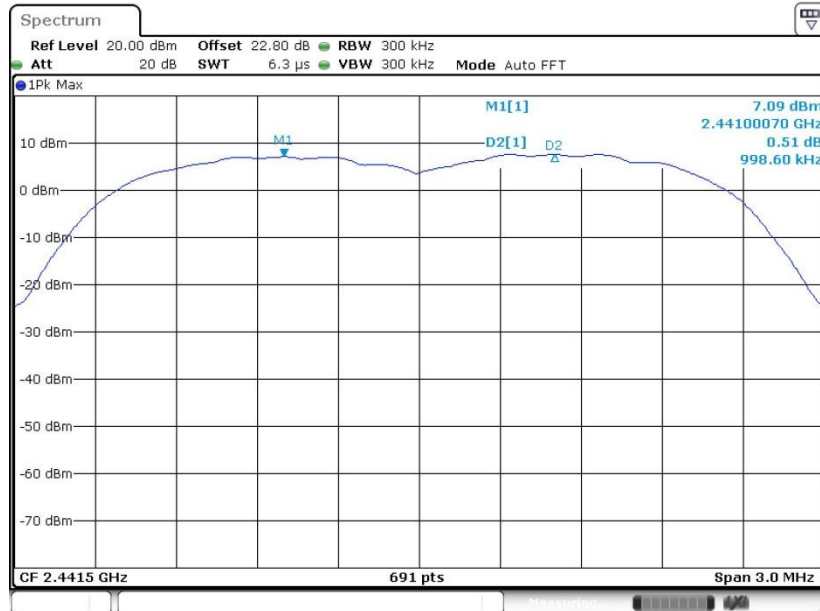

Date: 5.SEP.2020 20:50:54



Channel Separation Plot on Channel 77 - 78

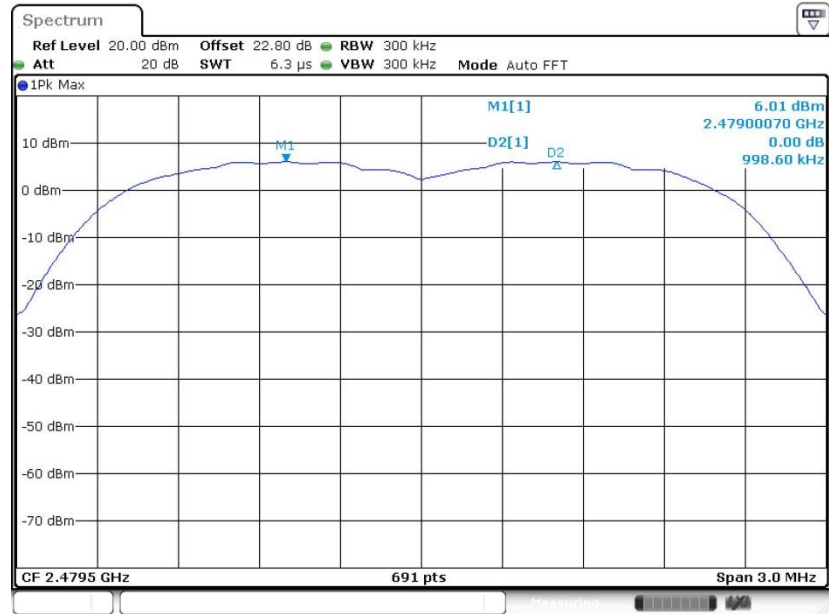

Date: 5.SEP.2020 20:57:30

### 3.3 Dwell Time Measurement

#### 3.3.1 Limit of Dwell Time

The average time of occupancy on any channel shall not be greater than 0.4 seconds within a period of 0.4 seconds multiplied by the number of hopping channels employed.

#### 3.3.2 Measuring Instruments

The measuring equipment is listed in the section 4 of this test report.

#### 3.3.3 Test Procedures

1. The testing follows ANSI C63.10-2013 clause 7.8.4.
2. The RF output of EUT was connected to the spectrum analyzer by RF cable and attenuator. The path loss was compensated to the results for each measurement.
3. Set to the maximum power setting and enable the EUT transmit continuously.
4. Enable the EUT hopping function.
5. Use the following spectrum analyzer settings: Span = zero span, centered on a hopping channel; RBW = 1 MHz; VBW  $\geq$  RBW; Sweep = as necessary to capture the entire dwell time per hopping channel; Detector function = peak; Trace = max hold.
6. Measure and record the results in the test report.

#### 3.3.4 Test Setup

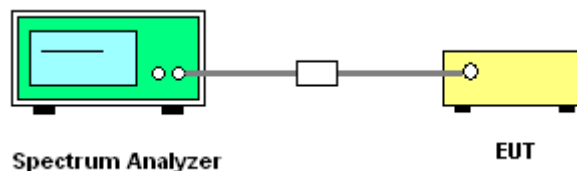



### 3.3.5 Test Result of Dwell Time

Please refer to Appendix A.

Package Transfer Time Plot

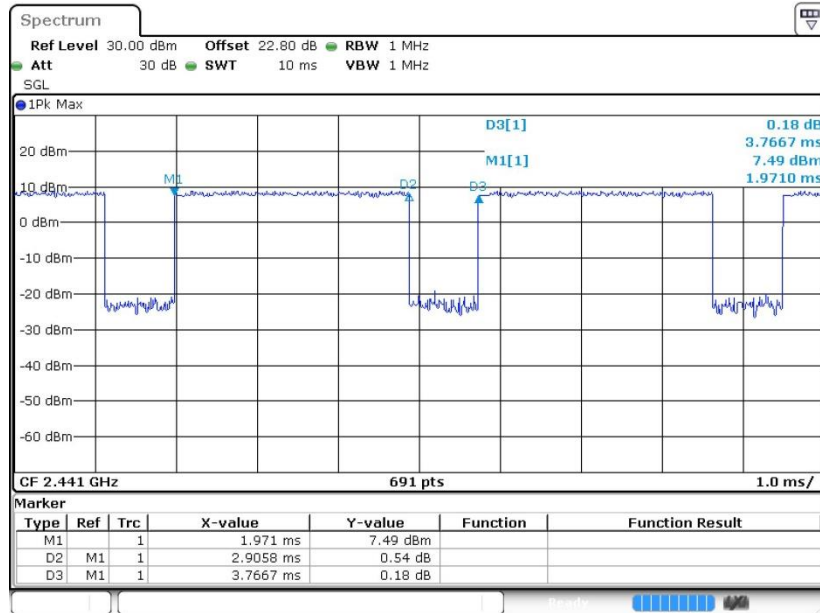

Date: 5.SEP.2020 06:03:40

**Remark:**

- In normal mode, hopping rate is 1600 hops/s with 6 slots (5 Transmit and 1 Receive slot) in 79 hopping channels.  
With channel hopping rate (1600 / 6 / 79) in Occupancy Time Limit (0.4 x 79) (s), Hops Over Occupancy Time comes to (1600 / 6 / 79) x (0.4 x 79) = 106.67 hops.
- In AFH mode, hopping rate is 800 hops/s with 6 slots in 20 hopping channels.  
With channel hopping rate (800 / 6 / 20) in Occupancy Time Limit (0.4 x 20) (s), Hops Over Occupancy Time comes to (800 / 6 / 20) x (0.4 x 20) = 53.33 hops.
- Dwell Time(s) = Hops Over Occupancy Time (hops) x Package Transfer Time

## 3.4 20dB and 99% Bandwidth Measurement

### 3.4.1 Limit of 20dB and 99% Bandwidth

Reporting only

### 3.4.2 Measuring Instruments

The measuring equipment is listed in the section 4 of this test report.

### 3.4.3 Test Procedures

1. The testing follows ANSI C63.10-2013 clause 6.9.2 and 6.9.3.
2. The RF output of EUT was connected to the spectrum analyzer by RF cable and attenuator. The path loss was compensated to the results for each measurement.
3. Set to the maximum power setting and enable the EUT transmit continuously.
4. Use the following spectrum analyzer settings for 20dB Bandwidth measurement.  
Span = approximately 2 to 5 times the 20 dB bandwidth, centered on a hopping channel;  
RBW  $\geq$  1% of the 20 dB bandwidth; VBW  $\geq$  RBW; Sweep = auto; Detector function = peak;  
Trace = max hold.
5. Use the following spectrum analyzer settings for 99 % Bandwidth measurement.  
Span = approximately 1.5 to 5 times the 99% bandwidth, centered on a hopping channel;  
RBW  $\geq$  1% of the 99% bandwidth; VBW  $\geq$  RBW; Sweep = auto; Detector function = peak;  
Trace = max hold.
6. Measure and record the results in the test report.

### 3.4.4 Test Setup

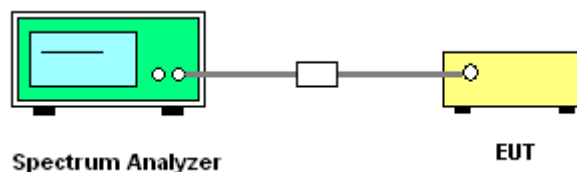

### 3.4.5 Test Result of 20dB Bandwidth

Please refer to Appendix A.



<1Mbps>

20 dB Bandwidth Plot on Channel 00

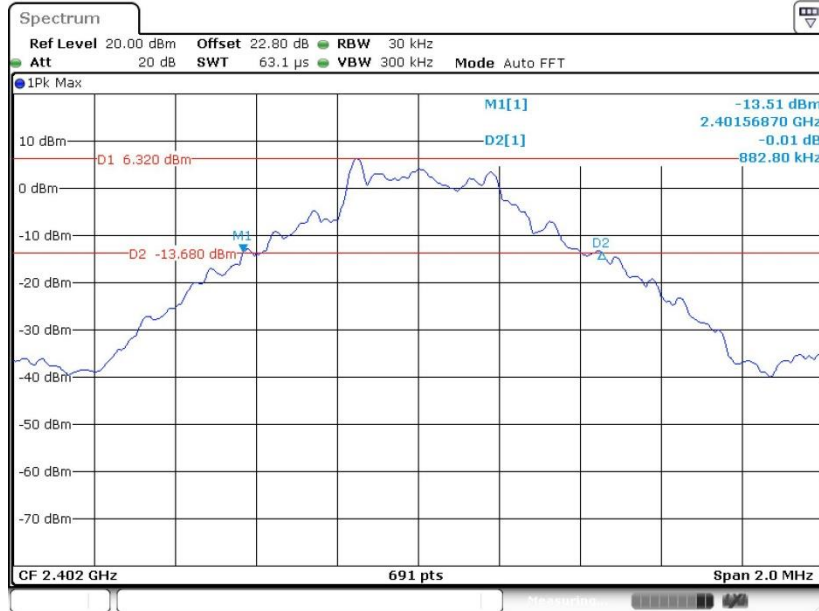

Date: 5.SEP.2020 19:42:45

20 dB Bandwidth Plot on Channel 39

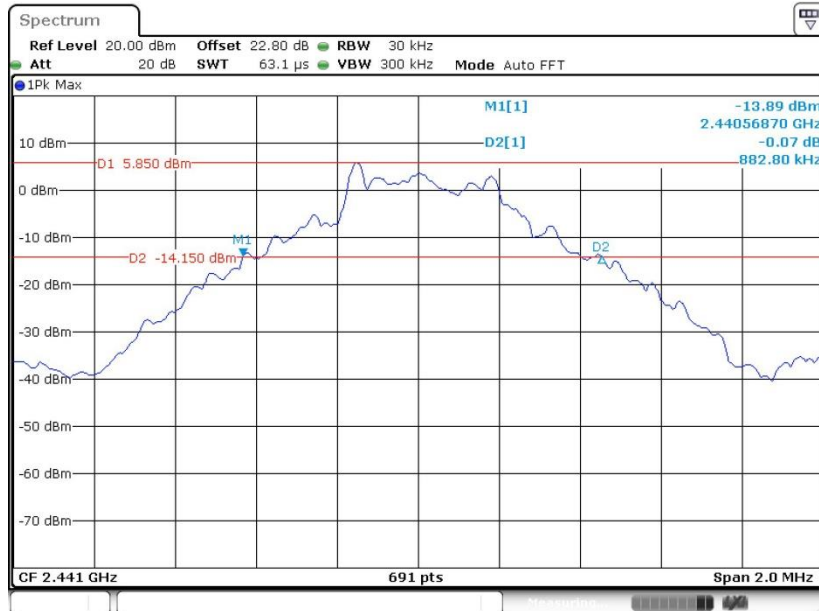

Date: 5.SEP.2020 19:47:44



20 dB Bandwidth Plot on Channel 78

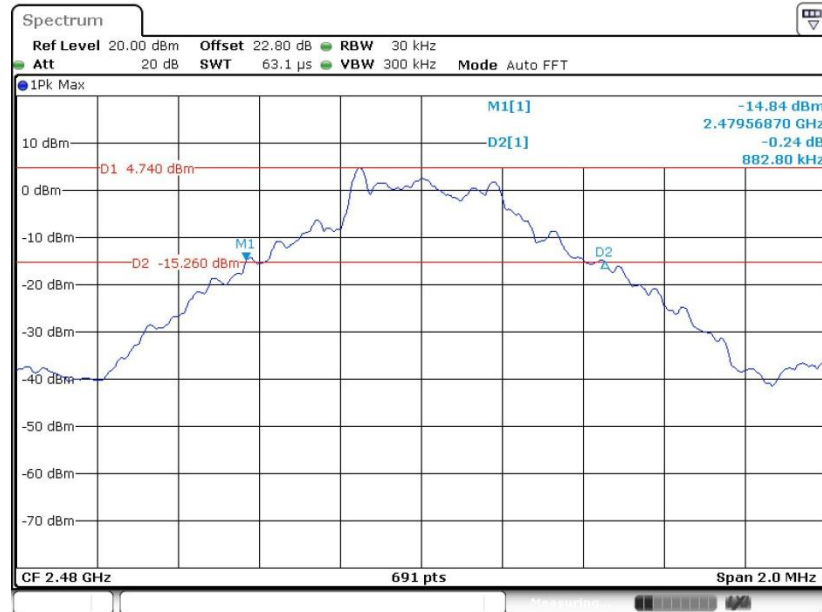

Date: 5.SEP.2020 19:53:15

<2Mbps>

20 dB Bandwidth Plot on Channel 00

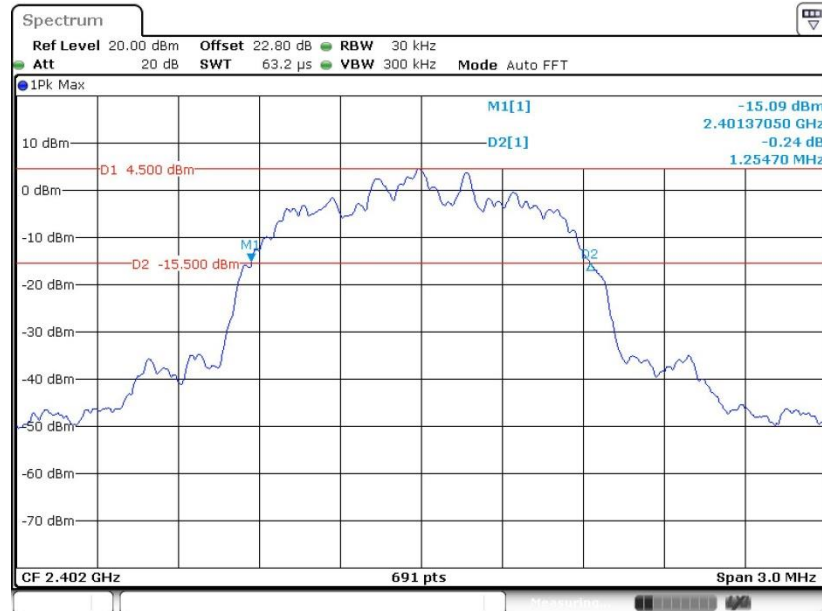

Date: 5.SEP.2020 20:27:59





20 dB Bandwidth Plot on Channel 39

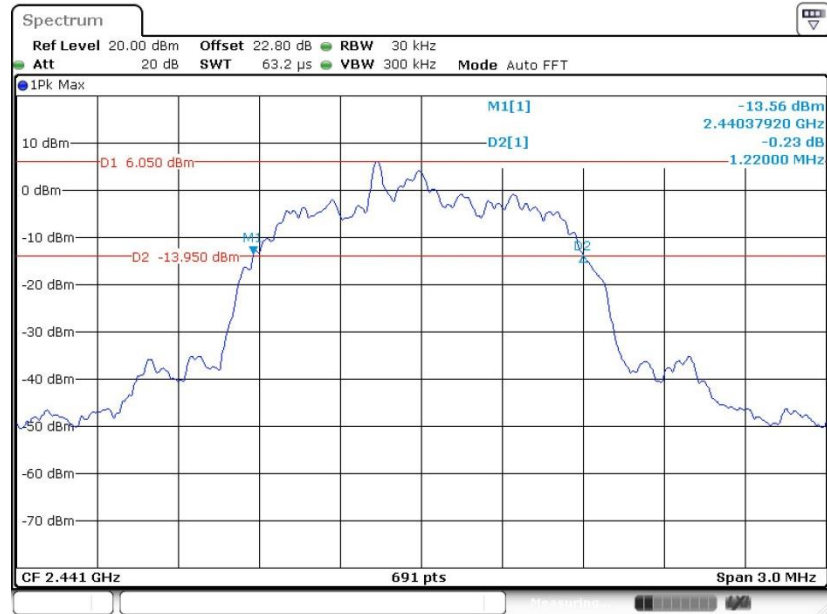

Date: 5.SEP.2020 20:32:52

20 dB Bandwidth Plot on Channel 78

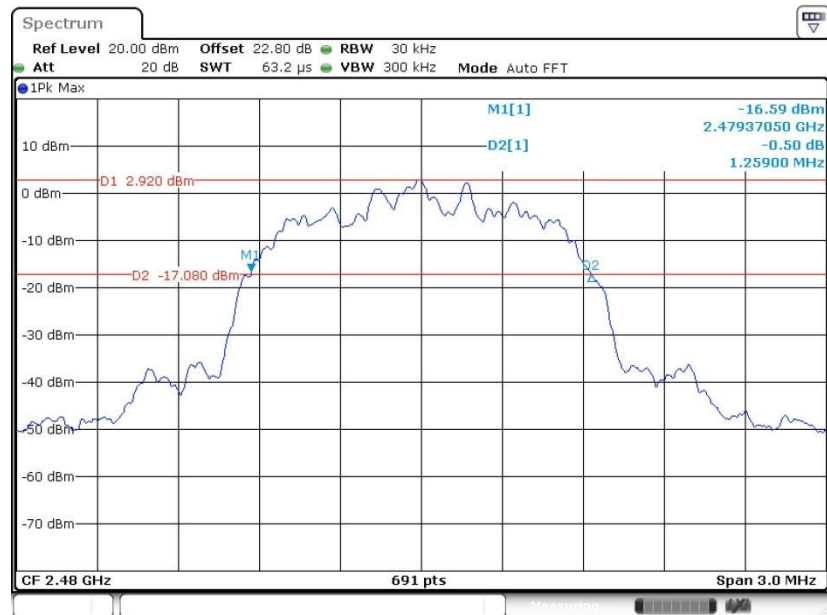

Date: 5.SEP.2020 20:36:53



<3Mbps>

20 dB Bandwidth Plot on Channel 00

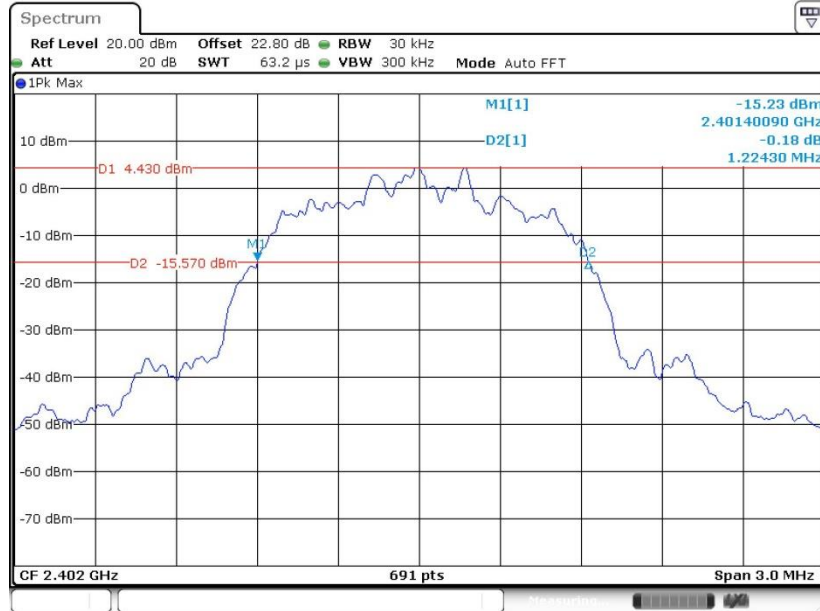

Date: 5.SEP.2020 20:45:35

20 dB Bandwidth Plot on Channel 39

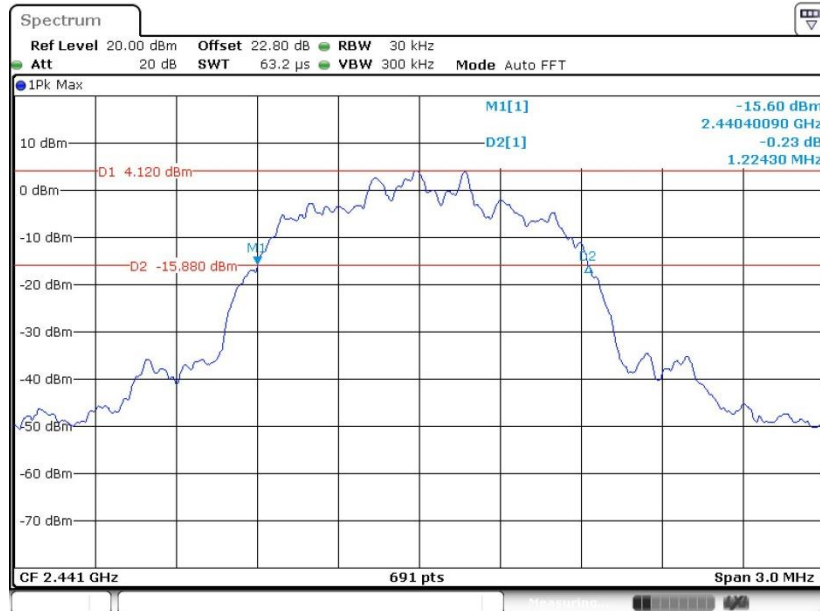

Date: 5.SEP.2020 20:52:49



20 dB Bandwidth Plot on Channel 78



Date: 5.SEP.2020 20:59:54



### 3.4.6 Test Result of 99% Occupied Bandwidth

Please refer to Appendix A.

<1Mbps>

#### 99% Occupied Bandwidth Plot on Channel 00



Date: 5.SEP.2020 19:43:43



99% Occupied Bandwidth Plot on Channel 39

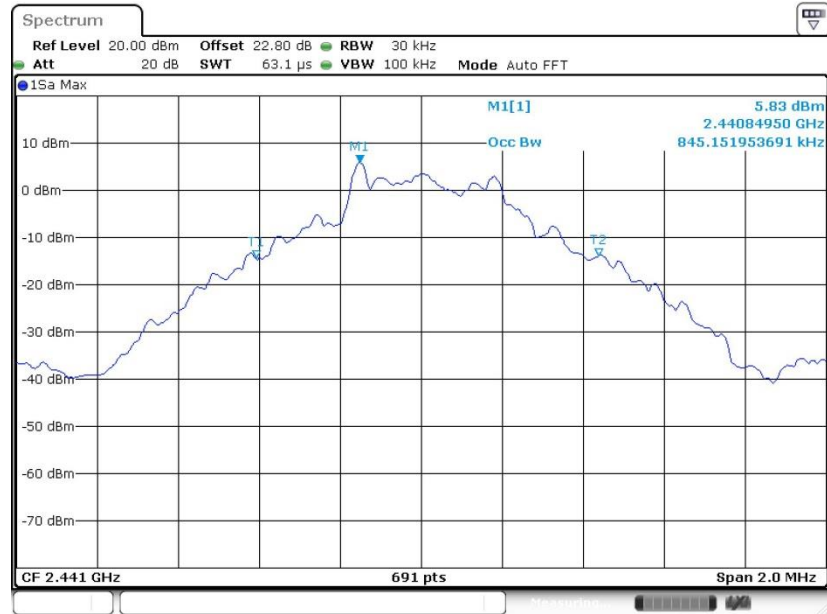

Date: 5.SEP.2020 19:48:21

99% Occupied Bandwidth Plot on Channel 78

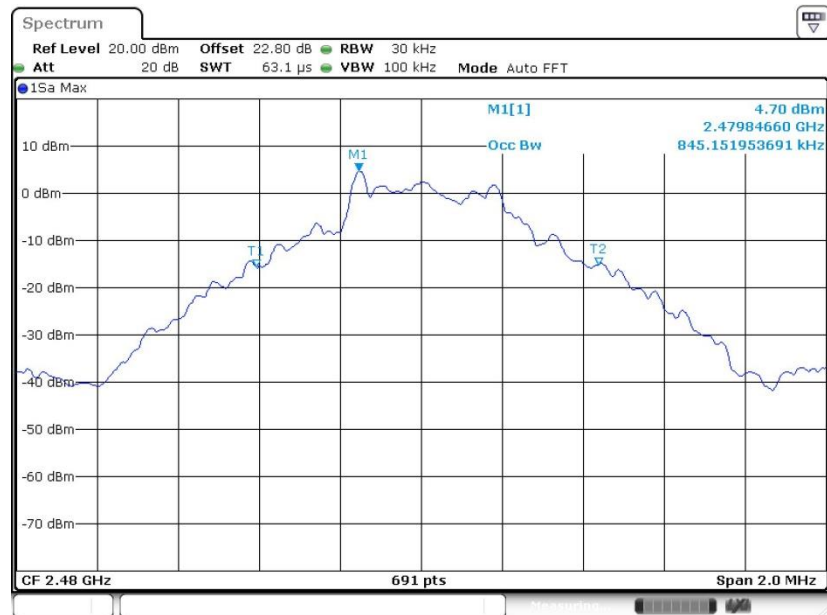

Date: 5.SEP.2020 19:54:27



<2Mbps>

99% Occupied Bandwidth Plot on Channel 00

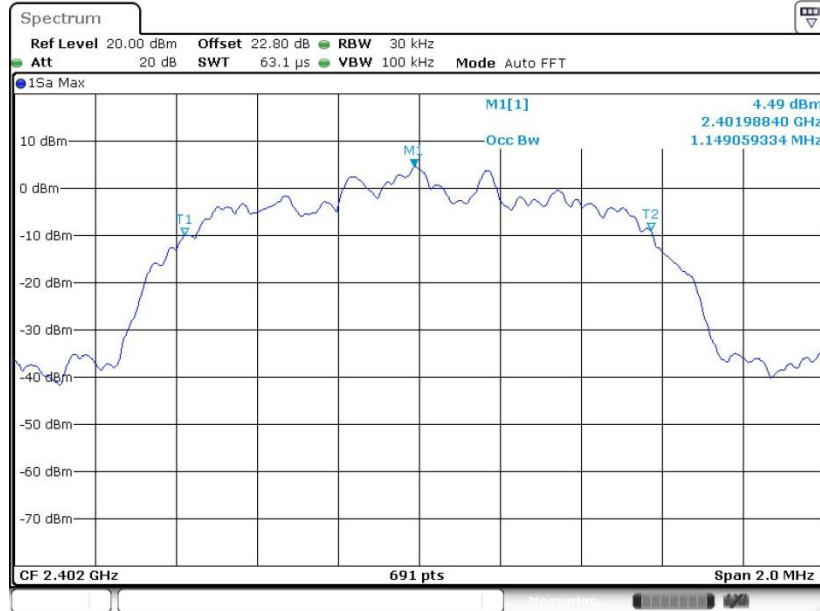

Date: 5.SEP.2020 20:29:09

99% Occupied Bandwidth Plot on Channel 39

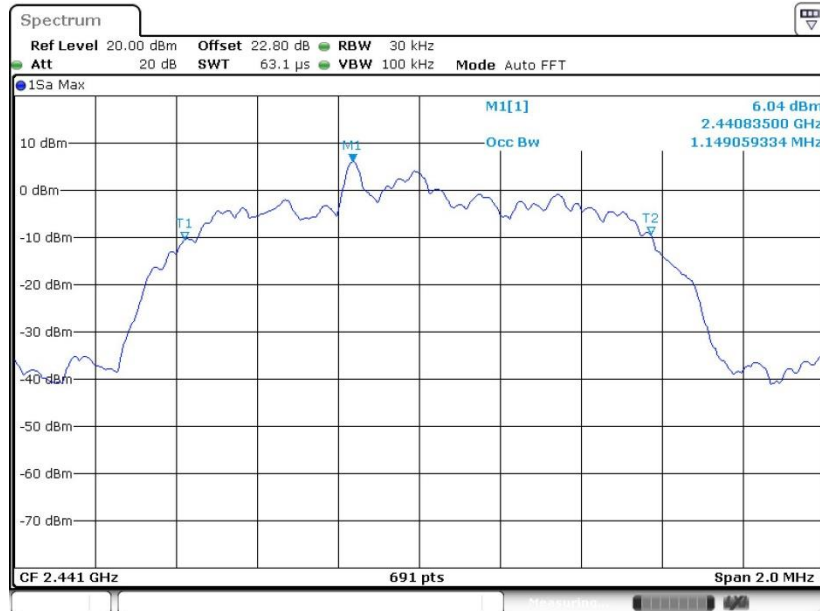

Date: 5.SEP.2020 20:33:44



99% Occupied Bandwidth Plot on Channel 78

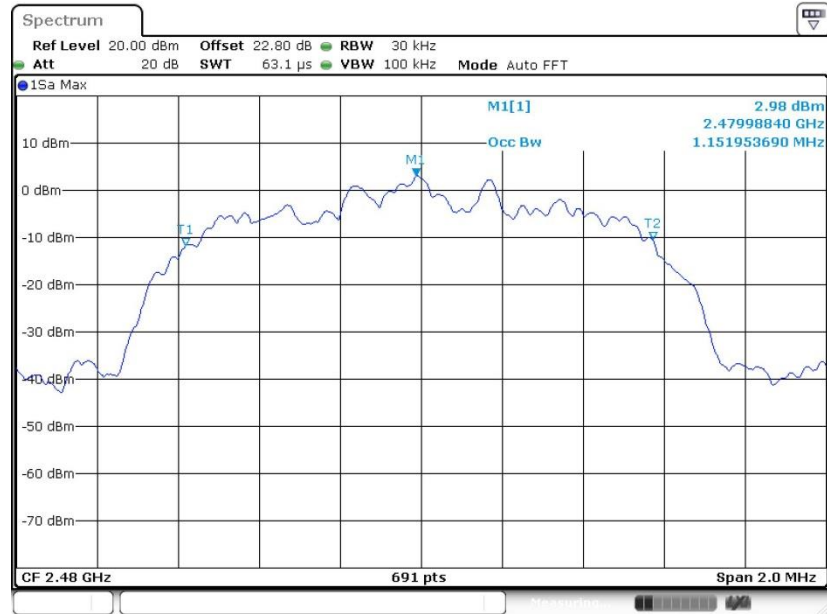

Date: 5.SEP.2020 20:37:56

<3Mbps>

99% Occupied Bandwidth Plot on Channel 00

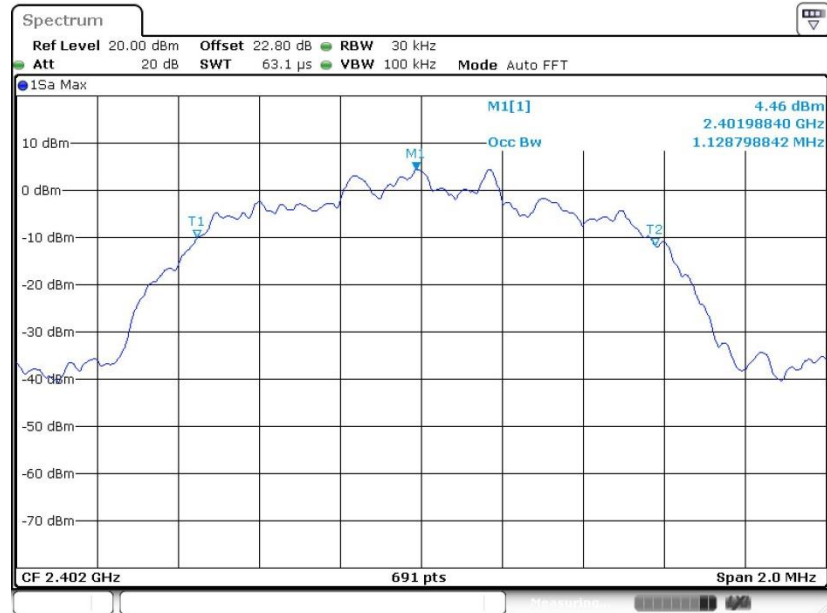

Date: 5.SEP.2020 20:46:45



### 99% Occupied Bandwidth Plot on Channel 39

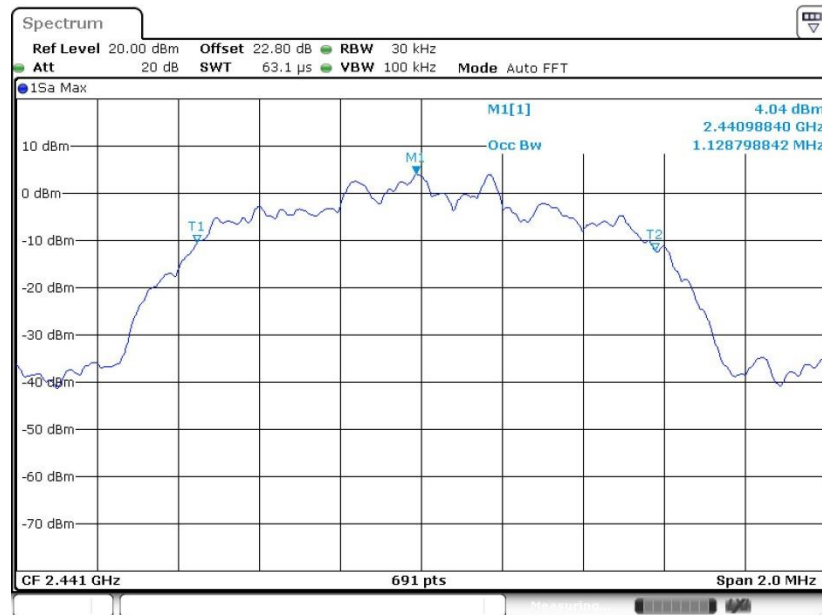

Date: 5.SEP.2020 20:53:50

### 99% Occupied Bandwidth Plot on Channel 78

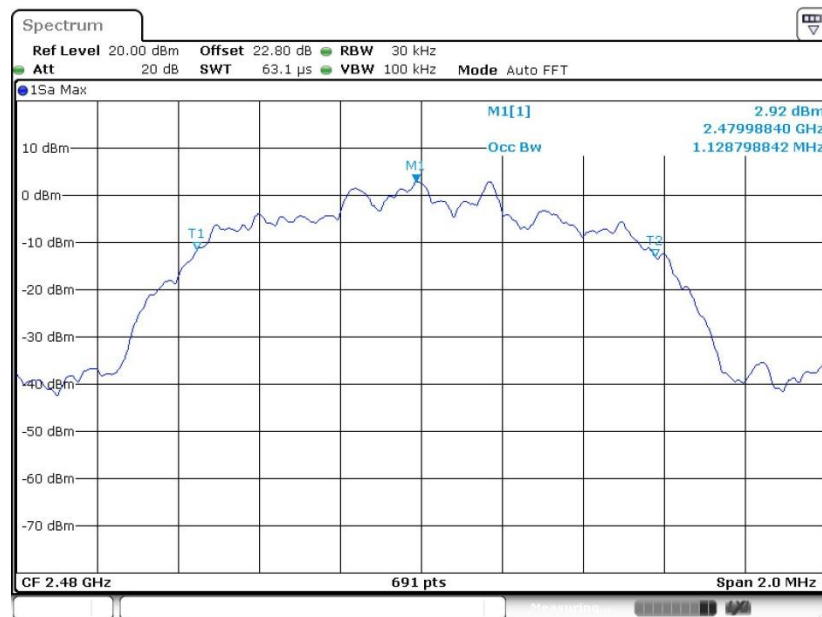

Date: 5.SEP.2020 21:00:53

Note : The occupied channel bandwidth is maintained within the band of operation for all of the modulations.



## 3.5 Output Power Measurement

### 3.5.1 Limit of Output Power

The maximum peak conducted output power of the intentional radiator shall not exceed the following:

(1) For frequency hopping systems operating in the 2400-2483.5 MHz band employing at least 75 non-overlapping hopping channels, and all frequency hopping systems in the 5725-5850 MHz band: 1 watt. For all other frequency hopping systems in the 2400-2483.5 MHz band 0.125 watts. The power limit for 1Mbps, 2Mbps, 3Mbps and AFH modes are 0.125 watts.

### 3.5.2 Measuring Instruments

The measuring equipment is listed in the section 4 of this test report.

### 3.5.3 Test Procedures

1. The testing follows ANSI C63.10-2013 clause 7.8.5.
2. The RF output of EUT was connected to the power meter by RF cable and attenuator. The path loss was compensated to the results for each measurement.
3. Set to the maximum power setting and enable the EUT transmit continuously.
4. Measure the conducted output power with cable loss and record the results in the test report.
5. Measure and record the results in the test report.

### 3.5.4 Test Setup

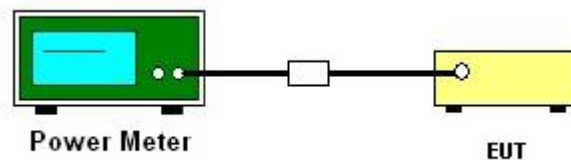

### 3.5.5 Test Result of Peak Output Power

Please refer to Appendix A.

### 3.5.6 Test Result of Average Output Power (Reporting Only)

Please refer to Appendix A.

## 3.6 Conducted Band Edges Measurement

### 3.6.1 Limit of Band Edges

In any 100 kHz bandwidth outside the intentional radiation frequency band, the radio frequency power shall be at least 20 dB below the highest level of the radiated power. In addition, radiated emissions which fall in the restricted bands must also comply with the radiated emission limits.

### 3.6.2 Measuring Instruments

The measuring equipment is listed in the section 4 of this test report.

### 3.6.3 Test Procedures

1. The testing follows ANSI C63.10-2013 clause 7.8.6.
2. Set to the maximum power setting and enable the EUT transmit continuously.
3. Set RBW = 100kHz, VBW = 300kHz. Band edge emissions must be at least 20 dB down from the highest emission level within the authorized band as measured with a 100kHz RBW. The attenuation shall be 30 dB instead of 20 dB when RMS conducted output power procedure is used.
4. Enable hopping function of the EUT and then repeat step 2. and 3.
5. Measure and record the results in the test report.

### 3.6.4 Test Setup





### 3.6.5 Test Result of Conducted Band Edges

<1Mbps>

#### Low Band Edge Plot on Channel 00

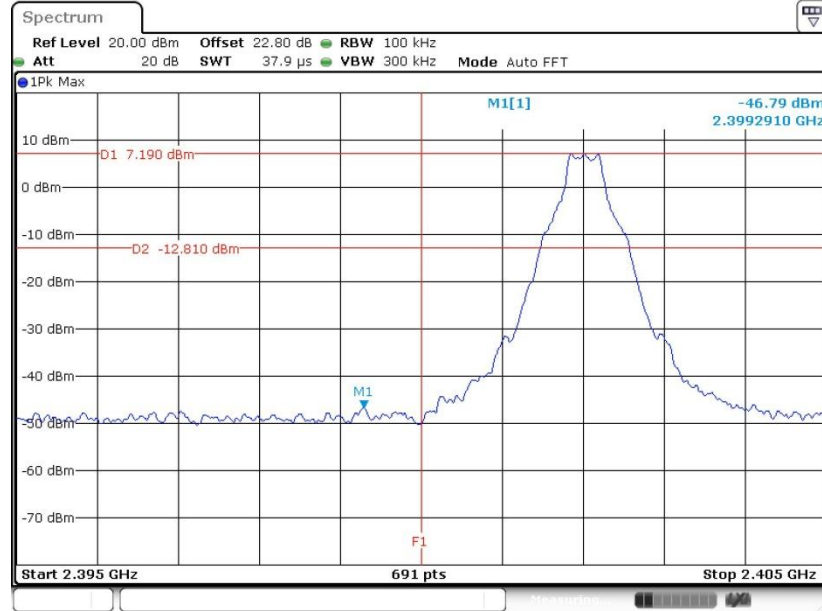

Date: 5.SEP.2020 19:43:07

#### High Band Edge Plot on Channel 78

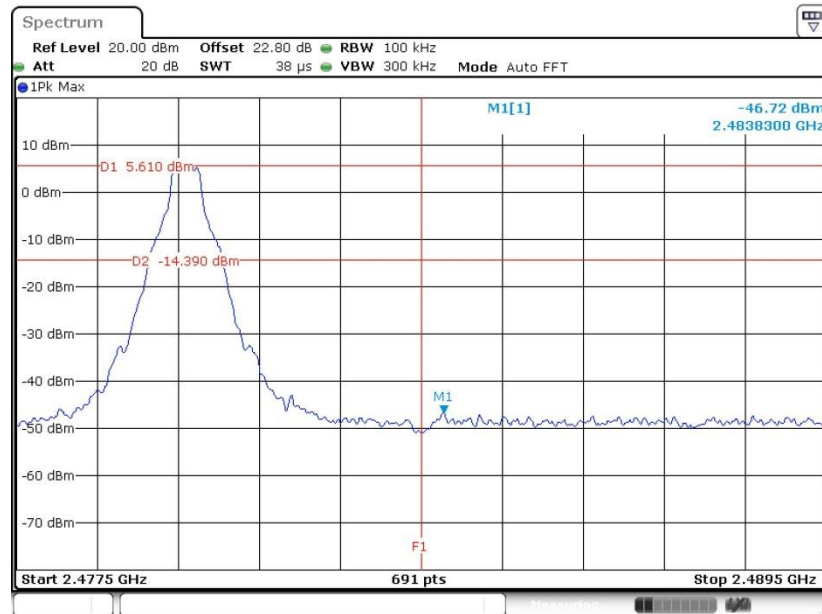

Date: 5.SEP.2020 19:53:39



<2Mbps>

Low Band Edge Plot on Channel 00

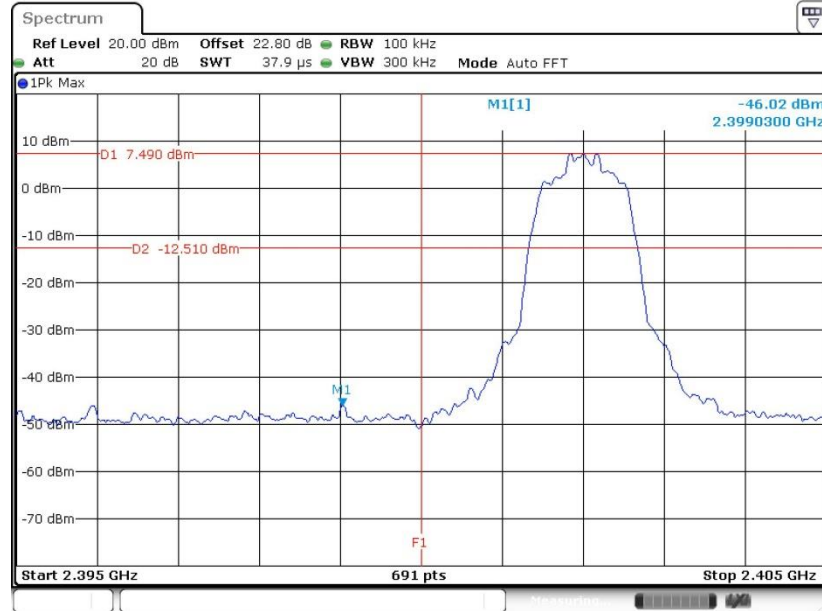

Date: 5.SEP.2020 20:28:22

High Band Edge Plot on Channel 78

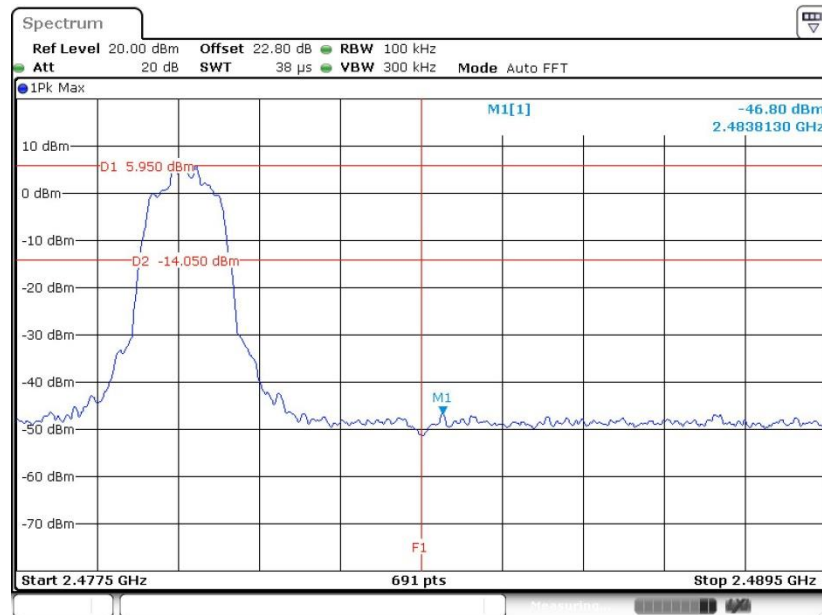

Date: 5.SEP.2020 20:37:17



<3Mbps>

Low Band Edge Plot on Channel 00

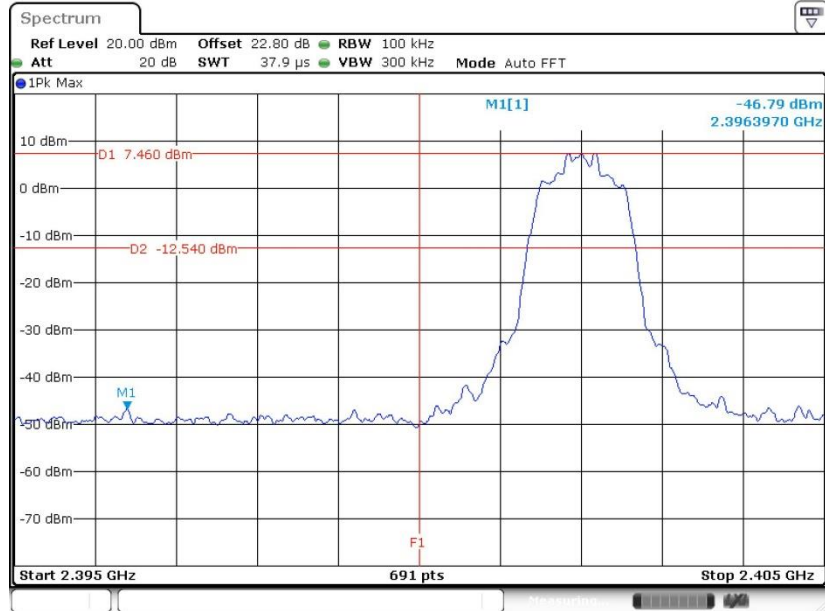

Date: 5.SEP.2020 20:46:00

High Band Edge Plot on Channel 78

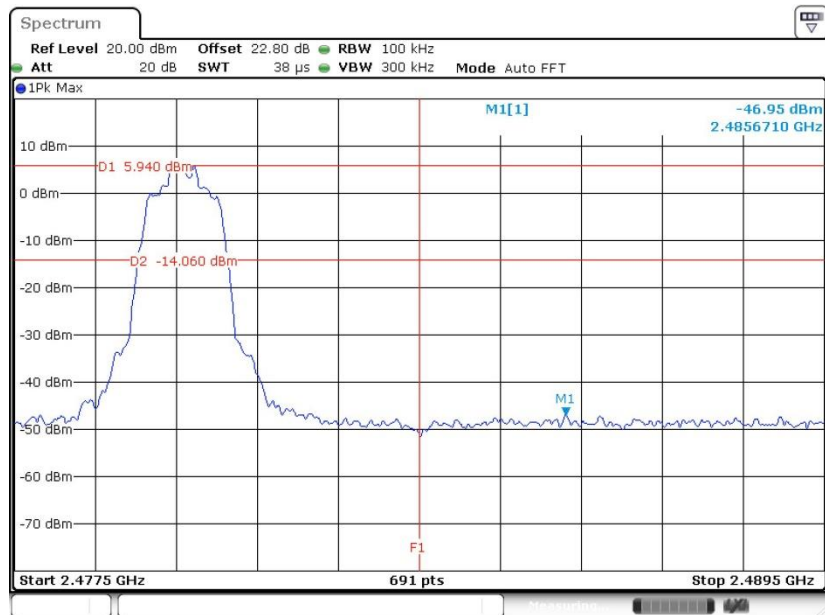

Date: 5.SEP.2020 21:00:17



### 3.6.6 Test Result of Conducted Hopping Mode Band Edges

<1Mbps>

#### Hopping Mode Low Band Edge Plot

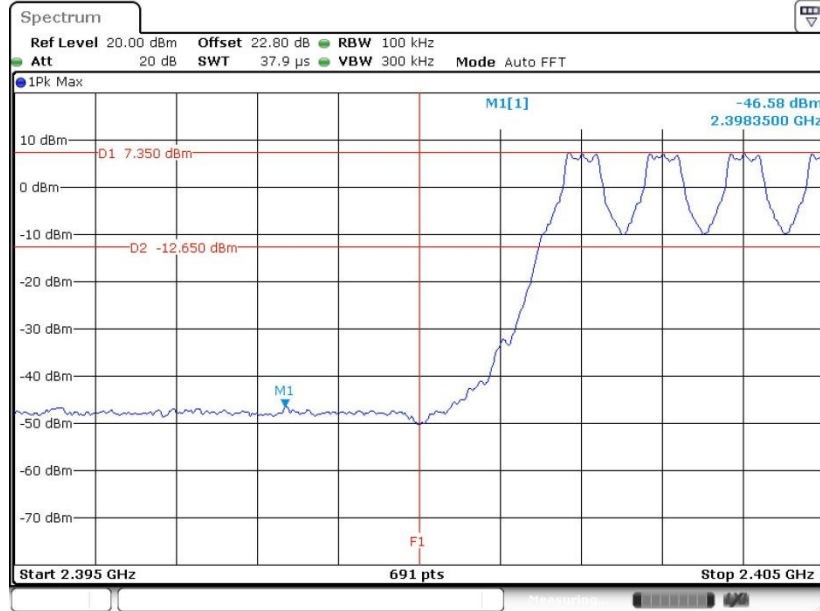

Date: 5.SEP.2020 20:03:02

#### Hopping Mode High Band Edge Plot

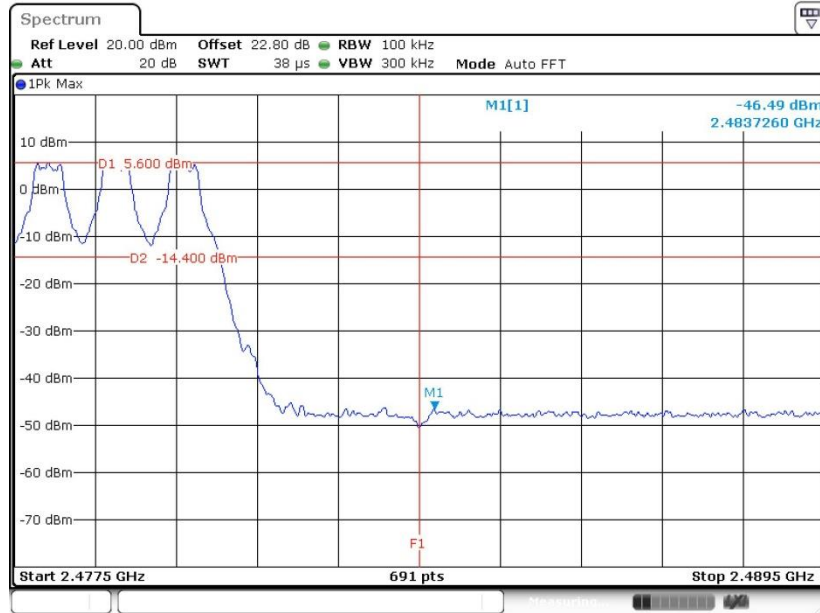

Date: 5.SEP.2020 20:06:13



<2Mbps>

### Hopping Mode Low Band Edge Plot

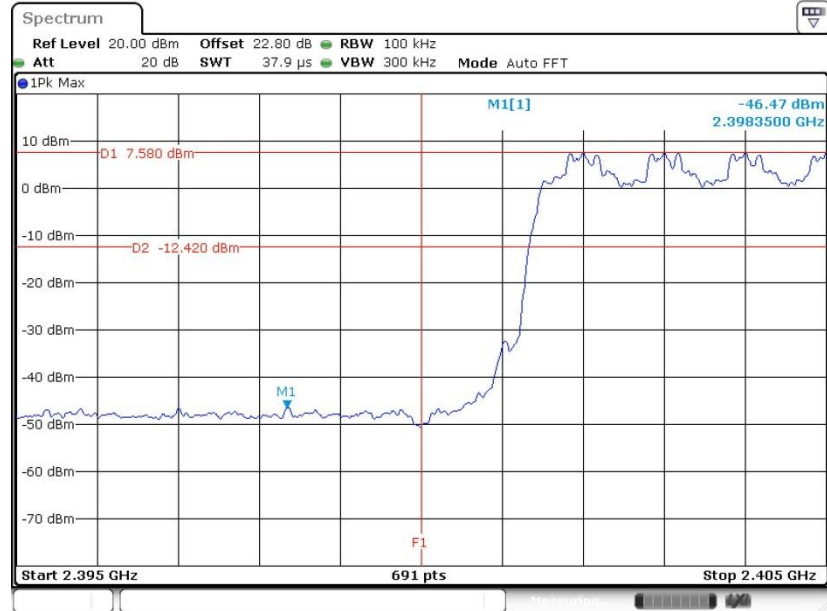

Date: 5.SEP.2020 20:16:27

### Hopping Mode High Band Edge Plot

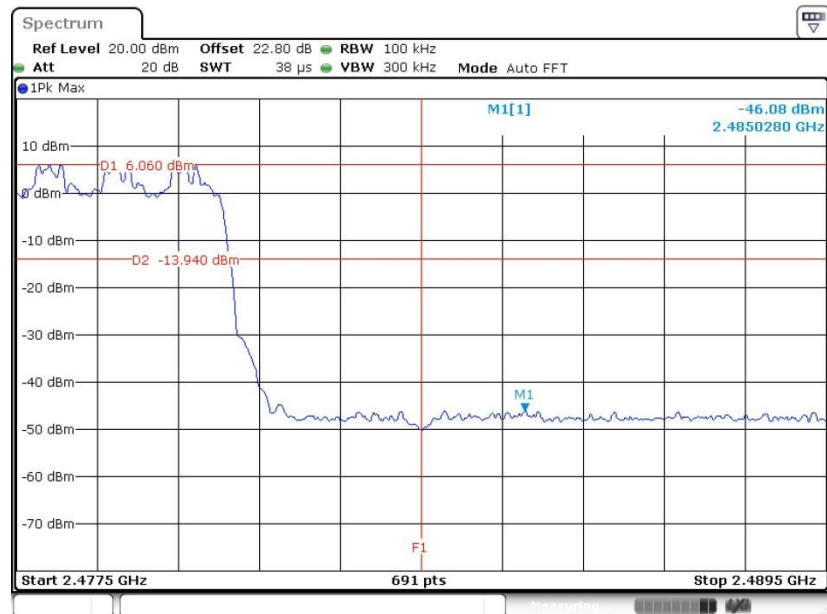

Date: 5.SEP.2020 20:20:00



<3Mbps>

### Hopping Mode Low Band Edge Plot

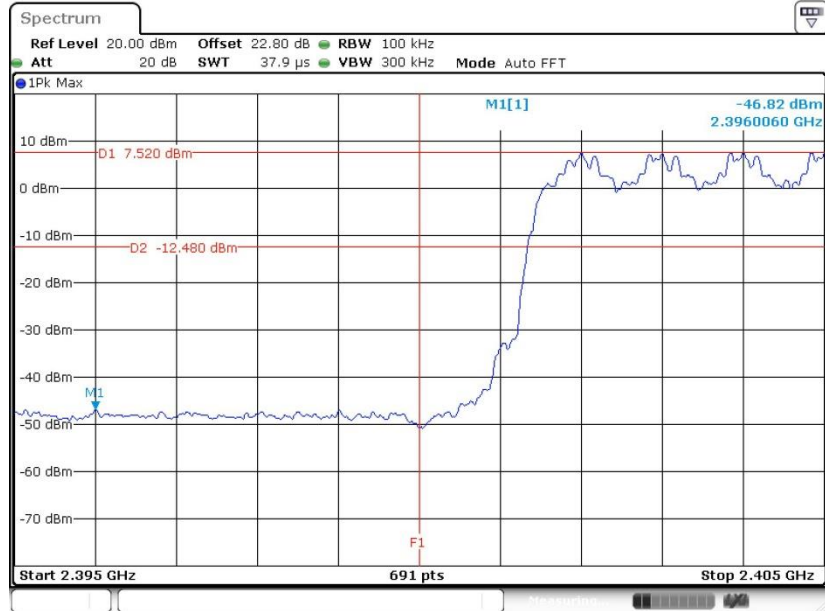

Date: 5.SEP.2020 21:08:46

### Hopping Mode High Band Edge Plot

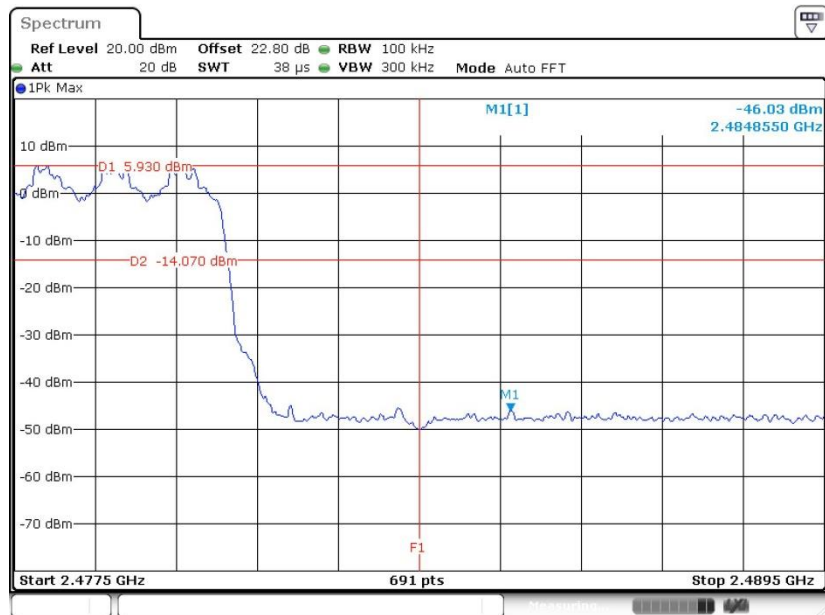

Date: 5.SEP.2020 21:06:34