

FCC SAR Measurement and Test Report

For

Shenzhen Inrico Electronics Co., LTD

3/F, Building NO.118, High Tech Industrial Park, 72 Guowei Road, Luohu

District, Shenzhen, China

FCC ID: 2AIV6-T522A

Test Standards:	FCC Part 2.1093 ANSI / IEEE C95.1 ::2005+A1:2010 ANSI / IEEE C95.3 : 2002(R2008) <u>IEEE 1528 :2013</u>
Product Description:	<u>Intelligent Two Way Radio</u>
Tested Model:	<u>T522A</u>
Report No.:	<u>WTX19X03011771W-7</u>
Sample Received Date:	<u>2019-04-15</u>
Tested Date:	<u>2019-04-16 to 2019-04-18</u>
Issued Date:	<u>2019-04-22</u>
Tested By:	<u>Ruler Liu / Engineer</u> <i>Ruler Liu</i>
Reviewed By:	<u>Silin Chen / EMC Manager</u> <i>Silin chen</i>
Approved & Authorized By:	<u>Jandy So / PSQ Manager</u> <i>Jandyso</i>
Prepared By:	

Shenzhen SEM Test Technology Co. Ltd.
1/F, Building A, Hongwei Industrial Park, Liuxian 2nd Road,
Bao'an District, Shenzhen, P.R.C. (518101)
Tel.: +86-755-33663308 Fax.: +86-755-33663309 Website: www.semtest.com.cn

Note: This test report is limited to the above client company and the product model only. It may not be duplicated without prior permitted by Shenzhen SEM Test Technology Co., Ltd.

TABLE OF CONTENTS

1. General Information	3
1.1 Product Description for Equipment Under Test (EUT)	3
1.2 Test Standards	6
1.3 Test Methodology	6
1.4 Test Facility	6
2. Summary of Test Results	7
3. Specific Absorption Rate (SAR)	8
3.1 Introduction	8
3.2 SAR Definition	8
4. SAR Measurement System	9
4.1 The Measurement System	9
4.2 Probe	9
4.3 Probe Calibration Process	11
4.4 Phantom	12
4.5 Device Holder	12
4.6 Test Equipment List	13
5. Tissue Simulating Liquids	14
5.1 Composition of Tissue Simulating Liquid	14
5.2 Tissue Dielectric Parameters for Head and Body Phantoms	15
5.3 Tissue Calibration Result	16
6. SAR Measurement Evaluation	17
6.1 Purpose of System Performance Check	17
6.2 System Setup	17
6.3 Validation Results	18
7. EUT Testing Position	20
7.1 EUT Antenna Position	20
7.2 EUT Testing Position	21
8. SAR Measurement Procedures	22
8.1 Measurement Procedures	22
8.2 Spatial Peak SAR Evaluation	22
8.3 Area & Zoom Scan Procedures	23
8.4 Volume Scan Procedures	23
8.5 SAR Averaged Methods	23
8.6 Power Drift Monitoring	23
9. SAR Test Result	24
9.1 Conducted RF Output Power	24
9.2 Test Results for Standalone SAR Test	62
9.3 Simultaneous Multi-band Transmission SAR Analysis	68
10. Measurement Uncertainty	71
10.1 Uncertainty for EUT SAR Test	71
10.2 Uncertainty for System Performance Check	72
Annex A. Plots of System Performance Check	74
Annex B. Plots of SAR Measurement	98
Annex C. EUT Photos	152
Annex D. Test Setup Photos	154
Annex E. Calibration Certificate	155

1. General Information

1.1 Product Description for Equipment Under Test (EUT)

Client Information

Applicant: Shenzhen Inrico Electronics Co., LTD
Address of applicant: 3/F, Building NO.118, High Tech Industrial Park, 72 Guowei Road, Luohu District, Shenzhen, China

Manufacturer: Shenzhen Inrico Electronics Co., LTD
Address of manufacturer: 3/F, Building NO.118, High Tech Industrial Park, 72 Guowei Road, Luohu District, Shenzhen, China

General Description of EUT:	
Product Name:	Intelligent Two Way Radio
Brand Name:	Inrico
Model No.:	T522A
Adding Model(s):	/
Rated Voltage:	DC3.7V
Battery:	4000mAh
<i>Note: The test data is gathered from a production sample provided by the manufacturer.</i>	

Technical Characteristics of EUT:	
2G	
Support Networks:	GSM, GPRS,EDGE
Support Band:	GSM850/PCS1900
Uplink Frequency:	GSM/GPRS 850: 824~849MHz GSM/GPRS 1900: 1850~1910MHz
Downlink Frequency:	GSM/GPRS 850: 869~894MHz GSM/GPRS 1900: 1930~1990MHz
RF Output Power:	GSM850: 32.02dBm, GSM1900: 29.09dBm EDGE850: 26.69dBm, EDGE1900: 25.77dBm
Type of Modulation:	GMSK,8PSK
Type of Antenna:	Integral Antenna
Antenna Gain:	GSM850: 1.21dBi; GSM1900: 1.86dBi
GPRS/EDGE Class:	Class 12
3G	
Support Networks:	WCDMA, HSDPA, HSUPA
Support Band:	WCDMA Band 2, WCDMA Band 5
Uplink Frequency:	WCDMA Band 2: 1850~1910MHz WCDMA Band 5: 824~849MHz
Downlink Frequency:	WCDMA Band 2: 1930~1990MHz WCDMA Band 5: 869~894MHz
RF Output Power:	WCDMA Band 2: 22.84dBm, WCDMA Band 5: 22.88dBm
Type of Modulation:	BPSK, QPSK
Antenna Type:	Integral Antenna
Antenna Gain:	WCDMA Band 2: 1.86dBi, WCDMA Band 5: 1.21dBi
4G	
Support Networks:	FDD-LTE
Support Band:	FDD-LTE Band 2, 4, 5, 7,12,13,17
Uplink Frequency:	FDD-LTE Band 2: Tx: 1850-1910MHz, FDD-LTE Band 4: Tx: 1710-1755MHz, FDD-LTE Band 5: Tx: 824-849MHz, FDD-LTE Band 7: Tx: 2500-2570MHz, FDD-LTE Band 12: Tx: 699-716MHz, FDD-LTE Band 13: Tx: 777-787MHz, FDD-LTE Band 17: Tx: 704-716MHz
Downlink Frequency:	FDD-LTE Band 2: Rx: 1930-1990MHz, FDD-LTE Band 4: Rx: 2110-2155MHz, FDD-LTE Band 5: Rx: 869-894MHz, FDD-LTE Band 7: Rx: 2620-2690MHz, FDD-LTE Band 12: Rx: 729-746MHz,

	FDD-LTE Band 13: Rx: 746-756MHz, FDD-LTE Band 17: Rx: 734-746MHz
RF Output Power:	FDD-LTE Band 2: 23.76dBm, FDD-LTE Band 4: 23.59dBm, FDD-LTE Band 5: 23.32dBm, FDD-LTE Band 7: 22.67dBm, FDD-LTE Band 12: 23.16dBm, FDD-LTE Band 13: 23.24dBm, FDD-LTE Band 17: 22.89dBm
Type of Modulation:	QPSK, 16QAM
Antenna Type:	Integral Antenna
Antenna Gain:	FDD-LTE Band 2: 1.86dBi, FDD-LTE Band 4: 1.89dBi, FDD-LTE Band 5: 1.21dBi, FDD-LTE Band 7: 2.06dBi, FDD-LTE Band 12: 0.58dBi, FDD-LTE Band 13: 1.20dBi, FDD-LTE Band 17: 0.61dBi,
WIFI	
Support Standards:	802.11b, 802.11g, 802.11n
Frequency Range:	2412-2462MHz for 11b/g/n(HT20) 2422-2452MHz for 11n(HT40)
RF Output Power:	15.31dBm (Conducted)
Type of Modulation:	CCK, QPSK, BPSK, 16QAM, 64QAM
Data Rate:	1-11Mbps, 6-54Mbps, up to 150Mbps
Quantity of Channels:	11/7
Channel Separation:	5MHz
Antenna Type:	Integral Antenna
Antenna Gain:	1.92dBi
Bluetooth	
Bluetooth Version:	V4.0
Frequency Range:	2402-2480MHz
RF Output Power:	5.711dBm (Conducted)
Data Rate:	1Mbps, 2Mbps, 3Mbps
Modulation:	GFSK, Pi/4 QDPSK, 8DPSK
Quantity of Channels:	79/40
Channel Separation:	1MHz/2MHz
Antenna Type:	Integral Antenna
Antenna Gain:	1.92dBi

1.2 Test Standards

The following report is prepared on behalf of the Shenzhen Inrico Electronics Co., LTD in accordance with FCC 47 CFR Part 2.1093, ANSI/IEEE C95.1-2005, ANSI / IEEE C95.3 :2002, IEEE 1528-2013, KDB 447498 D01 v06, KDB 648474 D04 v01r03, KDB 941225 D01 v03r01, KDB 941225 D05 v02r05 and KDB 865664 D01 v01r04 and KDB 865664 D02 v01r02 and KDB 248227 D01 v02r02.

The objective is to determine compliance with FCC Part 2.1093 of the Federal Communication Commissions rules.

Maintenance of compliance is the responsibility of the manufacturer. Any modification of the product, which result in lowering the emission, should be checked to ensure compliance has been maintained.

1.3 Test Methodology

All measurements contained in this report were conducted with KDB 865664 D01 v01r04 and KDB 865664 D02 v01r02. The public notice KDB 447498 D01 v06 for Mobile and Portable Devices RF Exposure Procedure also.

1.4 Test Facility

FCC – Registration No.: 125990

Shenzhen SEM Test Technology Co., Ltd. Laboratory has been recognized to perform compliance testing on equipment subject to the Commissions Declaration Of Conformity (DOC). The Designation Number is CN5010, and Test Firm Registration Number is 125990.

Industry Canada (IC) Registration No.: 11464A

The 3m Semi-anechoic chamber of Shenzhen SEM.Test Technology Co., Ltd. has been registered by Certification and Engineering Bureau of Industry Canada for radio equipment testing with Registration No.: 11464A.

2. Summary of Test Results

The maximum results of Specific Absorption Rate (SAR) have found during testing are as follows:

Front-of-face(25mm Gap)

Frequency Band	Front-of-face (25mm Gap)	SAR _{1g} Limit (W/kg)
	Maximum SAR _{1g} (W/kg)	
GSM	0.340	1.6
WCDMA	0.208	1.6
LTE	0.254	1.6
WLAN 2.4G	0.046	1.6
Simultaneous Transmission	0.386	1.6

Body(0mm Gap)

Frequency Band	Body (0mm Gap)	SAR _{1g} Limit (W/kg)
	Maximum SAR _{1g} (W/kg)	
GSM	0.952	1.6
WCDMA	0.457	1.6
LTE	0.624	1.6
WLAN 2.4G	0.145	1.6
Simultaneous Transmission	1.118	1.6

Remark:

The highest reported SAR values for Front-of-face, body and simultaneous transmission conditions are 0.340W/kg, 0.952W/kg, and 1.118W/kg respectively.

The device is in compliance with Specific Absorption Rate (SAR) for general population/uncontrolled exposure limits (1.6 W/kg) specified in FCC 47 CFR Part 2.1093 and ANSI/IEEE C95.1-2005, and had been tested in accordance with the measurement methods and procedure specified in IEEE 1528-2013 and KDB 865664 D01 v01r04 and KDB 865664 D02 v01r02

3. Specific Absorption Rate (SAR)

3.1 Introduction

SAR is related to the rate at which energy is absorbed per unit mass in an object exposed to a radio field. The SAR distribution in a biological body is complicated and is usually carried out by experimental techniques or numerical modeling. The standard recommends limits for two tiers of groups, occupational/controlled and general population/uncontrolled, based on a person's awareness and ability to exercise control over his or her exposure. In general, occupational/controlled exposure limits are higher than the limits for general population/uncontrolled.

3.2 SAR Definition

The SAR definition is the time derivative (rate) of the incremental energy (dW) absorbed by (dissipated in) an incremental mass (dm) contained in a volume element (dv) of a given density (ρ). The equation description is as below:

$$\text{SAR} = \frac{d}{dt} \left(\frac{dW}{dm} \right) = \frac{d}{dt} \left(\frac{dW}{\rho dv} \right)$$

SAR is expressed in units of Watts per kilogram (W/kg)

SAR measurement can be either related to the temperature elevation in tissue by

$$\text{SAR} = C \left(\frac{\delta T}{\delta t} \right)$$

Where: C is the specific heat capacity, δT is the temperature rise and δt is the exposure duration, or related to the electrical field in the tissue by

$$\text{SAR} = \frac{\sigma |E|^2}{\rho}$$

Where: σ is the conductivity of the tissue, ρ is the mass density of the tissue and E is the RMS electrical field strength.

However for evaluating SAR of low power transmitter, electrical field measurement is typically applied.

4. SAR Measurement System

4.1 The Measurement System

Comosar is a system that is able to determine the SAR distribution inside a phantom of human being according to different standards. The Comosar system consists of the following items:

- Main computer to control all the system
- 6 axis robot
- Data acquisition system
- Miniature E-field probe
- Phone holder
- Head simulating tissue

The following figure shows the system.



The EUT under test operating at the maximum power level is placed in the phone holder, under the phantom, which is filled with head simulating liquid. The E-Field probe measures the electric field inside the phantom. The OpenSAR software computes the results to give a SAR value in a 1g or 10g mass.

4.2 Probe

For the measurements the Specific Dosimetric E-Field Probe SSE5 SN 09/13 EP168 with following specifications is used

- Dynamic range: 0.01-100 W/kg
- Probe Length: 330 mm
- Length of Individual Dipoles: 4.5 mm
- Maximum external diameter: 8 mm
- Probe Tip External Diameter : 5 mm
- Distance between dipoles / probe extremity: 2.7mm

- Probe linearity: <0.25 dB
 - Axial Isotropy: <0.25 dB
 - Spherical Isotropy: <0.50 dB
 - Calibration range: 700 to 3000MHz for head & body simulating liquid.
- Angle between probe axis (evaluation axis) and surface normal line: less than 30°

Probe calibration is realized, in compliance with EN 62209-1 and IEEE 1528 STD, with CALISAR, Antenna proprietary calibration system. The calibration is performed with the EN 62209-1 annexe technique using reference guide at the five frequencies.

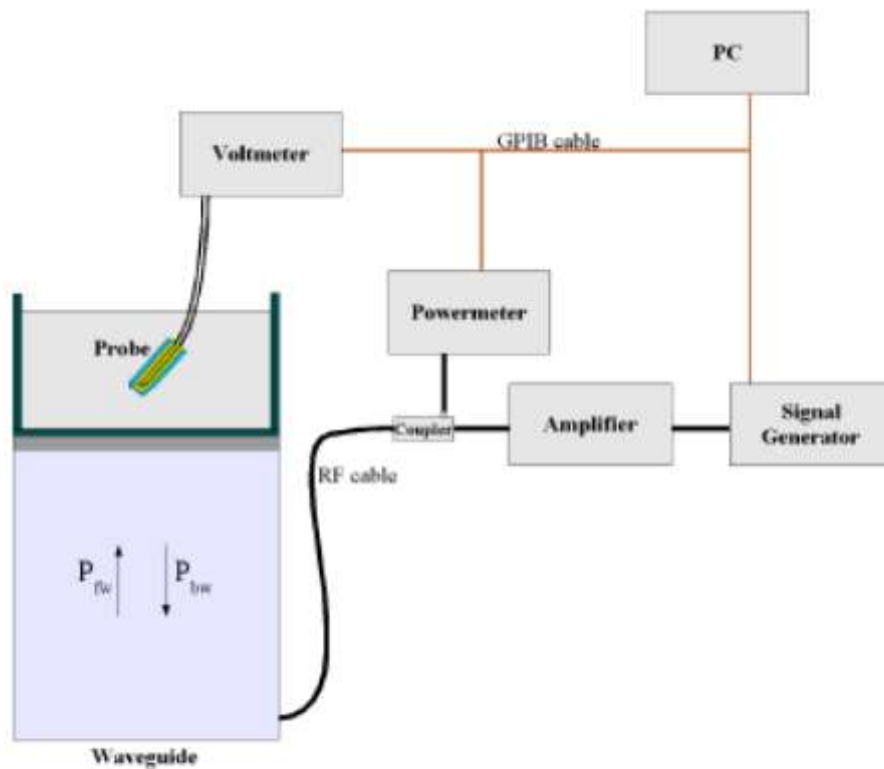

$$SAR = \frac{4(P_{fw} - P_{bw})}{ab\delta} \cos^2\left(\pi \frac{y}{a}\right) e^{-2z/\delta}$$

Where :

P_{fw} = Forward Power

P_{bw} = Backward Power

a and b = Waveguide dimensions

δ = Skin depth

Keithley configuration:

Rate = Medium; Filter = ON; RDGS = 10; Filter type = Moving Average; Range auto after each calibration, a SAR measurement is performed on a validation dipole and compared with a NPL calibrated probe, to verify it.

The calibration factors, CF(N), for the 3 sensors corresponding to dipole 1, dipole 2 and dipole 3 are:

$$CF(N)=SAR(N)/V_{lin}(N) \quad (N=1,2,3)$$

The linearised output voltage $V_{lin}(N)$ is obtained from the displayed output voltage $V(N)$ using

$$V_{lin}(N)=V(N)*(1+V(N)/DCP(N)) \quad (N=1,2,3)$$

where DCP is the diode compression point in mV.

4.3 Probe Calibration Process

Dosimetric Assessment Procedure

Each E-Probe/Probe Amplifier combination has unique calibration parameters. SATIMO Probe calibration procedure is conducted to determine the proper amplifier settings to enter in the probe parameters. The amplifier settings are determined for a given frequency by subjecting the probe to a known E-field density (1 mW/cm²) using an with CALISAR, Antenna proprietary calibration system.

Free Space Assessment Procedure

The free space E-field from amplified probe outputs is determined in a test chamber. This calibration can be performed in a TEM cell if the frequency is below 1 GHz and in a waveguide or other methodologies above 1 GHz for free space. For the free space calibration, the probe is placed in the volumetric center of the cavity and at the proper orientation with the field. The probe is rotated 360 degrees until the three channels show the maximum reading. The power density readings equates to 1mW/cm².

Temperature Assessment Procedure

E-field temperature correlation calibration is performed in a flat phantom filled with the appropriate simulated head tissue. The E-field in the medium correlates with the temperature rise in the dielectric medium. For temperature correlation calibration a RF transparent thermistor-based temperature probe is used in conjunction with the E-field probe.

Where:

$$SAR = C \frac{\Delta T}{\Delta t}$$

Δt = exposure time (30 seconds),

C = heat capacity of tissue (brain or muscle),

ΔT = temperature increase due to RF exposure.

SAR is proportional to $\Delta T/\Delta t$, the initial rate of tissue heating, before thermal diffusion takes place. The electric field in the simulated tissue can be used to estimate SAR by equating the thermally derived SAR to that with the E- field component.

$$\text{SAR} = \frac{|E|^2 \cdot \sigma}{\rho}$$

Where:

σ = simulated tissue conductivity,

ρ = Tissue density (1.25 g/cm³ for brain tissue)

4.4 Phantom

For the measurements the Specific Anthropomorphic Mannequin (SAM) defined by the IEEE SCC-34/SC2 group is used. The phantom is a polyurethane shell integrated in a wooden table. The thickness of the phantom amounts to 2mm +/- 0.2mm. It enables the dosimetric evaluation of left and right phone usage and includes an additional flat phantom part for the simplified performance check. The phantom set-up includes a cover, which prevents the evaporation of the liquid.

4.5 Device Holder

The positioning system allows obtaining cheek and tilting position with a very good accuracy. In compliance with CENELEC, the tilt angle uncertainty is lower than 1°.

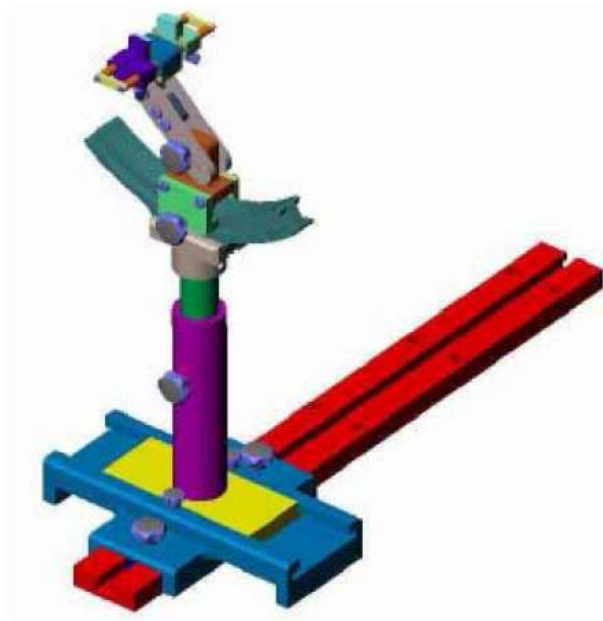

System Material	Permittivity	Loss Tangent
Delrin	3.7	0.005

4.6 Test Equipment List

Description	Manufacturer	Model	Serial Number	Cal. Date	Due. Date
E-Field Probe	MVG	SSE5	SN 09/13 EP168	2018-06-01	2019-05-31
750MHz Dipole	MVG	SID750	SN 47/12 DIP 0G750-203	2019-03-16	2020-03-15
835MHz Dipole	MVG	SID835	SN 47/12 DIP 0G835-204	2019-03-16	2020-03-15
1800MHz Dipole	MVG	SID1800	SN 47/12 DIP 1G800-206	2019-03-16	2020-03-15
1900MHz Dipole	MVG	SID1900	SN 47/12 DIP 1G900-207	2019-03-16	2020-03-15
2450MHz Dipole	MVG	SID2450	SN 13/15 DIP 2G450-364	2019-03-16	2020-03-15
2600MHz Dipole	MVG	SID2600	SN 13/15 DIP 2G600-365	2019-03-16	2020-03-15
Dielectric Probe Kit	SATIMO	SCLMP	SN 47/12 OCPG49	2019-03-16	2020-03-15
SAM Phantom	SATIMO	SAM	SN/ 47/12 SAM95	N/A	N/A
MULTIMETER	KEITHLEY	Keithley 2000	4006367	2018-05-22	2019-05-21
Signal Generator	Rohde & Schwarz	SMR20	100047	2018-05-22	2019-05-21
Universal Tester	Rohde & Schwarz	CMU200	112315	2018-05-22	2019-05-21
Communications Tester	Rohde & Schwarz	CMW500	148650	2018-05-22	2019-05-21
Network Analyzer	HP	8753C	SEMT-1064	2018-05-22	2019-05-21
Directional Couplers	Agilent	778D	20160	2018-05-22	2019-05-21

5. Tissue Simulating Liquids

5.1 Composition of Tissue Simulating Liquid

For the measurement of the field distribution inside the SAM phantom with SMTIMO, the phantom must be filled with around 25 liters of homogeneous body tissue simulating liquid. For head SAR testing, the liquid height from the ear reference point (ERP) of the phantom to the liquid top surface is larger than 15 cm. For body SAR testing, the liquid height from the center of the flat phantom to the liquid top surface is larger than 15 cm. The depth of tissue-equivalent liquid in a phantom must be ≥ 15.0 cm with $\leq \pm 0.5$ cm variation for SAR measurements ≤ 3 GHz. Please see the following photos for the liquid height.



Liquid Height for Head SAR



Liquid Height for Body SAR

The Composition of Tissue Simulating Liquid

Frequency (MHz)	Water (%)	Salt (%)	Sugar (%)	HEC (%)	Preventol (%)	DGBE (%)
Head						
750	41.1	1.4	57.0	0.2	0.3	0
835	40.3	1.4	57.9	0.2	0.2	0
1800-1900	55.2	0.3	0	0	0	44.5
2450	55.0	0.1	0	0	0	44.9
2600	54.9	0.1	0	0	0	45.0
Body						
750	50.0	0.8	48.8	0.2	0.2	0
835	50.8	0.9	48.1	0.1	0.1	0
1800-1900	70.2	0.4	0	0	0	29.4
2450	68.6	0.1	0	0	0	31.3
2600	68.2	0.1	0	0	0	31.7

5.2 Tissue Dielectric Parameters for Head and Body Phantoms

The head tissue dielectric parameters recommended by the IEEE SCC-34/SC-2 in P1528 have been incorporated in the following table. These head parameters are derived from planar layer models simulating the highest expected SAR for the dielectric properties and tissue thickness variations in a human head. Other head and body tissue parameters that have not been specified in P1528 are derived from the tissue dielectric parameters computed from the 4-Cole-Cole equations described in Reference [12] and extrapolated according to the head parameters specified in P1528.

Target Frequency (MHz)	Head		Body	
	Conductivity (σ)	Permittivity (ϵ_r)	Conductivity (σ)	Permittivity (ϵ_r)
150	0.76	52.3	0.80	61.9
300	0.87	45.3	0.92	58.2
450	0.87	43.5	0.94	56.7
750	0.89	41.9	0.96	55.5
835	0.90	41.5	0.97	55.2
900	0.97	41.5	1.05	55.0
915	0.98	41.5	1.06	55.0
1450	1.20	40.5	1.30	54.0
1610	1.29	40.3	1.40	53.8
1750	1.37	40.1	1.49	53.4
1800-2000	1.40	40.0	1.52	53.3
2450	1.80	39.2	1.95	52.7
3000	2.40	38.5	2.73	52.0
5800	5.27	35.3	6.00	48.2

5.3 Tissue Calibration Result

The dielectric parameters of the liquids were verified prior to the SAR evaluation using COMOSAR Dielectric Probe Kit and an Agilent Network Analyzer.

Calibration Result for Dielectric Parameters of Tissue Simulating Liquid

Head Tissue Simulating Liquid									
Freq. MHz.	Temp. (°C)	Conductivity			Permittivity			Limit (%)	Date
		Reading (σ)	Target (σ)	Delta (%)	Reading (ϵ_r)	Target (ϵ_r)	Delta (%)		
750	21.2	0.86	0.89	-3.37	41.32	41.90	-1.38	±5	2019-04-16
835	21.2	0.87	0.90	-3.33	41.11	41.50	-0.94	±5	2019-04-16
1750	21.3	1.37	1.37	0.00	39.02	40.1	-2.69	±5	2019-04-17
1800	21.3	1.37	1.40	-2.14	39.02	40.0	-2.45	±5	2019-04-17
1900	21.3	1.38	1.40	-1.43	38.56	40.00	-3.60	±5	2019-04-17
2450	21.3	1.74	1.80	-3.33	38.15	39.20	-2.68	±5	2019-04-18
2600	21.3	1.93	1.96	-1.53	38.63	39.0	-0.95	±5	2019-04-18

Body Tissue Simulating Liquid									
Freq. MHz.	Temp. (°C)	Conductivity			Permittivity			Limit (%)	Date
		Reading (σ)	Target (σ)	Delta (%)	Reading (ϵ_r)	Target (ϵ_r)	Delta (%)		
750	21.2	0.93	0.96	-3.12	54.96	55.50	-0.97	±5	2019-04-16
835	21.2	0.95	0.97	-2.06	54.85	55.20	-0.63	±5	2019-04-16
1750	21.3	1.46	1.49	-2.01	51.22	53.40	-4.08	±5	2019-04-17
1800	21.3	1.46	1.52	-3.95	51.22	53.30	-3.90	±5	2019-04-17
1900	21.3	1.50	1.52	-1.32	52.42	53.30	-1.65	±5	2019-04-17
2450	21.3	1.91	1.95	-2.05	52.01	52.70	-1.31	±5	2019-04-18
2600	21.3	2.12	2.16	-1.85	52.24	52.50	-0.50	±5	2019-04-18

6. SAR Measurement Evaluation

6.1 Purpose of System Performance Check

The system performance check verifies that the system operates within its specifications. System and operator errors can be detected and corrected. It is recommended that the system performance check be performed prior to any usage of the system in order to guarantee reproducible results. The system performance check uses normal SAR measurements in a simplified setup with a well characterized source. This setup was selected to give a high sensitivity to all parameters that might fail or vary over time. The system check does not intend to replace the calibration of the components, but indicates situations where the system uncertainty is exceeded due to drift or failure.

6.2 System Setup

In the simplified setup for system evaluation, the EUT is replaced by a calibrated dipole and the power source is replaced by a continuous wave which comes from a signal generator at frequency 750 MHz, 835 MHz, 1750 MHz, 1800 MHz, 1900 MHz, 2450MHz and 2600MHz. The calibrated dipole must be placed beneath the flat phantom section of the SAM twin phantom with the correct distance holder. The distance holder should touch the phantom surface with a light pressure at the reference marking and be oriented parallel to the long side of the phantom.

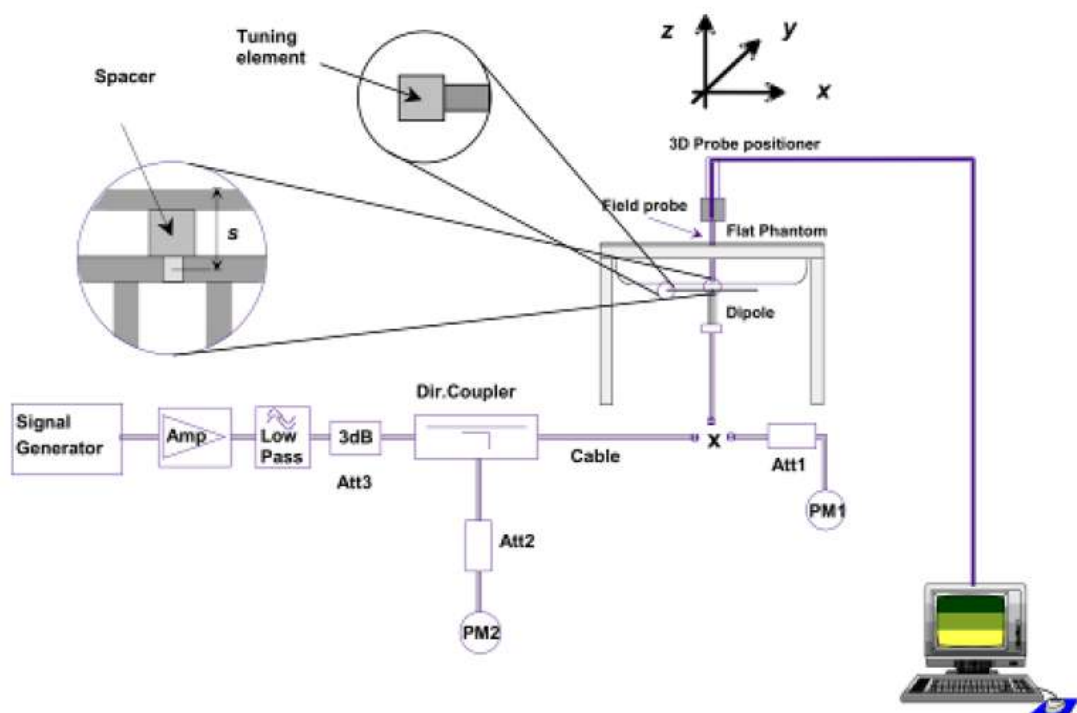

System Verification Setup Block Diagram



Setup Photo of Dipole Antenna

The output power on dipole port must be calibrated to 24 dBm(250 mW) before dipole is connected.

6.3 Validation Results

Comparing to the original SAR value provided by SATIMO, the validation data should be within its specification of 10 %. Table 6.1 shows the target SAR and measured SAR after normalized to 1W input power. The table below indicates the system performance check can meet the variation criterion.

Frequency MHz	Targeted SAR _{1g} (W/kg)	Measured SAR _{1g} (W/kg)	Normalized SAR _{1g} (W/kg)	Tolerance (%)	Date
Head					
750	8.40	2.16	8.64	2.86	2019-04-16
835	9.65	2.41	9.64	-0.10	2019-04-16
1800	38.49	9.61	38.44	-0.13	2019-04-17
1900	39.59	9.91	39.64	0.13	2019-04-17
2450	53.76	13.45	53.8	0.07	2019-04-18
2600	55.07	13.67	54.68	-0.71	2019-04-18
Body					
750	8.40	2.12	8.48	0.95	2019-04-16
835	9.36	2.35	9.4	0.43	2019-04-16
1800	38.29	9.58	38.32	0.08	2019-04-17
1900	39.01	9.78	39.12	0.28	2019-04-17
2450	50.33	12.59	50.36	0.06	2019-04-18
2600	53.92	13.43	53.72	-0.37	2019-04-18

Remark: Referring to IEEE 1528-2013, Section 8.2, The system check shall be performed at a test frequency that

is within $\pm 10\%$ or ± 100 MHz of the compliance test mid-band frequency, so the 1750 MHz system verification is made of 1800MHz Dipole.

Targeted and Measurement SAR

Please refer to Annex A for the plots of system performance check.

7. EUT Testing Position

7.1 EUT Antenna Position

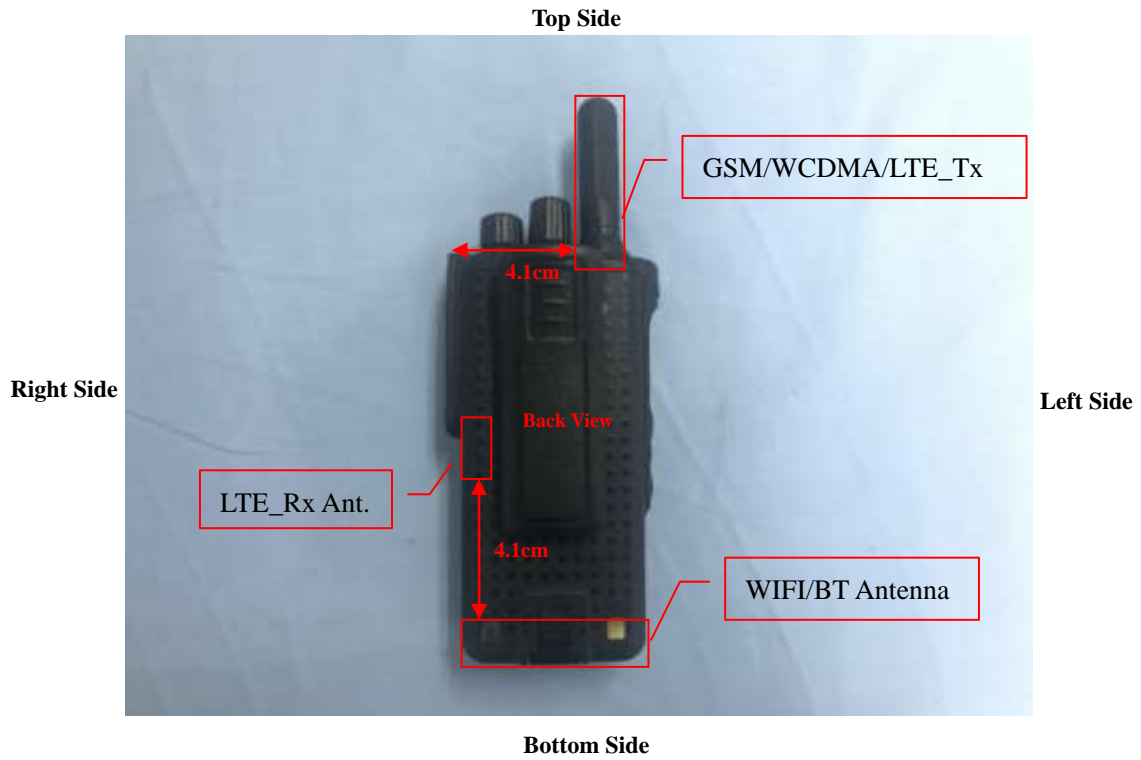

Block Diagram for EUT Antenna Position

7.2 EUT Testing Position

Body/ Front-of-face mode SAR assessments are required for this device. This EUT was tested in different positions for different SAR test modes, more information as below:

Body SAR tests, Test distance: 0mm		
Antennas	Front	Back
WWAN	No	Yes
WLAN	No	Yes

Front-of-face SAR tests, Test distance: 25mm		
Antennas	Front	Back
WWAN	Yes	No
WLAN	Yes	No

Remark:

1. Referring to KDB 447498 D01 v06, A test separation distance of 25mm must be applied for in-front-of the face SAR test exclusion and SAR measurement .
- 2 With body worn SAR, the belt-clip is used for body worn operation with only back side position of the device which is touching the body, so body worn SAR for only back side position is performed.
3. The typical use of the product would be the front of the device to the face.
4. The EUT is not a typical of PTT devices, which is supports 2G/3G/4G network communication, so PTT duty cycle correction is not need.
5. Referring to KDB 447498 D01 v06 , All body-worn accessories containing metallic components, either supplied with the product or available as an option from the device manufacturer, must be tested in conjunction with the host device to demonstrate compliance, So tested with belt clip when evaluating body-worn SAR.
6. RF energy will be generated only when the radio is transmitting.
7. The EUT must be 2.5cm away from human face when transmitting. With body worn SAR, the typical use of the products is with the belt clip, and the belt clip t is not to remove. So tested with belt clip when evaluating body-worn SAR.

Please refer to Annex D for the EUT test setup photos.

8. SAR Measurement Procedures

8.1 Measurement Procedures

The measurement procedures are as follows:

- (a) Use base station simulator (if applicable) or engineering software to transmit RF power continuously (continuous Tx) in the highest power channel.
- (b) Keep EUT to radiate maximum output power or 100% factor (if applicable)
- (c) Measure output power through RF cable and power meter.
- (d) Place the EUT in the positions as Annex D demonstrates.
- (e) Set scan area, grid size and other setting on the SATIMO software.
- (f) Measure SAR results for the highest power channel on each testing position.
- (g) Find out the largest SAR result on these testing positions of each band
- (h) Measure SAR results for other channels in worst SAR testing position if the SAR of highest power channel is larger than 0.8 W/kg

According to the test standard, the recommended procedure for assessing the peak spatial-average SAR value consists of the following steps:

- (a) Power reference measurement
- (b) Area scan
- (c) Zoom scan
- (d) Power drift measurement

8.2 Spatial Peak SAR Evaluation

The procedure for spatial peak SAR evaluation has been implemented according to the test standard. It can be conducted for 1g and 10g, as well as for user-specific masses. The SATIMO software includes all numerical procedures necessary to evaluate the spatial peak SAR value.

The base for the evaluation is a "cube" measurement. The measured volume must include the 1g and 10g cubes with the highest averaged SAR values. For that purpose, the center of the measured volume is aligned to the interpolated peak SAR value of a previously performed area scan.

The entire evaluation of the spatial peak values is performed within the post-processing engine. The system always gives the maximum values for the 1g and 10g cubes. The algorithm to find the cube with highest averaged SAR is divided into the following stages:

- (a) Extraction of the measured data (grid and values) from the Zoom Scan
- (b) Calculation of the SAR value at every measurement point based on all stored data
- (c) Generation of a high-resolution mesh within the measured volume
- (d) Interpolation of all measured values from the measurement grid to the high-resolution grid
- (e) Extrapolation of the entire 3D field distribution to the phantom surface over the distance from sensor to surface
- (f) Calculation of the averaged SAR within masses of 1g and 10g

8.3 Area & Zoom Scan Procedures

First Area Scan is used to locate the approximate location(s) of the local peak SAR value(s). The measurement grid within an Area Scan is defined by the grid extent, grid step size and grid offset. Next, in order to determine the EM field distribution in a three-dimensional spatial extension, Zoom Scan is required. The Zoom Scan measures 5x5x7 points with step size 8, 8 and 5 mm for 300 MHz to 3 GHz, and 8x8x8 points with step size 4, 4 and 2.5 mm for 3 GHz to 6 GHz. The Zoom Scan is performed around the highest E-field value to determine the averaged SAR-distribution over 10 g.

8.4 Volume Scan Procedures

The volume scan is used for assess overlapping SAR distributions for antennas transmitting in different frequency bands. It is equivalent to an oversized zoom scan used in standalone measurements. The measurement volume will be used to enclose all the simultaneous transmitting antennas. For antennas transmitting simultaneously in different frequency bands, the volume scan is measured separately in each frequency band. In order to sum correctly to compute the 1g aggregate SAR, the EUT remain in the same test position for all measurements and all volume scan use the same spatial resolution and grid spacing (step-size is 4, 4 and 2.5 mm). When all volume scan were completed, the software can combine and subsequently superpose these measurement data to calculating the multiband SAR.

8.5 SAR Averaged Methods

The local SAR inside the phantom is measured using small dipole sensing elements inside a probe body. The probe tip must not be in contact with the phantom surface in order to minimize measurements errors, but the highest local SAR will occur at the surface of the phantom.

An extrapolation is using to determinate this highest local SAR values. The extrapolation is based on a fourth-order least-square polynomial fit of measured data. The local SAR value is then extrapolated from the liquid surface with a 1mm step.

The measurements have to be performed over a limited time (due to the duration of the battery) so the step of measurement is high. It could vary between 5 and 8 mm. To obtain an accurate assessment of the maximum SAR averaged over 10g and 1 g requires a very fine resolution in the three dimensional scanned data array.

8.6 Power Drift Monitoring

All SAR testing is under the EUT install full charged battery and transmit maximum output power. In SATIMO measurement software, the power reference measurement and power drift measurement procedures are used for monitoring the power drift of EUT during SAR test. Both these procedures measure the field at a specified reference position before and after the SAR testing. The software will calculate the field difference in dB. If the power drift more than 5%, the SAR will be retested.

9. SAR Test Result

9.1 Conducted RF Output Power

GSM - Burst Average Power (dBm)								
Band	GSM850			Tune-up power (dBm)	PCS1900			Tune-up power (dBm)
Channel	128	190	251		512	661	810	
Frequency (MHz)	824.2	836.6	848.8		1850.2	1880	1909.8	
GSM	31.6	31.85	32.02	32.5	29.06	28.79	29.00	29.5
GPRS (1 slot)	31.63	31.73	31.73	32.0	29.08	28.88	29.09	29.5
GPRS (2 slots)	30.87	30.98	30.99	31.0	28.36	28.18	28.40	28.5
GPRS (3 slots)	29.10	29.20	29.25	29.5	26.65	26.46	26.72	27.0
GPRS (4 slots)	27.99	28.12	28.17	28.5	25.59	25.36	25.66	26.0
EGPRS (1 slot)	26.29	26.69	26.67	27.0	25.77	25.66	25.52	26.0
EGPRS (2 slots)	25.16	25.51	25.50	26.0	24.81	24.70	24.58	25.0
EGPRS (3 slots)	22.91	23.26	23.17	23.5	22.71	22.58	22.45	23.0
EGPRS (4 slots)	21.70	21.87	21.89	22.0	21.69	21.49	21.44	22.0

GSM - Source-Based Time-Average Power (dBm)								
Band	GSM850			Tune-up power (dBm)	PCS1900			Tune-up power (dBm)
Channel	128	190	251		512	661	810	
Frequency (MHz)	824.2	836.6	848.8		1850.2	1880	1909.8	
GSM	22.60	22.85	23.02	23.5	20.06	19.79	20.00	20.5
GPRS (1 slot)	22.63	22.73	22.73	23.0	20.08	19.88	20.09	20.5
GPRS (2 slots)	24.87	24.98	24.99	25.0	22.36	22.18	22.40	22.5
GPRS (3 slots)	24.85	24.95	25.00	25.5	22.40	22.21	22.47	22.5
GPRS (4 slots)	24.99	25.12	25.17	25.5	22.59	22.36	22.66	23.0
EGPRS (1 slot)	17.29	17.69	17.67	18.0	16.77	16.66	16.52	17.0
EGPRS (2 slots)	19.16	19.51	19.50	20.0	18.81	18.70	18.58	19.0
EGPRS (3 slots)	18.66	19.01	18.92	19.5	18.46	18.33	18.20	18.5
EGPRS (4 slots)	18.70	18.87	18.89	19.0	18.69	18.49	18.44	19.0

Note: The source-based time-averaged power is linearly scaled the maximum burst averaged power based on time slots. The calculated method are shown as below:

Source based time-average power = Burst averaged power - Duty cycle factor in dB

Duty cycle factor = 9 dB for 1 Tx slot, 6 dB for 2 Tx slots, 4.25 dB for 3 Tx slots, 3 dB for 4 Tx slots

Remark:

1. For Front-of-face SAR testing, GSM and GPRS (4TX slots) and GPRS (4TX slots) should be evaluated, therefore the EUT was set in GSM and GPRS (4TX slots) for GSM850 and GPRS (4TX slots) for GSM1900 due to its highest source-based time-average power.
2. For Body SAR testing, GPRS should be evaluated, therefore the EUT was set in GPRS (4TX slots) for GSM850 and

GPRS (4TX slots) for GSM1900 due to its highest source-based time-average power.

3. Per KDB 447498 D01 v06, the maximum output power channel is used for SAR testing and for further SAR test reduction.

4. The DUT do not support DTM function.

WCDMA - Average Power (dBm)								
Band	WCDMA Band II				WCDMA Band V			
Channel	9262	9400	9538	Tune-up power (dBm)	4132	4182	4233	Tune-up power (dBm)
Frequency (MHz)	1852.4	1880.0	1907.6		826.4	836.6	846.6	
RMC 12.2k	22.84	22.35	22.58	23.0	22.88	22.80	22.66	23.0
HSDPA Subtest-1	22.50	21.98	21.88	23.0	21.41	21.27	21.29	21.5
HSDPA Subtest-2	22.48	21.96	21.83	23.0	21.38	21.25	21.26	21.5
HSDPA Subtest-3	22.47	21.97	21.85	23.0	21.39	21.25	21.26	21.5
HSDPA Subtest-4	22.46	21.97	21.84	23.0	21.38	21.24	21.27	21.5
HSUPA Subtest-1	22.53	21.91	21.79	23.0	21.33	21.20	21.28	21.5
HSUPA Subtest-2	22.52	21.87	21.75	23.0	21.31	21.18	21.25	21.5
HSUPA Subtest-3	22.51	21.89	21.76	23.0	21.31	21.17	21.25	21.5
HSUPA Subtest-4	22.51	21.87	21.75	23.0	21.3	21.17	21.26	21.5
HSUPA Subtest-5	22.52	21.86	21.76	23.0	21.3	21.17	21.26	21.5

Remark:

1. Per KDB 941225 D01 v03, The 12.2kbps RMC mode was selected for SAR testing(the primary mode).
2. When the maximum output power and tune-up tolerance specified for production units in a secondary mode is $\leq 1/4$ dB higher than the primary mode or when the highest reported SAR of the primary mode is scaled by the ratio of specified maximum output power and tune-up tolerance of secondary to primary mode and the adjusted SAR is ≤ 1.2 W/kg, SAR measurement is not required for the secondary mode

FDD-LTE Band 2:

Channel Bandwidth: 1.4 MHz					
Modulation	Channel	RB Configuration		Average Power [dBm]	MPR (dB)
		Size	Offset		
QPSK	LCH	1	0	23.61	0
		1	3	23.69	0
		1	5	23.52	0
		3	0	22.5	0
		3	2	22.56	0
		3	3	22.53	0
		6	0	22.65	1
	MCH	1	0	22.62	0
		1	3	22.75	0
		1	5	22.62	0
		3	0	22.68	0
		3	2	22.68	0
		3	3	22.65	0
		6	0	21.79	1
	HCH	1	0	22.68	0
		1	3	22.77	0
		1	5	22.7	0
		3	0	22.72	0
		3	2	22.72	0
		3	3	22.77	0
		6	0	21.86	1
16QAM	LCH	1	0	22.69	1
		1	3	22.36	1
		1	5	22.71	1
		3	0	22.68	1
		3	2	22.67	1
		3	3	22.68	1
		6	0	21.53	2
	MCH	1	0	21.93	1
		1	3	22.14	1
		1	5	21.94	1
		3	0	21.68	1
		3	2	21.73	1
		3	3	21.68	1
		6	0	20.64	2
HCH	1	0	21.91	1	
	1	3	22.14	1	

		1	5	21.97	1
		3	0	21.88	1
		3	2	21.88	1
		3	3	21.93	1
		6	0	20.89	2

Channel Bandwidth: 3 MHz					
Modulation	Channel	RB Configuration		Average Power [dBm]	MPR (dB)
		Size	Offset		
QPSK	LCH	1	0	23.48	0
		1	7	23.7	0
		1	14	23.41	0
		8	0	22.64	1
		8	4	22.64	1
		8	7	22.59	1
		15	0	22.57	1
	MCH	1	0	22.69	0
		1	7	22.91	0
		1	14	22.62	0
		8	0	21.8	1
		8	4	21.79	1
		8	7	21.77	1
		15	0	21.68	1
	HCH	1	0	22.66	0
		1	7	22.78	0
		1	14	22.73	0
		8	0	21.77	1
		8	4	21.85	1
		8	7	21.79	1
		15	0	21.77	1
16QAM	LCH	1	0	22.74	1
		1	7	22.64	1
		1	14	22.73	1
		8	0	21.62	2
		8	4	21.64	2
		8	7	21.52	2
		15	0	21.47	2
	MCH	1	0	21.99	1
		1	7	22.19	1
		1	14	22.02	1
		8	0	20.7	2
		8	4	20.7	2
		8	7	20.66	2

	HCH	15	0	20.67	2
		1	0	21.92	1
		1	7	22.18	1
		1	14	21.98	1
		8	0	20.65	2
		8	4	20.76	2
		8	7	20.67	2
		15	0	20.71	2

Channel Bandwidth: 5 MHz					
Modulation	Channel	RB Configuration		Average Power [dBm]	MPR (dB)
		Size	Offset		
QPSK	LCH	1	0	23.49	0
		1	12	23.75	0
		1	24	23.35	0
		12	0	22.56	1
		12	6	22.61	1
		12	13	22.49	1
		25	0	22.54	1
	MCH	1	0	22.63	0
		1	12	22.94	0
		1	24	22.58	0
		12	0	21.73	1
		12	6	21.76	1
		12	13	21.65	1
		25	0	21.7	1
	HCH	1	0	22.61	0
		1	12	23.01	0
		1	24	22.69	0
		12	0	21.78	1
		12	6	21.76	1
		12	13	21.69	1
		25	0	21.71	1
16QAM	LCH	1	0	22.7	1
		1	12	23	1
		1	24	22.66	1
		12	0	21.61	2
		12	6	21.66	2
		12	13	21.48	2
		25	0	21.51	2
	MCH	1	0	21.79	1
		1	12	22.12	1
		1	24	21.84	1

		12	0	20.79	2
		12	6	20.86	2
		12	13	20.74	2
		25	0	20.68	2
	HCH	1	0	21.74	1
		1	12	22.08	1
		1	24	21.91	1
		12	0	20.69	2
		12	6	20.74	2
		12	13	20.67	2
		25	0	20.67	2

Channel Bandwidth: 10 MHz					
Modulation	Channel	RB Configuration		Average Power [dBm]	MPR (dB)
		Size	Offset		
QPSK	LCH	1	0	23.44	0
		1	24	23.46	0
		1	49	23.14	0
		25	0	22.57	1
		25	12	22.45	1
		25	25	22.48	1
		50	0	22.52	1
	MCH	1	0	22.71	0
		1	24	22.72	0
		1	49	22.54	0
		25	0	21.83	1
		25	12	21.71	1
		25	25	21.65	1
		50	0	21.7	1
	HCH	1	0	22.54	0
		1	24	22.67	0
		1	49	22.71	0
		25	0	21.74	1
		25	12	21.67	1
		25	25	21.62	1
		50	0	21.67	1
16QAM	LCH	1	0	22.74	1
		1	24	22.75	1
		1	49	22.48	1
		25	0	21.56	2
		25	12	21.43	2
		25	25	21.47	2
		50	0	21.46	2

	MCH	1	0	21.95	1
		1	24	22.07	1
		1	49	21.99	1
		25	0	20.79	2
		25	12	20.67	2
		25	25	20.67	2
		50	0	20.7	2
	HCH	1	0	21.76	1
		1	24	21.89	1
		1	49	21.98	1
		25	0	20.68	2
		25	12	20.6	2
		25	25	20.6	2
		50	0	20.65	2

Channel Bandwidth: 15 MHz					
Modulation	Channel	RB Configuration		Average Power [dBm]	MPR (dB)
		Size	Offset		
QPSK	LCH	1	0	23.37	0
		1	37	23.41	0
		1	74	22.89	0
		37	0	22.54	1
		37	18	22.46	1
		37	38	22.47	1
		75	0	22.56	1
	MCH	1	0	22.75	0
		1	37	22.94	0
		1	74	22.39	0
		37	0	21.98	1
		37	18	21.86	1
		37	38	21.72	1
		75	0	21.89	1
	HCH	1	0	22.43	0
		1	37	22.72	0
		1	74	22.61	0
		37	0	21.75	1
		37	18	21.76	1
		37	38	21.72	1
		75	0	21.71	1
16QAM	LCH	1	0	22.65	1
		1	37	22.71	1
		1	74	22.17	1
		37	0	21.5	2

		37	18	21.39	2
		37	38	21.38	2
		75	0	21.41	2
	MCH	1	0	21.84	1
		1	37	22	1
		1	74	21.81	1
		37	0	20.88	2
		37	18	20.78	2
		37	38	20.69	2
		75	0	20.76	2
	HCH	1	0	21.74	1
		1	37	21.94	1
		1	74	21.88	1
		37	0	20.62	2
		37	18	20.66	2
		37	38	20.6	2
75		0	20.6	2	

Channel Bandwidth: 20 MHz					
Modulation	Channel	RB Configuration		Average Power [dBm]	MPR (dB)
		Size	Offset		
QPSK	LCH	1	0	23.76	0
		1	49	23.36	0
		1	99	23.56	0
		50	0	22.78	1
		50	25	22.29	1
		50	50	22.31	1
		100	0	22.72	1
	MCH	1	0	22.64	0
		1	49	22.81	0
		1	99	22.26	0
		50	0	21.77	1
		50	25	21.69	1
		50	50	21.59	1
		100	0	21.74	1
	HCH	1	0	22.18	0
		1	49	22.57	0
		1	99	22.33	0
		50	0	21.49	1
		50	25	21.62	1
		50	50	21.39	1
		100	0	21.42	1
16QAM	LCH	1	0	22.47	1

		1	49	22.6	1
		1	99	21.81	1
		50	0	21.27	2
		50	25	21.23	2
		50	50	21.28	2
		100	0	21.27	2
	MCH	1	0	21.88	1
		1	49	22.09	1
		1	99	21.73	1
		50	0	20.75	2
		50	25	20.71	2
		50	50	20.6	2
	HCH	100	0	20.65	2
		1	0	21.58	1
		1	49	21.86	1
		1	99	21.66	1
		50	0	20.53	2
		50	25	20.56	2
		50	50	20.37	2
	100	0	20.46	2	

FDD-LTE Band 4:

Channel Bandwidth: 1.4 MHz					
Modulation	Channel	RB Configuration		Average Power [dBm]	MPR (dB)
		Size	Offset		
QPSK	LCH	1	0	22.76	0
		1	3	22.94	0
		1	5	22.75	0
		3	0	22.53	0
		3	2	22.51	0
		3	3	22.52	0
		6	0	21.82	1
	MCH	1	0	22.79	0
		1	3	22.94	0
		1	5	22.83	0
		3	0	22.59	0
		3	2	22.51	0
		3	3	22.5	0
	HCH	6	0	21.53	1
		1	0	23.21	0
		1	3	23.38	0

		1	5	23.26	0
		3	0	22.28	0
		3	2	22.28	0
		3	3	22.26	0
		6	0	22.32	1
16QAM	LCH	1	0	21.95	1
		1	3	22.07	1
		1	5	21.93	1
		3	0	21.87	1
		3	2	21.87	1
		3	3	21.88	1
		6	0	20.87	2
	MCH	1	0	21.85	1
		1	3	21.95	1
		1	5	21.86	1
		3	0	21.85	1
		3	2	21.86	1
		3	3	21.89	1
		6	0	20.67	2
	HCH	1	0	22.44	1
		1	3	22.67	1
		1	5	22.46	1
		3	0	22.19	1
		3	2	22.22	1
		3	3	22.18	1
		6	0	21.14	2

Channel Bandwidth: 3 MHz					
Modulation	Channel	RB Configuration		Average Power [dBm]	MPR (dB)
		Size	Offset		
QPSK	LCH	1	0	22.7	0
		1	7	22.97	0
		1	14	22.72	0
		8	0	21.72	1
		8	4	21.76	1
		8	7	21.72	1
		15	0	21.7	1
	MCH	1	0	22.78	0
		1	7	22.98	0
		1	14	22.78	0
		8	0	21.77	1
		8	4	21.8	1
		8	7	21.76	1

	HCH	15	0	21.69	1
		1	0	23.24	0
		1	7	23.47	0
		1	14	23.27	0
		8	0	22.26	1
		8	4	22.29	1
		8	7	22.24	1
		15	0	22.2	1
16QAM	LCH	1	0	21.91	1
		1	7	22.13	1
		1	14	21.89	1
		8	0	20.72	2
		8	4	20.74	2
		8	7	20.69	2
		15	0	20.62	2
	MCH	1	0	21.98	1
		1	7	22.23	1
		1	14	22.02	1
		8	0	20.7	1
		8	4	20.7	2
		8	7	20.66	2
		15	0	20.66	2
	HCH	1	0	22.37	2
		1	7	22.59	1
		1	14	22.38	1
		8	0	21.12	1
		8	4	21.14	1
		8	7	21.12	2
		15	0	21.13	2

Channel Bandwidth: 5 MHz					
Modulation	Channel	RB Configuration		Average Power [dBm]	MPR (dB)
		Size	Offset		
QPSK	LCH	1	0	22.75	0
		1	12	23.02	0
		1	24	22.7	0
		12	0	21.66	1
		12	6	21.68	1
		12	13	21.69	1
		25	0	21.73	1
	MCH	1	0	22.73	0
		1	12	22.97	0
		1	24	22.81	0

		12	0	21.69	1	
		12	6	21.74	1	
		12	13	21.7	1	
		25	0	21.71	1	
	HCH	1	0	23.22	0	
		1	12	23.58	0	
		1	24	23.3	0	
		12	0	22.12	1	
		12	6	22.23	1	
		12	13	22.21	1	
		25	0	22.21	1	
		16QAM	LCH	1	0	21.94
	1			12	22.19	1
1	24			21.86	1	
12	0			20.67	2	
12	6			20.74	2	
12	13			20.74	2	
25	0			20.66	2	
MCH	1		0	21.82	1	
	1		12	22.18	1	
	1		24	21.91	1	
	12		0	20.76	2	
	12		6	20.83	2	
	12		13	20.8	2	
	25		0	20.71	2	
HCH	1		0	22.22	1	
	1		12	22.58	1	
	1		24	22.3	1	
	12		0	21.12	2	
	12		6	21.22	2	
	12		13	21.14	2	
	25		0	21.2	2	

Channel Bandwidth: 10 MHz					
Modulation	Channel	RB Configuration		Average Power [dBm]	MPR (dB)
		Size	Offset		
QPSK	LCH	1	0	22.68	0
		1	24	22.87	0
		1	49	22.63	0
		25	0	21.71	1
		25	12	21.7	1
		25	25	21.76	1
		50	0	21.68	1
	MCH	1	0	22.72	0
		1	24	22.95	0
		1	49	22.84	0
		25	0	21.78	1
		25	12	21.8	1
		25	25	21.83	1
		50	0	21.77	1
	HCH	1	0	23.04	0
		1	24	23.33	0
		1	49	23.26	0
		25	0	22.14	1
		25	12	22.16	1
		25	25	22.27	1
		50	0	22.12	1
16QAM	LCH	1	0	21.94	1
		1	24	22.08	1
		1	49	21.84	1
		25	0	20.67	2
		25	12	20.66	2
		25	25	20.73	2
		50	0	20.7	2
	MCH	1	0	21.99	1
		1	24	22.19	1
		1	49	22.08	1
		25	0	20.76	2
		25	12	20.74	2
		25	25	20.83	2
		50	0	20.77	2
	HCH	1	0	22.17	1
		1	24	22.48	1
		1	49	22.36	1
		25	0	21.08	2

		25	12	21.12	2
		25	25	21.2	2
		50	0	21.12	2

Channel Bandwidth: 15 MHz					
Modulation	Channel	RB Configuration		Average Power [dBm]	MPR (dB)
		Size	Offset		
QPSK	LCH	1	0	22.64	0
		1	37	22.9	0
		1	74	22.58	0
		37	0	21.78	1
		37	18	21.81	1
		37	38	21.8	1
		75	0	21.8	1
	MCH	1	0	22.68	0
		1	37	23.01	0
		1	74	22.87	0
		37	0	21.8	1
		37	18	21.91	1
		37	38	21.97	1
		75	0	21.94	1
	HCH	1	0	22.91	0
		1	37	23.37	0
		1	74	23.2	0
		37	0	22.14	1
		37	18	22.21	1
		37	38	22.29	1
		75	0	21.94	1
16QAM	LCH	1	0	21.86	1
		1	37	21.99	1
		1	74	21.79	1
		37	0	20.68	2
		37	18	20.72	2
		37	38	20.71	2
		75	0	20.69	2
	MCH	1	0	21.84	1
		1	37	22.22	1
		1	74	21.99	1
		37	0	20.76	2
		37	18	20.85	2
		37	38	20.91	2
		75	0	20.79	2
HCH	1	0	22.05	1	

		1	37	22.36	1
		1	74	22.31	1
		37	0	20.84	2
		37	18	20.77	2
		37	38	20.8	2
		75	0	20.79	2

Channel Bandwidth: 20 MHz					
Modulation	Channel	RB Configuration		Average Power [dBm]	MPR (dB)
		Size	Offset		
QPSK	LCH	1	0	23.59	0
		1	49	23.57	0
		1	99	23.12	0
		50	0	22.66	1
		50	25	22.64	1
		50	50	22.66	1
		100	0	22.68	1
	MCH	1	0	23.17	0
		1	49	23.28	0
		1	99	22.77	0
		50	0	22.13	1
		50	25	22.08	1
		50	50	21.94	1
		100	0	22.05	1
	HCH	1	0	22.7	0
		1	49	22.88	0
		1	99	22.36	0
		50	0	21.93	1
		50	25	21.83	1
		50	50	21.84	1
		100	0	21.83	1
16QAM	LCH	1	0	22.24	1
		1	49	22.54	1
		1	99	22.01	1
		50	0	21.04	2
		50	25	21.11	2
		50	50	21.05	2
		100	0	21.04	2
	MCH	1	0	22.18	1
		1	49	22.45	1
		1	99	22.01	1
		50	0	21.03	2
		50	25	21.03	2

		50	50	20.93	2
		100	0	20.94	2
	HCH	1	0	21.86	1
		1	49	22.1	1
		1	99	21.47	1
		50	0	20.88	2
		50	25	20.77	2
		50	50	20.8	2
		100	0	20.81	2

FDD-LTE Band 5:

Channel Bandwidth: 1.4 MHz					
Modulation	Channel	RB Configuration		Average Power [dBm]	MPR (dB)
		Size	Offset		
QPSK	LCH	1	0	23.18	0
		1	3	23.16	0
		1	5	23.09	0
		3	0	22.07	0
		3	2	22.09	0
		3	3	22.05	0
		6	0	22.16	1
	MCH	1	0	22.48	0
		1	3	22.57	0
		1	5	22.44	0
		3	0	22.24	0
		3	2	22.29	0
		3	3	22.29	0
		6	0	21.51	1
	HCH	1	0	22.31	0
		1	3	22.48	0
		1	5	22.32	0
		3	0	22.27	0
		3	2	22.11	0
		3	3	22.19	0
		6	0	21.35	1
16QAM	LCH	1	0	22.14	1
		1	3	22.24	1
		1	5	22.13	1
		3	0	22.08	1
		3	2	22.11	1
		3	3	22.04	1
		6	0	20.97	2

	MCH	1	0	21.74	1
		1	3	21.9	1
		1	5	21.71	1
		3	0	21.44	1
		3	2	21.45	1
		3	3	21.44	1
		6	0	20.37	2
	HCH	1	0	21.48	1
		1	3	21.65	1
		1	5	21.53	1
		3	0	21.48	1
		3	2	21.42	1
		3	3	21.42	1
		6	0	21.29	2

Channel Bandwidth: 3 MHz					
Modulation	Channel	RB Configuration		Average Power [dBm]	MPR (dB)
		Size	Offset		
QPSK	LCH	1	0	23.14	0
		1	7	23.31	0
		1	14	23.05	0
		8	0	22.13	1
		8	4	22.16	1
		8	7	22.1	1
		15	0	22.07	1
	MCH	1	0	22.61	0
		1	7	22.78	0
		1	14	22.53	0
		8	0	21.57	1
		8	4	21.58	1
		8	7	21.53	1
		15	0	21.48	1
	HCH	1	0	22.39	0
		1	7	22.6	0
		1	14	22.39	0
		8	0	21.38	1
		8	4	21.45	1
		8	7	21.41	1
		15	0	21.38	1
16QAM	LCH	1	0	22.24	1
		1	7	22.41	1
		1	14	22.21	1
		8	0	21.09	2

		8	4	21.1	2
		8	7	21.01	2
		15	0	20.94	2
	MCH	1	0	21.88	1
		1	7	22.02	1
		1	14	21.8	1
		8	0	20.47	2
		8	4	20.47	2
		8	7	20.43	2
		15	0	20.45	2
	HCH	1	0	21.63	1
		1	7	21.82	1
		1	14	21.63	1
		8	0	20.39	2
		8	4	20.46	2
8		7	20.4	2	
15		0	20.32	2	

Channel Bandwidth: 5 MHz					
Modulation	Channel	RB Configuration		Average Power [dBm]	MPR (dB)
		Size	Offset		
QPSK	LCH	1	0	23.15	0
		1	12	23.31	0
		1	24	22.9	0
		12	0	22.01	1
		12	6	22.05	1
		12	13	21.93	1
		25	0	21.97	1
	MCH	1	0	22.62	0
		1	12	22.86	0
		1	24	22.41	0
		12	0	21.5	1
		12	6	21.56	1
		12	13	21.48	1
		25	0	21.53	1
	HCH	1	0	22.44	0
		1	12	22.7	0
		1	24	22.38	0
		12	0	21.44	1
		12	6	21.42	1
		12	13	21.39	1
		25	0	21.4	1
16QAM	LCH	1	0	22.22	1

		1	12	22.37	1
		1	24	22.08	1
		12	0	21.02	2
		12	6	21.02	2
		12	13	20.94	2
		25	0	20.92	2
	MCH	1	0	21.76	1
		1	12	21.96	1
		1	24	21.59	1
		12	0	20.56	2
		12	6	20.63	2
		12	13	20.56	2
	HCH	25	0	20.47	2
		1	0	21.67	1
		1	12	21.88	1
		1	24	21.57	1
		12	0	20.43	2
		12	6	20.48	2
		12	13	20.38	2
	25	0	20.37	2	

Channel Bandwidth: 10 MHz					
Modulation	Channel	RB Configuration		Average Power [dBm]	MPR (dB)
		Size	Offset		
QPSK	LCH	1	0	23.32	0
		1	24	23.08	0
		1	49	23.09	0
		25	0	22.28	1
		25	12	22.31	1
		25	25	22.26	1
		50	0	22.29	1
	MCH	1	0	22.75	0
		1	24	22.54	0
		1	49	22.34	0
		25	0	21.64	1
		25	12	21.59	1
		25	25	21.54	1
		50	0	21.51	1
	HCH	1	0	22.44	0
		1	24	22.59	0
		1	49	22.37	0
		25	0	21.47	1
		25	12	21.25	1

		25	25	21.33	1
		50	0	21.37	1
16QAM	LCH	1	0	22.25	1
		1	24	22.29	1
		1	49	21.89	1
		25	0	21.05	2
		25	12	20.95	2
		25	25	20.85	2
		50	0	20.89	2
		MCH	1	0	21.88
	1		24	21.93	1
	1		49	21.67	1
	25		0	20.57	2
	25		12	20.54	2
	25		25	20.57	2
	50		0	20.57	2
	HCH	1	0	21.7	1
		1	24	21.77	1
		1	49	21.4	1
		25	0	20.6	2
		25	12	20.34	2
		25	25	20.69	2
		50	0	20.49	2

FDD-LTE Band 7:

Channel Bandwidth: 5 MHz					
Modulation	Channel	RB Configuration		Average Power [dBm]	MPR (dB)
		Size	Offset		
QPSK	LCH	1	0	22.66	0
		1	12	22.45	0
		1	24	22.58	0
		12	0	21.55	1
		12	6	21.59	1
		12	13	21.51	1
		25	0	21.5	1
	MCH	1	0	21.96	0
		1	12	22.37	0
		1	24	22.06	0
		12	0	20.99	1
		12	6	21.06	1
		12	13	21.02	1
		25	0	21.02	1
	HCH	1	0	22.03	0
		1	12	22.24	0
		1	24	22.06	0
		12	0	21.05	1
		12	6	21.06	1
		12	13	21.03	1
		25	0	21.02	1
16QAM	LCH	1	0	21.61	1
		1	12	21.76	1
		1	24	21.47	1
		12	0	20.47	2
		12	6	20.5	2
		12	13	20.42	2
		25	0	20.38	2
	MCH	1	0	21.07	1
		1	12	21.39	1
		1	24	21.06	1
		12	0	20.65	2
		12	6	20.74	2
		12	13	20.65	2
		25	0	20.62	2
HCH	1	0	21.11	1	
	1	12	21.4	1	

		1	24	21.06	1
		12	0	20.36	2
		12	6	20.58	2
		12	13	20.73	2
		25	0	20.68	2

Channel Bandwidth: 10 MHz					
Modulation	Channel	RB Configuration		Average Power [dBm]	MPR (dB)
		Size	Offset		
QPSK	LCH	1	0	22.39	0
		1	24	22.32	0
		1	49	22.31	0
		25	0	21.55	1
		25	12	21.54	1
		25	25	21.41	1
		50	0	21.45	1
	MCH	1	0	22.01	0
		1	24	22.22	0
		1	49	22.14	0
		25	0	21.07	1
		25	12	21.05	1
		25	25	21.06	1
		50	0	20.98	1
	HCH	1	0	22.11	0
		1	24	22.12	0
		1	49	22	0
		25	0	21.15	1
		25	12	21.13	1
		25	25	21.15	1
		50	0	21.16	1
16QAM	LCH	1	0	21.67	1
		1	24	21.61	1
		1	49	21.39	1
		25	0	20.43	2
		25	12	20.37	2
		25	25	20.69	2
		50	0	20.35	2
	MCH	1	0	21.25	1
		1	24	21.33	1
		1	49	21.2	1
		25	0	20.68	2
		25	12	20.71	2
		25	25	20.65	2

	HCH	50	0	20.65	2
		1	0	21.3	1
		1	24	21.32	1
		1	49	21.09	1
		25	0	20.59	2
		25	12	20.96	2
		25	25	20.74	2
		50	0	20.97	2

Channel Bandwidth: 15 MHz					
Modulation	Channel	RB Configuration		Average Power [dBm]	MPR (dB)
		Size	Offset		
QPSK	LCH	1	0	22.39	0
		1	37	22.19	0
		1	74	22.15	0
		37	0	21.56	1
		37	18	21.53	1
		37	38	21.58	1
		75	0	21.56	1
	MCH	1	0	22	0
		1	37	22.35	0
		1	74	22.21	0
		37	0	21.02	1
		37	18	21.21	1
		37	38	21.23	1
		75	0	21.22	1
	HCH	1	0	22.08	0
		1	37	22.07	0
		1	74	22.1	0
		37	0	21.17	1
		37	18	21.18	1
		37	38	21.24	1
		75	0	21.24	1
16QAM	LCH	1	0	21.61	1
		1	37	21.56	1
		1	74	21.26	1
		37	0	20.61	2
		37	18	20.48	2
		37	38	20.35	2
		75	0	20.49	2
	MCH	1	0	21.21	1
		1	37	21.37	1
		1	74	21.1	1

		37	0	20.68	2
		37	18	20.46	2
		37	38	20.36	2
		75	0	20.65	2
	HCH	1	0	21.23	1
		1	37	21.42	1
		1	74	21	1
		37	0	20.65	2
		37	18	20.42	2
		37	38	20.65	2
		75	0	20.69	2

Channel Bandwidth: 20 MHz					
Modulation	Channel	RB Configuration		Average Power [dBm]	MPR (dB)
		Size	Offset		
QPSK	LCH	1	0	22.67	0
		1	49	22.26	0
		1	99	22.03	0
		50	0	21.64	1
		50	25	21.63	1
		50	50	21.62	1
		100	0	21.63	1
	MCH	1	0	21.92	0
		1	49	22.38	0
		1	99	22.03	0
		50	0	20.91	1
		50	25	21.04	1
		50	50	20.95	1
		100	0	20.89	1
	HCH	1	0	21.78	0
		1	49	21.98	0
		1	99	21.94	0
		50	0	21.09	1
		50	25	21.13	1
		50	50	21.15	1
		100	0	21.11	1
16QAM	LCH	1	0	21.47	1
		1	49	21.53	1
		1	99	21.12	1
		50	0	20.4	2
		50	25	20.39	2
		50	50	20.76	2
		100	0	20.69	2

	MCH	1	0	21.17	1
		1	49	21.39	1
		1	99	21.09	1
		50	0	20.87	2
		50	25	20.85	2
		50	50	20.68	2
		100	0	20.83	2
	HCH	1	0	20.89	1
		1	49	21.33	1
		1	99	20.84	1
		50	0	20.65	2
		50	25	20.72	2
		50	50	20.69	2
		100	0	20.56	2

FDD-LTE Band 12:

Channel Bandwidth: 1.4 MHz					
Modulation	Channel	RB Configuration		Average Power [dBm]	MPR (dB)
		Size	Offset		
QPSK	LCH	1	0	22.85	0
		1	3	22.99	0
		1	5	22.82	0
		3	0	21.9	0
		3	2	21.97	0
		3	3	21.93	0
		6	0	20.96	1
	MCH	1	0	22.48	0
		1	3	22.59	0
		1	5	22.41	0
		3	0	21.59	0
		3	2	21.6	0
		3	3	21.57	0
		6	0	20.62	1
	HCH	1	0	22.06	0
		1	3	22.18	0
		1	5	22.06	0
		3	0	22.17	0
		3	2	22.17	0
		3	3	22.11	0
		6	0	21.23	1
16QAM	LCH	1	0	22.19	1
		1	3	22.35	1
		1	5	22.14	1
		3	0	22.15	1
		3	2	22.14	1
		3	3	22.14	1
		6	0	20.91	2
	MCH	1	0	21.87	1
		1	3	21.95	1
		1	5	21.81	1
		3	0	21.61	1
		3	2	21.65	1
		3	3	21.6	1
		6	0	20.51	2
HCH	1	0	21.33	1	
	1	3	21.41	1	

		1	5	21.2	1
		3	0	21.3	1
		3	2	21.27	1
		3	3	21.22	1
		6	0	20.58	2

Channel Bandwidth: 3 MHz					
Modulation	Channel	RB Configuration		Average Power [dBm]	MPR (dB)
		Size	Offset		
QPSK	LCH	1	0	22.79	0
		1	7	23.05	0
		1	14	22.71	0
		8	0	21.98	1
		8	4	21.96	1
		8	7	21.92	1
		15	0	21.94	1
	MCH	1	0	22.53	0
		1	7	22.61	0
		1	14	22.39	0
		8	0	21.63	1
		8	4	21.69	1
		8	7	21.62	1
		15	0	21.55	1
	HCH	1	0	22.27	0
		1	7	22.34	0
		1	14	22.05	0
		8	0	21.26	1
		8	4	21.26	1
		8	7	21.24	1
		15	0	21.18	1
16QAM	LCH	1	0	22.13	1
		1	7	22.44	1
		1	14	22.14	1
		8	0	21	2
		8	4	21.07	2
		8	7	20.98	2
		15	0	20.93	2
	MCH	1	0	21.92	1
		1	7	22.04	1
		1	14	21.82	1
		8	0	20.59	2
		8	4	20.57	2
		8	7	20.52	2

	HCH	15	0	20.55	2
		1	0	21.61	1
		1	7	21.63	1
		1	14	21.2	1
		8	0	20.65	2
		8	4	20.75	2
		8	7	20.63	2
		15	0	20.47	2

Channel Bandwidth: 5 MHz					
Modulation	Channel	RB Configuration		Average Power [dBm]	MPR (dB)
		Size	Offset		
QPSK	LCH	1	0	22.76	0
		1	12	23.15	0
		1	24	22.55	0
		12	0	21.96	1
		12	6	21.92	1
		12	13	21.82	1
		25	0	21.95	1
	MCH	1	0	22.48	0
		1	12	22.79	0
		1	24	22.31	0
		12	0	21.46	1
		12	6	21.61	1
		12	13	21.42	1
		25	0	21.48	1
	HCH	1	0	22.25	0
		1	12	22.39	0
		1	24	22.72	0
		12	0	21.41	1
		12	6	21.35	1
		12	13	21.25	1
		25	0	21.4	1
16QAM	LCH	1	0	22.12	1
		1	12	22.05	1
		1	24	21.93	1
		12	0	21.05	2
		12	6	21.01	2
		12	13	20.91	2
		25	0	20.96	2
	MCH	1	0	21.76	1
		1	12	22	1
		1	24	21.58	1

		12	0	20.66	2
		12	6	20.74	2
		12	13	20.58	2
		25	0	20.51	2
	HCH	1	0	21.51	1
		1	12	21.79	1
		1	24	21.18	1
		12	0	20.47	2
		12	6	20.38	2
		12	13	20.63	2
		25	0	20.42	2

Channel Bandwidth: 10 MHz					
Modulation	Channel	RB Configuration		Average Power [dBm]	MPR (dB)
		Size	Offset		
QPSK	LCH	1	0	22.71	0
		1	24	23.16	0
		1	49	22.36	0
		25	0	22.14	1
		25	12	22.18	1
		25	25	22.15	1
		50	0	22.19	1
	MCH	1	0	22.59	0
		1	24	22.56	0
		1	49	22.24	0
		25	0	21.47	1
		25	12	21.55	1
		25	25	21.27	1
		50	0	21.37	1
	HCH	1	0	22.48	0
		1	24	22.43	0
		1	49	22.05	0
		25	0	21.67	1
		25	12	21.5	1
		25	25	21.29	1
		50	0	21.53	1
16QAM	LCH	1	0	22.14	1
		1	24	22.07	1
		1	49	21.65	1
		25	0	20.96	2
		25	12	20.76	2
		25	25	20.82	2
		50	0	20.89	2

	MCH	1	0	22.11	1
		1	24	21.99	1
		1	49	21.76	1
		25	0	20.47	2
		25	12	20.57	2
		25	25	20.33	2
		50	0	20.39	2
	HCH	1	0	21.16	1
		1	24	21.79	1
		1	49	21.25	1
		25	0	20.6	2
		25	12	20.48	2
		25	25	20.32	2
		50	0	20.51	2

FDD-LTE Band 13:

Channel Bandwidth: 5 MHz					
Modulation	Channel	RB Configuration		Average Power [dBm]	MPR (dB)
		Size	Offset		
QPSK	LCH	1	0	22.70	0
		1	12	23.21	0
		1	24	22.89	0
		12	0	21.74	1
		12	6	21.89	1
		12	13	21.77	1
		25	0	21.80	1
	MCH	1	0	22.86	0
		1	12	23.23	0
		1	24	23.02	0
		12	0	21.96	1
		12	6	21.96	1
		12	13	21.93	1
		25	0	21.98	1
	HCH	1	0	22.89	0
		1	12	23.17	0
		1	24	23.09	0
		12	0	21.91	1
		12	6	22.00	1
		12	13	22.08	1
		25	0	22.05	1
16QAM	LCH	1	0	21.81	1
		1	12	22.16	1

		1	24	22.07	1
		12	0	21.04	2
		12	6	21.07	2
		12	13	21.03	2
		25	0	20.90	2
	MCH	1	0	21.98	1
		1	12	22.37	1
		1	24	22.08	1
		12	0	21.09	2
		12	6	21.07	2
		12	13	20.99	2
		25	0	21.05	2
	HCH	1	0	22.10	1
		1	12	22.44	1
		1	24	22.16	1
		12	0	21.02	2
		12	6	21.15	2
		12	13	21.14	2
		25	0	21.09	2

Channel Bandwidth: 10 MHz					
Modulation	Channel	RB Configuration		Average Power [dBm]	MPR (dB)
		Size	Offset		
QPSK	LCH	/	/	/	/
		/	/	/	/
		/	/	/	/
		/	/	/	/
		/	/	/	/
		/	/	/	/
		/	/	/	/
	MCH	1	0	22.13	0
		1	24	23.24	0
		1	49	23.12	0
		25	0	22.03	1
		25	12	21.91	1
		25	25	22.13	1
		50	0	22.04	1
	HCH	/	/	/	/
		/	/	/	/
		/	/	/	/
		/	/	/	/
		/	/	/	/
		/	/	/	/

		/	/	/	/
16QAM	LCH	/	/	/	/
		/	/	/	/
		/	/	/	/
		/	/	/	/
		/	/	/	/
		/	/	/	/
		/	/	/	/
	MCH	1	0	21.87	1
		1	24	22.27	1
		1	49	22.17	1
		25	0	21.13	2
		25	12	21.07	2
		25	25	21.17	2
		50	0	21.09	2
	HCH	/	/	/	/
		/	/	/	/
		/	/	/	/
		/	/	/	/
		/	/	/	/
		/	/	/	/
		/	/	/	/

FDD-LTE Band 17:

Channel Bandwidth: 5 MHz					
Modulation	Channel	RB Configuration		Average Power [dBm]	MPR (dB)
		Size	Offset		
QPSK	LCH	1	0	22.54	0
		1	12	22.82	0
		1	24	22.35	0
		12	0	21.51	1
		12	6	21.6	1
		12	13	21.56	1
		25	0	21.55	1
	MCH	1	0	22.41	0
		1	12	22.69	0
		1	24	22.19	0
		12	0	21.53	1
		12	6	21.5	1
		12	13	21.21	1
		25	0	21.43	1
	HCH	1	0	22.25	0
		1	12	22.24	0
		1	24	22.61	0
		12	0	21.44	1
		12	6	21.34	1
		12	13	21.2	1
		25	0	21.33	1
16QAM	LCH	1	0	21.86	1
		1	12	21.54	1
		1	24	21.62	1
		12	0	20.58	2
		12	6	20.73	2
		12	13	20.69	2
		25	0	20.55	2
	MCH	1	0	21.67	1
		1	12	21.89	1
		1	24	21.5	1
		12	0	20.5	2
		12	6	20.47	2
		12	13	20.69	2
		25	0	20.44	2
	HCH	1	0	21.58	1
		1	12	21.78	1
		1	24	21.19	1

		12	0	20.5	2
		12	6	20.41	2
		12	13	20.57	2
		25	0	20.35	2

Channel Bandwidth: 10 MHz					
Modulation	Channel	RB Configuration		Average Power [dBm]	MPR (dB)
		Size	Offset		
QPSK	LCH	1	0	22.42	0
		1	24	22.48	0
		1	49	22.07	0
		25	0	21.44	1
		25	12	21.42	1
		25	25	21.11	1
		50	0	21.29	1
	MCH	1	0	22.45	0
		1	24	22.45	0
		1	49	22.05	0
		25	0	21.49	1
		25	12	21.43	1
		25	25	21.19	1
		50	0	21.32	1
	HCH	1	0	22.44	0
		1	24	22.89	0
		1	49	22.02	0
		25	0	21.62	1
		25	12	21.46	1
		25	25	21.27	1
		50	0	21.45	1
16QAM	LCH	1	0	21.62	1
		1	24	21.72	1
		1	49	21.46	1
		25	0	20.39	2
		25	12	20.44	2
		25	25	20.46	2
		50	0	20.73	2
	MCH	1	0	21.87	1
		1	24	21.93	1
		1	49	21.51	1
		25	0	20.50	2
		25	12	20.45	2
		25	25	20.54	2
		50	0	20.34	2

HCH	1	0	21.72	1
	1	24	21.78	1
	1	49	21.26	1
	25	0	20.60	2
	25	12	20.45	2
	25	25	20.69	2
	50	0	20.48	2

Remark:

- Per KDB941225 D05 v02r05, Start with the largest channel bandwidth then measure SAR for QPSK with 1 RB allocation, using the RB offset and required test channel combination with the highest maximum output power among RB offsets at the upper edge, middle, and lower edge of each required test channel. When the reported SAR is ≤ 0.8 W/kg, testing of the remaining RB offset configurations and required test channels is not required for 1 RB allocation; otherwise, SAR is required for the remaining required test channels and only for the RB offset configuration with the highest output power for that channel. 6 When the reported SAR of a required test channel is > 1.45 W/kg, SAR is required for all three RB offset configurations for that required test channel.
- Per KDB941225 D05 v02r05, The procedures required for 1 RB allocation in 5.2.1 are applied to measure the SAR for QPSK with 50% RB allocation.
- Per KDB941225 D05 v02r05, For QPSK with 100% RB allocation, SAR is not required when the highest maximum output power for 100 % RB allocation is less than the highest maximum output power in 50% and 1 RB allocations, and the highest reported SAR for 1 RB and 50% RB allocation in 5.2.1 and 5.2.2 are ≤ 0.8 W/kg. Otherwise, SAR is measured for the highest output power channel; and if the reported SAR is > 1.45 W/kg, the remaining required test channels must also be tested.
- Per KDB941225 D05 v02r05, For each modulation besides QPSK; e.g., 16-QAM, 64-QAM, apply the QPSK procedures in 5.2.1, 5.2.2, and 5.2.3 to determine the QAM configurations that may need SAR measurement. For each configuration identified as required for testing, SAR is required only when the highest maximum output power for the configuration in the higher order modulation is $> \frac{1}{2}$ dB higher than the same configuration in QPSK or when the reported SAR for the QPSK configuration is > 1.45 W/kg

WLAN - Maximum Average Power					
Test Mode	Data Rate	Channel	Frequency (MHz)	Average Power (dBm)	Tune-up power (dBm)
802.11b	1Mbps	CH 01	2412	14.85	15.5
		CH 06	2437	15.31	15.5
		CH 11	2462	14.85	15.5
802.11g	6Mbps	CH 01	2412	13.72	14.0
		CH 06	2437	13.96	14.0
		CH 11	2462	13.69	14.0
802.11n (20MHz)	MCS0	CH 01	2412	14.02	14.5
		CH 06	2437	13.9	14.5
		CH 11	2462	13.96	14.5
802.11n (40MHz)	MCS0	CH 03	2422	13.56	14.0
		CH 06	2437	12.92	14.0
		CH 09	2452	12.9	14.0

Remark:

1. Per KDB 248227 D01 v02r02, For 802.11b DSSS SAR measurements, DSSS SAR procedure applies to fixed exposure test position and initial test position procedure applies to multiple exposure test positions.
2. Per KDB 248227 D01 v02r02, For 802.11b DSSS SAR measurements, when the reported SAR of the highest measured maximum output power channel (see 3.1) for the exposure configuration is ≤ 0.8 W/kg, no further SAR testing is required for 802.11b DSSS in that exposure configuration. When the reported SAR is > 0.8 W/kg, SAR is required for that exposure configuration using the next highest measured output power channel. When any reported SAR is > 1.2 W/kg, SAR is required for the third channel; i.e., all channels require testing.
3. For OFDM modes (802.11g/n), SAR is not required when the highest reported SAR for DSSS is adjusted by the ratio of OFDM to DSSS specified maximum output power and it is ≤ 1.2 W/kg.

Bluetooth - Maximum Average Power			
Test Mode	Data Rate	Average Power(dBm)	Tune-up power (dBm)
GFSK	1Mbps	5.548	6.0
Pi/4 QDPSK	2Mbps	4.938	6.0
8DPSK	3Mbps	5.036	6.0

Bluetooth - Maximum Average Power					
Test Mode	Data Rate	Channel	Frequency (MHz)	Average Power (dBm)	Tune-up power (dBm)
BLE	1Mbps	CH 00	2402	5.028	6.0
		CH 19	2440	5.711	6.0
		CH 39	2480	5.394	6.0

Remark:

Bluetooth maximum output power is 5.711dBm, and Maximum Tune-Up output power is 6.0dBm. Per KDB 447498 D01 V06, the 1-g and 10-g SAR test exclusion thresholds for 100 MHz to 6 GHz at test separation distances ≤ 50 mm are determined by:

$[(\text{max. power of channel, including tune-up tolerance, } 4.87\text{mW}) / (\text{min. test separation distance, mm})] \cdot [\sqrt{f(\text{GHz})}] \leq 3.0$ for 1-g SAR and ≤ 7.5 for 10-g extremity SAR,16 where

- f(GHz) is the RF channel transmit frequency in GHz
- Power and distance are rounded to the nearest mW and mm before calculation¹⁷
- The result is rounded to one decimal place for comparison

Bluetooth:

Tune-Up Power (dBm)	Max. Power (mW)	Distance (mm)	Frequency (GHz)	Result	Limit
6	3.98	5	2.440	1.24	3

The exclusion thresholds is $1.24 < 3$, therefore, the RF exposure evaluation is not required.

9.2 Test Results for Standalone SAR Test

Front-of-face SAR

GSM850 – Head SAR Test (Gap: 25mm)									
Plot No.	Mode	Test Position Body	Frequency		Output Power (dBm)	Rated Limit (dBm)	Scaling Factor	SAR1g (W/kg)	Scaled SAR1g (W/kg)
			CH.	MHz					
1.	GSM	Front side	251	848.8	32.02	32.5	1.117	0.304	0.340

GSM1900 – Head SAR Test (Gap: 25mm)									
Plot No.	Mode	Test Position Body	Frequency		Output Power (dBm)	Rated Limit (dBm)	Scaling Factor	SAR1g (W/kg)	Scaled SAR1g (W/kg)
			CH.	MHz					
2.	GSM	Front side	512	1850.2	29.06	29.5	1.107	0.021	0.023

GSM850 –Head SAR Test (Gap: 25mm)									
Plot No.	Mode	Test Position Body	Frequency		Output Power (dBm)	Rated Limit (dBm)	Scaling Factor	SAR1g (W/kg)	Scaled SAR1g (W/kg)
			CH.	MHz					
3.	GPRS_4TX	Front side	251	848.8	28.17	28.5	1.079	0.304	0.328

GSM1900 –Head SAR Test (Gap: 25mm)									
Plot No.	Mode	Test Position Body	Frequency		Output Power (dBm)	Rated Limit (dBm)	Scaling Factor	SAR1g (W/kg)	Scaled SAR1g (W/kg)
			CH.	MHz					
4.	GPRS_4TX	Front side	810	1909.8	25.66	26.0	1.081	0.032	0.035

WCDMA Band 2 –Head SAR Test (Gap: 25mm)									
Plot No.	Mode	Test Position Body	Frequency		Output Power (dBm)	Rated Limit (dBm)	Scaling Factor	SAR1g (W/kg)	Scaled SAR1g (W/kg)
			CH.	MHz					
5.	RMC 12.2k	Front side	9262	1852.4	22.84	23.0	1.038	0.06	0.062

WCDMA Band 5 –Head SAR Test (Gap: 25mm)									
Plot No.	Mode	Test Position Body	Frequency		Output Power (dBm)	Rated Limit (dBm)	Scaling Factor	SAR1g (W/kg)	Scaled SAR1g (W/kg)
			CH.	MHz					
6.	RMC 12.2k	Front Side	4132	826.4	22.88	23.0	1.028	0.202	0.208

LTE Band 2–Head SAR Test (Gap: 25mm)								
Plot No.	Mode	Test Position	Frequency	Output Power	Rated Limit	Scaling Factor	SAR1g (W/kg)	Scaled SAR1g (W/kg)
	Modulation, Bandwidth, RB	Body	MHz	(dBm)	(dBm)			
7.	QPSK 20MHz 1RB	Front Side	1860.0	23.76	24.0	1.057	0.084	0.089
8.	QPSK 20MHz 50%RB	Front Side	1860.0	22.78	23.0	1.052	0.041	0.043

LTE Band 4–Head SAR Test (Gap: 25mm)								
Plot No.	Mode	Test Position	Frequency	Output Power	Rated Limit	Scaling Factor	SAR1g (W/kg)	Scaled SAR1g (W/kg)
	Modulation, Bandwidth, RB	Body	MHz	(dBm)	(dBm)			
9.	QPSK 20MHz 1RB	Front Side	1720.0	23.59	24.0	1.099	0.186	0.204
10.	QPSK 20MHz 50%RB	Front Side	1720.0	22.66	23.0	1.081	0.091	0.098

LTE Band 5–Head SAR Test (Gap: 25mm)								
Plot No.	Mode	Test Position	Frequency	Output Power	Rated Limit	Scaling Factor	SAR1g (W/kg)	Scaled SAR1g (W/kg)
	Modulation, Bandwidth, RB	Body	MHz	(dBm)	(dBm)			
11.	QPSK 10MHz 1RB	Front Side	829.0	23.32	23.5	1.042	0.242	0.252
12.	QPSK 10MHz 50%RB	Front Side	829.0	22.31	22.5	1.045	0.11	0.115

LTE Band 7–Head SAR Test (Gap: 25mm)								
Plot No.	Mode	Test Position	Frequency	Output Power	Rated Limit	Scaling Factor	SAR1g (W/kg)	Scaled SAR1g (W/kg)
	Modulation, Bandwidth, RB	Body	MHz	(dBm)	(dBm)			
13.	QPSK 20MHz 1RB	Front Side	2510.0	22.67	23.0	1.079	0.087	0.094
14.	QPSK 20MHz 50%RB	Front Side	2510.0	21.64	22.0	1.086	0.042	0.046

LTE Band 12–Head SAR Test (Gap: 25mm)								
Plot No.	Mode	Test Position	Frequency	Output Power	Rated Limit	Scaling Factor	SAR1g (W/kg)	Scaled SAR1g (W/kg)
	Modulation, Bandwidth, RB	Body	MHz	(dBm)	(dBm)			
15.	QPSK 10MHz 1RB	Front Side	704.0	23.16	23.5	1.081	0.178	0.192
16.	QPSK 10MHz 50%RB	Front Side	704.0	22.18	22.5	1.076	0.074	0.080

LTE Band 13–Head SAR Test (Gap: 25mm)								
Plot No.	Mode	Test Position Body	Frequency	Output Power (dBm)	Rated Limit (dBm)	Scaling Factor	SAR1g (W/kg)	Scaled SAR1g (W/kg)
	Modulation, Bandwidth, RB		MHz					
17.	QPSK 10MHz 1RB	Front Side	782.0	23.24	23.5	1.062	0.239	0.254
18.	QPSK 10MHz 50%RB	Front Side	782.0	22.13	22.5	1.089	0.121	0.132

LTE Band 17–Head SAR Test (Gap: 25mm)								
Plot No.	Mode	Test Position Body	Frequency	Output Power (dBm)	Rated Limit (dBm)	Scaling Factor	SAR1g (W/kg)	Scaled SAR1g (W/kg)
	Modulation, Bandwidth, RB		MHz					
19.	QPSK 10MHz 1RB	Front Side	711.0	22.89	23.0	1.026	0.185	0.190
20.	QPSK 10MHz 50%RB	Front Side	711.0	21.62	22.0	1.091	0.093	0.102

WLAN 2.4GHz –Head SAR Test (Gap: 25mm)									
Plot No.	Mode	Test Position Body	Frequency		Output Power (dBm)	Rated Limit (dBm)	Scaling Factor	SAR1g (W/kg)	Scaled SAR1g (W/kg)
			CH.	MHz					
21.	802.11b	Front Side	06	2437	15.31	15.5	1.045	0.044	0.046

Remark: Per KDB 447498 D01 v06, if the highest output channel SAR for each exposure position ≤ 0.8 W/kg other channels SAR tests are not necessary.

Body SAR

GSM850 – Body SAR Test (Gap: 0mm)									
Plot No.	Mode	Test Position Body	Frequency		Output Power (dBm)	Rated Limit (dBm)	Scaling Factor	SAR1g (W/kg)	Scaled SAR1g (W/kg)
			CH.	MHz					
22.	GPRS_4TX	Back Side	251	848.8	28.17	28.5	1.079	0.882	0.952
23.	GPRS_4TX	Back Side	128	824.2	27.99	28.5	1.125	0.646	0.726
24.	GPRS_4TX	Back Side	190	836.6	28.12	28.5	1.091	0.719	0.785

GSM1900 – Body SAR Test (Gap: 0mm)									
Plot No.	Mode	Test Position Body	Frequency		Output Power (dBm)	Rated Limit (dBm)	Scaling Factor	SAR1g (W/kg)	Scaled SAR1g (W/kg)
			CH.	MHz					
25.	GPRS_4TX	Back Side	810	1909.8	25.66	26.0	1.081	0.076	0.082

WCDMA Band 2 – Body SAR Test (Gap: 0mm)									
Plot No.	Mode	Test Position Body	Frequency		Output Power (dBm)	Rated Limit (dBm)	Scaling Factor	SAR1g (W/kg)	Scaled SAR1g (W/kg)
			CH.	MHz					
26.	RMC 12.2k	Back Side	9262	1852.4	22.84	23.0	1.038	0.118	0.122

WCDMA Band 5 – Body SAR Test (Gap: 0mm)									
Plot No.	Mode	Test Position Body	Frequency		Output Power (dBm)	Rated Limit (dBm)	Scaling Factor	SAR1g (W/kg)	Scaled SAR1g (W/kg)
			CH.	MHz					
27.	RMC 12.2k	Back Side	4132	826.4	22.88	23.0	1.028	0.445	0.457

LTE Band 2–Body SAR Test (Gap: 0mm)									
Plot No.	Mode	Test Position Body	Frequency	Output Power (dBm)	Rated Limit (dBm)	Scaling Factor	SAR1g (W/kg)	Scaled SAR1g (W/kg)	
	Modulation, Bandwidth, RB		MHz						
28.	QPSK 20MHz 1RB	Back Side	1860.0	23.76	24.0	1.057	0.151	0.160	
29.	QPSK 20MHz 50%RB	Back Side	1860.0	22.78	23.0	1.052	0.072	0.076	

LTE Band 4–Body SAR Test (Gap: 0mm)								
Plot No.	Mode	Test Position Body	Freque ncy	Output Power (dBm)	Rated Limit (dBm)	Scaling Factor	SAR1g (W/kg)	Scaled SAR1g (W/kg)
	Modulation, Bandwidth, RB		MHz					
30.	QPSK 20MHz 1RB	Back Side	1720.0	23.59	24.0	1.099	0.406	0.446
31.	QPSK 20MHz 50%RB	Back Side	1720.0	22.66	23.0	1.081	0.243	0.263

LTE Band 5–Body SAR Test (Gap: 0mm)								
Plot No.	Mode	Test Position Body	Freque ncy	Output Power (dBm)	Rated Limit (dBm)	Scaling Factor	SAR1g (W/kg)	Scaled SAR1g (W/kg)
	Modulation, Bandwidth, RB		MHz					
32.	QPSK 10MHz 1RB	Back Side	829.0	23.32	23.5	1.042	0.509	0.531
33.	QPSK 10MHz 50%RB	Back Side	829.0	22.31	22.5	1.045	0.287	0.300

LTE Band 7–Body SAR Test (Gap: 0mm)								
Plot No.	Mode	Test Position Body	Freque ncy	Output Power (dBm)	Rated Limit (dBm)	Scaling Factor	SAR1g (W/kg)	Scaled SAR1g (W/kg)
	Modulation, Bandwidth, RB		MHz					
34.	QPSK 20MHz 1RB	Back Side	2510.0	22.67	23.0	1.079	0.161	0.174
35.	QPSK 20MHz 50%RB	Back Side	2510.0	21.64	22.0	1.086	0.085	0.092

LTE Band 12–Body SAR Test (Gap: 0mm)								
Plot No.	Mode	Test Position Body	Freque ncy	Output Power (dBm)	Rated Limit (dBm)	Scaling Factor	SAR1g (W/kg)	Scaled SAR1g (W/kg)
	Modulation, Bandwidth, RB		MHz					
36.	10MHz 1RB	Back Side	704.0	23.16	23.5	1.081	0.432	0.467
37.	10MHz 50%RB	Back Side	704.0	22.18	22.5	1.076	0.212	0.228

LTE Band 13–Body SAR Test (Gap: 0mm)								
Plot No.	Mode	Test Position Body	Freque ncy	Output Power (dBm)	Rated Limit (dBm)	Scaling Factor	SAR1g (W/kg)	Scaled SAR1g (W/kg)
	Modulation, Bandwidth, RB		MHz					
38.	QPSK 10MHz 1RB	Back Side	782.0	23.24	23.5	1.062	0.588	0.624
39.	QPSK 10MHz 50%RB	Back Side	782.0	22.13	22.5	1.089	0.376	0.409

LTE Band 17–Body SAR Test (Gap: 0mm)								
Plot No.	Mode	Test Position Body	Freque ncy	Output Power (dBm)	Rated Limit (dBm)	Scaling Factor	SAR1g (W/kg)	Scaled SAR1g (W/kg)
	Modulation, Bandwidth, RB		MHz					
40.	QPSK 10MHz 1RB	Back Side	711.0	22.89	23.0	1.026	0.546	0.560
41.	QPSK 10MHz 50%RB	Back Side	711.0	21.62	22.0	1.091	0.254	0.277

WLAN 2.4GHz –Body SAR Test									
Plot No.	Mode	Test Position Body	Frequency		Output Power (dBm)	Rated Limit (dBm)	Scaling Factor	SAR1g (W/kg)	Scaled SAR1g (W/kg)
			CH.	MHz					
42.	802.11b	Back Side	06	2437	15.31	15.5	1.045	0.139	0.145

Repeated SAR

GSM850 – Body SAR Test (Gap: 0mm)									
Plot No.	Mode	Test Position Body	Frequency		Output Power (dBm)	Rated Limit (dBm)	Scaling Factor	SAR1g (W/kg)	Scaled SAR1g (W/kg)
			CH.	MHz					
43.	GPRS_4TX	Back Side	251	848.8	28.17	28.5	1.079	0.879	0.948

Remark:

- 1) Repeated measurement is not required when the original highest measured SAR is < 0.80 W/kg; steps 2) through 4) do not apply.
- 2) When the original highest measured SAR is ≥ 0.80 W/kg, repeat that measurement once.
- 3) Perform a second repeated measurement only if the ratio of largest to smallest SAR for the original and first repeated measurements is > 1.20 or when the original or repeated measurement is ≥ 1.45 W/kg (~ 10% from the 1-g SAR limit).
- 4) Perform a third repeated measurement only if the original, first or second repeated measurement is ≥ 1.5 W/kg and the ratio of largest to smallest SAR for the original, first and second repeated measurements is > 1.20

9.3 Simultaneous Multi-band Transmission SAR Analysis

List of Mode for Simultaneous Multi-band Transmission

No.	Configurations	Front-of-face SAR	Body SAR
1	GSM(Voice/Data) + WLAN(Data)	Yes	Yes
2	WCDMA (Voice/Data)+ WLAN(Data)	Yes	Yes
3	LTE(Data) + WLAN(Data)	Yes	Yes
4	GSM(Voice/Data) + Bluetooth(Data)	Yes	Yes
5	WCDMA (Voice/Data) + Bluetooth(Data)	Yes	Yes
6	LTE(Data) + Bluetooth(Data)	Yes	Yes

Remark:

1. GSM and WCDMA share the same antenna, and cannot transmit simultaneously.
2. WLAN and Bluetooth share the same antenna, and cannot transmit simultaneously.
3. According to the KDB 447498 D01 v06, when standalone SAR test exclusion applies to an antenna that transmits simultaneously with other antennas, the standalone SAR must be estimated according to following to determine simultaneous transmission SAR test exclusion:

(max. power of channel, including tune-up tolerance, mW)/(min. test separation distance, mm) 2 ·[$\sqrt{f(\text{GHz})}$]/x W/kg for test separation distances ≤ 50 mm;

where x = 7.5 for 1-g SAR, and x = 18.75 for 10-g SAR.

For simultaneous transmission analysis, Bluetooth SAR is estimated per KDB 447498 D01 v06 as below:

Bluetooth:

Tune-Up Power (dBm)	Max. Power (mW)	Distance (mm)	Frequency (GHz)	X	SAR(1g) 5mm	SAR(1g) 25mm
6.0	3.98	5/25	2.440	7.5	0.166	0.033

4. The maximum SAR summation is calculated based on the same configuration and test position.

Front-of-face SAR
WWAN and WLAN

Position	WWAN		WLAN	Summed SAR (W/kg)
	Band	Scaled SAR (W/kg)	Scaled SAR (W/kg)	
Front	GSM850	0.340	0.046	0.386
Front	GSM1900	0.035	0.046	0.081
Front	WCDMA Band 2	0.062	0.046	0.108
Front	WCDMA Band 5	0.208	0.046	0.254
Front	LTE Band 2	0.089	0.046	0.135
Front	LTE Band 4	0.204	0.046	0.25
Front	LTE Band 5	0.252	0.046	0.298
Front	LTE Band 7	0.094	0.046	0.14
Front	LTE Band 12	0.192	0.046	0.238
Front	LTE Band 13	0.254	0.046	0.3
Front	LTE Band 17	0.190	0.046	0.236

WWAN and Bluetooth

Position	WWAN		Bluetooth	Summed SAR (W/kg)
	Band	Scaled SAR (W/kg)	Scaled SAR (W/kg)	
Front	GSM850	0.340	0.033	0.373
Front	GSM1900	0.035	0.033	0.068
Front	WCDMA Band 2	0.062	0.033	0.095
Front	WCDMA Band 5	0.208	0.033	0.241
Front	LTE Band 2	0.089	0.033	0.122
Front	LTE Band 4	0.204	0.033	0.237
Front	LTE Band 5	0.252	0.033	0.285
Front	LTE Band 7	0.094	0.033	0.127
Front	LTE Band 12	0.192	0.033	0.225
Front	LTE Band 13	0.254	0.033	0.287
Front	LTE Band 17	0.190	0.033	0.223

Body SAR
WWAN and WLAN

Position	WWAN		WLAN	Summed SAR (W/kg)
	Band	Scaled SAR (W/kg)	Scaled SAR (W/kg)	
Back	GSM850	0.952	0.145	1.097
Back	GSM1900	0.082	0.145	0.227
Back	WCDMA Band 2	0.122	0.145	0.267
Back	WCDMA Band 5	0.457	0.145	0.602
Back	LTE Band 2	0.160	0.145	0.305
Back	LTE Band 4	0.446	0.145	0.591
Back	LTE Band 5	0.531	0.145	0.676
Back	LTE Band 7	0.174	0.145	0.319
Back	LTE Band 12	0.467	0.145	0.612
Back	LTE Band 13	0.624	0.145	0.769
Back	LTE Band 17	0.560	0.145	0.705

WWAN and Bluetooth

Position	WWAN		Bluetooth	Summed SAR (W/kg)
	Band	Scaled SAR (W/kg)	Scaled SAR (W/kg)	
Back	GSM850	0.952	0.166	1.118
Back	GSM1900	0.082	0.166	0.248
Back	WCDMA Band 2	0.122	0.166	0.288
Back	WCDMA Band 5	0.457	0.166	0.623
Back	LTE Band 2	0.160	0.166	0.326
Back	LTE Band 4	0.446	0.166	0.612
Back	LTE Band 5	0.531	0.166	0.697
Back	LTE Band 7	0.174	0.166	0.34
Back	LTE Band 12	0.467	0.166	0.633
Back	LTE Band 13	0.624	0.166	0.79
Back	LTE Band 17	0.560	0.166	0.726

10. Measurement Uncertainty

10.1 Uncertainty for EUT SAR Test

a	b	c	d	e= f(d,k)	f	g	h= c*f/e	i= c*g/e	k
Uncertainty Component	Sec.	Tol (+- %)	Prob. Dist.	Div.	Ci (1g)	Ci (10g)	1g Ui (+-%)	10g Ui (+-%)	Vi
Measurement System									
Probe calibration	E.2.1	7.0	N	1	1	1	7.00	7.00	∞
Axial Isotropy	E.2.2	2.5	R	$\sqrt{3}$	$(1_{Cp})^{1/2}$	$(1_{Cp})^{1/2}$	1.02	1.02	∞
Hemispherical Isotropy	E.2.2	4.0	R	$\sqrt{3}$	$(Cp)^{1/2}$	$(Cp)^{1/2}$	1.63	1.63	∞
Boundary effect	E.2.3	1.0	R	$\sqrt{3}$	1	1	0.58	0.58	∞
Linearity	E.2.4	5.0	R	$\sqrt{3}$	1	1	2.89	2.89	∞
System detection limits	E.2.5	1.0	R	$\sqrt{3}$	1	1	0.58	0.58	∞
Readout Electronics	E.2.6	0.02	N	1	1	1	0.02	0.02	∞
Reponse Time	E.2.7	3.0	R	$\sqrt{3}$	1	1	1.73	1.73	∞
Integration Time	E.2.8	2.0	R	$\sqrt{3}$	1	1	1.15	1.15	∞
RF ambient Conditions – Noise	E.6.1	3.0	R	$\sqrt{3}$	1	1	1.73	1.73	∞
RF ambient Conditions - Reflections	E.6.1	3.0	R	$\sqrt{3}$	1	1	1.73	1.73	∞
Probe positioner Mechanical Tolerance	E.6.2	2.0	R	$\sqrt{3}$	1	1	1.15	1.15	∞
Probe positioning with respect to Phantom Shell	E.6.3	0.05	R	$\sqrt{3}$	1	1	0.03	0.03	∞
Extrapolation, interpolation and integration Algorithms for Max. SAR Evaluation	E.5	5.0	R	$\sqrt{3}$	1	1	2.89	2.89	∞
Test Sample Related									
Test sample positioning	E.4.2	0.03	N	1	1	1	0.03	0.03	N-1
Device Holder Uncertainty	E.4.1	5.00	N	1	1	1	5.00	5.00	
Output power Variation - SAR drift measurement	E.2.9	12.02	R	$\sqrt{3}$	1	1	6.94	6.94	∞
SAR scaling	E6.5	0.0	R	$\sqrt{3}$	1	1	0.0	0.0	∞
Phantom and Tissue Parameters									
Phantom Uncertainty (Shape and thickness tolerances)	E.3.1	0.05	R	$\sqrt{3}$	1	1	0.03	0.03	∞
Uncertainty in SAR correction for deviations in permittivity and conductivity	E3.2	1.9	R	$\sqrt{3}$	1	0.84	1.10	0.90	∞
Liquid conductivity - deviation	E.3.2	5.00	R	$\sqrt{3}$	0.64	0.43	1.85	1.24	∞

from target value										
Liquid conductivity measurement uncertainty	E.3.3	5.00	N	1	0.64	0.43	3.20	2.15	∞	
Liquid permittivity - deviation from target value	E.3.2	0.37	R	$\sqrt{3}$	0.6	0.49	0.13	0.10	∞	
Liquid permittivity measurement uncertainty	E.3.3	10.00	N	1	0.6	0.49	6.00	4.90	∞	
Combined Standard Uncertainty			RSS				12.98	12.53		
Expanded Uncertainty (95% Confidence interval)			K=2				25.32	24.43		

10.2 Uncertainty for System Performance Check

a	b	c	d	e= f(d,k)	f	g	h= c*f/e	i= c*g/e	k
Uncertainty Component	Sec.	Tol (+- %)	Prob. Dist.	Div.	Ci (1g)	Ci (10g)	1g Ui (+-%)	10g Ui (+-%)	Vi
Measurement System									
Probe calibration	E.2.1	7.0	N	1	1	1	7.00	7.00	∞
Axial Isotropy	E.2.2	2.5	R	$\sqrt{3}$	$(1_{Cp})^{1/2}$	$(1_{Cp})^{1/2}$	1.02	1.02	∞
Hemispherical Isotropy	E.2.2	4.0	R	$\sqrt{3}$	$(Cp)^{1/2}$	$(Cp)^{1/2}$	1.63	1.63	∞
Boundary effect	E.2.3	1.0	R	$\sqrt{3}$	1	1	0.58	0.58	∞
Linearity	E.2.4	5.0	R	$\sqrt{3}$	1	1	2.89	2.89	∞
System detection limits	E.2.5	1.0	R	$\sqrt{3}$	1	1	0.58	0.58	∞
Modulation response	E.2.5	0	R	$\sqrt{3}$	0	0	0.0	0.0	∞
Readout Electronics	E.2.6	0.02	N	1	1	1	0.02	0.02	∞
Reponse Time	E.2.7	3.0	R	$\sqrt{3}$	1	1	1.73	1.73	∞
Integration Time	E.2.8	2.0	R	$\sqrt{3}$	1	1	1.15	1.15	∞
RF ambient Conditions – Noise	E.6.1	3.0	R	$\sqrt{3}$	1	1	1.73	1.73	∞
RF ambient Conditions - Reflections	E.6.1	3.0	R	$\sqrt{3}$	1	1	1.73	1.73	∞
Probe positioner Mechanical Tolerance	E.6.2	2.0	R	$\sqrt{3}$	1	1	1.15	1.15	∞
Probe positioning with respect to Phantom Shell	E.6.3	0.05	R	$\sqrt{3}$	1	1	0.03	0.03	∞
Extrapolation, interpolation and integration Algorithms for Max.	E.5.2	5.0	R	$\sqrt{3}$	1	1	2.89	2.89	∞

SAR Evaluation									
Dipole									
Dipole axis to liquid Distance	8,E.4.2	1.00	N	$\sqrt{3}$	1	1	0.58	0.58	N-1
Input power and SAR drift measurement	8,6.6.2	12.02	R	$\sqrt{3}$	1	1	6.94	6.94	∞
Deviation of experimental dipole from numerical dipole	E.6.4	5.5	R	$\sqrt{3}$	1	1	3.20	3.20	∞
Phantom and Tissue Parameters									
Phantom Uncertainty (Shape and thickness tolerances)	E.3.1	0.05	R	$\sqrt{3}$	1	1	0.03	0.03	∞
Uncertainty in SAR correction for deviations in permittivity and conductivity	E3.2	2.0	R	$\sqrt{3}$	1	0.84	1.10	1.10	∞
Liquid conductivity - deviation from target value	E.3.2	5.00	R	$\sqrt{3}$	0.64	0.43	1.85	1.24	
Liquid conductivity - measurement uncertainty	E.3.3	5.00	N	1	0.64	0.43	3.20	2.15	
Liquid permittivity - deviation from target value	E.3.2	0.37	R	$\sqrt{3}$	0.6	0.49	0.13	0.10	
Liquid permittivity - measurement uncertainty	E.3.3	10.00	N	1	0.6	0.49	6.00	4.90	M
Combined Standard Uncertainty			RSS				12.00	11.50	
Expanded Uncertainty (95% Confidence interval)			K=2				23.39	22.43	

Annex A. Plots of System Performance Check

MEASUREMENT 1

For Head Liquid

Type: Validation measurement (Fast, 75.00 %)

Date of measurement: 04/16/2019

Measurement duration: 7 minutes 21 seconds

E-field Probe: SSE5 - SN 09/13 EP168; ConvF: 6.99; Calibrated: 06/01/2018

A. Experimental conditions

Area Scan	dx=8mm dy=8mm
Zoom Scan	dx=8mm dy=8mm dz=5mm
Phantom	Validation plane
Device Position	Dipole
Band	CW750
Signal	Duty Cycle 1:1

B. SAR Measurement Results

Frequency (MHz)	750.000000
Relative Permittivity (real part)	41.320574
Conductivity (S/m)	0.862373
Power Variation (%)	0.038363
Ambient Temperature	21.1
Liquid Temperature	21.3

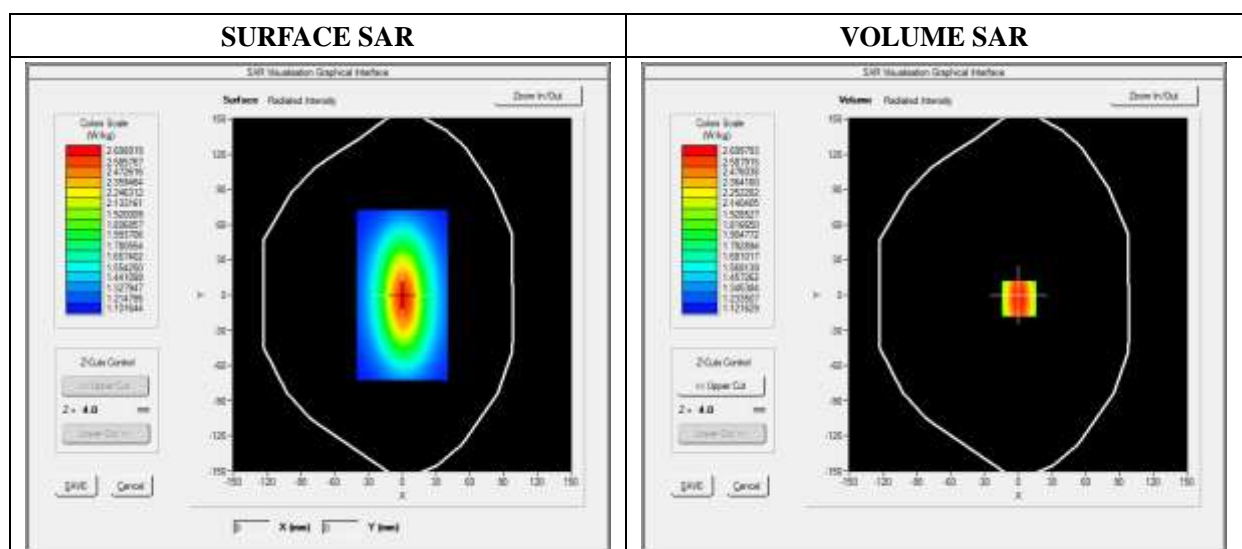

Maximum location: X=0.00, Y=0.00

SAR 10g (W/Kg)	1.042744
SAR 1g (W/Kg)	2.164534

Z Axis Scan

Z (mm)	0.00	4.00	9.00	14.00	19.00	24.00	29.00
SAR (W/Kg)	0.0000	2.3634	1.8023	1.4523	1.2514	1.1005	1.0245

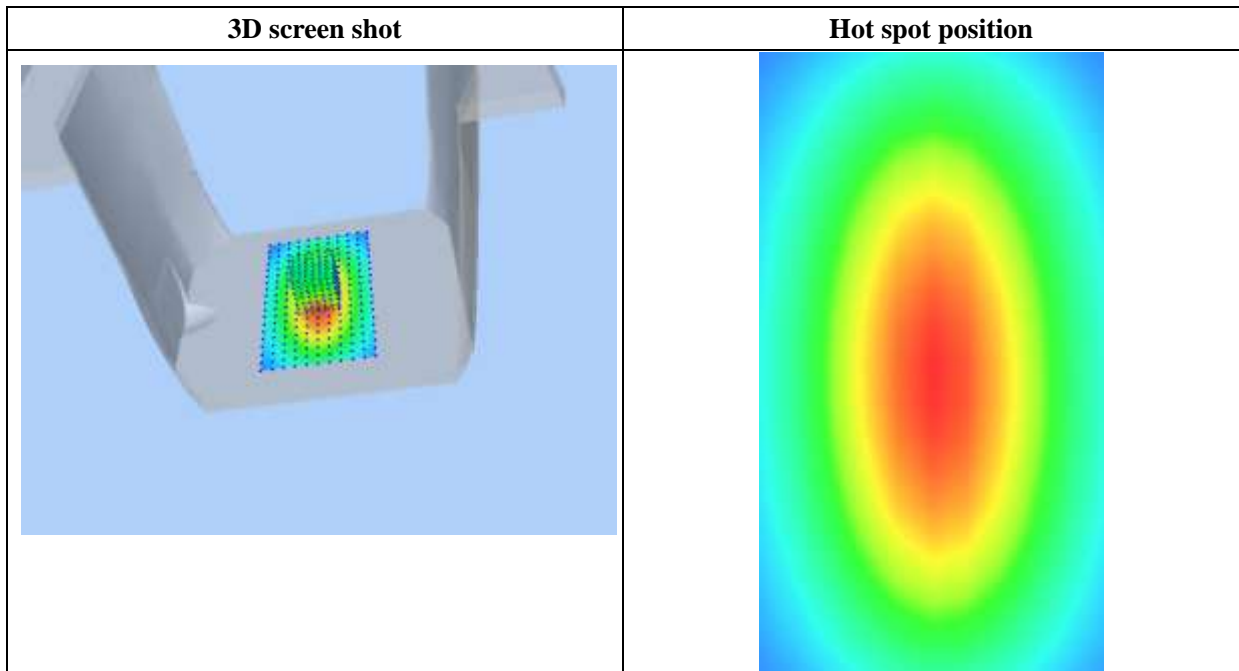
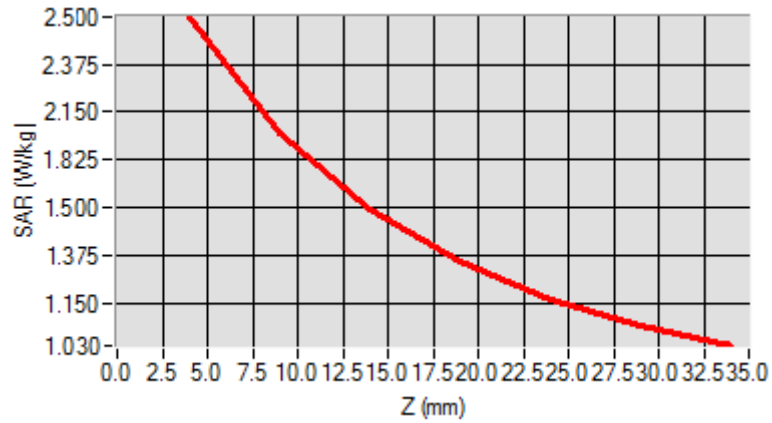

MEASUREMENT 2

For Head Liquid

Type: Validation measurement (Fast, 75.00 %)

Date of measurement: 04/16/2019

Measurement duration: 7 minutes 21 seconds

E-field Probe: SSE5 - SN 09/13 EP168; ConvF: 6.93; Calibrated: 06/01/2018

A. Experimental conditions

Area Scan	dx=8mm dy=8mm
Zoom Scan	dx=8mm dy=8mm dz=5mm
Phantom	Validation plane
Device Position	Dipole
Band	CW835
Signal	Duty Cycle 1:1

B. SAR Measurement Results

Frequency (MHz)	835.000000
Relative Permittivity (real part)	41.110245
Conductivity (S/m)	0.871245
Power Variation (%)	0.038437
Ambient Temperature	21.1
Liquid Temperature	21.3

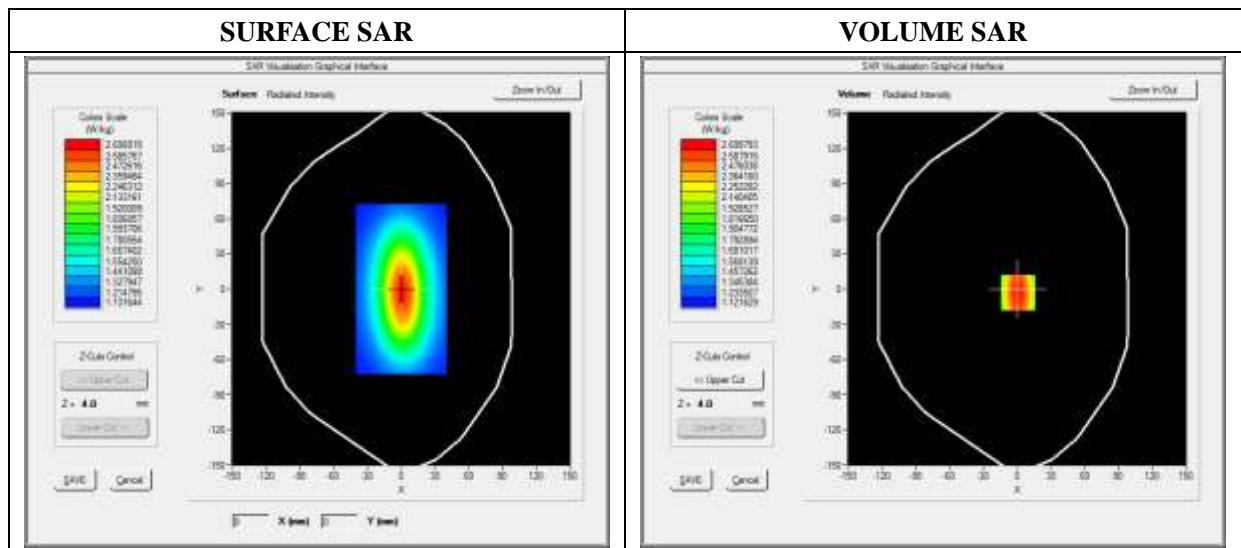

Maximum location: X=0.00, Y=0.00

SAR 10g (W/Kg)	1.129489
SAR 1g (W/Kg)	2.411253

Z Axis Scan

Z (mm)	0.00	4.00	9.00	14.00	19.00	24.00	29.00
SAR (W/Kg)	0.0000	2.4900	1.8942	1.4811	1.3541	1.1123	1.0539

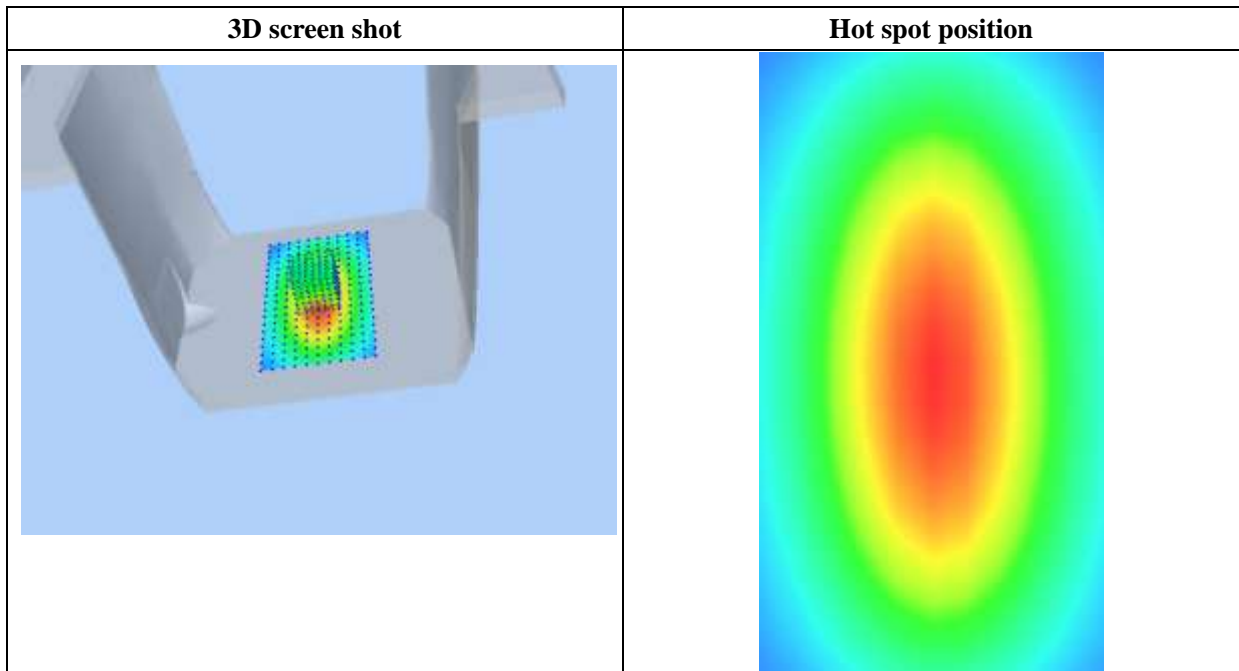
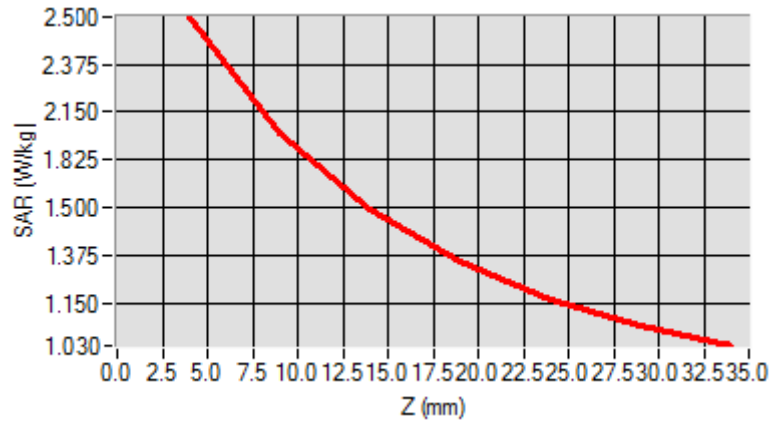

MEASUREMENT 3

For Head Liquid

Type: Validation measurement (Fast, 75.00 %)

Date of measurement: 04/17/2019

Measurement duration: 12 minutes 21 seconds

E-field Probe: SSE5 - SN 09/13 EP168; ConvF: 5.84; Calibrated: 06/01/2018

A. Experimental conditions

Area Scan	dx=8mm dy=8mm
Zoom Scan	dx=8mm dy=8mm dz=5mm
Phantom	Validation plane
Device Position	Dipole
Band	CW1800
Signal	CW (Crest factor: 1.0)

B. SAR Measurement Results

Frequency (MHz)	1800.000000
Relative Permittivity (real part)	39.024890
Conductivity (S/m)	1.371250
Power Variation (%)	1.401232
Ambient Temperature	21.1
Liquid Temperature	21.2

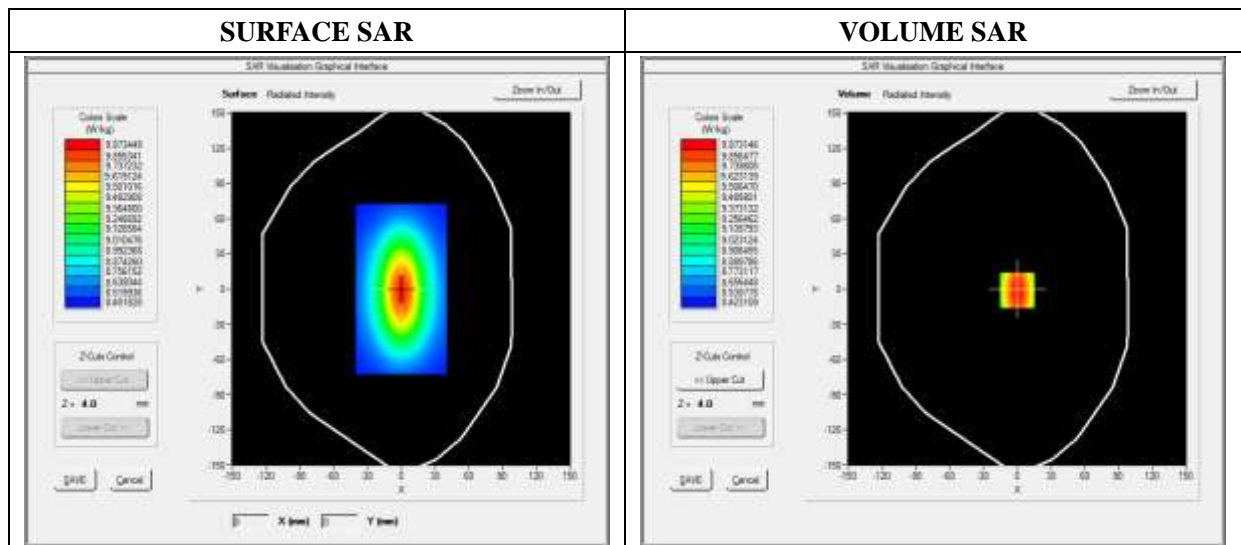

Maximum location: X=0.00, Y=0.00

SAR 10g (W/Kg)	5.171252
SAR 1g (W/Kg)	9.611250

Z Axis Scan

Z (mm)	0.00	4.00	9.00	14.00	19.00	24.00	29.00
SAR (W/Kg)	0.0000	10.3455	7.1125	5.1026	3.425	3.0242	2.1125

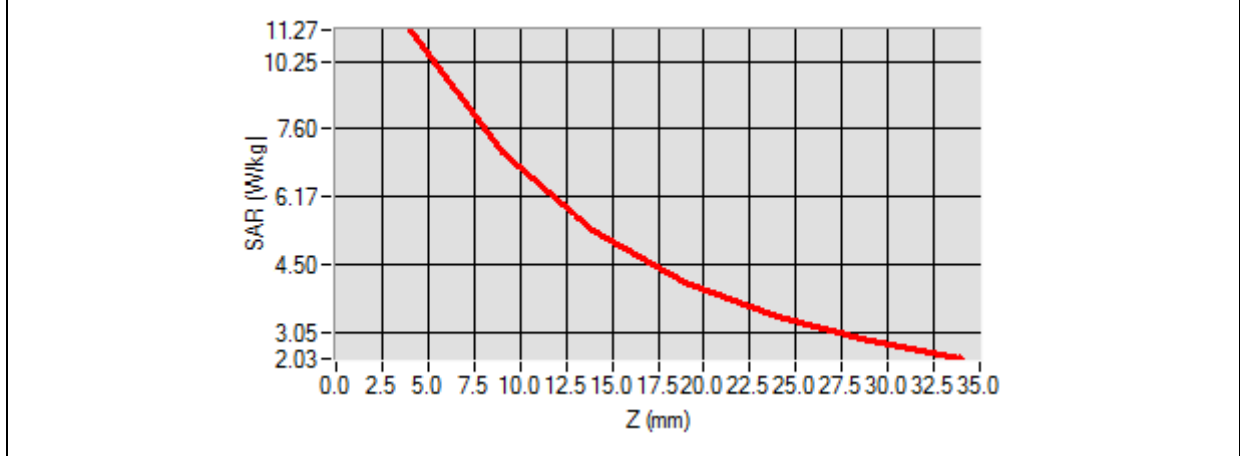

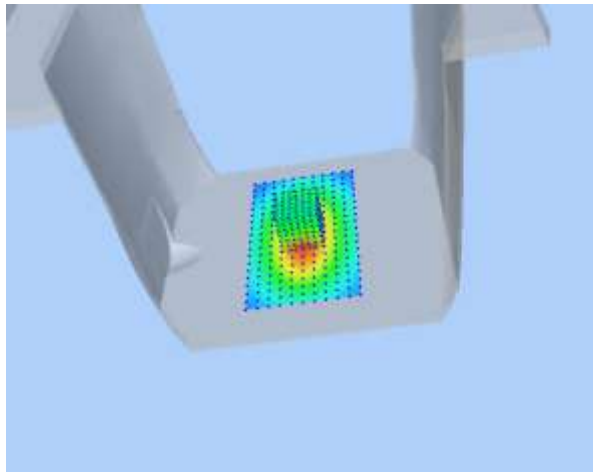
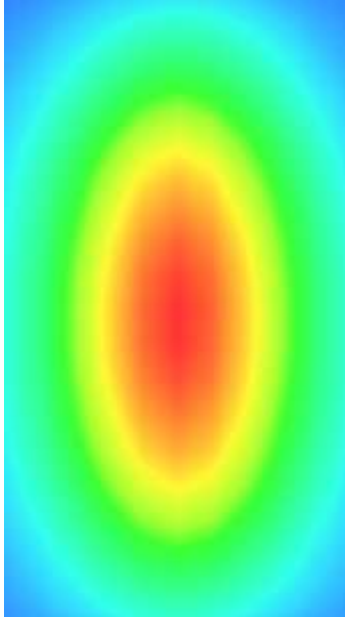
3D screen shot	Hot spot position
	

MEASUREMENT 4

For Head Liquid

Type: Validation measurement (Fast, 75.00 %)

Date of measurement: 04/17/2019

Measurement duration: 12 minutes 21 seconds

E-field Probe: SSE5 - SN 09/13 EP168; ConvF: 6.35; Calibrated: 06/01/2018

A. Experimental conditions

Area Scan	dx=8mm dy=8mm
Zoom Scan	dx=8mm dy=8mm dz=5mm
Phantom	Validation plane
Device Position	Dipole
Band	CW1900
Signal	Duty Cycle 1:1

B. SAR Measurement Results

Frequency (MHz)	1900.000000
Relative Permittivity (real part)	38.560124
Conductivity (S/m)	1.380369
Power Variation (%)	1.022540
Ambient Temperature	21.1
Liquid Temperature	21.3

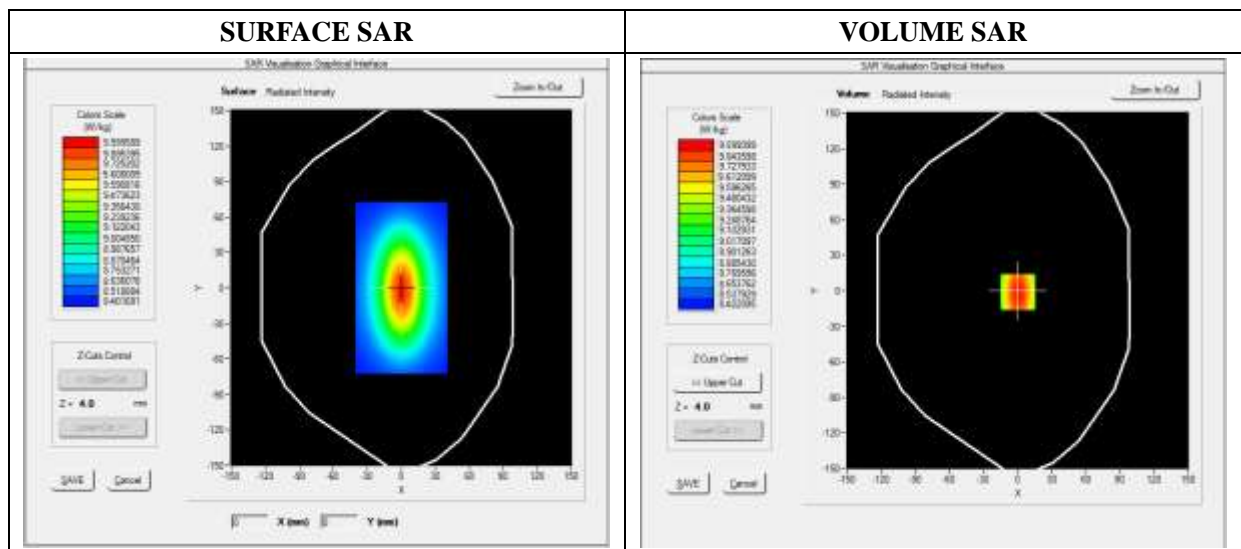

Maximum location: X=0.00, Y=0.00

SAR 10g (W/Kg)	7.174526
SAR 1g (W/Kg)	9.913214

Z Axis Scan

Z (mm)	0.00	4.00	9.00	14.00	19.00	24.00	29.00
SAR (W/Kg)	0.0000	10.2354	6.8400	5.0121	4.1189	3.0522	2.8424

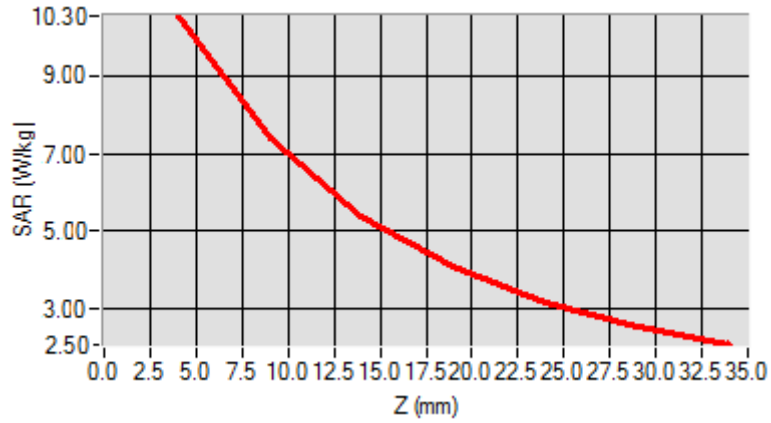

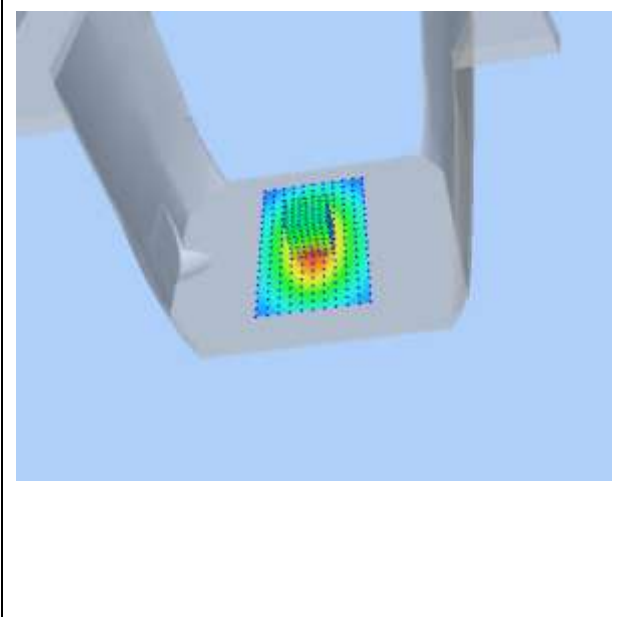
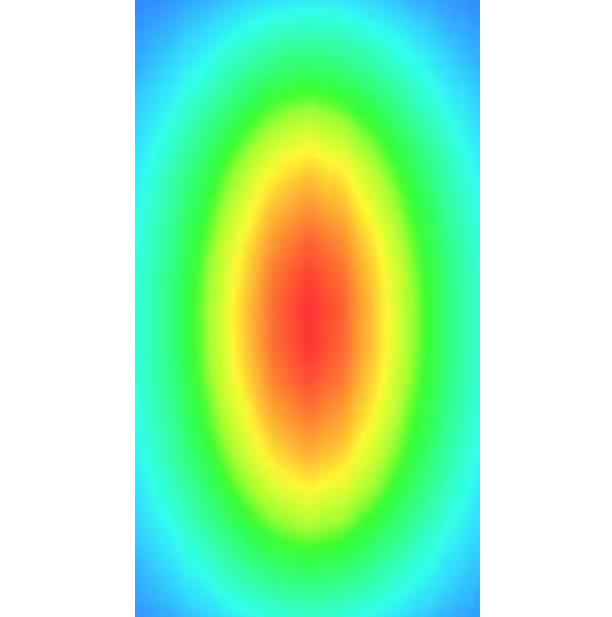
3D screen shot	Hot spot position
	

MEASUREMENT 5

For Head Liquid

Type: Validation measurement (Fast, 75.00 %)

Date of measurement: 04/18/2019

Measurement duration: 12 minutes 21 seconds

E-field Probe: SSE5 - SN 09/13 EP168; ConvF: 5.64; Calibrated: 06/01/2018

A. Experimental conditions

Area Scan	dx=8mm dy=8mm
Zoom Scan	dx=8mm dy=8mm dz=5mm
Phantom	Validation plane
Device Position	Dipole
Band	CW2450
Signal	Duty Cycle 1:1

B. SAR Measurement Results

Frequency (MHz)	2450.000000
Relative Permittivity (real part)	38.153660
Conductivity (S/m)	1.740236
Power Variation (%)	1.141452
Ambient Temperature	21.1
Liquid Temperature	21.2

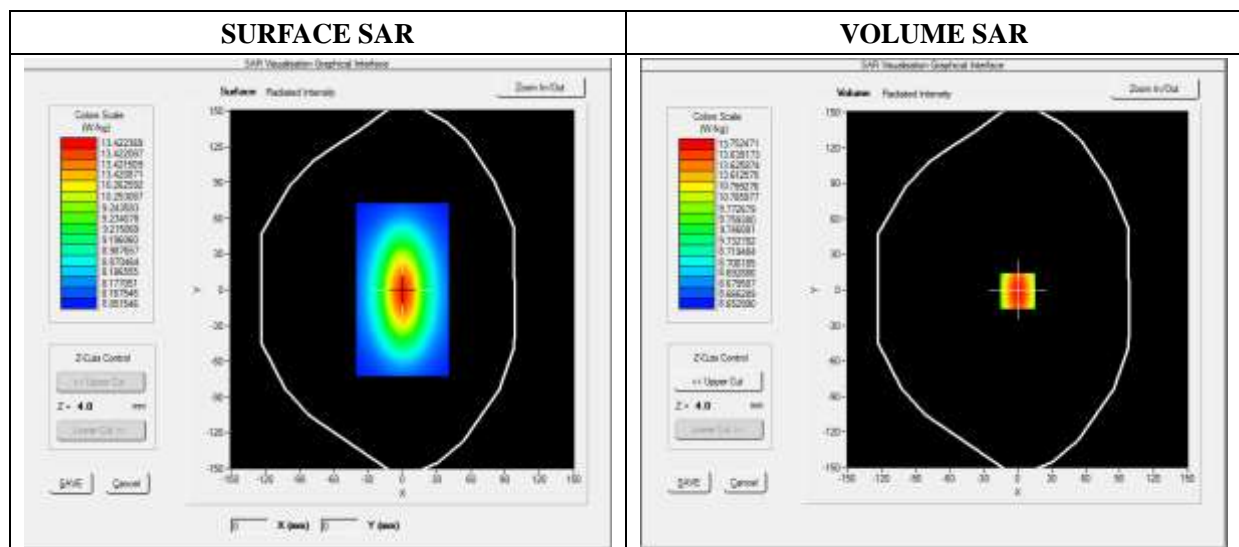

Maximum location: X=0.00, Y=0.00

SAR 10g (W/Kg)	8.020427
SAR 1g (W/Kg)	13.452457

Z Axis Scan

Z (mm)	0.00	4.00	9.00	14.00	19.00	24.00	29.00
SAR (W/Kg)	0.0000	14.1034	12.0012	10.2624	7.4715	5.9022	4.5114

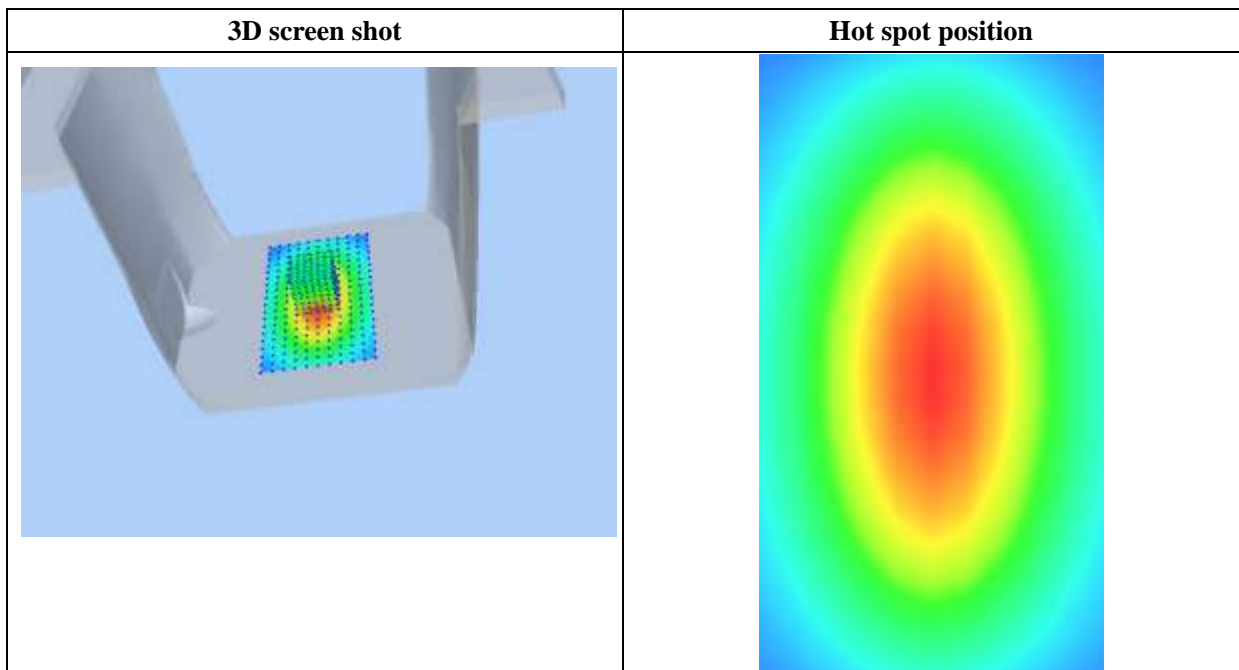
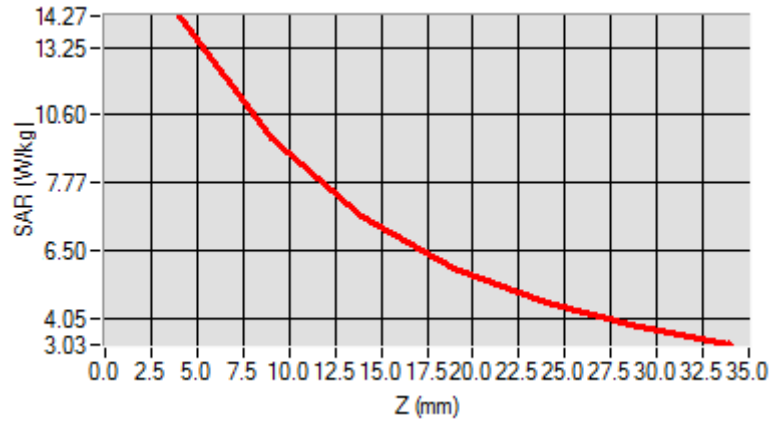

MEASUREMENT 6

For Head Liquid

Type: Validation measurement (Fast, 75.00 %)

Date of measurement: 04/18/2019

Measurement duration: 12 minutes 21 seconds

E-field Probe: SSE5 - SN 09/13 EP168; ConvF: 5.37; Calibrated: 06/01/2018

A. Experimental conditions

Area Scan	dx=8mm dy=8mm
Zoom Scan	dx=8mm dy=8mm dz=5mm
Phantom	Validation plane
Device Position	Dipole
Band	CW2600
Signal	Duty Cycle 1:1

B. SAR Measurement Results

Frequency (MHz)	2600.000000
Relative Permittivity (real part)	38.631092
Conductivity (S/m)	1.930182
Power Variation (%)	1.028221
Ambient Temperature	21.1
Liquid Temperature	21.2

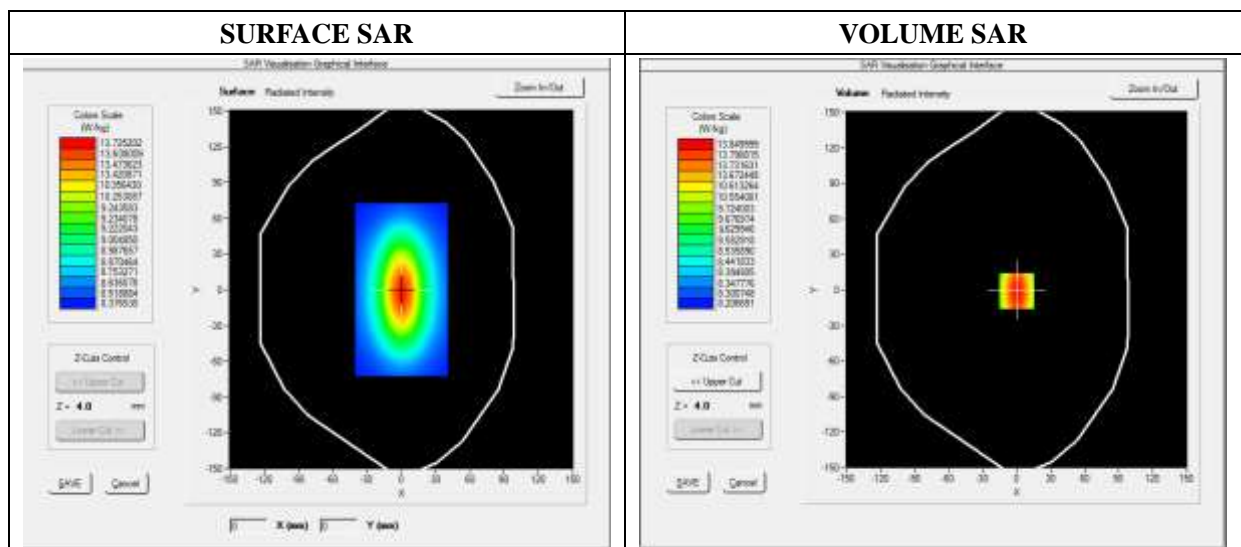

Maximum location: X=0.00, Y=0.00

SAR 10g (W/Kg)	8.270822
SAR 1g (W/Kg)	13.670282

Z Axis Scan

Z (mm)	0.00	4.00	9.00	14.00	19.00	24.00	29.00
SAR (W/Kg)	0.0000	14.0426	12.1354	10.2965	7.4854	5.9354	4.5186

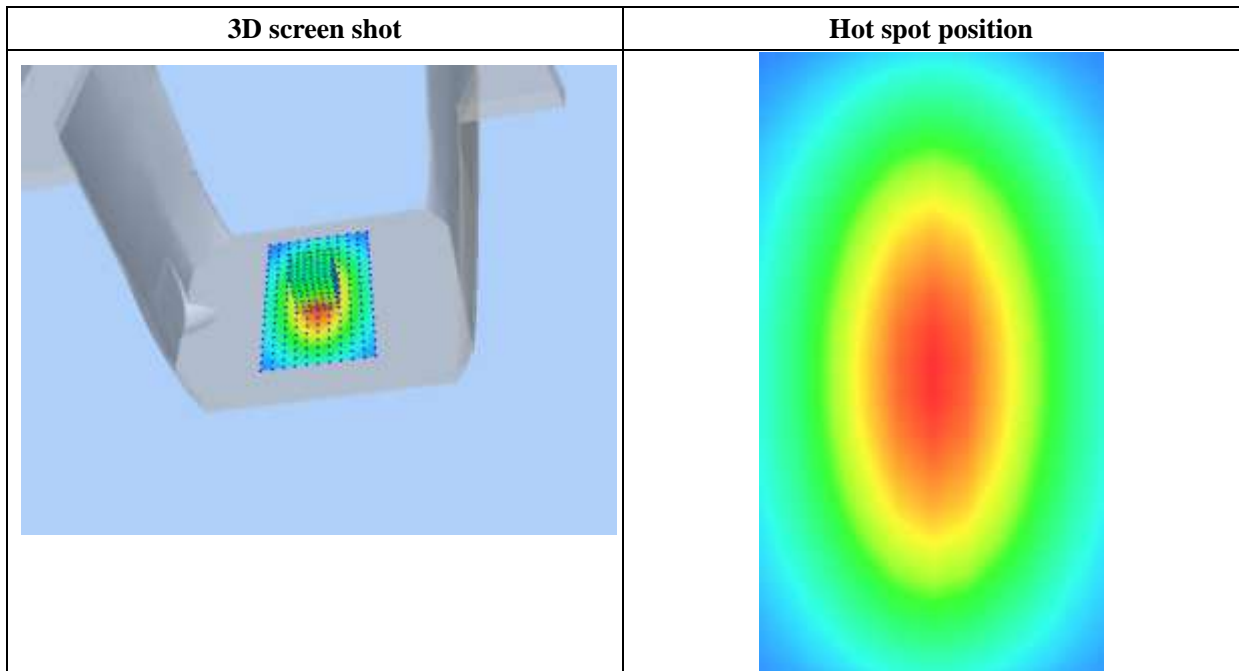
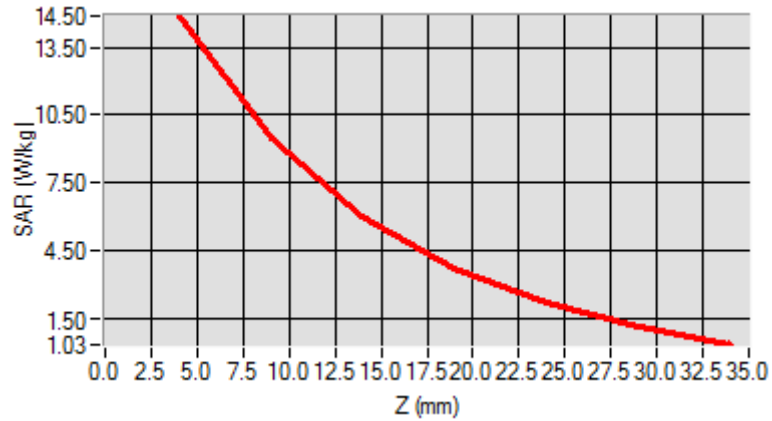

MEASUREMENT 7

For Body Liquid

Type: Validation measurement (Fast, 75.00 %)

Date of measurement: 04/16/2019

Measurement duration: 12 minutes 21 seconds

E-field Probe: SSE5 - SN 09/13 EP168; ConvF: 7.28; Calibrated: 06/01/2018

A. Experimental conditions

Area Scan	dx=8mm dy=8mm
Zoom Scan	dx=8mm dy=8mm dz=5mm
Phantom	Validation plane
Device Position	Dipole
Band	CW750
Signal	Duty Cycle 1:1

B. SAR Measurement Results

Frequency (MHz)	750.000000
Relative Permittivity (real part)	54.964739
Conductivity (S/m)	0.931048
Power Variation (%)	0.034745
Ambient Temperature	21.1
Liquid Temperature	21.3

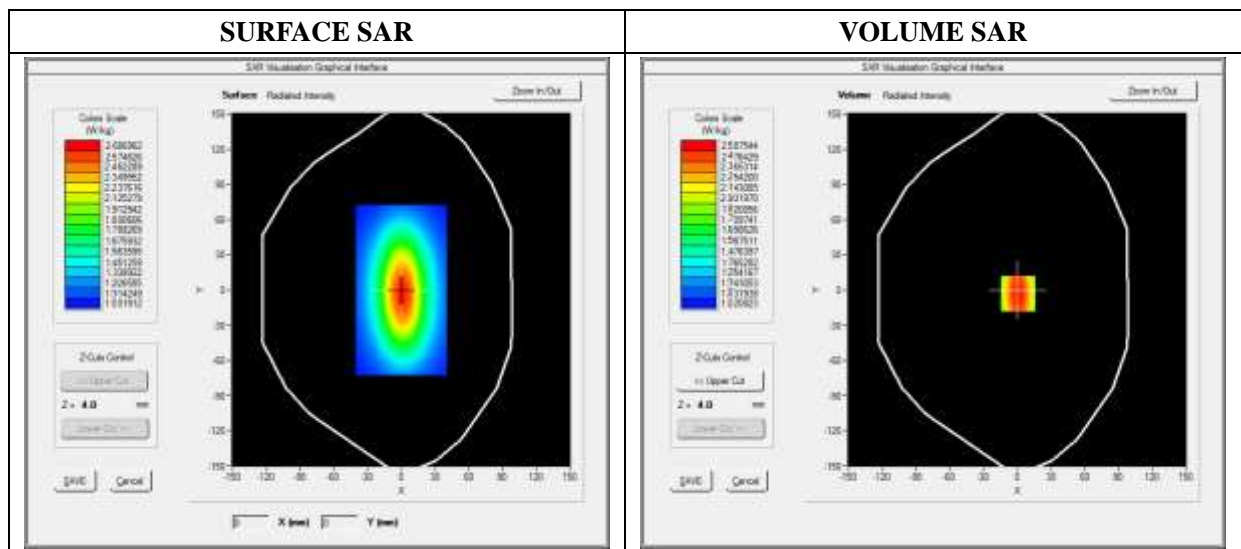

Maximum location: X=0.00, Y=0.00

SAR 10g (W/Kg)	1.000865
SAR 1g (W/Kg)	2.124211

Z Axis Scan

Z (mm)	0.00	4.00	9.00	14.00	19.00	24.00	29.00
SAR (W/Kg)	0.0000	2.5132	1.1087	0.8214	0.5160	0.4875	0.4864

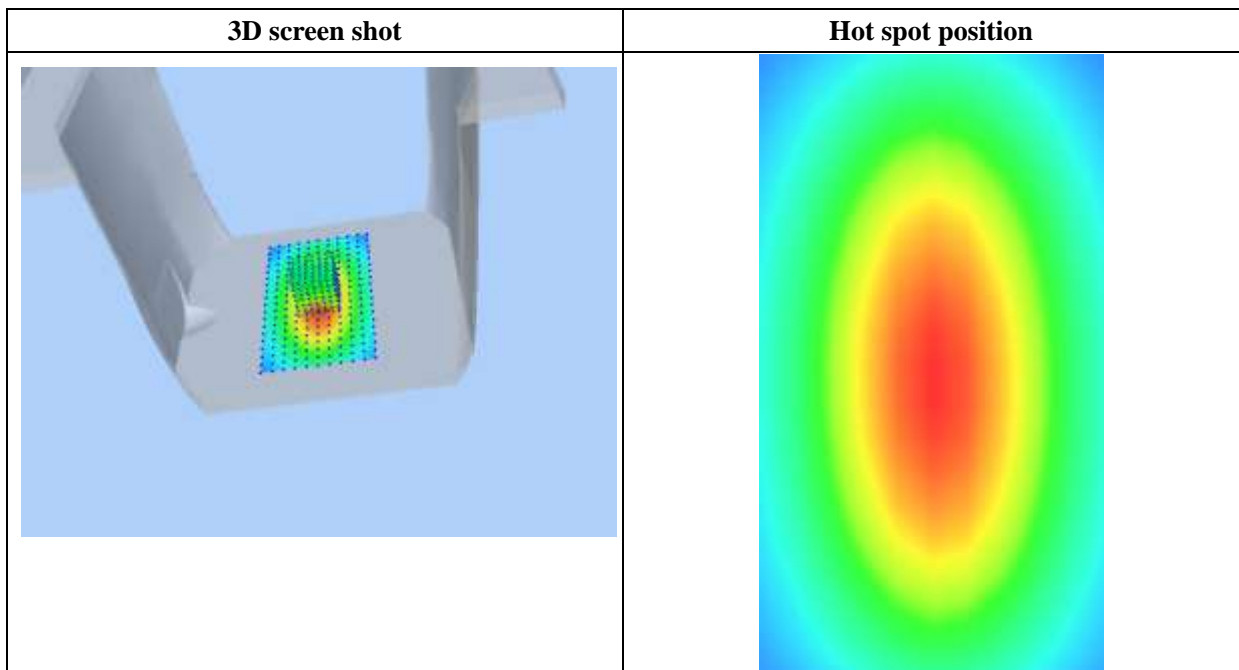
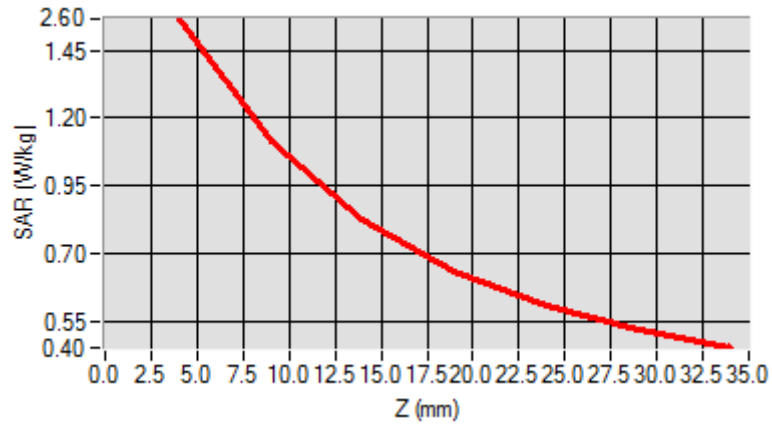

MEASUREMENT 8

For Body Liquid

Type: Validation measurement (Fast, 75.00 %)

Date of measurement: 04/16/2019

Measurement duration: 12 minutes 21 seconds

E-field Probe: SSE5 - SN 09/13 EP168; ConvF: 7.13; Calibrated: 06/01/2018

A. Experimental conditions

Area Scan	dx=8mm dy=8mm
Zoom Scan	dx=8mm dy=8mm dz=5mm
Phantom	Validation plane
Device Position	Dipole
Band	CW835
Signal	Duty Cycle 1:1

B. SAR Measurement Results

Frequency (MHz)	835.000000
Relative Permittivity (real part)	54.851214
Conductivity (S/m)	0.951454
Power Variation (%)	0.901472
Ambient Temperature	21.1
Liquid Temperature	21.3

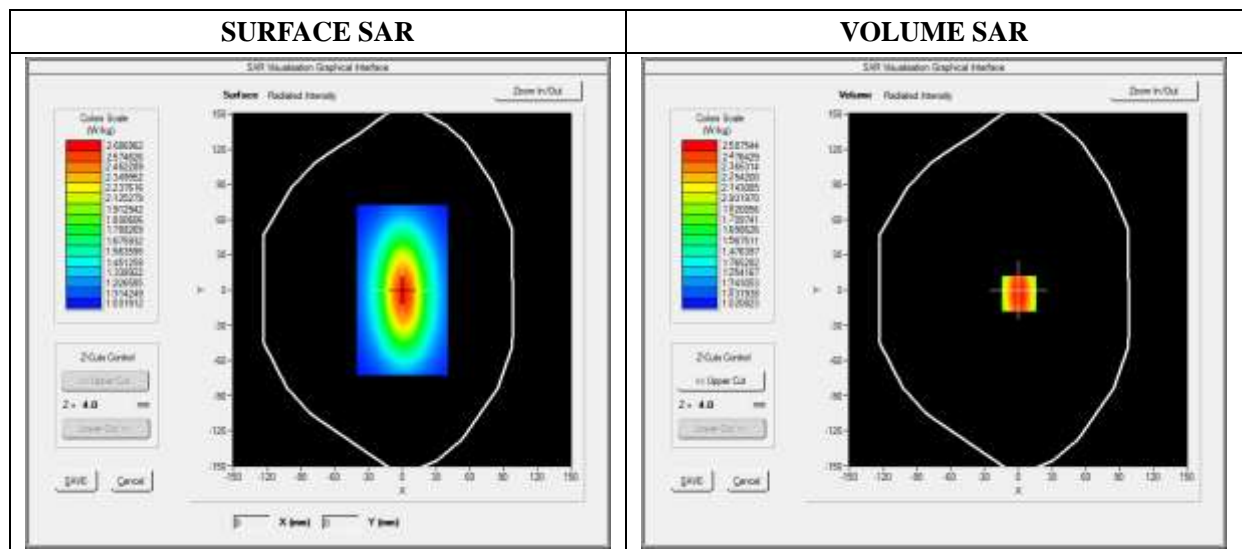

Maximum location: X=0.00, Y=0.00

SAR 10g (W/Kg)	1.028956
SAR 1g (W/Kg)	2.354211

Z Axis Scan

Z (mm)	0.00	4.00	9.00	14.00	19.00	24.00	29.00
SAR (W/Kg)	0.0000	2.5789	1.1300	0.8795	0.5940	0.5011	0.5100

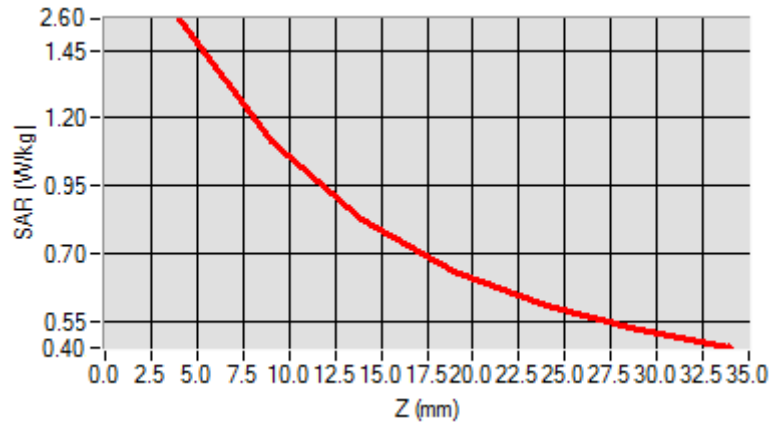

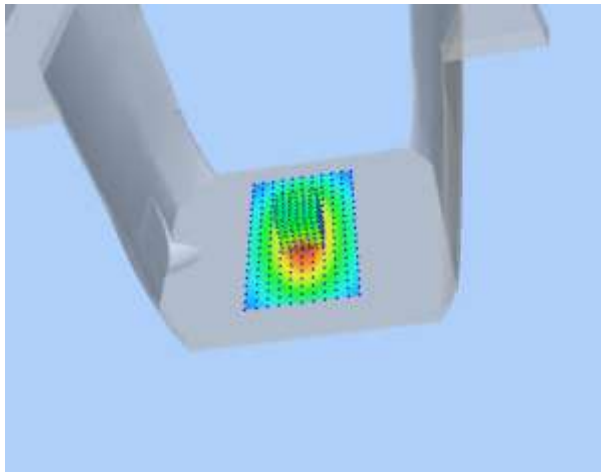
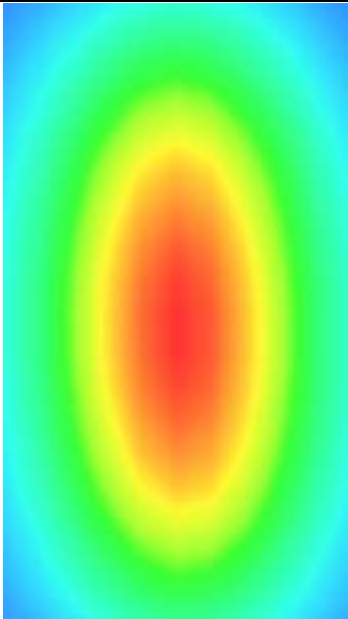
3D screen shot	Hot spot position
	

MEASUREMENT 9

For Body Liquid

Type: Validation measurement (Fast, 75.00 %)

Date of measurement: 04/17/2019

Measurement duration: 12 minutes 21 seconds

E-field Probe: SSE5 - SN 09/13 EP168; ConvF: 6.06; Calibrated: 06/01/2018

A. Experimental conditions

Area Scan	dx=8mm dy=8mm
Zoom Scan	dx=8mm dy=8mm dz=5mm
Phantom	Validation plane
Device Position	Dipole
Band	CW1800
Signal	CW (Crest factor: 1.0)

B. SAR Measurement Results

Frequency (MHz)	1800.000000
Relative Permittivity (real part)	51.224510
Conductivity (S/m)	1.461261
Power Variation (%)	0.845690
Ambient Temperature	21.1
Liquid Temperature	21.2

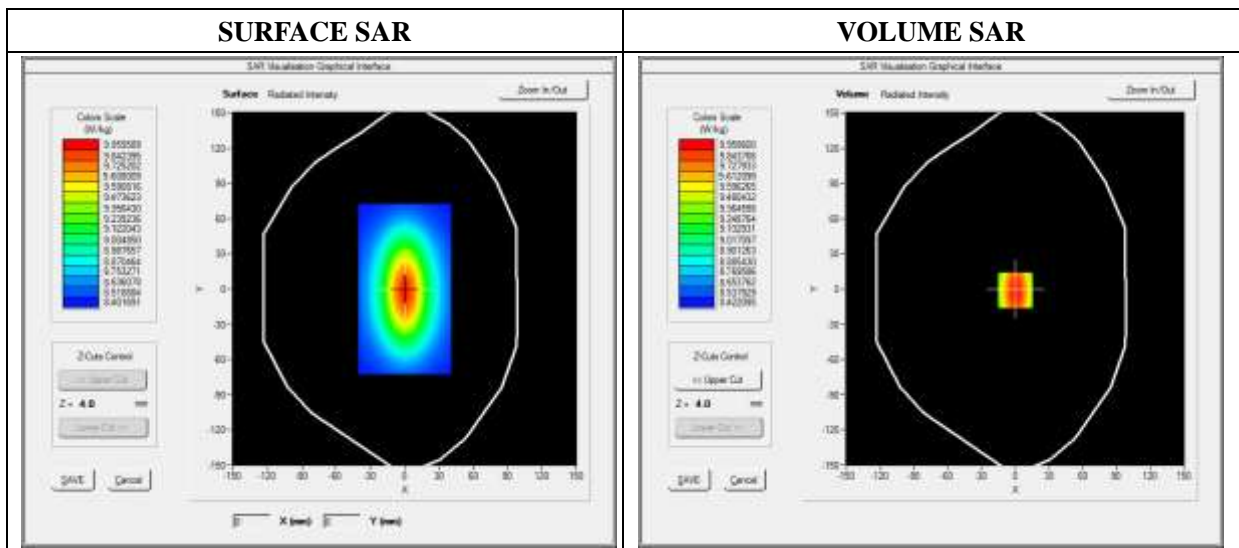

Maximum location: X=0.00, Y=0.00

SAR 10g (W/Kg)	5.221202
SAR 1g (W/Kg)	9.582560

Z Axis Scan

Z (mm)	0.00	4.00	9.00	14.00	19.00	24.00	29.00
SAR (W/Kg)	0.0000	11.2425	9.4123	8.0345	6.9125	6.3092	3.9460

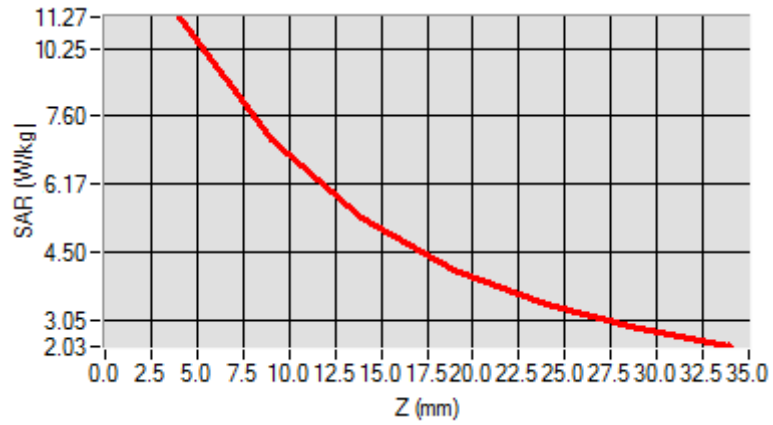

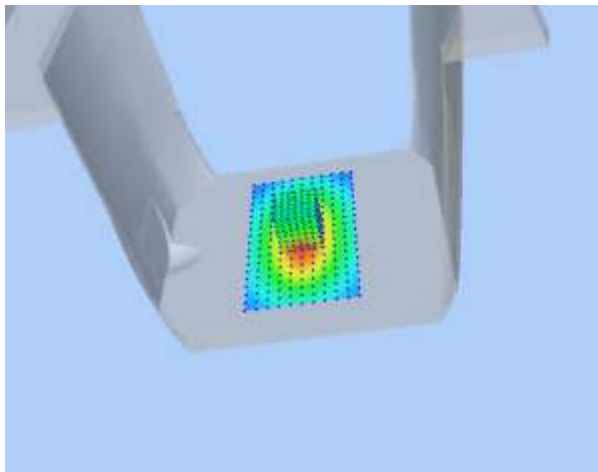
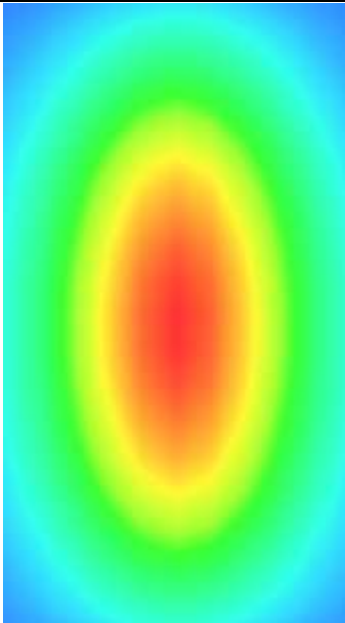
3D screen shot	Hot spot position
	

MEASUREMENT 10

For Body Liquid

Type: Validation measurement (Fast, 75.00 %)

Date of measurement: 04/17/2019

Measurement duration: 12 minutes 21 seconds

E-field Probe: SSE5 - SN 09/13 EP168; ConvF: 6.55; Calibrated: 06/01/2018

A. Experimental conditions

Area Scan	dx=8mm dy=8mm
Zoom Scan	dx=8mm dy=8mm dz=5mm
Phantom	Validation plane
Device Position	Dipole
Band	CW1900
Signal	Duty Cycle 1:1

B. SAR Measurement Results

Frequency (MHz)	1900.000000
Relative Permittivity (real part)	52.420415
Conductivity (S/m)	1.501966
Power Variation (%)	0.541872
Ambient Temperature	21.1
Liquid Temperature	21.3

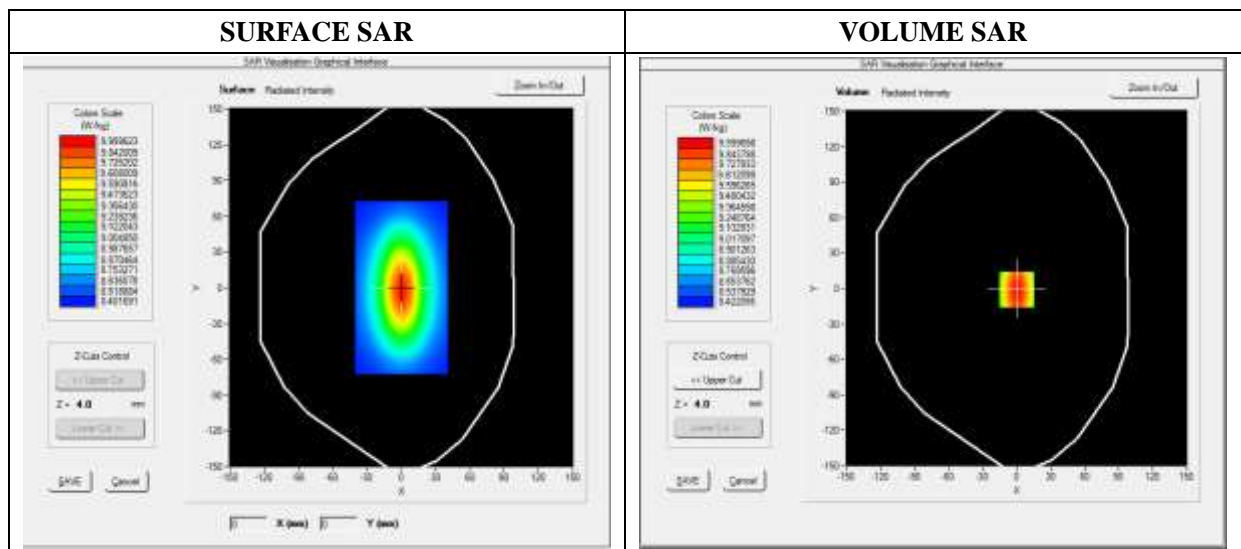

Maximum location: X=0.00, Y=0.00

SAR 10g (W/Kg)	5.134651
SAR 1g (W/Kg)	9.781550

Z Axis Scan

Z (mm)	0.00	4.00	9.00	14.00	19.00	24.00	29.00
SAR (W/Kg)	0.0000	10.2031	6.43001	4.9011	4.5325	3.1201	2.5024

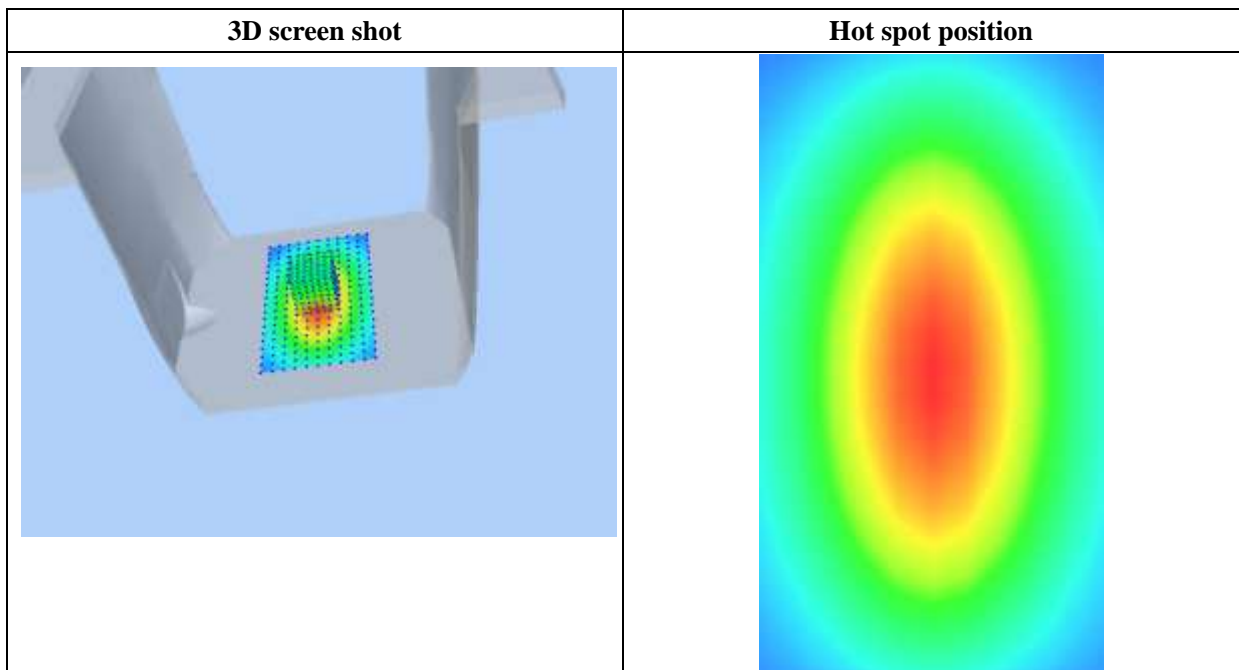
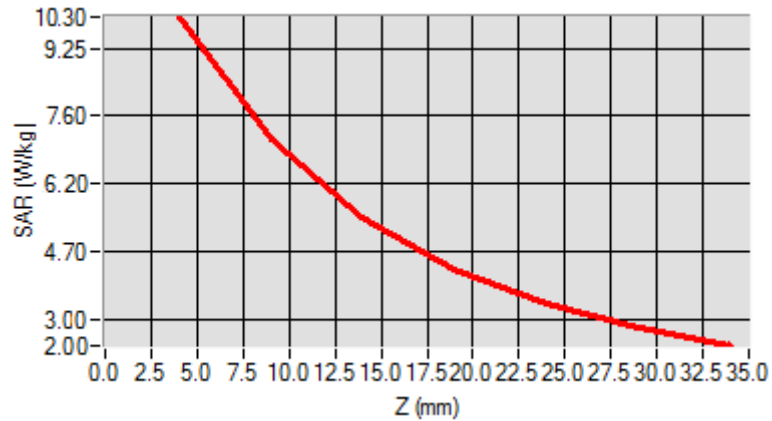

MEASUREMENT 11

For Body Liquid

Type: Validation measurement (Fast, 75.00 %)

Date of measurement: 04/18/2019

Measurement duration: 12 minutes 21 seconds

E-field Probe: SSE5 - SN 09/13 EP168; ConvF: 5.80; Calibrated: 06/01/2018

A. Experimental conditions

Area Scan	dx=8mm dy=8mm
Zoom Scan	dx=8mm dy=8mm dz=5mm
Phantom	Validation plane
Device Position	Dipole
Band	CW2450
Signal	Duty Cycle 1:1

B. SAR Measurement Results

Frequency (MHz)	2450.000000
Relative Permittivity (real part)	52.010212
Conductivity (S/m)	1.910255
Power Variation (%)	1.369745
Ambient Temperature	21.1
Liquid Temperature	21.2

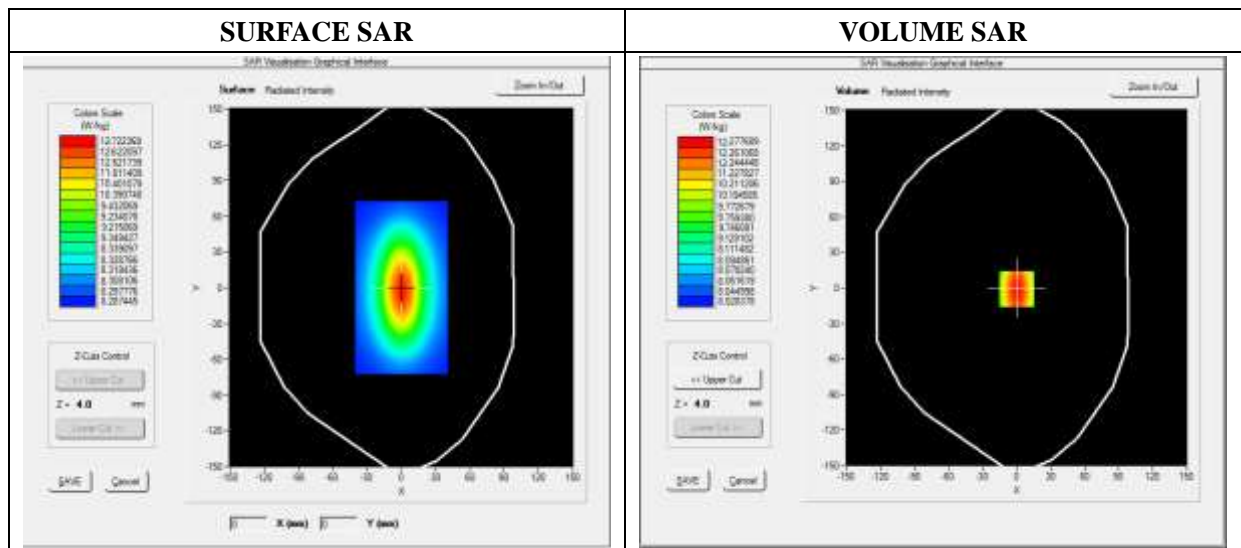

Maximum location: X=0.00, Y=0.00

SAR 10g (W/Kg)	7.119522
SAR 1g (W/Kg)	12.592360

Z Axis Scan

Z (mm)	0.00	4.00	9.00	14.00	19.00	24.00	29.00
SAR (W/Kg)	0.0000	13.1911	11.7951	9.2945	8.5400	6.3712	4.6225

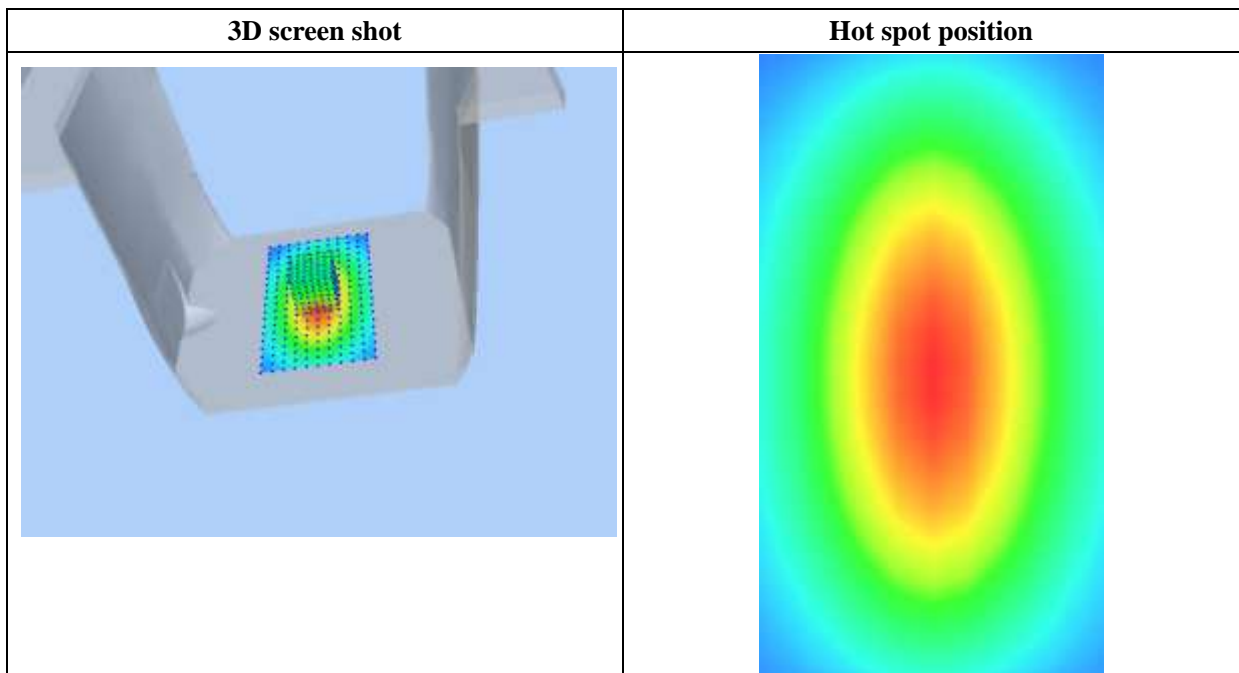
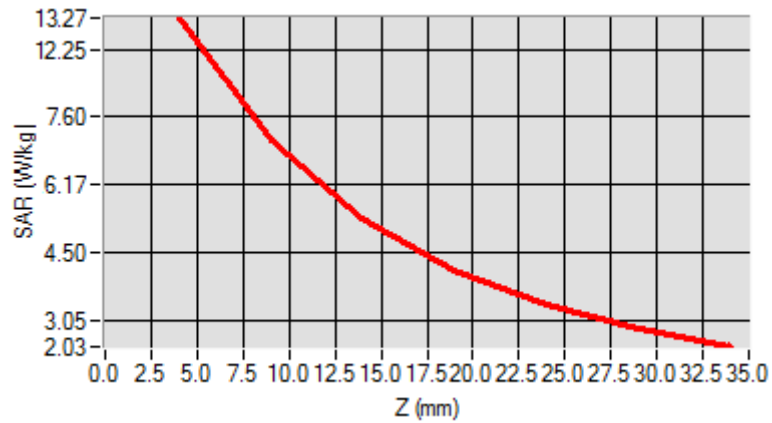

MEASUREMENT 12

For Body Liquid

Type: Validation measurement (Fast, 75.00 %)

Date of measurement: 04/18/2019

Measurement duration: 12 minutes 21 seconds

E-field Probe: SSE5 - SN 09/13 EP168; ConvF: 5.58; Calibrated: 06/01/2018

A. Experimental conditions

Area Scan	dx=8mm dy=8mm
Zoom Scan	dx=8mm dy=8mm dz=5mm
Phantom	Validation plane
Device Position	Dipole
Band	CW2600
Signal	Duty Cycle 1:1

B. SAR Measurement Results

Frequency (MHz)	2600.000000
Relative Permittivity (real part)	52.241202
Conductivity (S/m)	2.120943
Power Variation (%)	1.038832
Ambient Temperature	21.1
Liquid Temperature	21.2

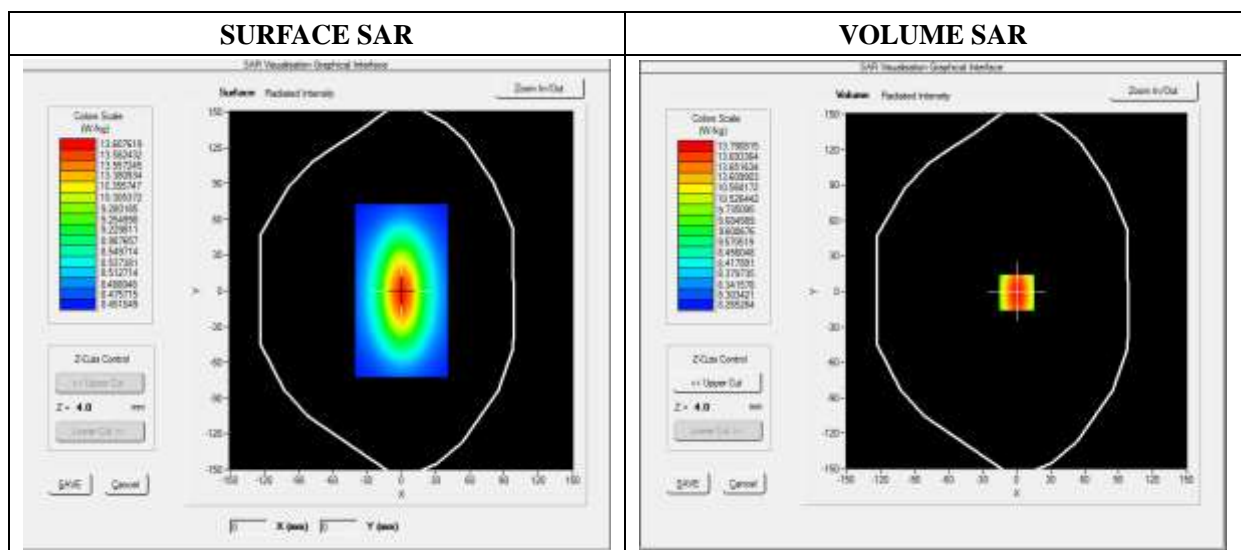

Maximum location: X=0.00, Y=0.00

SAR 10g (W/Kg)	6.083781
SAR 1g (W/Kg)	13.430481

Z Axis Scan

Z (mm)	0.00	4.00	9.00	14.00	19.00	24.00	29.00
SAR (W/Kg)	0.0000	13.6473	11.8441	9.3627	8.5782	6.4357	4.6342

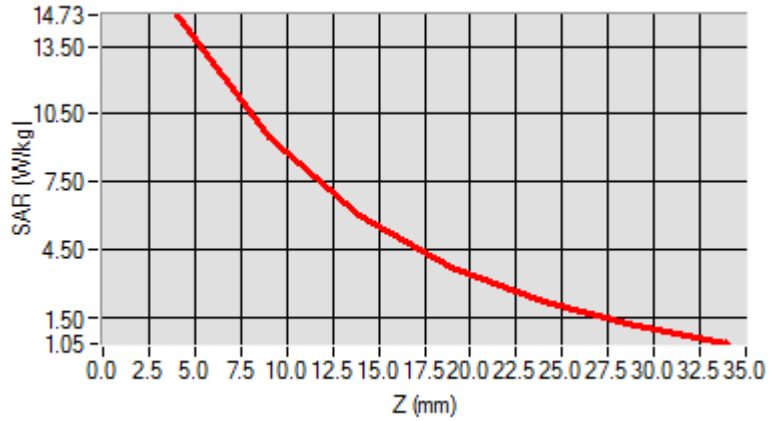

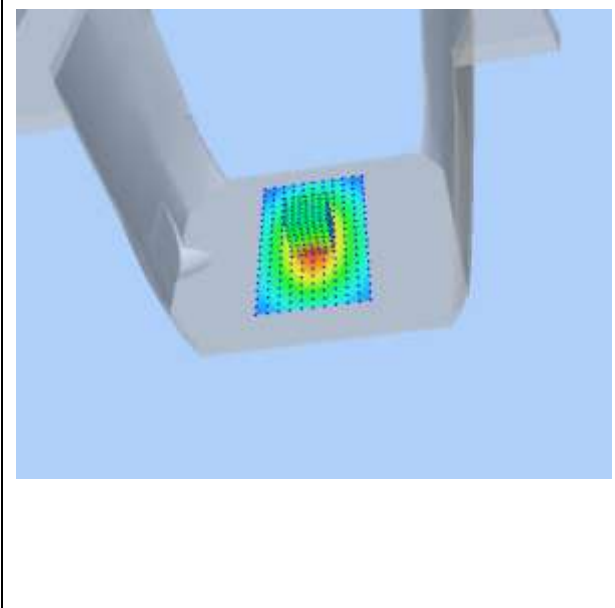
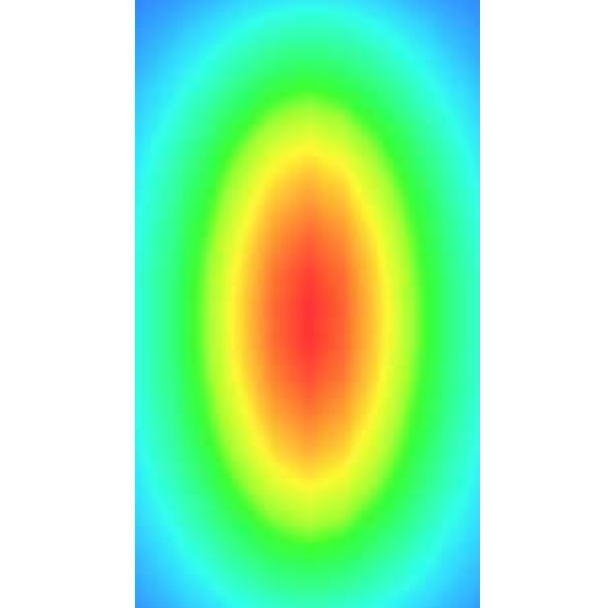
3D screen shot	Hot spot position
	

Annex B. Plots of SAR Measurement

<u>BAND</u>	<u>PARAMETERS</u>
GSM850	<u>Measurement 1</u> : Flat Plane with Front side(Front-of-face) device position on High Channel in GSM mode
GSM1900	<u>Measurement 2</u> : Flat Plane with Front side(Front-of-face) device position on Low Channel in GSM mode
GPRS850_4TX	<u>Measurement 3</u> : Flat Plane with Front side(Front-of-face) device position on High Channel in PTT mode
GPRS1900_4TX	<u>Measurement 4</u> : Flat Plane with Front side(Front-of-face) device position on High Channel in PTT mode
WCDMA1900	<u>Measurement 5</u> : Flat Plane with Front side(Front-of-face) device position on Low Channel in WCDMA mode
WCDMA850	<u>Measurement 6</u> : Flat Plane with Front side(Front-of-face) device position on Low Channel in WCDMA mode
LTE Band 2	<u>Measurement 7</u> : Flat Plane with Front side(Front-of-face) device position on Low Channel in LTE mode
LTE Band 4	<u>Measurement 9</u> : Flat Plane with Front side(Front-of-face) device position on Low Channel in LTE mode
LTE Band 5	<u>Measurement 11</u> : Flat Plane with Front side(Front-of-face) device position on Low Channel in LTE mode
LTE Band 7	<u>Measurement 13</u> : Flat Plane with Front side(Front-of-face) device position on Low Channel in LTE mode
LTE Band 12	<u>Measurement 15</u> : Flat Plane with Front side(Front-of-face) device position on Low Channel in LTE mode
LTE Band 13	<u>Measurement 17</u> : Flat Plane with Front side(Front-of-face) device position on Middle Channel in LTE mode
LTE Band 17	<u>Measurement 19</u> : Flat Plane with Front side(Front-of-face) device position on High Channel in LTE mode
WiFi_802.11b	<u>Measurement 21</u> : Flat Plane with Front side(Front-of-face) device position on Middle Channel in 802.11b mode
GPRS850_4TX	<u>Measurement 22</u> : Flat Plane with Back device position on High Channel in GPRS mode
GPRS1900_4TX	<u>Measurement 25</u> : Flat Plane with Back device position on High Channel in GPRS mode
WCDMA1900	<u>Measurement 26</u> : Flat Plane with Back side device position on Low Channel in WCDMA mode
WCDMA850	<u>Measurement 27</u> : Flat Plane with Back device position on Low Channel in WCDMA mode
LTE Band 2	<u>Measurement 28</u> : Flat Plane with Back device position on Low Channel in LTE mode

LTE Band 4	<u>Measurement 30</u> : Flat Plane with Back device position on Low Channel in LTE mode
LTE Band 5	<u>Measurement 32</u> : Flat Plane with Back device position on Low Channel in LTE mode
LTE Band 7	<u>Measurement 34</u> : Flat Plane with Back device position on Low Channel in LTE mode
LTE Band 12	<u>Measurement 36</u> : Flat Plane with Back device position on Low Channel in LTE mode
LTE Band 13	<u>Measurement 38</u> : Flat Plane with Back device position on Middle Channel in LTE mode
LTE Band 17	<u>Measurement 40</u> : Flat Plane with Back device position on High Channel in LTE mode
WiFi_802.11b	<u>Measurement 42</u> : Flat Plane with Back side device position on Middle Channel in 802.11b mode
<i>Remark: SAR plot is showed the highest measured SAR in each exposure configuration, wireless mode and frequency band combination.</i>	

MEASUREMENT 1

Type: Phone measurement (Complete)

Date of measurement: 04/16/2019

Measurement duration: 11 minutes 48 seconds

E-field Probe: SSE5 - SN 09/13 EP168; ConvF: 6.93; Calibrated: 06/01/2018

A. Experimental conditions

Area Scan	dx=8mm dy=8mm
Zoom Scan	dx=8mm dy=8mm dz=5mm
Phantom	Flat plane
Device Position	Front
Band	GSM850
Channels	High
Signal	TDMA (Crest factor: 8.0)

B. SAR Measurement Results

Frequency (MHz)	848.800000
Relative Permittivity (real part)	41.110245
Conductivity (S/m)	0.871245
Power Variation (%)	1.144536
Ambient Temperature	21.1
Liquid Temperature	21.3

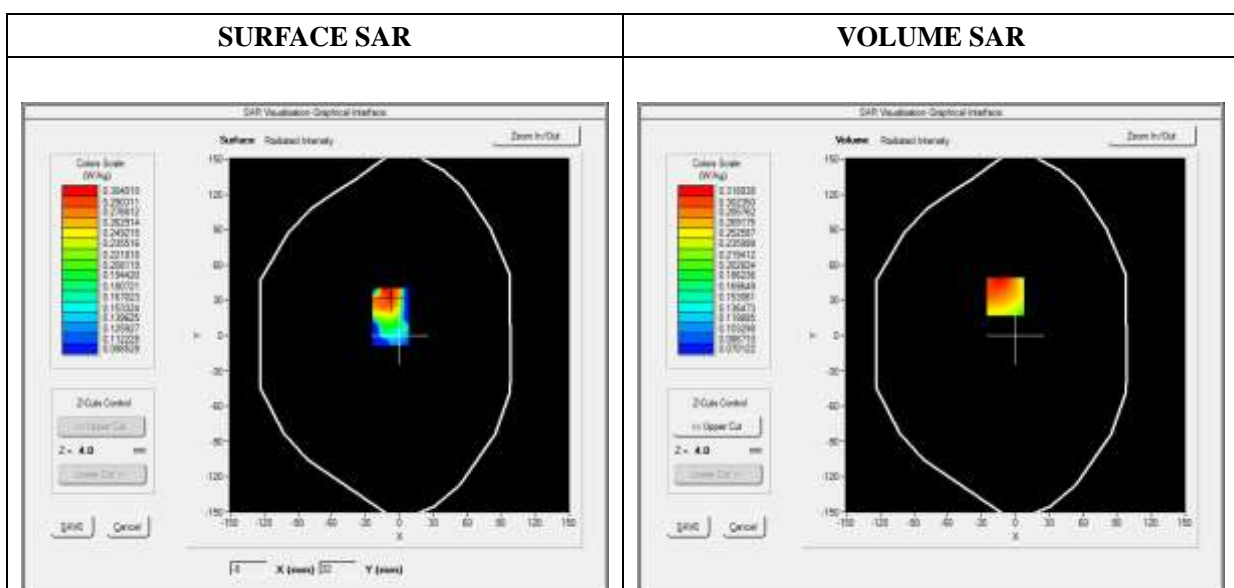

Maximum location: X=-9.00, Y=33.00

SAR Peak: 0.40 W/kg

SAR 10g (W/Kg)	0.227761
SAR 1g (W/Kg)	0.303927

Z (mm)	0.00	4.00	9.00	14.00	19.00
SAR (W/Kg)	0.9950	0.3189	0.1745	0.1886	0.1080

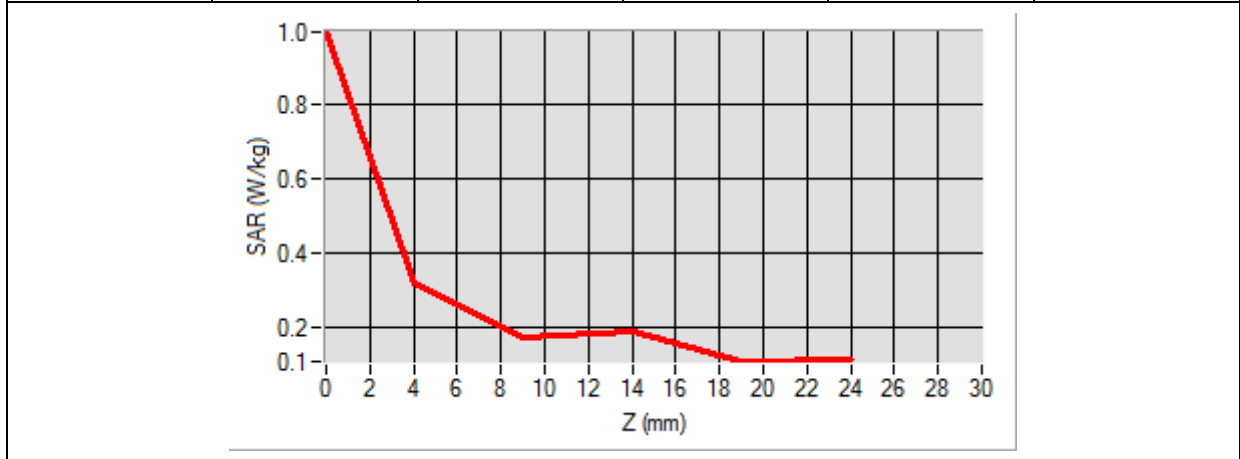

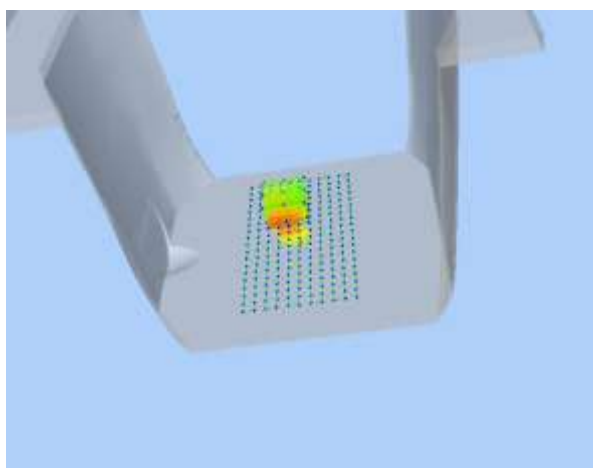
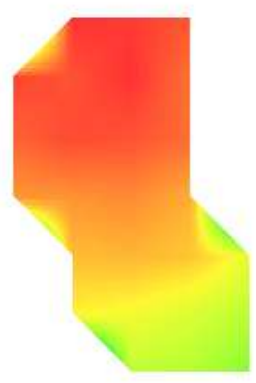
<p>3D screen shot</p>	<p>Hot spot position</p>
	

MEASUREMENT 2

Type: Phone measurement (Complete)

Date of measurement: 04/17/2019

Measurement duration: 11 minutes 48 seconds

E-field Probe: SSE5 - SN 09/13 EP168; ConvF: 6.35; Calibrated: 06/01/2018

A. Experimental conditions

Area Scan	dx=8mm dy=8mm
Zoom Scan	dx=8mm dy=8mm dz=5mm
Phantom	Flat plane
Device Position	Front
Band	GSM1900
Channels	Low
Signal	TDMA (Crest factor: 8.0)

B. SAR Measurement Results

Frequency (MHz)	1850.200000
Relative Permittivity (real part)	38.560124
Conductivity (S/m)	1.380369
Power Variation (%)	1.442440
Ambient Temperature	21.1
Liquid Temperature	21.3

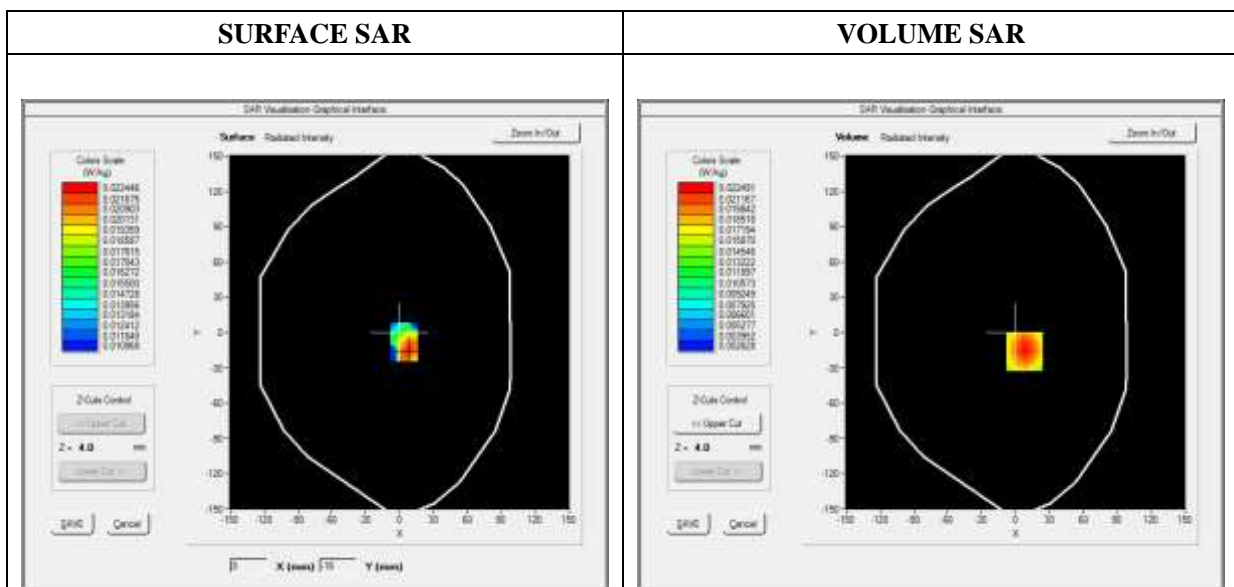



Maximum location: X=8.00, Y=-16.00

SAR Peak: 0.03 W/kg

SAR 10g (W/Kg)	0.012892
SAR 1g (W/Kg)	0.021466

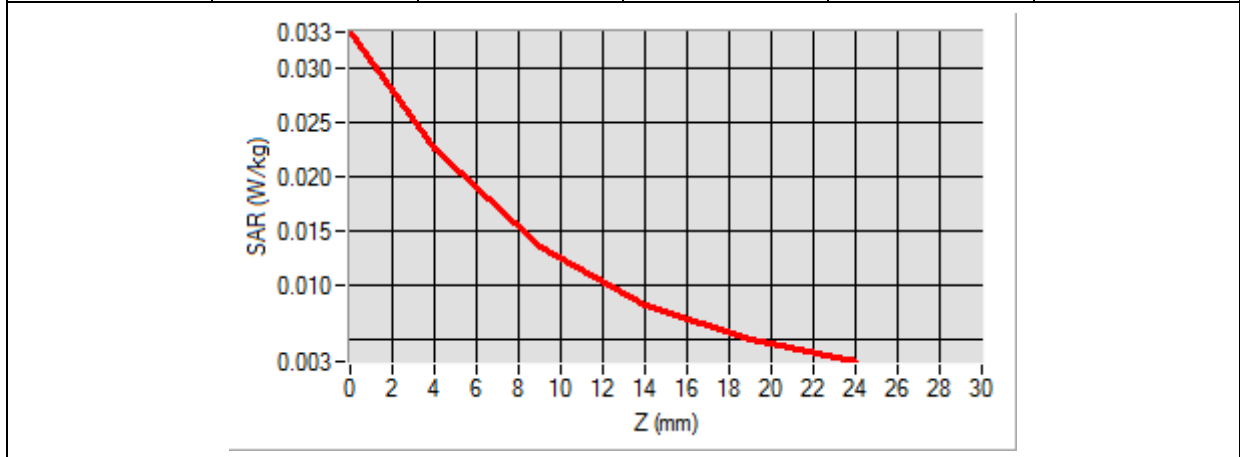
Z (mm)	0.00	4.00	9.00	14.00	19.00
SAR (W/Kg)	0.0332	0.0225	0.0136	0.0082	0.0051

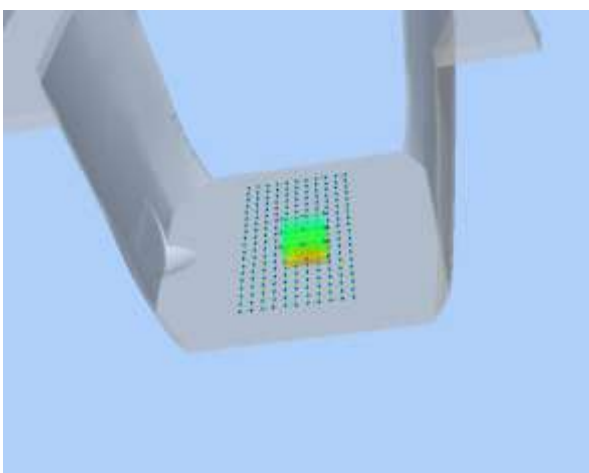

<p>3D screen shot</p>	<p>Hot spot position</p>
	

MEASUREMENT 3

Type: Phone measurement (Complete)

Date of measurement: 04/16/2019

Measurement duration: 12 minutes 3 seconds

E-field Probe: SSE5 - SN 09/13 EP168; ConvF: 6.93; Calibrated: 06/01/2018

A. Experimental conditions

Area Scan	dx=8mm dy=8mm
Zoom Scan	dx=8mm dy=8mm dz=5mm
Phantom	Flat plane
Device Position	Front
Band	GPRS850_4TX
Channels	High
Signal	Duty Cycle: 1:2

B. SAR Measurement Results

Frequency (MHz)	848.800000
Relative Permittivity (real part)	41.110245
Conductivity (S/m)	0.871245
Power Variation (%)	1.539211
Ambient Temperature	21.1
Liquid Temperature	21.3

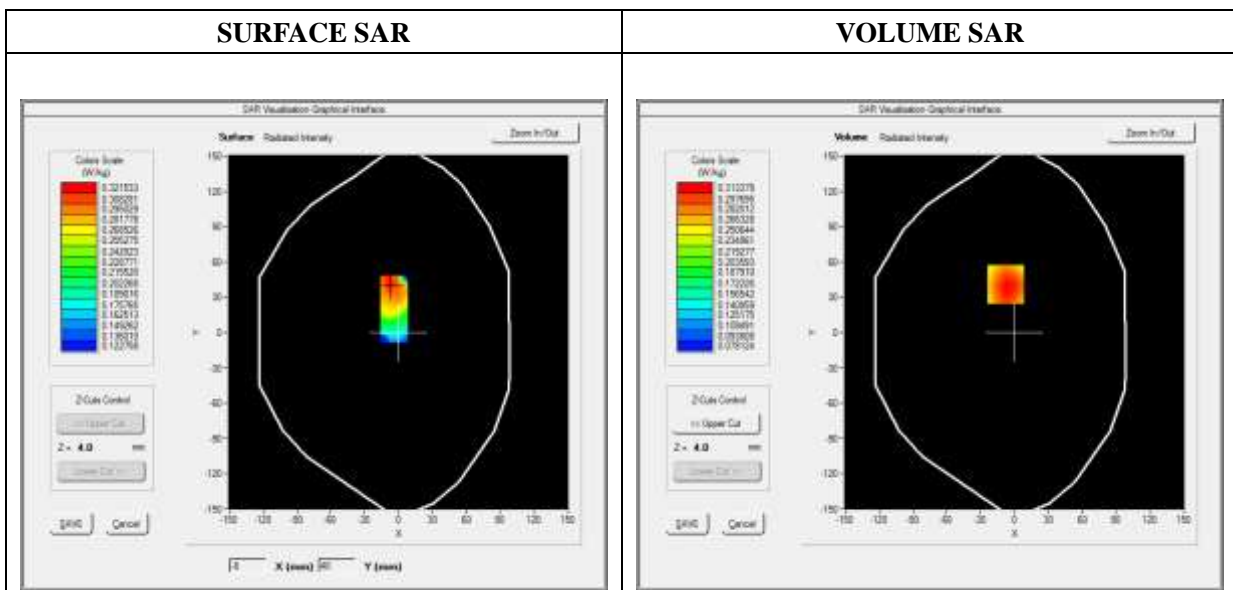



Maximum location: X=-8.00, Y=41.00

SAR Peak: 0.41 W/kg

SAR 10g (W/Kg)	0.217881
SAR 1g (W/Kg)	0.303974

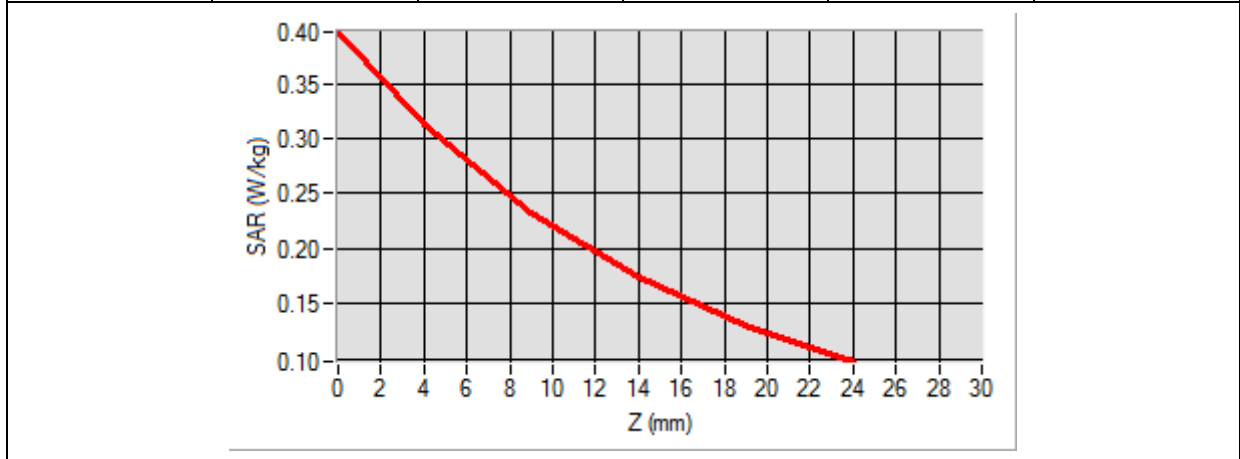
Z (mm)	0.00	4.00	9.00	14.00	19.00
SAR (W/Kg)	0.3968	0.3134	0.2330	0.1743	0.1314

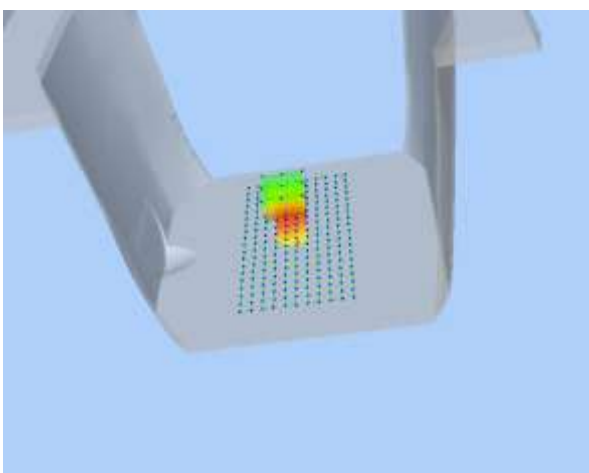

3D screen shot	Hot spot position
	

MEASUREMENT 4

Type: Phone measurement (Complete)

Date of measurement: 04/17/2019

Measurement duration: 12 minutes 3 seconds

E-field Probe: SSE5 - SN 09/13 EP168; ConvF: 6.35; Calibrated: 06/01/2018

A. Experimental conditions

Area Scan	dx=8mm dy=8mm
Zoom Scan	dx=8mm dy=8mm dz=5mm
Phantom	Flat plane
Device Position	Front
Band	GPRS1900_4TX
Channels	High
Signal	Duty Cycle: 1:2

B. SAR Measurement Results

Frequency (MHz)	1909.800000
Relative Permittivity (real part)	38.560124
Conductivity (S/m)	1.380369
Power Variation (%)	1.536272
Ambient Temperature	21.1
Liquid Temperature	21.3

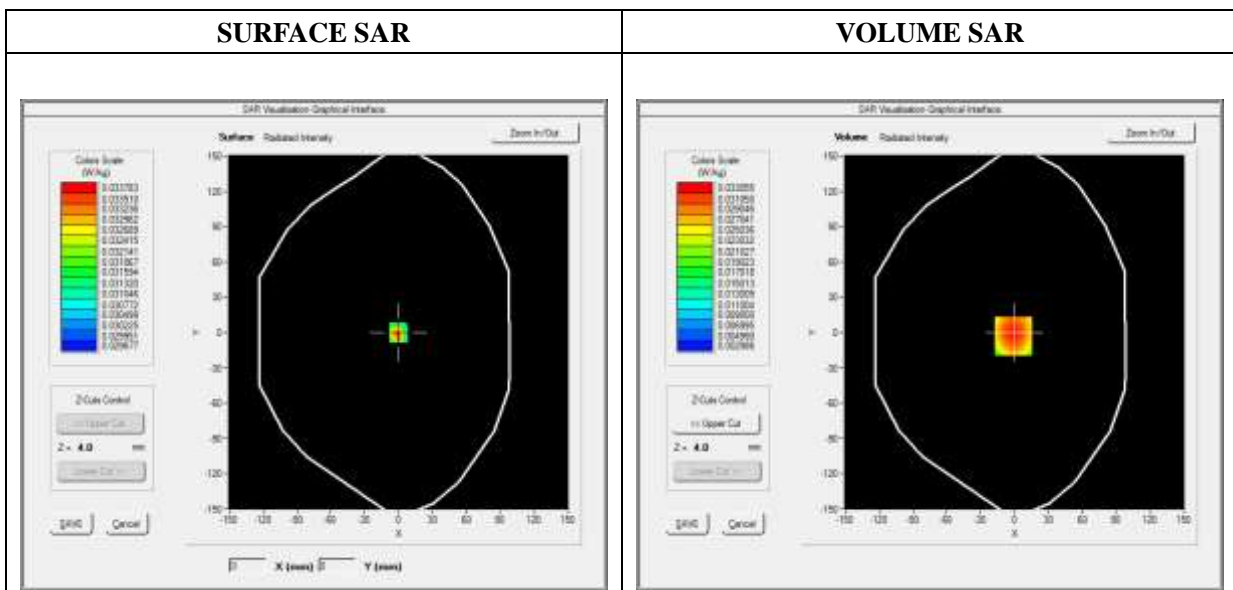



Maximum location: X=-1.00, Y=-3.00

SAR Peak: 0.05 W/kg

SAR 10g (W/Kg)	0.018850
SAR 1g (W/Kg)	0.031521

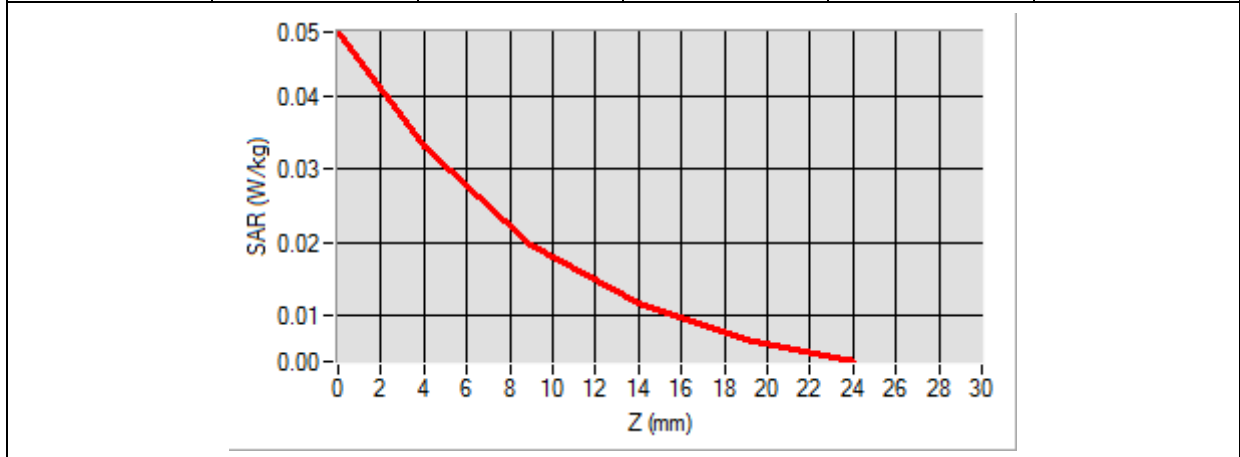
Z (mm)	0.00	4.00	9.00	14.00	19.00
SAR (W/Kg)	0.0489	0.0331	0.0198	0.0116	0.0068

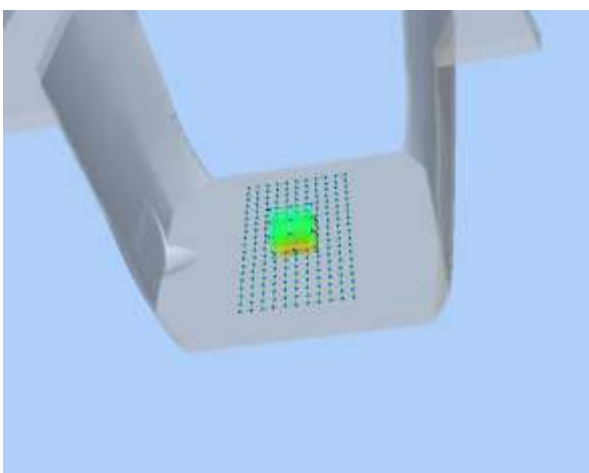

<p>3D screen shot</p>	<p>Hot spot position</p>
	

MEASUREMENT 5

Type: Phone measurement (Complete)

Date of measurement: 04/17/2019

Measurement duration: 12 minutes 3 seconds

E-field Probe: SSE5 - SN 09/13 EP168; ConvF: 6.35; Calibrated: 06/01/2018

A. Experimental conditions

Area Scan	dx=8mm dy=8mm
Zoom Scan	dx=8mm dy=8mm dz=5mm
Phantom	Flat plane
Device Position	Front
Band	WCDMA1900_RMC
Channels	Low
Signal	Duty Cycle 1:1

B. SAR Measurement Results

Frequency (MHz)	1852.400000
Relative Permittivity (real part)	38.560124
Conductivity (S/m)	1.380369
Power Variation (%)	1.524540
Ambient Temperature	21.1
Liquid Temperature	21.3

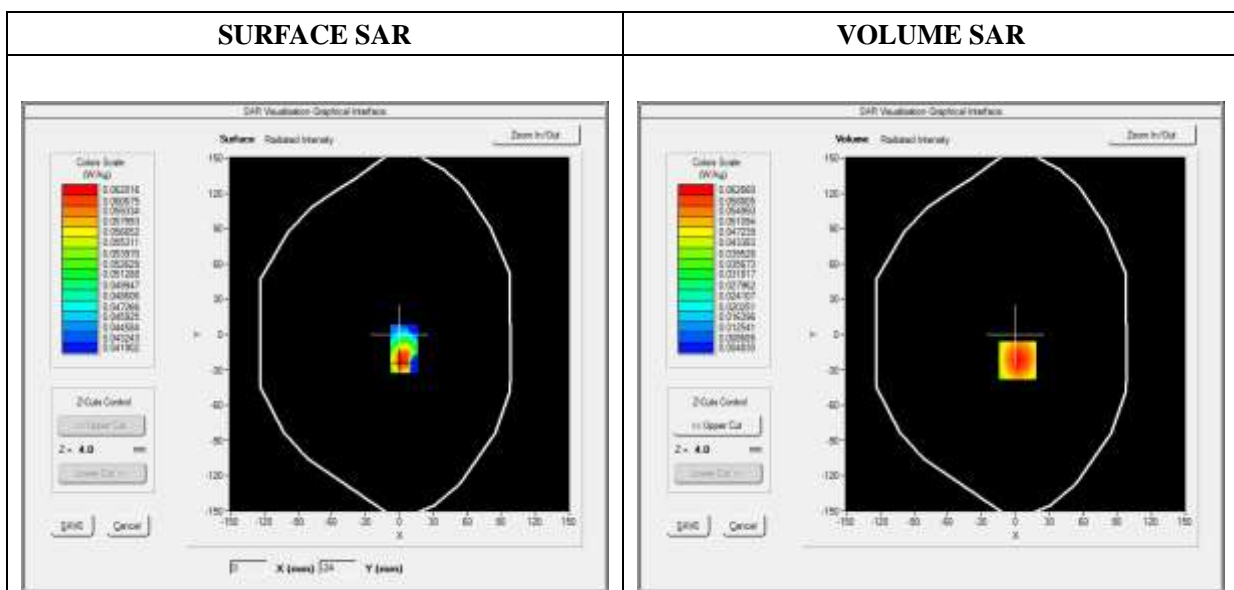



Maximum location: X=2.00, Y=-22.00

SAR Peak: 0.10 W/kg

SAR 10g (W/Kg)	0.034993
SAR 1g (W/Kg)	0.059570

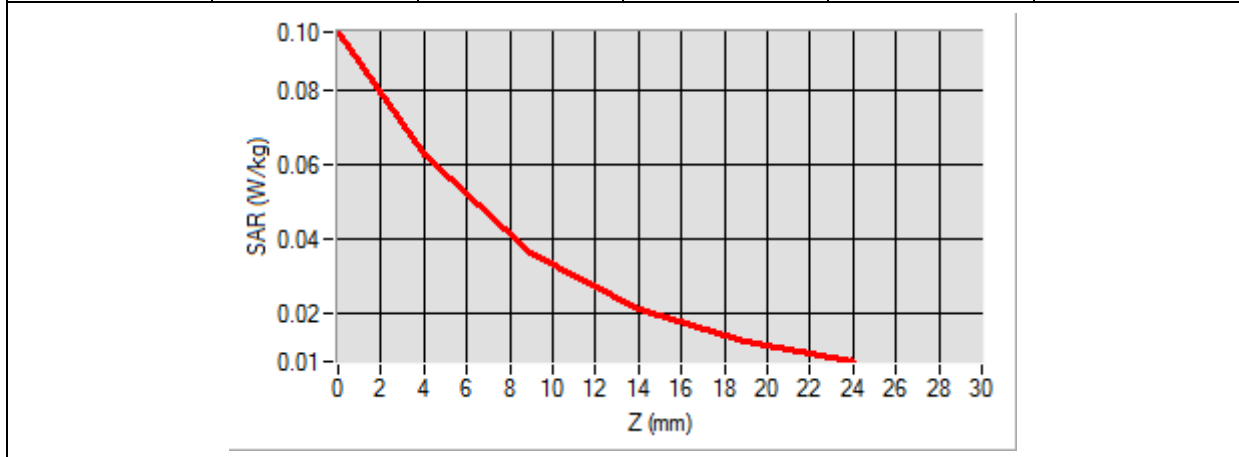
Z (mm)	0.00	4.00	9.00	14.00	19.00
SAR (W/Kg)	0.0953	0.0627	0.0363	0.0210	0.0125

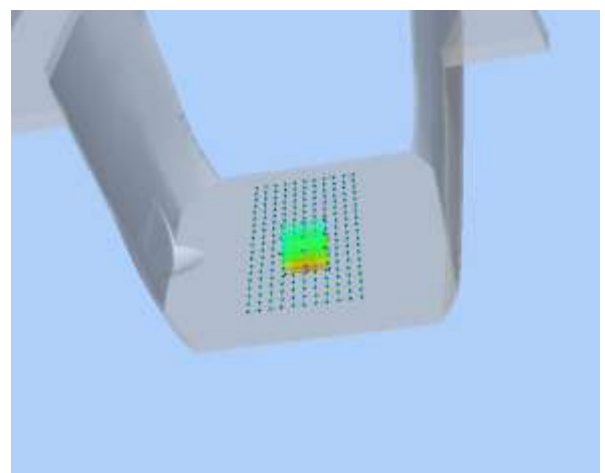

3D screen shot	Hot spot position
	

MEASUREMENT 6

Type: Phone measurement (Complete)

Date of measurement: 04/16/2019

Measurement duration: 12 minutes 3 seconds

E-field Probe: SSE5 - SN 09/13 EP168; ConvF: 6.93; Calibrated: 06/01/2018

A. Experimental conditions

Area Scan	dx=8mm dy=8mm
Zoom Scan	dx=8mm dy=8mm dz=5mm
Phantom	Flat plane
Device Position	Front
Band	WCDMA850_RMC
Channels	Low
Signal	Duty Cycle 1:1

B. SAR Measurement Results

Frequency (MHz)	826.400000
Relative Permittivity (real part)	41.110245
Conductivity (S/m)	0.871245
Power Variation (%)	1.342427
Ambient Temperature	21.1
Liquid Temperature	21.3

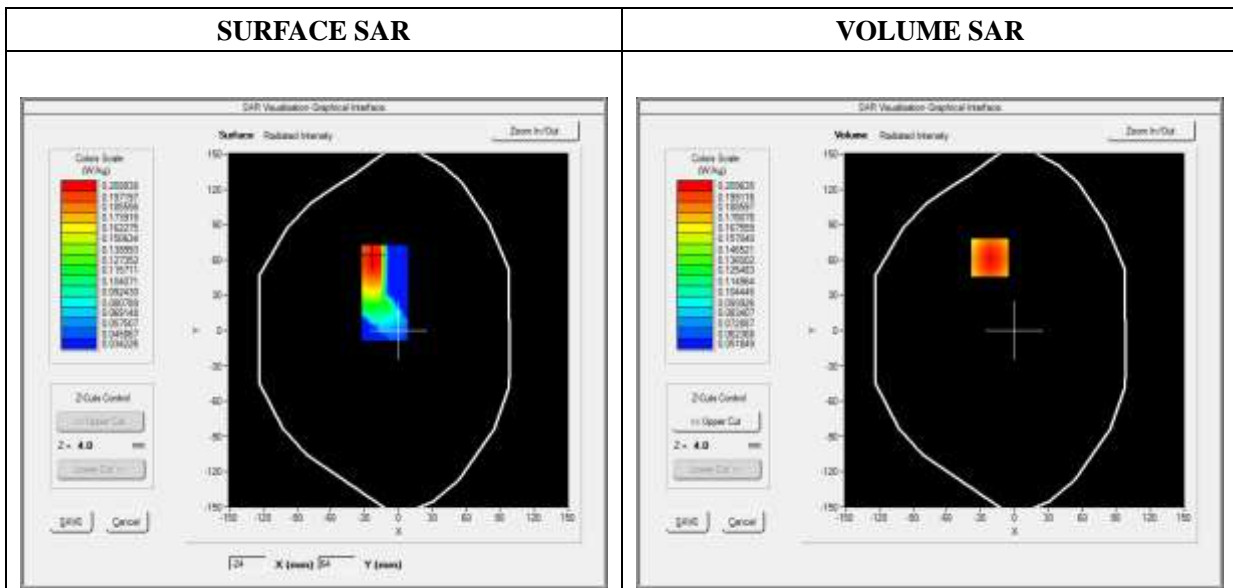

Maximum location: X=-22.00, Y=62.00

SAR Peak: 0.27 W/kg

SAR 10g (W/Kg)	0.146265
SAR 1g (W/Kg)	0.202241

Z (mm)	0.00	4.00	9.00	14.00	19.00
SAR (W/Kg)	0.2653	0.2096	0.1562	0.1174	0.0892

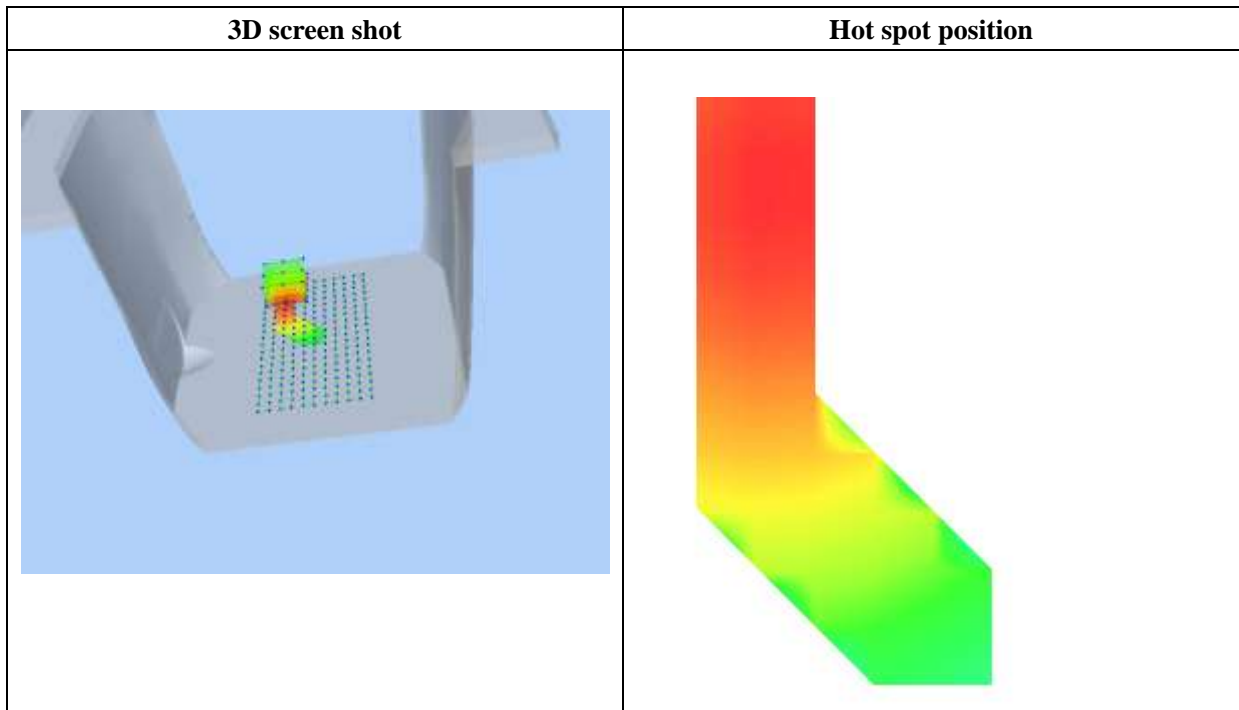
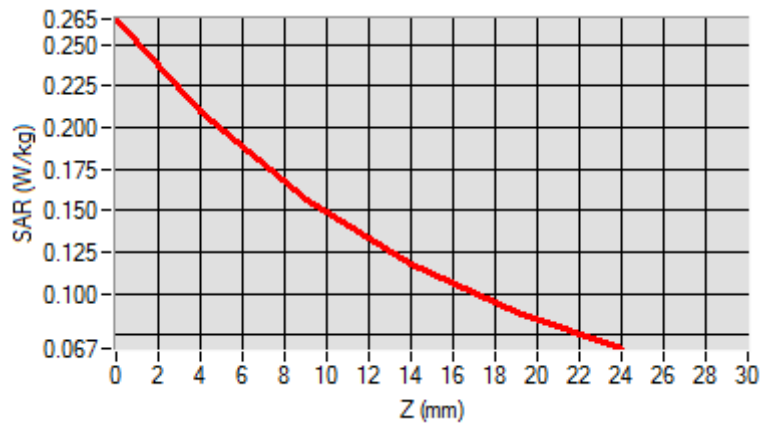

MEASUREMENT 7

Type: Phone measurement (Complete)

Date of measurement: 04/17/2019

Measurement duration: 12 minutes 3 seconds

E-field Probe: SSE5 - SN 09/13 EP168; ConvF: 6.35; Calibrated: 06/01/2018

A. Experimental conditions

Area Scan	dx=8mm dy=8mm
Zoom Scan	dx=8mm dy=8mm dz=5mm
Phantom	Flat plane
Device Position	Front
Band	LTE Band 2
Channels	QPSK, 20MHz, 1RB, Low
Signal	Duty Cycle 1:1

B. SAR Measurement Results

Frequency (MHz)	1860.000000
Relative Permittivity (real part)	38.560124
Conductivity (S/m)	1.380369
Power Variation (%)	1.743564
Ambient Temperature	21.1
Liquid Temperature	21.3

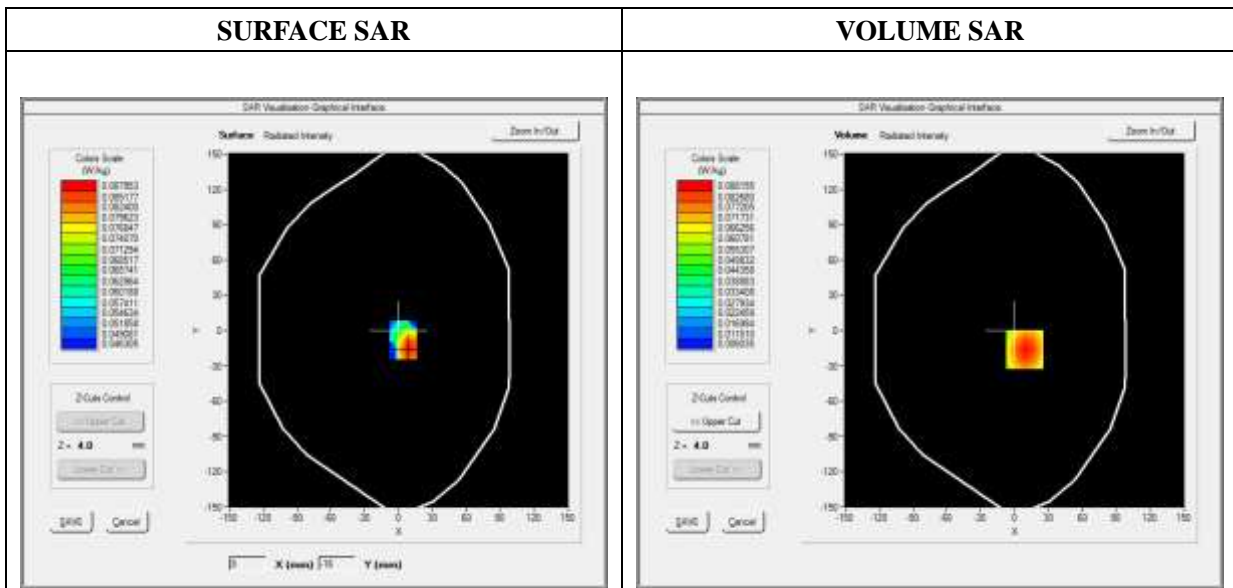



Maximum location: X=9.00, Y=-16.00

SAR Peak: 0.13 W/kg

SAR 10g (W/Kg)	0.049586
SAR 1g (W/Kg)	0.083926

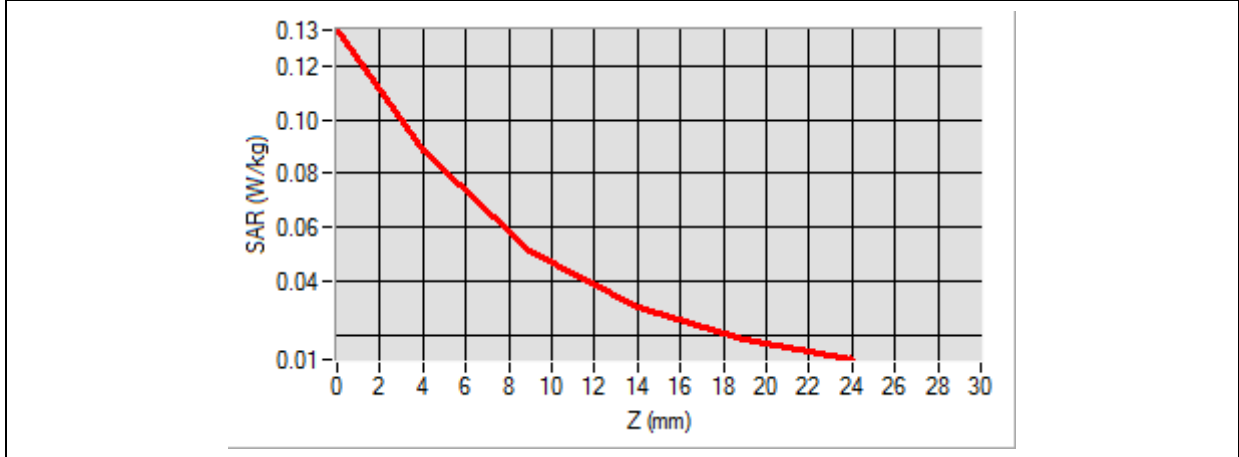
Z (mm)	0.00	4.00	9.00	14.00	19.00
SAR (W/Kg)	0.1333	0.0882	0.0515	0.0302	0.0183

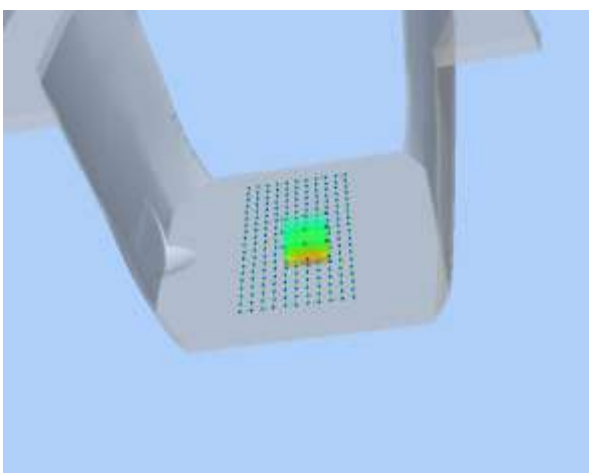

3D screen shot	Hot spot position
	

MEASUREMENT 9

Type: Phone measurement (Complete)

Date of measurement: 04/17/2019

Measurement duration: 12 minutes 3 seconds

E-field Probe: SSE5 - SN 09/13 EP168; ConvF: 5.84; Calibrated: 06/01/2018

A. Experimental conditions

Area Scan	dx=8mm dy=8mm
Zoom Scan	dx=8mm dy=8mm dz=5mm
Phantom	Flat plane
Device Position	Front
Band	LTE Band 4
Channels	QPSK, 20MHz, 1RB, Low
Signal	Duty Cycle 1:1

B. SAR Measurement Results

Frequency (MHz)	1720.000000
Relative Permittivity (real part)	39.025421
Conductivity (S/m)	1.370123
Power Variation (%)	1.374628
Ambient Temperature	21.1
Liquid Temperature	21.2

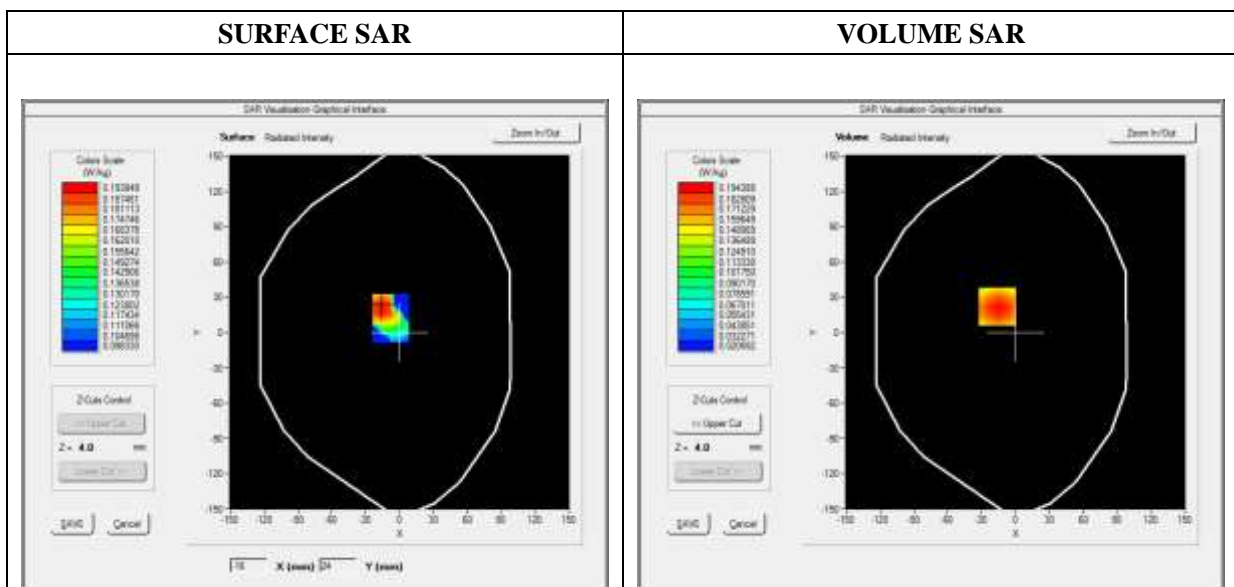



Maximum location: X=-16.00, Y=22.00

SAR Peak: 0.28 W/kg

SAR 10g (W/Kg)	0.115970
SAR 1g (W/Kg)	0.185625

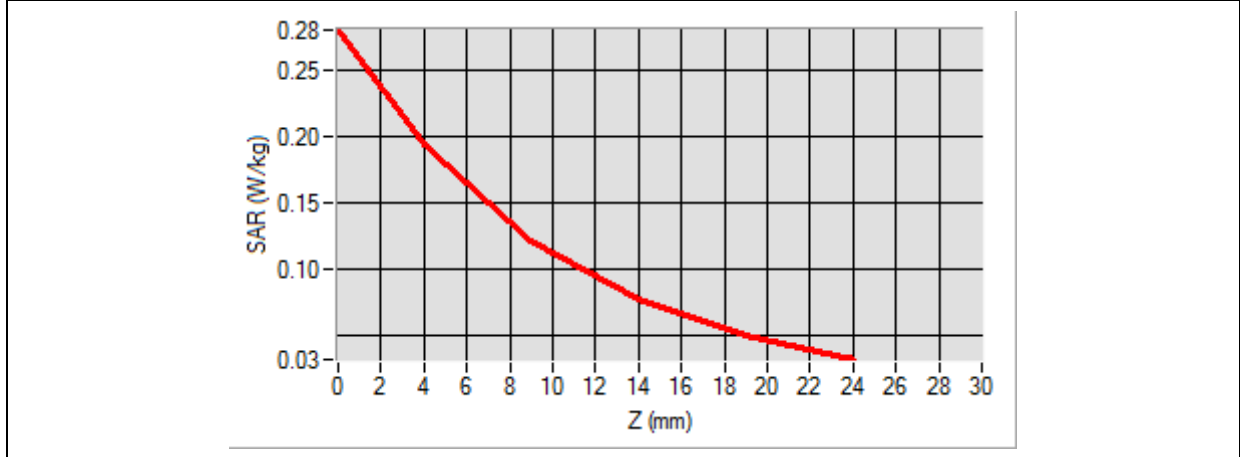
Z (mm)	0.00	4.00	9.00	14.00	19.00
SAR (W/Kg)	0.2806	0.1944	0.1214	0.0765	0.0493

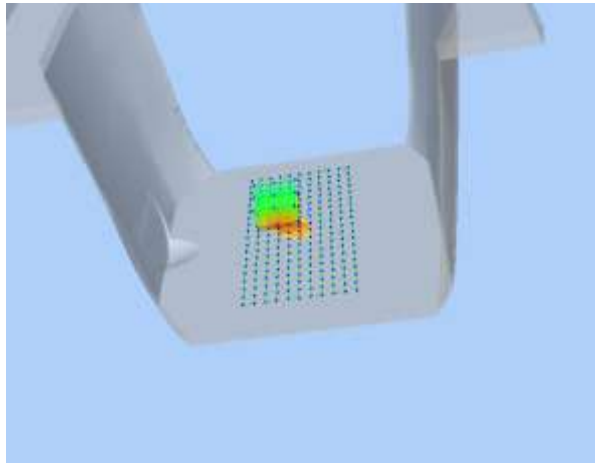

3D screen shot	Hot spot position
	

MEASUREMENT 11

Type: Phone measurement (Complete)

Date of measurement: 04/16/2019

Measurement duration: 12 minutes 3 seconds

E-field Probe: SSE5 - SN 09/13 EP168; ConvF: 6.93; Calibrated: 06/01/2018

A. Experimental conditions

Area Scan	dx=8mm dy=8mm
Zoom Scan	dx=8mm dy=8mm dz=5mm
Phantom	Flat plane
Device Position	Front
Band	LTE Band 5
Channels	QPSK, 10MHz, 1RB, Low
Signal	Duty Cycle 1:1

B. SAR Measurement Results

Frequency (MHz)	829.000000
Relative Permittivity (real part)	41.110245
Conductivity (S/m)	0.871245
Power Variation (%)	0.924535
Ambient Temperature	21.1
Liquid Temperature	21.2

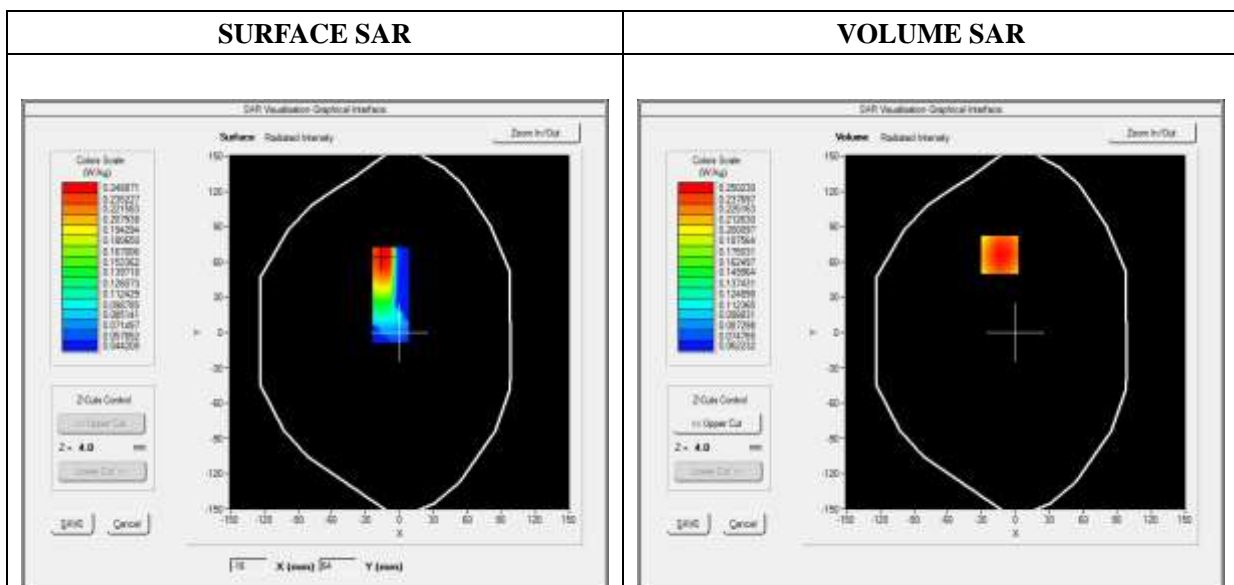

Maximum location: X=-14.00, Y=66.00

SAR Peak: 0.32 W/kg

SAR 10g (W/Kg)	0.175239
SAR 1g (W/Kg)	0.241522

Z (mm)	0.00	4.00	9.00	14.00	19.00
SAR (W/Kg)	0.3166	0.2502	0.1866	0.1405	0.1070

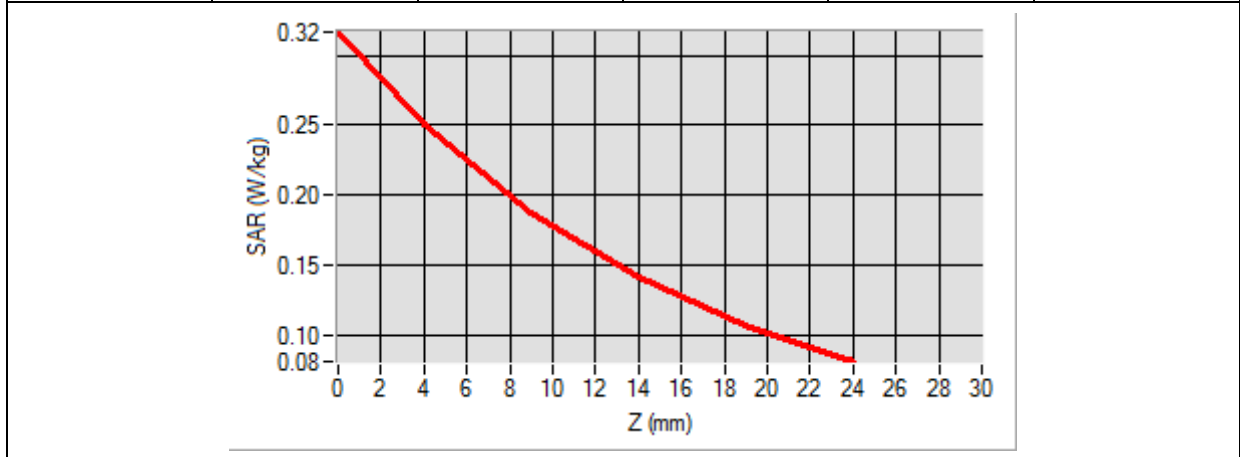

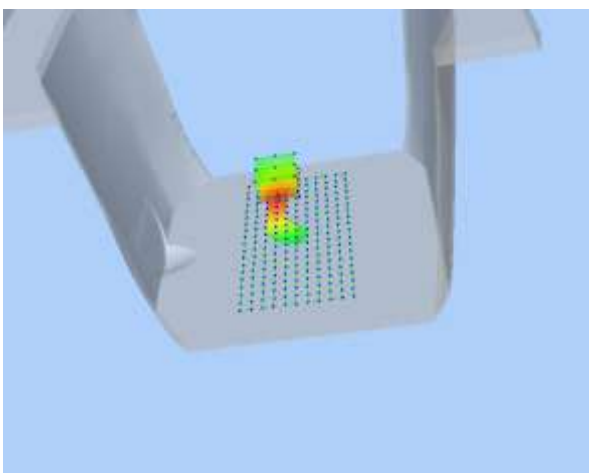
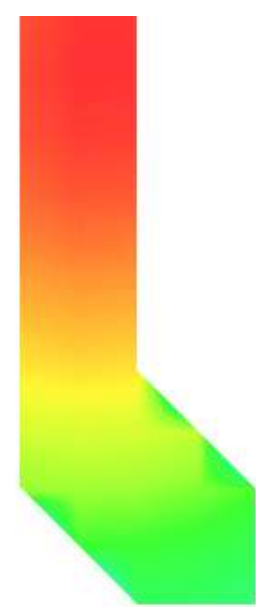
<p>3D screen shot</p>	<p>Hot spot position</p>
	

MEASUREMENT 13

Type: Phone measurement (Complete)

Date of measurement: 04/18/2019

Measurement duration: 12 minutes 3 seconds

E-field Probe: SSE5 - SN 09/13 EP168; ConvF: 5.37; Calibrated: 06/01/2018

A. Experimental conditions

Area Scan	dx=8mm dy=8mm
Zoom Scan	dx=8mm dy=8mm dz=5mm
Phantom	Flat plane
Device Position	Front
Band	LTE Band 7
Channels	QPSK, 20MHz, 1RB, Low
Signal	Duty Cycle 1:1

B. SAR Measurement Results

Frequency (MHz)	2510.000000
Relative Permittivity (real part)	38.631092
Conductivity (S/m)	1.930182
Power Variation (%)	0.924535
Ambient Temperature	21.1
Liquid Temperature	21.2

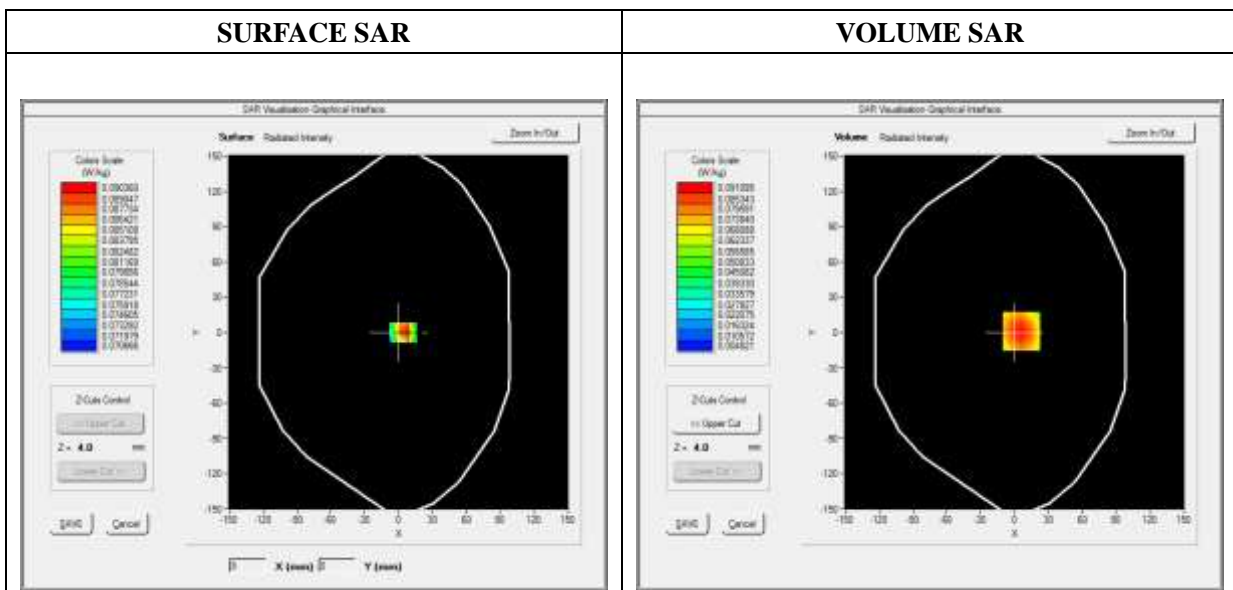



Maximum location: X=6.00, Y=1.00

SAR Peak: 0.14 W/kg

SAR 10g (W/Kg)	0.050235
SAR 1g (W/Kg)	0.086650

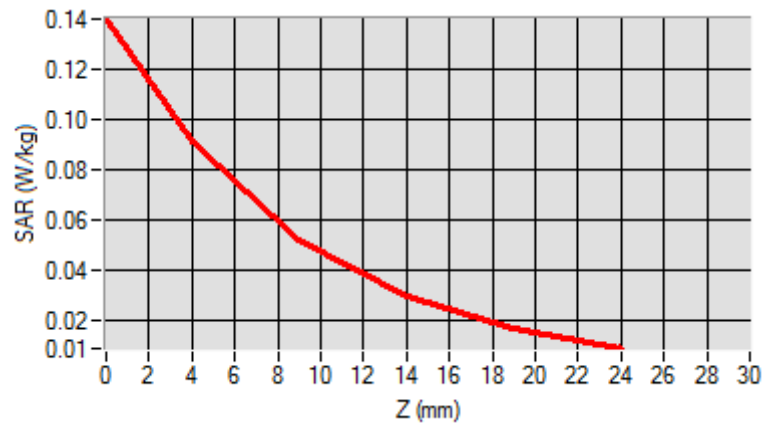
Z (mm)	0.00	4.00	9.00	14.00	19.00
SAR (W/Kg)	0.1398	0.0911	0.0517	0.0290	0.0163

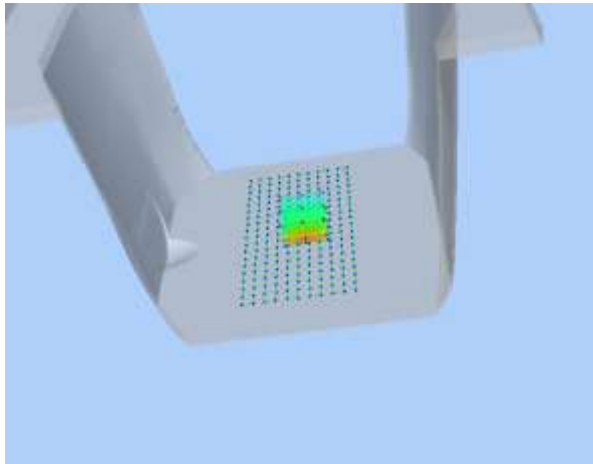

<p>3D screen shot</p>	<p>Hot spot position</p>
	

MEASUREMENT 15

Type: Phone measurement (Complete)

Date of measurement: 04/16/2019

Measurement duration: 12 minutes 3 seconds

E-field Probe: SSE5 - SN 09/13 EP168; ConvF: 6.99; Calibrated: 06/01/2018

A. Experimental conditions

Area Scan	dx=8mm dy=8mm
Zoom Scan	dx=8mm dy=8mm dz=5mm
Phantom	Flat plane
Device Position	Front
Band	LTE Band 12
Channels	QPSK, 10MHz, 1RB, Low
Signal	Duty Cycle 1:1

B. SAR Measurement Results

Frequency (MHz)	704.000000
Relative Permittivity (real part)	41.320574
Conductivity (S/m)	0.862373
Power Variation (%)	0.924535
Ambient Temperature	21.1
Liquid Temperature	21.2

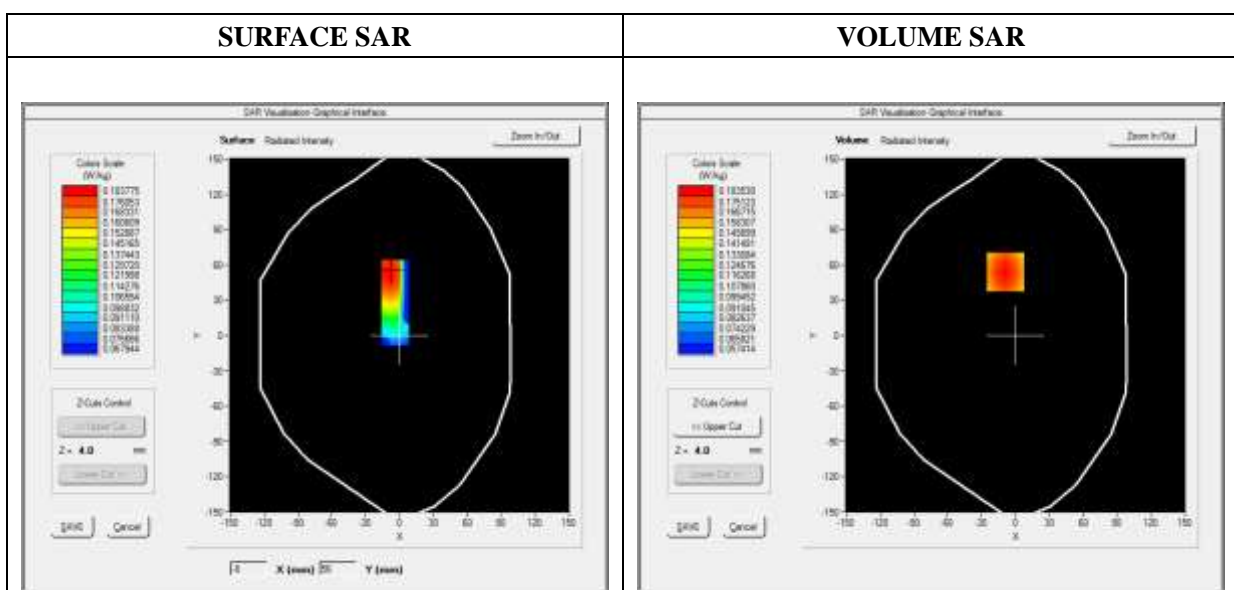



Maximum location: X=-9.00, Y=54.00

SAR Peak: 0.22 W/kg

SAR 10g (W/Kg)	0.134436
SAR 1g (W/Kg)	0.177545

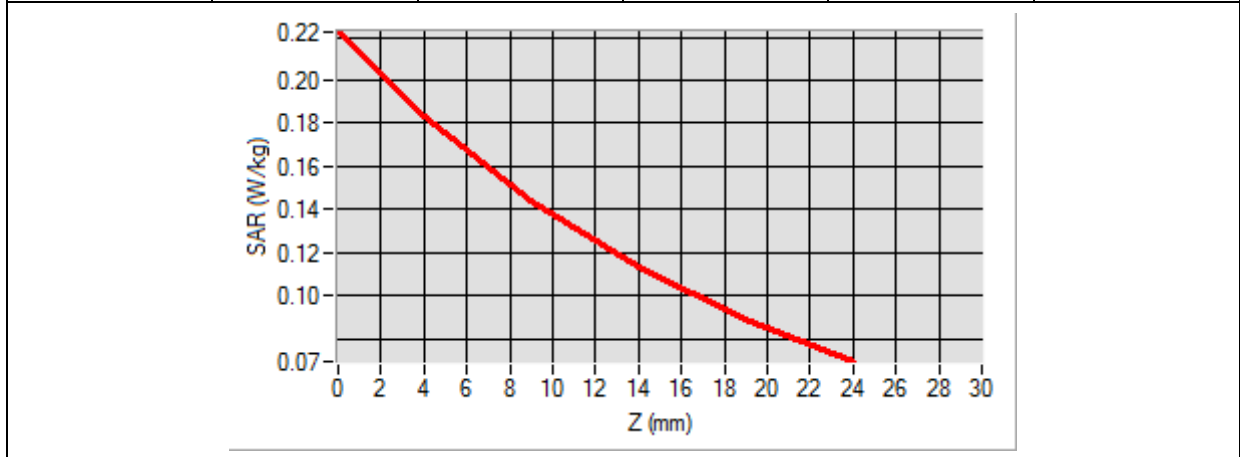
Z (mm)	0.00	4.00	9.00	14.00	19.00
SAR (W/Kg)	0.2225	0.1835	0.1440	0.1133	0.0892

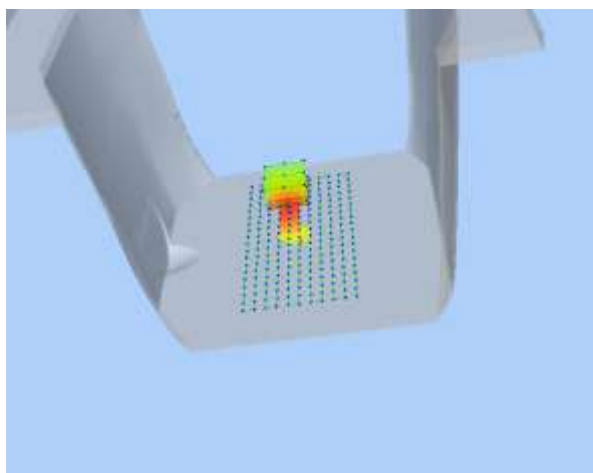

<p>3D screen shot</p>	<p>Hot spot position</p>
	

MEASUREMENT 17

Type: Phone measurement (Complete)

Date of measurement: 04/16/2019

Measurement duration: 12 minutes 3 seconds

E-field Probe: SSE5 - SN 09/13 EP168; ConvF: 6.99; Calibrated: 06/01/2018

A. Experimental conditions

Area Scan	dx=8mm dy=8mm
Zoom Scan	dx=8mm dy=8mm dz=5mm
Phantom	Flat plane
Device Position	Front
Band	LTE Band 13
Channels	QPSK, 10MHz, 1RB, Middle
Signal	Duty Cycle 1:1

B. SAR Measurement Results

Frequency (MHz)	782.000000
Relative Permittivity (real part)	41.320574
Conductivity (S/m)	0.862373
Power Variation (%)	0.924521
Ambient Temperature	21.1
Liquid Temperature	21.2

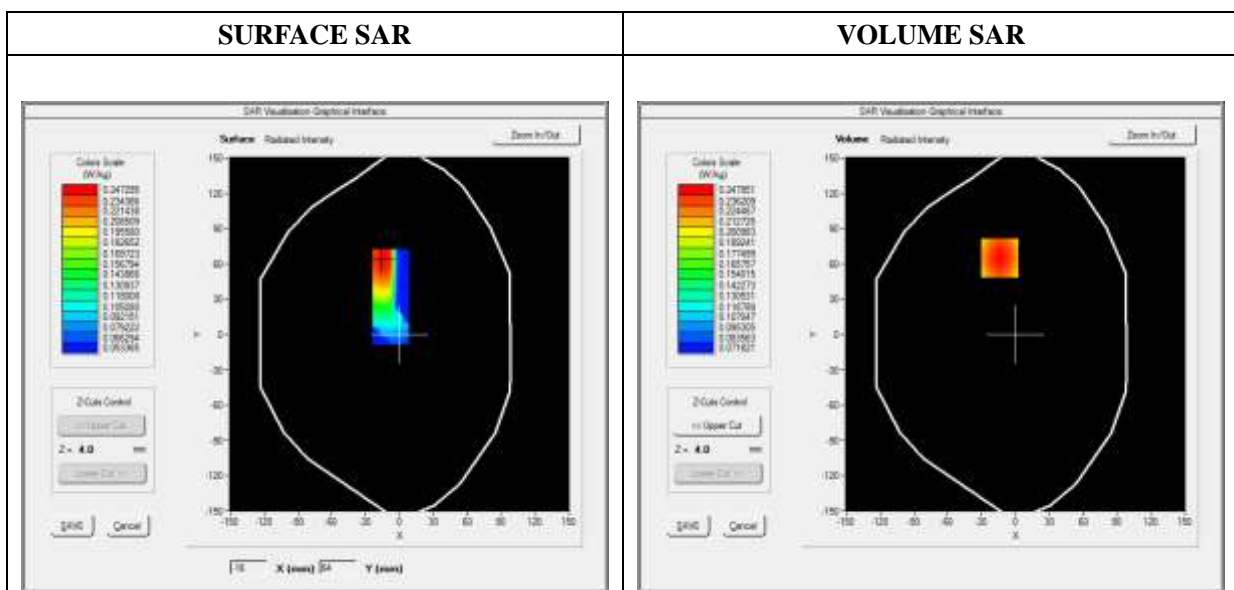

Maximum location: X=-14.00, Y=65.00

SAR Peak: 0.31 W/kg

SAR 10g (W/Kg)	0.177106
SAR 1g (W/Kg)	0.239486

Z (mm)	0.00	4.00	9.00	14.00	19.00
SAR (W/Kg)	0.3074	0.2480	0.1893	0.1453	0.1122

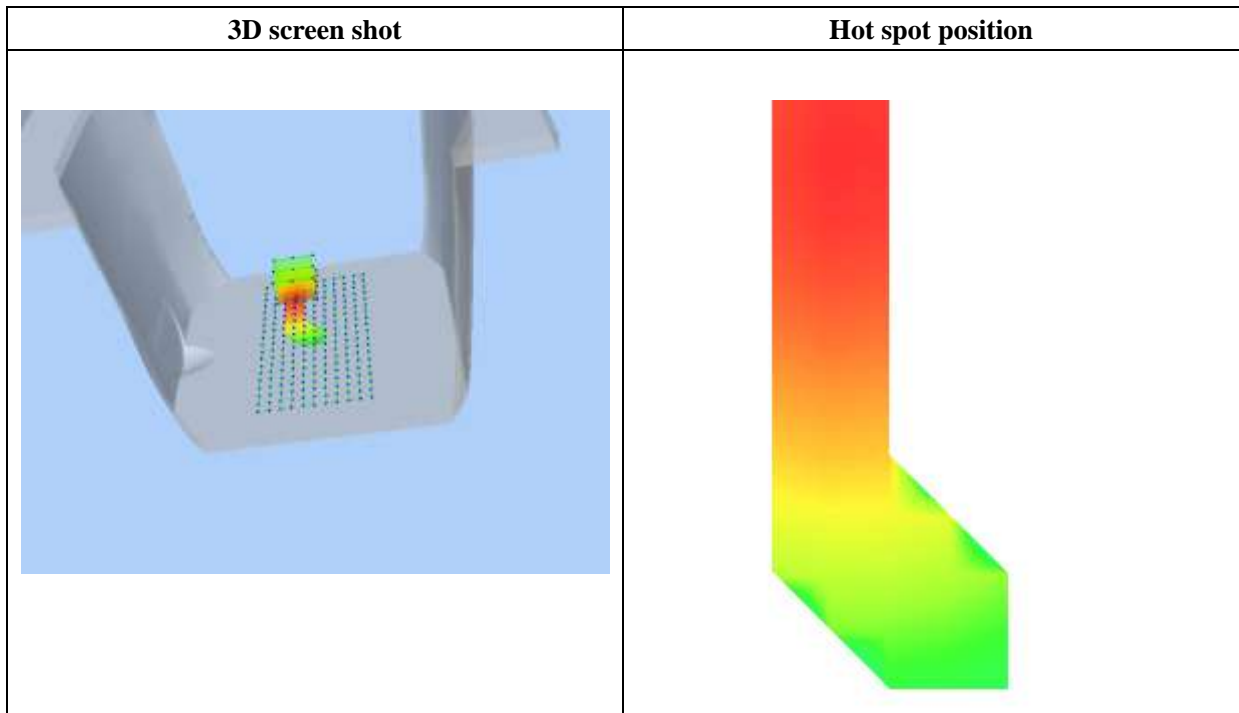
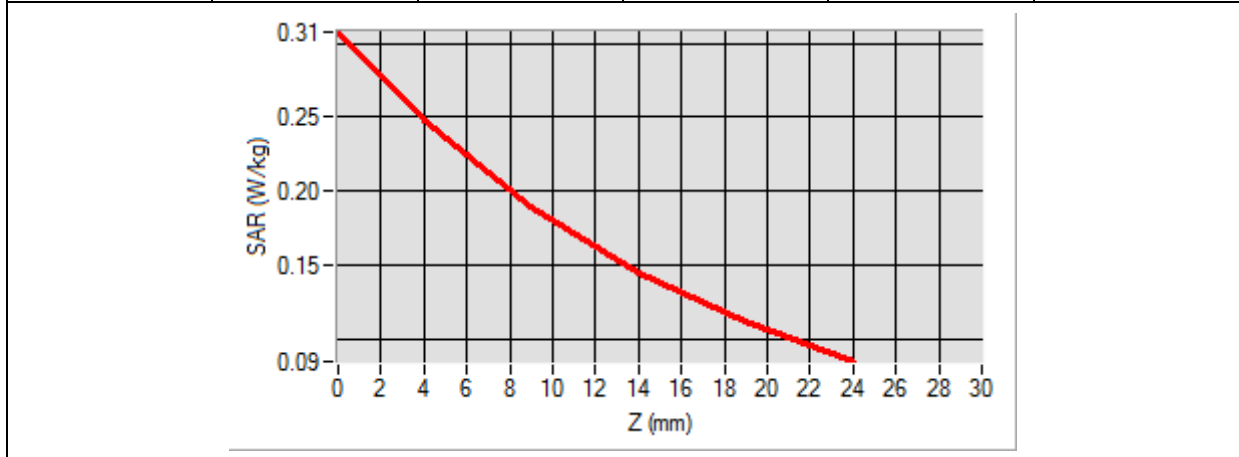

MEASUREMENT 19

Type: Phone measurement (Complete)

Date of measurement: 04/16/2019

Measurement duration: 12 minutes 3 seconds

E-field Probe: SSE5 - SN 09/13 EP168; ConvF: 6.99; Calibrated: 06/01/2018

A. Experimental conditions

Area Scan	dx=8mm dy=8mm
Zoom Scan	dx=8mm dy=8mm dz=5mm
Phantom	Flat plane
Device Position	Front
Band	LTE Band 17
Channels	QPSK, 10MHz, 1RB, High
Signal	Duty Cycle 1:1

B. SAR Measurement Results

Frequency (MHz)	711.000000
Relative Permittivity (real part)	41.320574
Conductivity (S/m)	0.862373
Power Variation (%)	0.924452
Ambient Temperature	21.1
Liquid Temperature	21.2

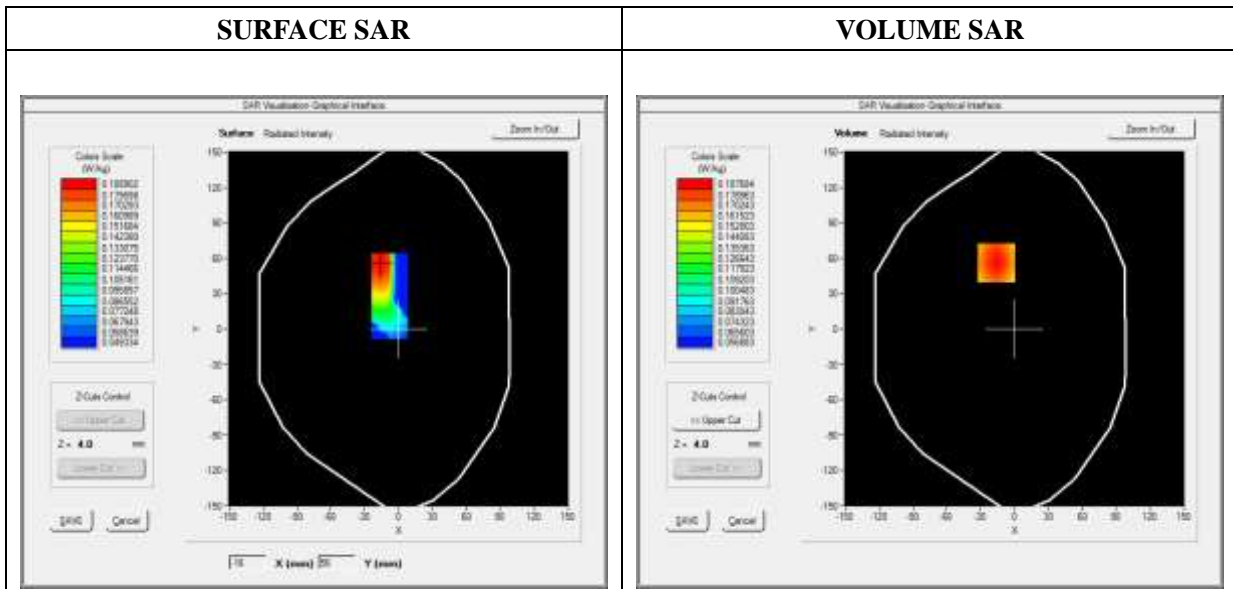

Maximum location: X=-16.00, Y=56.00

SAR Peak: 0.23 W/kg

SAR 10g (W/Kg)	0.139046
SAR 1g (W/Kg)	0.184819

Z (mm)	0.00	4.00	9.00	14.00	19.00
SAR (W/Kg)	0.2287	0.1877	0.1465	0.1150	0.0906

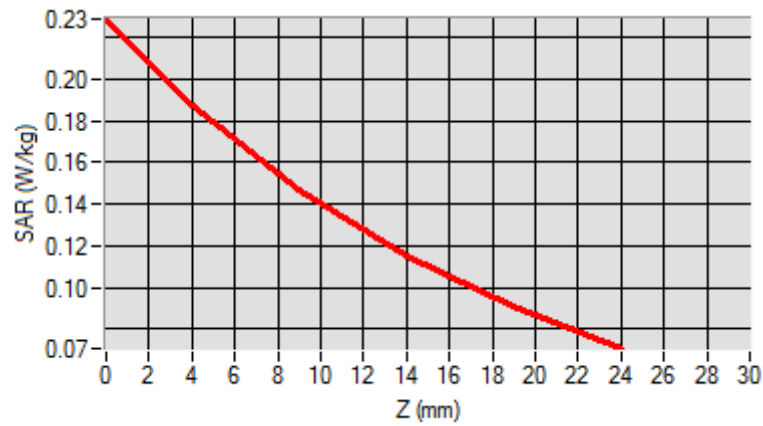

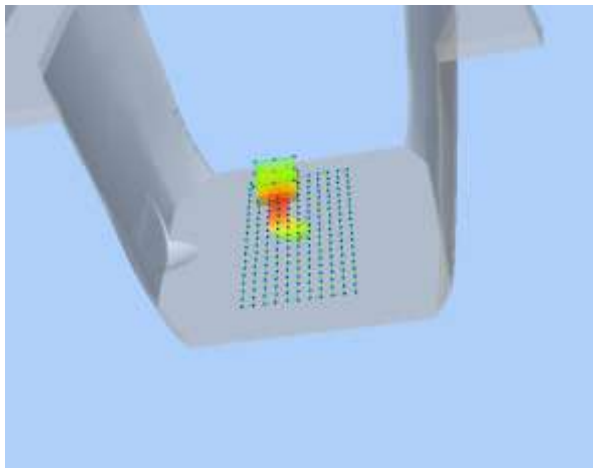
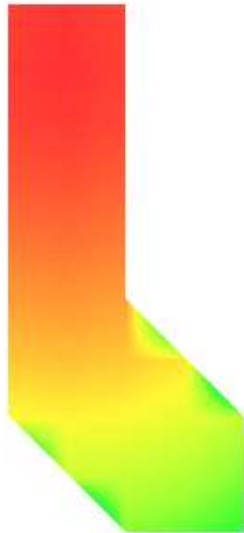
3D screen shot	Hot spot position
	

MEASUREMENT 21

Type: Phone measurement (Complete)

Date of measurement: 04/18/2019

Measurement duration: 12 minutes 3 seconds

E-field Probe: SSE5 - SN 09/13 EP168; ConvF: 5.64; Calibrated: 06/01/2018

A. Experimental conditions

Area Scan	dx=8mm dy=8mm
Zoom Scan	dx=8mm dy=8mm dz=5mm
Phantom	Flat plane
Device Position	Front
Band	WiFi_802.11b
Channels	Middle
Signal	Duty Cycle 1:1

B. SAR Measurement Results

Frequency (MHz)	2437.000000
Relative Permittivity (real part)	38.153660
Conductivity (S/m)	1.740236
Power Variation (%)	3.234772
Ambient Temperature	21.1
Liquid Temperature	21.2

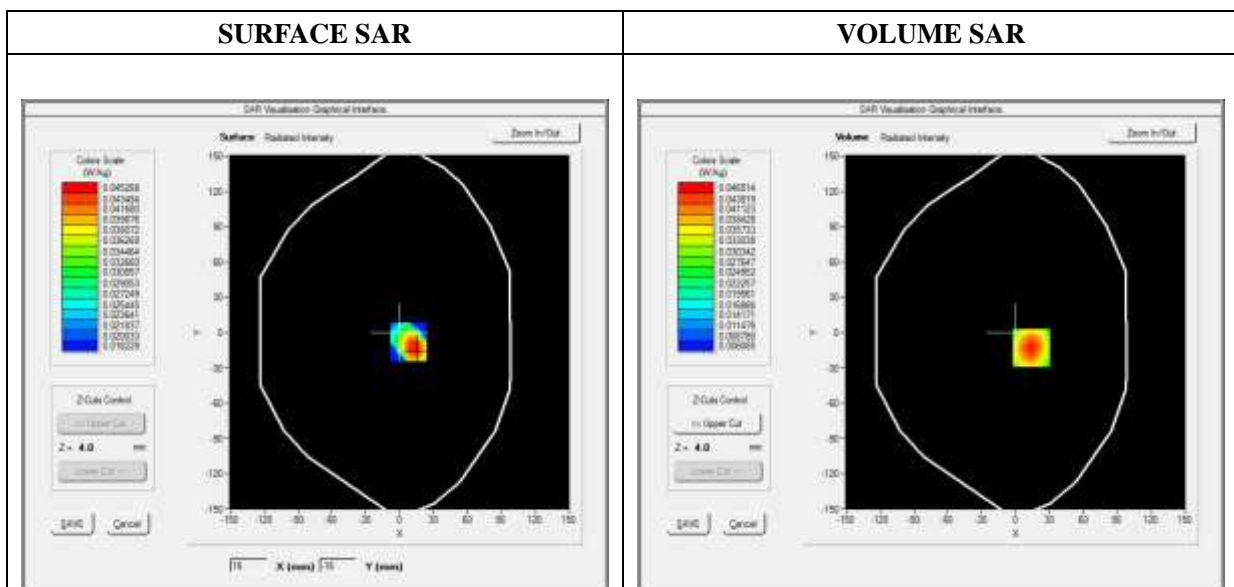

Maximum location: X=14.00, Y=-13.00

SAR Peak: 0.07 W/kg

SAR 10g (W/Kg)	0.026416
SAR 1g (W/Kg)	0.044077

Z (mm)	0.00	4.00	9.00	14.00	19.00
SAR (W/Kg)	0.0708	0.0465	0.0274	0.0170	0.0115

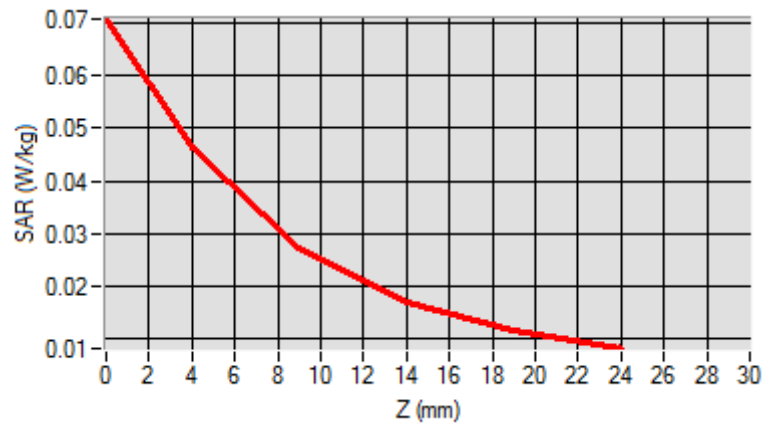

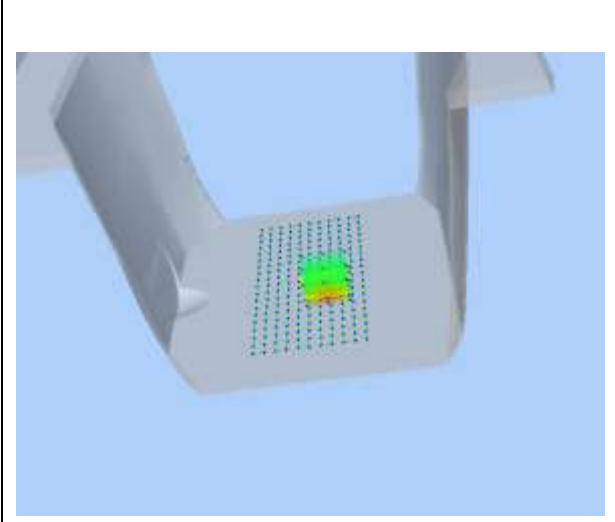
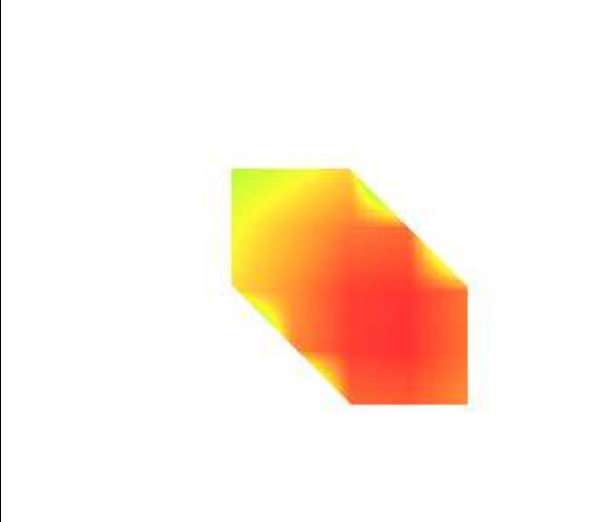
<p>3D screen shot</p>	<p>Hot spot position</p>
	

MEASUREMENT 22

Type: Phone measurement (Complete)

Date of measurement: 04/16/2019

Measurement duration: 12 minutes 3 seconds

E-field Probe: SSE5 - SN 09/13 EP168; ConvF: 7.13; Calibrated: 06/01/2018

A. Experimental conditions

Area Scan	dx=8mm dy=8mm
Zoom Scan	dx=8mm dy=8mm dz=5mm
Phantom	Flat plane
Device Position	Back
Band	GPRS850_4TX
Channels	High
Signal	Duty Cycle: 1:2

B. SAR Measurement Results

Frequency (MHz)	836.600000
Relative Permittivity (real part)	54.851214
Conductivity (S/m)	0.951454
Power Variation (%)	0.901472
Ambient Temperature	21.1
Liquid Temperature	21.3

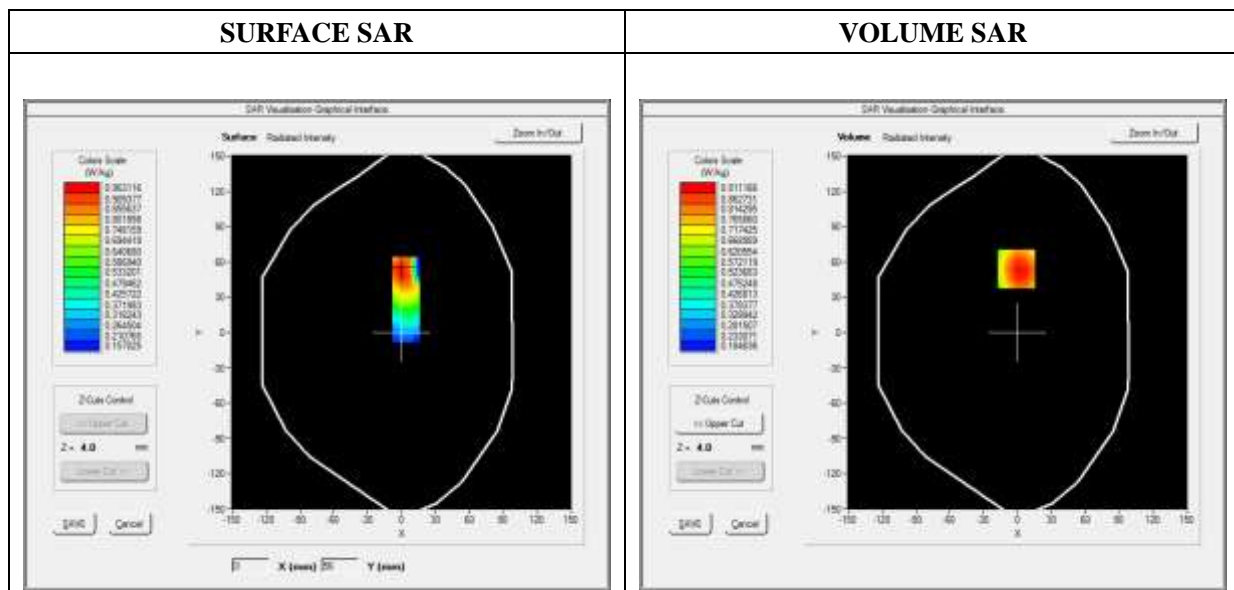



Maximum location: X=-1.00, Y=54.00

SAR Peak: 1.17 W/kg

SAR 10g (W/Kg)	0.624499
SAR 1g (W/Kg)	0.882299

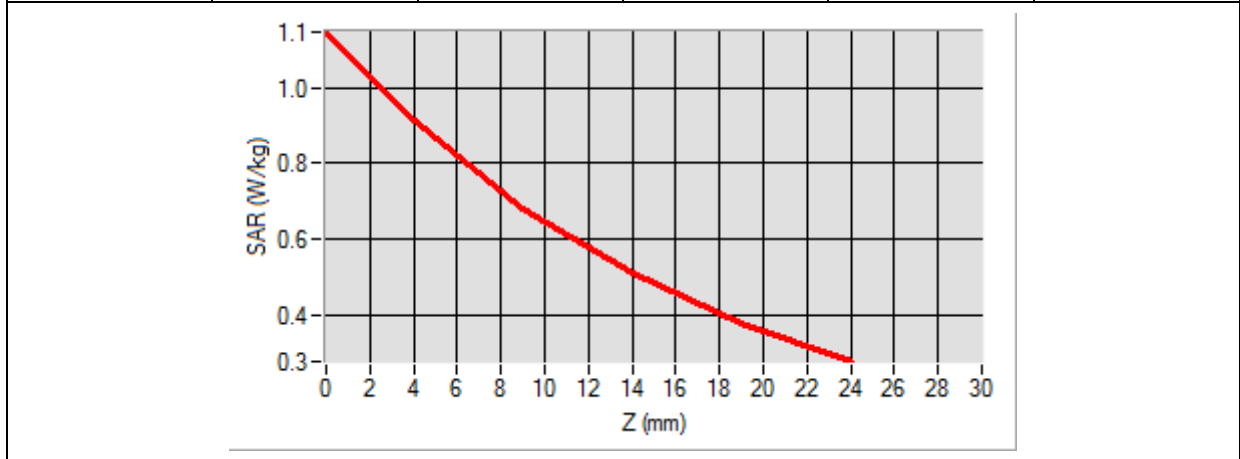
Z (mm)	0.00	4.00	9.00	14.00	19.00
SAR (W/Kg)	1.1463	0.9112	0.6804	0.5078	0.3784

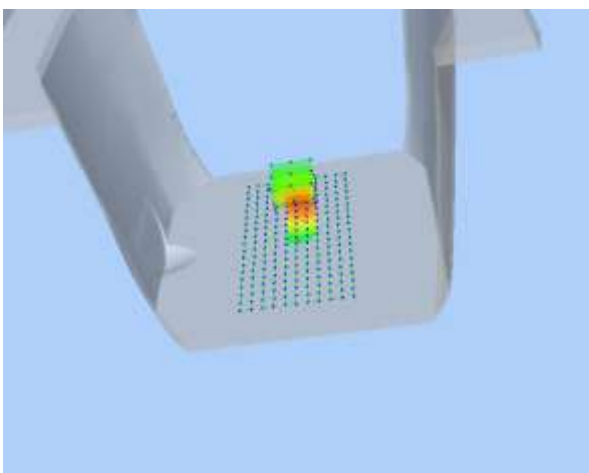

<p>3D screen shot</p>	<p>Hot spot position</p>
	

MEASUREMENT 25

Type: Phone measurement (Complete)

Date of measurement: 04/17/2019

Measurement duration: 12 minutes 3 seconds

E-field Probe: SSE5 - SN 09/13 EP168; ConvF: 6.55; Calibrated: 06/01/2018

A. Experimental conditions

Area Scan	dx=8mm dy=8mm
Zoom Scan	dx=8mm dy=8mm dz=5mm
Phantom	Flat plane
Device Position	Back
Band	GPRS1900_4TX
Channels	High
Signal	Duty Cycle: 1:2

B. SAR Measurement Results

Frequency (MHz)	1909.800000
Relative Permittivity (real part)	52.420415
Conductivity (S/m)	1.501966
Power Variation (%)	2.483762
Ambient Temperature	21.1
Liquid Temperature	21.3

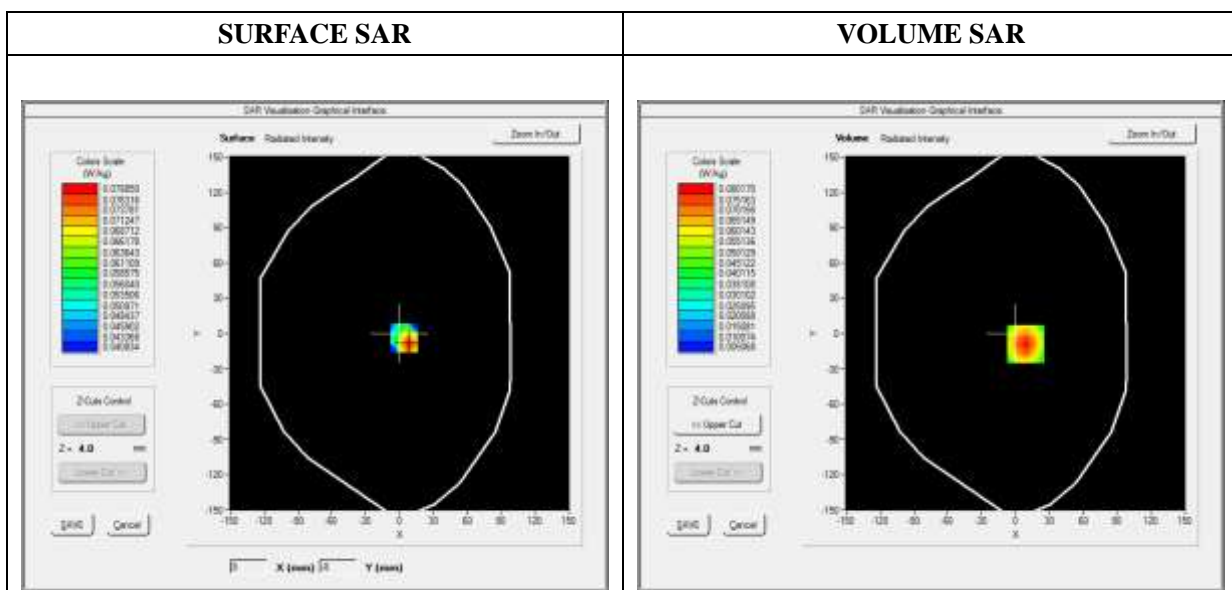



Maximum location: X=9.00, Y=-9.00

SAR Peak: 0.12 W/kg

SAR 10g (W/Kg)	0.042381
SAR 1g (W/Kg)	0.075644

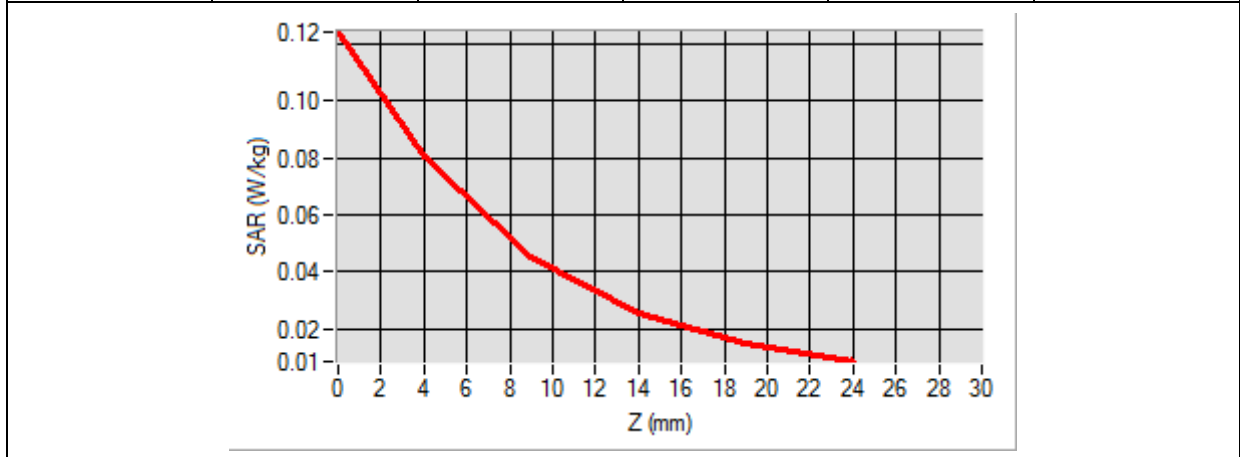
Z (mm)	0.00	4.00	9.00	14.00	19.00
SAR (W/Kg)	0.1241	0.0802	0.0452	0.0255	0.0149

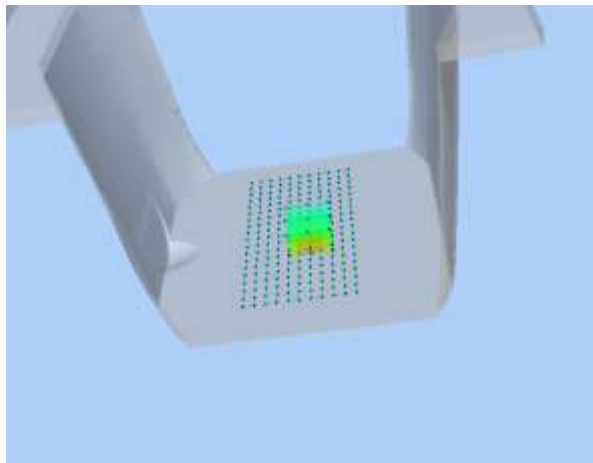

3D screen shot	Hot spot position
	

MEASUREMENT 26

Type: Phone measurement (Complete)

Date of measurement: 04/17/2019

Measurement duration: 12 minutes 3 seconds

E-field Probe: SSE5 - SN 09/13 EP168; ConvF: 6.55; Calibrated: 06/01/2018

A. Experimental conditions

Area Scan	dx=8mm dy=8mm
Zoom Scan	dx=8mm dy=8mm dz=5mm
Phantom	Flat Plane
Device Position	Back
Band	WCDMA1900_RMC
Channels	Low
Signal	Duty Cycle 1:1

B. SAR Measurement Results

Frequency (MHz)	1852.400000
Relative Permittivity (real part)	52.420415
Conductivity (S/m)	1.501966
Power Variation (%)	1.789272
Ambient Temperature	21.1
Liquid Temperature	21.3

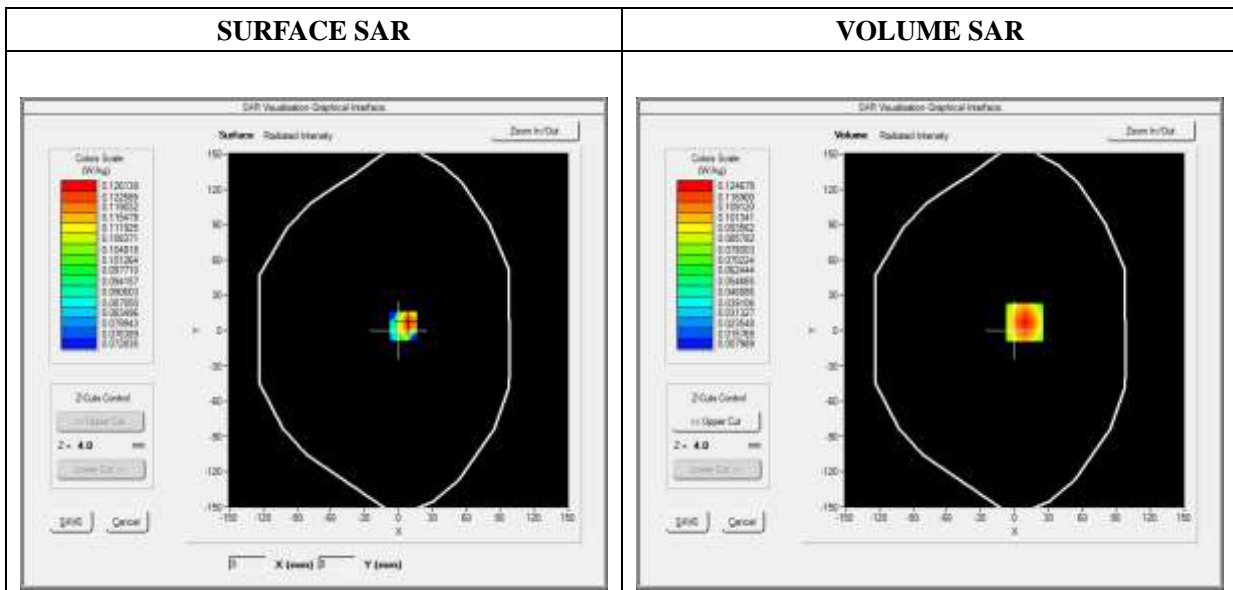



Maximum location: X=9.00, Y=7.00

SAR Peak: 0.19 W/kg

SAR 10g (W/Kg)	0.066965
SAR 1g (W/Kg)	0.118030

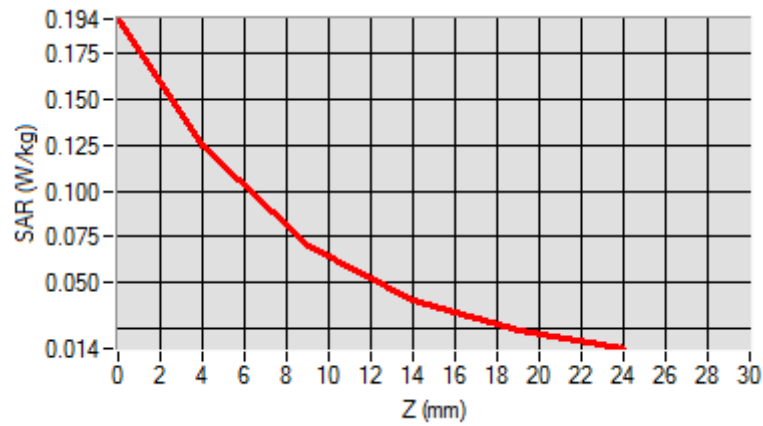
Z (mm)	0.00	4.00	9.00	14.00	19.00
SAR (W/Kg)	0.1942	0.1247	0.0699	0.0394	0.0233

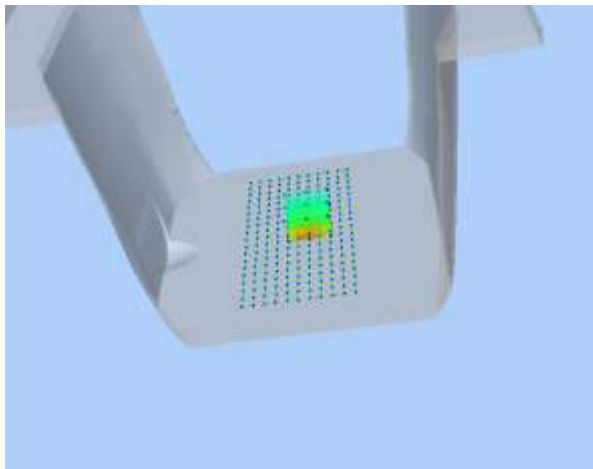

3D screen shot	Hot spot position
	

MEASUREMENT 27

Type: Phone measurement (Complete)

Date of measurement: 04/16/2019

Measurement duration: 12 minutes 3 seconds

E-field Probe: SSE5 - SN 09/13 EP168; ConvF: 7.13; Calibrated: 06/01/2018

A. Experimental conditions

Area Scan	dx=8mm dy=8mm
Zoom Scan	dx=8mm dy=8mm dz=5mm
Phantom	Flat Plane
Device Position	Back
Band	WCDMA850_RMC
Channels	Low
Signal	Duty Cycle 1:1

B. SAR Measurement Results

Frequency (MHz)	826.400000
Relative Permittivity (real part)	54.851214
Conductivity (S/m)	0.951454
Power Variation (%)	2.341234
Ambient Temperature	21.1
Liquid Temperature	21.3

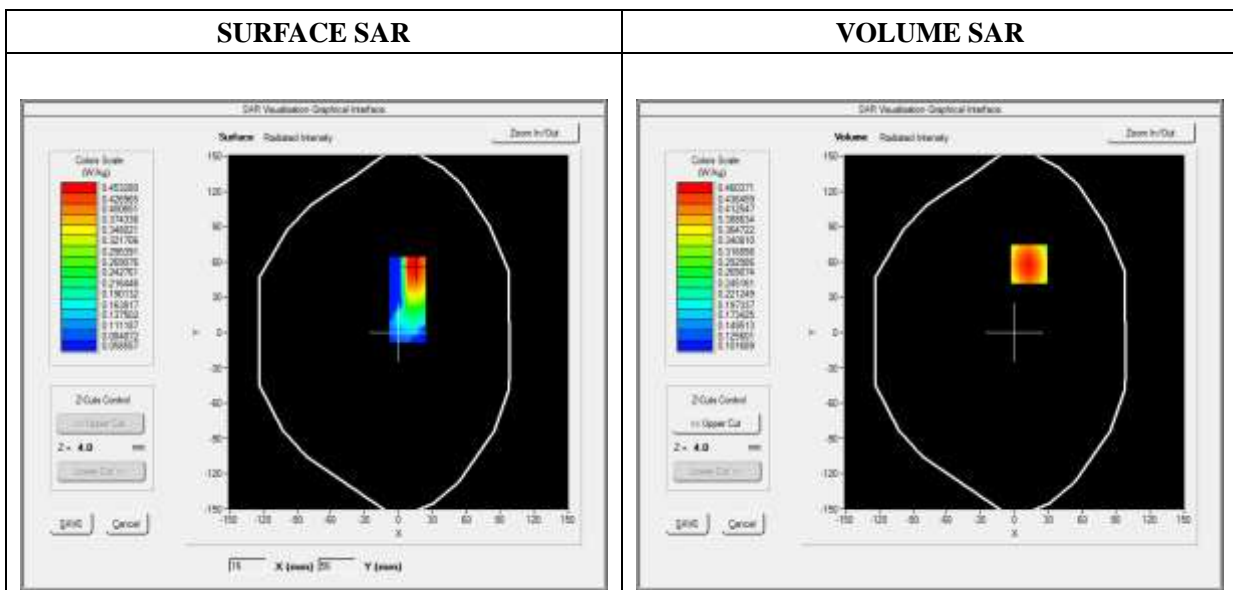



Maximum location: X=13.00, Y=58.00

SAR Peak: 0.59 W/kg

SAR 10g (W/Kg)	0.315693
SAR 1g (W/Kg)	0.444895

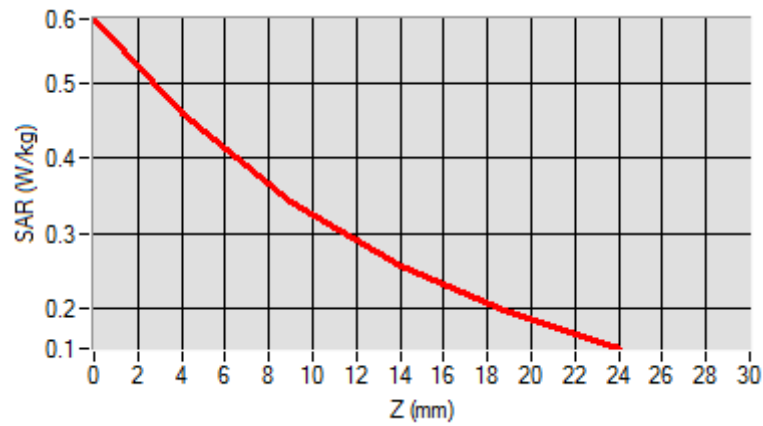
Z (mm)	0.00	4.00	9.00	14.00	19.00
SAR (W/Kg)	0.5851	0.4604	0.3414	0.2559	0.1943

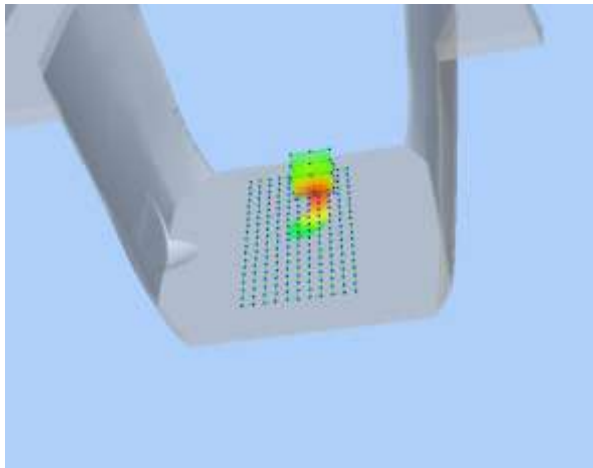

3D screen shot	Hot spot position
	

MEASUREMENT 28

Type: Phone measurement (Complete)

Date of measurement: 04/17/2019

Measurement duration: 12 minutes 3 seconds

E-field Probe: SSE5 - SN 09/13 EP168; ConvF: 6.55; Calibrated: 06/01/2018

A. Experimental conditions

Area Scan	dx=8mm dy=8mm
Zoom Scan	dx=8mm dy=8mm dz=5mm
Phantom	Flat Plane
Device Position	Back
Band	LTE Band 2
Channels	QPSK, 20MHz, 1RB,Low
Signal	Duty Cycle 1:1

B. SAR Measurement Results

Frequency (MHz)	1860.000000
Relative Permittivity (real part)	52.420415
Conductivity (S/m)	1.501966
Power Variation (%)	1.523573
Ambient Temperature	21.1
Liquid Temperature	21.3

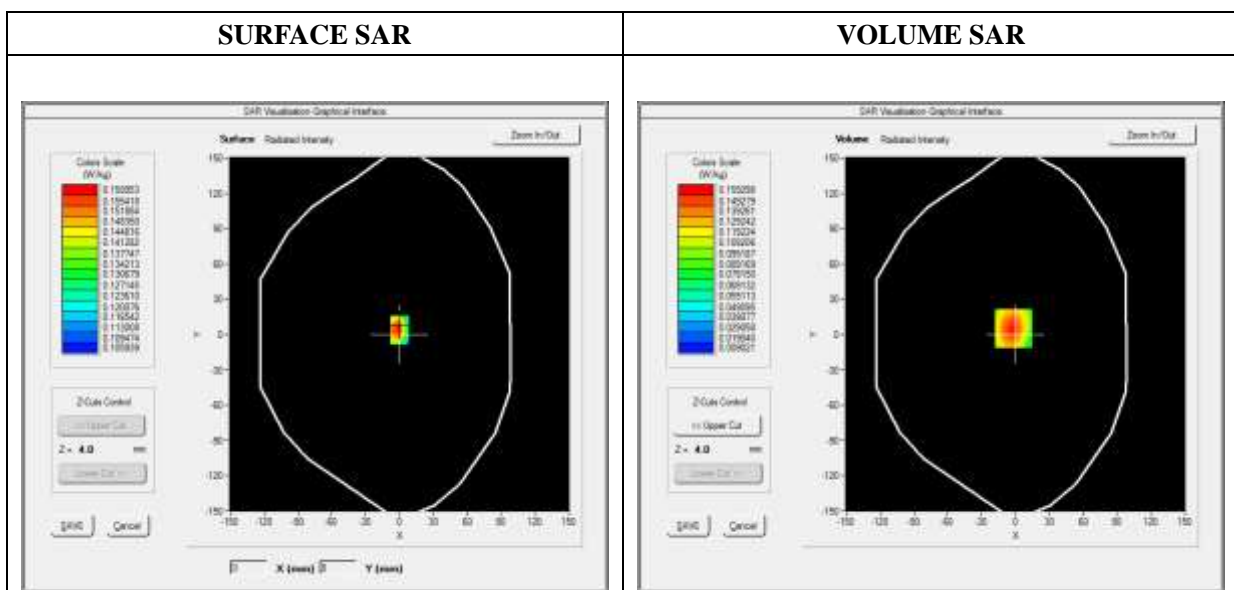



Maximum location: X=-2.00, Y=5.00

SAR Peak: 0.25 W/kg

SAR 10g (W/Kg)	0.085396
SAR 1g (W/Kg)	0.150846

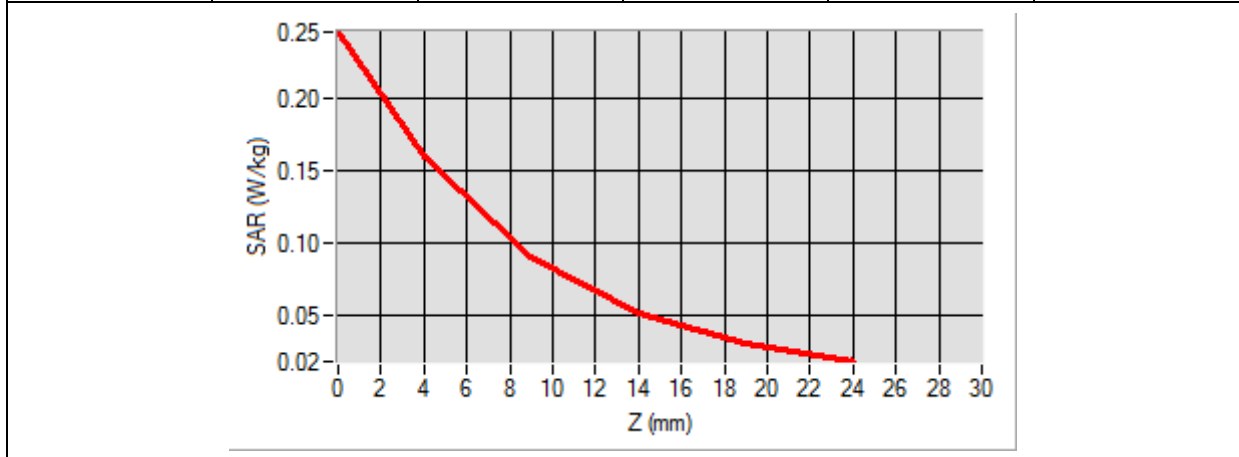
Z (mm)	0.00	4.00	9.00	14.00	19.00
SAR (W/Kg)	0.2468	0.1593	0.0899	0.0509	0.0299

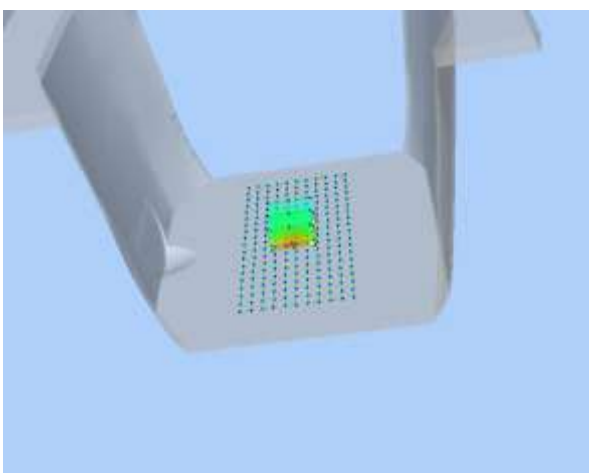

<p>3D screen shot</p>	<p>Hot spot position</p>
	

MEASUREMENT 30

Type: Phone measurement (Complete)

Date of measurement: 04/17/2019

Measurement duration: 12 minutes 3 seconds

E-field Probe: SSE5 - SN 09/13 EP168; ConvF: 6.06; Calibrated: 06/01/2018

A. Experimental conditions

Area Scan	dx=8mm dy=8mm
Zoom Scan	dx=8mm dy=8mm dz=5mm
Phantom	Flat Plane
Device Position	Back
Band	LTE Band 4
Channels	QPSK, 20MHz, 1RB, Low
Signal	Duty Cycle 1:1

B. SAR Measurement Results

Frequency (MHz)	1720.000000
Relative Permittivity (real part)	51.220432
Conductivity (S/m)	1.460124
Power Variation (%)	0.858383
Ambient Temperature	21.1
Liquid Temperature	21.2

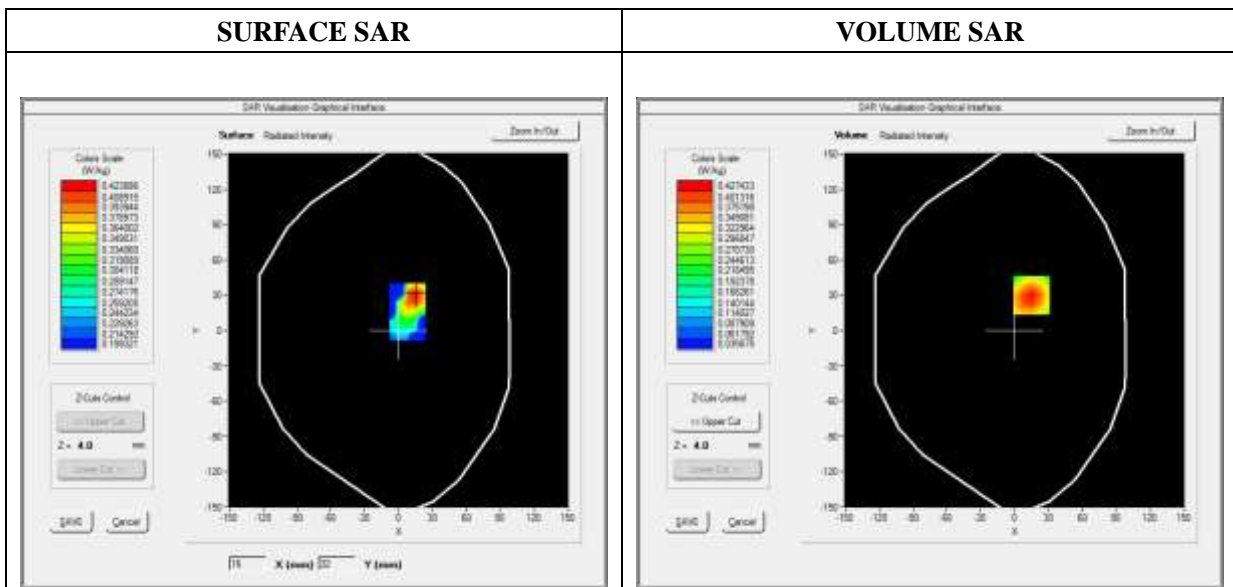

Maximum location: X=15.00, Y=30.00

SAR Peak: 0.60 W/kg

SAR 10g (W/Kg)	0.250161
SAR 1g (W/Kg)	0.406306

Z (mm)	0.00	4.00	9.00	14.00	19.00
SAR (W/Kg)	0.5971	0.4274	0.2776	0.1796	0.1165

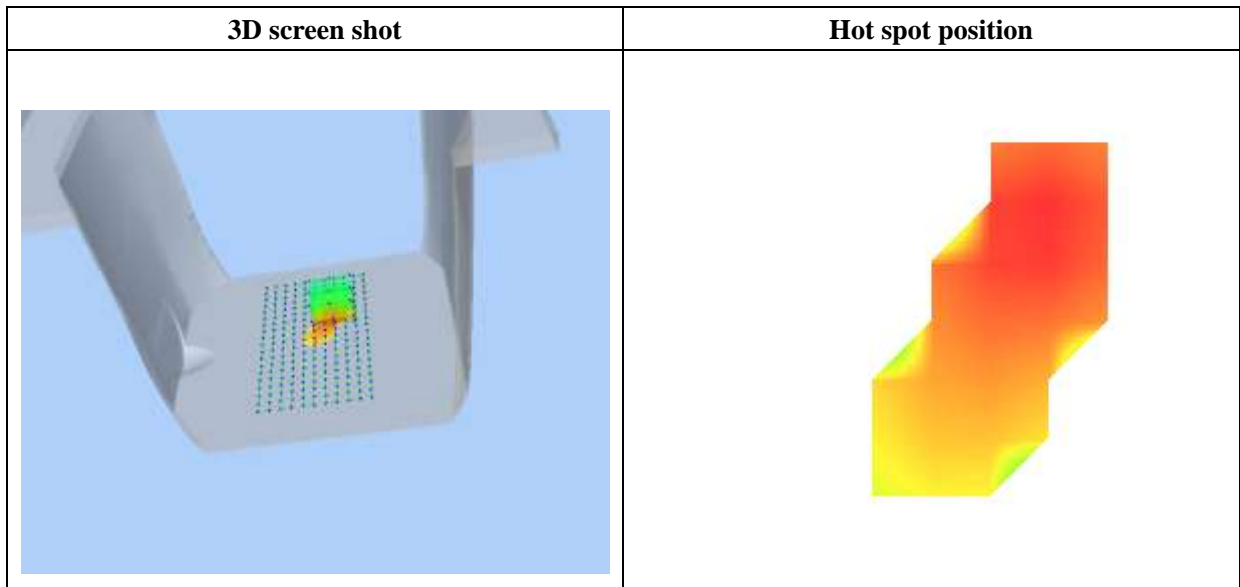
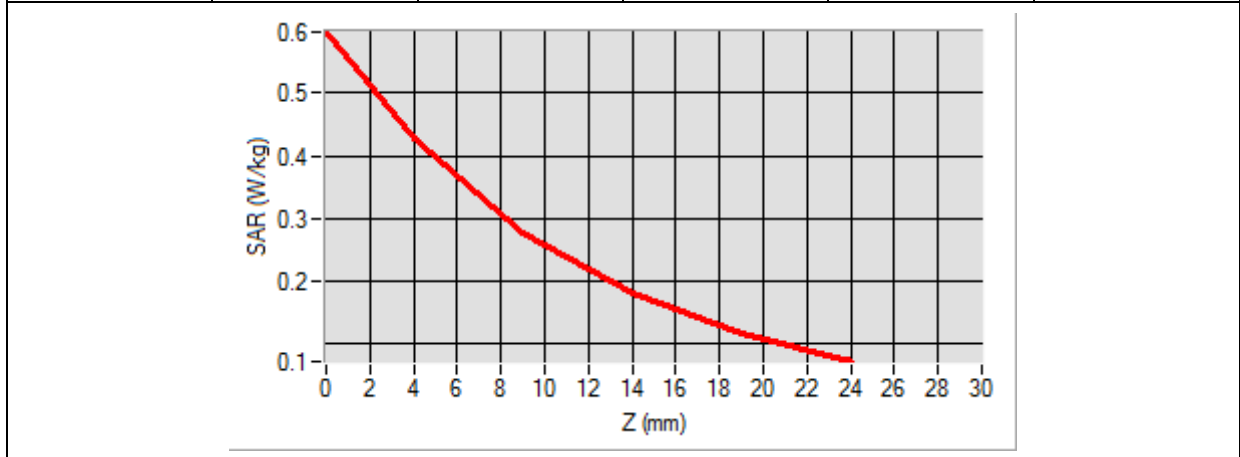

MEASUREMENT 32

Type: Phone measurement (Complete)

Date of measurement: 04/16/2019

Measurement duration: 12 minutes 3 seconds

E-field Probe: SSE5 - SN 09/13 EP168; ConvF: 7.13; Calibrated: 06/01/2018

A. Experimental conditions

Area Scan	dx=8mm dy=8mm
Zoom Scan	dx=8mm dy=8mm dz=5mm
Phantom	Flat Plane
Device Position	Back
Band	LTE Band 5
Channels	QPSK, 10MHz, 1RB, Low
Signal	Duty Cycle 1:1

B. SAR Measurement Results

Frequency (MHz)	829.000000
Relative Permittivity (real part)	54.851214
Conductivity (S/m)	0.951454
Power Variation (%)	1.037332
Ambient Temperature	21.1
Liquid Temperature	21.2

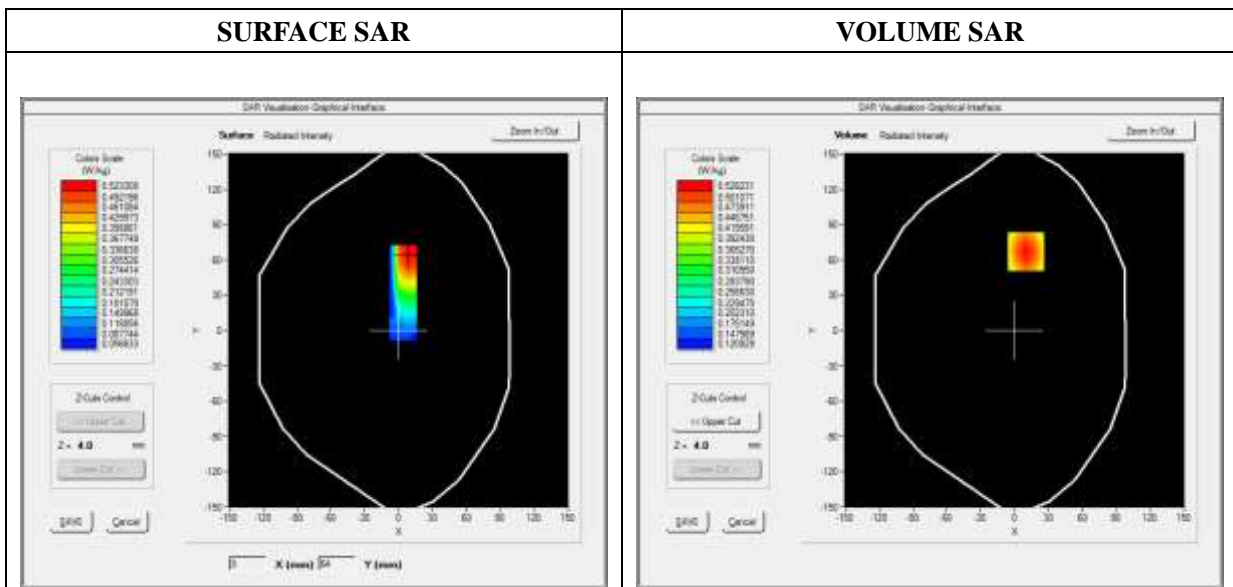

Maximum location: X=10.00, Y=67.00

SAR Peak: 0.67 W/kg

SAR 10g (W/Kg)	0.362426
SAR 1g (W/Kg)	0.509227

Z (mm)	0.00	4.00	9.00	14.00	19.00
SAR (W/Kg)	0.6685	0.5282	0.3936	0.2959	0.2249

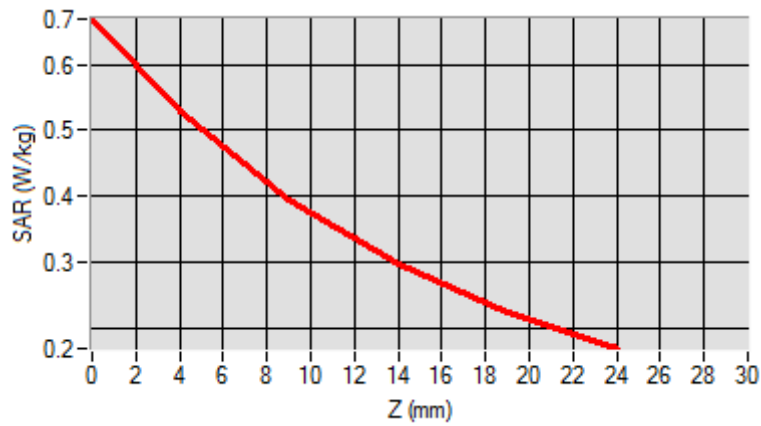

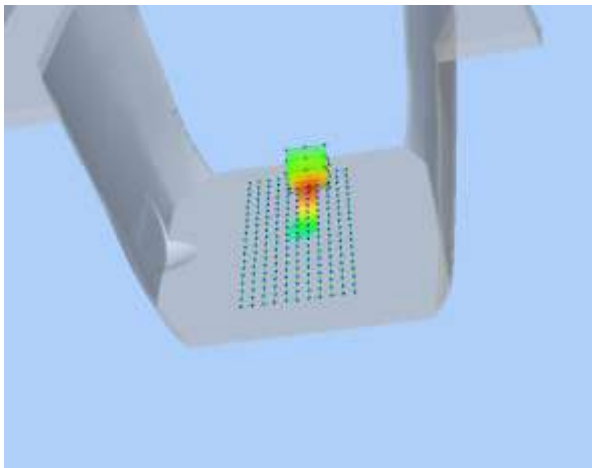
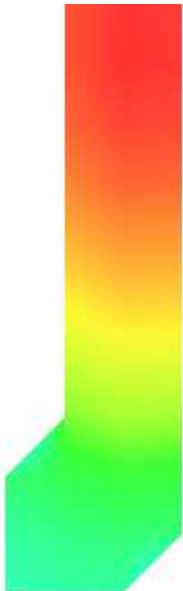
3D screen shot	Hot spot position
	

MEASUREMENT 34

Type: Phone measurement (Complete)

Date of measurement: 04/18/2019

Measurement duration: 12 minutes 3 seconds

E-field Probe: SSE5 - SN 09/13 EP168; ConvF: 5.58; Calibrated: 06/01/2018

A. Experimental conditions

Area Scan	dx=8mm dy=8mm
Zoom Scan	dx=8mm dy=8mm dz=5mm
Phantom	Flat Plane
Device Position	Back
Band	LTE Band 7
Channels	QPSK, 20MHz, 1RB, Low
Signal	Duty Cycle 1:1

B. SAR Measurement Results

Frequency (MHz)	2510.000000
Relative Permittivity (real part)	52.241202
Conductivity (S/m)	2.120943
Power Variation (%)	3.124788
Ambient Temperature	21.1
Liquid Temperature	21.2

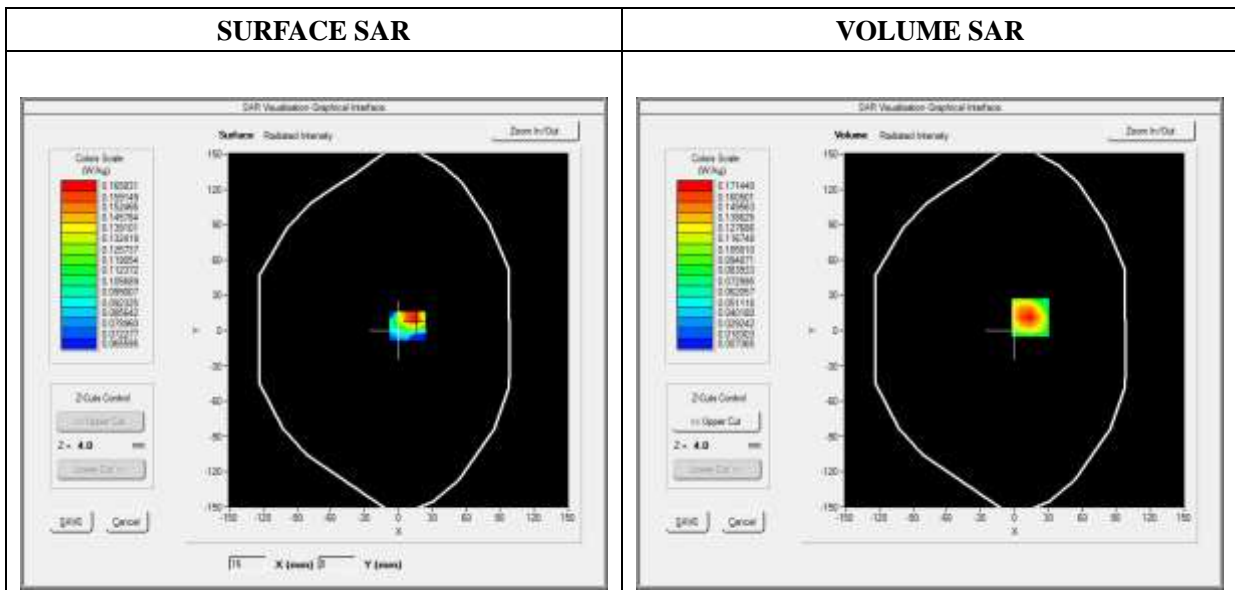

Maximum location: X=14.00, Y=11.00

SAR Peak: 0.27 W/kg

SAR 10g (W/Kg)	0.086779
SAR 1g (W/Kg)	0.161175

Z (mm)	0.00	4.00	9.00	14.00	19.00
SAR (W/Kg)	0.2670	0.1714	0.0951	0.0516	0.0280

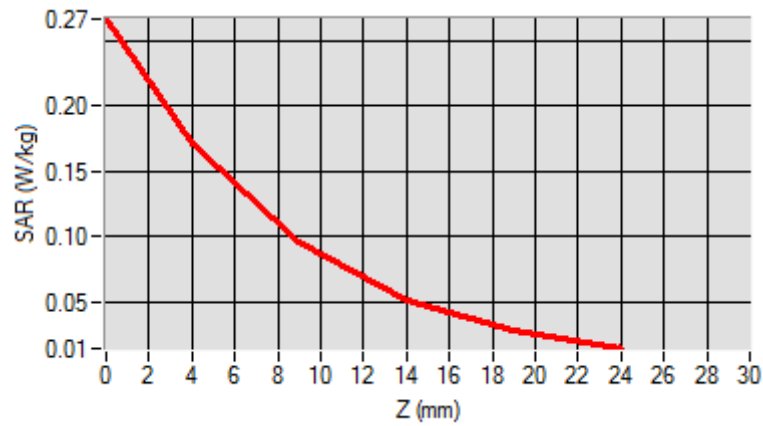

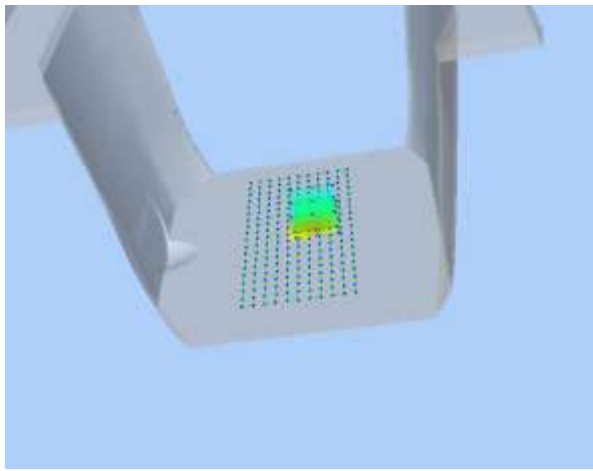
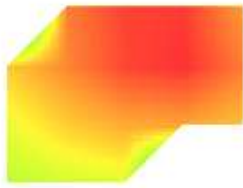
3D screen shot	Hot spot position
	

MEASUREMENT 36

Type: Phone measurement (Complete)

Date of measurement: 04/16/2019

Measurement duration: 12 minutes 3 seconds

E-field Probe: SSE5 - SN 09/13 EP168; ConvF: 7.28; Calibrated: 06/01/2018

A. Experimental conditions

Area Scan	dx=8mm dy=8mm
Zoom Scan	dx=8mm dy=8mm dz=5mm
Phantom	Flat Plane
Device Position	Back
Band	LTE Band 12
Channels	QPSK, 10MHz, 1RB, Low
Signal	Duty Cycle 1:1

B. SAR Measurement Results

Frequency (MHz)	704.000000
Relative Permittivity (real part)	54.964739
Conductivity (S/m)	0.931048
Power Variation (%)	3.672346
Ambient Temperature	21.1
Liquid Temperature	21.2

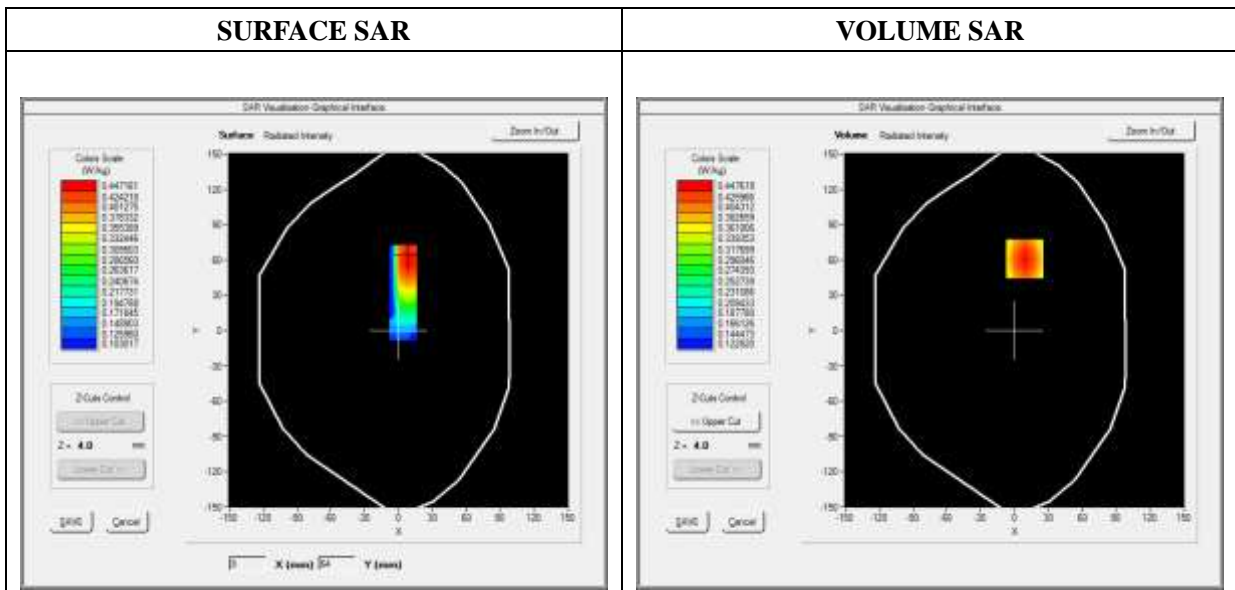



Maximum location: X=9.00, Y=61.00

SAR Peak: 0.54 W/kg

SAR 10g (W/Kg)	0.320860
SAR 1g (W/Kg)	0.431512

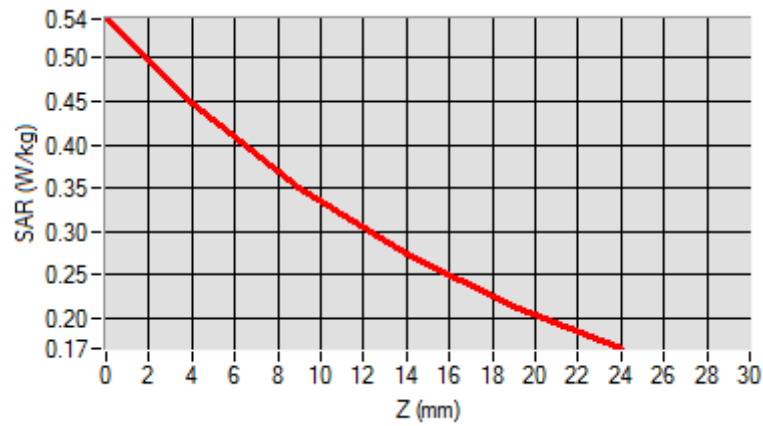
Z (mm)	0.00	4.00	9.00	14.00	19.00
SAR (W/Kg)	0.5445	0.4476	0.3496	0.2735	0.2141

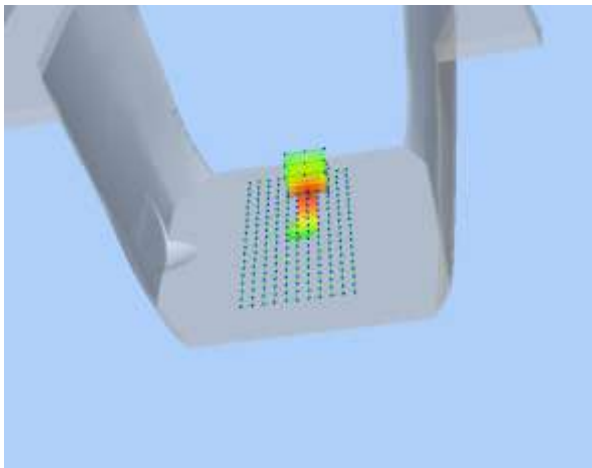

3D screen shot	Hot spot position
	

MEASUREMENT 38

Type: Phone measurement (Complete)

Date of measurement: 04/16/2019

Measurement duration: 12 minutes 3 seconds

E-field Probe: SSE5 - SN 09/13 EP168; ConvF: 7.28; Calibrated: 06/01/2018

A. Experimental conditions

Area Scan	dx=8mm dy=8mm
Zoom Scan	dx=8mm dy=8mm dz=5mm
Phantom	Flat Plane
Device Position	Back
Band	LTE Band 13
Channels	QPSK, 10MHz, 1RB, Middle
Signal	Duty Cycle 1:1

B. SAR Measurement Results

Frequency (MHz)	782.000000
Relative Permittivity (real part)	54.964739
Conductivity (S/m)	0.931048
Power Variation (%)	3.017812
Ambient Temperature	21.1
Liquid Temperature	21.2

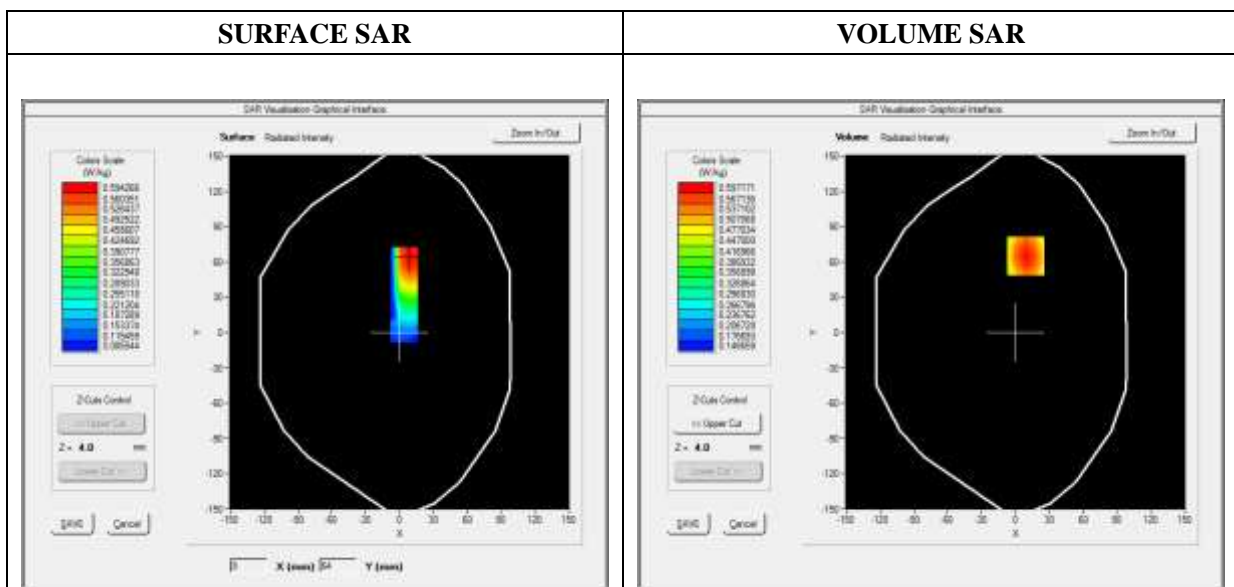



Maximum location: X=9.00, Y=65.00

SAR Peak: 0.74 W/kg

SAR 10g (W/Kg)	0.424756
SAR 1g (W/Kg)	0.587969

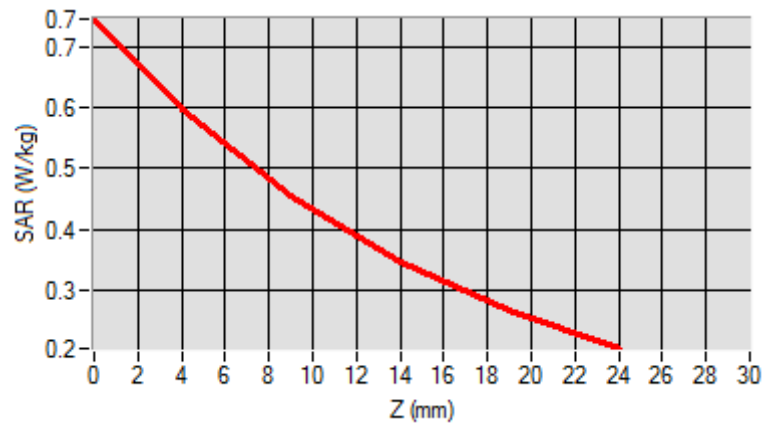
Z (mm)	0.00	4.00	9.00	14.00	19.00
SAR (W/Kg)	0.7448	0.5972	0.4533	0.3467	0.2675

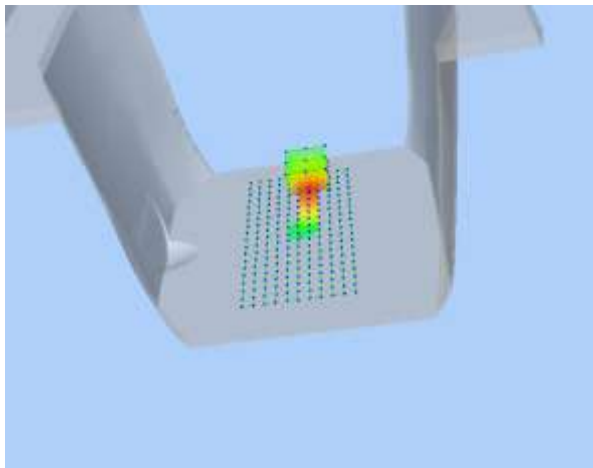

3D screen shot	Hot spot position
	

MEASUREMENT 40

Type: Phone measurement (Complete)

Date of measurement: 04/16/2019

Measurement duration: 12 minutes 3 seconds

E-field Probe: SSE5 - SN 09/13 EP168; ConvF: 7.28; Calibrated: 06/01/2018

A. Experimental conditions

Area Scan	dx=8mm dy=8mm
Zoom Scan	dx=8mm dy=8mm dz=5mm
Phantom	Flat Plane
Device Position	Back
Band	LTE Band 17
Channels	QPSK, 10MHz, 1RB, High
Signal	Duty Cycle 1:1

B. SAR Measurement Results

Frequency (MHz)	711.000000
Relative Permittivity (real part)	54.964739
Conductivity (S/m)	0.931048
Power Variation (%)	3.108329
Ambient Temperature	21.1
Liquid Temperature	21.2

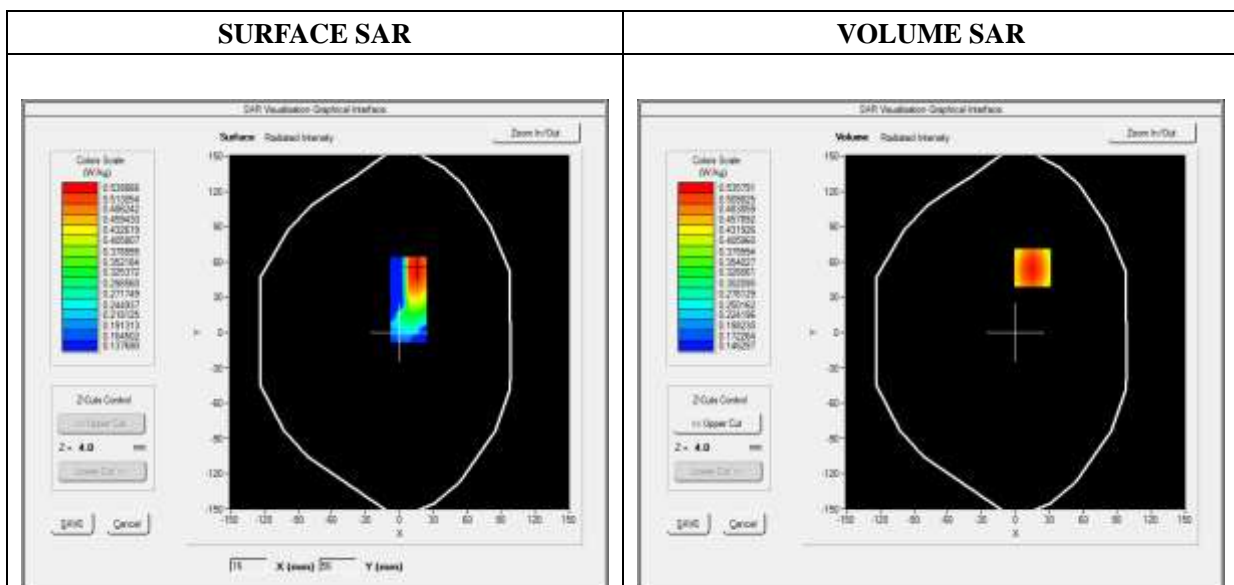

Maximum location: X=15.00, Y=55.00

SAR Peak: 0.65 W/kg

SAR 10g (W/Kg)	0.402877
SAR 1g (W/Kg)	0.546179

Z (mm)	0.00	4.00	9.00	14.00	19.00
SAR (W/Kg)	0.6507	0.5358	0.4194	0.3288	0.2581

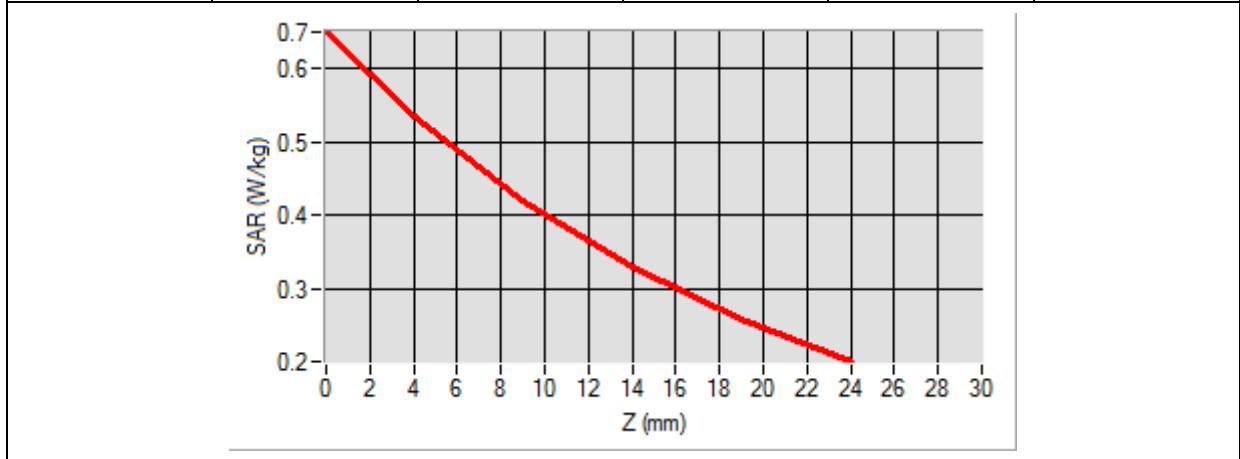

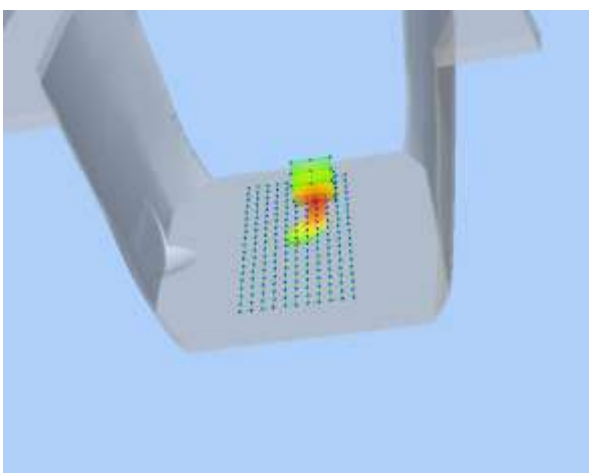
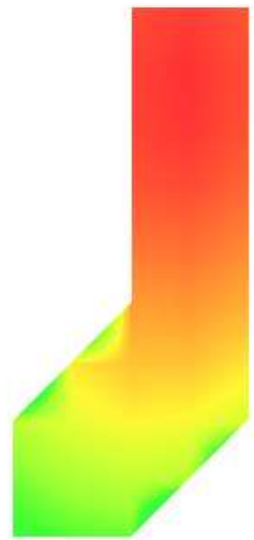
<p>3D screen shot</p>	<p>Hot spot position</p>
	

MEASUREMENT 42

Type: Phone measurement (Complete)

Date of measurement: 04/18/2019

Measurement duration: 12 minutes 3 seconds

E-field Probe: SSE5 - SN 09/13 EP168; ConvF: 5.80; Calibrated: 06/01/2018

A. Experimental conditions

Area Scan	dx=8mm dy=8mm
Zoom Scan	dx=8mm dy=8mm dz=5mm
Phantom	Flat Plane
Device Position	Back
Band	WiFi_802.11b
Channels	Middle
Signal	Duty Cycle 1:1

B. SAR Measurement Results

Frequency (MHz)	2437.000000
Relative Permittivity (real part)	52.010212
Conductivity (S/m)	1.910255
Power Variation (%)	2.492743
Ambient Temperature	21.1
Liquid Temperature	21.2

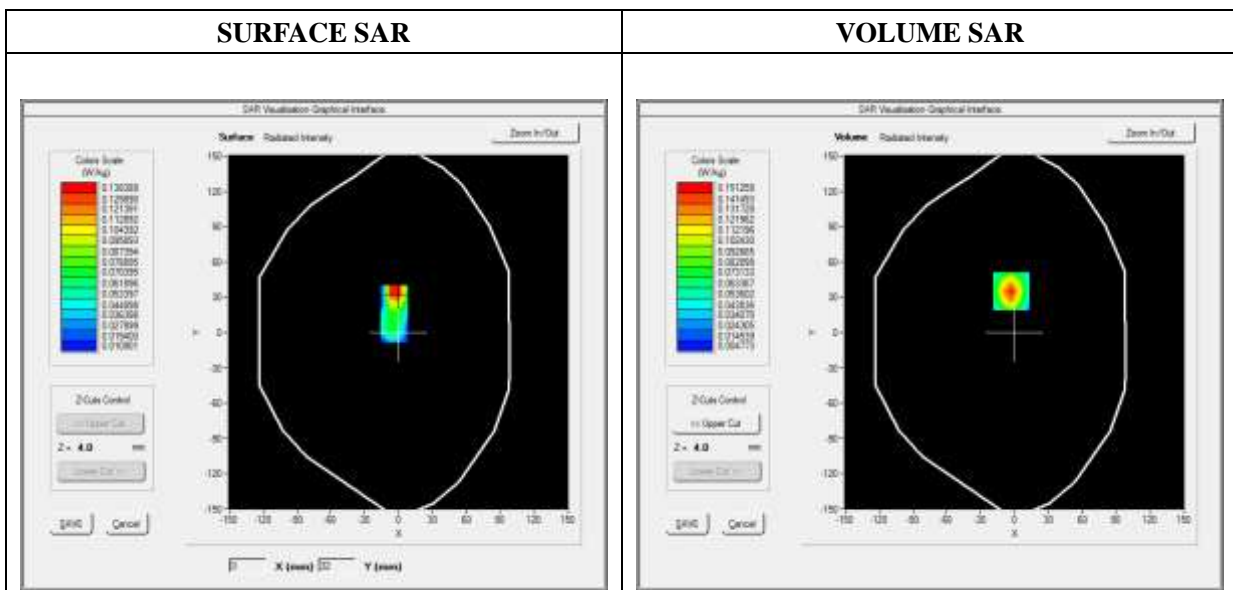

Maximum location: X=-3.00, Y=35.00

SAR Peak: 0.23 W/kg

SAR 10g (W/Kg)	0.071397
SAR 1g (W/Kg)	0.139103

Z (mm)	0.00	4.00	9.00	14.00	19.00
SAR (W/Kg)	0.2319	0.1513	0.0861	0.0485	0.0276

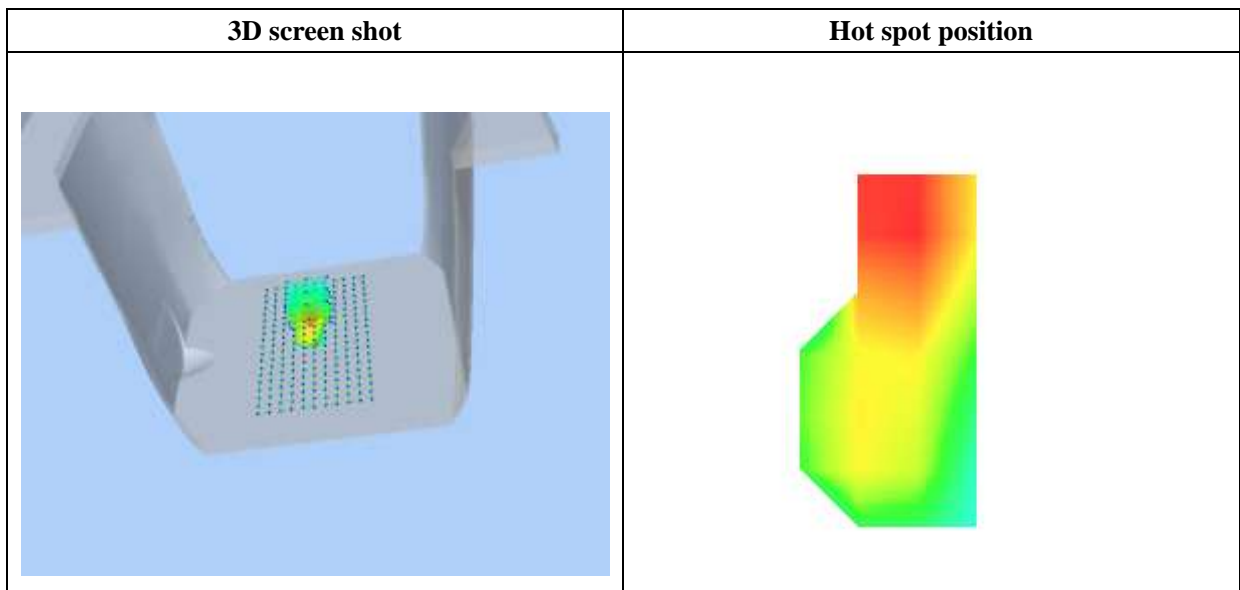
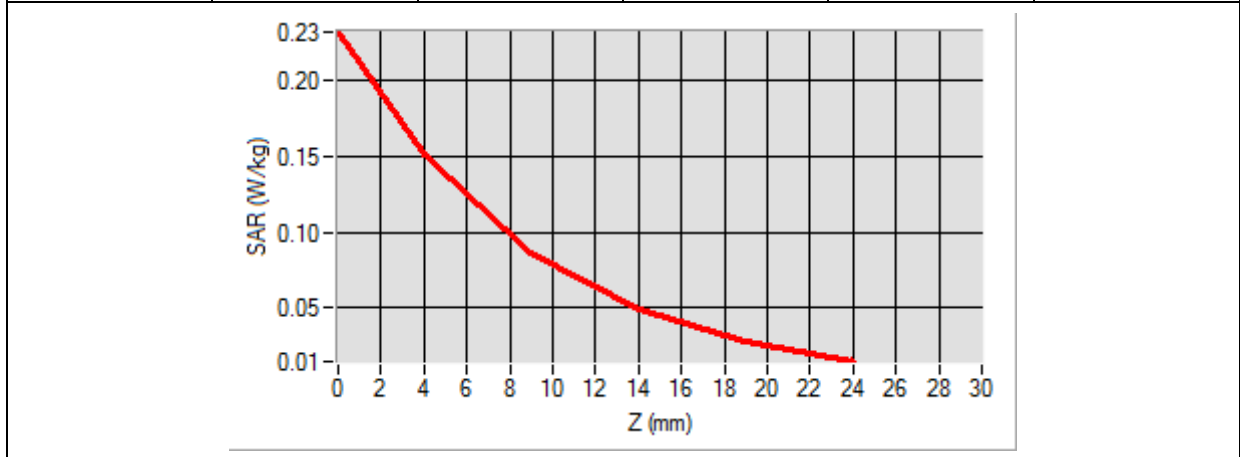

Annex C. EUT Photos

EUT View 1



EUT View 2



Antenna View

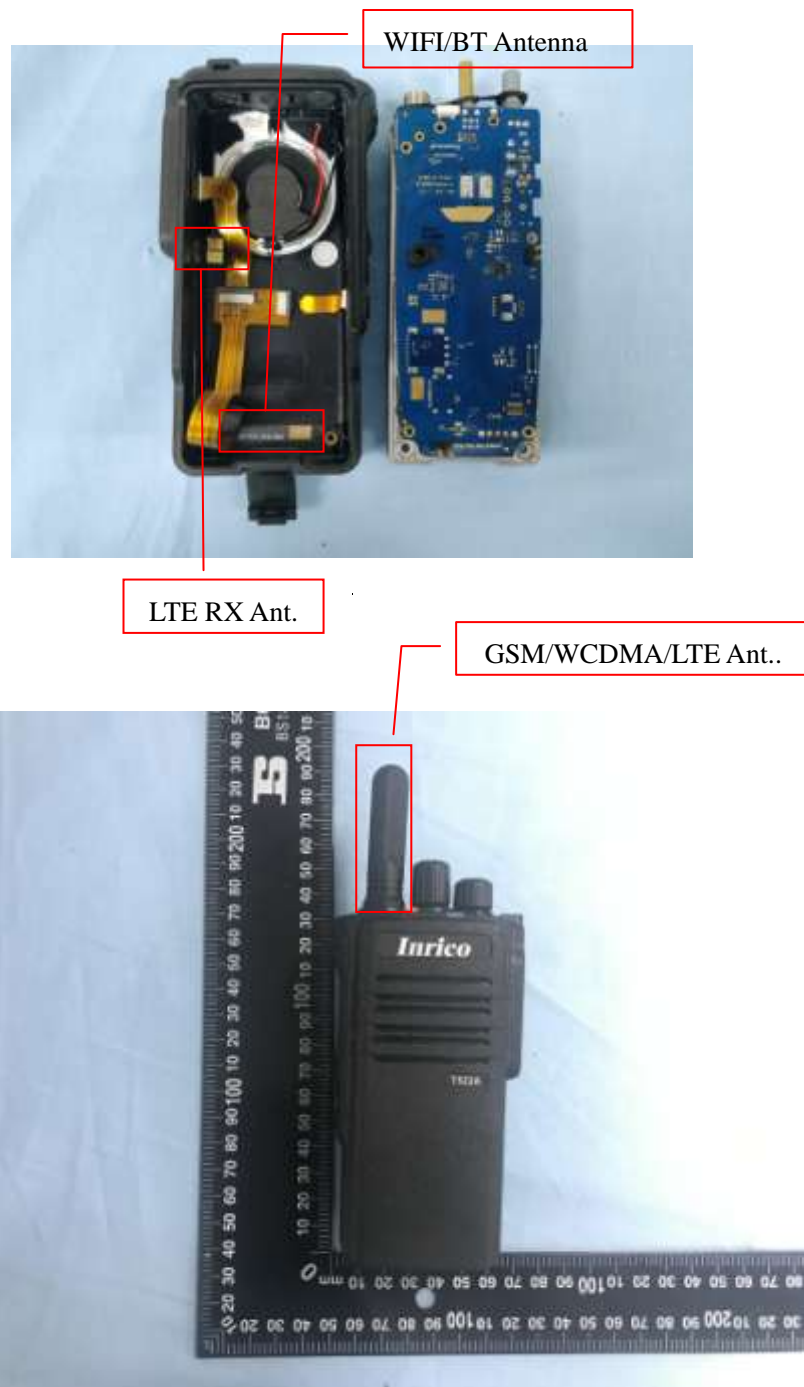

Annex D. Test Setup Photos

Head Exposure Conditions

Front-of-face



Body Exposure Conditions

Body Back



Annex E. Calibration Certificate

Please refer to the exhibit for the calibration certificate

******* END OF REPORT *******