

Instructions

T310R



POC RADIO

Innovation Rich Communications
Inrico

Inrico
Innovation Rich Communications

全球实时对讲



T310R

使用说明书

使用前须知

请仔细阅读以下内容，使用者对使用本机的一般危险性的了解和认识非常重要。

- 请勿在易燃易爆环境如煤气，粉尘，蒸汽等情况下使用本机或对电池进行充电。
- 在加油或停车于加油站时，请关闭本机。
- 请勿在任何情况下擅自改装或调整本机。
- 请勿让本机受到长时间阳光直射或放置于加热器具附近。
- 请勿将本机放在极度多尘，潮湿，水溅，以及不平稳的表面上。
- 请勿自行拆装，维修仅限专业技术人员。

目录

开箱和装置检查.....	01
随机附件.....	01
操作安全说明.....	02
电池安全说明.....	03
使用前充电.....	03
电池长时间保存.....	03
锂电池的特性.....	03
维护和保养.....	03
熟悉本机.....	04
功能说明.....	06
配件安装.....	07
安装SIM卡.....	07
安装MicroSD卡.....	07
安装电池.....	08
安装肩夹.....	08
基本功能.....	09
开机/关机.....	09
用户登录.....	09
呼叫使用.....	10
语音回放.....	10
指示灯状态说明.....	10
简单故障排除.....	11
规格参数.....	12

开箱和设备检查

请小心从包装箱中取出对讲机。我们建议您在废弃包装材料之前确认一下箱内是否有下表列出的物品。若有任何物品在搬运中丢失或损坏，请与我们的经销商联系确认。

随机附件

名称	数量
对讲机	1
锂电池	1
电源适配器	1
USB线	1
背夹	1
对讲机挂绳	1
使用说明书	1

操作安全说明

● 请不要对电池充电时间过长

如果对电池的充电在规定时间内仍未完成，请停止充电。电池可能会过热和冒烟爆裂或突然起火。

● 请不要将电池放入微波炉和高压容器

电池可能会过热和冒烟爆裂或突然起火。

● 请不要让破裂并泄漏的电池靠近火源

如果电池泄漏或发出刺鼻的气味，立即将其远离易燃区域。电池泄漏的电解液容易起火，可能会导致电池冒烟或突然起火。

● 请不要使用异常电池

如果电池发出刺鼻的气味，颜色看上去不同，变形或者因任何原因而表现异常，请将电池从充电器或操作装置上取下不要使用。

● 请使用专用充电器

充电器是专门为该型号设备所设计的，对本机电池的充电更为科学合理，安全可靠。

电池安全说明

在使用之前先对电池充电

为尽量减少电池放电，请不要使用电池时将电池从装置上取下来，并保存在阴凉干燥处。

在长时间存放电池时请从设备上拆卸电池

- 如果10天或更长时间不使用电池，则需将电池放电至40%-65%，以延长电池寿命。

- 当电池闲置超过10天时，需将电池放电到65%以下存储，防止电池鼓包。

- 将电池存放在阴凉干燥处(温度低于25摄氏度)。

锂电池的特性

- 电池经反复充电、放电，其容量逐渐减少。

- 即使电池从不使用也会老化。

- 在较阴凉处对锂电池充电，所需的时间较长。

- 在较热处对电池充电会缩短其使用寿命。在较热处存放电池时，电池老化的更快。请不要将电池留在车内和放在加热具附近。

- 如果电池使用时间变短，即使已经满电，也请更换电池。继续对电池进行充电和放电，将导致电解液泄漏。

维护和保养

- 清洁和维护本设备之前，先停止使用本设备，关闭电源，并断开与其他设备的所有连接。

- 当对讲机不使用时请将附件插孔盖盖上。

- 清洁对讲机外观的灰尘时，请使用中性洗涤剂（不能使用强腐蚀性化学药剂）进行擦拭。

请保持设备及其配件干燥。请勿使用微波炉或吹风机等外部加热设备对其进行干燥处理。

熟悉本机

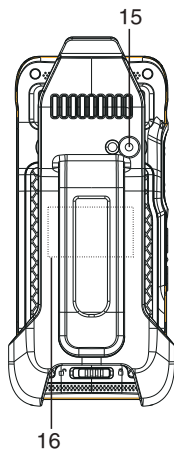
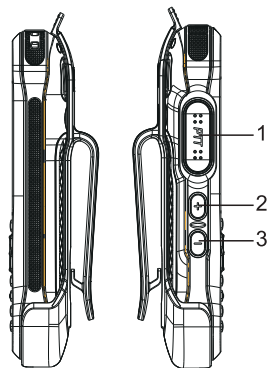
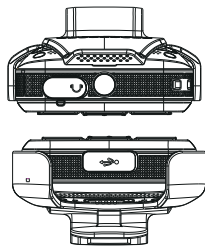
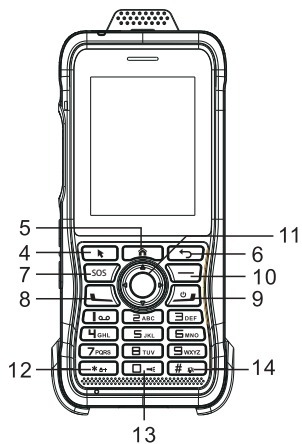

功能说明

序列	名称	功能
1	PTT按键	按下发起组呼，松开结束组呼
2	音量+键	增大音量
3	音量-键	减小音量
4	选择键	选择键
5	home键	进入主界面
6	返回键	返回上一级菜单
7	SOS键/ 可编程键F2	默认长按为SOS 管理平台可自定义按键
8	拨号键	拨打语音电话
9	挂机键	通话中挂断电话 长按关机，短按息屏
10	可编程键F3	默认短按语音回放 管理平台可自定义按键
11	导航键	中间OK确认； 导航键可上翻，下翻，左翻，右翻
12	*键	返回键+*键可解锁
13	0键	长按打开/关闭手电筒
14	#字键	长按切换静音/震动模式
15	摄像头 (选配)	拍照
16	NFC	NFC功能必须在巡更模式下才能生效

配件安装

插入SIM卡

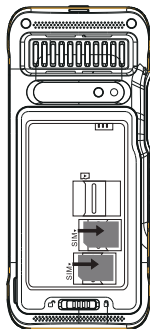

插入Micor SD卡

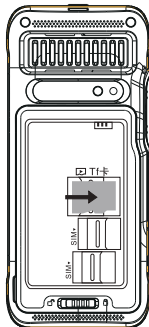

安装电池

- 将带有金属触点的一端插入电池槽
- 向下按压电池另一端

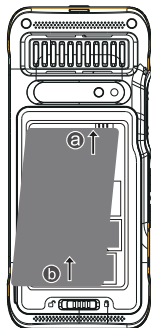

密合电池盖：

- 向上推入电池盖插孔；
- 向下压下电池盖，再把锁扣扣上

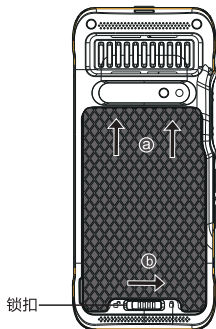

安装背夹

- 背夹顶部对准卡槽定位
- 背夹下端两边卡住对讲机下端两侧；
卸下背夹：依次扣取下端卡住部分，再取下顶部。

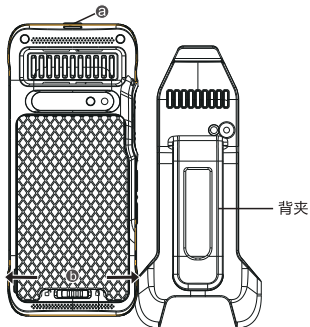

电池充电

将USB线一端插入设备充电接口，另一端插入适配器，适配器通电后，电池充电器通电后，电池充电指示灯亮红色，充满电后指示灯为绿色。

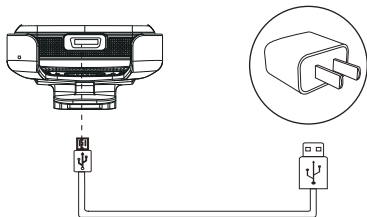

基本功能

● 开机

长按开机键4s等待开机等待程序启动。

● 关机

长按开机键4s关机。

● 解锁

短按开机键息屏上锁，按返回键加*号键解锁。

● 用户登录

用户登陆成功后，显示当前群组名。

● 呼叫使用

按下PTT键，即可开始对讲。

设备处于呼叫状态，led灯长亮红灯；

如果设备处于接听状态，LED灯长亮绿灯；

如果当前网络状态不在线，红灯快闪；

如果当前话权被占，即别人正在通话，PTT键无效。

每次每人最长通话时间限制在60秒内，如果超过60秒，则自动释放话权。

● 语音回放

短按F3键，语音回放最后十段循环，按PTT键，自动回到最后一段语音回放。

指示灯状态说明

序号	工作状态	LED指示灯	
		颜色	持续时长
1	申请话权成功(对讲)	红色	常亮
2	接听(对讲)	绿色	常亮
3	搜网状态	红色	闪烁(1秒1次)
4	极低电(低于15%)	红色	闪烁(3秒一次)
5	正常待机状态	绿色	闪烁(5秒一次)
6	充电状态	红色	常亮
7	充电状态--充满电	绿色	常亮

简单故障排除

现象	解决方案
无法开机	<ul style="list-style-type: none"> ● 电池可能安装错误。拆卸并重新接上电池。 ● 电池可能没电了。充电或更换电池。 ● 电池可能因脏或损坏而接触不良。清洁电池触点或更换电池。
终端死机	<ul style="list-style-type: none"> ● 程序运行过多，强制停止一些正在运行的应用程序或重新启动终端。
按键无反应	<ul style="list-style-type: none"> ● 按键可能暂时无法正常工作，重新启动终端。 ● 按键坏了，请与经销商或本公司客服联系。
显示屏白屏	<ul style="list-style-type: none"> ● 显示屏可能暂时无法正常工作，重新启动终端。 ● 显示屏坏了，请与经销商或本公司客服联系。
连接有回音或者噪音	<ul style="list-style-type: none"> ● 通信信号可能较弱，确保终端在网络覆盖范围内。 ● 扬声器可能被挡住，清洁扬声器表面。
无法检测到SIM卡	<ul style="list-style-type: none"> ● SIM卡可能安装不正确，拆卸并重新安装SIM卡。 ● SIM卡可能金属触点脏或损坏，清洁金属触点。
无法定位	<ul style="list-style-type: none"> ● 位置信号弱，终端可能无法接收信号。移至开阔平坦的地方，再试一次。
电池无法充电	<ul style="list-style-type: none"> ● 电源适配器插头可能损坏或接触不良，拔出并重新插入适配器。 ● 数据线连接器可能损坏或接触不良，拔出并重新插入电缆。
待机时间缩短	<ul style="list-style-type: none"> ● 环境原因，高温环境下电池寿命变短，更换新电池。 ● 运营商有关，信号微弱地区耗电增加，请暂时将对讲机关闭。
无法连接网络	<ul style="list-style-type: none"> ● SIM卡无法正常工作或无法使用，确认SIM卡有无欠费。 ● 手机网络未启用，打开SIM卡网络，联系运营商启用蜂窝网络。

规格参数

操作系统	RTOS	
频段	欧版	GSM: B2/B3/B5/B8 WCDMA: B1/B2/B5/B8 TDD: B38/B39/B40/B41 FDD: B1/B3/B5/B7/B8/B20/B28A/B28B
	美版	GSM: B2/B5 WCDMA: B2/B5 TDD: B40 FDD: B2/B4/B5/B7/B66
	支持	GPS/北斗 RFID
	CPU	T107
	内存	48MB(RAM)+ 128MB(ROM)
	工作电压	3.8V
屏幕尺寸	2.4英寸 (240*320像素)	
摄像头	0.3MP(选配)	
电池	3400 mAh	
尺寸	136*60*22.5mm (不包含背夹)	
重量	≈ 180g	
工作温度	-10°C ~ 55°C	
存储温度	-20°C ~ 55°C	

Guidelines:

- Do not remove the RF Exposure Label from the device.

RF exposures

decrease with distance from the antenna.

- When worn on the body, always place the radio in approved clip, holder, holster, case, case, or body harness

for this product. Use of non-approved accessories may result in exposure levels, which exceed the general / uncontrolled environment RF exposure limits.

- Use only manufacturer's name approved supplied or replacement antennas, batteries, and accessories.

Use of non-manufacturer-name approved antennas, batteries, and may exceed the FCC RF exposure guidelines.

- For a list approved accessories please consult your local dealer for information.

Max. SAR Level(s) Reported(W/kg)

Body :0.66W/kg, Face Up:0.99W/kg

Limit (W/kg):1.6W/kg

Guidelines:

- Do not remove the RF Exposure Label from the device.
- User awareness instructions should accompany device when transferred to other users.
- Do not use this device if the operational requirements described herein are not met.

Operating Instructions:

- Transmit no more than the rated duty factor of 50% of the time.

To transmit (talk), push the Push-To-Talk (PTT) button.

To receive calls, release the PTT button.

Transmitting 50 % of the time, or less, is important because this radio generates measurable RF energy exposure only when transmitting(in terms of measuring for standards compliance).

- Hold the radio in a vertical position in front of face with the microphone(and the other parts of the radio, including the antenna) at least one inch (2.5 cm)away from the nose.

Keeping the radio at the proper distance is important because Antenna should be kept away from eyes.

—Consult the dealer or an experienced radio/TV technician for help.

SAR tests are conducted using standard operating positions accepted by the FCC with the device transmitting at its highest certified power level in all tested frequency bands, although the SAR is determined at the highest certified power level, the actual SAR level of the device while operating can be well below the maximum value. Before a new model device is available for sale to the public, it must be tested and certified to the FCC that it does not exceed the exposure limit established by the FCC, Tests for each device are performed in positions and locations (worn on the body)as required by the FCC.

For face-up, 10mm was used for test, this equipment should be installed and operated with minimum distance 10mm. For body worn operation, this model phone has been tested and meets the FCC RF exposure guidelines when used with an accessory designated for this product or when used with an accessory that Contains no metal and that positions the handset minimum of 5mm from the body. Non-compliance with the above restrictions may result in violation of RF exposure guidelines. RF Exposure Compliance and Control Guidelines and Operating Instructions To control your exposure and ensure compliance with the general/uncontrolled environment exposure limits always adhere following procedures.

Specification

Operating System		RTOS
Frequency	EU version	GSM: B2/B3/B5/B8
		WCDMA: B1/B2/B5/B8
		TDD: B38/B39/B40/B41
		FDD: B1/B3/B5/B7/B8/B20/B28A/B28B
	US version	GSM: B2/B5
		WCDMA: B2/B5
	FDD: B2/B4/B5/B7/B40/B66	
Support	GPS	RFID
CPU	T107	
Memory	48MB(RAM)+ 128MB(ROM)	
Camera	0.3MP (optional)	
Voltage	3.8V	
Screen Size	2.4inches,240x320 Pixel	
Battery	3400 mAh	
Dimension (H*W*D)	136*60*21.5 (Without Belt clip)	
Weight	≈180g	
Working Temperature	-10°C ~ 55°C	
Storage Temperature	-20°C ~ 55°C	

Any Changes or modifications not expressly approved by the party responsible for compliance could void the user's authority to operate the equipment.

This device complies with part 15 of the FCC Rules. Operation is subject to the following two conditions: (1) This device may not cause harmful interference, and (2) this device must accept any interference received, including interference that may cause undesired operation.

IMPORTANT NOTE:

Note: This equipment has been tested and found to comply with the limits for a Class B digital device, pursuant to part 15 of the FCC rules. These limits are designed to provide reasonable protection against harmful interference in a residential installation. This equipment generates, uses and can radiate radio frequency energy and, if not installed and used in accordance with the instructions, may cause harmful interference to radio communications. However, there is no guarantee that interference will not occur in a particular installation. If this equipment does cause harmful interference to radio or television reception, which can be determined by turning the equipment off and on, the user is encouraged to try to correct the interference by one or more of the following measures:

- Reorient or relocate the receiving antenna.
- Increase the separation between the equipment and receiver.
- Connect the equipment into an outlet on a circuit different from that to which the receiver is connected.

Status Indicators

Working Status	Led Indicator	
	Color	Lasting Time
Transmitting	Red	Solid Red
Receiving	Green	Solid Green
Searching network	Red	Flash 1S/time
Low power less than 15%	Red	Flash 3S/time
Normal standby	Green	Flash 5S/time
Charging	Red	Solid Red
Fully charged	Green	Solid Green

Specification

Operating System		RTOS
Frequency	EU version	GSM: B2/B3/B5/B8
		WCDMA: B1/B2/B5/B8
		TDD: B38/B39/B40/B41
		FDD: B1/B3/B5/B7/B8/B20/B28A/B28B
	US version	GSM: B2/B5
		WCDMA: B2/B5
		TDD: B40
		FDD: B2/B4/B5/B7/B66
Support	GPS/BDS	RFID
CPU	T107	
Memory	48MB(RAM)+ 128Gb(ROM)	
Camera	0.3MP (optional)	
Voltage	3.8V	
Screen Size	2.4inches,240x320 Pixel	
Battery	3400 mAh	
Dimension (H*W*D)	136*60*21.5 (Without Antenna & Belt clip)	
Weight	≈180g	
Working Temperature	-10°C ~ 55°C	
Storage Temperature	-20°C ~ 55°C	

5. Attaching the Belt Clip

- Align the top of the clip with the slot ;
- The end of the clip is stuck on both sides of the end of the walkie-talkie: Uninstall the belt clip : Remove from the bottom , and then the top.

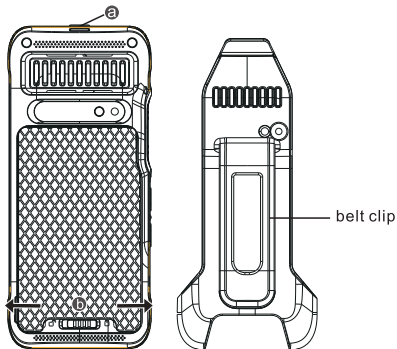

6. Charging batteries

Plug one end of the USB cable into the battery charging port, and the other end into the adapter. After the adapter is powered on, the battery charging indicator lights up red, and when fully charged, the red light turns green.

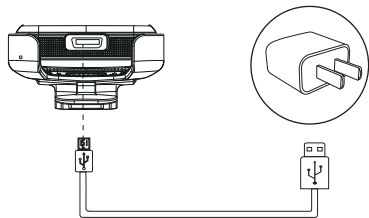

Basic Functions

1. Power on/Power off

- Power On: Long press the power button for 4 seconds and the program will start.
- Power Off: Long press the power button for 4 seconds.

2. Screen unlock

Short press the power button to lock the screen.
Press the back button with ***** to unlock.

3. Initiate a Call

- Press PTT button and start to talk.
- The LED light is blinking green after loading the APP.
- The LED light is solid red during transmitting.
- The LED light is solid green during receiving.
- If occupied when other person is talking, the PTT button is invalid.

4. Voice Playback

- Short press the F2 button to playback cyclically the latest 10 voice records.
- Press the PTT button, return automatically to the last voice record.

Accessories Installation

1. Insert SIM card

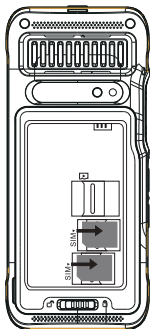

2. Insert Micro SD card

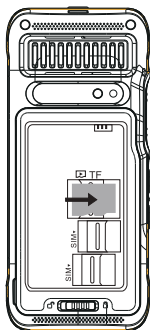

3. Attaching the Battery Cover

- Push the battery cover until it clicks into place.
- Push the battery cover down.

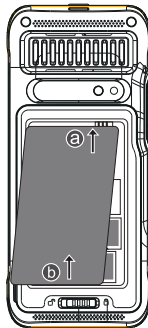

4. Close the Battery Cover

- (a) Push up into the battery cover socket
(b) Lock the battery latch
- Open the battery cover :
Flip down the battery button and open the battery cover

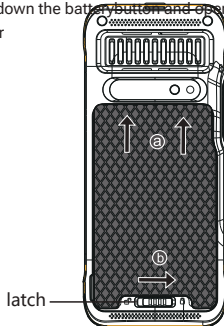

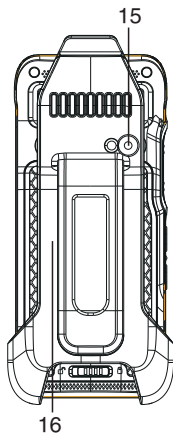
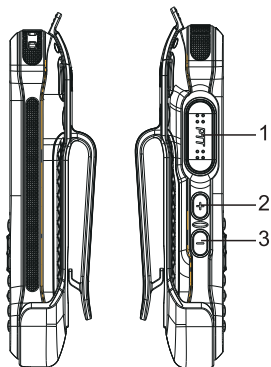

Function Sheet

No.	Button Name	Function
1	PTT Button	Long press the PTT button to talk. Release the PTT button to listen.
2	volume +	Press to increase the volume
3	volume -	Press to decrease the volume
4	Select button	Select an option
5	Home	Enter the main interface
6	Return button	Back to previous menu
7	SOS/ Programmable Key F2	Default long press for SoS Customizable keys in the management platform
8	Dial button	Make a voice call
9	Hang-up button	Hang up during a call Long press to turn off the phone, short press for screen off
10	Programmable Key F3	Default short press to play back voice Customizable keys in the management platform
11	Navigation button	Press OK to confirm Navigation key can turn up, turn down, turn left, turn right
12	*	Return button + * key to unlock
13	0	Long press to turn on/off flashlight
14	#	Long press to switch mute/vibration mode
15	Camera(optional)	Photo shoot
16	NFC (optional)	NFC function must be in the patrol mode to take effect

Clean and Maintenance

- Before cleaning and maintaining the device: please stop running, turn off the device, and disconnect all connections with other equipment.
- When you do not use the radio, please cover the accessories connector.
- When cleaning the dust, please use soft brush and neutral detergent (no strong corrosive chemicals) to wipe it.
- Please keep the equipment and accessories dry. Please do not use the microwave oven or hair dryer or other heating devices to dry them.

Product Overview

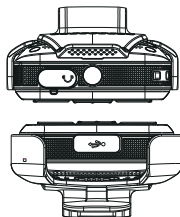
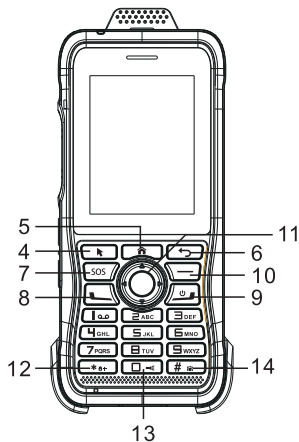

Handling Precautions

Please read the following notice carefully. It is very important for device users to gain general knowledge and risks.

- **Do not overcharge the battery**

Please stop charging if it can't be fully charged within required time. The battery probably overheats, smokes, bursts or suddenly be on fire due to abnormal charging process. When fully charged or not charged, please disconnect the charger and unplug it from the power outlet.

- **Do not discard battery in a microwave or high pressure container.**

The battery probably overheats, smokes, bursts or suddenly be on fire.

- **Do not expose damaged battery near any fire.**

If the battery is broken, leaking or has an abnormal odor, please remove it from flammable areas immediately. The fluid in the battery is flammable, which may cause smoke and fire.

- **Do not use abnormal battery**

If the battery is with odd smelly, discolored, deformed, etc., please stop charging or disassemble from the device immediately.

- **Please use authorized power adaptor**

To comply with warranty terms and avoid damages, charge the battery using a specified charger for best performance.

Battery Care

Fully Charge Battery Before Initial Use

- Do preserve battery life by switching off a device and removing the batteries when it's not being used, and is not expected to be used for extended periods of time.
- Do practice proper battery storage by keeping batteries in a cool, dry place at normal room temperature.

Properly Store Batteries

- Remove the battery from the device.
- Charge and discharge the battery to 40%-65% if it will not be used for 10 days or more. This can greatly extend the battery life.
- The battery should drop below 65% when it is idle for more than 10 days to prevent it from swelling.
- Store the battery in cool and dry environment that's less than 25°C.

Features of Lithium Battery

- Battery capacity will reduce after multiple charging cycles.
- The battery capacity drops gradually even without being used.
- Longer charging time is required in shady place.
- Charging and storing Lithium battery in warm condition will short its lifespan. Please do not leave them inside the vehicle or near the heater.
- If the battery working time has reduced significantly, please replace the battery immediately in avoidance of fluid leakage.

Contents

Unpacking and Device Checking.....	01
Accessories.....	02
Handling Precautions.....	03
Battery Care.....	03
Fully Charge Battery Before Initial Use.....	03
Properly Store Batteries.....	03
Features of Lithium Battery	03
Clean and Maintenance.....	04
Product Overview.....	05
Function Sheet.....	07
Accessories Installation.....	08
Insert SIM Card	08
Insert micro SD Card.....	08
Assemble the Battery Cover.....	09
Close the Battery Cover.....	09
Attaching the Belt Clip.....	10
Charging batteries.....	10
Basic Functions.....	11
Power on/Power off.....	11
Screen unlock.....	11
Initiate a Call.....	11
Voice Playback.....	11
Status Indicators.....	12
Simple Troubleshooting.....	13
Specification.....	14

Unpacking and Device Checking

Please unpack and take out the device and all accessories carefully, and ensure all lists have been gotten before discarding the cardboard box. If any items are lost or damaged in transit, please contact with our distributors.

Accessories

Items	Number
PoC Radio	1
Lithium Battery	1
Power Adaptor	1
USB Charging Cable	1
Belt Clip	1
Hand Strip	1
User Manual	1
	1

Disclaimer

This guide is for reference only and the information in this document is carefully examined, and is believed to be entirely reliable. However, no responsibility is assumed for inaccuracies. Furthermore, the supplier reserves the right to make changes to any products herein to improve readability, function, or design. The supplier does not assume any liability arising out of the applications or use of any product or circuit described herein; nor does it cover any liability under its patent rights, nor the rights of others.

FCC Caution:

Any Changes or modifications not expressly approved by the party responsible for compliance could void the user's authority to operate the equipment.

This device complies with part 15 of the FCC Rules. Operation is subject to the following : (1) This device may not cause harmful interference, and (2) this device must accept any interference received, including interference that may cause undesired operation.

IMPORTANT NOTE:

Note: This equipment has been tested and found to comply with the limits for a Class B digital device, pursuant to part 15 of the FCC Rules.

These limits are designed to provide reasonable protection against harmful interference in a residential installation. This equipment generates, uses and can radiate radio frequency energy and, if not installed and used in accordance with the instructions, may cause harmful interference to radio communications. However, there is no guarantee that interference will not occur in a particular installation. If this equipment does cause harmful interference to radio or television reception, which can be determined by turning the equipment off and on, the user is encouraged to try to correct the interference by one or more of the following measures:

- Reorient or relocate the receiving antenna.
- Increase the separation between the equipment and receiver.
- Connect the equipment into an outlet on a circuit different from that to which the receiver is connected.
- Consult the dealer or an experienced radio/TV technician for help.

SAR tests are conducted using standard operating positions accepted by the FCC with the device transmitting at its highest certified power level in all tested frequency bands, although the SAR is determined at the highest certified power level, the actual SAR level of the device while operating can be well below the maximum value.

Before a new model device is available for sale to the public, it must be tested and certified tested and certified to the FCC that it does not exceed the exposure limit established by the FCC. Tests for each device are performed in positions and locations (worn on the body) as required by the FCC.

For face-up, 10mm was used for test, this equipment should be installed and operated with minimum distance 10mm.

For body worn operation, this model phone has been tested and meets the FCC RF exposure guidelines when used with an accessory designated for this product or when used with an accessory that Contains no metal and that positions the handset minimum of 5mm from the body. Non-compliance with the above restrictions may result in violation of RF exposure guidelines.

RF Exposure Compliance and Control Guidelines and Operating Instructions. To control your exposure and ensure compliance with the general/uncontrolled environment exposure limits always adhere following procedures.