



# TESTREPORT

Applicant Name : Inrico Technologies Co., Ltd  
Address : 3/F, Building No.118, High Tech Industrial Park, 72 Guowei Road, Luohu District, Shenzhen, China  
ReportNumber: SZ1211009-52872E-RF-00D  
FCC ID: 2AIV6-I-10

## Test Standard (s)

FCC PART 27;FCC PART 22H; FCC PART 24

## Sample Description

Product Type: Body Worn Camera  
Model No.: I-10  
Trade Mark: Inrico  
Date Received: 2021/10/09  
Date of Test: 2021/10/27~2021/11/28  
Report Date: 2021/11/29

Test Result:	Pass*
--------------	-------

\* In the configuration tested, the EUT complied with the standards above.

**Prepared and Checked By:**

**Approved By:**

*Black Ding*

*Candy Li*

Black Ding  
EMC Engineer

Candy Li  
EMC Engineer

Note: This report may contain data that are not covered by the A2LA accreditation and are marked with an asterisk "★".

Shenzhen Accurate Technology Co., Ltd. is not responsible for the authenticity of any test data provided by the applicant. Data included from the applicant that may affect test results are marked with an asterisk "\*". Customer model name, addresses, names, trademarks etc. are not considered data.

This report cannot be reproduced except in full, without prior written approval of the Company. Unless otherwise stated the results shown in this test report refer only to the sample(s) tested. This report is valid only with a valid digital signature. The digital signature may be available only under the Adobe software above version 7.0.

## Shenzhen Accurate Technology Co., Ltd.

1/F., Building A, Changyuan New Material Port, Science & Industry Park, Nanshan District, Shenzhen, Guangdong, P.R. China

Tel: +86 755-26503290

Fax: +86 755-26503396

Web: www.atc-lab.com

Version 45: 2021-11-09

Page 1 of 64

FCC -2G,3G,4G

## TABLE OF CONTENTS

<b>GENERAL INFORMATION</b> .....	<b>3</b>
PRODUCT DESCRIPTION FOR EQUIPMENT UNDER TEST (EUT).....	3
OBJECTIVE.....	3
TEST METHODOLOGY.....	4
MEASUREMENT UNCERTAINTY.....	4
TEST FACILITY.....	4
<b>SYSTEM TEST CONFIGURATION</b> .....	<b>5</b>
DESCRIPTION OF TEST CONFIGURATION.....	5
EQUIPMENT MODIFICATIONS.....	6
SUPPORT EQUIPMENT LIST AND DETAILS.....	6
SUPPORT CABLE DESCRIPTION.....	6
BLOCK DIAGRAM OF TEST SETUP.....	7
<b>SUMMARY OF TEST RESULTS</b> .....	<b>8</b>
<b>TEST EQUIPMENT LIST</b> .....	<b>9</b>
<b>FCC §1.1307(B)&amp;§2.1093 - RF EXPOSURE INFORMATION</b> .....	<b>11</b>
<b>FCC§2.1047 - MODULATION CHARACTERISTIC</b> .....	<b>12</b>
<b>FCC § 2.1046,§ 22.913 (A), § 24.232 (C),§27.50- RF OUTPUT POWER</b> .....	<b>13</b>
APPLICABLE STANDARD.....	13
TEST PROCEDURE.....	13
TEST DATA.....	13
<b>FCC §2.1049, §22.917, §22.905 &amp; §24.238&amp;§27.53- OCCUPIED BANDWIDTH</b> .....	<b>35</b>
APPLICABLE STANDARD.....	35
TEST PROCEDURE.....	35
TEST DATA.....	35
<b>FCC §2.1051, §22.917(A), §24.238(A), §27.53 - SPURIOUS EMISSIONS AT ANTENNA TERMINALS</b> .....	<b>40</b>
APPLICABLE STANDARD.....	40
TEST PROCEDURE.....	40
TEST DATA.....	40
<b>FCC §2.1051, §22.917(A), §24.238(A), §27.53, §90.691 - SPURIOUS EMISSIONS AT ANTENNA TERMINALS</b> .....	<b>41</b>
APPLICABLE STANDARD.....	41
TEST PROCEDURE.....	41
TEST DATA.....	41
<b>FCC§ 22.917 (A), § 24.238 (A),§27.53 - BAND EDGES</b> .....	<b>52</b>
APPLICABLE STANDARD.....	52
TEST PROCEDURE.....	52
TEST DATA.....	52
<b>FCC § 2.1055,§ 22.355, § 24.235, §27.54,§90.213- FREQUENCY STABILITY</b> .....	<b>53</b>
APPLICABLE STANDARD.....	53
TEST PROCEDURE.....	53
TEST DATA.....	54

## GENERAL INFORMATION

### Product Description for Equipment under Test (EUT)

Frequency Range	GSM 850: 824-849MHz(TX); 869-894MHz(RX) PCS 1900: 1850-1910MHz(TX); 1930-1990MHz(RX) WCDMA Band 2: 1850-1910MHz(TX); 1930-1990MHz(RX) WCDMA Band 5: 824-849MHz(TX); 869-894MHz(RX) LTE Band 2: 1850-1910MHz(TX); 1930-1990MHz(RX) LTE Band 4: 1710-1755MHz(TX); 2110-2155MHz(RX) LTE Band 5: 824-849MHz(TX); 869-894MHz(RX) LTE Band 7: 2500-2570MHz(TX); 2620-2690MHz(RX) LTE Band 17: 704-716MHz(TX); 734-746MHz(RX) LTE Band 38: 2570-2620MHz(TX/RX) LTE Band 41: 2545-2655MHz(TX/RX)
Modulation Technique	2G: GMSK/8PSK 3G: BPSK, QPSK, 16QAM 4G: QPSK, 16QAM
Antenna Specification*	GSM850/WCDMA B5/LTE B5:-0.45dBi; PCS1900/WCDMA B2/LTE B2:-0.38dBi; LTE B4:-0.45dBi; LTE B7:-0.28dBi;LTE B17:-0.67dBi; LTE B38/B41:-0.32dBi;(provided by the applicant)
Voltage Range	DC 3.8V from battery or DC 5.0V from adapter.
Sample serial number	SZ1211009-52872E-RF-S1(for radiated test) SZ1211009-52872E-RF-S2 ((RF Conducted Test)Assigned by ATC)
Sample/EUT Status	Good condition
Normal/Extreme Condition	L.V.: Low Voltage 3.5V <sub>DC</sub> ; N.V.: Normal Voltage3.8V <sub>DC</sub> ; H.V.: High Voltage 4.35V <sub>DC</sub> ;
Adapter information	Model:LM-601E-050200U01CE Input: AC 100-240V, 50/60Hz, 0.35A Output: DC 5.0V,2000mA

### Objective

This test report is in accordance with Part 2-Subpart J, Part 22-Subpart H and Part24-Subpart E and Subpart 27of the Federal Communication Commissions rules.

The objective is to determine the compliance of the EUT with FCC rules for output power, modulation characteristic, occupied bandwidth, and spurious emission at antenna terminal, spurious radiated emission, frequency stability and band edge.

## Test Methodology

All tests and measurements indicated in this document were performed in accordance with the Code of Federal Regulations Title 47 Part 2-Subpart J as well as the following parts:

Part 22 Subpart H - Public Mobile Services  
 Part 24 Subpart E - Personal Communication Services  
 Part 27 – Miscellaneous wireless communications services

ANSI C63.26-2015: American National Standard for Compliance Testing of Transmitters Used in Licensed Radio Services

All emissions measurement was performed at Shenzhen Accurate Technology Co., Ltd. The radiated testing was performed at an antenna-to-EUT distance of 3 meters.

Each test item follows test standards and with no deviation.

## Measurement Uncertainty

Parameter		Uncertainty
Occupied Channel Bandwidth		5%
RF Frequency		$0.082 \times 10^{-7}$
RF output power, conducted		0.73dB
Unwanted Emission, conducted		1.6dB
AC Power Lines Conducted Emissions		2.72dB
Emissions, Radiated	9kHz - 30MHz	2.66dB
	30MHz - 1GHz	4.28dB
	1GHz- 18GHz	4.98dB
	18GHz-26.5GHz	5.06dB
	26.5GHz-40GHz	4.72dB
Temperature		1°C
Humidity		6%
Supply voltages		0.4%

*Note: The extended uncertainty given in this report is obtained by combining the standard uncertainty times the coverage factor K with the 95% confidence interval. Otherwise required by the applicant or Product Regulations, Decision Rule in this report did not consider the uncertainty.*

## Test Facility

The Test site used by Shenzhen Accurate Technology Co., Ltd. to collect test data is located on the 1/F., Building A, Changyuan New Material Port, Science & Industry Park, Nanshan District, Shenzhen, Guangdong, P.R. China.

The test site has been approved by the FCC under the KDB 974614 D01 and is listed in the FCC Public Access Link (PAL) database, FCC Registration No.: 708358, the FCC Designation No.: CN1189. Accredited by American Association for Laboratory Accreditation (A2LA) The Certificate Number is 429 7.01.

Listed by Innovation, Science and Economic Development Canada (ISED), the Registration Number is 5077A.

## SYSTEM TEST CONFIGURATION

### Description of Test Configuration

The final qualification test was performed with the EUT operating at normal mode.

The test items were performed with the EUT operating at testing mode. Test was performed with channels as below table:

Frequency Band	Bandwidth (MHz)	Test Frequency (MHz)		
		Low	Middle	High
GSM850	0.25	824.2	836.6	848.8
PCS1900	0.25	1850.2	1880	1909.8
WCDMA B2	4.2	1852.4	1880	1907.6
WCDMA B5	4.2	826.4	836.6	846.6
LTE B2	1.4	1850.7	1880	1909.3
	3	1851.5	1880	1908.5
	5	1852.5	1880	1907.5
	10	1855	1880	1905
	15	1857.5	1880	1902.5
	20	1860	1880	1900
LTE B4	1.4	1710.7	1732.5	1754.3
	3	1711.5	1732.5	1753.5
	5	1712.5	1732.5	1752.5
	10	1715	1732.5	1750
	15	1717.5	1732.5	1747.5
	20	1720	1732.5	1745
LTE B5	1.4	824.7	836.5	848.3
	3	825.5	836.5	847.5
	5	826.5	836.5	846.5
	10	829	836.5	844
LTE B7	5	2502.5	2535	2567.5
	10	2505	2535	2565
	15	2507.5	2535	2562.5
	20	2510	2535	2560
LTE B17	5	706.5	710	713.5
	10	709	710	711

Frequency Band	Bandwidth (MHz)	Test Frequency (MHz)		
		Low	Middle	High
LTE B38	5	2572.5	2595	2617.5
	10	2575	2595	2615
	15	2577.5	2595	2612.5
	20	2580	2595	2610
LTE B41	5	2547.5	2600	2652.5
	10	2550	2600	2650
	15	2552.5	2600	2647.5
	20	2555	2600	2645

### Equipment Modifications

No modification was made to the EUT.

### Support Equipment List and Details

Manufacturer	Description	Model	Serial Number
Rohde & Schwarz	Wideband Radio Communication tester	CMW500	146520

### Support Cable Description

Cable Description	Length (m)	From / Port	To
Un-shielded Un-detachable AC cable	1.2	AC Power	CMU200

### Block Diagram of Test Setup

Test Set up Connect:

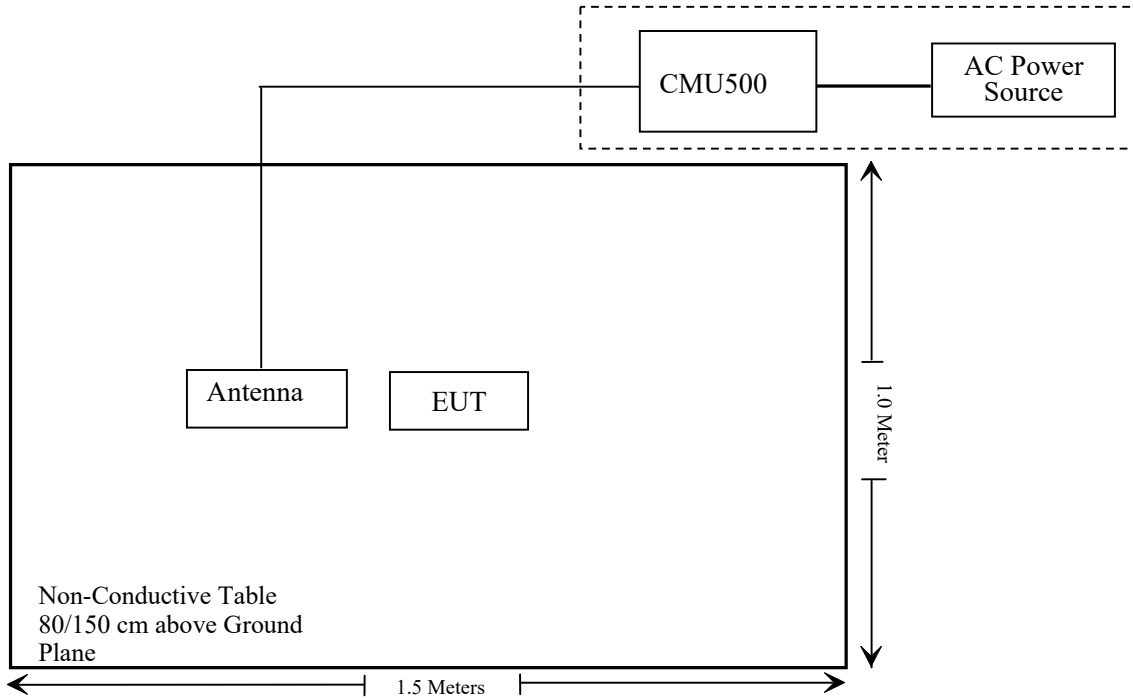

**SUMMARY OF TEST RESULTS**

FCC Rules	Description of Test	Result
§1.1307 , §2.1093	RF Exposure (SAR)	Compliant*
§2.1046; § 22.913 (a); § 24.232 (c); §27.50;	RF Output Power	Compliant
§ 2.1047	Modulation Characteristics	Not Applicable
§ 2.1049; § 22.905; § 22.917; § 24.238; §27.53;	Occupied Bandwidth	Compliant
§ 2.1051; § 22.917 (a); § 24.238 (a); §27.53	Spurious Emissions at Antenna Terminal	Compliant
§ 2.1053; § 22.917 (a); § 24.238 (a); §27.53	Field Strength of Spurious Radiation	Compliant
§ 22.917 (a); § 24.238 (a); §27.53	Band Edge	Compliant
§ 2.1055; § 22.355; § 24.235; §27.54;	Frequency stability	Compliant

Note: \* Please refer to SAR report number: SZ1211009-51697E-SA



**TEST EQUIPMENT LIST**

Manufacturer	Description	Model	Serial Number	Calibration Date	Calibration Due Date
<b>Radiated Emission Test</b>					
Rohde& Schwarz	Test Receiver	ESR	101817	2020/12/24	2021/12/23
Rohde&Schwarz	Spectrum Analyzer	FSV40	101495	2020/12/24	2021/12/23
SONOMA INSTRUMENT	Amplifier	310 N	186131	2020/12/25	2021/12/24
A.H. Systems, inc.	Preamplifier	PAM-0118P	531	2021/11/09	2022/11/08
Quinstar	Amplifier	QLW-184055 36-J0	15964001002	2020/11/28	2021/11/27
Anritsu Corp	50 Coaxial Switch	MP59B	6100237248	2020/12/25	2021/12/24
Schwarzbeck	Bilog Antenna	VULB9163	9163-194	2020/01/05	2023/01/04
Schwarzbeck	Bilog Antenna	VULB9163	9163-323	2020/01/05	2023/01/04
Schwarzbeck	Horn Antenna	BBHA9120D	9120D-655	2020/01/05	2023/01/04
Schwarzbeck	Horn Antenna	BBHA9120D	9120D-1067	2020/01/05	2023/01/04
PASTERNAK	Horn Antenn	PE9852/2F-20	1120	2020/01/05	2023/01/04
PASTERNAK	Horn Antenn	PE9852/2F-20	1120	2020/01/05	2023/01/04
Unknown	RF Coaxial Cable	N-5m	No.3	2020/12/25	2021/12/24
Unknown	RF Coaxial Cable	N-5m	No.4	2020/12/25	2021/12/24
Unknown	RF Coaxial Cable	N-1m	No.5	2020/12/25	2021/12/24
Unknown	RF Coaxial Cable	N-1m	No.6	2020/12/25	2021/12/24
Wainwright	High Pass Filter	WHKX3.6/18 G-10SS	5	2020/12/25	2021/12/24
CD	High Pass Filter	HPM-1.2/18G -60	110	2020/12/25	2021/12/24
Anritsu	Signal Generator	68369B	004114	2021/7/31	2022/7/30

Manufacturer	Description	Model	Serial Number	Calibration Date	Calibration Due Date
<b>RF Conducted Test</b>					
Rohde&Schwarz	Spectrum Analyzer	FSV-40	101495	2020/12/24	2021/12/23
Mini-Circuits	Power Splitter	DC-18000MHz	SF10944151S	2020/12/25	2021/12/24
Rohde & Schwarz	Wideband Radio Communication Tester	CMW500	154606	2020/12/25	2021/12/24
HP	6dB Attenuator	8493B 6dB Attenuator	2708A 04769	2020/12/25	2021/12/24
Gongwen	Temp. & Humid. Chamber	JB913R	GZ-WS004	2020/12/25	2021/12/24
Unknown	RF Cable	Unknown	Unknown	Each time	/

\* Statement of Traceability: Shenzhen Accurate Technology Co., Ltd. attests that all calibrations have been performed in accordance to requirements that traceable to National Primary Standards and International System of Units (SI).

---

## **FCC §1.1307(b)&§2.1093 - RF EXPOSURE INFORMATION**

---

### **Applicable Standard**

FCC§1.1310 and §2.1093.

### **Test Result**

Compliant, please refer to the SAR report: SZ1211009-51697E-SA.

---

## **FCC§2.1047 - MODULATION CHARACTERISTIC**

---

According to FCC § 2.1047(d), Part 22H & 24E& 27 there is no specific requirement for digital modulation, therefore modulation characteristic is not presented.

## **FCC § 2.1046, § 22.913 (a), § 24.232 (c), § 27.50- RF OUTPUT POWER**

### **Applicable Standard**

According to FCC §2.1046 and §22.913 (a), the ERP of mobile transmitters and auxiliary test transmitters must not exceed 7 watts.

According to FCC §2.1046 and §24.232 (C), mobile and portable stations are limited to 2 watts EIRP and the equipment must employ a means for limiting power to the minimum necessary for successful communications.

The peak-to-average power ratio (PAPR) of the transmitter output power must not exceed 13 dB.

According to §27.50(c), Portable stations (hand-held devices) in the 600 MHz uplink band and the 698-746 MHz band, and fixed and mobile stations in the 600 MHz uplink band are limited to 3 watts ERP.

According to §27.50(h), the maximum EIRP must not exceed 2Watts (33dBm) for 2500-2570MHz & 2496-2690MHz.

### **Test Procedure**

*Conducted method:*

The RF output of the transmitter was connected to the CMW500 through sufficient attenuation.

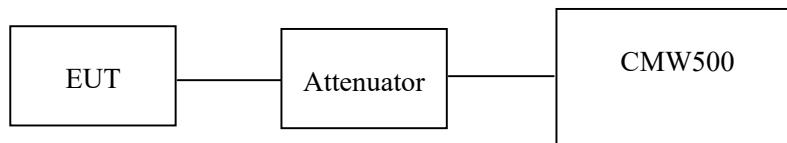

### **Test Data**

#### **Environmental Conditions**

<b>Temperature:</b>	27.6°C
<b>Relative Humidity:</b>	58%
<b>ATM Pressure:</b>	101.0kPa

*The testing was performed by Black Ding from 2021-10-27 to 2021-10-28.*

**Conducted Power****Cellular Band (Part 22H)**

Mode	Channel	Frequency (MHz)	Average Output Power (dBm)	ERP(dBm)	Limit (dBm)
GSM	128	824.2	31.4	28.8	38.45
	190	836.6	31.6	29.0	38.45
	251	848.8	31.7	29.1	38.45

Mode	Channel	Frequency (MHz)	Average Output Power (dBm)				ERP(dBm)				Limit (dBm)
			1 slot	2 slots	3 slots	4 slots	1 slot	2 slots	3 slots	4 slots	
GPRS	128	824.2	31.35	31.02	29.72	28.52	28.75	28.42	27.12	25.92	38.45
	190	836.6	31.67	31.32	29.93	28.77	29.07	28.72	27.33	26.17	38.45
	251	848.8	31.78	31.44	30.07	28.81	29.18	28.84	27.47	26.21	38.45

Mode	Channel	Frequency (MHz)	Average Output Power (dBm)				ERP(dBm)				Limit (dBm)
			1 slot	2 slots	3 slots	4 slots	1 slot	2 slots	3 slots	4 slots	
EGPRS	128	824.2	27.09	25.80	23.59	22.18	24.49	23.2	20.99	19.58	38.45
	190	836.6	27.08	25.71	23.42	22.14	24.48	23.11	20.82	19.54	38.45
	251	848.8	27.18	25.91	23.66	22.33	24.58	23.31	21.06	19.73	38.45

Mode	Test Mode	3GPP Sub Test	Average Output Power (dBm)			ERP(dBm)		
			Low	Mid	High	Low	Mid	High
WCDMA (Band 5)	RMC12.2k		22.85	23.02	22.98	20.25	20.42	20.38
	HSDPA	1	20.71	20.57	20.78	18.11	17.97	18.18
		2	20.68	20.54	20.55	18.08	17.94	17.95
		3	20.65	20.61	20.56	18.05	18.01	17.96
		4	20.67	20.54	20.53	18.07	17.94	17.93
	HSUPA	1	21.08	20.85	20.78	18.48	18.25	18.18
		2	21.01	20.77	20.72	18.41	18.17	18.12
		3	21.02	20.78	20.68	18.42	18.18	18.08
		4	20.99	20.69	20.69	18.39	18.09	18.09
		5	20.64	20.74	20.65	18.04	18.14	18.05
HSPA+	1	20.82	20.71	20.67	18.22	18.11	18.07	

Note: ERP(dBm) = Conducted Power(dBm) + Antenna Gain(dBd)  
 For GSM850 / WCDMA Band5: Antenna Gain = -0.45dBi = -2.6dBd (0dBd=2.15dBi)  
 Limit: ERP ≤ 38.45dBm

**PCS Band (Part 24E)**

Mode	Channel	Frequency (MHz)	Average Output Power (dBm)	EIRP(dBm)	Limit (dBm)
GSM	512	1850.2	29.1	28.72	33
	661	1880.0	29.3	28.92	33
	810	1909.8	29.5	29.12	33

Mode	Channel	Frequency (MHz)	Average Output Power (dBm)				EIRP(dBm)				Limit (dBm)
			1 slot	2 slots	3 slots	4 slots	1 slot	2 slots	3 slots	4 slots	
GPRS	512	1850.2	29.12	28.32	26.47	25.37	28.74	27.94	26.09	24.99	33
	661	1880.0	29.19	28.42	26.57	25.51	28.81	28.04	26.19	25.13	33
	810	1909.8	29.39	28.64	26.86	25.78	29.01	28.26	26.48	25.40	33

Mode	Channel	Frequency (MHz)	Average Output Power (dBm)				EIRP(dBm)				Limit (dBm)
			1 slot	2 slots	3 slots	4 slots	1 slot	2 slots	3 slots	4 slots	
EGPRS	512	1850.2	25.46	24.20	22.02	20.87	25.08	23.82	21.64	20.49	33
	661	1880.0	26.05	23.72	21.53	20.20	25.67	23.34	21.15	19.82	33
	810	1909.8	25.87	24.58	22.42	21.00	25.49	24.20	22.04	20.62	33

Mode	Test Mode	3GPP Sub Test	Average Output Power (dBm)			EIRP(dBm)		
			Low	Mid	High	Low	Mid	High
WCDMA (Band 2)	RMC12.2k		22.53	22.59	22.58	22.15	22.21	22.2
	HSDPA	1	20.45	20.44	20.58	20.07	20.06	20.20
		2	20.42	20.43	20.5	20.04	20.05	20.12
		3	20.47	20.38	20.52	20.09	20.00	20.14
		4	20.51	20.40	20.49	20.13	20.02	20.11
	HSUPA	1	20.75	20.50	20.64	20.37	20.12	20.26
		2	20.72	20.51	20.62	20.34	20.13	20.24
		3	20.71	20.54	20.59	20.33	20.16	20.21
		4	20.69	20.48	20.55	20.31	20.10	20.17
		5	20.65	20.50	20.54	20.27	20.12	20.16
HSPA+	1	20.43	20.47	20.48	20.05	20.09	20.10	

Note: EIRP(dBm) = Conducted Power(dBm) + Antenna Gain(dBi)  
For PCS1900 / WCDMA Band2: Antenna Gain = -0.38dBi  
Limit: EIRP ≤ 33dBm

**LTE Band 2**

Bandwidth (MHz)	Modulation	RB size/ RB Offset	Conducted Average Output Power (dBm)			EIRP(dBm)		
			Low	Mid	High	Low	Mid	High
1.4	QPSK	RB1#0	21.95	21.93	21.84	21.57	21.55	21.46
		RB1#3	22.10	22.08	22.03	21.72	21.70	21.65
		RB1#5	21.95	21.85	21.87	21.57	21.47	21.49
		RB3#0	22.06	22.04	21.92	21.68	21.66	21.54
		RB3#3	22.11	22.10	21.91	21.73	21.72	21.53
		RB6#0	20.99	20.99	20.93	20.61	20.61	20.55
	16QAM	RB1#0	21.08	20.92	20.81	20.70	20.54	20.43
		RB1#3	21.27	21.12	20.99	20.89	20.74	20.61
		RB1#5	21.07	20.97	20.80	20.69	20.59	20.42
		RB3#0	21.02	19.32	21.10	20.64	18.94	20.72
		RB3#3	21.09	17.91	21.09	20.71	17.53	20.71
		RB6#0	20.07	20.00	19.95	19.69	19.62	19.57
3.0	QPSK	RB1#0	21.99	21.99	21.91	21.61	21.61	21.53
		RB1#8	21.97	21.99	21.94	21.59	21.61	21.56
		RB1#14	21.92	21.92	21.92	21.54	21.54	21.54
		RB6#0	20.97	20.90	20.81	20.59	20.52	20.43
		RB6#9	20.90	20.91	20.88	20.52	20.53	20.50
		RB15#0	21.00	20.98	20.91	20.62	20.60	20.53
	16QAM	RB1#0	21.59	21.17	20.92	21.21	20.79	20.54
		RB1#8	21.53	21.18	20.90	21.15	20.80	20.52
		RB1#14	21.52	21.12	20.83	21.14	20.74	20.45
		RB6#0	20.11	20.01	19.82	19.73	19.63	19.44
		RB6#9	20.09	20.07	19.82	19.71	19.69	19.44
		RB15#0	20.16	20.03	20.01	19.78	19.65	19.63



Bandwidth (MHz)	Modulation	RB size/ RB Offset	Conducted Average Output Power (dBm)			EIRP(dBm)		
			Low	Mid	High	Low	Mid	High
5.0	QPSK	RB1#0	21.90	21.94	21.78	21.52	21.56	21.4
		RB1#13	22.03	22.04	21.92	21.65	21.66	21.54
		RB1#24	21.87	21.87	21.77	21.49	21.49	21.39
		RB15#0	21.02	20.98	20.89	20.64	20.60	20.51
		RB15#10	21.02	21.05	20.99	20.64	20.67	20.61
		RB25#0	20.96	20.99	20.87	20.58	20.61	20.49
	16QAM	RB1#0	20.81	21.24	20.88	20.43	20.86	20.50
		RB1#13	20.90	21.33	20.97	20.52	20.95	20.59
		RB1#24	20.79	21.19	20.83	20.41	20.81	20.45
		RB15#0	20.13	20.03	19.99	19.75	19.65	19.61
		RB15#10	20.14	20.11	20.06	19.76	19.73	19.68
		RB25#0	20.09	20.10	19.97	19.71	19.72	19.59
10.0	QPSK	RB1#0	21.94	21.97	21.85	21.56	21.59	21.47
		RB1#25	22.08	22.10	22.02	21.70	21.72	21.64
		RB1#49	21.90	21.87	21.92	21.52	21.49	21.54
		RB25#0	20.99	20.97	20.91	20.61	20.59	20.53
		RB25#25	20.94	21.00	20.97	20.56	20.62	20.59
		RB50#0	20.98	20.97	20.90	20.60	20.59	20.52
	16QAM	RB1#0	21.55	21.12	20.84	21.17	20.74	20.46
		RB1#25	21.66	21.26	20.77	21.28	20.88	20.39
		RB1#49	21.45	21.06	20.68	21.07	20.68	20.30
		RB25#0	20.18	20.08	19.75	19.80	19.70	19.37
		RB25#25	20.10	20.13	19.88	19.72	19.75	19.50
		RB50#0	20.05	20.05	20.07	19.67	19.67	19.69

Bandwidth (MHz)	Modulation	RB size/ RB Offset	Conducted Average Output Power (dBm)			EIRP(dBm)		
			Low	Mid	High	Low	Mid	High
15.0	QPSK	RB1#0	21.84	21.90	21.80	21.46	21.52	21.42
		RB1#37	21.92	21.99	21.45	21.54	21.61	21.07
		RB1#74	21.79	21.79	21.32	21.41	21.41	20.94
		RB36#0	21.07	20.95	20.46	20.69	20.57	20.08
		RB36#18	20.97	20.99	20.45	20.59	20.61	20.07
		RB36#37	20.99	20.99	20.51	20.61	20.61	20.13
		RB75#0	21.45	21.09	20.73	21.07	20.71	20.35
	16QAM	RB1#0	21.49	21.05	20.79	21.11	20.67	20.41
		RB1#37	21.48	20.88	20.63	21.10	20.50	20.25
		RB1#74	20.09	19.98	19.47	19.71	19.60	19.09
		RB36#0	20.00	20.06	19.51	19.62	19.68	19.13
		RB36#18	20.07	20.08	19.53	19.69	19.70	19.15
		RB36#37	21.84	21.90	21.80	21.46	21.52	21.42
		RB75#0	21.92	21.99	21.45	21.54	21.61	21.07
20.0	QPSK	RB1#0	21.28	21.23	21.04	20.90	20.85	20.66
		RB1#49	21.67	21.65	21.46	21.29	21.27	21.08
		RB1#99	21.19	21.09	21.04	20.81	20.71	20.66
		RB50#0	20.55	20.46	20.57	20.17	20.08	20.19
		RB50#24	20.45	20.45	20.45	20.07	20.07	20.07
		RB50#49	20.53	20.45	20.51	20.15	20.07	20.13
		RB100#0	20.61	20.57	20.65	20.23	20.19	20.27
	16QAM	RB1#0	20.94	20.89	21.08	20.56	20.51	20.70
		RB1#49	20.60	20.33	20.61	20.22	19.95	20.23
		RB1#99	19.58	19.45	19.69	19.20	19.07	19.31
		RB50#0	19.48	19.56	19.57	21.46	21.52	21.42
		RB50#24	19.63	19.51	19.61	21.54	21.61	21.07
		RB50#49	21.28	21.23	21.04	21.41	21.41	20.94
		RB100#0	21.67	21.65	21.46	20.69	20.57	20.08

Note: EIRP(dBm) = Conducted Power(dBm) + Antenna Gain(dBi)  
For Band2: Antenna Gain = -0.38dBi  
Limit: EIRP ≤ 33dBm

**LTE Band 4**

Bandwidth (MHz)	Modulation	RB size/ RB Offset	Conducted Average Output Power (dBm)			EIRP(dBm)		
			Low	Mid	High	Low	Mid	High
1.4	QPSK	RB1#0	21.83	21.86	21.69	21.38	21.41	21.24
		RB1#3	21.97	22.01	21.99	21.52	21.56	21.54
		RB1#5	21.81	21.84	21.67	21.36	21.39	21.22
		RB3#0	21.95	21.94	21.88	21.50	21.49	21.43
		RB3#3	21.96	21.96	21.89	21.51	21.51	21.44
		RB6#0	20.92	20.92	20.82	20.47	20.47	20.37
	16QAM	RB1#0	20.91	21.03	20.82	20.46	20.58	20.37
		RB1#3	21.08	21.18	21.00	20.63	20.73	20.55
		RB1#5	20.92	21.00	20.85	20.47	20.55	20.40
		RB3#0	21.23	20.97	21.05	20.78	20.52	20.60
		RB3#3	21.24	21.01	21.02	20.79	20.56	20.57
		RB6#0	19.99	19.99	19.83	19.54	19.54	19.38
3.0	QPSK	RB1#0	21.84	21.86	21.82	21.39	21.41	21.37
		RB1#8	21.87	21.91	21.84	21.42	21.46	21.39
		RB1#14	21.83	21.82	21.75	21.38	21.37	21.30
		RB6#0	20.88	20.88	20.78	20.43	20.43	20.33
		RB6#9	20.90	20.81	20.77	20.45	20.36	20.32
		RB15#0	20.95	20.96	20.88	20.50	20.51	20.43
	16QAM	RB1#0	21.59	21.13	20.98	21.14	20.68	20.53
		RB1#8	21.63	21.08	20.94	21.18	20.63	20.49
		RB1#14	21.58	21.07	20.87	21.13	20.62	20.42
		RB6#0	19.98	19.92	19.81	19.53	19.47	19.36
		RB6#9	20.01	19.96	19.77	19.56	19.51	19.32
		RB15#0	20.07	19.96	19.97	19.62	19.51	19.52

Bandwidth (MHz)	Modulation	RB size/ RB Offset	Conducted Average Output Power (dBm)			EIRP(dBm)		
			Low	Mid	High	Low	Mid	High
5.0	QPSK	RB1#0	21.77	21.79	21.70	21.32	21.34	21.25
		RB1#13	22.00	21.94	21.84	21.55	21.49	21.39
		RB1#24	21.78	21.78	21.70	21.33	21.33	21.25
		RB15#0	20.98	20.90	20.92	20.53	20.45	20.47
		RB15#10	20.93	20.99	20.86	20.48	20.54	20.41
		RB25#0	20.93	20.89	20.89	20.48	20.44	20.44
	16QAM	RB1#0	20.80	21.17	20.88	20.35	20.72	20.43
		RB1#13	20.97	21.35	21.02	20.52	20.90	20.57
		RB1#24	20.77	21.10	20.90	20.32	20.65	20.45
		RB15#0	20.09	19.91	20.03	19.64	19.46	19.58
		RB15#10	20.03	19.99	19.94	19.58	19.54	19.49
		RB25#0	20.04	19.93	19.93	19.59	19.48	19.48
10.0	QPSK	RB1#0	21.86	21.86	21.83	21.41	21.41	21.38
		RB1#25	21.94	21.99	21.98	21.49	21.54	21.53
		RB1#49	21.86	21.86	21.79	21.41	21.41	21.34
		RB25#0	21.01	20.96	20.99	20.56	20.51	20.54
		RB25#25	21.01	20.99	20.89	20.56	20.54	20.44
		RB50#0	20.98	20.96	20.94	20.53	20.51	20.49
	16QAM	RB1#0	21.58	21.09	20.93	21.13	20.64	20.48
		RB1#25	21.72	21.27	21.04	21.27	20.82	20.59
		RB1#49	21.61	21.08	20.92	21.16	20.63	20.47
		RB25#0	20.12	20.01	20.11	19.67	19.56	19.66
		RB25#25	20.09	20.05	20.00	19.64	19.60	19.55
		RB50#0	20.05	20.00	19.98	19.62	19.51	19.52

Bandwidth (MHz)	Modulation	RB size/ RB Offset	Conducted Average Output Power (dBm)			EIRP(dBm)		
			Low	Mid	High	Low	Mid	High
15.0	QPSK	RB1#0	21.71	21.79	21.75	21.26	21.34	21.3
		RB1#38	21.86	21.96	21.89	21.41	21.51	21.44
		RB1#74	21.70	21.76	21.74	21.25	21.31	21.29
		RB36#0	20.96	20.95	21.01	20.51	20.50	20.56
		RB36#39	21.01	21.01	20.95	20.56	20.56	20.50
		RB75#0	20.96	20.97	20.94	20.51	20.52	20.49
	16QAM	RB1#0	21.47	20.96	21.19	21.02	20.51	20.74
		RB1#38	21.60	21.13	21.35	21.15	20.68	20.90
		RB1#74	21.48	20.97	21.25	21.03	20.52	20.80
		RB36#0	20.01	19.96	19.94	19.56	19.51	19.49
		RB36#39	20.02	20.04	19.92	19.57	19.59	19.47
		RB75#0	20.00	20.00	19.92	19.55	19.55	19.47
20.0	QPSK	RB1#0	21.55	21.57	21.48	21.10	21.12	21.03
		RB1#50	22.04	22.14	22.02	21.59	21.69	21.57
		RB1#99	21.60	21.63	21.46	21.15	21.18	21.01
		RB50#0	20.93	20.90	20.95	20.48	20.45	20.50
		RB50#50	20.97	20.96	20.83	20.52	20.51	20.38
		RB100#0	21.01	20.93	20.88	20.56	20.48	20.43
	16QAM	RB1#0	20.99	20.90	21.19	20.54	20.45	20.74
		RB1#50	21.43	21.35	21.63	20.98	20.90	21.18
		RB1#99	20.99	20.90	21.26	20.54	20.45	20.81
		RB50#0	19.97	19.89	19.92	19.52	19.44	19.47
		RB50#50	19.96	19.98	19.82	19.51	19.53	19.37
		RB100#0	20.01	19.95	19.88	19.56	19.50	19.43

Note: EIRP(dBm) = Conducted Power(dBm) + Antenna Gain(dBi)

For Band4: Antenna Gain = -0.45dBi

Limit: EIRP ≤ 30dBm

## LTE Band5

Bandwidth (MHz)	Modulation	RB size/ RB Offset	Conducted Average Output Power (dBm)			ERP(dBm)		
			Low	Mid	High	Low	Mid	High
1.4	QPSK	RB1#0	22.20	22.22	22.15	19.60	19.62	19.55
		RB1#3	22.39	22.43	22.38	19.79	19.83	19.78
		RB1#5	22.19	22.24	22.23	19.59	19.64	19.63
		RB3#0	22.32	22.32	22.33	19.72	19.72	19.73
		RB3#3	22.30	22.30	22.36	19.70	19.70	19.76
		RB6#0	21.26	21.29	21.29	18.66	18.69	18.69
	16QAM	RB1#0	21.24	21.36	21.22	18.64	18.76	18.62
		RB1#3	21.41	21.56	21.42	18.81	18.96	18.82
		RB1#5	21.27	21.37	21.26	18.67	18.77	18.66
		RB3#0	21.50	21.29	21.42	18.90	18.69	18.82
		RB3#3	21.52	21.33	21.40	18.92	18.73	18.80
		RB6#0	20.27	20.32	20.24	17.67	17.72	17.64
3.0	QPSK	RB1#0	22.23	22.30	22.26	19.63	19.70	19.66
		RB1#8	22.22	22.33	22.27	19.62	19.73	19.67
		RB1#14	22.22	22.28	22.25	19.62	19.68	19.65
		RB6#0	21.21	21.26	21.21	18.61	18.66	18.61
		RB6#9	21.21	21.25	21.24	18.61	18.65	18.64
		RB15#0	21.25	21.32	21.27	18.65	18.72	18.67
	16QAM	RB1#0	21.86	21.45	21.32	19.26	18.85	18.72
		RB1#8	21.82	21.41	21.28	19.22	18.81	18.68
		RB1#14	21.79	21.45	21.26	19.19	18.85	18.66
		RB6#0	20.31	20.28	20.19	17.71	17.68	17.59
		RB6#9	20.27	20.33	20.19	17.67	17.73	17.59
		RB15#0	20.33	20.29	20.35	17.73	17.69	17.75

Bandwidth (MHz)	Modulation	RB size/ RB Offset	Conducted Average Output Power (dBm)			ERP(dBm)		
			Low	Mid	High	Low	Mid	High
5.0	QPSK	RB1#0	22.17	22.22	22.20	19.57	19.62	19.6
		RB1#13	22.35	22.34	22.32	19.75	19.74	19.72
		RB1#24	22.20	22.21	22.19	19.60	19.61	19.59
		RB15#0	21.32	21.29	21.35	18.72	18.69	18.75
		RB15#10	21.32	21.35	21.30	18.72	18.75	18.70
		RB25#0	21.27	21.32	21.29	18.67	18.72	18.69
	16QAM	RB1#0	21.12	21.51	21.27	18.52	18.91	18.67
		RB1#13	21.22	21.61	21.41	18.62	19.01	18.81
		RB1#24	21.12	21.50	21.29	18.52	18.90	18.69
		RB15#0	20.36	20.31	20.38	17.76	17.71	17.78
		RB15#10	20.33	20.35	20.35	17.73	17.75	17.75
		RB25#0	20.34	20.33	20.36	17.74	17.73	17.76
10.0	QPSK	RB1#0	22.24	22.33	22.28	19.64	19.73	19.68
		RB1#25	22.39	22.41	22.44	19.79	19.81	19.84
		RB1#49	22.25	22.29	22.24	19.65	19.69	19.64
		RB25#0	21.27	21.35	21.42	18.67	18.75	18.82
		RB25#25	21.36	21.35	21.30	18.76	18.75	18.70
		RB50#0	21.34	21.32	21.36	18.74	18.72	18.76
	16QAM	RB1#0	21.88	21.42	21.29	19.28	18.82	18.69
		RB1#25	21.99	21.55	21.36	19.39	18.95	18.76
		RB1#49	21.85	21.44	21.29	19.25	18.84	18.69
		RB25#0	20.35	20.36	20.53	17.75	17.76	17.93
		RB25#25	20.44	20.37	20.41	17.84	17.77	17.81
		RB50#0	20.35	20.34	20.41	17.75	17.74	17.81

Note: ERP(dBm) = Conducted Power(dBm) + Antenna Gain(dBd)  
For Band5: Antenna Gain = -0.45dBi = -2.6dBd (0dBd=2.15dBi)  
Limit: ERP ≤ 38.45dBm

**LTE Band 7**

Bandwidth (MHz)	Modulation	RB size/ RB Offset	Conducted Average Output Power(dBm)			EIRP(dBm)		
			Low	Mid	High	Low	Mid	High
5.0	QPSK	RB1#0	21.74	22.00	21.00	21.46	21.72	20.72
		RB1#13	21.90	22.13	20.86	21.62	21.85	20.58
		RB1#24	21.80	22.01	20.69	21.52	21.73	20.41
		RB15#0	20.88	21.08	20.83	20.60	20.80	20.55
		RB15#10	20.93	21.06	20.75	20.65	20.78	20.47
		RB25#0	20.80	21.05	20.76	20.52	20.77	20.48
	16QAM	RB1#0	20.63	21.24	19.96	20.35	20.96	19.68
		RB1#13	20.76	21.38	19.97	20.48	21.10	19.69
		RB1#24	20.62	21.25	19.83	20.34	20.97	19.55
		RB15#0	19.88	20.06	19.94	19.60	19.78	19.66
		RB15#10	19.91	20.05	19.89	19.63	19.77	19.61
		RB25#0	19.88	20.02	19.92	19.60	19.74	19.64
10.0	QPSK	RB1#0	21.86	22.10	21.10	21.58	21.82	20.82
		RB1#25	22.08	22.29	20.89	21.80	22.01	20.61
		RB1#49	21.92	22.13	20.81	21.64	21.85	20.53
		RB25#0	20.88	21.11	20.91	20.60	20.83	20.63
		RB25#25	20.89	21.11	20.82	20.61	20.83	20.54
		RB50#0	20.94	21.13	20.85	20.66	20.85	20.57
	16QAM	RB1#0	21.33	21.22	19.98	21.05	20.94	19.70
		RB1#25	21.53	21.32	19.94	21.25	21.04	19.66
		RB1#49	21.37	21.24	19.90	21.09	20.96	19.62
		RB25#0	19.93	20.19	20.12	19.65	19.91	19.84
		RB25#25	20.00	20.13	20.05	19.72	19.85	19.77
		RB50#0	19.93	20.14	20.02	19.65	19.86	19.74



Bandwidth (MHz)	Modulation	RB size/ RB Offset	Conducted Average Output Power(dBm)			EIRP(dBm)		
			Low	Mid	High	Low	Mid	High
15.0	QPSK	RB1#0	21.77	21.97	21.27	21.49	21.69	20.99
		RB1#38	21.93	22.17	20.94	21.65	21.89	20.66
		RB1#74	21.85	22.07	20.91	21.57	21.79	20.63
		RB36#0	21.03	21.23	21.03	20.75	20.95	20.75
		RB36#39	21.05	21.23	20.93	20.77	20.95	20.65
		RB75#0	21.03	21.26	20.93	20.75	20.98	20.65
	16QAM	RB1#0	21.24	21.11	20.55	20.96	20.83	20.27
		RB1#38	21.43	21.24	20.37	21.15	20.96	20.09
		RB1#74	21.38	21.15	20.37	21.10	20.87	20.09
		RB36#0	19.92	20.16	20.12	19.64	19.88	19.84
		RB36#39	19.98	20.13	20.04	19.70	19.85	19.76
		RB75#0	20.01	20.17	20.07	19.73	19.89	19.79
20.0	QPSK	RB1#0	21.61	21.79	21.43	21.33	21.51	21.15
		RB1#50	22.14	22.31	20.99	21.86	22.03	20.71
		RB1#99	21.73	21.91	20.74	21.45	21.63	20.46
		RB50#0	20.93	21.05	21.15	20.65	20.77	20.87
		RB50#50	20.98	21.04	20.92	20.70	20.76	20.64
		RB100#0	20.91	21.06	21.01	20.63	20.78	20.73
	16QAM	RB1#0	20.91	21.02	20.91	20.63	20.74	20.63
		RB1#50	21.40	21.45	20.60	21.12	21.17	20.32
		RB1#99	21.03	21.08	20.40	20.75	20.80	20.12
		RB50#0	19.91	20.08	20.24	19.63	19.80	19.96
		RB50#50	19.95	20.05	20.06	19.67	19.77	19.78
		RB100#0	19.93	20.06	20.17	19.65	19.78	19.89

Note: ERP(dBm) = Conducted Power(dBm) + Antenna Gain(dBi)

For Band7: Antenna Gain = -0.28dBi

Limit: ERP ≤ 33dBm

## LTE Band 17

Bandwidth (MHz)	Modulation	RB size/ RB Offset	Conducted Average Output Power (dBm)			ERP(dBm)		
			Low	Mid	High	Low	Mid	High
5.0	QPSK	RB1#0	22.26	22.24	22.14	19.44	19.42	19.32
		RB1#13	22.37	22.34	22.30	19.55	19.52	19.48
		RB1#24	22.21	22.21	22.18	19.39	19.39	19.36
		RB15#0	21.39	21.26	21.33	18.57	18.44	18.51
		RB15#10	21.39	21.31	21.29	18.57	18.49	18.47
		RB25#0	21.37	21.27	21.25	18.55	18.45	18.43
	16QAM	RB1#0	21.18	21.53	21.27	18.36	18.71	18.45
		RB1#13	21.31	21.69	21.41	18.49	18.87	18.59
		RB1#24	21.15	21.50	21.28	18.33	18.68	18.46
		RB15#0	20.54	20.34	20.44	17.72	17.52	17.62
		RB15#10	20.53	20.37	20.37	17.71	17.55	17.55
		RB25#0	20.53	20.35	20.35	17.71	17.53	17.53
10.0	QPSK	RB1#0	22.28	22.34	22.31	19.46	19.52	19.49
		RB1#25	22.40	22.41	22.41	19.58	19.59	19.59
		RB1#49	22.28	22.28	22.30	19.46	19.46	19.48
		RB25#0	21.38	21.29	21.29	18.56	18.47	18.47
		RB25#25	21.35	21.30	21.29	18.53	18.48	18.47
		RB50#0	21.37	21.27	21.29	18.55	18.45	18.47
	16QAM	RB1#0	21.95	21.49	21.35	19.13	18.67	18.53
		RB1#25	22.08	21.57	21.40	19.26	18.75	18.58
		RB1#49	21.90	21.42	21.31	19.08	18.60	18.49
		RB25#0	20.55	20.40	20.46	17.73	17.58	17.64
		RB25#25	20.50	20.45	20.48	17.68	17.63	17.66
		RB50#0	20.45	20.38	20.39	17.63	17.56	17.57

Note: ERP(dBm) = Conducted Power(dBm) + Antenna Gain(dBd)  
For Band17: Antenna Gain = -0.67dBi = -2.82dBd (0dBd=2.15dBi)  
Limit: ERP ≤ 34.77dBm

**LTE Band 38**

Bandwidth (MHz)	Modulation	RB size/ RB Offset	Conducted Average Output Power (dBm)			EIRP(dBm)		
			Low	Mid	High	Low	Mid	High
5.0	QPSK	RB1#0	23.00	23.09	22.68	22.68	22.77	22.36
		RB1#13	23.10	23.19	22.65	22.78	22.87	22.33
		RB1#24	23.00	23.11	22.56	22.68	22.79	22.24
		RB15#0	22.07	22.07	22.08	21.75	21.75	21.76
		RB15#10	22.06	22.07	22.08	21.74	21.75	21.76
		RB25#0	22.11	22.09	22.06	21.79	21.77	21.74
	16QAM	RB1#0	22.20	21.99	21.73	21.88	21.67	21.41
		RB1#13	22.28	22.14	21.76	21.96	21.82	21.44
		RB1#24	22.23	22.04	21.68	21.91	21.72	21.36
		RB15#0	21.11	21.09	21.15	20.79	20.77	20.83
		RB15#10	21.11	21.07	21.12	20.79	20.75	20.80
		RB25#0	21.08	21.16	21.13	20.76	20.84	20.81
10.0	QPSK	RB1#0	23.03	23.19	22.95	22.71	22.87	22.63
		RB1#25	23.34	23.39	22.73	23.02	23.07	22.41
		RB1#49	23.00	23.23	22.81	22.68	22.91	22.49
		RB25#0	22.13	22.21	22.19	21.81	21.89	21.87
		RB25#25	22.12	22.21	22.16	21.80	21.89	21.84
		RB50#0	22.13	22.23	22.15	21.81	21.91	21.83
	16QAM	RB1#0	22.20	22.01	22.05	21.88	21.69	21.73
		RB1#25	22.50	22.34	21.87	22.18	22.02	21.55
		RB1#49	22.23	22.10	21.96	21.91	21.78	21.64
		RB25#0	21.16	21.26	21.26	20.84	20.94	20.94
		RB25#25	21.15	21.28	21.21	20.83	20.96	20.89
		RB50#0	21.14	21.26	21.19	20.82	20.94	20.87

Bandwidth (MHz)	Modulation	RB size/ RB Offset	Conducted Average Output Power (dBm)			EIRP(dBm)		
			Low	Mid	High	Low	Mid	High
15.0	QPSK	RB1#0	22.96	23.06	23.17	22.64	22.74	22.85
		RB1#38	23.08	23.26	22.97	22.76	22.94	22.65
		RB1#74	23.05	23.13	23.06	22.73	22.81	22.74
		RB36#0	22.15	22.25	22.29	21.83	21.93	21.97
		RB36#39	22.16	22.26	22.26	21.84	21.94	21.94
		RB75#0	22.20	22.30	22.25	21.88	21.98	21.93
	16QAM	RB1#0	22.11	21.99	22.33	21.79	21.67	22.01
		RB1#38	22.25	22.12	22.21	21.93	21.80	21.89
		RB1#74	22.26	22.01	22.25	21.94	21.69	21.93
		RB36#0	21.07	21.15	21.32	20.75	20.83	21.00
		RB36#39	21.12	21.18	21.25	20.80	20.86	20.93
		RB75#0	21.09	21.25	21.23	20.77	20.93	20.91
20.0	QPSK	RB1#0	22.82	22.86	23.00	22.50	22.54	22.68
		RB1#50	23.35	23.45	23.10	23.03	23.13	22.78
		RB1#99	22.93	22.94	22.93	22.61	22.62	22.61
		RB50#0	22.10	22.18	22.22	21.78	21.86	21.90
		RB50#50	22.15	22.17	22.11	21.83	21.85	21.79
		RB100#0	22.12	22.19	22.16	21.8	21.87	21.84
	16QAM	RB1#0	21.89	21.84	22.20	21.57	21.52	21.88
		RB1#50	22.37	22.42	22.37	22.05	22.10	22.05
		RB1#99	21.96	21.89	22.17	21.64	21.57	21.85
		RB50#0	21.10	21.27	21.25	20.78	20.95	20.93
		RB50#50	21.18	21.23	21.03	20.86	20.91	20.71
		RB100#0	21.12	21.21	21.11	20.8	20.89	20.79

Note: EIRP(dBm) = Conducted Power(dBm) + Antenna Gain(dBi)

For Band38: Antenna Gain = -0.32dBi

Limit: EIRP ≤ 33dBm

**LTE Band 41**

Bandwidth (MHz)	Modulation	RB size/ RB Offset	Conducted Average Output Power (dBm)			EIRP(dBm)		
			Low	Mid	High	Low	Mid	High
5.0	QPSK	RB1#0	22.76	22.91	22.76	22.44	22.59	22.44
		RB1#13	22.89	23.00	22.82	22.57	22.68	22.50
		RB1#24	22.80	22.86	22.72	22.48	22.54	22.40
		RB15#0	21.86	21.95	21.79	21.54	21.63	21.47
		RB15#10	21.85	21.92	21.80	21.53	21.60	21.48
		RB25#0	21.85	21.92	21.81	21.53	21.60	21.49
	16QAM	RB1#0	21.82	22.16	21.76	21.50	21.84	21.44
		RB1#13	21.96	22.24	21.87	21.64	21.92	21.55
		RB1#24	21.86	22.13	21.75	21.54	21.81	21.43
		RB15#0	20.96	21.09	20.85	20.64	20.77	20.53
		RB15#10	20.96	21.07	20.83	20.64	20.75	20.51
		RB25#0	20.98	21.00	20.90	20.66	20.68	20.58
10.0	QPSK	RB1#0	22.81	23.01	22.90	22.49	22.69	22.58
		RB1#25	23.20	23.29	23.16	22.88	22.97	22.84
		RB1#49	22.92	23.01	22.82	22.60	22.69	22.50
		RB25#0	21.91	22.06	21.90	21.59	21.74	21.58
		RB25#25	21.92	22.02	21.87	21.60	21.70	21.55
		RB50#0	21.96	22.01	21.93	21.64	21.69	21.61
	16QAM	RB1#0	22.11	21.90	21.99	21.79	21.58	21.67
		RB1#25	22.43	22.25	22.24	22.11	21.93	21.92
		RB1#49	22.15	21.88	21.92	21.83	21.56	21.60
		RB25#0	21.01	21.16	21.01	20.69	20.84	20.69
		RB25#25	21.03	21.14	20.96	20.71	20.82	20.64
		RB50#0	21.00	21.10	21.03	20.68	20.78	20.71

Bandwidth (MHz)	Modulation	RB size/ RB Offset	Conducted Average Output Power (dBm)			EIRP(dBm)		
			Low	Mid	High	Low	Mid	High
15.0	QPSK	RB1#0	22.78	22.94	22.82	22.46	22.62	22.50
		RB1#38	22.97	23.12	22.93	22.65	22.80	22.61
		RB1#74	22.90	22.90	22.77	22.58	22.58	22.45
		RB36#0	21.97	22.06	21.90	21.65	21.74	21.58
		RB36#39	21.99	22.00	21.83	21.67	21.68	21.51
		RB75#0	21.98	22.07	21.93	21.66	21.75	21.61
	16QAM	RB1#0	22.00	21.87	22.00	21.68	21.55	21.68
		RB1#38	22.21	22.05	22.13	21.89	21.73	21.81
		RB1#74	22.12	21.90	21.95	21.80	21.58	21.63
		RB36#0	20.97	21.06	21.00	20.65	20.74	20.68
		RB36#39	21.04	21.02	20.96	20.72	20.70	20.64
		RB75#0	20.99	21.09	20.98	20.67	20.77	20.66
20.0	QPSK	RB1#0	22.63	22.73	22.73	22.31	22.41	22.41
		RB1#50	23.23	23.26	23.26	22.91	22.94	22.94
		RB1#99	22.72	22.70	22.64	22.40	22.38	22.32
		RB50#0	22.01	22.04	21.89	21.69	21.72	21.57
		RB50#50	22.00	21.96	21.86	21.68	21.64	21.54
		RB100#0	22.02	22.02	21.86	21.70	21.70	21.54
	16QAM	RB1#0	21.74	21.75	21.96	21.42	21.43	21.64
		RB1#50	22.32	22.28	22.46	22.00	21.96	22.14
		RB1#99	21.82	21.75	21.89	21.50	21.43	21.57
		RB50#0	21.04	21.17	21.01	20.72	20.85	20.69
		RB50#50	21.08	21.13	20.96	20.76	20.81	20.64
		RB100#0	21.06	21.12	20.97	20.74	20.80	20.65

Note: EIRP(dBm) = Conducted Power(dBm) + Antenna Gain(dBi)  
For Band41: Antenna Gain = -0.32dBi  
Limit: EIRP ≤ 33dBm

**Peak-to-average ratio (PAR)****Cellular Band**

Mode	Channel	PAR (dB)	Limit(dB)
GSM	Low	3.48	13
	Middle	3.42	13
	High	3.51	13

Mode	Channel	PAR (dB)	Limit(dB)
EGPRS	Low	3.55	13
	Middle	3.71	13
	High	3.76	13

Mode	Channel	PAR (dB)	Limit (dB)
RMC	Low	3.52	13
	Middle	3.72	13
	High	3.43	13
HSDPA	Low	3.51	13
	Middle	3.57	13
	High	3.62	13
HSUPA	Low	3.44	13
	Middle	3.45	13
	High	3.58	13
HSPA+	Low	3.42	13
	Middle	3.54	13
	High	3.53	13

**PCS Band**

Mode	Channel	PAR (dB)	Limit(dB)
GSM	Low	3.52	13
	Middle	3.57	13
	High	3.49	13

Mode	Channel	PAR (dB)	Limit(dB)
EGPRS	Low	3.52	13
	Middle	3.57	13
	High	3.53	13

Mode	Channel	PAR (dB)	Limit (dB)
RMC	Low	3.47	13
	Middle	3.57	13
	High	3.53	13
HSDPA	Low	3.57	13
	Middle	3.56	13
	High	3.48	13
HSUPA	Low	3.46	13
	Middle	3.45	13
	High	3.51	13
HSPA+	Low	3.40	13
	Middle	3.53	13
	High	3.49	13

#### LTE Band 2 20MHz Bandwidth

Modulation	Low channel (dB)	Middle channel (dB)	High channel (dB)	PAR Limit (dB)	Result
QPSK (1RB Size)	8.60	8.60	8.64	13	Pass
QPSK (100RB Size)	8.64	8.49	8.58	13	Pass
16QAM (1RB Size)	8.43	8.41	8.60	13	Pass
16QAM (100RB Size)	8.67	8.35	8.43	13	Pass

#### LTE Band 4 20MHz Bandwidth

Modulation	Low channel (dB)	Middle channel (dB)	High channel (dB)	PAR Limit (dB)	Result
QPSK (1RB Size)	8.64	8.55	8.46	13	Pass
QPSK (100RB Size)	8.58	8.46	8.60	13	Pass
16QAM (1RB Size)	8.55	8.64	8.49	13	Pass
16QAM (100RB Size)	8.64	8.41	8.69	13	Pass



**LTE Band 5 10MHz Bandwidth**

Modulation	Low channel (dB)	Middle channel (dB)	High channel (dB)	PAR Limit (dB)	Result
QPSK (1RB Size)	8.75	8.55	8.43	13	Pass
QPSK (50RB Size)	8.43	8.49	8.49	13	Pass
16QAM (1RB Size)	8.52	8.60	8.55	13	Pass
16QAM (50RB Size)	8.49	8.55	8.60	13	Pass

**LTE Band 7 20MHz Bandwidth**

Modulation	Low channel (dB)	Middle channel (dB)	High channel (dB)	PAR Limit (dB)	Result
QPSK (1RB Size)	8.41	8.67	8.60	13	Pass
QPSK (100RB Size)	8.60	8.58	8.64	13	Pass
16QAM (1RB Size)	8.67	8.64	8.55	13	Pass
16QAM (100RB Size)	8.58	8.58	8.58	13	Pass

**LTE Band 17 10MHz Bandwidth**

Modulation	Low channel (dB)	Middle channel (dB)	High channel (dB)	PAR Limit (dB)	Result
QPSK (1RB Size)	8.55	8.69	8.60	13	Pass
QPSK (50RB Size)	8.35	8.58	8.69	13	Pass
16QAM (1RB Size)	8.55	8.60	8.64	13	Pass
16QAM (50RB Size)	8.52	8.64	8.58	13	Pass

**LTE Band 38 20MHz Bandwidth**

Modulation	Low channel (dB)	Middle channel (dB)	High channel (dB)	PAR Limit (dB)	Result
QPSK (1RB Size)	9.00	8.88	8.26	13	Pass
QPSK (100RB Size)	6.55	7.13	8.12	13	Pass
16QAM (1RB Size)	8.62	7.25	7.87	13	Pass
16QAM (100RB Size)	8.10	8.35	9.44	13	Pass

**LTE Band 41 20MHz Bandwidth**

Modulation	Low channel (dB)	Middle channel (dB)	High channel (dB)	PAR Limit (dB)	Result
QPSK (1RB Size)	8.58	8.64	8.60	13	Pass
QPSK (100RB Size)	8.67	8.41	8.52	13	Pass
16QAM (1RB Size)	8.60	8.72	8.55	13	Pass
16QAM (100RB Size)	8.64	8.49	8.58	13	Pass

## FCC §2.1049, §22.917, §22.905 & §24.238&§27.53- OCCUPIED BANDWIDTH

### Applicable Standard

FCC 47 §2.1049, §22.917, §22.905, §24.238,§27.53.

### Test Procedure

The RF output of the transmitter was connected to the simulator and the spectrum analyzer through sufficient attenuation.

The resolution bandwidth of the spectrum analyzer was set at 1% to 5% of the anticipated emission bandwidth and the 26 dB & 99% bandwidth was recorded.

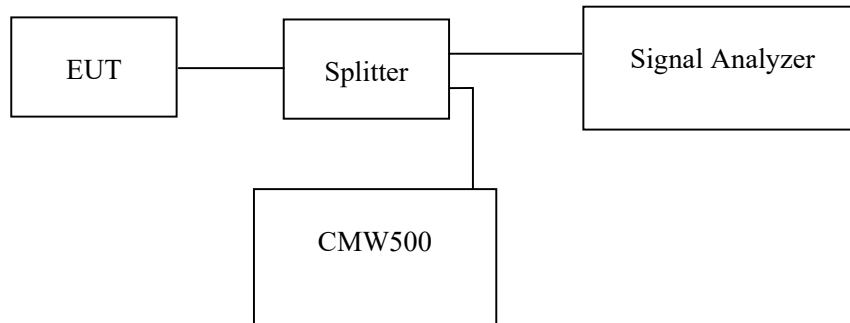

### Test Data

#### Environmental Conditions

<b>Temperature:</b>	27.6°C
<b>Relative Humidity:</b>	58 %
<b>ATM Pressure:</b>	101.0kPa

*The testing was performed by Black Ding from 2021-10-27 to 2021-11-28.*

*EUT operation mode: Transmitting*

**Test Result: Pass**

**Cellular Band (Part 22H)**

Mode	Channel	Frequency (MHz)	99% Occupied Bandwidth (kHz)	26 dB Emission Bandwidth (kHz)
GSM (GMSK)	128	824.2	244.57	318.40
	190	836.6	243.13	319.80
	251	848.8	243.13	319.80
EGPRS(8PSK)	128	824.2	241.52	319.40
	190	836.6	251.81	322.70
	251	848.8	250.36	322.70

	Frequency (MHz)	Occupied Bandwidth (MHz)	26dB Bandwidth (MHz)
RMC	826.4	4.17	4.72
	836.6	4.17	4.70
	846.6	4.15	4.73
HSDPA	826.4	4.20	4.83
	836.6	4.17	4.72
	846.6	4.21	4.94
HSUPA	826.4	4.18	4.94
	836.6	4.17	4.70
	846.6	4.21	5.34

**PCS Band (Part 24E)**

Mode	Channel	Frequency (MHz)	99% Occupied Bandwidth (kHz)	26 dB Emission Bandwidth (kHz)
GSM (GMSK)	512	1850.2	244.57	321.30
	661	1880.0	244.57	321.30
	810	1909.8	243.13	319.80
EGPRS(8PSK)	512	1850.2	251.81	322.70
	661	1880.0	251.81	322.70
	810	1909.8	250.36	322.70

	Frequency (MHz)	Occupied Bandwidth (MHz)	26dB Bandwidth (MHz)
RMC	1852.4	4.20	4.89
	1880.0	4.18	4.94
	1907.6	4.17	4.70
HSDPA	1852.4	4.18	4.94
	1880.0	4.18	4.75
	1907.6	4.18	4.70
HSUPA	1852.4	4.20	4.81
	1880.0	4.17	4.70
	1907.6	4.17	4.70

**LTE Mode:****LTE Band 2:**

Bandwidth	Modulation	Low channel		Middle channel		High channel	
		OBW (MHz)	26dB EBW (MHz)	OBW (MHz)	26dB EBW (MHz)	OBW (MHz)	26dB EBW (MHz)
1.4 MHz	QPSK	1.096	1.296	1.102	1.326	1.102	1.290
	16QAM	1.096	1.320	1.090	1.290	1.096	1.296
3 MHz	QPSK	2.683	2.880	2.695	2.880	2.683	2.892
	16QAM	2.683	2.892	2.683	2.880	2.683	2.880
5 MHz	QPSK	4.511	4.960	4.511	4.980	4.491	4.940
	16QAM	4.491	4.940	4.531	5.840	4.491	4.980
10 MHz	QPSK	8.942	9.680	8.942	9.600	8.942	9.600
	16QAM	8.942	9.560	8.942	9.560	8.942	9.680
15 MHz	QPSK	13.533	14.820	13.473	14.640	13.473	14.640
	16QAM	13.473	14.640	13.533	14.700	13.473	14.640
20 MHz	QPSK	17.964	19.200	17.964	19.280	17.964	19.520
	16QAM	17.964	19.360	17.964	19.280	17.964	19.280

**LTE Band 4:**

Bandwidth	Modulation	Low channel		Middle channel		High channel	
		OBW (MHz)	26dB EBW (MHz)	OBW (MHz)	26dB EBW (MHz)	OBW (MHz)	26dB EBW (MHz)
1.4 MHz	QPSK	1.096	1.302	1.096	1.320	1.102	1.290
	16QAM	1.108	1.326	1.090	1.290	1.102	1.302
3 MHz	QPSK	2.683	2.880	2.683	2.880	2.683	2.892
	16QAM	2.683	2.916	2.683	2.880	2.683	2.880
5 MHz	QPSK	4.511	5.060	4.511	4.940	4.511	5.400
	16QAM	4.491	4.940	4.511	5.140	4.551	5.400
10 MHz	QPSK	8.942	9.680	8.942	9.720	8.942	9.840
	16QAM	8.942	9.560	8.942	9.600	8.942	9.640
15 MHz	QPSK	13.533	14.760	13.413	14.640	13.533	14.880
	16QAM	13.533	14.700	13.533	15.060	13.533	14.880
20 MHz	QPSK	17.884	19.200	17.884	19.280	17.964	19.520
	16QAM	17.884	19.280	17.884	19.200	17.884	19.280

**LTE Band 5:**

Bandwidth	Modulation	Low channel		Middle channel		High channel	
		OBW (MHz)	26dB EBW (MHz)	OBW (MHz)	26dB EBW (MHz)	OBW (MHz)	26dB EBW (MHz)
1.4 MHz	QPSK	1.096	1.290	1.108	1.350	1.102	1.290
	16QAM	1.102	1.326	1.102	1.410	1.090	1.296
3 MHz	QPSK	2.683	2.880	2.683	2.904	2.683	2.892
	16QAM	2.683	2.892	2.683	2.928	2.683	2.868
5 MHz	QPSK	4.511	4.960	4.511	4.960	4.491	4.940
	16QAM	4.491	4.940	4.511	4.960	4.511	4.980
10 MHz	QPSK	8.942	9.720	8.942	9.560	8.942	9.680
	16QAM	8.942	9.600	8.942	9.640	8.981	9.640

**LTE Band 7:**

Bandwidth	Modulation	Low channel		Middle channel		High channel	
		OBW (MHz)	26dB EBW (MHz)	OBW (MHz)	26dB EBW (MHz)	OBW (MHz)	26dB EBW (MHz)
5 MHz	QPSK	4.511	4.940	4.511	4.980	4.491	4.940
	16QAM	4.491	4.940	4.511	4.960	4.511	5.180
10 MHz	QPSK	8.942	9.720	8.942	9.600	8.942	9.680
	16QAM	8.942	9.520	8.942	9.680	8.942	9.600
15 MHz	QPSK	13.533	14.760	13.413	14.640	13.533	14.760
	16QAM	13.473	14.640	13.473	14.700	13.533	14.700
20 MHz	QPSK	17.884	19.200	17.884	19.280	17.964	19.280
	16QAM	17.964	19.120	17.884	19.280	17.884	19.280

**LTE Band 17**

Bandwidth	Modulation	Low channel		Middle channel		High channel	
		OBW (MHz)	26dB EBW (MHz)	OBW (MHz)	26dB EBW (MHz)	OBW (MHz)	26dB EBW (MHz)
5 MHz	QPSK	4.551	5.240	4.511	5.220	4.511	5.160
	16QAM	4.511	5.180	4.531	5.260	4.531	5.240
10 MHz	QPSK	8.942	9.960	8.942	9.800	8.942	9.920
	16QAM	8.942	9.760	8.942	9.880	8.942	9.840

**LTE Band 38**

Bandwidth	Modulation	Low channel		Middle channel		High channel	
		OBW (MHz)	26dB EBW (MHz)	OBW (MHz)	26dB EBW (MHz)	OBW (MHz)	26dB EBW (MHz)
5 MHz	QPSK	4.511	5.220	4.511	5.040	4.511	5.060
	16QAM	4.511	5.020	4.511	5.320	4.511	5.220
10 MHz	QPSK	8.982	9.720	8.942	9.640	8.982	9.840
	16QAM	8.942	9.520	8.942	9.560	8.942	9.800
15 MHz	QPSK	13.533	14.640	13.473	15.240	13.473	14.700
	16QAM	13.533	14.700	13.533	15.180	13.533	15.480
20 MHz	QPSK	17.964	19.520	17.884	19.280	17.964	19.600
	16QAM	17.884	19.200	17.884	19.600	17.884	19.520

**LTE Band 41**

Bandwidth	Modulation	Low channel		Middle channel		High channel	
		OBW (MHz)	26dB EBW (MHz)	OBW (MHz)	26dB EBW (MHz)	OBW (MHz)	26dB EBW (MHz)
5 MHz	QPSK	4.511	5.360	4.511	5.040	4.511	5.000
	16QAM	4.511	5.140	4.511	5.300	4.511	5.000
10 MHz	QPSK	8.942	9.640	8.942	9.680	8.942	9.720
	16QAM	8.942	9.600	8.942	9.600	8.942	10.320
15 MHz	QPSK	13.533	15.420	13.413	14.640	13.473	14.700
	16QAM	13.533	15.540	13.533	15.900	13.533	16.380
20 MHz	QPSK	17.964	19.200	17.884	19.280	17.884	19.280
	16QAM	17.964	19.600	17.964	20.160	17.884	19.200

*Test plots refer to the Appendix A.*

## FCC §2.1051, §22.917(a), §24.238(a), §27.53 - SPURIOUS EMISSIONS AT ANTENNA TERMINALS

### Applicable Standard

FCC §2.1051, §22.917(a) and §24.238(a)and§27.53.

The spectrum was to be investigated to the tenth harmonics of the highest fundamental frequency as specified in § 2.1051.

### Test Procedure

The RF output of the transceiver was connected to a spectrum analyzer and simulator through appropriate attenuation. The resolution bandwidth of the spectrum analyzer was set at 1MHz. Sufficient scans were taken to show any out of band emissions up to 10<sup>th</sup> harmonic.

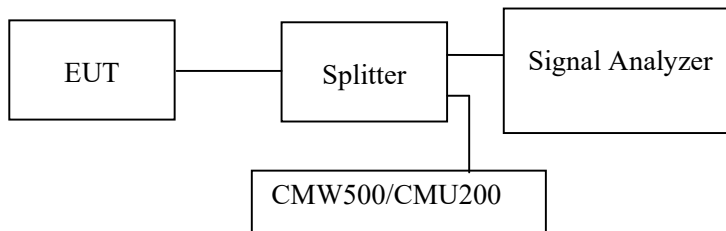

### Test Data

#### Environmental Conditions

<b>Temperature:</b>	28.2~29.0°C
<b>Relative Humidity:</b>	44~56 %
<b>ATM Pressure:</b>	101.0kPa

*The testing was performed by Black Ding from 2021-10-27 to 2021-11-28.*

*EUT operation mode: Transmitting*

#### Test result: Pass

*Test plots refer to the Appendix B.*



## FCC §2.1051, §22.917(a), §24.238(a), §27.53, §90.691 - SPURIOUS EMISSIONS AT ANTENNA TERMINALS

### Applicable Standard

FCC §2.1051, §22.917(a) and §24.238(a) and §27.53 and §90.691

The spectrum was to be investigated to the tenth harmonics of the highest fundamental frequency as specified in § 2.1051.

### Test Procedure

The RF output of the transceiver was connected to a spectrum analyzer and simulator through appropriate attenuation. The resolution bandwidth of the spectrum analyzer was set at 1MHz. Sufficient scans were taken to show any out of band emissions up to 10<sup>th</sup> harmonic.

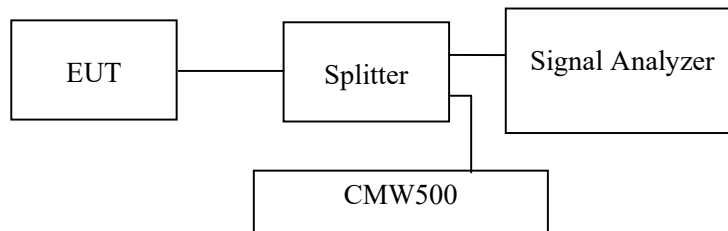

### Test Data

#### Environmental Conditions

<b>Temperature:</b>	26.5~27°C
<b>Relative Humidity:</b>	54~56 %
<b>ATM Pressure:</b>	101.0kPa

*The testing was performed by Chao Moon 2021-11-01 for Below 1GHz and 2021-11-02 for above 1GHz.*

*EUT operation mode:*

Transmitting (Pre-scan in the X,Y and Z axes of orientation, the worst case X-axis of orientation was recorded)

*The worst case is as below:*

**30 MHz ~ 10 GHz:****Cellular Band**

Frequency (MHz)	Receiver Reading (dBm)	Turntable Degree	Rx Antenna		Substituted Factor (dB)	Absolute Level (dBm)	Limit (dBm)	Margin (dB)
			Height (m)	Polar (H/V)				
GSM Mode								
Low channel								
955.1	-79.25	87	1.2	H	11.79	-67.46	-13	-54.46
955.1	-76.24	54	1.1	V	12.48	-63.76	-13	-50.76
1648.4	-45.47	336	2.1	H	-2.73	-48.20	-13	-35.20
1648.4	-44.31	328	1.6	V	-2.79	-47.10	-13	-34.10
2472.6	-40.28	277	1.6	H	1.18	-39.10	-13	-26.10
2472.6	-37.81	106	1	V	1.21	-36.60	-13	-23.60
3296.8	-44.94	316	1.8	H	3.24	-41.70	-13	-28.70
3296.8	-42.87	64	1	V	3.27	-39.60	-13	-26.60
Middle Channel								
955.1	-79.35	34	2.3	H	11.79	-67.56	-13	-54.56
955.1	-76.24	112	2.3	V	12.48	-63.76	-13	-50.76
1673.2	-41.23	12	1.4	H	-2.67	-43.90	-13	-30.90
1673.2	-39.86	213	1.8	V	-2.74	-42.60	-13	-29.60
2509.8	-38.72	147	2.3	H	1.32	-37.40	-13	-24.40
2509.8	-35.86	123	1.7	V	1.36	-34.50	-13	-21.50
3346.4	-44.41	281	1.3	H	3.31	-41.10	-13	-28.10
3346.4	-41.82	316	1.3	V	3.32	-38.50	-13	-25.50
High Channel								
955.1	-79.44	323	2.1	H	11.79	-67.65	-13	-54.65
955.1	-76.34	59	1.4	V	12.48	-63.86	-13	-50.86
1697.6	-37.26	205	1.4	H	-2.64	-39.90	-13	-26.90
1697.6	-35.61	184	2.0	V	-2.69	-38.30	-13	-25.30
2546.4	-37.47	76	1.5	H	1.47	-36.00	-13	-23.00
2546.4	-35.42	220	1.2	V	1.52	-33.90	-13	-20.90
3395.2	-44.08	116	2.2	H	3.38	-40.70	-13	-27.70
3395.2	-41.77	331	2.4	V	3.37	-38.40	-13	-25.40

Frequency (MHz)	Receiver Reading (dBm)	Turntable Degree	Rx Antenna		Substituted Factor (dB)	Absolute Level (dBm)	Limit (dBm)	Margin (dB)
			Height (m)	Polar (H/V)				
WCDMA Mode								
Low channel								
951.23	-78.60	206	2.4	H	11.79	-66.81	-13	-53.81
951.23	-78.18	102	1.4	V	12.48	-65.70	-13	-52.70
1652.80	-49.07	111	1.3	H	-2.73	-51.80	-13	-38.80
1652.80	-47.91	153	2.3	V	-2.79	-50.70	-13	-37.70
2479.20	-51.48	95	2.2	H	1.18	-50.30	-13	-37.30
2479.20	-50.41	284	2.1	V	1.21	-49.20	-13	-36.20
3305.60	-49.54	6	1.3	H	3.24	-46.30	-13	-33.30
3305.60	-49.17	106	1.5	V	3.27	-45.90	-13	-32.90
Middle Channel								
951.23	-79.07	182	2.3	H	11.79	-67.28	-13	-54.28
951.23	-78.15	54	1.2	V	12.48	-65.67	-13	-52.67
1673.20	-43.53	232	1	H	-2.67	-46.20	-13	-33.20
1673.20	-46.66	234	2.1	V	-2.74	-49.40	-13	-36.40
2509.80	-47.02	86	1.7	H	1.32	-45.70	-13	-32.70
2509.80	-46.76	194	1.1	V	1.36	-45.40	-13	-32.40
3346.40	-48.91	275	1.2	H	3.31	-45.60	-13	-32.60
3346.40	-48.42	335	2.1	V	3.32	-45.10	-13	-32.10
High Channel								
951.23	-78.92	5	1.7	H	11.79	-67.13	-13	-54.13
951.23	-78.45	266	1.2	V	12.48	-65.97	-13	-52.97
1693.20	-46.86	243	1.5	H	-2.64	-49.50	-13	-36.50
1693.20	-46.71	90	2.1	V	-2.69	-49.40	-13	-36.40
2539.80	-51.97	174	1.0	H	1.47	-50.50	-13	-37.50
2539.80	-51.02	31	1.9	V	1.52	-49.50	-13	-36.50
3386.40	-49.38	337	2.5	H	3.38	-46.00	-13	-33.00
3386.40	-48.77	264	2.2	V	3.37	-45.40	-13	-32.40

## 30 MHz ~ 20 GHz:

## PCS Band

Frequency (MHz)	Receiver Reading (dBm)	Turntable Degree	Rx Antenna		Substituted Factor (dB)	Absolute Level (dBm)	Limit (dBm)	Margin (dB)
			Height (m)	Polar (H/V)				
GSM Mode								
Low channel								
955.1	-79.06	53	2.5	H	11.79	-67.27	-13	-54.27
955.1	-78.43	152	2.1	V	12.48	-65.95	-13	-52.95
3700.4	-38.76	277	2.2	H	4.96	-33.80	-13	-20.80
3700.4	-36.99	254	1.2	V	4.59	-32.40	-13	-19.40
Middle Channel								
955.1	-78.51	318	2.2	H	11.79	-66.72	-13	-53.72
955.1	-77.72	345	1.9	V	12.48	-65.24	-13	-52.24
3760	-37.61	326	2	H	5.31	-32.30	-13	-19.30
3760	-39.53	63	1.2	V	4.93	-34.60	-13	-21.60
High Channel								
955.1	-77.92	308	1.9	H	11.79	-66.13	-13	-53.13
955.1	-78.25	208	2.2	V	12.48	-65.77	-13	-52.77
3819.6	-38.24	350	1.1	H	5.64	-32.60	-13	-19.60
3819.6	-37.97	304	1.5	V	5.27	-32.70	-13	-19.70
WCDMA Mode								
Low channel								
951.23	-78.74	17	1	H	11.79	-66.95	-13	-53.95
951.23	-77.86	253	1.4	V	12.48	-65.38	-13	-52.38
3704.80	-50.96	225	1.7	H	4.96	-46.00	-13	-33.00
3704.80	-50.59	119	2.3	V	4.59	-46.00	-13	-33.20
Middle channel								
951.23	-78.06	334	1.6	H	11.79	-66.27	-13	-53.27
951.23	-78.88	144	1.1	V	12.48	-66.40	-13	-53.40
3760.00	-50.51	338	1.6	H	5.31	-45.20	-13	-32.20
3760.00	-50.43	180	1.5	V	4.93	-45.50	-13	-32.50
High channel								
951.23	-78.82	211	2.5	H	11.79	-67.03	-13	-54.03
951.23	-77.98	162	1	V	12.48	-65.50	-13	-52.50
3815.20	-48.84	357	2.1	H	5.64	-43.20	-13	-30.20
3815.20	-48.97	110	2.3	V	5.27	-43.70	-13	-30.70

**LTE Band:** (Pre-scan with all the bandwidth, and worst case as below)

Frequency (MHz)	Receiver Reading (dBm)	Turntable Degree	Rx Antenna		Substituted Factor (dB)	Absolute Level (dBm)	Limit (dBm)	Margin (dB)
			Height (m)	Polar (H/V)				
Band 2								
Test frequency range: 30MHz-20GHz								
1.4MHz bandwidth, low channel								
950.45	-79.07	325	2.2	H	11.79	-67.28	-13	-54.28
950.45	-77.60	124	2.5	V	12.48	-65.12	-13	-52.12
3701.40	-46.76	290	1.9	H	4.96	-41.80	-13	-28.80
3701.40	-48.39	183	1.8	V	4.59	-43.80	-13	-30.80
5552.10	-53.93	88	1.5	H	10.63	-43.30	-13	-30.30
5552.10	-52.78	254	1.4	V	8.98	-43.80	-13	-30.80
7402.80	-44.44	303	1.9	H	14.06	-41.20	-13	-28.20
7402.80	-46.17	149	2.3	V	14.69	-42.90	-13	-29.90
1.4MHz bandwidth, middle channel								
950.45	-78.24	56	2.2	H	11.79	-66.45	-13	-53.45
950.45	-78.55	70	1.6	V	12.48	-66.07	-13	-53.07
3760.00	-45.11	85	1.8	H	5.31	-39.80	-13	-26.80
3760.00	-46.23	106	1.8	V	4.93	-41.30	-13	-28.30
5640.00	-53.88	11	1.6	H	10.68	-43.20	-13	-30.20
5640.00	-53.34	22	1.4	V	9.24	-44.10	-13	-31.10
7520.00	-45.51	116	1.9	H	14.38	-42.20	-13	-29.20
7520.00	-45.12	212	1.5	V	15.16	-41.80	-13	-28.80
1.4MHz bandwidth, high channel								
950.45	-79.24	88	2.3	H	11.79	-67.45	-13	-54.45
950.45	-77.97	342	1.9	V	12.48	-65.49	-13	-52.49
3818.60	-46.14	338	1.8	H	5.64	-40.50	-13	-27.50
3818.60	-46.97	268	1.2	V	5.27	-41.70	-13	-28.70
5727.90	-54.93	121	1.6	H	10.73	-44.20	-13	-31.20
5727.90	-54.01	18	2	V	9.51	-44.50	-13	-31.50
7637.20	-57.71	48	1.8	H	14.71	-43.00	-13	-30.00
7637.20	-58.64	68	1.5	V	15.34	-43.30	-13	-30.30

Frequency (MHz)	Receiver Reading (dBm)	Turntable Degree	Rx Antenna		Substituted Factor (dB)	Absolute Level (dBm)	Limit (dBm)	Margin (dB)
			Height (m)	Polar (H/V)				
Band 4								
Test frequency range: 30MHz-20GHz								
1.4MHz bandwidth, low channel								
950.45	-79.28	120	1.4	H	11.79	-67.49	-13	-54.49
950.45	-78.72	233	2.4	V	12.48	-66.24	-13	-53.24
3421.40	-46.23	347	2.1	H	3.43	-42.80	-13	-29.80
3421.40	-45.40	252	1.9	V	3.4	-42.00	-13	-29.00
5132.10	-54.62	148	2.4	H	9.72	-44.90	-13	-31.90
5132.10	-53.18	56	1.1	V	8.38	-44.80	-13	-31.80
6842.80	-49.39	348	1.1	H	7.09	-42.30	-13	-29.30
6842.80	-50.56	32	1	V	7.16	-43.40	-13	-30.40
1.4MHz bandwidth, middle channel								
950.45	-78.31	314	1.5	H	11.79	-66.52	-13	-53.52
950.45	-77.96	212	2	V	12.48	-65.48	-13	-52.48
3465.00	-46.09	186	1.9	H	3.49	-42.60	-13	-29.60
3465.00	-46.55	21	1.6	V	3.45	-43.10	-13	-30.10
5197.50	-54.14	253	1.2	H	9.84	-44.30	-13	-31.30
5197.50	-52.01	192	2.3	V	8.41	-43.60	-13	-30.60
6930.00	-49.59	297	1.1	H	7.09	-42.50	-13	-29.50
6930.00	-49.46	8	1.5	V	7.16	-42.30	-13	-29.30
1.4MHz bandwidth, high channel								
950.45	-77.86	228	1.3	H	11.79	-66.07	-13	-53.07
950.45	-77.99	288	1.9	V	12.48	-65.51	-13	-52.51
3508.60	-44.95	65	1.7	H	3.55	-41.40	-13	-28.40
3508.60	-45.00	11	1.4	V	3.5	-41.50	-13	-28.50
5262.90	-54.56	134	2	H	9.96	-44.60	-13	-31.60
5262.90	-52.24	118	2	V	8.44	-43.80	-13	-30.80
7017.20	-51.19	59	2	H	7.09	-44.10	-13	-31.10
7017.20	-50.56	217	2.4	V	7.16	-43.40	-13	-30.40

Frequency (MHz)	Receiver Reading (dBm)	Turntable Degree	Rx Antenna		Substituted Factor (dB)	Absolute Level (dBm)	Limit (dBm)	Margin (dB)
			Height (m)	Polar (H/V)				
Band 5								
Test frequency range: 30MHz-10GHz								
1.4MHz bandwidth, low channel								
950.45	-78.46	275	1.3	H	11.79	-66.67	-13	-53.67
950.45	-78.07	174	2.5	V	12.48	-65.59	-13	-52.59
1649.40	-48.37	171	1.9	H	-2.73	-51.10	-13	-38.10
1649.40	-49.91	190	2.1	V	-2.79	-52.70	-13	-39.70
2474.10	-35.98	147	1.9	H	1.18	-34.80	-13	-21.80
2474.10	-37.51	319	1.8	V	1.21	-36.30	-13	-23.30
3298.80	-49.24	359	2.2	H	3.24	-46.00	-13	-33.00
3298.80	-49.87	322	2.5	V	3.27	-46.60	-13	-33.60
1.4MHz bandwidth, middle channel								
950.45	-78.06	212	2.3	H	11.79	-66.27	-13	-53.27
950.45	-78.82	294	2.1	V	12.48	-66.34	-13	-53.34
1673.00	-43.73	12	1.5	H	-2.67	-46.40	-13	-33.40
1673.00	-46.56	36	1.1	V	-2.74	-49.30	-13	-36.30
2509.50	-52.62	133	1.2	H	1.32	-51.30	-13	-38.30
2509.50	-51.66	116	1.4	V	1.36	-50.30	-13	-37.30
3346.00	-49.31	167	1.3	H	3.31	-46.00	-13	-33.00
3346.00	-48.92	296	1.3	V	3.32	-45.60	-13	-32.60
1.4MHz bandwidth, high channel								
950.45	-78.32	196	1.9	H	11.79	-66.53	-13	-53.53
950.45	-77.88	113	2.3	V	12.48	-65.40	-13	-52.40
1696.60	-48.46	135	1.2	H	-2.64	-51.10	-13	-38.10
1696.60	-46.01	205	2.4	V	-2.69	-48.70	-13	-35.70
2544.90	-52.57	97	1.1	H	1.47	-51.10	-13	-38.10
2544.90	-50.72	151	2.0	V	1.52	-49.20	-13	-36.20
3393.20	-48.88	220	2.0	H	3.38	-45.50	-13	-32.50
3393.20	-48.27	314	1.9	V	3.37	-44.90	-13	-31.90

Frequency (MHz)	Receiver Reading (dBm)	Turntable Degree	Rx Antenna		Substituted Factor (dB)	Absolute Level (dBm)	Limit (dBm)	Margin (dB)
			Height (m)	Polar (H/V)				
Band 7								
Test frequency range: 30MHz-26.5GHz								
5MHz bandwidth, low channel								
950.45	-78.92	133	2.5	H	11.79	-67.13	-25	-42.13
950.45	-75.81	214	1.3	V	12.48	-63.33	-25	-38.33
5005.00	-53.60	143	1.2	H	9.5	-44.10	-25	-19.10
5005.00	-51.92	135	2.4	V	8.32	-43.60	-25	-18.60
7507.50	-57.38	241	1.1	H	14.38	-43.00	-25	-18.00
7507.50	-57.16	208	1.5	V	15.16	-42.00	-25	-17.00
5MHz bandwidth, middle channel								
950.45	-78.06	65	2	H	11.79	-66.27	-25	-41.27
950.45	-76.60	357	2.3	V	12.48	-64.12	-25	-39.12
5070.00	-53.56	278	1.5	H	9.56	-44.00	-25	-19.00
5070.00	-52.24	161	1	V	8.34	-43.90	-25	-18.90
7605.00	-59.81	64	1.8	H	14.71	-45.10	-25	-20.10
7605.00	-60.04	240	1.1	V	15.34	-44.70	-25	-19.70
5MHz bandwidth, high channel								
950.45	-78.95	126	1.1	H	11.79	-67.16	-25	-42.16
950.45	-75.64	10	1	V	12.48	-63.16	-25	-38.16
5135.00	-53.42	244	2	H	9.72	-43.70	-25	-18.70
5135.00	-51.78	346	1.8	V	8.38	-43.40	-25	-18.40
7702.50	-59.93	102	2.4	H	15.03	-44.90	-25	-19.90
7702.50	-60.11	159	1.9	V	15.51	-44.60	-25	-19.60



Frequency (MHz)	Receiver Reading (dBm)	Turntable Degree	Rx Antenna		Substituted Factor (dB)	Absolute Level (dBm)	Limit (dBm)	Margin (dB)
			Height (m)	Polar (H/V)				
Band 17								
Test frequency range: 30MHz-10GHz								
5MHz bandwidth, low channel								
950.45	-78.18	84	2	H	11.79	-66.39	-13	-53.39
950.45	-77.51	8	2.4	V	12.48	-65.03	-13	-52.03
1413.00	-53.77	37	1.3	H	-0.53	-54.30	-13	-41.30
1413.00	-52.96	126	2	V	-0.74	-53.70	-13	-40.70
2119.50	-45.31	344	1.3	H	-0.89	-46.20	-13	-33.20
2119.50	-45.78	181	2	V	-1.12	-46.90	-13	-33.90
2826.00	-52.74	23	1.1	H	2.24	-50.50	-13	-37.50
2826.00	-52.23	308	1.8	V	2.33	-49.90	-13	-36.90
5MHz bandwidth, middle channel								
950.45	-78.21	97	1.7	H	11.79	-66.42	-13	-53.42
950.45	-77.61	320	1.2	V	12.48	-65.13	-13	-52.13
1420.00	-55.57	126	2.1	H	-0.53	-56.10	-13	-43.10
1420.00	-55.06	310	1.6	V	-0.74	-55.80	-13	-42.80
2130.00	-46.31	316	1.7	H	-0.89	-47.20	-13	-34.20
2130.00	-46.18	190	2.4	V	-1.12	-47.30	-13	-34.30
2840.00	-52.54	323	1.4	H	2.24	-50.30	-13	-37.30
2840.00	-51.63	187	2.1	V	2.33	-49.30	-13	-36.30
5MHz bandwidth, high channel								
950.45	-78.56	303	2.3	H	11.79	-66.77	-13	-53.77
950.45	-78.24	25	2.4	V	12.48	-65.76	-13	-52.76
1427.00	-54.67	287	1.9	H	-0.53	-55.20	-13	-42.20
1427.00	-54.16	265	1.3	V	-0.74	-54.90	-13	-41.90
2140.50	-45.61	244	1	H	-0.89	-46.50	-13	-33.50
2140.50	-45.88	268	2	V	-1.12	-47.00	-13	-34.00
2854.00	-53.34	347	1.4	H	2.24	-51.10	-13	-38.10
2854.00	-53.03	107	1.2	V	2.33	-50.70	-13	-37.70

Frequency (MHz)	Receiver Reading (dBm)	Turntable Degree	Rx Antenna		Substituted Factor (dB)	Absolute Level (dBm)	Limit (dBm)	Margin (dB)
			Height (m)	Polar (H/V)				
Band 38								
Test frequency range: 30MHz-26.5GHz								
5MHz bandwidth, low channel								
950.45	-78.09	181	1.4	H	11.79	-66.30	-25	-41.30
950.45	-76.21	359	1.7	V	12.48	-63.73	-25	-38.73
5145.00	-54.31	334	1.2	H	9.81	-44.50	-25	-19.50
5145.00	-52.33	238	2.3	V	8.43	-43.90	-25	-18.90
7717.50	-60.93	330	1.2	H	15.03	-45.90	-25	-20.90
7717.50	-60.91	267	2.2	V	15.51	-45.40	-25	-20.40
5MHz bandwidth, middle channel								
950.45	-78.58	50	2.4	H	11.79	-66.79	-25	-41.79
950.45	-76.20	149	2.2	V	12.48	-63.72	-25	-38.72
5190.00	-54.01	168	1.9	H	9.81	-44.20	-25	-19.20
5190.00	-52.03	311	1.2	V	8.43	-43.60	-25	-18.60
7785.00	-59.33	330	1.4	H	15.03	-44.30	-25	-19.30
7785.00	-59.41	38	1.8	V	15.51	-43.90	-25	-18.90
5MHz bandwidth, high channel								
950.45	-77.94	240	1.1	H	11.79	-66.15	-25	-41.15
950.45	-76.87	173	1.5	V	12.48	-64.39	-25	-39.39
5235.00	-53.51	133	2.3	H	9.81	-43.70	-25	-18.70
5235.00	-50.83	269	1.2	V	8.43	-42.40	-25	-17.40
7852.50	-59.23	166	2.4	H	15.03	-44.20	-25	-19.20
7852.50	-59.01	75	1.3	V	15.51	-43.50	-25	-18.50

Frequency (MHz)	Receiver Reading (dBm)	Turntable Degree	Rx Antenna		Substituted Factor (dB)	Absolute Level (dBm)	Limit (dBm)	Margin (dB)
			Height (m)	Polar (H/V)				
Band 41								
Test frequency range: 30MHz-26.5GHz								
5MHz bandwidth, low channel								
950.45	-78.56	356	2.1	H	11.79	-66.77	-25	-41.77
950.45	-75.80	175	1.3	V	12.48	-63.32	-25	-38.32
5095.00	-52.7	216	1.4	H	9.5	-43.20	-25	-18.20
5095.00	-51.12	84	1.7	V	8.32	-42.80	-25	-17.80
7642.50	-60.01	268	1.3	H	14.71	-45.30	-25	-20.30
7642.50	-60.04	232	1.9	V	15.34	-44.70	-25	-19.70
5MHz bandwidth, middle channel								
950.45	-78.37	329	2.1	H	11.79	-66.58	-25	-41.58
950.45	-75.74	42	2.3	V	12.48	-63.26	-25	-38.26
5200.00	-53.31	352	1.5	H	9.81	-43.50	-25	-18.50
5200.00	-51.23	110	1.3	V	8.43	-42.80	-25	-17.80
7800.00	-59.33	71	1	H	15.03	-44.30	-25	-19.30
7800.00	-59.31	85	1.2	V	15.51	-43.80	-25	-18.80
5MHz bandwidth, high channel								
950.45	-78.37	99	2	H	11.79	-66.58	-25	-41.58
950.45	-75.67	195	2.2	V	12.48	-63.19	-25	-38.19
5305.00	-50.41	327	1.2	H	10.11	-40.30	-25	-15.30
5305.00	-40.54	143	1.2	V	8.54	-32.00	-25	-7.00
7957.50	-60.75	226	1.9	H	15.35	-45.40	-25	-20.40
7957.50	-60.68	147	1.4	V	15.68	-45.00	-25	-20.00

**Note:**

Absolute Level = Reading Level + Substituted Factor

Substituted Factor contains: SG Level - Cable loss+ Antenna Gain

Margin = Limit - Absolute Level

dBd is for the ERP, dBi is for EIRP.

## FCC§ 22.917 (a), § 24.238 (a),§27.53 - BAND EDGES

### Applicable Standard

According to § 22.917(a), the power of any emissions outside of the authorized operating frequency ranges must be attenuated below the transmitting power (P) by a factor of at least  $43 + 10 \log(P)$  dB.

According to §24.238(a), the power of any emissions outside of the authorized operating frequency ranges must be attenuated below the transmitting power (P) by a factor of at least  $43 + 10 \log(P)$  dB.

According to FCC §27.53 (c)(h)(m), the power of any emission outside of the authorized operating frequency ranges must be attenuated below the transmitting power (P) by a factor of at least  $43 + 10 \log(P)$  dB.

### Test Procedure

The RF output of the transmitter was connected to the input of the spectrum analyzer through sufficient attenuation.

The center of the spectrum analyzer was set to block edge frequency

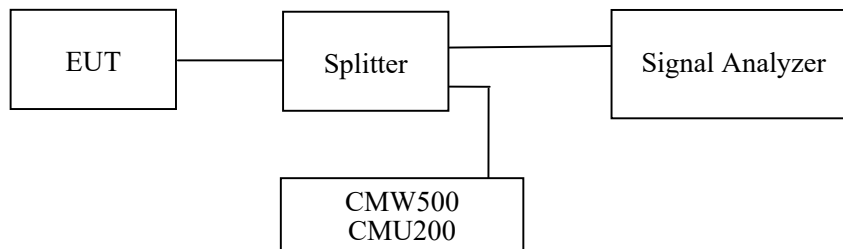

### Test Data

#### Environmental Conditions

Temperature:	27.6~28.5℃
Relative Humidity:	58~62 %
ATM Pressure:	101.0~102kPa

*The testing was performed by Black Ding from 2021-10-27 to 2021-11-24.*

*EUT operation mode: Transmitting (Worst case)*

**Test Result: Pass**

*Test plots refer to the Appendix C.*

## **FCC § 2.1055, § 22.355, § 24.235, §27.54, §90.213- FREQUENCY STABILITY**

### **Applicable Standard**

FCC § 2.1055, §22.355, §24.235, §27.54 and §90.213.

According to FCC §2.1055, the frequency stability shall be sufficient to ensure that the fundamental emissions stay within the authorized bands of operation.

According to §22.355, the carrier frequency of each transmitter in the Public Mobile Services must be maintained within the tolerances given in Table below:

Frequency Tolerance for Transmitters in the Public Mobile Services

Frequency Range (MHz)	Base, fixed (ppm)	Mobile ≤ 3 watts (ppm)	Mobile > 3 watts (ppm)
25 to 50	20.0	20.0	50.0
50 to 450	5.0	5.0	50.0
450 to 512	2.5	5.0	5.0
821 to 896	1.5	2.5	2.5
928 to 929.	5.0	N/A	N/A
929 to 960.	1.5	N/A	N/A
2110 to 2220	10.0	N/A	N/A

According to §24.235, the frequency stability shall be sufficient to ensure that the fundamental emissions stays within the authorized frequency block.

### **Test Procedure**

Frequency Stability vs. Temperature: The equipment under test was connected to an external DC power supply and the RF output was connected to communication test set via feed-through attenuators. The EUT was placed inside the temperature chamber. The DC leads and RF output cable exited the chamber through an opening made for the purpose.

After the temperature stabilized for approximately 20 minutes, the frequency output was recorded from the communication test set.

Frequency Stability vs. Voltage: For hand carried, battery powered equipment; reduce primary supply voltage to the battery operating end point which shall be specified by the manufacturer.

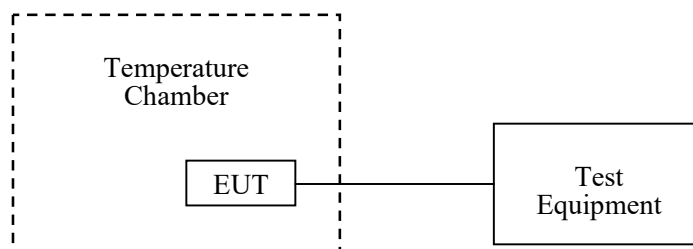

**Test Data****Environmental Conditions**

<b>Temperature:</b>	27.6°C
<b>Relative Humidity:</b>	58 %
<b>ATM Pressure:</b>	101.0kPa

The testing was performed by Black Ding from 2021-10-27 to 2021-10-28.

EUT operation mode: Transmitting

**Test Result: Pass**

Please refer to the following tables.

**Cellular Band (Part 22H)****GSM Mode**

Middle Channel, $f_0=836.6\text{MHz}$				
Temperature (°C)	Voltage Supplied ( $V_{DC}$ )	Frequency Error (Hz)	Frequency Error (ppm)	Limit (ppm)
-30	N.V.	5	0.0060	2.5
-20		4	-0.0048	2.5
-10		3	0.0036	2.5
0		6	0.0072	2.5
10		-3	-0.0036	2.5
20		8	0.0096	2.5
30		-6	-0.0072	2.5
40		7	0.0084	2.5
50		8	0.0096	2.5
20		L.V.	4	0.0048
	H.V.	2	0.0024	2.5

**EDGE Mode**

<b>Middle Channel, <math>f_0=836.6\text{MHz}</math></b>				
<b>Temperature (°C)</b>	<b>Voltage Supplied (<math>V_{DC}</math>)</b>	<b>Frequency Error (Hz)</b>	<b>Frequency Error (ppm)</b>	<b>Limit (ppm)</b>
-30	N.V.	-4	0.0048	2.5
-20		-3	-0.0036	2.5
-10		-7	-0.0084	2.5
0		8	0.0096	2.5
10		6	0.0072	2.5
20		4	0.0048	2.5
30		7	0.0084	2.5
40		-6	-0.0072	2.5
50		-5	-0.0060	2.5
20	L.V.	4	0.0048	2.5
	H.V.	-6	-0.0072	2.5

**WCDMA Mode**

<b>Middle Channel, <math>f_0=836.6\text{MHz}</math></b>				
<b>Temperature (°C)</b>	<b>Voltage Supplied (<math>V_{DC}</math>)</b>	<b>Frequency Error (Hz)</b>	<b>Frequency Error (ppm)</b>	<b>Limit (ppm)</b>
-30	N.V.	-8.22	-0.0098	2.5
-20		9.14	0.0109	2.5
-10		8.13	0.0097	2.5
0		9.21	0.0110	2.5
10		8.22	0.0098	2.5
20		-10.43	-0.0125	2.5
30		8.05	0.0096	2.5
40		11.02	0.0132	2.5
50		10.01	0.0120	2.5
20		L.V.	10.02	0.0120
	H.V.	10.01	0.0120	2.5

**PCS Band (Part 24E)****GSM Mode**

Middle Channel, $f_0=1880.0$ MHz				
Temperature (°C)	Voltage Supplied (V <sub>DC</sub> )	Frequency Error (Hz)	Frequency Error (ppm)	Result
-30	N.V.	3	-0.0016	pass
-20		-8	-0.0042	pass
-10		6	0.0032	pass
0		8	0.0042	pass
10		-1	0.0005	pass
20		18	0.0096	pass
30		-3	-0.0016	pass
40		7	0.0037	pass
50		10	0.0054	pass
20		L.V.	-3	-0.0016
	H.V.	-2	-0.0011	pass

**EDGE Mode**

Middle Channel, $f_0=1880.0$ MHz				
Temperature (°C)	Voltage Supplied (V <sub>DC</sub> )	Frequency Error (Hz)	Frequency Error (ppm)	Result
-30	N.V.	4	-0.0021	pass
-20		-4	-0.0021	pass
-10		-5	-0.0027	pass
0		3	-0.0016	pass
10		-4	-0.0021	pass
20		19	0.0101	pass
30		6	0.0032	pass
40		8	0.0042	pass
50		-7	-0.0037	pass
20		L.V.	3	0.0016
	H.V.	6	0.0032	pass



**WCDMA Mode**

Middle Channel, $f_0=1880.0$ MHz				
Temperature (°C)	Voltage Supplied (V <sub>DC</sub> )	Frequency Error (Hz)	Frequency Error (ppm)	Result
-30	N.V.	-11.32	-0.0060	pass
-20		-12.11	-0.0064	pass
-10		-13.23	-0.0070	pass
0		-14.11	-0.0075	pass
10		-13.11	-0.0070	pass
20		-9.91	-0.0053	pass
30		-10.05	-0.0053	pass
40		-10.03	-0.0053	pass
50		-11.28	-0.0060	pass
20		L.V.	-11.13	-0.0059
	H.V.	-10.02	-0.0053	pass

**LTE:**  
**QPSK:**  
**Band 2:**

10.0 MHz Middle Channel, $f_0=1880$ MHz				
Temperature (°C)	Voltage Supplied (V <sub>DC</sub> )	Frequency Error (Hz)	Frequency Error (ppm)	Result
-30	N.V.	10	-0.0053	pass
-20		8	-0.0043	pass
-10		-6	-0.0032	pass
0		3	0.0016	pass
10		8	0.0043	pass
20		6	0.0032	pass
30		4	0.0021	pass
40		7	0.0037	pass
50		-10	-0.0053	pass
20		L.V.	-8	-0.0043
	H.V.	-7	-0.0037	pass

**Band 4:**

10 MHz Bandwidth					
Temperature (°C)	Power Supplied (V <sub>DC</sub> )	F <sub>L</sub> (MHz)	F <sub>H</sub> (MHz)	F <sub>L</sub> Limit (MHz)	F <sub>H</sub> Limit (MHz)
-30	N.V.	1710.3256	1754.8745	1710	1755
-20		1710.3161	1754.8742	1710	1755
-10		1710.2133	1754.8772	1710	1755
0		1710.2129	1754.8751	1710	1755
10		1710.2123	1754.8743	1710	1755
20		1710.3162	1754.8738	1710	1755
30		1710.3122	1754.8736	1710	1755
40		1710.2142	1754.8751	1710	1755
50		1710.2154	1754.8753	1710	1755
20	L.V.	1710.2142	1754.8778	1710	1755
	H.V.	1710.2146	1754.8767	1710	1755

**Band 5:**

10.0 MHz Middle Channel, f <sub>0</sub> =836.5MHz				
Temperature (°C)	Voltage Supplied (V <sub>DC</sub> )	Frequency Error (Hz)	Frequency Error (ppm)	Limit (ppm)
-30	N.V.	5	0.006	2.5
-20		-10	-0.0120	2.5
-10		-4	-0.0048	2.5
0		6	0.0072	2.5
10		10	0.0120	2.5
20		8	0.0096	2.5
30		7	0.0084	2.5
40		10	-0.0120	2.5
50		3	0.0036	2.5
20	L.V.	-9	-0.0108	2.5
	H.V.	-7	-0.0084	2.5

**Band 7:**

10 MHz Bandwidth					
Temperature (°C)	Power Supplied (V <sub>DC</sub> )	F <sub>L</sub> (MHz)	F <sub>H</sub> (MHz)	F <sub>L</sub> Limit (MHz)	F <sub>H</sub> Limit (MHz)
-30	N.V.	2500.8925	2569.9845	2500	2570
-20		2500.8953	2569.9955	2500	2570
-10		2500.8832	2569.9813	2500	2570
0		2500.8815	2569.9717	2500	2570
10		2500.7917	2569.9862	2500	2570
20		2500.7814	2569.9436	2500	2570
30		2500.7742	2569.9521	2500	2570
40		2500.7543	2569.9811	2500	2570
50		2500.7526	2569.9821	2500	2570
20	L.V.	2500.7425	2569.9723	2500	2570
	H.V.	2500.7547	2569.9642	2500	2570

**Band 17:**

10 MHz Bandwidth					
Temperature (°C)	Power Supplied (V <sub>DC</sub> )	F <sub>L</sub> (MHz)	F <sub>H</sub> (MHz)	F <sub>L</sub> Limit (MHz)	F <sub>H</sub> Limit (MHz)
-30	N.V.	704.1293	715.8468	704	716
-20		704.1233	715.8438	704	716
-10		704.1276	715.8442	704	716
0		704.1217	715.8468	704	716
10		704.1247	715.8459	704	716
20		704.1291	715.8487	704	716
30		704.1258	715.8488	704	716
40		704.1291	715.8497	704	716
50		704.1262	715.8455	704	716
20		L.V.	704.1210	715.8460	704
	H.V.	704.1266	715.8441	704	716

**Band 38:**

10 MHz Bandwidth					
Temperature (°C)	Power Supplied (V <sub>DC</sub> )	F <sub>L</sub> (MHz)	F <sub>H</sub> (MHz)	F <sub>L</sub> Limit (MHz)	F <sub>H</sub> Limit (MHz)
-30	N.V.	2570.8396	2619.9816	2570	2620
-20		2570.8010	2619.8724	2570	2620
-10		2570.7200	2619.7623	2570	2620
0		2570.6100	2619.6522	2570	2620
10		2570.5001	2619.5421	2570	2620
20		2570.3904	2619.4321	2570	2620
30		2570.2801	2619.3221	2570	2620
40		2570.1706	2619.2121	2570	2620
50		2570.1632	2619.1370	2570	2620
20	L.V.	2570.1522	2619.1201	2570	2620
	H.V.	2570.1028	2619.0034	2570	2620

**Band 41:**

10 MHz Bandwidth					
Temperature (°C)	Power Supplied (V <sub>DC</sub> )	F <sub>L</sub> (MHz)	F <sub>H</sub> (MHz)	F <sub>L</sub> Limit (MHz)	F <sub>H</sub> Limit (MHz)
-30	N.V.	2545.8724	2654.9746	2545	2655
-20		2545.8622	2654.8653	2545	2655
-10		2545.7621	2654.8754	2545	2655
0		2545.6522	2654.7652	2545	2655
10		2545.5723	2654.5654	2545	2655
20		2545.4320	2654.5453	2545	2655
30		2545.3121	2654.4357	2545	2655
40		2545.2121	2654.2652	2545	2655
50		2545.1912	2654.1252	2545	2655
20		L.V.	2545.6621	2654.0851	2545
	H.V.	2545.7624	2654.0702	2545	2655

Note: the applicant declared the operating frequency range is 2545MHz-2655MHz.

**16QAM:****Band 2:**

10.0 MHz Middle Channel, $f_0=1880\text{MHz}$				
Temperature (°C)	Voltage Supplied (V <sub>DC</sub> )	Frequency Error (Hz)	Frequency Error (ppm)	Result
-30	N.V.	9	0.0048	pass
-20		7	0.0037	pass
-10		5	0.0027	pass
0		8	0.0043	pass
10		10	-0.0053	pass
20		-10	-0.0053	pass
30		-7	-0.0037	pass
40		9	0.0048	pass
50		-6	-0.0032	pass
20		L.V.	6	0.0032
	H.V.	8	0.0043	pass

**Band 4:**

10 MHz Bandwidth					
Temperature (°C)	Power Supplied (V <sub>DC</sub> )	F <sub>L</sub> (MHz)	F <sub>H</sub> (MHz)	F <sub>L</sub> Limit (MHz)	F <sub>H</sub> Limit (MHz)
-30	N.V.	1710.3764	1754.8642	1710	1755
-20		1710.3753	1754.8534	1710	1755
-10		1710.3725	1754.8628	1710	1755
0		1710.3653	1754.7954	1710	1755
10		1710.3652	1754.7972	1710	1755
20		1710.2636	1754.7835	1710	1755
30		1710.3552	1754.7756	1710	1755
40		1710.3572	1754.7682	1710	1755
50		1710.3655	1754.7718	1710	1755
20		L.V.	1710.3652	1754.7436	1710
	H.V.	1710.3633	1754.7428	1710	1755

**Band 5:**

10.0 MHz Middle Channel, $f_0=836.5\text{MHz}$				
Temperature (°C)	Voltage Supplied ( $V_{DC}$ )	Frequency Error (Hz)	Frequency Error (ppm)	Limit (ppm)
-30	N.V.	4	0.0048	2.5
-20		6	0.0072	2.5
-10		-10	-0.0120	2.5
0		5	0.0036	2.5
10		7	0.0084	2.5
20		-8	-0.0096	2.5
30		4	0.0048	2.5
40		6	0.0072	2.5
50		-6	-0.0072	2.5
20	L.V.	-3	-0.0036	2.5
	H.V.	7	0.0084	2.5

**Band 7:**

10 MHz Bandwidth					
Temperature (°C)	Power Supplied ( $V_{DC}$ )	$F_L$ (MHz)	$F_H$ (MHz)	$F_L$ Limit (MHz)	$F_H$ Limit (MHz)
-30	N.V.	2500.7452	2569.8512	2500	2570
-20		2500.7336	2569.8544	2500	2570
-10		2500.7317	2569.8435	2500	2570
0		2500.7235	2569.8533	2500	2570
10		2500.6345	2569.8235	2500	2570
20		2500.6238	2569.7865	2500	2570
30		2500.6332	2569.7855	2500	2570
40		2500.6327	2569.8437	2500	2570
50		2500.6329	2569.8444	2500	2570
20	L.V.	2500.6231	2569.8341	2500	2570
	H.V.	2500.5425	2569.8352	2500	2570

**Band 17:**

10 MHz Bandwidth					
Temperature (°C)	Power Supplied (V <sub>DC</sub> )	F <sub>L</sub> (MHz)	F <sub>H</sub> (MHz)	F <sub>L</sub> Limit (MHz)	F <sub>H</sub> Limit (MHz)
-30	N.V.	704.1232	715.8468	704	716
-20		704.1235	715.8477	704	716
-10		704.1251	715.8435	704	716
0		704.1237	715.8436	704	716
10		704.1241	715.8433	704	716
20		704.1244	715.8432	704	716
30		704.1248	715.8437	704	716
40		704.1237	715.8446	704	716
50		704.1225	715.8448	704	716
20	L.V.	704.1211	715.8455	704	716
	H.V.	704.1247	715.8435	704	716

**Band 38:**

10 MHz Bandwidth					
Temperature (°C)	Power Supplied (V <sub>DC</sub> )	F <sub>L</sub> (MHz)	F <sub>H</sub> (MHz)	F <sub>L</sub> Limit (MHz)	F <sub>H</sub> Limit (MHz)
-30	N.V.	2570.9698	2619.9876	2570	2620
-20		2570.8915	2619.8791	2570	2620
-10		2570.7827	2619.7692	2570	2620
0		2570.6725	2619.6595	2570	2620
10		2570.5647	2619.5486	2570	2620
20		2570.4532	2619.4380	2570	2620
30		2570.3425	2619.3231	2570	2620
40		2570.2317	2619.2155	2570	2620
50		2570.1255	2619.1047	2570	2620
20	L.V.	2570.0172	2619.8753	2570	2620
	H.V.	2570.0033	2619.7628	2570	2620

**Band 41:**

10 MHz Bandwidth					
Temperature (°C)	Power Supplied (V <sub>DC</sub> )	F <sub>L</sub> (MHz)	F <sub>H</sub> (MHz)	F <sub>L</sub> Limit (MHz)	F <sub>H</sub> Limit (MHz)
-30	N.V.	2545.9488	2654.9662	2545	2655
-20		2545.8474	2654.8554	2545	2655
-10		2545.7352	2654.7488	2545	2655
0		2545.6325	2654.6387	2545	2655
10		2545.5111	2654.5284	2545	2655
20		2545.4165	2654.4156	2545	2655
30		2545.2986	2654.3083	2545	2655
40		2545.1878	2654.1977	2545	2655
50		2545.1832	2654.0826	2545	2655
20	L.V.	2545.1626	2654.0735	2545	2655
	H.V.	2545.0577	2654.0383	2545	2655

Note: the applicant declared the operating frequency range is 2545MHz-2655MHz.

\*\*\*\*\* **END OF REPORT** \*\*\*\*\*