

FCC TEST REPORT

For

PANWIRA (FAR EAST) LTD.

Professional PA Speaker With FM Radio

Model No.: MS-S2106, MS-S2105, MS-S2107R, MS-S3122, MS-S3123,
MS-S2125DR, MS-S2126, MS-S2129DR, MS-S3101, MS-S3151,
MS-S2108, MS-S2128, MS-S2127, MS-S8102

Prepared for : PANWIRA (FAR EAST) LTD.
Address : 2nd Floor, Fuk Chiu Factory Building 20 Bute Street, Mong
Kok, Kowloon, Hong Kong

Prepared By : Shenzhen Anbotek Compliance Laboratory Limited
Address : 1/F., Building 1, SEC Industrial Park, No.0409 Qianhai Road,
Nanshan District, Shenzhen, Guangdong, China
Tel: (86) 755-26066544
Fax: (86) 755-26014772

Report Number : R011606497I
Date of Test : Jun. 08~Jul. 02, 2016
Date of Report : Jul. 04, 2016

TABLE OF CONTENT

Description

Page

Test Report

1. GENERAL INFORMATION.....	5
1.1. Client Information.....	5
1.2. Description of Device (EUT).....	5
1.3. Auxiliary Equipment Used during Test.....	6
1.4. Description of Test Facility.....	6
1.5. Measurement Uncertainty.....	6
2. TEST METHODOLOGY.....	7
2.1. Summary of Test Results.....	7
2.2. Description of Test Modes.....	7
2.3. List of channels:.....	8
3. CONDUCTED EMISSION TEST.....	9
3.1. Block Diagram of Test Setup.....	9
3.2. Power Line Conducted Emission Measurement Limits (15.207).....	9
3.3. Configuration of EUT on Measurement.....	9
3.4. Operating Condition of EUT.....	9
3.5. Test Procedure.....	10
3.6. Test equipment.....	10
3.7. Power Line Conducted Emission Measurement Results.....	10
4. RADIATION INTERFERENCE.....	15
4.1 Requirements (15.247, 15.209):.....	15
4.2 Test Procedure.....	15
4.3 Test Configuration.....	16
4.4 Test Results.....	17
5. CHANNEL SEPARATION TEST.....	28
5.1 Measurement Procedure.....	28
5.2 Test SET-UP.....	28
5.3 Test Equipment.....	28
5.4 Test Results.....	29
6. 20DB BANDWIDTH TEST.....	31
6.1 Measurement Procedure.....	31
6.2 Test SET-UP.....	31
6.3 Test Equipment.....	31
6.4 Test Results.....	31
7. QUANTITY OF HOPPING CHANNEL TEST.....	33
7.1 Measurement Procedure.....	33

7.2 Test SET-UP.....	33
7.3 Test Equipment.....	33
7.4 Test Results.....	33
8. DWELL TIME TEST.....	35
8.1 Measurement Procedure.....	35
8.2 Test SET-UP.....	35
8.3 Test Equipment.....	35
8.4 Test Results.....	35
9. MAXIMUM PEAK OUTPUT POWER TEST.....	37
9.1 Measurement Procedure.....	37
9.2 Test SET-UP.....	37
9.3 Test Equipment.....	37
9.4 Test Results.....	38
10. BAND EDGE TEST.....	40
10.1 Measurement Procedure.....	40
10.2 Test SET-UP.....	40
10.3 Test Equipment.....	41
10.4 Test Results.....	41
11. ANTENNA APPLICATION.....	47
11.1 Antenna requirement.....	47
11.2 Result.....	47
12. TEST SETUP PHOTOGRAPH.....	48
12.1. Photo of Conducted Emission Measurement.....	48
12.2. Photo of Radiation Emission Test.....	48
APPENDIX I (EXTERNAL PHOTOS).....	50
APPENDIX II (INTERNAL PHOTOS).....	53

TEST REPORT

Applicant : PANWIRA (FAR EAST) LTD.
Manufacturer : GuangZhou Dotun Electrical CO., LTD
EUT : Professional PA Speaker With FM Radio
Model No. : MS-S2106
Serial No. : MS-S2105, MS-S2107R, MS-S3122, MS-S3123, MS-S2125DR,
MS-S2126, MS-S2129DR, MS-S3101, MS-S3151, MS-S2108,
MS-S2128, MS-S2127, MS-S8102
Trade Mark : MAXSTAR
Rating : 110-120V or 220-240V, 50/60Hz

Measurement Procedure Used:

FCC Part15 Subpart C 2015, Paragraph 15.207, 15.247 & 15.209

The device described above is tested by Shenzhen Anbotek Compliance Laboratory Limited to determine the maximum emission levels emanating from the device and the severe levels of the device can endure and its performance criterion. The measurement results are contained in this test report and Shenzhen Anbotek Compliance Laboratory Limited is assumed full of responsibility for the accuracy and completeness of these measurements. Also, this report shows that the EUT (Equipment Under Test) is technically compliant with the FCC Part 15 Subpart C requirements.

This report applies to above tested sample only and shall not be reproduced in part without written approval of Shenzhen Anbotek Compliance Laboratory Limited.

Date of Test : Jun. 08~Jul. 02, 2016

Kebo Zhang

Prepared by :

(Tested Engineer / Kebo Zhang)

Dolly mo

Reviewer :

(Project Manager / Dolly Mo)

Approved & Authorized Signer :

Tom Chen

(Manager / Tom Chen)

1. GENERAL INFORMATION

1.1. Client Information

Applicant	:	PANWIRA (FAR EAST) LTD.
Address	:	2nd Floor, Fuk Chiu Factory Building 20 Bute Street, Mong Kok, Kowloon, Hong Kong
Manufacturer	:	GuangZhou Dotun Electrical CO., LTD
Address	:	NO.88, Guo Ya Road, ShenShan, JiangGao, Baiyun District, Guangzhou, Guangdong, China
Factory	:	GuangZhou Dotun Electrical CO., LTD
Address	:	NO.88, Guo Ya Road, ShenShan, JiangGao, Baiyun District, Guangzhou, Guangdong, China

1.2. Description of Device (EUT)

Product Name	:	Professional PA Speaker With FM Radio	
Models No.	:	MS-S2106	
Serial No.	:	MS-S2105, MS-S2107R, MS-S3122, MS-S3123, MS-S2125DR, MS-S2126, MS-S2129DR, MS-S3101, MS-S3151, MS-S2108, MS-S2128, MS-S2127, MS-S8102	
Trademark	:	N/A	
Product Description	:	Operation Frequency:	2402MHz~2480MHz
		Transfer Rate:	1/2/3 Mbits/s
		Number of Channel:	79 Channels
		Modulation Type:	GFSK, $\pi/4$ -DQPSK, 8-DPSK
		Modulation Technology:	FHSS
		Antenna Type:	Integral PCB Antenna
		Antenna Gain(Peak):	1.2 dBi
Power Supply	:	Input AC 120-240V, 50/60Hz	

Note:

- (1) For a more detailed features description, please refer to the manufacturer's specifications or the User's Manual.

1.3. Auxiliary Equipment Used during Test

N/A

1.4. Description of Test Facility

The test facility is recognized, certified, or accredited by the following organizations:

FCC-Registration No.: 752021

Shenzhen Anbotek Compliance Laboratory Limited, EMC Laboratory has been registered and fully described in a report filed with the (FCC) Federal Communications Commission. The acceptance letter from the FCC is maintained in our files. Registration 752021, July 06, 2016.

IC-Registration No.: 8058A-1

Shenzhen Anbotek Compliance Laboratory Limited., EMC Laboratory has been registered and fully described in a report filed with the (IC) Industry Canada. The acceptance letter from the IC is maintained in our files. Registration 8058A, Jun. 13, 2016.

Test Location

All Emissions tests were performed at
Shenzhen Anbotek Compliance Laboratory Limited. at 1/F., Building 1, SEC Industrial Park,
No.0409 Qianhai Road, Nanshan District, Shenzhen, Guangdong, China

1.5. Measurement Uncertainty

Radiation Uncertainty : Ur = 4.1 dB (Horizontal)
Ur = 4.3 dB (Vertical)

Conduction Uncertainty : Uc = 3.4dB

2. TEST METHODOLOGY

The tests documented in this report were performed in accordance with ANSI C63.10: 2013 and FCC Part 15, Paragraph 15.207, 15.247 & 15.209.

2.1. Summary of Test Results

The EUT has been tested according to the following specifications:

Standard Section	Test Item	Judgment
15.203/15.247(c)	Antenna Requirement	PASS
15.207	Conducted Emission	PASS
15.247(b)(1)	Conducted Peak Output Power	PASS
15.247(a)(1)	20dB Occupied Bandwidth	PASS
15.247(a)(1)	Carrier Frequencies Separation	PASS
15.247(a)(1)	Hopping Channel Number	PASS
15.247(a)(1)	Dwell Time	PASS
15.205/15.209	Spurious Emission	PASS
15.247(d)	Band Edge	PASS
Remark: "N/A" is an abbreviation for Not Applicable.		

2.2. Description of Test Modes

To investigate the maximum EMI emission characteristics generates from EUT, the test system was pre-scanning tested base on the consideration of following EUT operation mode or test configuration mode which possible have effect on EMI emission level. Each of these EUT operation mode(s) or test configuration mode(s) mentioned follow was evaluated respectively.

Test Mode	Description
Transmitting mode	Keep the EUT in Transmitting mode with worst case data rate

Remark: The sample was placed 0.8m above the ground plane of 3m chamber. Measurements in both horizontal and vertical polarities were performed. During the test, each emission was maximized by: having the EUT continuously working, investigated all operating modes, rotated about all 3 axis (X, Y & Z) and considered typical configuration to obtain worst position, manipulating interconnecting cables, rotating the turntable, varying antenna height from 1m to 4m in both horizontal and vertical polarizations. The emissions worst-case are shown in Test Results of the following pages.

2.3. List of channels:

Channel	Frequency (MHz)	Channel	Frequency (MHz)	Channel	Frequency (MHz)
00	2402	27	2429	54	2456
01	2403	28	2430	55	2457
02	2404	29	2431	56	2458
03	2405	30	2432	57	2459
04	2406	31	2433	58	2460
05	2407	32	2434	59	2461
06	2408	33	2435	60	2462
07	2409	34	2436	61	2463
08	2410	35	2437	62	2464
09	2411	36	2438	63	2465
10	2412	37	2439	64	2466
11	2413	38	2440	65	2467
12	2414	39	2441	66	2468
13	2415	40	2442	67	2469
14	2416	41	2443	68	2470
15	2417	42	2444	69	2471
16	2418	43	2445	70	2472
17	2419	44	2446	71	2473
18	2420	45	2447	72	2474
19	2421	46	2448	73	2475
20	2422	47	2449	74	2476
21	2423	48	2450	75	2477
22	2424	49	2451	76	2478
23	2425	50	2452	77	2479
24	2426	51	2453	78	2480
25	2427	52	2454		
26	2428	53	2455		

Remark: Channel 0, 39 & 78 selected for GFSK, $\pi/4$ -DQPSK and 8DPSK.

3. Conducted Emission Test

3.1. Block Diagram of Test Setup

3.1.1. Block diagram of connection between the EUT and simulators

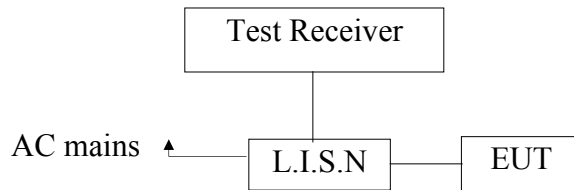

3.2. Power Line Conducted Emission Measurement Limits (15.207)

Frequency MHz	Limits dB(μV)	
	Quasi-peak Level	Average Level
0.15 ~ 0.50	66 ~ 56*	56 ~ 46*
0.50 ~ 5.00	56	46
5.00 ~ 30.00	60	50

- Notes: 1. *Decreasing linearly with logarithm of frequency.
2. The lower limit shall apply at the transition frequencies.

3.3. Configuration of EUT on Measurement

The following equipments are installed on Power Line Conducted Emission Measurement to meet the commission requirement and operating regulations in a manner which tends to maximize its emission characteristics in a normal application.

3.4. Operating Condition of EUT

- 3.4.1. Setup the EUT and simulator as shown as Section 3.1.
- 3.4.2. Turn on the power of all equipment.
- 3.4.3. Let the EUT work in test mode (ON) and measure it.

3.5. Test Procedure

The EUT system is connected to the power mains through a line impedance stabilization network (L.I.S.N.). This provides a 50ohm coupling impedance for the EUT system. Please refer the block diagram of the test setup and photographs. Both sides of AC line are checked to find out the maximum conducted emission. In order to find the maximum emission levels, the relative positions of equipment and all of the interface cables shall be changed according to FCC ANSI C63.10-2013 on Conducted Emission Measurement.

The bandwidth of test receiver (ESCI) set at 9KHz.

The frequency range from 150KHz to 30MHz is checked.

The test results are reported on Section 3.6.

3.6. Test equipment

Item	Equipment	Manufacturer	Model No.	Serial No.	Last Cal.	Cal. Interval
1.	Two-Line V-network	Rohde & Schwarz	ENV216	100055	Apr. 17, 2016	1 Year
2.	EMI Test Receiver	Rohde & Schwarz	ESCI	100627	Apr. 17, 2016	1 Year
3.	RF Switching Unit	Compliance Direction	RSU-M2	38303	Apr. 17, 2016	1 Year

3.7. Power Line Conducted Emission Measurement Results

PASS.

The frequency range from 150KHz to 30 MHz is investigated.

Please refer the following pages.

CONDUCTED EMISSION TEST DATA

Test Site: 1# Shielded Room
 Operating Condition: ON
 Test Specification: AC 120V, 60Hz
 Comment: Live Line
 Tem.:24°C Hum.:49%

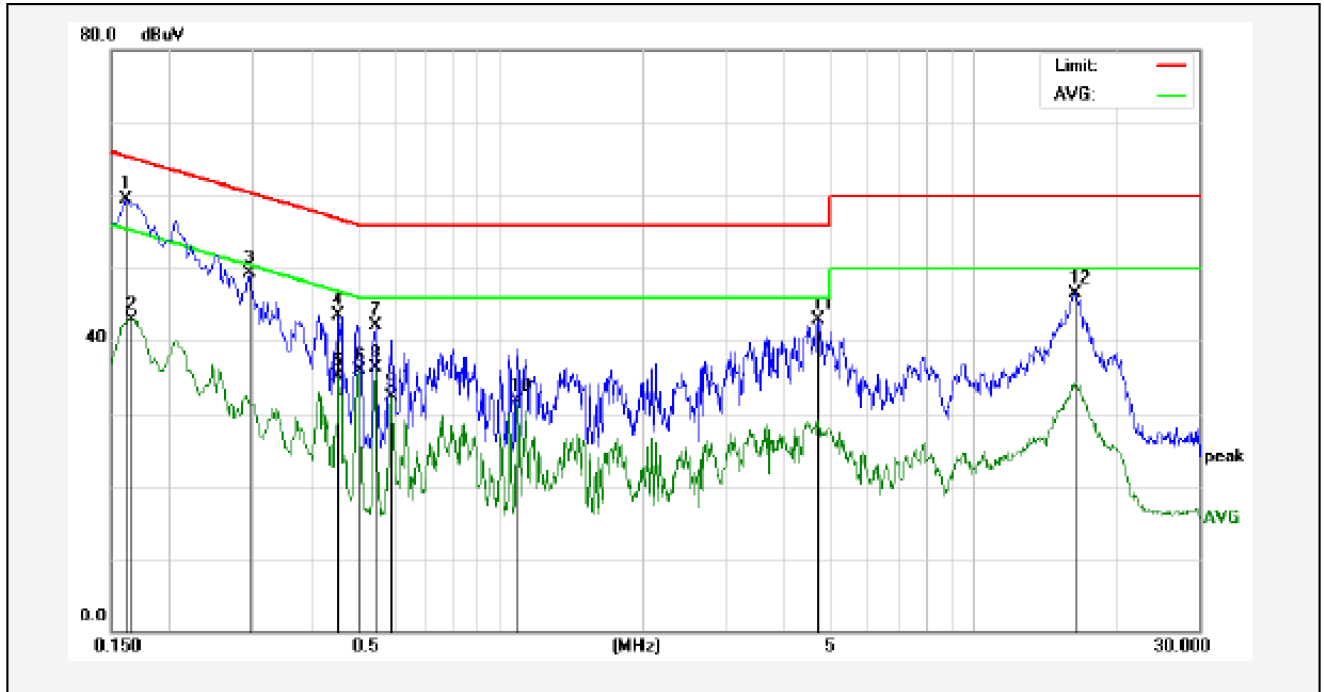

No.	Freq. (MHz)	Reading (dBuV)	Factor (dB)	Result (dBuV)	Limit dBuV	Over Limit (dB)	Detector	Remark
1	0.1620	39.46	20.00	59.46	65.36	-5.90	QP	
2	0.1660	22.83	20.00	42.83	55.15	-12.32	AVG	
3	0.2940	29.39	20.00	49.39	60.41	-11.02	QP	
4	0.4540	23.46	20.00	43.46	56.80	-13.34	QP	
5	0.4540	15.19	20.00	35.19	46.80	-11.61	AVG	
6	0.5020	15.87	20.00	35.87	46.00	-10.13	AVG	
7	0.5460	22.08	20.00	42.08	56.00	-13.92	QP	
8	0.5460	16.35	20.00	36.35	46.00	-9.65	AVG	
9	0.5899	12.24	20.00	32.24	46.00	-13.76	AVG	
10	1.0859	11.63	20.00	31.63	46.00	-14.37	AVG	
11	4.7100	22.85	20.00	42.85	56.00	-13.15	QP	
12	16.4540	26.58	20.00	46.58	60.00	-13.42	QP	

CONDUCTED EMISSION TEST DATA

Test Site: 1# Shielded Room
 Operating Condition: ON
 Test Specification: AC 120V, 60Hz
 Comment: Neutral Line
 Tem.:24°C Hum.:49%

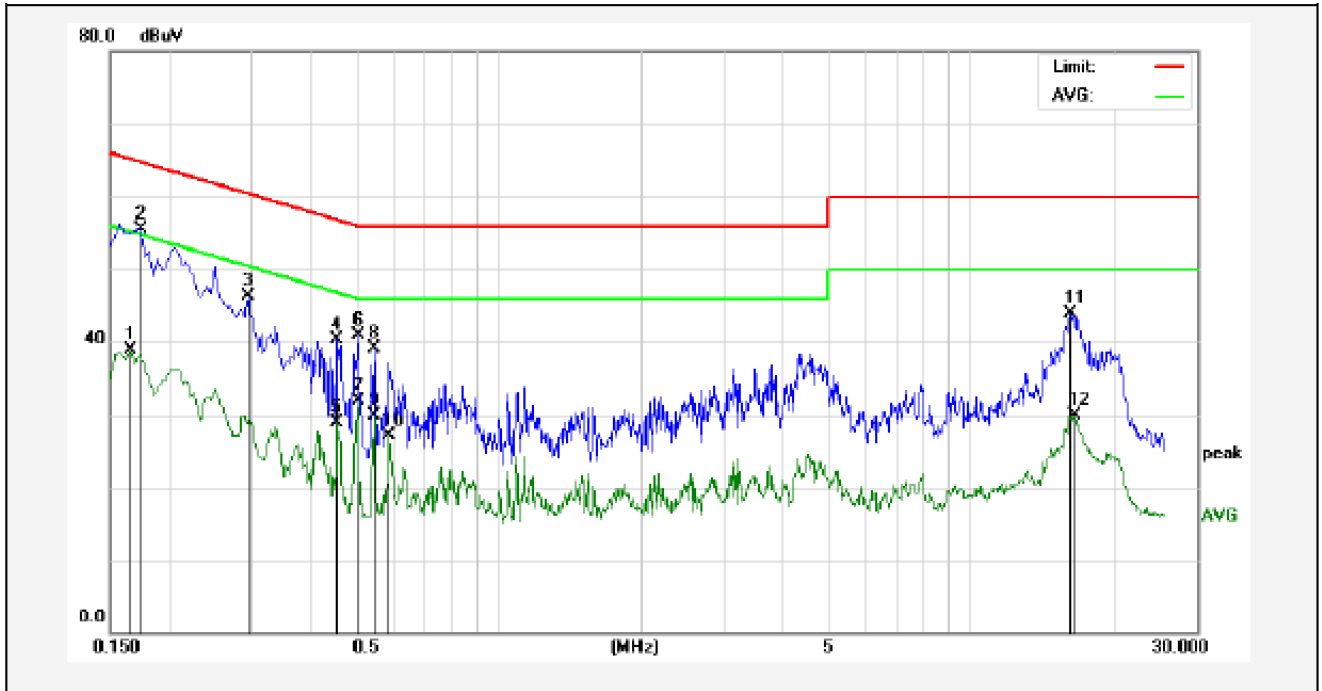

No.	Freq. (MHz)	Reading (dBuV)	Factor (dB)	Result (dBuV)	Limit dBuV	Over Limit (dB)	Detector	Remark
1	0.1660	18.87	20.00	38.87	55.15	-16.28	AVG	
2	0.1740	35.54	20.00	55.54	64.76	-9.22	QP	
3	0.2940	26.24	20.00	46.24	60.41	-14.17	QP	
4	0.4540	20.35	20.00	40.35	56.80	-16.45	QP	
5	0.4540	8.87	20.00	28.87	46.80	-17.93	AVG	
6	0.5020	20.96	20.00	40.96	56.00	-15.04	QP	
7	0.5020	11.99	20.00	31.99	46.00	-14.01	AVG	
8	0.5460	19.15	20.00	39.15	56.00	-16.85	QP	
9	0.5460	9.99	20.00	29.99	46.00	-16.01	AVG	
10	0.5860	7.19	20.00	27.19	46.00	-18.81	AVG	
11	16.2220	23.84	20.00	43.84	60.00	-16.16	QP	
12	16.5180	9.89	20.00	29.89	50.00	-20.11	AVG	

CONDUCTED EMISSION TEST DATA

Test Site: 1# Shielded Room
 Operating Condition: ON
 Test Specification: AC 240V, 60Hz
 Comment: Live Line
 Tem.:24°C Hum.:49%

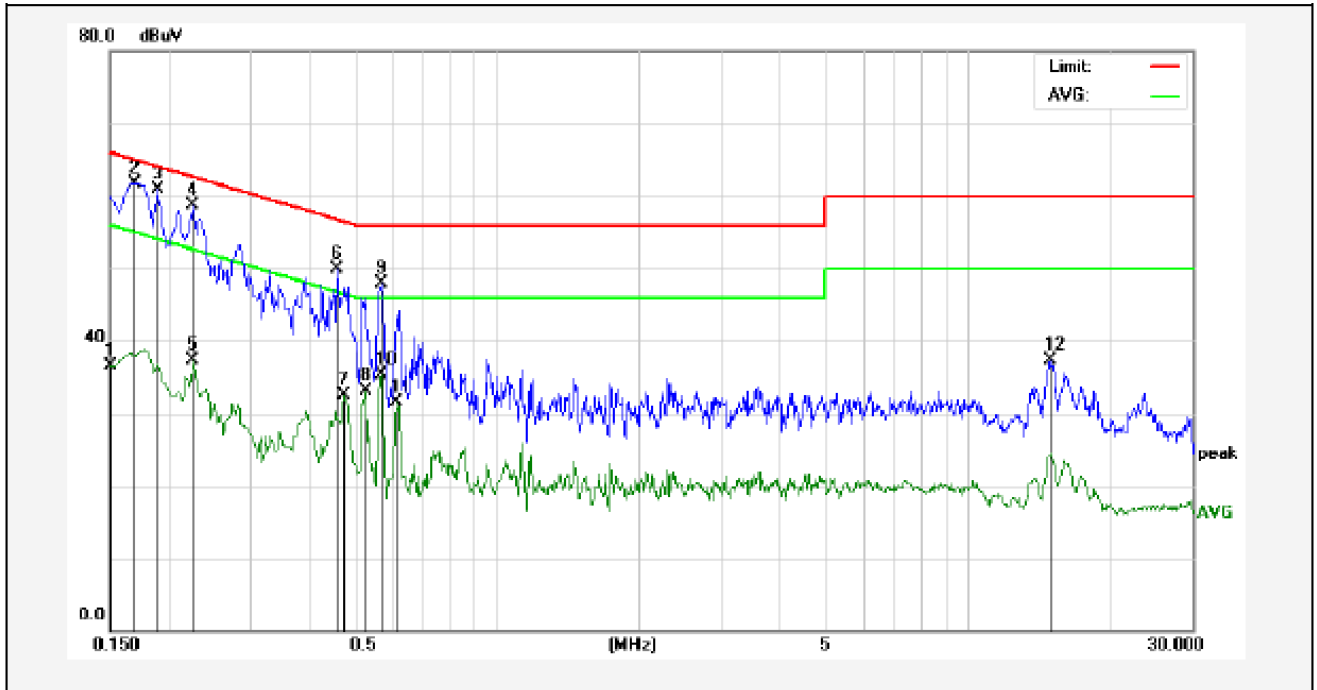

No.	Freq. (MHz)	Reading (dBuV)	Factor (dB)	Result (dBuV)	Limit dBuV	Over Limit (dB)	Detector	Remark
1	0.1499	16.57	20.00	36.57	56.00	-19.43	AVG	
2	0.1700	41.73	20.00	61.73	64.96	-3.23	QP	
3	0.1900	40.85	20.00	60.85	64.03	-3.18	QP	
4	0.2260	38.74	20.00	58.74	62.59	-3.85	QP	
5	0.2260	17.23	20.00	37.23	52.59	-15.36	AVG	
6	0.4580	29.81	20.00	49.81	56.73	-6.92	QP	
7	0.4740	12.47	20.00	32.47	46.44	-13.97	AVG	
8	0.5260	13.14	20.00	33.14	46.00	-12.86	AVG	
9	0.5700	27.91	20.00	47.91	56.00	-8.09	QP	
10	0.5700	15.24	20.00	35.24	46.00	-10.76	AVG	
11	0.6100	11.50	20.00	31.50	46.00	-14.50	AVG	
12	14.9339	17.25	20.00	37.25	60.00	-22.75	QP	

CONDUCTED EMISSION TEST DATA

Test Site: 1# Shielded Room
 Operating Condition: ON
 Test Specification: AC 240V, 60Hz
 Comment: Neutral Line
 Tem.:24°C Hum.:49%

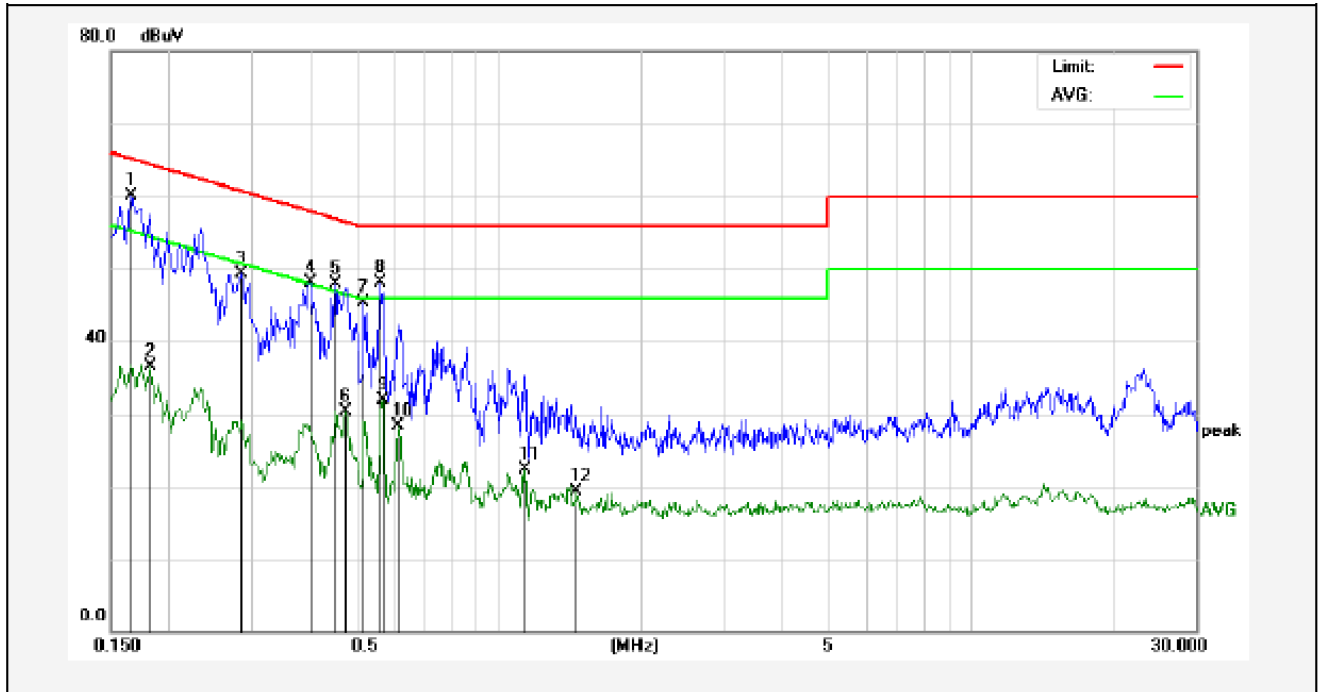

No.	Freq. (MHz)	Reading (dBuV)	Factor (dB)	Result (dBuV)	Limit dBuV	Over Limit (dB)	Detector	Remark
1	0.1660	40.15	20.00	60.15	65.15	-5.00	QP	
2	0.1819	16.54	20.00	36.54	54.39	-17.85	AVG	
3	0.2860	29.36	20.00	49.36	60.64	-11.28	QP	
4	0.3980	28.13	20.00	48.13	57.89	-9.76	QP	
5	0.4500	27.82	20.00	47.82	56.87	-9.05	QP	
6	0.4740	10.33	20.00	30.33	46.44	-16.11	AVG	
7	0.5180	25.22	20.00	45.22	56.00	-10.78	QP	
8	0.5620	28.16	20.00	48.16	56.00	-7.84	QP	
9	0.5700	11.85	20.00	31.85	46.00	-14.15	AVG	
10	0.6100	8.33	20.00	28.33	46.00	-17.67	AVG	
11	1.1380	2.23	20.00	22.23	46.00	-23.77	AVG	
12	1.4620	-0.75	20.00	19.25	46.00	-26.75	AVG	

4. Radiation Interference

4.1 Requirements (15.247, 15.209):

4.1.1. Test Limits (< 30 MHz)

Frequency (MHz)	Field Strength (microvolts/meter)	Measurement Distance (meter)
0.009-0.490	2400/F(kHz)	300
0.490-1.705	24000/F(kHz)	30
1.705-30.0	30	30

4.1.2. Test Limits (\geq 30 MHz)

FIELD STRENGTH of Fundamental: @3M	FIELD STRENGTH of Harmonics	S15.209	
902-928 MHz		30 - 88 MHz	40 dBuV/m
2.4-2.4835 GHz		88 - 216 MHz	43.5
94 dB μ V/m @3m	54 dB μ V/m @3m	216 - 960 MHz	46
		ABOVE 960 MHz	54dBuV/m

For range 9KHz~30MHz, The measured value is really too low to be recorded.

Emissions radiated outside of the specified frequency bands, except for harmonics, shall be attenuated by at least 50 dB below the level of the fundamental or to the general radiated emission limits in 15.209, whichever is the lesser attenuation.

4.2 Test Procedure

For below 1GHz: The EUT is placed on a turntable, which is 0.1m above the ground plane.
For above 1GHz: The EUT is placed on a turntable, which is 0.1m above the ground plane.
The turn table can rotate 360 degrees to determine the position of the maximum emission level.
The EUT is set 3 meters away from the receiving antenna which is mounted on a antenna tower.
The antenna can be moved up and down from 1 to 4 meters to find out the maximum emission level. Rotated the EUT through three orthogonal axes to determine the maximum emissions, both horizontal and vertical polarization of the antenna are set on test. The EUT is tested in 9*6*6 Chamber. The device is evaluated in xyz orientation.

For 30MHz to 1000MHz:

Set the spectrum analyzer as:
RBW = 100kHz, VBW =300kHz,
Detector= Quasi-Peak
Trace mode= Max hold.
Sweep- auto couple.

For Above 1GHz:

Set the spectrum analyzer as:
RBW = 1MHz, VBW =3MHz,
Detector= Peak
Trace mode= Max hold.
Sweep- auto couple.

Set the spectrum analyzer as:
RBW =1MHz, VBW =10Hz
Detector= Average
Trace mode= Max hold.
Sweep- auto couple.

Test Equipment

Item	Equipment	Manufacturer	Model No.	Serial No.	Last Cal.	Cal. Interval
1.	Spectrum Analysis	Agilent	E4407B	US39390582	Apr. 17, 2016	1 Year
2.	Preamplifier	Instruments corporation	EMC011830	980100	Apr. 17, 2016	1 Year
3.	EMI Test Receiver	Rohde & Schwarz	ESPI	101604	Apr. 17, 2016	1 Year
4.	Double Ridged Horn Antenna	Instruments corporation	GTH-0118	351600	Apr. 20, 2016	1 Year
5.	Bilog Broadband Antenna	Schwarzbeck	VULB9163	VULB 9163-289	Apr. 20, 2016	1 Year
6.	Pre-amplifier	SONOMA	310N	186860	Apr. 17, 2016	1 Year
7.	EMI Test Software EZ-EMC	SHURPLE	N/A	N/A	N/A	N/A
8	Power Sensor	DAER	RPR3006 W	15I00041SN046	Jun. 28, 2016	1 Year
9	MXA Spectrum Analysis	Agilent	N9020A	MY51170037	Jun. 28, 2016	1 Year
10	MXG RF Vector Signal Generator	Agilent	N5182A	MY48180656	Jun. 28, 2016	1 Year
11	Signal Generator	Agilent	E4421B	MY41000743	Jun. 28, 2016	1 Year
12	DC Power supply	IV	IV-8080	YQSB0096	Jun. 28, 2016	1 Year
13	TEMP&HUMI PROGRAMMABLE CHAMBER	Bell Group	BE-THK-150M8	SE-0137	Mar 16, 2016	1 Year

4.3 Test Configuration

4.3.1. 9k to 30MHz emissions:

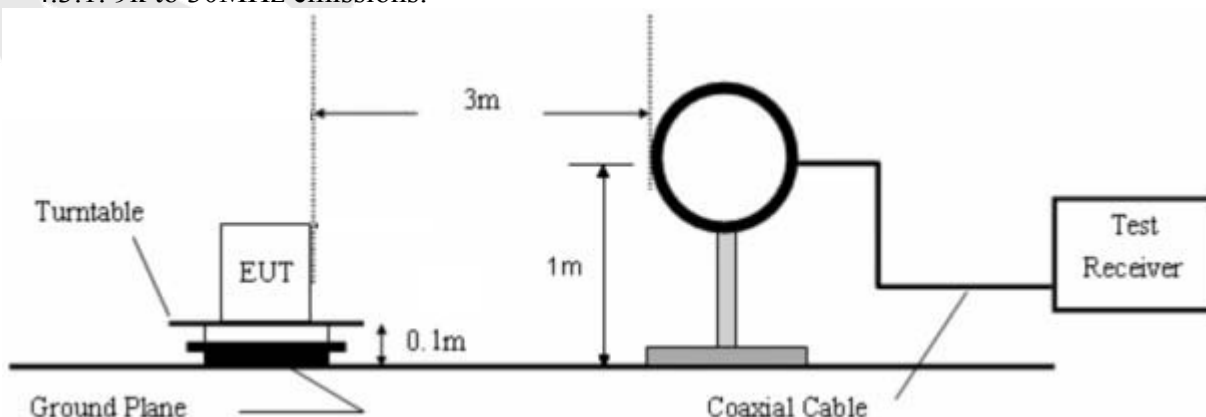

4.3.2. 30M to 1G emissions:

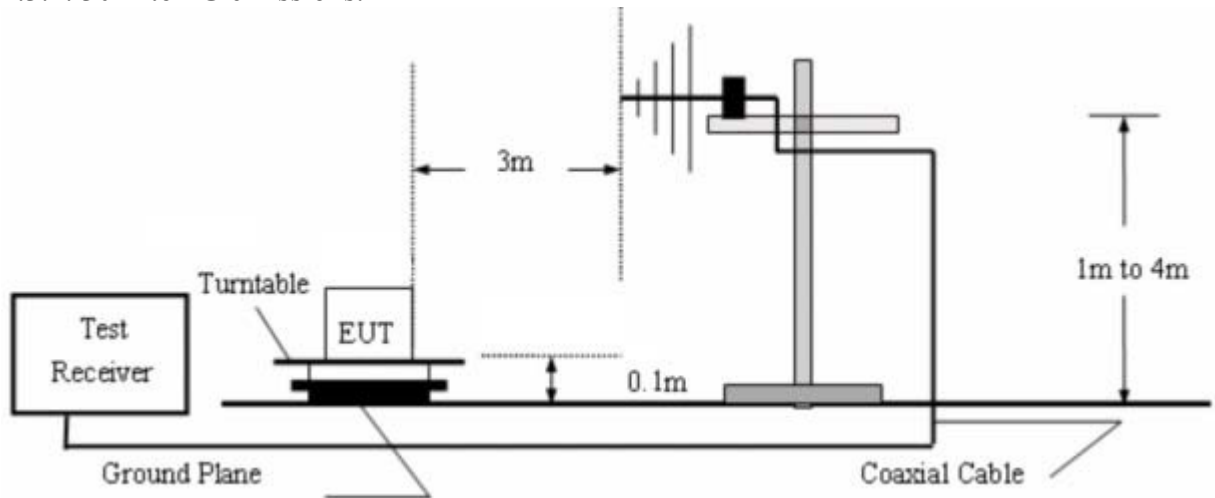

4.3.3. 1G to 40G emissions:

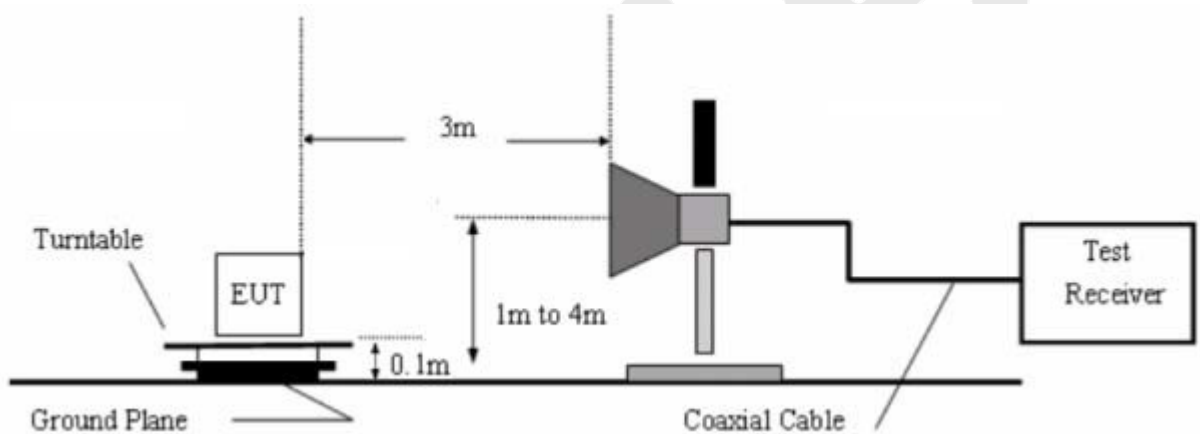

4.4 Test Results

PASS.

The EUT was tested on (BT Mode, AUX Mode, USB Mode) modes, only the worst data of (BT Mode) is attached in the following pages.

Only the worst case (x orientation).

The EDR was tested on ($\pi/4$ DQPSK, 8DPSK) modes, only the worst data of ($\pi/4$ DQPSK) is attached in the following pages.

The test results of above 18000MHz are attenuated more than 20dB below the permissible limits, so the results don't record in the report.

Job No.:	011606497I	Polarization:	Horizontal
Standard:	(RE)FCC PART 15C_3m	Power Source:	AC 120V, 60Hz
Test item:	Radiation Test (30~1000MHz)	Temp.(C)/Hum.(%RH):	24.3(°C)/55%RH
Test Mode:	BT Mode	Distance:	3m

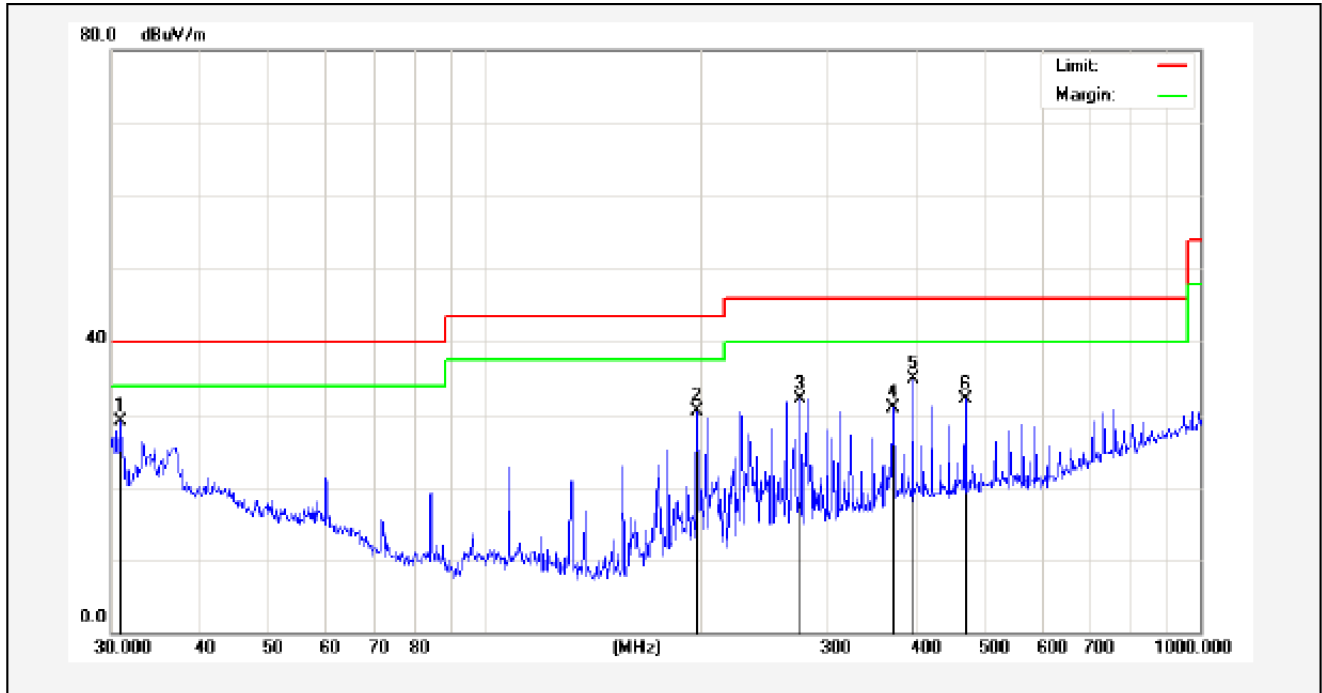

No.	Freq. (MHz)	Reading (dBuV/m)	Factor (dB/m)	Result (dBuV/m)	Limit (dBuV/)	Over Limit (dB)	Detector	Height (cm)	degree (deg)	Remark
1	30.9619	45.57	-16.44	29.13	40.00	-10.87	peak			
2	197.8928	51.43	-20.88	30.55	43.50	-12.95	peak			
3	276.1235	50.47	-18.38	32.09	46.00	-13.91	peak			
4	372.0045	44.25	-13.43	30.82	46.00	-15.18	peak			
5	396.2415	47.89	-12.94	34.95	46.00	-11.05	peak			
6	468.8762	44.02	-11.85	32.17	46.00	-13.83	peak			

Job No.:	011606497I	Polarization:	Vertical
Standard:	(RE)FCC PART 15C_3m	Power Source:	AC 120V, 60Hz
Test item:	Radiation Test (30~1000MHz)	Temp.(C)/Hum.(%RH):	24.3(C)/55%RH
Test Mode:	BT Mode	Distance:	3m

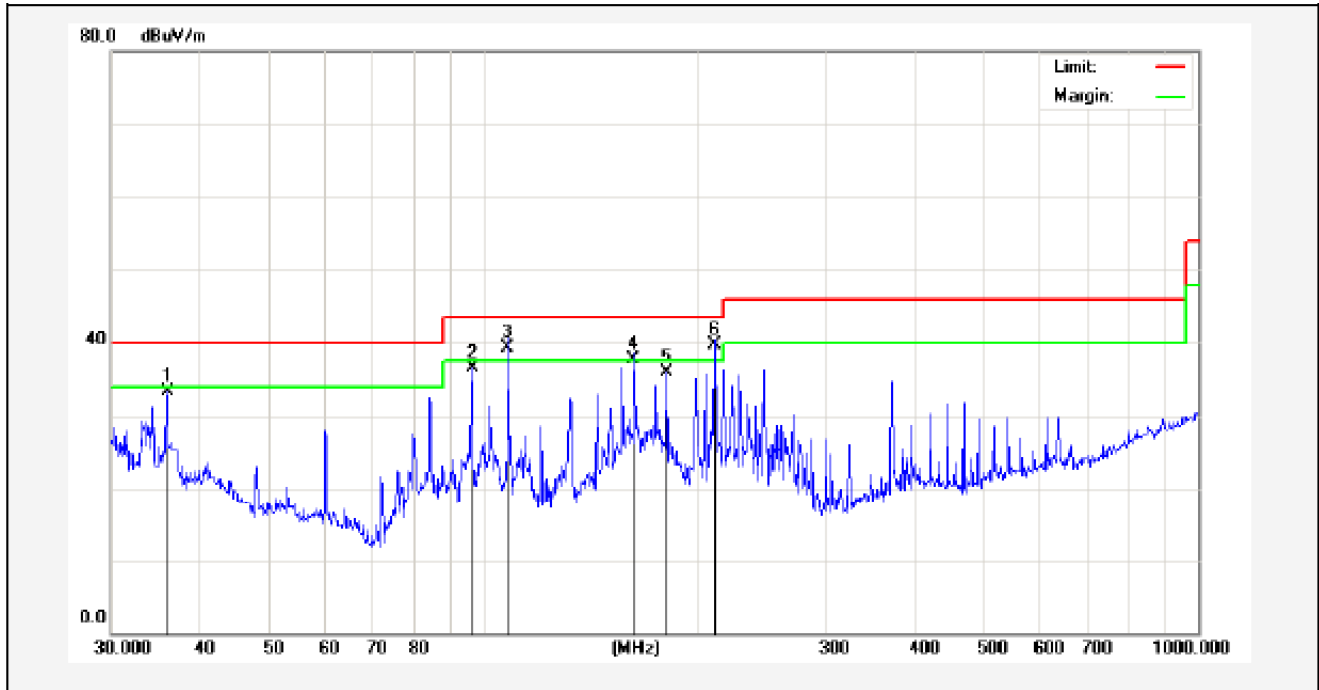

No.	Freq. (MHz)	Reading (dBuV/m)	Factor (dB/m)	Result (dBuV/m)	Limit (dBuV/)	Over Limit (dB)	Detector	Height (cm)	degree (deg)	Remark
1	36.0007	46.86	-13.50	33.36	40.00	-6.64	peak			
2	96.0986	52.52	-15.97	36.55	43.50	-6.95	peak			
3	107.9877	55.02	-15.66	39.36	43.50	-4.14	QP	100	360	
4	162.0414	55.50	-17.81	37.69	43.50	-5.81	QP	100	360	
5	180.0165	52.85	-16.85	36.00	43.50	-7.50	peak			
6	210.0482	55.27	-15.48	39.79	43.50	-3.71	QP	100	0	

Job No.:	011606497I	Polarization:	Horizontal
Standard:	(RE)FCC PART 15C_3m	Power Source:	AC 240V, 60Hz
Test item:	Radiation Test (30~1000MHz)	Temp.(C)/Hum.(%RH):	24.3(°C)/55%RH
Test Mode:	BT Mode	Distance:	3m

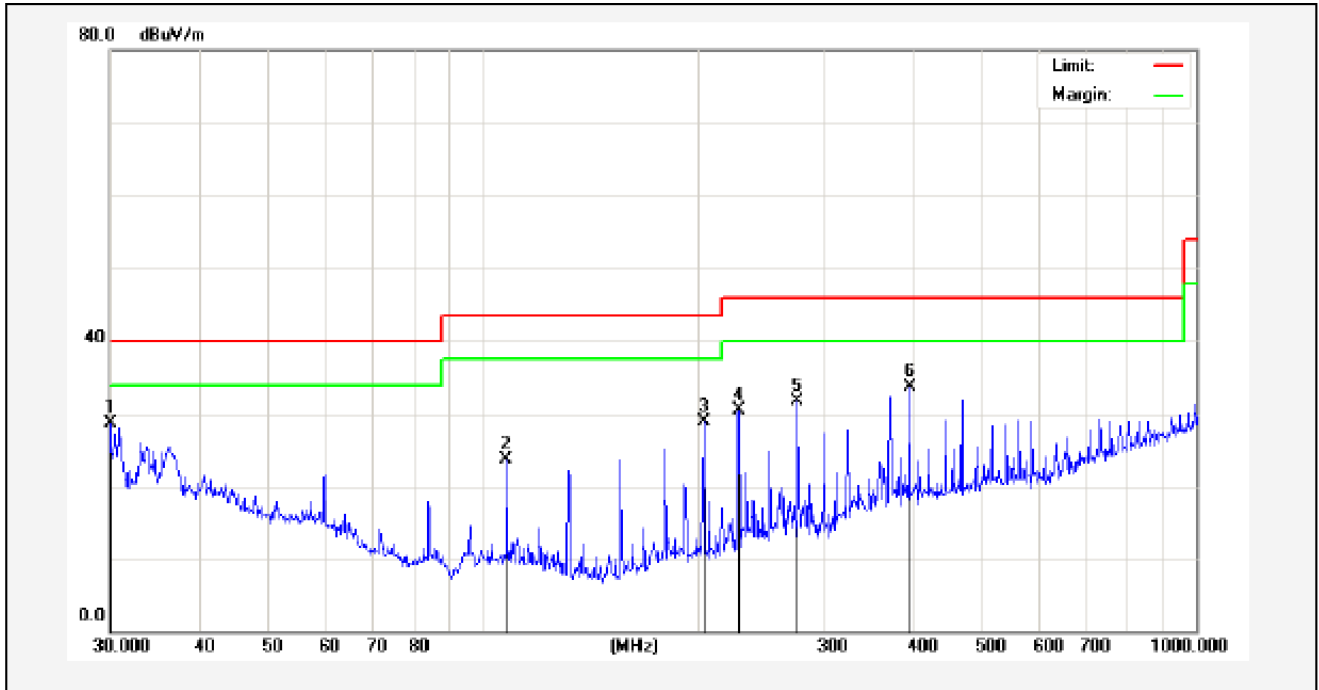

No.	Freq. (MHz)	Reading (dBuV/m)	Factor (dB/m)	Result (dBuV/m)	Limit (dBuV/)	Over Limit (dB)	Detector	Height (cm)	degree (deg)	Remark
1	30.0000	45.69	-16.95	28.74	40.00	-11.26	peak			
2	107.8877	44.30	-20.66	23.64	43.50	-19.86	peak			
3	204.2377	49.56	-20.71	28.85	43.50	-14.65	peak			
4	228.4904	49.76	-19.26	30.50	46.00	-15.50	peak			
5	276.1235	50.15	-18.38	31.77	46.00	-14.23	peak			
6	396.2415	46.63	-12.94	33.69	46.00	-12.31	peak			



Job No.:	011606497I	Polarization:	Vertical
Standard:	(RE)FCC PART 15C_3m	Power Source:	AC 240V, 60Hz
Test item:	Radiation Test (30~1000MHz)	Temp.(C)/Hum.(%RH):	24.3(C)/55%RH
Test Mode:	BT Mode	Distance:	3m

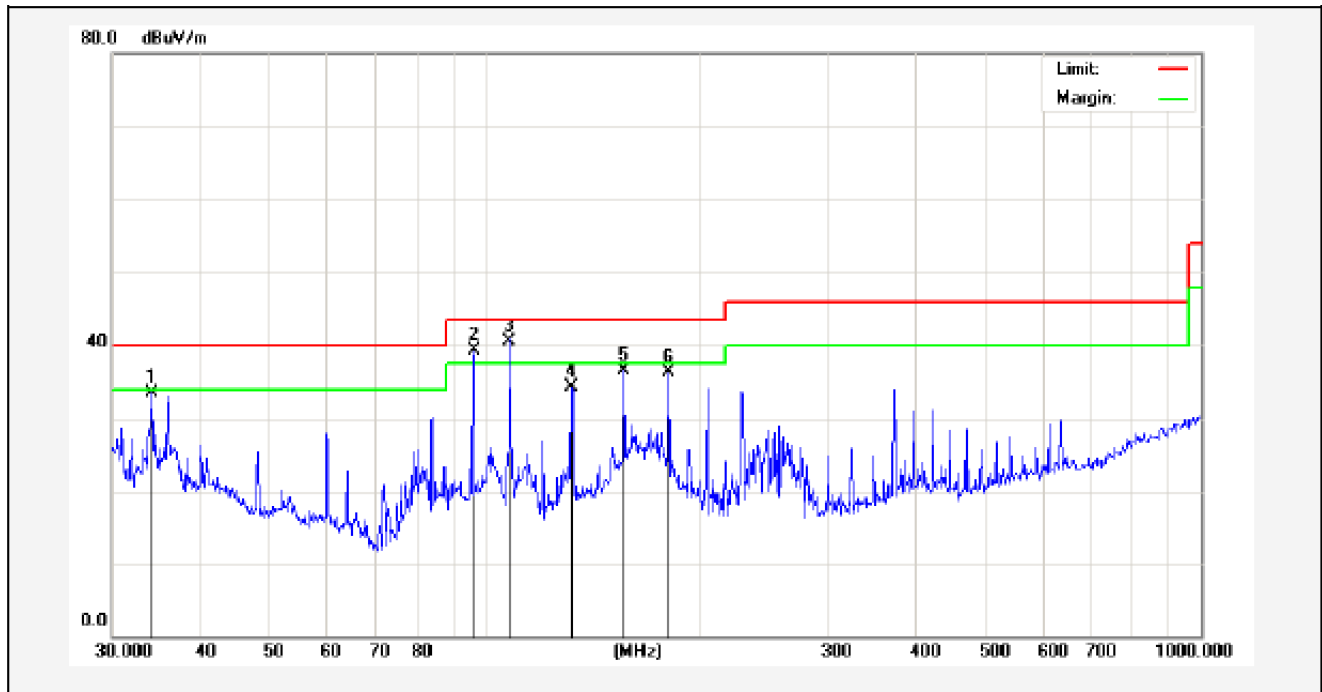

No.	Freq. (MHz)	Reading (dBuV/m)	Factor (dB/m)	Result (dBuV/m)	Limit (dBuV/)	Over Limit (dB)	Detector	Height (cm)	degree (deg)	Remark
1	34.0365	48.21	-14.80	33.41	40.00	-6.59	peak			
2	96.0986	55.27	-15.97	39.30	43.50	-4.20	peak			
3	107.8877	56.16	-15.66	40.50	43.50	-3.00	QP	100	0	
4	131.7577	52.22	-17.93	34.29	43.50	-9.21	peak			
5	155.9101	54.60	-18.06	36.54	43.50	-6.96	peak			
6	180.0165	53.14	-16.85	36.29	43.50	-7.21	peak			

Job No.:	011606497I	Polarization:	Horizontal
Standard:	(RE)FCC PART 15C_Class B_3m	Power Source:	AC 240V, 60Hz
Test item:	Radiation Test (Above 1GHz)	Temp.(C)/Hum.(%RH):	24.3(C)/55%RH
Test Mode:	TX(2402 MHz)	Distance:	3m

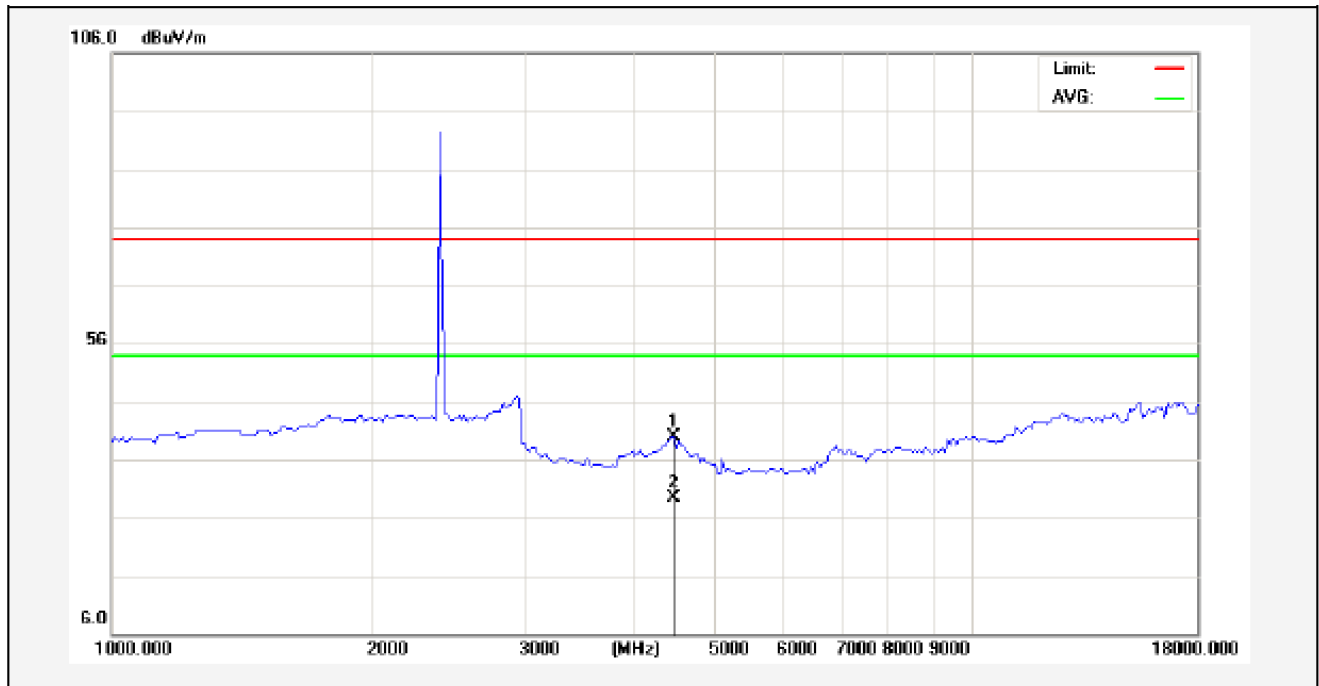

No.	Freq. (MHz)	Reading (dBuV/m)	Factor (dB/m)	Result (dBuV/m)	Limit (dBuV/)	Over Limit (dB)	Detector	Height (cm)	degree (deg)	Remark
1	4485.000	37.23	2.74	39.97	74.00	-34.03	peak			
2	4485.000	26.61	2.74	29.35	54.00	-24.65	AVG			



Job No.:	011606497I	Polarization:	Vertical
Standard:	(RE)FCC PART 15C_Class B_3m	Power Source:	AC 240V, 60Hz
Test item:	Radiation Test (Above 1GHz)	Temp.(C)/Hum.(%RH):	24.3(°C)/55%RH
Test Mode:	TX(2402 MHz)	Distance:	3m

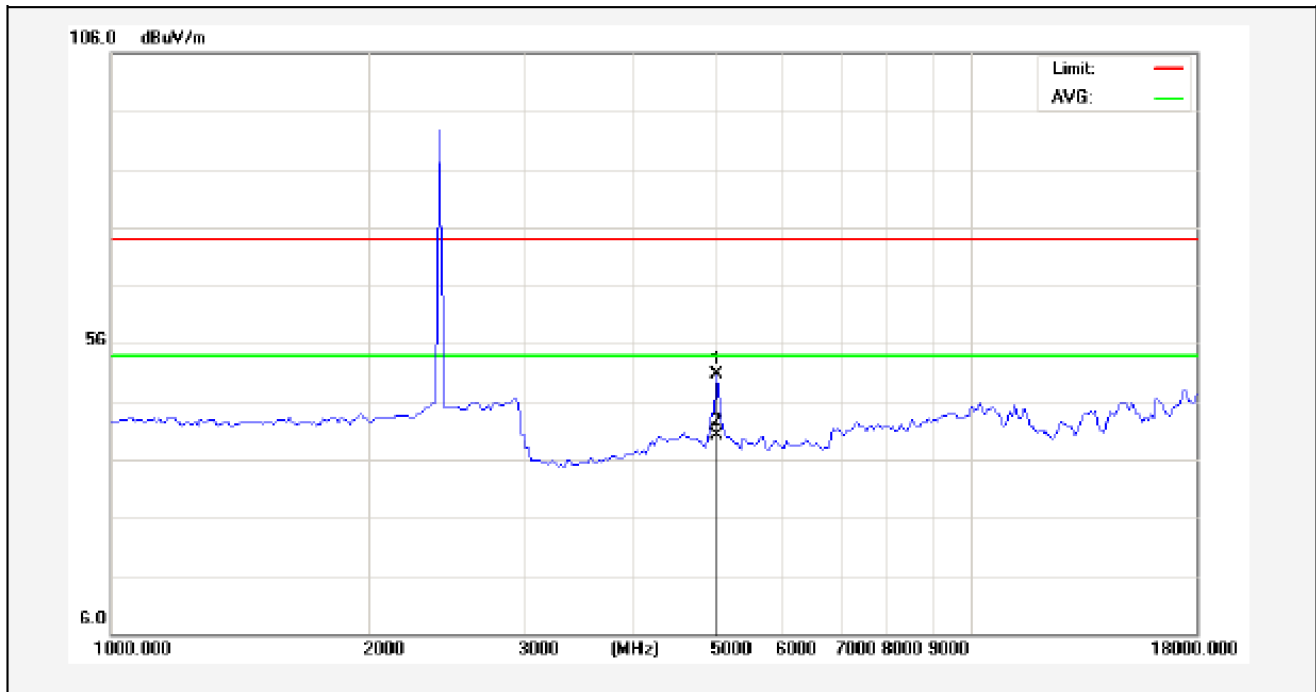

No.	Freq. (MHz)	Reading (dBuV/m)	Factor (dB/m)	Result (dBuV/m)	Limit (dBuV/)	Over Limit (dB)	Detector	Height (cm)	degree (deg)	Remark
1	5037.500	47.05	3.67	50.72	74.00	-23.28	peak			
2	5037.500	36.45	3.67	40.12	54.00	-13.88	AVG			



Job No.:	011606497I	Polarization:	Horizontal
Standard:	(RE)FCC PART 15C_Class B_3m	Power Source:	AC 240V, 60Hz
Test item:	Radiation Test (Above 1GHz)	Temp.(C)/Hum.(%RH):	24.3(°C)/55% RH
Test Mode:	TX(2441 MHz)	Distance:	3m

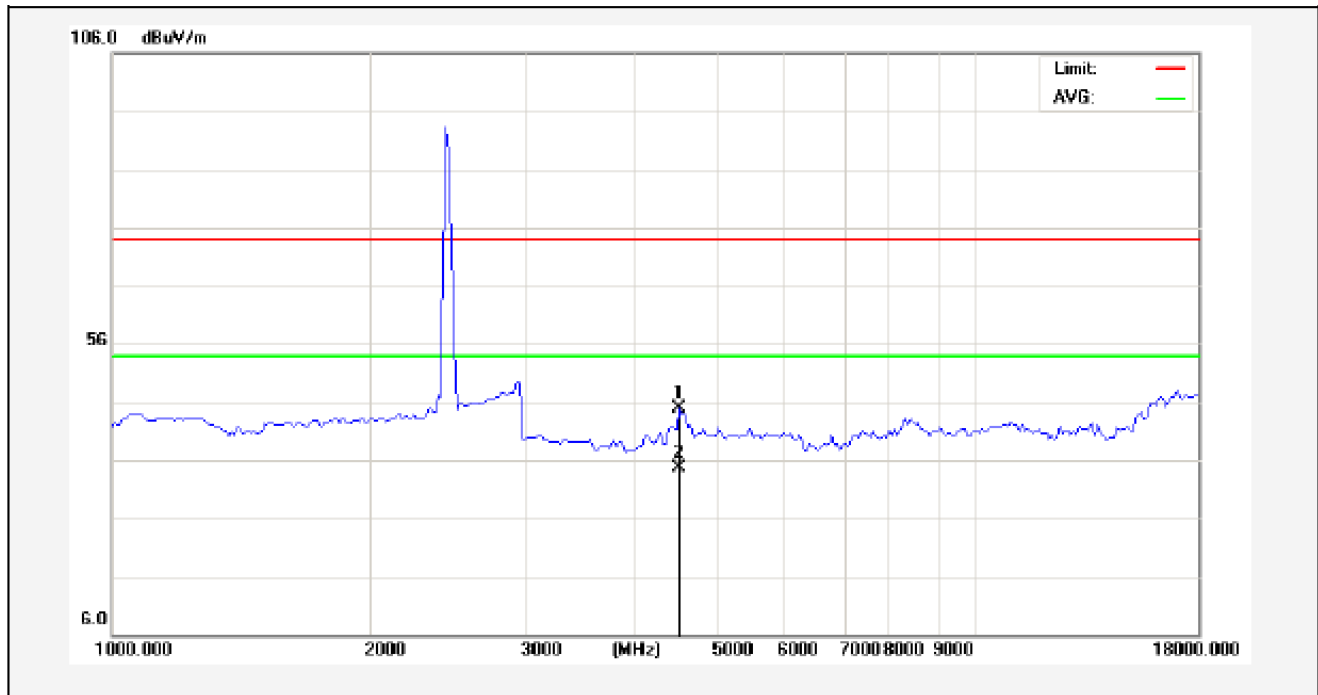

No.	Freq. (MHz)	Reading (dBuV/m)	Factor (dB/m)	Result (dBuV/m)	Limit (dBuV/)	Over Limit (dB)	Detector	Height (cm)	degree (deg)	Remark
1	4527.723	42.14	2.81	44.95	74.00	-29.05	peak			
2	4527.723	31.86	2.81	34.67	54.00	-19.33	AVG			

A M P

Job No.:	011606497I	Polarization:	Vertical
Standard:	(RE)FCC PART 15C_Class B_3m	Power Source:	AC 240V, 60Hz
Test item:	Radiation Test (Above 1GHz)	Temp.(C)/Hum.(%RH):	24.3(°C)/55%RH
Test Mode:	TX(2441 MHz)	Distance:	3m

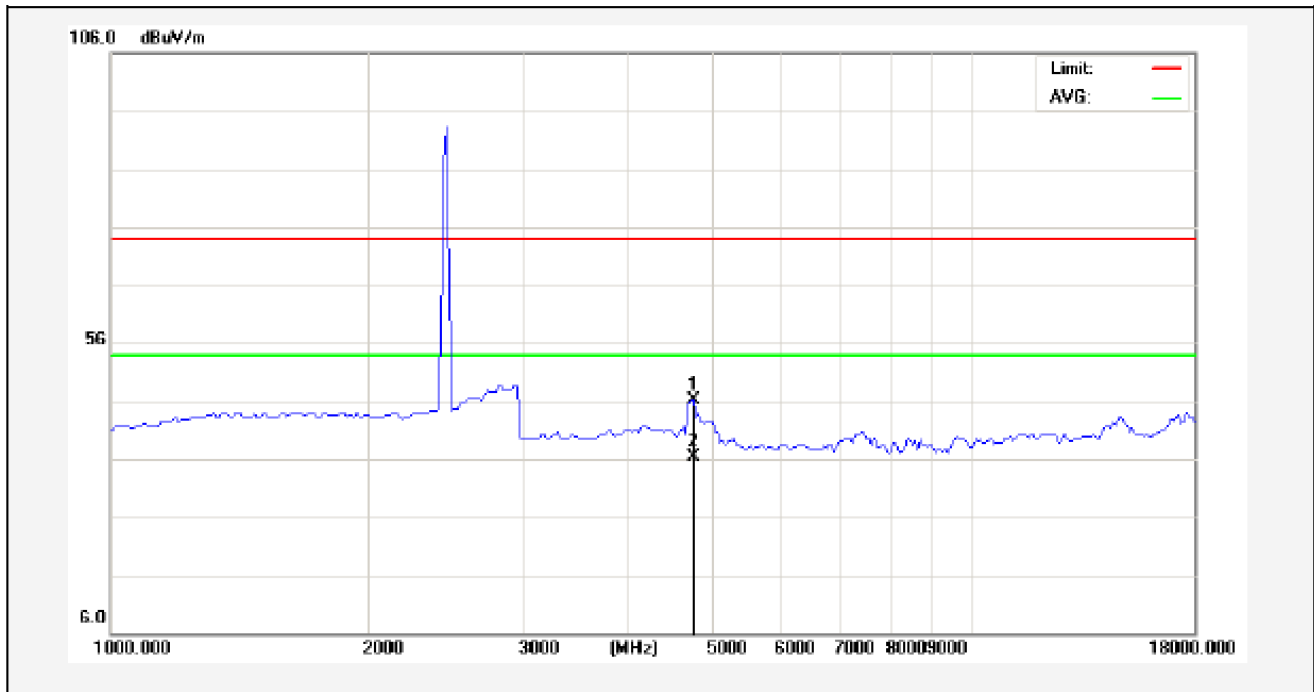

No.	Freq. (MHz)	Reading (dBuV/m)	Factor (dB/m)	Result (dBuV/m)	Limit (dBuV/)	Over Limit (dB)	Detector	Height (cm)	degree (deg)	Remark
1	4740.000	42.84	3.19	46.03	74.00	-27.97	peak			
2	4740.000	33.27	3.19	36.46	54.00	-17.54	AVG			



Job No.:	011606497I	Polarization:	Horizontal
Standard:	(RE)FCC PART 15C_Class B_3m	Power Source:	AC 240V, 60Hz
Test item:	Radiation Test (Above 1GHz)	Temp.(C)/Hum.(%RH):	24.3(°C)/55%RH
Test Mode:	TX(2480 MHz)	Distance:	3m

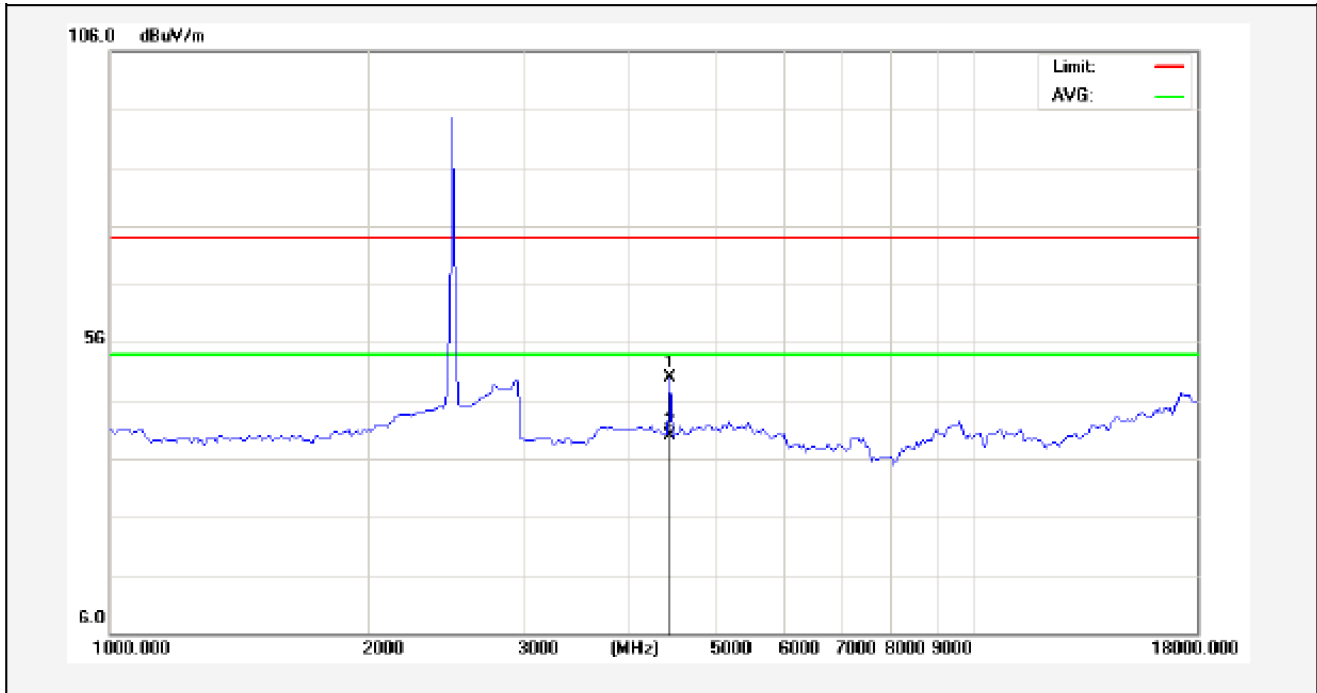

No.	Freq. (MHz)	Reading (dBuV/m)	Factor (dB/m)	Result (dBuV/m)	Limit (dBuV/)	Over Limit (dB)	Detector	Height (cm)	degree (deg)	Remark
1	4442.500	47.20	2.68	49.88	74.00	-24.12	peak			
2	4442.500	37.29	2.68	39.97	54.00	-14.03	AVG			



Job No.:	011606497I	Polarization:	Vertical
Standard:	(RE)FCC PART 15C_Class B_3m	Power Source:	AC 240V, 60Hz
Test item:	Radiation Test (Above 1GHz)	Temp.(C)/Hum.(%RH):	24.3(°C)/55%RH
Test Mode:	TX(2480 MHz)	Distance:	3m

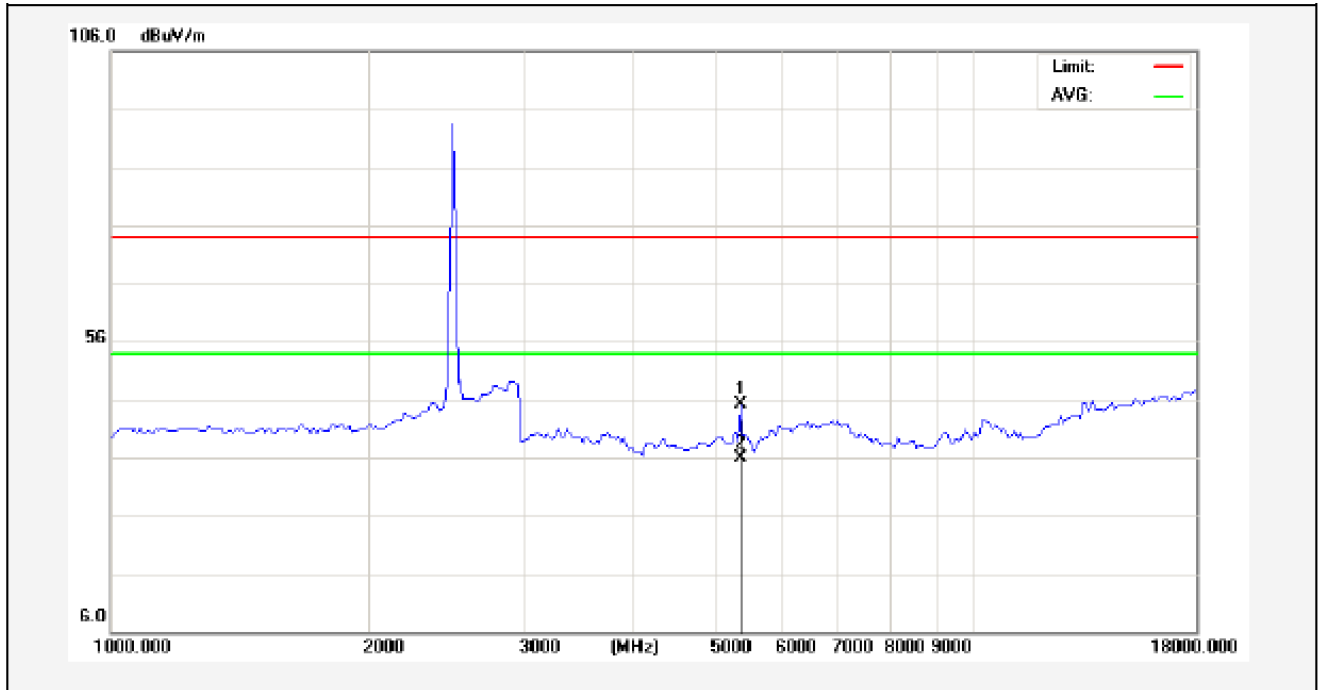

No.	Freq. (MHz)	Reading (dBuV/m)	Factor (dB/m)	Result (dBuV/m)	Limit (dBuV/)	Over Limit (dB)	Detector	Height (cm)	degree (deg)	Remark
1	5377.500	41.25	3.88	45.13	74.00	-28.87	peak			
2	5377.500	31.91	3.88	35.79	54.00	-18.21	AVG			

A M P

5. CHANNEL SEPARATION TEST

5.1 Measurement Procedure

The EUT must have its hopping function enabled. Using the following spectrum analyzer settings:

1. Span= Wide enough to capture the peaks of two adjacent channels
2. Set the RBW = 100 kHz.
3. Set the VBW = 100 kHz.
4. Sweep time = auto couple.
5. Detector function = peak.
6. Trace mode = max hold.
7. Allow trace to fully stabilize.

5.2 Test SET-UP

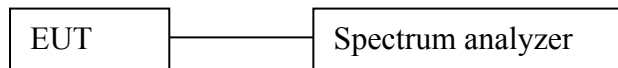

5.3 Test Equipment

Item	Equipment	Manufacturer	Model No.	Serial No.	Last Cal.	Cal. Interval
1.	Spectrum Analysis	Agilent	E4407B	US39390582	Apr. 17, 2016	1 Year
2.	Preamplifier	Instruments corporation	EMC011830	980100	Apr. 17, 2016	1 Year
3.	EMI Test Receiver	Rohde & Schwarz	ESPI	101604	Apr. 17, 2016	1 Year
4.	Double Ridged Horn Antenna	Instruments corporation	GTH-0118	351600	Apr. 20, 2016	1 Year
5.	Bilog Broadband Antenna	Schwarzbeck	VULB9163	VULB 9163-289	Apr. 20, 2016	1 Year
6.	Pre-amplifier	SONOMA	310N	186860	Apr. 17, 2016	1 Year
7.	EMI Test Software EZ-EMC	SHURPLE	N/A	N/A	N/A	N/A
8	Power Sensor	DAER	RPR3006W	15I00041SN046	Jun. 28, 2016	1 Year
9	MXA Spectrum Analysis	Agilent	N9020A	MY51170037	Jun. 28, 2016	1 Year
10	MXG RF Vector Signal Generator	Agilent	N5182A	MY48180656	Jun. 28, 2016	1 Year
11	Signal Generator	Agilent	E4421B	MY41000743	Jun. 28, 2016	1 Year
12	DC Power supply	IV	IV-8080	YQSB0096	Jun. 28, 2016	1 Year
13	TEMP&HUMI PROGRAMMABLE CHAMBER	Bell Group	BE-THK-150M8	SE-0137	Mar 16, 2016	1 Year

5.4 Test Results

Test Item	: Frequency Separation	Test Mode	: CH Low ~ CH High
Test Voltage	: AC 240V, 60Hz	Temperature	: 24°C
Test Result	: PASS	Humidity	: 55%RH

Channel	Frequency (MHz)	Separation Read Value (kHz)	Limit (kHz)	Modulation Mode
Low	2401	1005	927.8	BDR
Mid	2441	1005	930.1	BDR
High	2480	1005	931.9	BDR
Low	2401	1005	842.7	EDR
Mid	2441	1005	840.0	EDR
High	2480	1029	840.7	EDR

Remark:

1. The limit of mode (EDR) is 2/3 of 20dB BW;
2. The EDR was tested on ($\pi/4$ DQPSK, 8DPSK) modes, only the worst data of ($\pi/4$ DQPSK) is attached in the following pages.

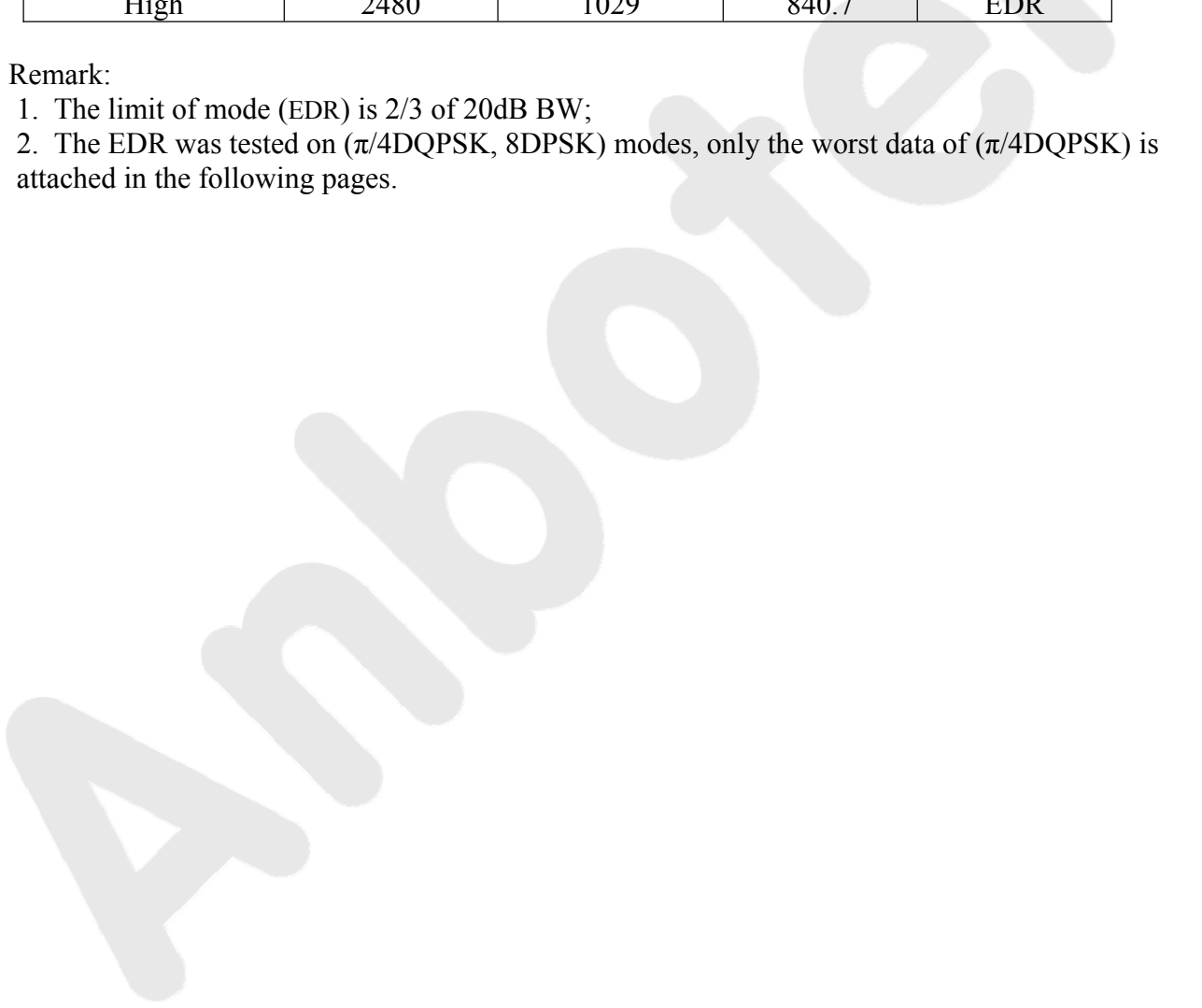



Test Mode: BDR---Low



Test Mode: BDR---Mid



Test Mode: BDR---High

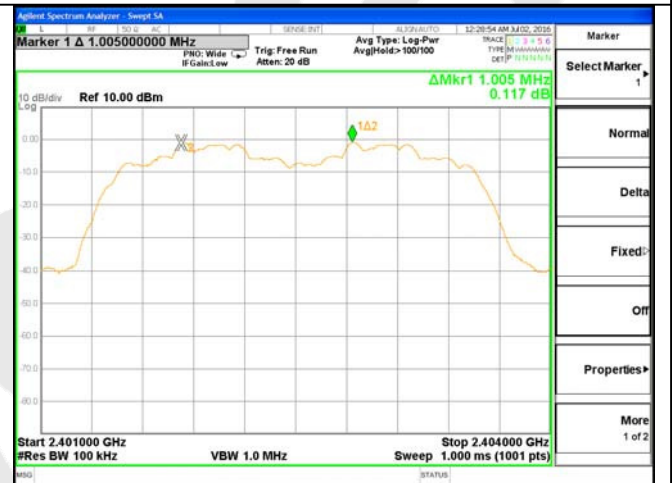

Test Mode: EDR---Low



Test Mode: EDR---Mid



Test Mode: EDR---High

6. 20DB BANDWIDTH TEST

6.1 Measurement Procedure

Using the following spectrum analyzer settings:

1. Span= approximately 2 to 3 times the 20dB bandwidth, centered on a hopping channel.
2. Set the RBW = 30 kHz.
3. Set the VBW = 100 kHz.
4. Sweep time = auto couple.
5. Detector function = peak.
6. Trace mode = max hold.
7. Allow trace to fully stabilize.

6.2 Test SET-UP

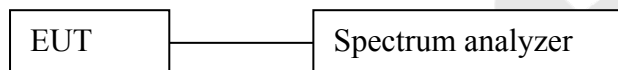

6.3 Test Equipment

Same as the equipment listed in 5.3.

6.4 Test Results

Test Item	: 20dB BW	Test Mode	: CH Low ~ CH High
Test Voltage	: AC 240V, 60Hz	Temperature	: 24°C
Test Result	: PASS	Humidity	: 55%RH

Channel	Frequency (MHz)	20dB Down BW(kHz)	Modulation Mode
Low	2402	927.8	BDR
Mid	2441	930.1	BDR
High	2480	931.9	BDR
Low	2402	1264.0	EDR
Mid	2441	1260.0	EDR
High	2480	1261.0	EDR

Remark: The EDR was tested on ($\pi/4$ DQPSK, 8DPSK) modes, only the worst data of ($\pi/4$ DQPSK) is attached in the following pages.

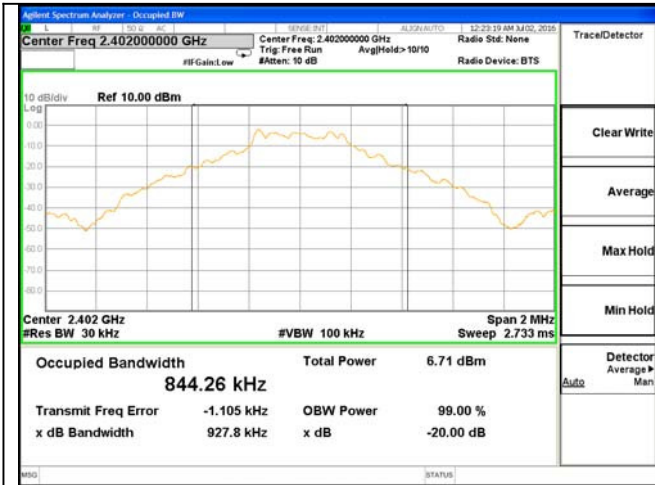

Test Mode: BDR---Low

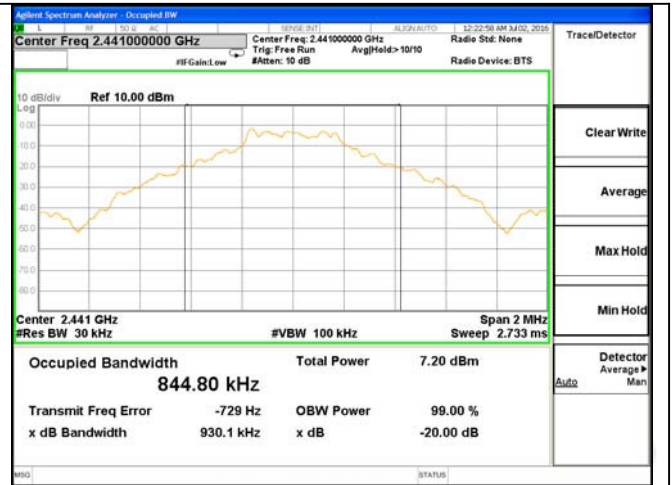

Test Mode: BDR---Mid

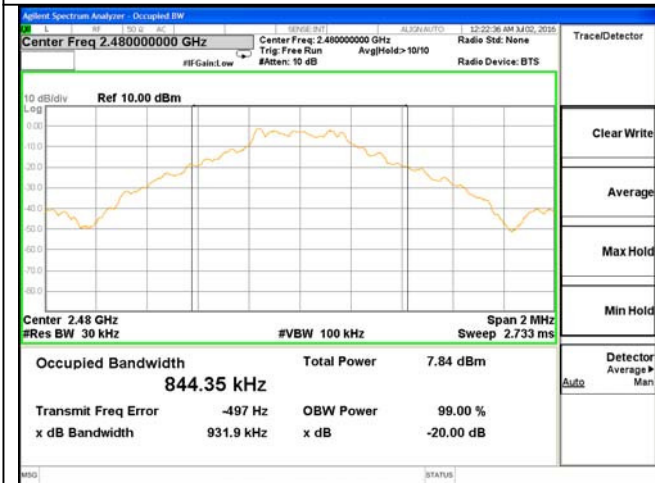

Test Mode: BDR---High

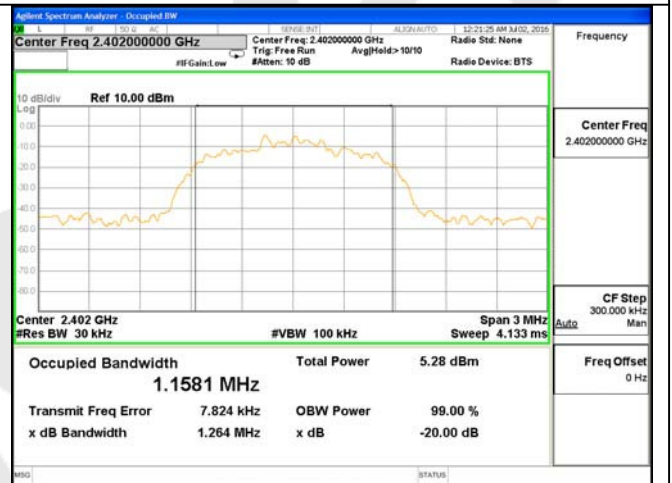

Test Mode: EDR---Low

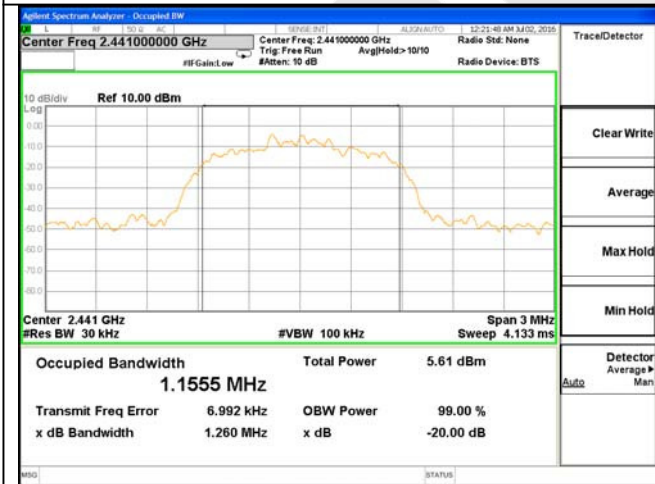

Test Mode: EDR---Mid

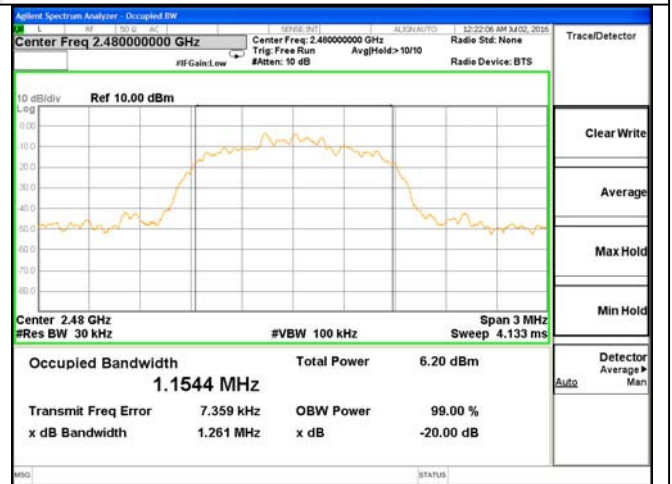

Test Mode: EDR---High

7. QUANTITY OF HOPPING CHANNEL TEST

7.1 Measurement Procedure

The EUT must have its hopping function enabled. Using the following spectrum analyzer setting:

1. Span= the frequency band of operation
2. Set the RBW = 1 MHz.
3. Set the VBW = 1 MHz.
4. Sweep time = auto couple.
5. Detector function = peak.
6. Trace mode = max hold.
7. Allow trace to fully stabilize.

7.2 Test SET-UP

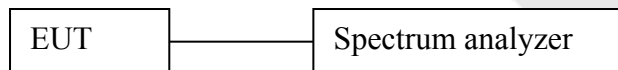

7.3 Test Equipment

Same as the equipment listed in 5.3.

7.4 Test Results

Test Item	: Number of Hopping Frequency	Test Mode	: CH Low ~ CH High
Test Voltage	: AC 240V, 60Hz	Temperature	: 24°C
Test Result	: PASS	Humidity	: 55%RH

Hopping Channel Frequency Range	Quantity of Hopping Channel	Quantity of Hopping Channel
2402-2480	79	> 15

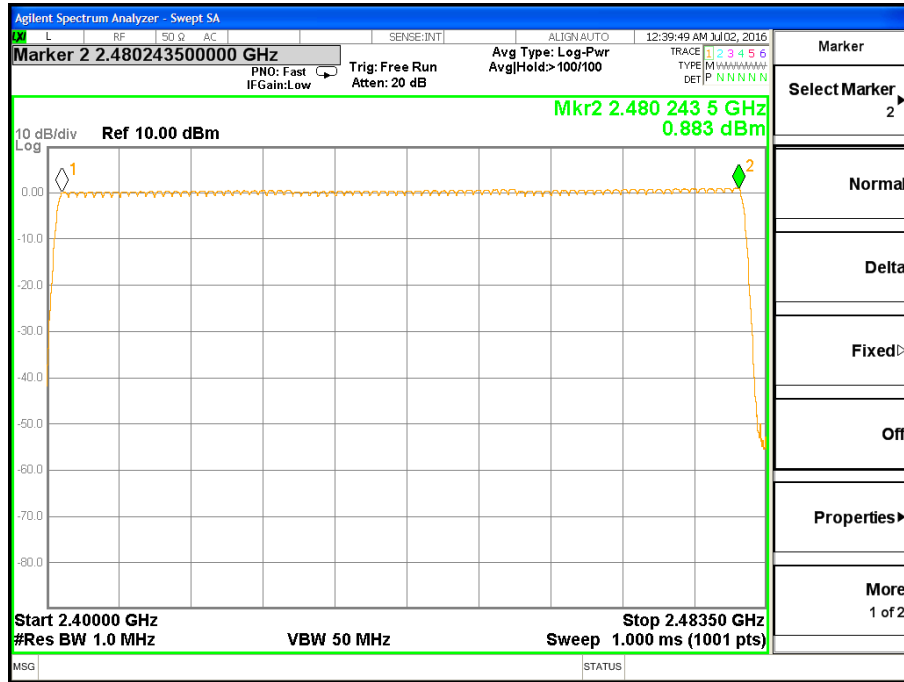

Anbotek

8. DWELL TIME TEST

8.1 Measurement Procedure

The EUT must have its hopping function enabled. Use the following spectrum analyzer settings:

1. Span= zero span, centered on a hopping channel
2. Set the RBW = 1 MHz.
3. Set the VBW = 1 MHz.
4. Sweep time = as necessary to capture the entire dwell time per hopping channel.
5. Detector function = peak.
6. Trace mode = max hold.
7. Allow trace to fully stabilize.

8.2 Test SET-UP

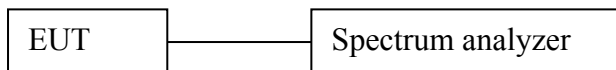

8.3 Test Equipment

Same as the equipment listed in 5.3.

8.4 Test Results

Test Item	: Time of Occupancy	Test Mode	: CH Low ~ CH High
Test Voltage	: AC 240V, 60Hz	Temperature	: 24°C
Test Result	: PASS	Humidity	: 55%RH

Package Type	Pulse width (ms)	Time slot length(ms)	Dwell time (ms)	Limit (s)	Modulation
DH1	0.366	time slot length *1600/2 /79 * 31.6	117.12	0.4	BDR
DH3	1.375	time slot length *1600/4 /79 * 31.6	220.00	0.4	BDR
DH5	2.864	time slot length *1600/6 /79 * 31.6	305.49	0.4	BDR
DH1	0.376	time slot length *1600/2 /79 * 31.6	120.32	0.4	EDR
DH3	1.645	time slot length *1600/4 /79 * 31.6	263.20	0.4	EDR
DH5	2.870	time slot length *1600/6 /79 * 31.6	306.13	0.4	EDR

Remark: The EDR was tested on ($\pi/4$ DQPSK, 8DPSK) modes, only the worst data of ($\pi/4$ DQPSK) is attached in the following pages.



Test Mode: BDR---DH1



Test Mode: BDR---DH3



Test Mode: BDR---DH5



Test Mode: EDR---DH1



Test Mode: EDR---DH1



Test Mode: EDR---DH3

9. MAXIMUM PEAK OUTPUT POWER TEST

9.1 Measurement Procedure

- a. Check the calibration of the measuring instrument(SA) using either an internal calibrator or a known signal from an external generator.
- b. Turn on the EUT and connect it to measurement instrument. Then set it to any one convenient frequency within its operating range. Set a reference level on the measuring instrument equal to the highest peak value.
- c. The center frequency of the spectrum analyzer is set to the fundamental frequency and using proper RBW and VBW setting.
- d. Measure the captured power within the band and recording the plot.
- e. Repeat above procedures until all frequencies required were complete.

Using the following spectrum analyzer settings:

1. Span= approximately 5 times the 20dB bandwidth, centered on a hopping channel
2. Set the RBW = 3 MHz.
3. Set the VBW = 3 MHz.
4. Sweep time = auto couple.
5. Detector function = peak.
6. Trace mode = max hold.
7. Allow trace to fully stabilize.

9.2 Test SET-UP

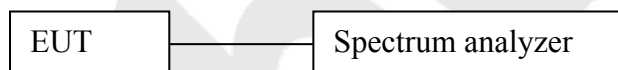

9.3 Test Equipment

Same as the equipment listed in 5.3.

9.4 Test Results

Test Item	: Max. peak output power	Test Mode	: CH Low ~ CH High
Test Voltage	: AC 240V, 60Hz	Temperature	: 24°C
Test Result	: PASS	Humidity	: 55%RH

Channel Frequency (MHz)	Peak Power output(mW)	Peak Power output(dBm)	Peak Power Limit(mW)	Results	Modulation
2402	1.020	0.085	1000	PASS	BDR
2441	1.114	0.468	1000	PASS	BDR
2480	1.270	1.037	1000	PASS	BDR
2402	1.008	0.036	125	PASS	EDR
2441	1.095	0.396	125	PASS	EDR
2480	1.240	0.934	125	PASS	EDR

Remark: The EDR was tested on ($\pi/4$ DQPSK, 8DPSK) modes, only the worst data of ($\pi/4$ DQPSK) is attached in the following pages.

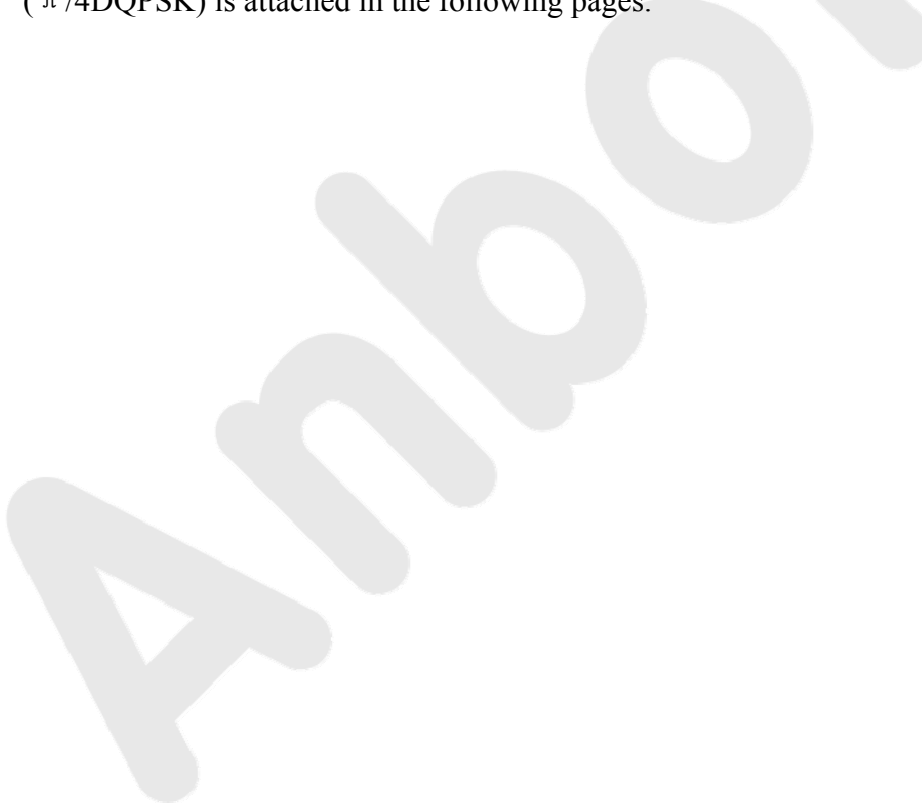

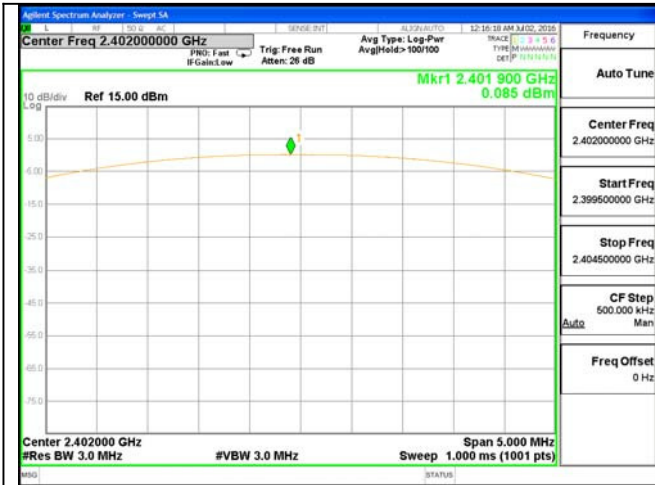

Test Mode: BDR---Low

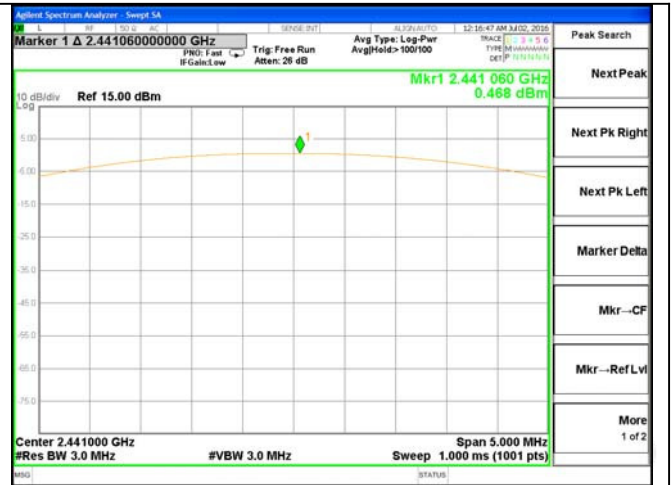

Test Mode: BDR---Mid

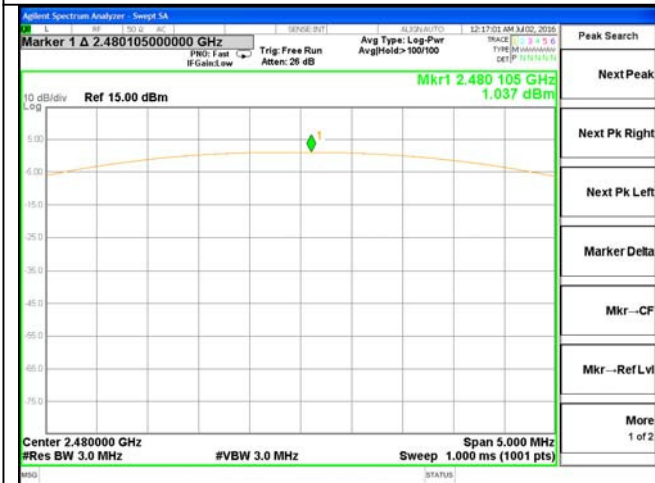

Test Mode: BDR---High

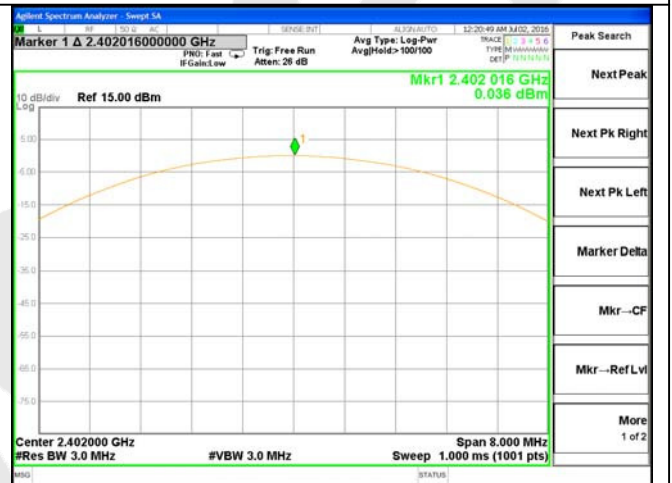

Test Mode: EDR---Low

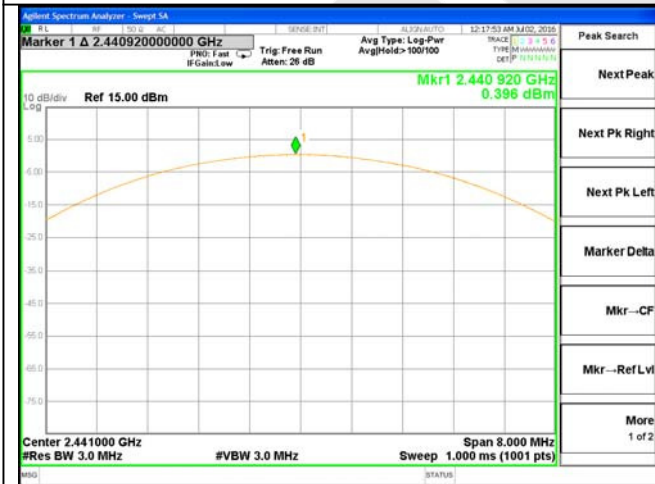

Test Mode: EDR---Mid

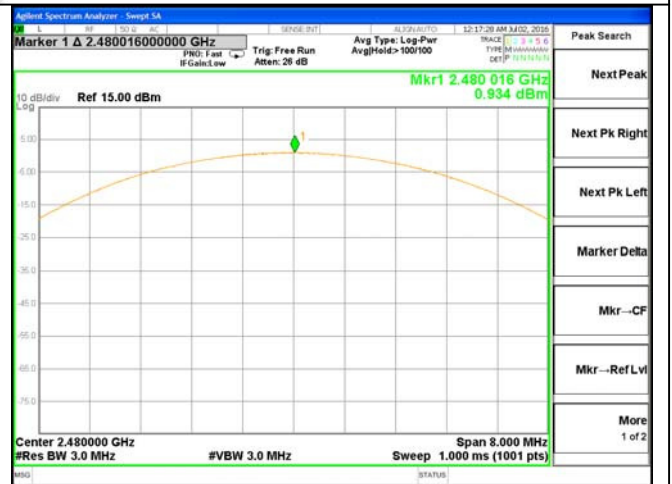

Test Mode: EDR---High

10. BAND EDGE TEST

10.1 Measurement Procedure

A) Conducted Emission method:

1. Check the calibration of the measuring instrument using either an internal calibrator or a known signal from an external generator.
2. Position the EUT without connection to measurement instrument. Put it on the Rotated table and turn on the EUT and make it operate in transmitting mode. Then set it to low Channel and High Channel within its operating range, and make sure the instrument is operated in its linear range.
3. Set spectrum analyzer RBW 100kHz and VBW 300kHz convenient frequency span including 100kHz bandwidth from band edge,
4. Measurement the highest amplitude appearing on spectral display and set it as a reference level. Plot the graph with marking the highest point and edge frequency.
5. Report above procedures until all measured frequencies were complete.

B) Radiated Emission method:

The EUT is placed on a turn table which is 0.1 meter high above the ground. The turn table can rotate 360 degrees to determine the position of the maximum emission level. The EUT is set 3 meters away from the receiving antenna which is mounted on a antenna tower. The antenna can be moved up and down from 1 to 4 meters to find out the maximum emission level. Rotated the EUT through three orthogonal axes to determine the maximum emissions, both horizontal and vertical polarization of the antenna are set on test. The EUT is tested in 9*6*6 Chamber. for Radiated emissions restricted band RBW= 1 MHz, VBW= 3 MHz.

10.2 Test SET-UP

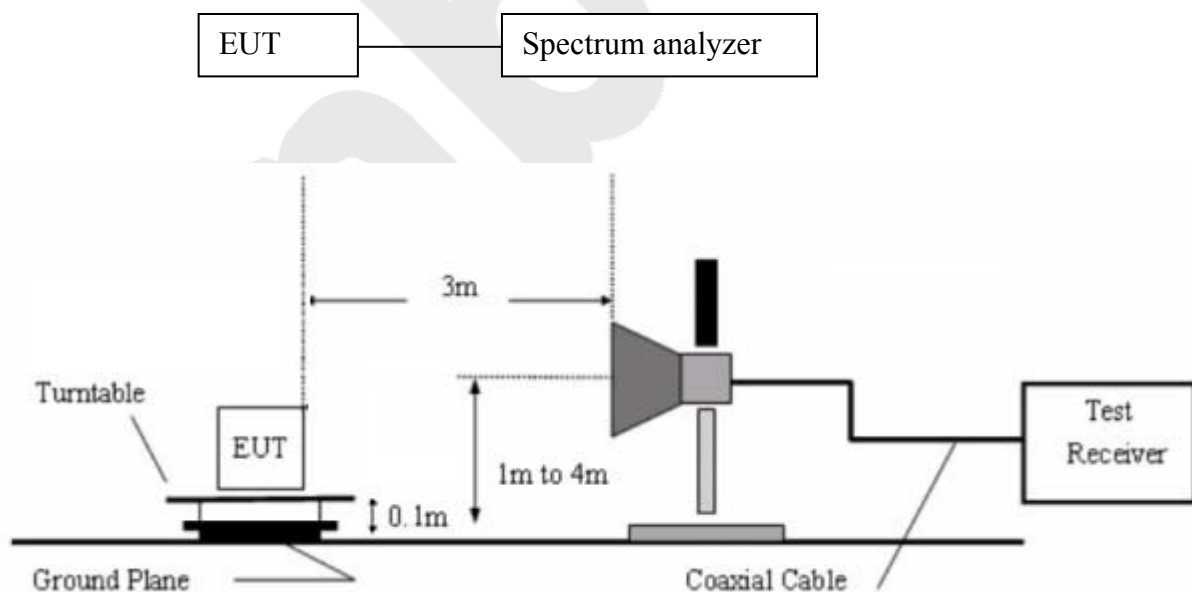

10.3 Test Equipment

Same as the equipment listed in 5.3.

10.4 Test Results

Pass.

Please refer the following data.

Test Item	: Band eadge	Test Mode	: CH Low ~ CH High
Test Voltage	: AC 240V, 60Hz	Temperature	: 24°C
Test Result	: PASS	Humidity	: 55%RH

For Hopping Mode:

Remark: The EDR was tested on ($\pi/4$ DQPSK, 8DPSK) modes, only the worst data of ($\pi/4$ DQPSK) is attached in the following pages.

Anbotek



Test Mode: BDR



Test Mode: BDR

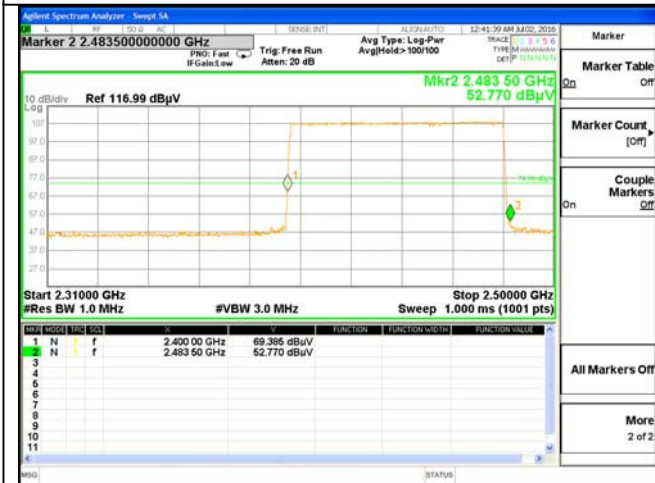

Test Mode: EDR



Test Mode: EDR

Test Item	: Band edge	Test Mode	: CH Low ~ CH High
Test Voltage	: AC 240V, 60Hz	Temperature	: 24°C
Test Result	: PASS	Humidity	: 55%RH

For Non-Hopping Mode:

1. Conducted Test

Frequency (MHz)	Peak Power Output(dBm)	Emission read Value(dBm)	Result of Band edge(dBc)	Band edge Limit(dBc)	Modulation
<2400	0.101	-38.937	38.836	>20dBc	BDR
	-0.369	-29.929	30.298	>20dBc	EDR
>2483.5	1.020	-53.922	52.902	>20dBc	BDR
	0.306	-51.299	50.993	>20dBc	EDR

2. Radiated emission Test

Frequency (MHz)	Antenna polarization (H/V)	Emission (dBuV/m)		Band edge Limit (dBuV/m)		Modulation
		PK	AV	PK	AV	
<2400	V	52.16	40.23	74.00	54.00	BDR
	V	51.42	39.25	74.00	54.00	EDR
>2483.5	V	49.37	37.68	74.00	54.00	BDR
	V	48.44	37.24	74.00	54.00	EDR

Remark: The EDR was tested on ($\pi/4$ DQPSK, 8DPSK) modes, only the worst data of ($\pi/4$ DQPSK) is attached in the following pages.



Test Mode: BDR



Test Mode: BDR

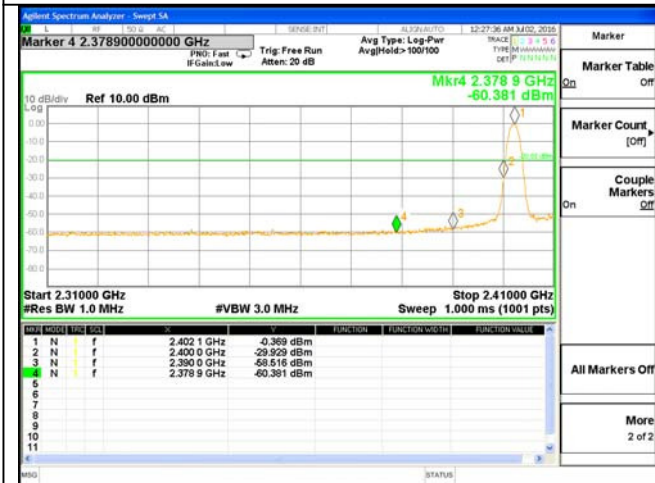

Test Mode: EDR



Test Mode: EDR

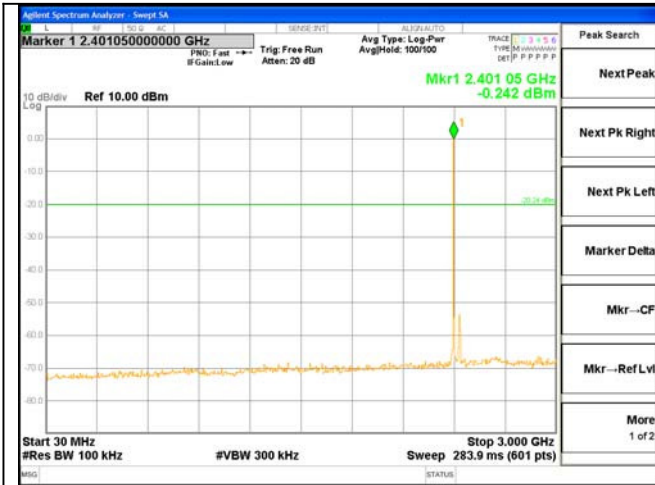

Test Mode: BDR---Low

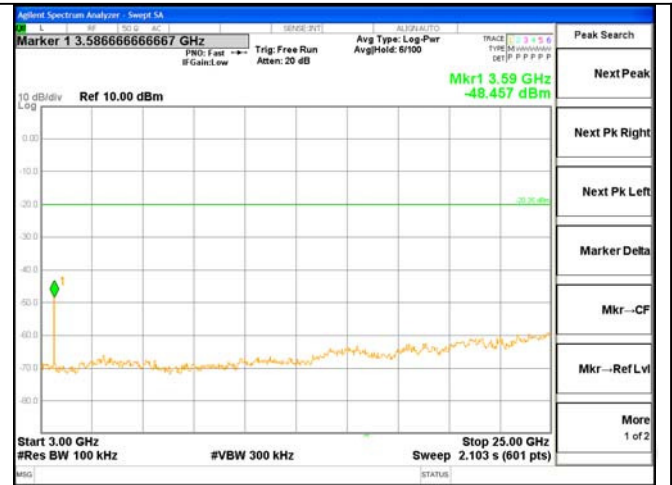

Test Mode: BDR---Low

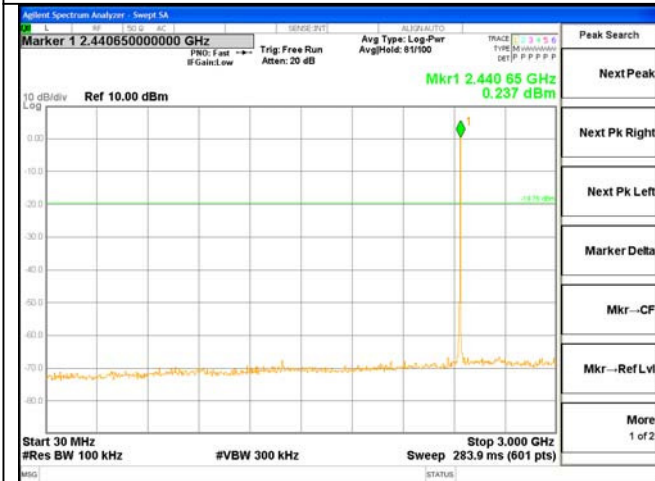

Test Mode: BDR---Mid



Test Mode: BDR---Mid

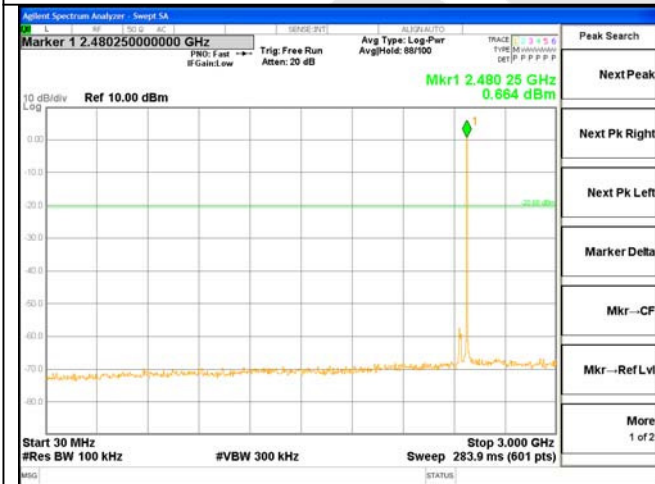

Test Mode: BDR---High

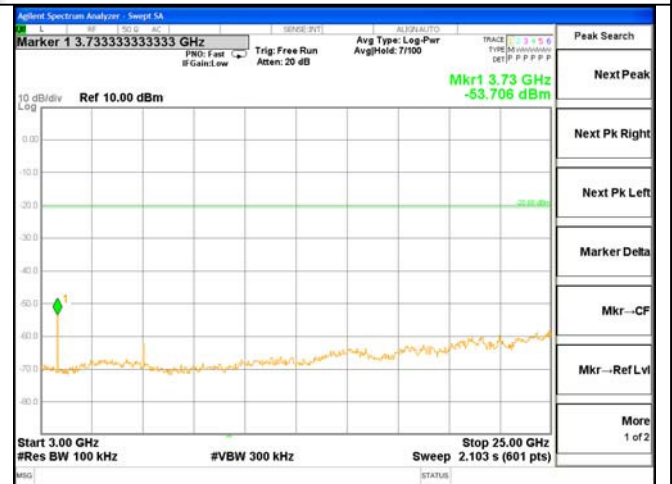

Test Mode: BDR---High

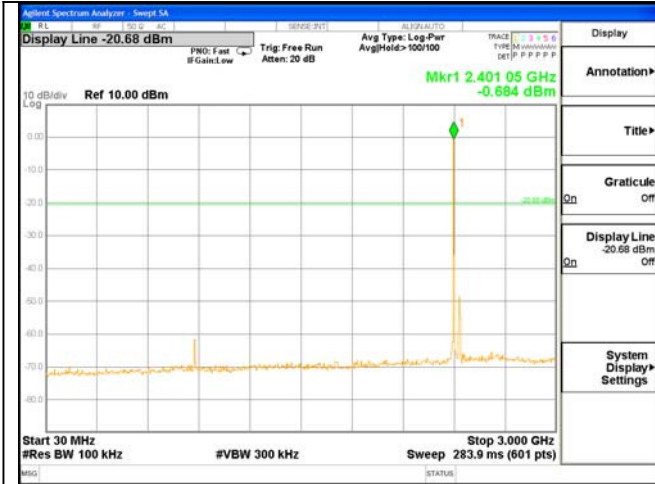

Test Mode: EDR---Low



Test Mode: EDR---Low

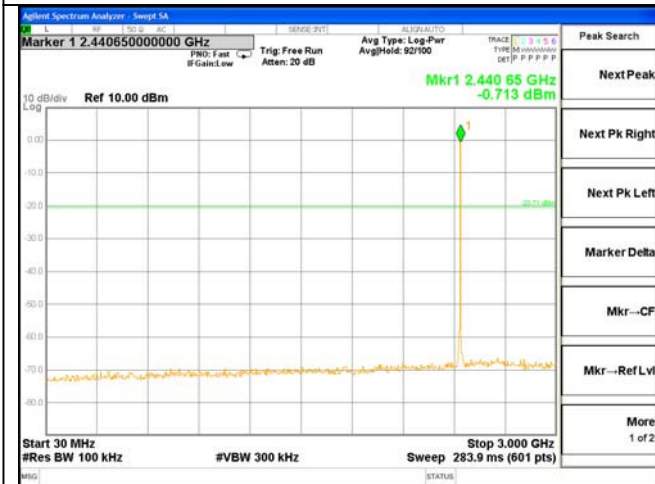

Test Mode: EDR---Mid



Test Mode: EDR---Mid

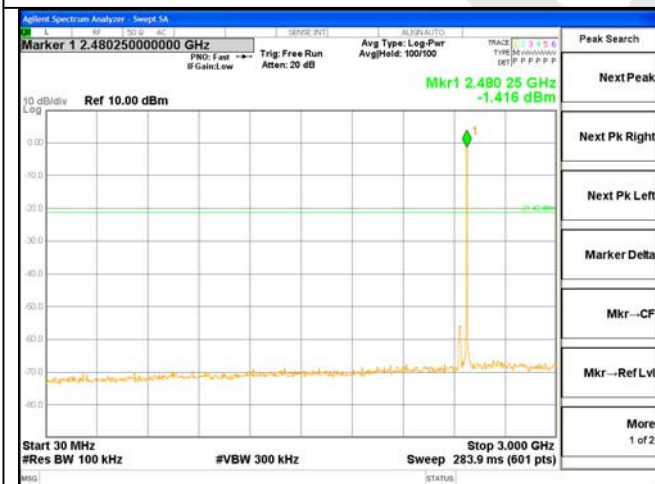

Test Mode: EDR---High



Test Mode: EDR---High

11. ANTENNA APPLICATION

11.1 Antenna requirement

The EUT'S antenna is met the requirement of FCC part 15C section 15.203 and 15.247.

FCC part 15C section 15.247 requirements:

Systems operating in the 2402-2480MHz band that are used exclusively for fixed, point-to-point operations may employ transmitting antennas with directional gain greater than 6dBi provided the maximum peak output power of the intentional radiator is reduced by 1dB for every 3dB that the directional gain of the antenna exceeds 6dBi.

11.2 Result

The EUT's antenna used a PCB Antenna, The antenna's gain is 1.2 dBi and meets the requirement.

BT Antenna

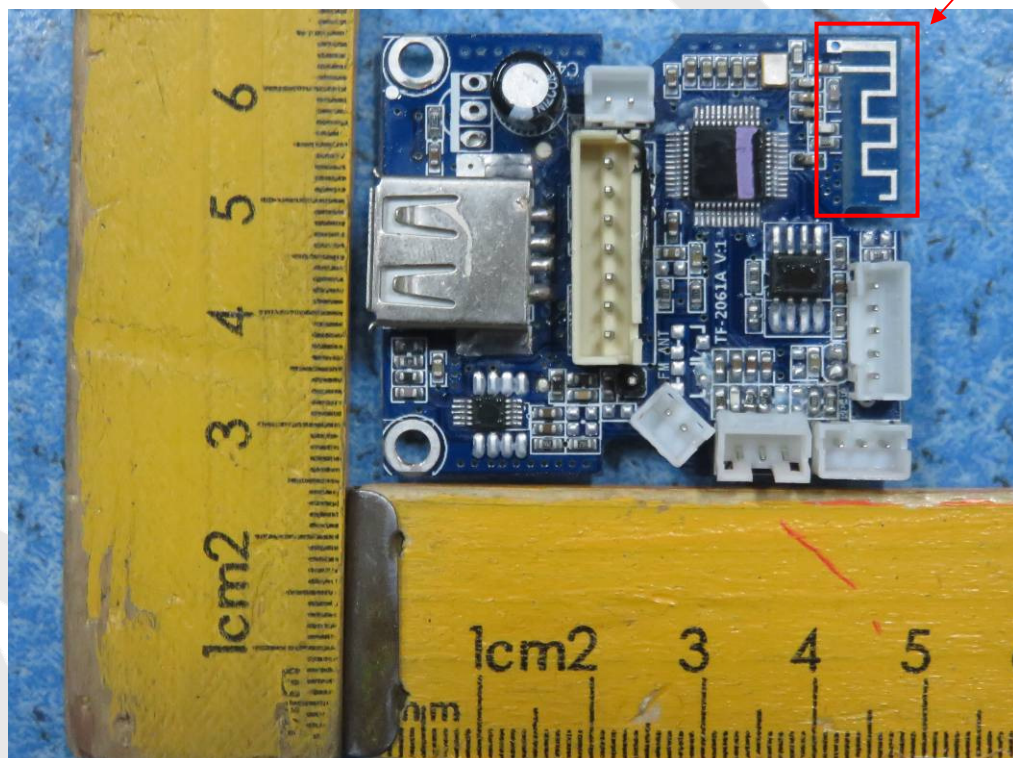

12. TEST SETUP PHOTOGRAPH

12.1. Photo of Conducted Emission Measurement



12.2. Photo of Radiation Emission Test





Anbotek

APPENDIX I (EXTERNAL PHOTOS)







APPENDIX II (INTERNAL PHOTOS)

