

FCC RADIO TEST REPORT

FCC ID: 2AITNWAVE

Product: wifi extender

Trade Mark: N/A

Model No.: 805600

Family Model: N/A

Report No.: S21010401002002

Issue Date: 26 Jan. 2021

Prepared for

Powerstick .com Inc

29 Camelot Drive, Ottawa ,Ontario, Canada, K2G 5W6

Prepared by

Shenzhen NTEK Testing Technology Co., Ltd.

1/F, Building E, Fenda Science Park Sanwei, Xixiang, Bao'an

District Shenzhen, Guangdong, China

Tel.: 400-800-6106, 0755-3699 5508

Website:<http://www.ntek.org.cn>

TEST RESULT CERTIFICATION

Applicant's name : Powerstick .com Inc
Address : 29 Camelot Drive, Ottawa ,Ontario, Canada, K2G 5W6
Manufacturer's Name : Shen Zhen Coexistence Electronics Co.,Ltd
Address : No.601-605, Building B, Airway Avenue 30th, xixiang Bao'an district, Shenzhen China

Product description

Product name : wifi extender
Model and/or type reference : 805600
Family Model : N/A

Standards : FCC Part15.407

Test procedure : ANSI C63.10-2013 and KDB 789033 D02 General UNII Test Procedures New Rules v02r01
FCC KDB 662911 D01 Multiple Transmitter Output v02r01

This device described above has been tested by NTEK, and the test results show that the equipment under test (EUT) is in compliance with the FCC requirements. And it is applicable only to the tested sample identified in the report.

This report shall not be reproduced except in full, without the written approval of NTEK, this document may be altered or revised by NTEK, personnel only, and shall be noted in the revision of the document.

Date of Test

Date (s) of performance of tests : 04 Jan. 2021 ~ 26 Jan. 2021

Date of Issue : 26 Jan. 2021

Test Result : Pass

Testing Engineer : [Signature: Mary Hu]
(Mary Hu)

Technical Manager : [Signature: Jason Chen]
(Jason Chen)

Authorized Signatory : [Signature: Alex]
(Alex Li)

Table of Contents

	Page
1. SUMMARY OF TEST RESULTS	6
1.1 FACILITIES AND ACCREDITATIONS	7
1.2 MEASUREMENT UNCERTAINTY	7
2. GENERAL INFORMATION	8
2.1 GENERAL DESCRIPTION OF EUT	8
2.2 DESCRIPTION OF TEST MODES	10
2.3 BLOCK DIGRAM SHOWING THE CONFIGURATION OF SYSTEM TESTED	11
2.4 DESCRIPTION OF SUPPORT UNITS(CONDUCTED MODE)	12
2.5 EQUIPMENTS LIST FOR ALL TEST ITEMS	13
3. EMC EMISSION TEST	15
3.1 CONDUCTED EMISSION MEASUREMENT	15
3.1.1 APPLICABLE STANDARD	15
3.1.2 CONFORMANCE LIMIT	15
3.1.3 TEST CONFIGURATION	15
3.1.4 TEST PROCEDURE	15
3.2 RADIATED EMISSION MEASUREMENT	20
3.2.1 APPLICABLE STANDARD	20
3.2.2 CONFORMANCE LIMIT	20
3.2.3 MEASURING INSTRUMENTS	20
3.2.4 TEST CONFIGURATION	21
3.2.5 TEST PROCEDURE	22
3.2.6 TEST RESULTS (9KHZ – 30 MHZ)	23
3.2.7 TEST RESULTS (30MHZ – 1GHZ)	24
3.2.8 TEST RESULTS (1GHZ-18GHZ)	28
3.2.10 TEST RESULTS (18GHZ-40GHZ)	30
4. POWER SPECTRAL DENSITY TEST	35
4.1 APPLIED PROCEDURES / LIMIT	35
4.2 TEST PROCEDURE	36
4.3 DEVIATION FROM STANDARD	36
4.4 TEST SETUP	36
4.5 EUT OPERATION CONDITIONS	36
4.6 TEST RESULTS	37
5. 26DB & 99% EMISSION BANDWIDTH	38
5.1 APPLIED PROCEDURES / LIMIT	38
5.2 TEST PROCEDURE	38
5.3 EUT OPERATION CONDITIONS	39
5.4 TEST RESULTS	39

Table of Contents

	Page
6. MINIMUM 6 DB BANDWIDTH	40
6.1 APPLIED PROCEDURES / LIMIT	40
6.2 TEST PROCEDURE	40
6.3 DEVIATION FROM STANDARD	40
6.4 TEST SETUP	40
6.5 EUT OPERATION CONDITIONS	40
6.6 TEST RESULTS	41
7. MAXIMUM CONDUCTED OUTPUT POWER	42
7.1 PPLIED PROCEDURES / LIMIT	42
7.5 TEST RESULTS	44
8. OUT OF BAND EMISSIONS	45
8.1 APPLICABLE STANDARD	45
8.2 TEST PROCEDURE	45
8.3 DEVIATION FROM STANDARD	45
8.4 TEST SETUP	45
8.5 EUT OPERATION CONDITIONS	45
8.6 TEST RESULTS	46
9. FREQUENCY STABILITY MEASUREMENT	47
9.1 LIMIT	47
9.2 TEST PROCEDURES	47
9.3 TEST SETUP LAYOUT	47
9.4 EUT OPERATION DURING TEST	47
9.5 TEST RESULTS	48
10. ANTENNA REQUIREMENT	54
10.1 STANDARD REQUIREMENT	54
10.2 EUT ANTENNA	54

Revision History

Report No.	Version	Description	Issued Date
S21010401002002	Rev.01	Initial issue of report	26 Jan. 2021

1. SUMMARY OF TEST RESULTS

Test procedures according to the technical standards:

FCC Part15 (15.407) , Subpart E			
Standard Section	Test Item	Judgment	Remark
15.207	AC Power Line Conducted Emissions	PASS	
15.209(a), 15.407 (b)(1) 15.407 (b)(4) 15.407 (b)(8)	Spurious Radiated Emissions	PASS	
15.407 (a)(1) 15.407 (a)(3)	26 dB and 99% Emission Bandwidth	PASS	
15.407(e)	Minimum 6 dB bandwidth	PASS	
15.407 (a)(1) 15.407 (a)(3)	Maximum Conducted Output Power	PASS	
15.407(b)(1) 15.407(b)(4)	Band Edge	PASS	
15.407 (a)(1) 15.407 (a)(3)	Power Spectral Density	PASS	
15.407(b)	Spurious Emissions at Antenna Terminals	PASS	
15.203	Antenna Requirement	PASS	

NOTE:

- (1) "N/A" denotes test is not applicable in this Test Report
- (2) This device operates with a duty cycle greater than 99%

1.1 FACILITIES AND ACCREDITATIONS

FACILITIES

All measurement facilities used to collect the measurement data are located at
1/F, Building E, Fenda Science Park Sanwei, Xixiang, Bao'an District
Shenzhen, Guangdong, China

The sites are constructed in conformance with the requirements of ANSI C63.7, ANSI C63.10 and CISPR Publication 22.

LABORATORY ACCREDITATIONS AND LISTINGS

Site Description

CNAS-Lab. : The Laboratory has been assessed and proved to be in compliance with
CNAS-CL01:2006 (identical to ISO/IEC 17025:2005)
The Certificate Registration Number is L5516.

IC-Registration : The Certificate Registration Number is 9270A.
CAB identifier:CN0074

FCC- Accredited : Test Firm Registration Number: 463705.
Designation Number: CN1184

A2LA-Lab. : The Certificate Registration Number is 4298.01
This laboratory is accredited in accordance with the recognized
International Standard ISO/IEC 17025:2005 General requirements for the
competence of testing and calibration laboratories.
This accreditation demonstrates technical competence for a defined
scope and the operation of a laboratory quality management system
(refer to joint ISO-ILAC-IAF Communiqué dated 8 January 2009).

Name of Firm : Shenzhen NTEK Testing Technology Co., Ltd.

Site Location : 1/F, Building E, Fenda Science Park Sanwei, Xixiang, Bao'an District
Shenzhen, Guangdong, China

1.2 MEASUREMENT UNCERTAINTY

The reported uncertainty of measurement $y \pm U$, where expanded uncertainty U is based on a standard uncertainty multiplied by a coverage factor of $k=2$, providing a level of confidence of approximately 95 %.

No.	Item	Uncertainty
1	Conducted Emission Test	$\pm 2.80\text{dB}$
2	RF power, conducted	$\pm 0.16\text{dB}$
3	Spurious emissions, conducted	$\pm 0.21\text{dB}$
4	All emissions, radiated(30MHz~1GHz)	$\pm 2.64\text{dB}$
5	All emissions, radiated(1GHz~6GHz)	$\pm 2.40\text{dB}$
6	All emissions, radiated(> 6GHz)	$\pm 2.52\text{dB}$
7	Temperature	$\pm 0.5^\circ\text{C}$
8	Humidity	$\pm 2\%$

2. GENERAL INFORMATION
2.1 GENERAL DESCRIPTION OF EUT

Equipment	wifi extender	
Trade Mark	N/A	
Model Name	805600	
Family Model	N/A	
Model Difference	N/A	
FCC ID	2AITNWAVE	
Product Description	Mode Supported	<input checked="" type="checkbox"/> 802.11a <input checked="" type="checkbox"/> 802.11n(HT20) <input checked="" type="checkbox"/> 802.11n(HT40) <input checked="" type="checkbox"/> 802.11ac(HT20) <input checked="" type="checkbox"/> 802.11ac(HT40) <input checked="" type="checkbox"/> 802.11ac(HT80)
	Data Rate	802.11a: 6,9,12,18,24,36,48,54Mbps; 802.11n(HT20/HT40):MCS0-MCS15; 802.11ac(VHT20): NSS1, MCS0-MCS8 802.11ac(VHT40/VHT80):NSS1, MCS0-MCS9
	Modulation	OFDM with BPSK/QPSK/16QAM/64QAM
	Operating Frequency Range	<input checked="" type="checkbox"/> U-NII-1: 5150 MHz ~5250MHz <input type="checkbox"/> U-NII-2A: 5250MHz~5350MHz <input type="checkbox"/> U-NII-2C: 5470MHz~5725MHz <input checked="" type="checkbox"/> U-NII-3: 5725 MHz ~5850 MHz
	Function:	<input type="checkbox"/> Outdoor AP <input checked="" type="checkbox"/> Indoor AP <input type="checkbox"/> Fixed P2P <input type="checkbox"/> Client
	Antenna Type	Antenna 1:Rod antenna Antenna 2: PCB Antenna
	Antenna Gain	Antenna 1: 2.5dBi Antenna 2: 2.5dBi
	Based on the application, features, or specification exhibited in User's Manual, More details of EUT technical specification, please refer to the User's Manual.	
Ratings	DC 5V, 1.5A powered by Micro USB port	
Adapter	<input type="checkbox"/> Adapter supply:	
Battery	N/A	
Connecting I/O Port(s)	Please refer to the User's Manual	
HW Version	V1.1	
SW Version	Wave by PowerStick_127	

Note:

1. For a more detailed features description, please refer to the manufacturer's specifications or the User's Manual.
2. Frequency and Channel list:

Band	20MHz		40MHz		80MHz	
	Channel	Frequency	Channel	Frequency	Channel	Frequency
U-NII-1	36	5180 MHz	38	5190 MHz	42	5210 MHz
	40	5200 MHz	46	5230 MHz	-	-
	44	5220 MHz				
	48	5240 MHz				
U-NII-3	149	5745 MHz	151	5755 MHz	155	5775 MHz
	153	5765 MHz	159	5795 MHz		
	157	5785 MHz				
	161	5805 MHz				
	165	5825 MHz				

For 5G WIFI has two antennas, and different modes support different transmit mode what describe as Following form:

Mode	Tx/Rx
802.11a	1TX, 1RX
802.11n/ac	1TX/2TX, 1RX/2RX

For 5GHz mode, Antenna 1,2 are transmitting, each with the same directional gain.
 For MIMO mode, Directional gain= $G_{ANT} + 10 \log(N_{ANT})$ dBi =5.51dBi in 5GHz
 the 802.11n(20/40) ac(20/40/80) 5GHz has MIMO mode.

Note: GANT means antenna gain for ANT in dBi.
 NANT means the number of Antennas.

2.2 DESCRIPTION OF TEST MODES

To investigate the maximum EMI emission characteristics generates from EUT, the test system was pre-scanning tested base on the consideration of following EUT operation mode or test configuration mode which possible have effect on EMI emission level. Each of these EUT operation mode(s) or test configuration mode(s) mentioned above was evaluated respectively.

Pretest Mode	Description
Mode 1	Normal Link Mode
Mode 2	802.11a/n/ac20 CH36/CH40/CH48/CH149/CH157/CH165
Mode 3	802.11n40/ac40 CH38/CH46CH151/CH159
Mode 4	802.11ac80 CH42/CH155

For Radiated Emission	
Final Test Mode	Description
Mode 1	Normal Link Mode
Mode 2	802.11a/n/ac20 CH36/CH40/CH48/CH149/CH157/CH165
Mode 3	802.11n40/ac40 CH38/CH46CH151/CH159
Mode 4	802.11ac80 CH42/CH155

Note:

- (1) The measurements are performed at the highest, middle, lowest available channels.
- (2) The measurements are performed at all Bit Rate of Transmitter, the worst data was reported

2.3 BLOCK DIGRAM SHOWING THE CONFIGURATION OF SYSTEM TESTED

For AC Conducted Emission Mode

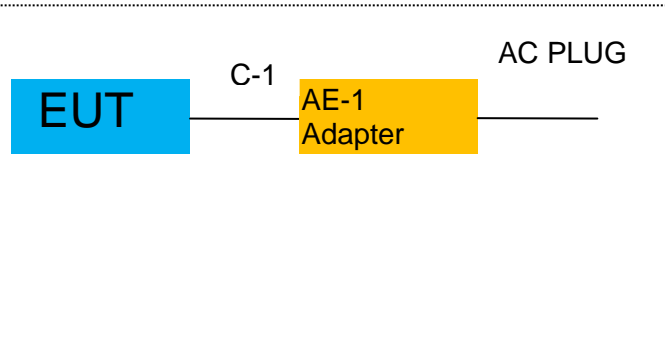

For Radiated Test Cases



For Conducted Test Cases

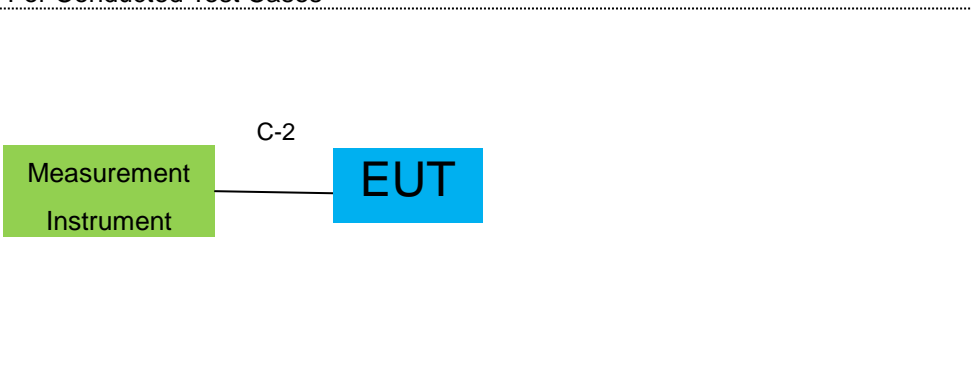

Note: 1. The temporary antenna connector is soldered on the PCB board in order to perform conducted tests and this temporary antenna connector is listed in the equipment list.

2.4 DESCRIPTION OF SUPPORT UNITS(CONDUCTED MODE)

The EUT has been tested as an independent unit together with other necessary accessories or support units. The following support units or accessories were used to form a representative test configuration during the tests.

Item	Equipment	Mfr/Brand	Model/Type No.	Series No.	Note
AE-1	Adapter	N/A	N/A	N/A	Peripherals

Item	Cable Type	Shielded Type	Ferrite Core	Length
C-1	Power Cable	NO	NO	1.2m
C-2	RF Cable	YES	NO	0.1m

Note:

- (1) The support equipment was authorized by Declaration of Confirmation.
- (2) For detachable type I/O cable should be specified the length in cm in 『Length』 column.
- (3) During the battery power test, the battery is fully charged.

2.5 EQUIPMENTS LIST FOR ALL TEST ITEMS

Radiation& Conducted Test equipment

Item	Kind of Equipment	Manufacturer	Type No.	Serial No.	Last calibration	Calibrated until	Calibration period
1	Spectrum Analyzer	Agilent	E4407B	MY45108040	2020.05.11	2021.05.10	1 year
2	Spectrum Analyzer	Agilent	N9020A	MY49100060	2020.07.13	2021.07.12	1 year
3	Spectrum Analyzer	R&S	FSV40	101417	2020.08.07	2021.08.06	1 year
4	Test Receiver	R&S	ESPI7	101318	2020.05.11	2021.05.10	1 year
5	Bilog Antenna	TESEQ	CBL6111D	31216	2020.04.11	2021.04.10	1 year
6	50Ω Coaxial Switch	Anritsu	MP59B	6200983705	2020.05.11	2023.05.10	3 year
7	Horn Antenna	EM	EM-AH-10180	2011071402	2020.04.11	2021.04.10	1 year
8	Amplifier	EMC	EMC051835SE	980246	2020.07.13	2021.07.12	1 year
9	Active Loop Antenna	SCHWARZBECK	FMZB 1519B	055	2020.05.11	2021.05.10	1 year
10	Power Meter	DARE	RPR3006W	15I00041SN084	2020.07.13	2021.07.12	1 year
11	USB RF Power Sensor	DARE	RPR3006W	15I00041SN084	2020.07.13	2021.07.12	1 year
12	Test Cable (9KHz-30MHz)	N/A	R-01	N/A	2019.08.06	2022.08.05	3 year
13	Test Cable (30MHz-1GHz)	N/A	R-02	N/A	2020.07.13	2021.07.12	1 year
14	High Test Cable(1G-40GHz)	N/A	R-03	N/A	2019.06.28	2022.06.27	3 year
15	High Test Cable(1G-40GHz)	N/A	R-04	N/A	2019.06.28	2022.06.27	3 year
16	Filter	TRILTHIC	2400MHz	29	2020.07.13	2021.07.12	1 year
17	temporary antenna connector (Note)	NTS	R001	N/A	N/A	N/A	N/A
18	Low Noise Amplifier	B&Z	BZ-P540-550850-452727	16476-11729	2020.04.15	2021.04.14	1 year
19	Broadband Horn Antenna	SCHWARZBECK	BBHA 9170	803	2020.05.11	2021.05.10	1 year
20	Thermal Chamber	Ten Billion	TTC-B3C	TBN-960502	2020.05.11	2021.05.10	1 year

Note:

We will use the temporary antenna connector (soldered on the PCB board) When conducted test
And this temporary antenna connector is listed within the instrument list

AC Conduction Test equipment

Item	Kind of Equipment	Manufacturer	Type No.	Serial No.	Last calibration	Calibrated until	Calibration period
1	Test Receiver	R&S	ESCI	101160	2020.05.11	2021.05.10	1 year
2	LISN	R&S	ENV216	101313	2020.04.11	2021.04.10	1 year
3	LISN	SCHWARZBECK	NNLK 8129	8129245	2020.05.11	2021.05.10	1 year
4	50Ω Coaxial Switch	ANRITSU CORP	MP59B	6200983704	2020.05.11	2023.05.10	3 year
5	Test Cable (9KHz-30MHz)	N/A	C01	N/A	2020.05.11	2023.05.10	3 year
6	Test Cable (9KHz-30MHz)	N/A	C02	N/A	2020.05.11	2023.05.10	3 year
7	Test Cable (9KHz-30MHz)	N/A	C03	N/A	2020.05.11	2021.05.10	1 year

Note: Each piece of equipment is scheduled for calibration once a year except the Test Cable& Aux Equipment which is scheduled for calibration every 3 years.

3. EMC EMISSION TEST

3.1 CONDUCTED EMISSION MEASUREMENT

3.1.1 APPLICABLE STANDARD

According to FCC Part 15.207(a)

3.1.2 CONFORMANCE LIMIT

Frequency(MHz)	Conducted Emission Limit	
	Quasi-peak	Average
0.15-0.5	66-56*	56-46*
0.5-5.0	56	46
5.0-30.0	60	50

Note: 1. *Decreases with the logarithm of the frequency
 2. The lower limit shall apply at the transition frequencies
 3. The limit decreases in line with the logarithm of the frequency in the range of 0.15 to 0.50MHz.

3.1.3 TEST CONFIGURATION

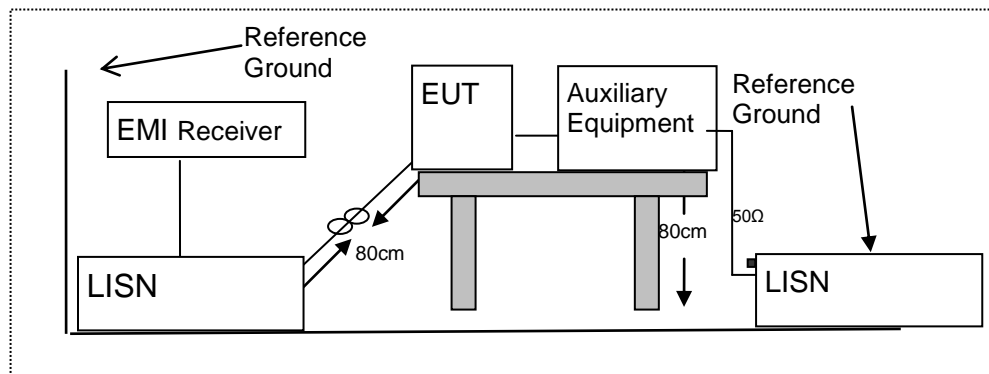

3.1.4 TEST PROCEDURE

According to the requirements in Section 13.1.4.1 of ANSI C63.10-2013 Conducted emissions the EUT measured in the frequency range between 0.15 MHz and 30 MHz using CISPR Quasi-Peak and average detector mode.

1. The EUT was placed 0.4 meter from the conducting wall of the shielding room.
2. The EUT was placed on a table which is 0.8m above ground plane.
3. Connect EUT to the power mains through a line impedance stabilization network (LISN). All other support equipments powered from additional LISN(s). The LISN provide 50 Ohm/ 50uH of coupling impedance for the measuring instrument.
4. Interconnecting cables that hang closer than 40 cm to the ground plane shall be folded back and forth in the center forming a bundle 30 to 40cm long.
5. I/O cables that are not connected to a peripheral shall be bundled in the center. The end of the cable may be terminated, if required, using the correct terminating impedance. The overall length shall not exceed 1 m.
6. LISN at least 80 cm from nearest part of EUT chassis.
7. The frequency range from 150KHz to 30MHz was searched.
8. Set the test-receiver system to Peak Detect Function and specified bandwidth(IF bandwidth=9KHz) with Maximum Hold Mode
9. For the actual test configuration, please refer to the related Item –EUT Test Photos.

EUT :	wifi extender	Model Name. :	805600
Temperature :	21.8 °C	Relative Humidity :	43%
Pressure :	1010hPa	Phase :	L
Test Voltage :	DC 5V powered by Adapter AC 120V/60Hz	Test Mode :	Mode 1(5.2G)

Frequency (MHz)	Reading Level (dBμV)	Correct Factor (dB)	Measure-ment (dBμV)	Limits (dBμV)	Margin (dB)	Remark
0.1564	36.94	9.56	46.50	65.65	-19.15	QP
0.1564	22.00	9.56	31.56	55.65	-24.09	AVG
0.1824	34.79	9.55	44.34	64.37	-20.03	QP
0.1824	19.47	9.55	29.02	54.37	-25.35	AVG
0.5778	31.65	9.55	41.20	56.00	-14.80	QP
0.5778	21.43	9.55	30.98	46.00	-15.02	AVG
1.0140	28.41	9.56	37.97	56.00	-18.03	QP
1.0140	17.63	9.56	27.19	46.00	-18.81	AVG
1.4738	24.34	9.56	33.90	56.00	-22.10	QP
1.4738	13.70	9.56	23.26	46.00	-22.74	AVG
15.7737	22.58	9.79	32.37	60.00	-27.63	QP
15.7737	11.03	9.79	20.82	50.00	-29.18	AVG

Remark:

1. All readings are Quasi-Peak and Average values.
2. Factor = Insertion Loss + Cable Loss.

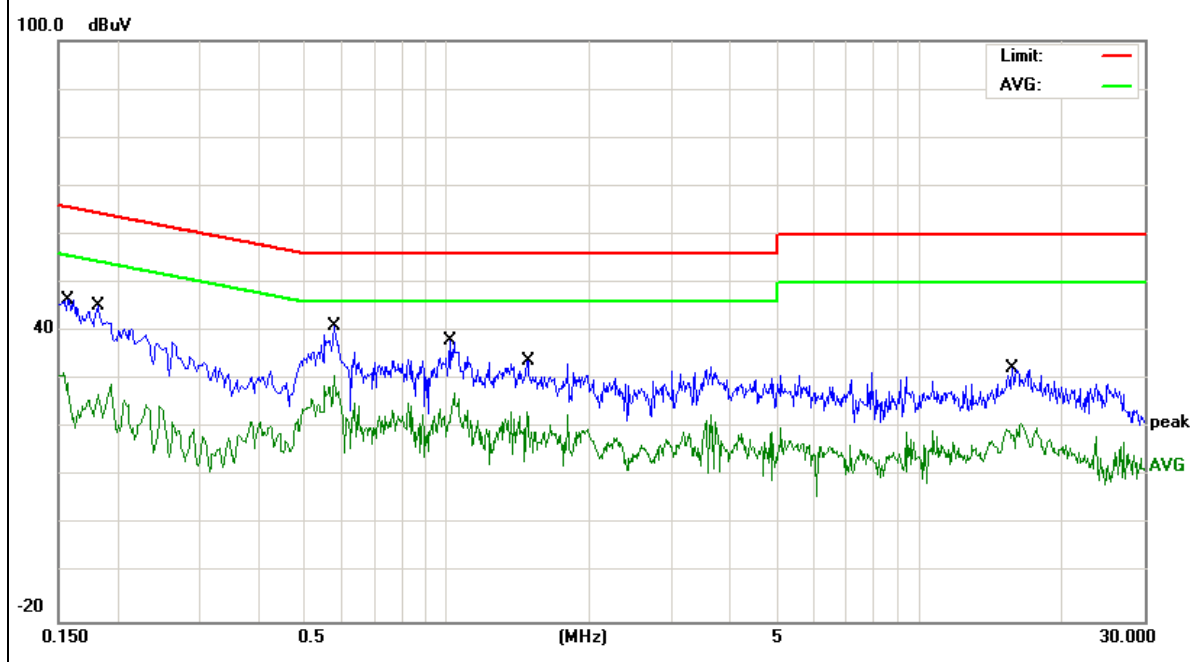

EUT :	wifi extender	Model Name. :	805600
Temperature :	21.8 °C	Relative Humidity :	43%
Pressure :	1010hPa	Phase :	N
Test Voltage :	DC 5V powered by Adapter AC 120V/60Hz	Test Mode :	Mode 1(5.2G)

Frequency (MHz)	Reading Level (dBμV)	Correct Factor (dB)	Measure-ment (dBμV)	Limits (dBμV)	Margin (dB)	Remark
0.1554	39.65	9.55	49.20	65.70	-16.50	QP
0.1554	24.96	9.55	34.51	55.70	-21.19	AVG
0.2184	32.86	9.54	42.40	62.88	-20.48	QP
0.2184	18.73	9.54	28.27	52.88	-24.61	AVG
0.6219	28.76	9.54	38.30	56.00	-17.70	QP
0.6219	19.01	9.54	28.55	46.00	-17.45	AVG
1.0940	23.27	9.55	32.82	56.00	-23.18	QP
1.0940	13.77	9.55	23.32	46.00	-22.68	AVG
2.1099	23.13	9.57	32.70	56.00	-23.30	QP
2.1099	12.12	9.57	21.69	46.00	-24.31	AVG
16.1297	21.97	9.78	31.75	60.00	-28.25	QP
16.1297	10.43	9.78	20.21	50.00	-29.79	AVG

Remark:

1. All readings are Quasi-Peak and Average values.
2. Factor = Insertion Loss + Cable Loss.

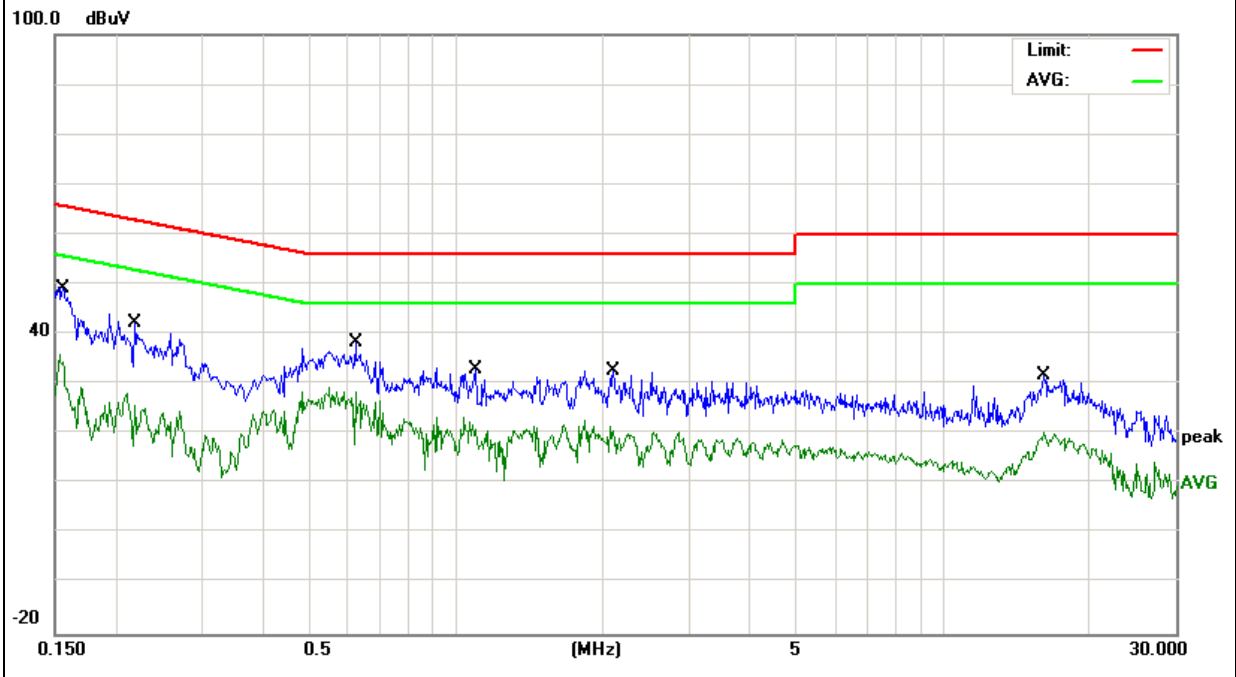

EUT :	wifi extender	Model Name. :	805600
Temperature :	21.8 °C	Relative Humidity :	43%
Pressure :	1010hPa	Phase :	L
Test Voltage :	DC 5V powered by Adapter AC 120V/60Hz	Test Mode :	Mode 1(5.8G)

Frequency (MHz)	Reading Level (dBμV)	Correct Factor (dB)	Measure-ment (dBμV)	Limits (dBμV)	Margin (dB)	Remark
0.1685	38.14	9.56	47.70	65.03	-17.33	QP
0.1685	19.78	9.56	29.34	55.03	-25.69	AVG
0.2139	35.61	9.55	45.16	63.05	-17.89	QP
0.2139	17.11	9.55	26.66	53.05	-26.39	AVG
0.5701	29.85	9.55	39.40	56.00	-16.60	QP
0.5701	19.38	9.55	28.93	46.00	-17.07	AVG
0.9418	25.64	9.56	35.20	56.00	-20.80	QP
0.9418	16.06	9.56	25.62	46.00	-20.38	AVG
1.3099	22.96	9.56	32.52	56.00	-23.48	QP
1.3099	12.60	9.56	22.16	46.00	-23.84	AVG
15.5699	24.41	9.79	34.20	60.00	-25.80	QP
15.5699	15.09	9.79	24.88	50.00	-25.12	AVG

Remark:

1. All readings are Quasi-Peak and Average values.
2. Factor = Insertion Loss + Cable Loss.

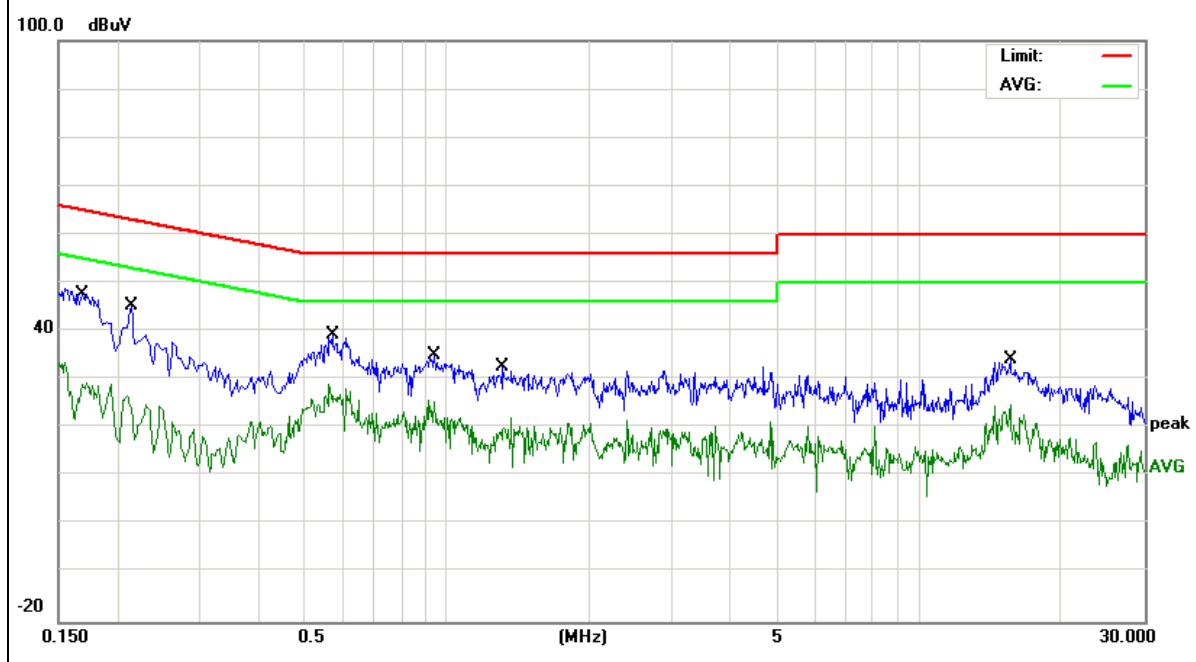

EUT :	wifi extender	Model Name. :	805600
Temperature :	21.8 °C	Relative Humidity :	43%
Pressure :	1010hPa	Phase :	N
Test Voltage :	DC 5V powered by Adapter AC 120V/60Hz	Test Mode :	Mode 1(5.8G)

Frequency (MHz)	Reading Level (dBμV)	Correct Factor (dB)	Measurement (dBμV)	Limits (dBμV)	Margin (dB)	Remark
0.1703	35.65	9.55	45.20	64.94	-19.74	QP
0.1703	22.14	9.55	31.69	54.94	-23.25	AVG
0.5620	27.46	9.54	37.00	56.00	-19.00	QP
0.5620	19.92	9.54	29.46	46.00	-16.54	AVG
0.8618	23.62	9.54	33.16	56.00	-22.84	QP
0.8618	12.79	9.54	22.33	46.00	-23.67	AVG
1.7860	22.33	9.57	31.90	56.00	-24.10	QP
1.7860	13.85	9.57	23.42	46.00	-22.58	AVG
2.5259	22.72	9.58	32.30	56.00	-23.70	QP
2.5259	10.67	9.58	20.25	46.00	-25.75	AVG
15.3498	21.94	9.76	31.70	60.00	-28.30	QP
15.3498	11.33	9.76	21.09	50.00	-28.91	AVG

Remark:

1. All readings are Quasi-Peak and Average values.
2. Factor = Insertion Loss + Cable Loss.

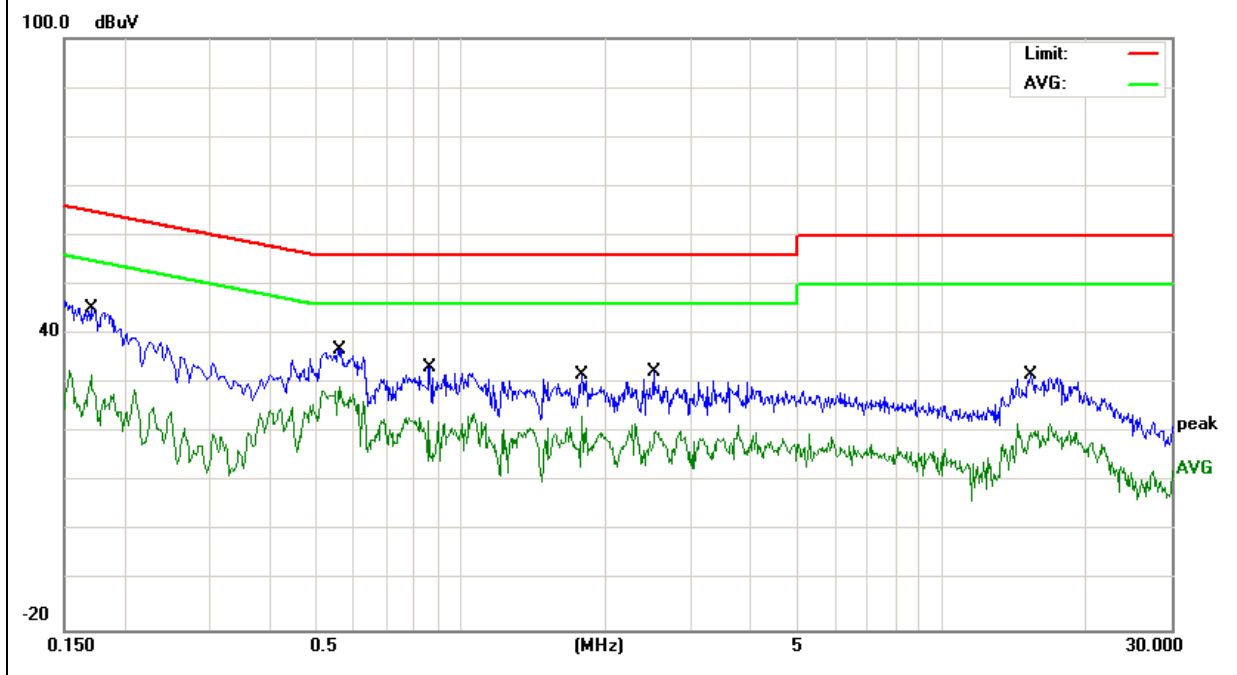

3.2 RADIATED EMISSION MEASUREMENT

3.2.1 APPLICABLE STANDARD

According to FCC Part 15.407(b)(9) and 15.209

3.2.2 CONFORMANCE LIMIT

According to FCC Part 15.407(b) (9): radiated emissions which fall in the restricted bands, as defined in §15.205(a), must also comply with the radiated emission limits specified in §15.209(a) (see §15.205(c)).
According to FCC Part 15.205, Restricted bands

MHz	MHz	MHz	GHz
0.090-0.110	16.42-16.423	399.9-410	4.5-5.15
0.495-0.505	16.69475-16.69525	608-614	5.35-5.46
2.1735-2.1905	16.80425-16.80475	960-1240	7.25-7.75
4.125-4.128	25.5-25.67	1300-1427	8.025-8.5
4.17725-4.17775	37.5-38.25	1435-1626.5	9.0-9.2
4.20725-4.20775	73-74.6	1645.5-1646.5	9.3-9.5
6.215-6.218	74.8-75.2	1660-1710	10.6-12.7
6.26775-6.26825	123-138	2200-2300	14.47-14.5
8.291-8.294	149.9-150.05	2310-2390	15.35-16.2
8.362-8.366	156.52475-156.52525	2483.5-2500	17.7-21.4
8.37625-8.38675	156.7-156.9	2690-2900	22.01-23.12
8.41425-8.41475	162.0125-167.17	3260-3267	23.6-24.0
12.29-12.293	167.72-173.2	3332-3339	31.2-31.8
12.51975-12.52025	240-285	3345.8-3358	36.43-36.5
12.57675-12.57725	322-335.4	3600-4400	(2)
13.36-13.41			

20dBc in any 100 kHz bandwidth outside the operating frequency band. In case the emission fall within the restricted band specified on 15.205(a), then the 15.209(a) limit in the table below has to be followed.

Restricted Frequency(MHz)	Field Strength (µV/m)	Field Strength (dBµV/m)	Measurement Distance
0.009~0.490	2400/F(KHz)	20 log (uV/m)	300
0.490~1.705	24000/F(KHz)	20 log (uV/m)	30
1.705~30.0	30	29.5	30
30-88	100	40	3
88-216	150	43.5	3
216-960	200	46	3
Above 960	500	54	3

Limits of Radiated Emission Measurement(Above 1000MHz)

Frequency(MHz)	Class B (dBuV/m) (at 3M)	
	PEAK	AVERAGE
Above 1000	74	54

Remark :1. Emission level in dBuV/m=20 log (uV/m)
 2. Measurement was performed at an antenna to the closed point of EUT distance of meters.
 3. For Frequency 9kHz~30MHz:
 Distance extrapolation factor =40log(Specific distance/ test distance)(dB);
 Limit line=Specific limits(dBuV) + distance extrapolation factor.
 For Frequency above 30MHz:
 Distance extrapolation factor =20log(Specific distance/ test distance)(dB);
 Limit line=Specific limits(dBuV) + distance extrapolation factor.

3.2.3 MEASURING INSTRUMENTS

The Measuring equipment is listed in the section 6.3 of this test report.

3.2.4 TEST CONFIGURATION

(a) For radiated emissions below 30MHz

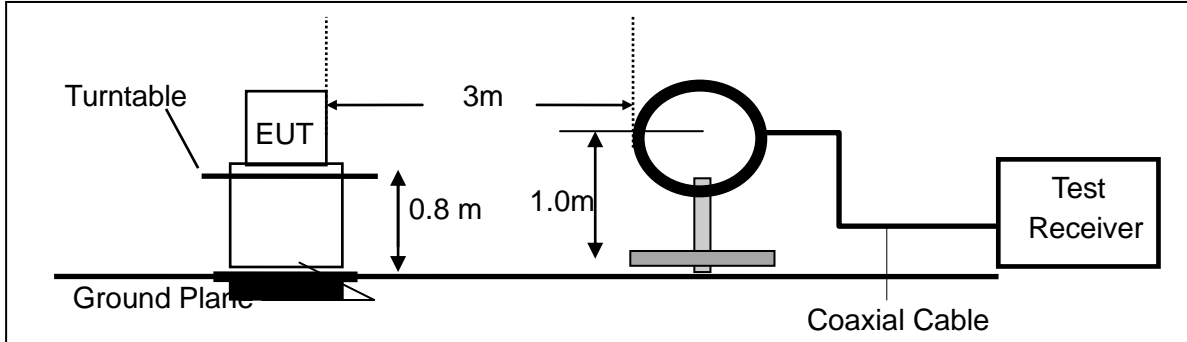

(b) For radiated emissions from 30MHz to 1000MHz

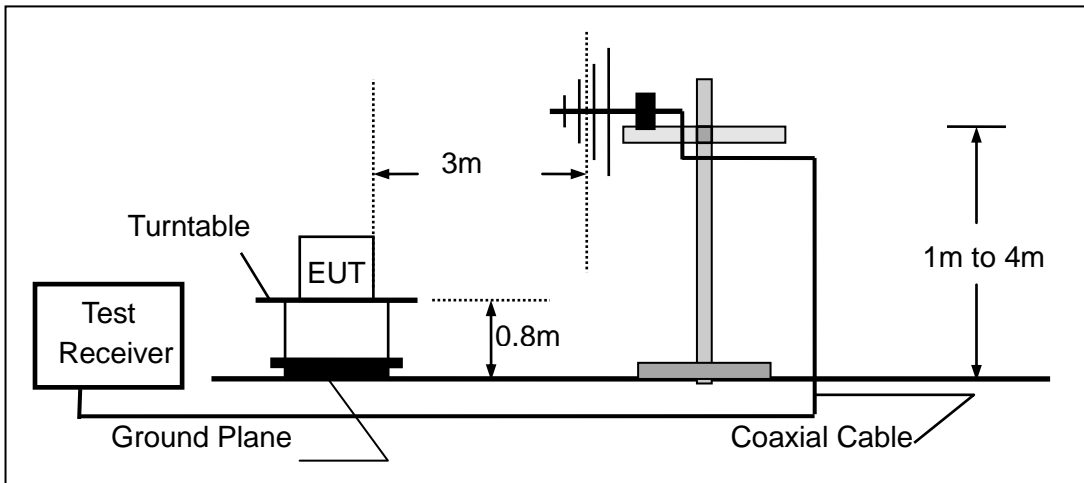

(c) For radiated emissions above 1000MHz

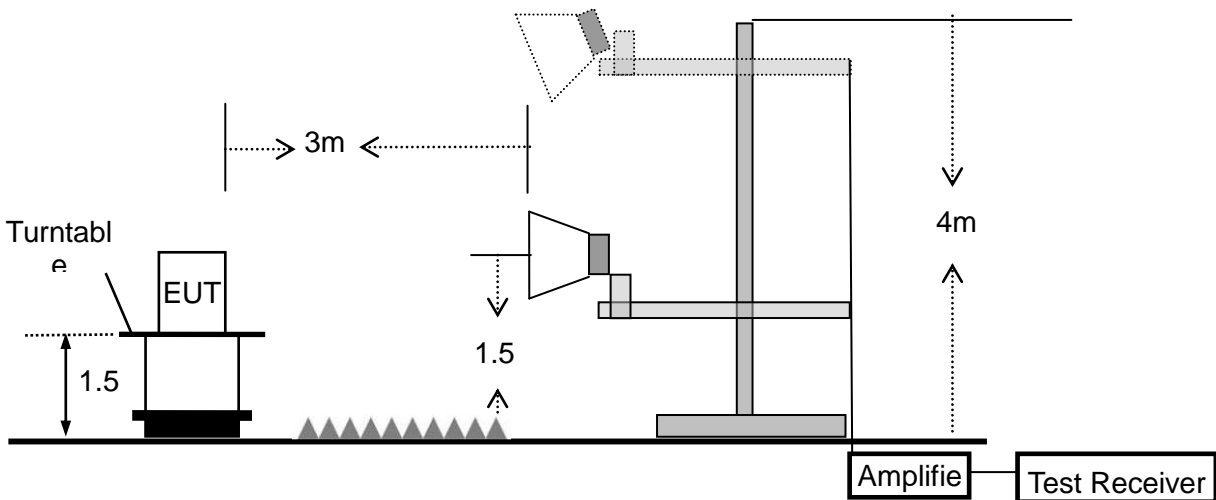

3.2.5 TEST PROCEDURE

The test site semi-anechoic chamber has met the requirement of NSA tolerance 4 dB according to the standards: ANSI C63.10-2013. The test distance is 3m. The setup is according to the requirements in Section 13.1.4.1 of ANSI C63.10-2013 and CAN/CSA-CEI/IEC CISPR 22.

This test is required for any spurious emission that falls in a Restricted Band, as defined in Section 15.205. It must be performed with the highest gain of each type of antenna proposed for use with the EUT.

Use the following spectrum analyzer settings:

Spectrum Parameter	Setting
Attenuation	Auto
Start Frequency	1000 MHz
Stop Frequency	10th carrier harmonic
RB / VB (emission in restricted band)	1 MHz / 1 MHz for Peak, 1 MHz / 10Hz for Average

Receiver Parameter	Setting
Attenuation	Auto
Start ~ Stop Frequency	9kHz~150kHz / RB 200Hz for QP
Start ~ Stop Frequency	150kHz~30MHz / RB 9kHz for QP
Start ~ Stop Frequency	30MHz~1000MHz / RB 120kHz for QP

- The measuring distance of at 3 m shall be used for measurements at frequency up to 1GHz. For frequencies above 1GHz, any suitable measuring distance may be used.
- The EUT was placed on the top of a rotating table 0.8 m for below 1GHz and 1.5m for above 1GHz the ground at a 3 meter. The table was rotated 360 degrees to determine the position of the highest radiation.
- The height of the equipment or of the substitution antenna shall be 0.8 m for below 1GHz and 1.5m for above 1GHz; the height of the test antenna shall vary between 1 m to 4 m. Both horizontal and vertical polarizations of the antenna are set to make the measurement.
- The initial step in collecting conducted emission data is a spectrum analyzer peak detector mode pre-scanning the measurement frequency range. Significant peaks are then marked and then Quasi Peak detector mode re-measured.
- If the Peak Mode measured value compliance with and lower than Quasi Peak Mode Limit, the EUT shall be deemed to meet QP Limits and then no additional QP Mode measurement performed.
- For the actual test configuration, please refer to the related Item –EUT Test Photos.

Note:

Both horizontal and vertical antenna polarities were tested and performed pretest to three orthogonal axis. The worst case emissions were reported

During the radiated emission test, the Spectrum Analyzer was set with the following configurations:

Frequency Band (MHz)	Function	Resolution bandwidth	Video Bandwidth
30 to 1000	QP	120 kHz	300 kHz
Above 1000	Peak	1 MHz	1 MHz
	Average	1 MHz	10 Hz

Note: for the frequency ranges below 30 MHz, a narrower RBW is used for these ranges but the measured value should add a RBW correction factor (RBWCF) where $RBWCF [dB] = 10 \cdot \lg(100 [kHz] / \text{narrower RBW [kHz]})$. , the narrower RBW is 1 kHz and RBWCF is 20 dB for the frequency 9 kHz to 150 kHz, and the narrower RBW is 10 kHz and RBWCF is 10 dB for the frequency 150 kHz to 30 MHz.

3.2.6 TEST RESULTS (9KHZ – 30 MHZ)

EUT :	wifi extender	Model Name :	805600
Temperature :	26 °C	Relative Humidity :	54%
Pressure:	1010 hPa	Test Voltage :	DC 5V powered by Adapter AC 120V/60Hz
Test Mode :	TX	Polarization :	--

Freq.	Reading	Limit	Margin	State
(MHz)	(dBuV/m)	(dBuV/m)	(dB)	P/F
--	--	--	--	N/A
--	--	--	--	N/A

NOTE:

The amplitude of spurious emissions which are attenuated by more than 20dB below the permissible value has no need to be reported.

3.2.7 TEST RESULTS (30MHZ – 1GHZ)

EUT :	wifi extender	Model Name :	805600
Temperature :	25.3 °C	Relative Humidity :	55%
Pressure :	1010 hPa	Test Voltage :	DC 5V powered by Adapter AC 120V/60Hz
Test Mode :	TX(5.2G)- 802.11n20 (Low CH)		

Polar (H/V)	Frequency	Meter Reading	Factor	Emission Level	Limits	Margin	Remark
	(MHz)	(dBuV)	(dB)	(dBuV/m)	(dBuV/m)	(dB)	
V	34.6385	14.29	16.91	31.20	40.00	-8.80	QP
V	50.2324	16.42	8.98	25.40	40.00	-14.60	QP
V	63.3132	19.62	6.15	25.77	40.00	-14.23	QP
V	96.7749	19.79	10.31	30.10	43.50	-13.40	QP
V	154.8204	18.20	11.69	29.89	43.50	-13.61	QP
V	570.6100	12.33	21.87	34.20	46.00	-11.80	QP

Remark:

Emission Level= Meter Reading+ Factor, Margin= Emission Level - Limit

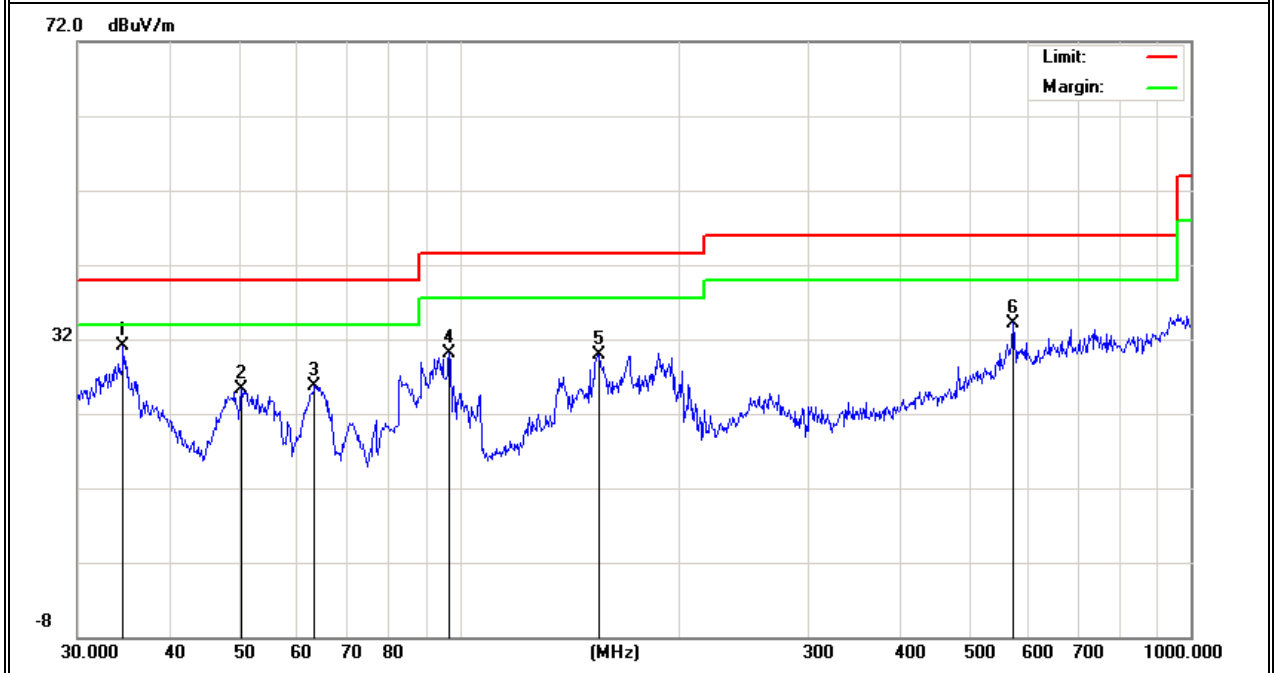

Polar (H/V)	Frequency	Meter Reading	Factor	Emission Level	Limits	Margin	Remark
	(MHz)	(dBUV)	(dB)	(dBUV/m)	(dBUV/m)	(dB)	
H	80.0806	15.52	8.08	23.60	40.00	-16.40	QP
H	148.9625	14.32	11.98	26.30	43.50	-17.20	QP
H	183.8437	15.84	9.76	25.60	43.50	-17.90	QP
H	308.9125	16.03	15.37	31.40	46.00	-14.60	QP
H	431.0316	12.78	18.32	31.10	46.00	-14.90	QP
H	599.3211	11.07	21.69	32.76	46.00	-13.24	QP

Remark:

Emission Level= Meter Reading+ Factor, Margin= Emission Level - Limit

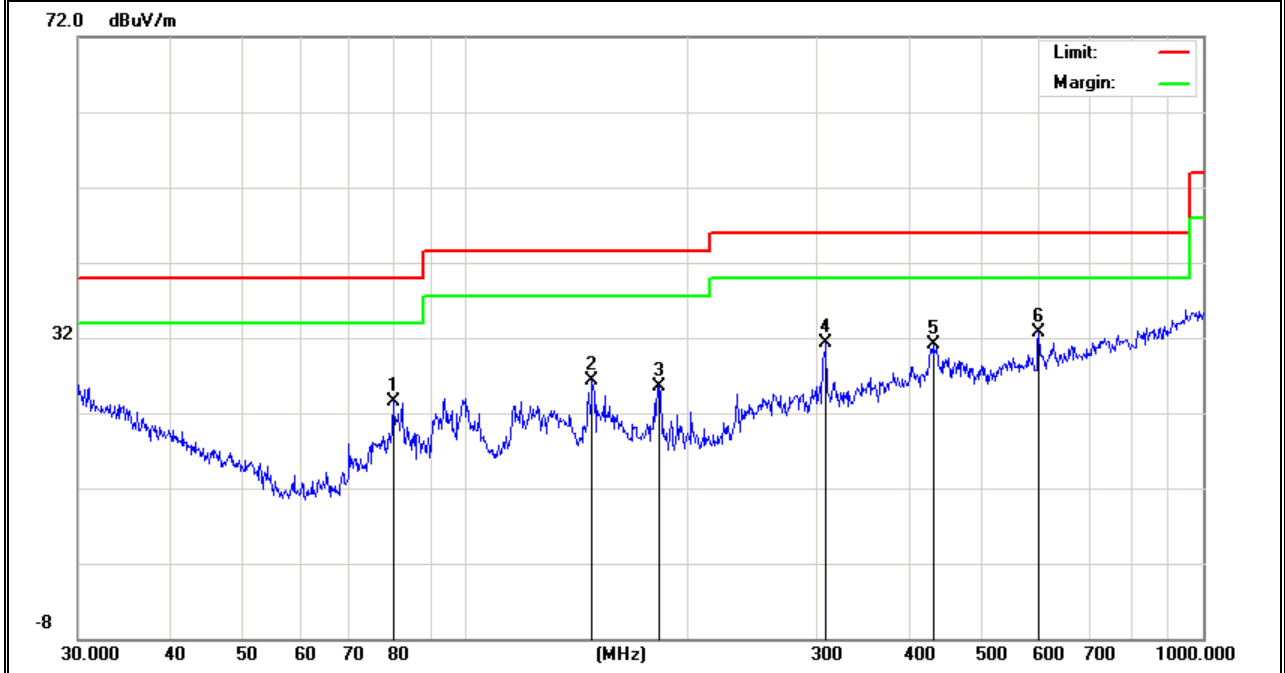

EUT :	wifi extender	Model Name :	805600
Temperature :	25.3 °C	Relative Humidity :	55%
Pressure :	1010 hPa	Test Voltage :	DC 5V powered by Adapter AC 120V/60Hz
Test Mode :	TX(5.8G) - 802.11ac20 (Low CH)		

Polar (H/V)	Frequency	Meter Reading	Factor	Emission Level	Limits	Margin	Remark
	(MHz)	(dBuV)	(dB)	(dBuV/m)	(dBuV/m)	(dB)	
V	34.8823	12.43	16.77	29.20	40.00	-10.80	QP
V	49.8813	18.05	9.25	27.30	40.00	-12.70	QP
V	90.8554	19.61	9.89	29.50	43.50	-14.00	QP
V	166.0680	20.25	10.65	30.90	43.50	-12.60	QP
V	654.2318	9.95	22.65	32.60	46.00	-13.40	QP
V	912.8618	6.05	26.84	32.89	46.00	-13.11	QP

Remark:

Emission Level= Meter Reading+ Factor, Margin= Emission Level - Limit

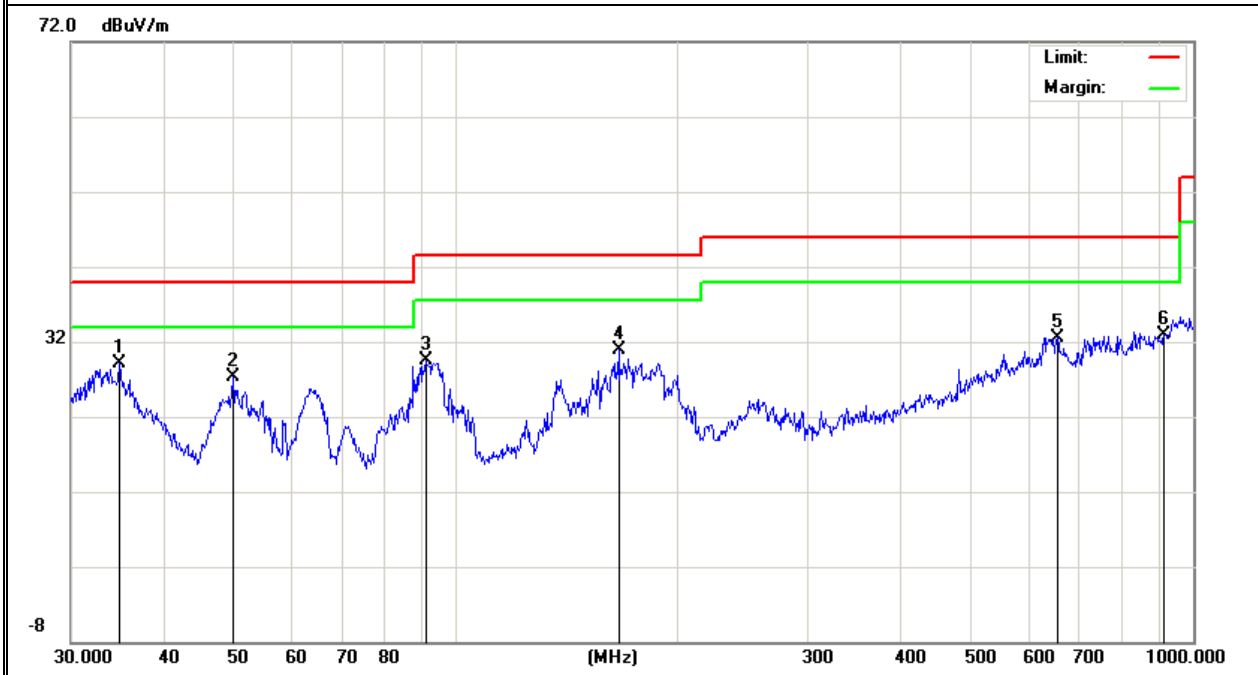

Polar (H/V)	Frequency	Meter Reading	Factor	Emission Level	Limits	Margin	Remark
	(MHz)	(dBuV)	(dB)	(dBuV/m)	(dBuV/m)	(dB)	
H	97.4560	13.75	10.45	24.20	43.50	-19.30	QP
H	127.2176	13.36	12.34	25.70	43.50	-17.80	QP
H	164.3300	14.67	10.63	25.30	43.50	-18.20	QP
H	298.2681	15.23	14.57	29.80	46.00	-16.20	QP
H	443.2943	11.21	18.59	29.80	46.00	-16.20	QP
H	866.0878	8.79	25.91	34.70	46.00	-11.30	QP

Remark:

Emission Level= Meter Reading+ Factor, Margin= Emission Level - Limit

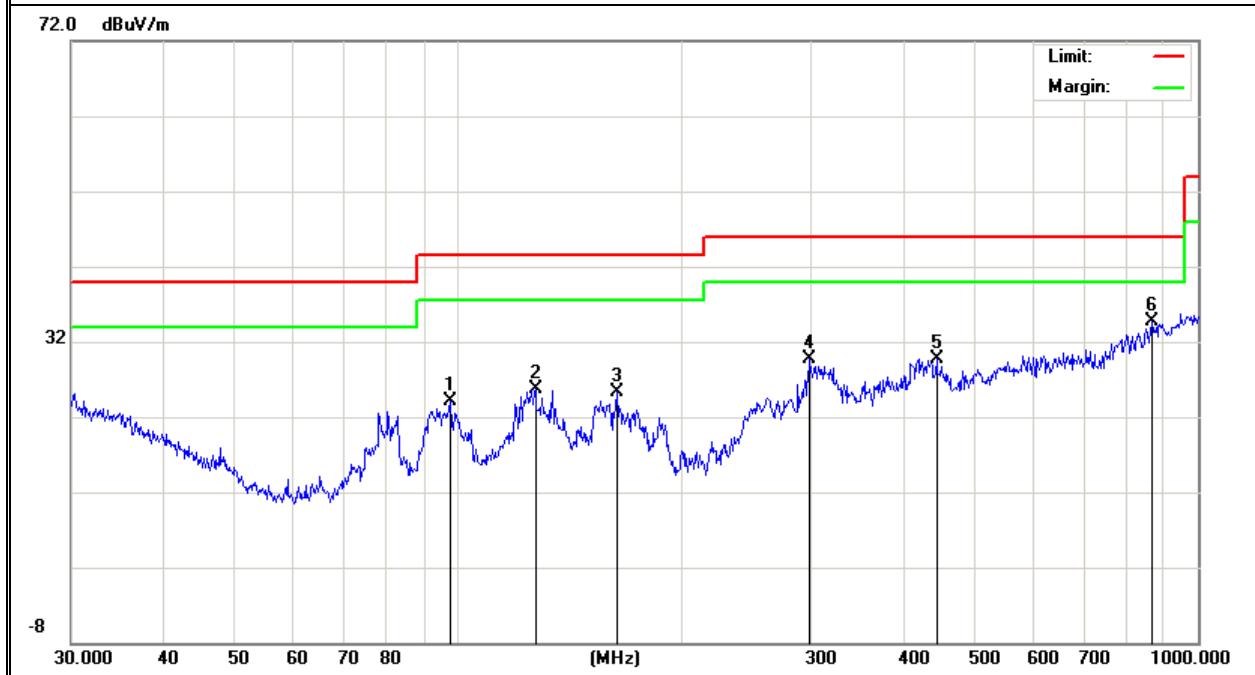

Note: All modes have been tested, just the the worst mode has been recorded in the report.

3.2.8 TEST RESULTS (1GHz-18GHz)

EUT :	wifi extender	Model Name. :	805600
Temperature :	20 °C	Relative Humidity :	48%
Pressure :	1010 hPa	Test Voltage :	DC 5V powered by Adapter AC 120V/60Hz
Test Mode :	TX(5.2G) - 802.11n20_5180~5240MHz		

Note: 1,2 Represent the value of antenna 1 and 2,The worst data is Antenna 1,only shown Antenna 1 data

Polar	Frequency	Meter Reading	Cable loss	Antenna Factor	Preamp Factor	Emission Level	Limits	Margin	Detector Type
(H/V)	(MHz)	(dBuV)	(dB)	dB/m	(dB)	(dBuV/m)	(dBuV/m)	(dB)	
Low Channel (5180 MHz)-Above 1G									
Vertical	3015	64.25	5.94	35.40	44.00	61.59	68.2	-6.61	Pk
Vertical	10380	60.36	8.46	39.75	44.50	64.07	68.2	-4.13	Pk
Vertical	15570	62.58	10.12	38.80	44.10	67.40	74	-6.60	Pk
Vertical	15570	42.75	10.12	38.80	42.70	48.97	54	-5.03	AV
Horizontal	2981	64.42	5.94	35.18	44.00	61.54	68.2	-6.66	Pk
Horizontal	10380	61.38	8.46	38.71	44.50	64.05	68.2	-4.15	Pk
Horizontal	15570	61.78	10.12	38.38	44.10	66.18	74	-7.82	Pk
Horizontal	15570	41.28	10.12	38.38	44.10	45.68	54	-8.32	AV
Middle Channel (5200 MHz)-Above 1G									
Vertical	3561	64.72	6.48	36.35	44.05	63.50	68.2	-4.70	Pk
Vertical	10460	62.27	8.47	37.88	44.51	64.11	68.2	-4.09	Pk
Vertical	15690	60.85	10.12	38.8	44.1	65.67	74	-8.33	Pk
Vertical	15690	43.20	10.12	38.8	42.7	49.42	54	-4.58	AV
Horizontal	3363	63.97	6.48	36.37	44.05	62.77	68.2	-5.43	Pk
Horizontal	10400	60.21	8.47	38.64	44.5	62.82	68.2	-5.38	Pk
Horizontal	15600	61.07	10.12	38.38	44.1	65.47	74	-8.53	Pk
Horizontal	15600	45.59	10.12	38.38	44.1	49.99	54	-4.01	AV
High Channel (5200 MHz)-Above 1G									
Vertical	3926	63.49	7.1	37.24	43.5	64.33	74	-9.67	Pk
Vertical	3926	45.45	7.1	37.24	43.5	46.29	54	-7.71	AV
Vertical	10480	62.68	8.46	37.68	44.5	64.32	68.2	-3.88	Pk
Vertical	15720	58.05	10.12	38.8	44.1	62.87	74	-11.13	Pk
Vertical	15720	35.59	10.12	38.8	42.7	41.81	54	-12.19	AV
Horizontal	3885	66.66	7.1	37.24	43.5	67.50	74	-6.50	Pk
Horizontal	3885	41.97	7.1	37.24	43.5	42.81	54	-11.19	AV
Horizontal	10480	59.27	8.46	38.57	44.5	61.80	68.2	-6.40	Pk
Horizontal	15720	61.06	10.12	38.38	44.1	65.46	74	-8.54	Pk
Horizontal	15720	41.47	10.12	38.38	44.1	45.87	54	-8.13	AV

Note:"802.11n20 (5G)" mode is the worst mode. PK value is lower than the Average value limit, So average didn't record.

The amplitude of spurious emissions that are attenuated by more than 20dB below the permissible value has no need to be reported.

Emission level (dBuV/m) = 20 log Emission level (uV/m).

Corrected Reading: Antenna Factor + Cable Loss + Read Level - Preamp Factor = Level.

EUT :	wifi extender	Model Name. :	805600
Temperature :	20 °C	Relative Humidity :	48%
Pressure :	1010 hPa	Test Voltage :	DC 5V powered by Adapter AC 120V/60Hz
Test Mode :	TX (5.8G) -- 802.11ac20_5745~5825MHz		

Note: 1,2 Represent the value of antenna 1 and 2,The worst data is Antenna 1,only shown
Antenna 1 data

Polar	Frequency	Meter Reading	Cable loss	Antenna Factor	Preamp Factor	Emission Level	Limits	Margin	Detector Type
(H/V)	(MHz)	(dBuV)	(dB)	dB/m	(dB)	(dBuV/m)	(dBuV/m)	(dB)	
Low Channel (5745 MHz)-Above 1G									
Vertical	2806	66.59	5.94	35.40	44.00	63.93	74.00	-10.07	Pk
Vertical	2806	44.63	5.94	35.40	44.00	41.97	54.00	-12.03	AV
Vertical	11490	61.92	8.46	39.75	44.50	65.63	74.00	-8.37	Pk
Vertical	11490	43.43	8.46	39.75	44.50	47.14	54.00	-6.86	AV
Vertical	17235	52.02	10.12	38.80	44.10	56.84	68.20	-11.36	Pk
Horizontal	2911	59.75	5.94	35.18	44.00	56.87	68.20	-11.33	Pk
Horizontal	11490	61.98	8.46	38.71	44.50	64.65	74.00	-9.35	Pk
Horizontal	11490	38.63	8.46	38.71	44.50	41.30	54.00	-12.70	AV
Horizontal	17235	54.32	10.12	38.38	44.10	58.72	68.20	-9.48	Pk
middle Channel (5785 MHz)-Above 1G									
Vertical	3763	61.96	6.48	36.35	44.05	60.74	74.00	-13.26	Pk
Vertical	3763	43.21	6.48	36.35	44.05	41.99	54.00	-12.01	AV
Vertical	11570	62.84	8.47	37.88	44.51	64.68	74.00	-9.32	Pk
Vertical	11570	41.52	8.47	37.88	44.51	43.36	54.00	-10.64	AV
Vertical	17355	57.01	10.12	38.8	44.10	61.83	68.20	-6.37	Pk
Horizontal	3561	51.39	6.48	36.37	44.05	50.19	68.20	-18.01	Pk
Horizontal	11570	57.36	8.47	38.64	44.50	59.97	74.00	-14.03	Pk
Horizontal	11570	40.09	8.47	38.64	44.50	42.70	54.00	-11.30	AV
Horizontal	17355	55.25	10.12	38.38	44.10	59.65	68.20	-8.55	Pk
High Channel (5825 MHz)-Above 1G									
Vertical	3907	60.16	7.10	37.24	43.50	61.00	74.00	-13.00	Pk
Vertical	3907	42.87	7.10	37.24	43.50	43.71	54.00	-10.29	AV
Vertical	11650	60.01	8.46	37.68	44.50	61.65	74.00	-12.35	Pk
Vertical	11650	39.54	8.46	37.68	44.50	41.18	54.00	-12.82	AV
Vertical	17475	52.14	10.12	38.8	44.10	56.96	68.20	-11.24	Pk
Horizontal	3912	59.70	7.10	37.24	43.50	60.54	74.00	-13.46	Pk
Horizontal	3912	39.48	7.10	37.24	43.50	40.32	54.00	-13.68	AV
Horizontal	11650	59.69	8.46	38.57	44.50	62.22	74.00	-11.78	Pk
Horizontal	11650	44.19	8.46	38.57	44.50	46.72	54.00	-7.28	AV
Horizontal	17475	53.58	10.12	38.38	44.10	57.98	68.20	-10.22	Pk

Note:"802.11ac20(5G)" mode is the worst mode. PK value is lower than the Average value limit, So average didn't record.

The amplitude of spurious emissions that are attenuated by more than 20dB below the permissible value

has no need to be reported.

Emission level (dBuV/m) = 20 log Emission level (uV/m).

Corrected Reading: Antenna Factor + Cable Loss + Read Level - Preamp Factor = Level.

3.2.10 TEST RESULTS (18GHz-40GHz)

EUT :	wifi extender	Model Name. :	805600
Temperature :	20 °C	Relative Humidity :	48%
Pressure :	1010 hPa	Test Voltage :	DC 5V powered by Adapter AC 120V/60Hz
Test Mode :	TX (5.2G)-802.11ac40 5190MHz~5230MHz; TX (5.8G)-802.11n20 5745MHz~5825MHz		

All the modulation modes have been tested, and the worst result was report as below:
Low Channel (5190 MHz)-Above 1G

Horizontal

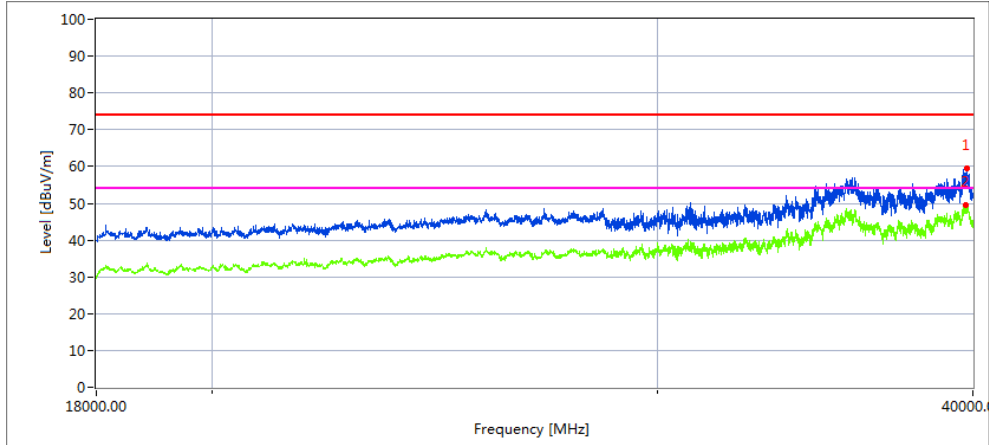

Frequency	Meter Reading	Cable loss	Antenna Factor	Preamp Factor	Emission Level	Limits	Margin	Remark
39769.27	33.82	20.09	44.07	43.48	54.5	68.2	13.7	Peak

Vertical

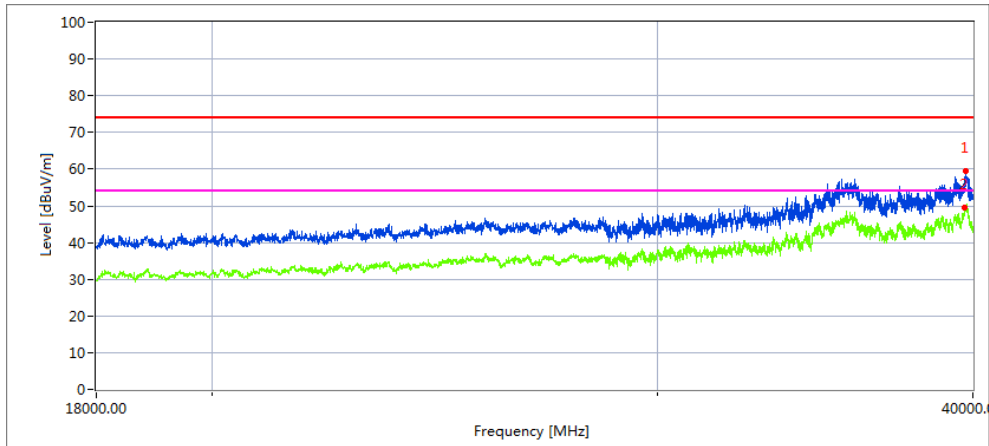

Frequency	Meter Reading	Cable loss	Antenna Factor	Preamp Factor	Emission Level	Limits	Margin	Remark
39769.546	35.92	20.09	44.07	43.48	56.6	68.2	11.6	Peak

High Channel (5230 MHz)-Above 1G

Horizontal

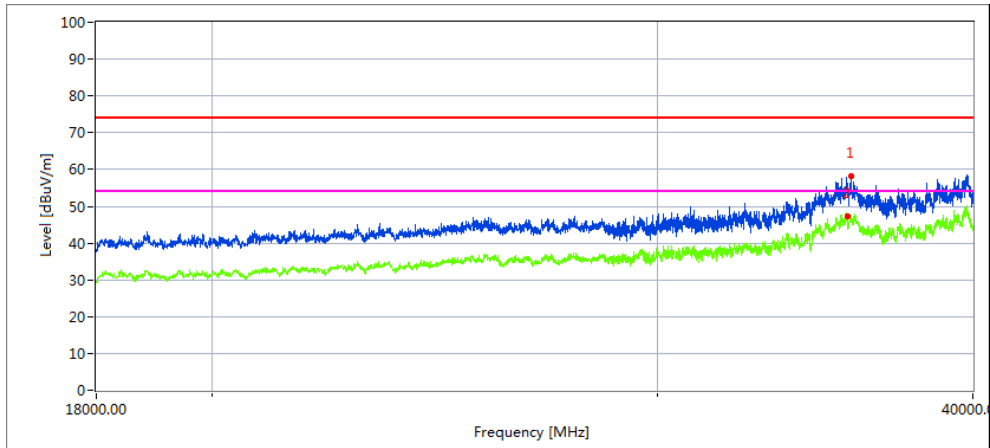

Frequency	Meter Reading	Cable loss	Antenna Factor	Preamp Factor	Emission Level	Limits	Margin	Remark
35628.37	38.37	19.11	42.73	44.61	55.6	68.2	12.6	Peak

Vertical

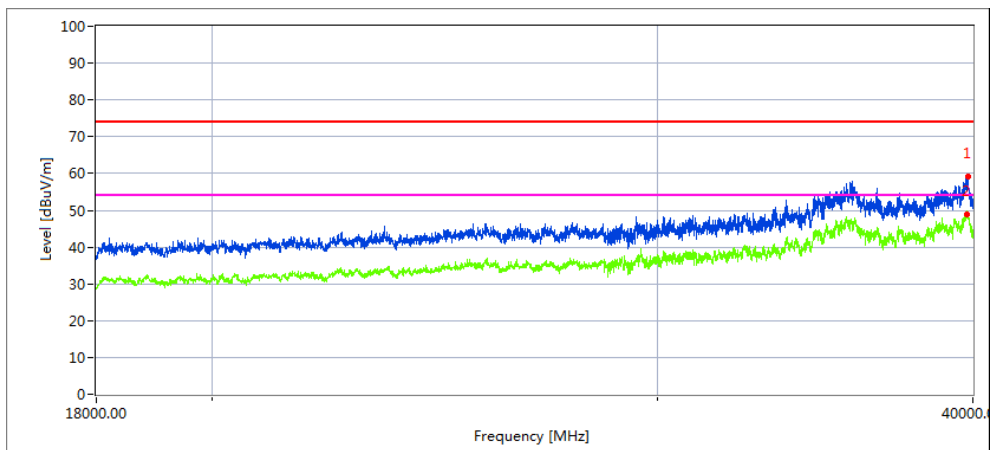

Frequency	Meter Reading	Cable loss	Antenna Factor	Preamp Factor	Emission Level	Limits	Margin	Remark
39769.476	35.42	20.09	44.07	43.48	56.1	68.2	12.1	Peak

Low Channel (5745 MHz)-Above 1G

Horizontal

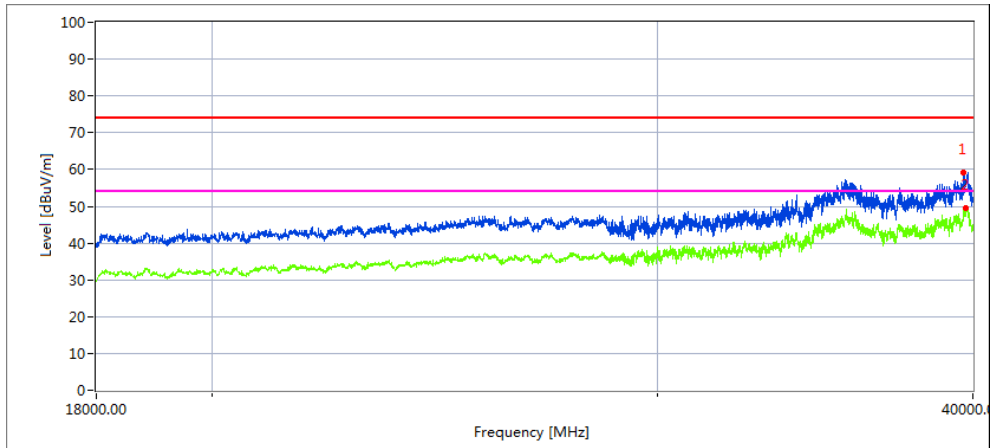

Frequency	Meter Reading	Cable loss	Antenna Factor	Preamp Factor	Emission Level	Limits	Margin	Remark
39670.224	33.43	20.09	44.16	43.48	54.2	68.2	14	Peak

Vertical

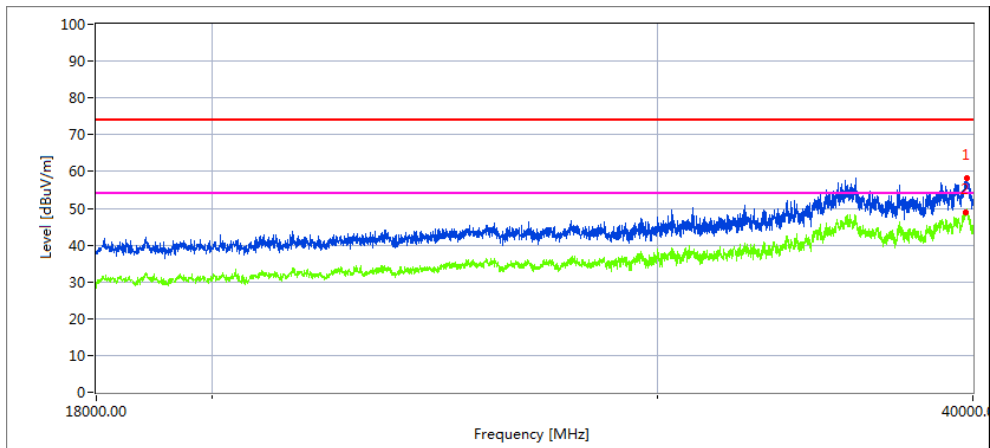

Frequency	Meter Reading	Cable loss	Antenna Factor	Preamp Factor	Emission Level	Limits	Margin	Remark
39731.342	36.58	20.06	44.07	43.21	57.5	68.2	10.7	Peak

High Channel (5825 MHz)-Above 1G

Horizontal

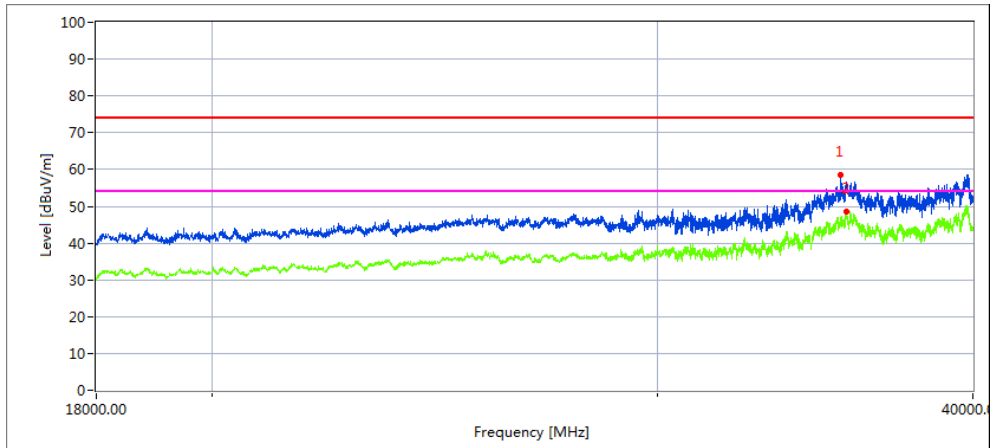

Frequency	Meter Reading	Cable loss	Antenna Factor	Preamp Factor	Emission Level	Limits	Margin	Remark
35628.534	38.84	19.11	42.63	43.48	57.1	68.2	11.1	Peak

Vertical

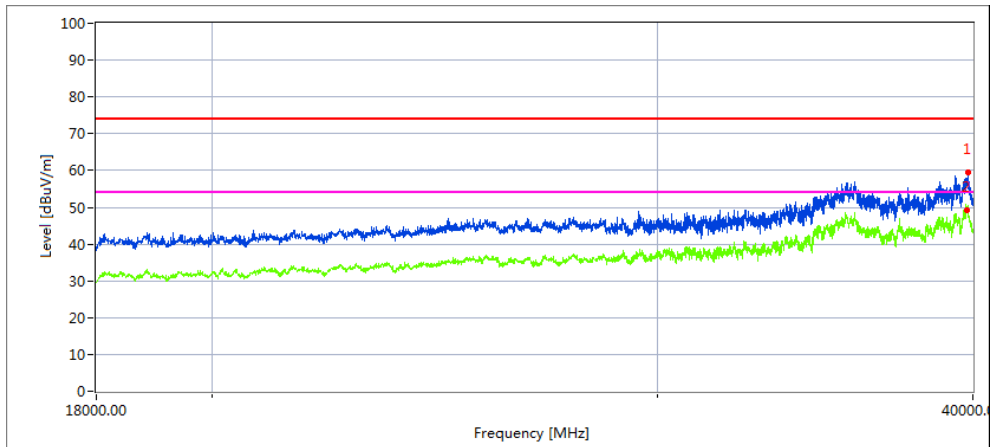

Frequency	Meter Reading	Cable loss	Antenna Factor	Preamp Factor	Emission Level	Limits	Margin	Remark
39821.763	34.92	20.1	44.1	43.22	55.9	68.2	12.3	Peak

3.2.11 Spurious Emission in Restricted Band 4.5GHz~5.150 GHz& 5.350GHz~5460GHz

EUT :	wifi extender	Model Name. :	805600
Temperature :	20 °C	Relative Humidity :	48%
Pressure :	1010 hPa	Test Voltage :	DC 5V powered by Adapter AC 120V/60Hz
Test Mode :	TX (5.2G)-802.11n20 5150MHz~5250MHz,		

Note: 1,2 Represent the value of antenna 1 and 2,The worst data is Antenna 1,only shown Antenna 1 data

All the modulation modes have been tested, The report just record the worst data mode.

Frequency	Meter Reading	Cable Loss	Antenna Factor	Preamp Factor	Emission Level	Limits	Margin	Detector	Comment
(MHz)	(dBμV)	(dB)	dB/m	(dB)	(dBμV/m)	(dBμV/m)	(dB)	Type	
5.2G WIFI-802.11n20 Mode Low Channel									
4500	63.31	5.2	35.6	44.2	59.91	74	-14.09	Pk	Horizontal
4500	46.96	5.2	35.6	44.2	43.56	54	-10.44	AV	Horizontal
4500	54.38	5.2	35.6	44.2	50.98	74	-23.02	Pk	Horizontal
4500	40.93	5.2	35.6	44.2	37.53	54	-16.47	AV	Horizontal
5150	70.52	5.36	35.66	44.22	67.32	74	-6.68	Pk	Horizontal
5150	52.90	5.36	35.66	44.22	49.70	54	-4.30	AV	Horizontal
5150	71.12	5.36	35.66	44.22	67.92	74	-6.08	Pk	Vertical
5150	51.63	5.36	35.66	44.22	48.43	54	-5.57	AV	Vertical
5.2G WIFI-802.11n20 Mode High Channel									
5350	62.44	5.68	35.68	44.22	59.58	74	-14.42	Pk	Vertical
5350	42.23	5.68	35.68	44.22	39.37	54	-14.63	AV	Vertical
5350	55.61	5.68	35.68	44.22	52.75	74	-21.25	Pk	Horizontal
5350	39.20	5.68	35.68	44.22	36.34	54	-17.66	AV	Horizontal

Note: (1) Emission Level= Antenna Factor + Cable Loss + Read Level - Preamp Factor

(2) "802.11n20 " mode is the worst mode. When PK value is lower than the Average value limit, average don't record.

4. POWER SPECTRAL DENSITY TEST

4.1 APPLIED PROCEDURES / LIMIT

According to FCC §15.407(a)

For the band 5.15-5.25 GHz,

(i) For an outdoor access point operating in the band 5.15-5.25 GHz, the maximum power spectral density shall not exceed 17 dBm in any 1 megahertz band. If transmitting antennas of directional gain greater than 6 dBi are used, both the maximum conducted output power and the maximum power spectral density shall be reduced by the amount in dB that the directional gain of the antenna exceeds 6 dBi. The maximum e.i.r.p. at any elevation angle above 30 degrees as measured from the horizon must not exceed 125 mW (21 dBm).

(ii) For an indoor access point operating in the band 5.15-5.25 GHz, the maximum power spectral density shall not exceed 17 dBm in any 1 megahertz band. If transmitting antennas of directional gain greater than 6 dBi are used, both the maximum conducted output power and the maximum power spectral density shall be reduced by the amount in dB that the directional gain of the antenna exceeds 6 dBi.

(iii) For fixed point-to-point access points operating in the band 5.15-5.25 GHz, the maximum power spectral density shall not exceed 17 dBm in any 1 megahertz band. Fixed point-to-point U-NII devices may employ antennas with directional gain up to 23 dBi without any corresponding reduction in the maximum conducted output power or maximum power spectral density. For fixed point-to-point transmitters that employ a directional antenna gain greater than 23 dBi, a 1 dB reduction in maximum conducted output power and maximum power spectral density is required for each 1 dB of antenna gain in excess of 23 dBi. Fixed, point-to-point operations exclude the use of point-to-multipoint systems, omnidirectional applications, and multiple collocated transmitters transmitting the same information. The operator of the U-NII device, or if the equipment is professionally installed, the installer, is responsible for ensuring that systems employing high gain directional antennas are used exclusively for fixed, point-to-point operations.

(iv) For client devices in the 5.15-5.25 GHz band, the maximum power spectral density shall not exceed 11 dBm in any 1 megahertz band. If transmitting antennas of directional gain greater than 6 dBi are used, both the maximum conducted output power and the maximum power spectral density shall be reduced by the amount in dB that the directional gain of the antenna exceeds 6 dBi.

For the 5.25-5.35 GHz and 5.47-5.725 GHz bands, the maximum conducted output power over the frequency bands of operation shall not exceed the lesser of 250 mW or $11 \text{ dBm} + 10 \log B$, where B is the 26 dB emission bandwidth in megahertz. In addition, the maximum power spectral density shall not exceed 11 dBm in any 1 megahertz band. If transmitting antennas of directional gain greater than 6 dBi are used, both the maximum conducted output power and the maximum power spectral density shall be reduced by the amount in dB that the directional gain of the antenna exceeds 6 dBi.

For the band 5.725-5.85 GHz

(3) For the band 5.725-5.85 GHz, the maximum power spectral density shall not exceed 30 dBm in any 500-kHz band. If transmitting antennas of directional gain greater than 6 dBi are used, both the maximum conducted output power and the maximum power spectral density shall be reduced by the amount in dB that the directional gain of the antenna exceeds 6 dBi.

,

4.2 TEST PROCEDURE

For devices operating in the bands 5.15-5.25 GHz, 5.25-5.35 GHz, and 5.47-5.725 GHz, the above procedures make use of 1 MHz RBW to satisfy directly the 1 MHz reference bandwidth specified in § 15.407(a)(5). For devices operating in the band 5.725-5.85 GHz, the rules specify a measurement bandwidth of 500 kHz. Many spectrum analyzers do not have 500 kHz RBW, thus a narrower RBW may need to be used. The rules permit the use of a RBWs less than 1 MHz, or 500 kHz, “provided that the measured power is integrated over the full reference bandwidth” to show the total power over the specified measurement bandwidth (i.e., 1 MHz, or 500 kHz). If measurements are performed using a reduced resolution bandwidth (< 1 MHz, or < 500 kHz) and integrated over 1 MHz, or 500 KHz bandwidth, the following adjustments to the procedures apply:

- a) Set RBW $\geq 1/T$, where T is defined in section II.B.I.a).
- b) Set VBW ≥ 3 RBW.
- c) If measurement bandwidth of Maximum PSD is specified in 500 kHz, add $10\log(500\text{kHz}/\text{RBW})$ to the measured result, whereas RBW (< 500 KHz) is the reduced resolution bandwidth of the spectrum analyzer set during measurement.
- d) If measurement bandwidth of Maximum PSD is specified in 1 MHz, add $10\log(1\text{MHz}/\text{RBW})$ to the measured result, whereas RBW (< 1 MHz) is the reduced resolution bandwidth of spectrum analyzer set during measurement.
- e) Care must be taken to ensure that the measurements are performed during a period of continuous transmission or are corrected upward for duty cycle.

Note: As a practical matter, it is recommended to use reduced RBW of 100 KHz for the sections 5.c) and 5.d) above, since RBW=100 KHZ is available on nearly all spectrum analyzers.

4.3 DEVIATION FROM STANDARD

No deviation.

4.4 TEST SETUP



4.5 EUT OPERATION CONDITIONS

The EUT tested system was configured as the statements of 2.1 Unless otherwise a special operating condition is specified in the follows during the testing.

4.6 TEST RESULTS

EUT :	wifi extender	Model Name :	805600
Temperature :	26 °C	Relative Humidity :	54%
Pressure :	1015 hPa	Test Voltage :	DC 5V powered by Adapter AC 120V/60Hz
Test Mode :	TX Frequency Band 1 (5150-5250MHz), Band 2 (5745-5825MHz)		

Refer to section 5 of this report:
For 5G band. Directional gain=5.51dBi; 6.0dBi > 5.51dBi, so PSD limit not calculated

Test data reference attachment.

5. 26DB & 99% EMISSION BANDWIDTH

5.1 APPLIED PROCEDURES / LIMIT

The maximum power spectral density is measured as a conducted emission by direct connection of a calibrated test instrument to the equipment under test. If the device cannot be connected directly, alternative techniques acceptable to the Commission may be used. Measurements in the 5.725-5.85 GHz band are made over a reference bandwidth of 500 kHz or the 26 dB emission bandwidth of the device, whichever is less. Measurements in the 5.15-5.25 GHz, 5.25-5.35 GHz, and the 5.47-5.725 GHz bands are made over a bandwidth of 1 MHz or the 26 dB emission bandwidth of the device, whichever is less. A narrower resolution bandwidth can be used, provided that the measured power is integrated over the full reference bandwidth.

5.2 TEST PROCEDURE

- a) Set RBW = approximately 1% of the emission bandwidth.
- b) Set the VBW > RBW.
- c) Detector = Peak.
- d) Trace mode = max hold.
- e) Measure the maximum width of the emission that is 26 dB down from the maximum of the emission. Compare this with the RBW setting of the analyzer. Readjust RBW and repeat measurement as needed until the RBW/EBW ratio is approximately 1%.

The following procedure shall be used for measuring (99 %) power bandwidth:

- 1. Set center frequency to the nominal EUT channel center frequency.
- 2. Set span = 1.5 times to 5.0 times the OBW.
- 3. Set RBW = 1 % to 5 % of the OBW
- 4. Set VBW $\geq 3 \cdot$ RBW
- 5. Video averaging is not permitted. Where practical, a sample detection and single sweep mode shall be used. Otherwise, peak detection and max hold mode (until the trace stabilizes) shall be used.
- 6. Use the 99 % power bandwidth function of the instrument (if available).
- 7. If the instrument does not have a 99 % power bandwidth function, the trace data points are recovered and directly summed in power units. The recovered amplitude data points, beginning at the lowest frequency, are placed in a running sum until 0.5 % of the total is reached; that frequency is recorded as the lower frequency. The process is repeated until 99.5 % of the total is reached; that frequency is recorded as the upper frequency. The 99% occupied bandwidth is the difference between these two frequencies.

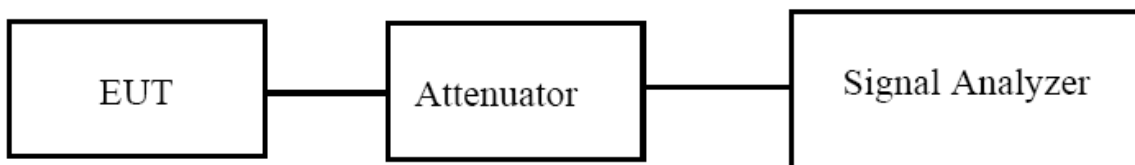

5.3 EUT OPERATION CONDITIONS

The EUT tested system was configured as the statements of 2.4 Unless otherwise a special operating condition is specified in the follows during the testing.

5.4 TEST RESULTS

EUT :	wifi extender	Model Name :	805600
Temperature :	26 °C	Relative Humidity :	54%
Pressure :	1012 hPa	Test Voltage :	DC 5V powered by Adapter AC 120V/60Hz
Test Mode :	TX Frequency Band 1 (5150-5250MHz), Band 2 (5745-5825MHz)		

Test data reference attachment.

6. MINIMUM 6 DB BANDWIDTH

6.1 APPLIED PROCEDURES / LIMIT

According to FCC §15.407(e)

(e) Within the 5.725-5.85 GHz band, the minimum 6 dB bandwidth of U-NII devices shall be at least 500 kHz.

6.2 TEST PROCEDURE

Section 15.407(e) specifies the minimum 6 dB emission bandwidth of at least 500 KHz for the band 5.715-5.85 GHz. The following procedure shall be used for measuring this bandwidth:

- a) Set RBW = 100 kHz.
- b) Set the video bandwidth (VBW) $\geq 3 \times$ RBW.
- c) Detector = Peak.
- d) Trace mode = max hold.
- e) Sweep = auto couple.
- f) Allow the trace to stabilize.
- g) Measure the maximum width of the emission that is constrained by the frequencies associated with the two outermost amplitude points (upper and lower frequencies) that are attenuated by 6 dB relative to the maximum level measured in the fundamental emission.

6.3 DEVIATION FROM STANDARD

No deviation.

6.4 TEST SETUP

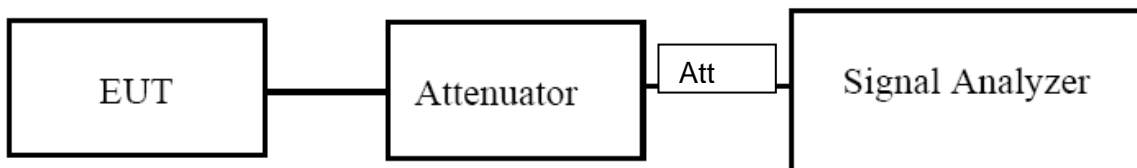

6.5 EUT OPERATION CONDITIONS

The EUT tested system was configured as the statements of 2.4 Unless otherwise a special operating condition is specified in the follows during the testing.

6.6 TEST RESULTS

EUT :	wifi extender	Model Name :	805600
Temperature :	26 °C	Relative Humidity :	54%
Pressure :	1012 hPa	Test Voltage :	DC 5V powered by Adapter AC 120V/60Hz
Test Mode :	TX (5G) Mode Frequency Band 2 (5725-5850MHz)		

Test data reference attachment.

7. MAXIMUM CONDUCTED OUTPUT POWER

7.1 PPLIED PROCEDURES / LIMIT

According to FCC §15.407

The maximum conduced output power should not exceed:

Frequency Band(MHz)	Limit
5150~5250	1W
5725~5850	1W

7.2 TEST PROCEDURE

· Method PM is Measurement using an RF average power meter. The procedure for this method is as follows:

- a) Measurements may be performed using a wideband RF power meter with a thermocouple detector or equivalent if all of the following conditions are satisfied:
 - 1) The EUT is configured to transmit continuously, or to transmit with a constant duty cycle.
 - 2) At all times when the EUT is transmitting, it shall be transmitting at its maximum power control level.
 - 3) The integration period of the power meter exceeds the repetition period of the transmitted signal by at least a factor of five.
- b) If the transmitter does not transmit continuously, measure the duty cycle D of the transmitter output signal as described in 12.2.
- c) Measure the average power of the transmitter. This measurement is an average over both the ON and OFF periods of the transmitter.
- d) Adjust the measurement in dBm by adding $[10 \log (1 / D)]$, where D is the duty cycle {e.g., $[10 \log (1 / 0.25)]$, if the duty cycle is 25%}.

7.3 DEVIATION FROM STANDARD

No deviation.

7.4 TEST SETUP

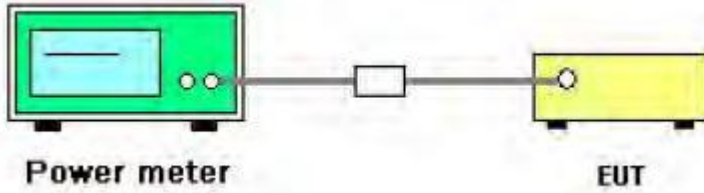

6.5 EUT OPERATION CONDITIONS

The EUT tested system was configured as the statements of 2.4 Unless otherwise a special operating condition is specified in the follows during the testing.

7.5 TEST RESULTS

EUT :	wifi extender	Model Name :	805600
Temperature :	26 °C	Relative Humidity :	54%
Pressure :	1012 hPa	Test Voltage :	DC 5V powered by Adapter AC 120V/60Hz
Test Mode :	TX Frequency Band 1 (5150-5250MHz), Band 2 (5745-5825MHz)		

Refer to section 5 of this report:

For 5G band. Directional gain=5.51dBi; 6.0dBi > 5.51dBi, so conducted power limit not calculated

Test data reference attachment.

8. OUT OF BAND EMISSIONS

8.1 APPLICABLE STANDARD

According to FCC §15.407(b)

Undesirable emission limits. Except as shown in paragraph (b)(7) of this section, the maximum emissions outside of the frequency bands of operation shall be attenuated in accordance with the following limits:

- (1) For transmitters operating in the 5.15-5.25 GHz band: All emissions outside of the 5.15-5.35 GHz band shall not exceed an e.i.r.p. of -27 dBm/MHz.

- (2) For transmitters operating in the 5.725-5.85 GHz band: For transmitters operating in the 5.725-5.85 GHz band: All emissions shall be limited to a level of -27 dBm/MHz at 75 MHz or more above or below the band edge increasing linearly to 10 dBm/MHz at 25 MHz above or below the band edge, and from 25 MHz above or below the band edge increasing linearly to a level of 15.6 dBm/MHz at 5 MHz above or below the band edge, and from 5 MHz above or below the band edge increasing linearly to a level of 27 dBm/MHz at the band edge.

8.2 TEST PROCEDURE

1. Check the calibration of the measuring instrument using either an internal calibrator or a known signal from an external generator.
2. Position the EUT without connection to measurement instrument. Turn on the EUT and connect its antenna terminal to measurement instrument via a low loss cable. Then set it to any one measured frequency within its operating range, and make sure the instrument is operated in its linear range.
3. Set RBW of spectrum analyzer to 1 MHz with a convenient frequency span.
4. Measure the highest amplitude appearing on spectral display and set it as a reference level. Plot the graph with marking the highest point and edge frequency.
5. Repeat above procedures until all measured frequencies were complete.

8.3 DEVIATION FROM STANDARD

No deviation.

8.4 TEST SETUP

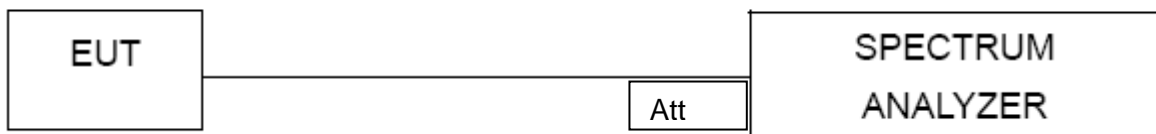

8.5 EUT OPERATION CONDITIONS

The EUT tested system was configured as the statements of 2.4 Unless otherwise a special operating condition is specified in the follows during the testing.

8.6 TEST RESULTS

EUT :	wifi extender	Model Name :	805600
Temperature :	26 °C	Relative Humidity :	54%
Pressure :	1012 hPa	Test Voltage :	DC 5V powered by Adapter AC 120V/60Hz

Test data reference attachment.

9. Frequency Stability Measurement

9.1 LIMIT

Manufactures of U-NII devices are responsible for ensuring frequency stability such that an emission is maintained within the band of operation under all conditions of normal operation as specified in the user's manual.

9.2 TEST PROCEDURES

1. The transmitter output (antenna port) was connected to the spectrum analyzer.
2. EUT have transmitted absence of modulation signal and fixed channelize.
3. Set the spectrum analyzer span to view the entire absence of modulation emissions bandwidth.
4. Set RBW = 10 kHz, VBW = 10 kHz with peak detector and maxhold settings.
5. f_c is declaring of channel frequency. Then the frequency error formula is $(f_c - f) / f_c \times 10^6$ ppm and the limit is less than ± 20 ppm (IEEE 802.11 specification).
6. The test extreme voltage is to change the primary supply voltage from 85 to 115 percent of the nominal value
7. Extreme temperature is $-20^\circ\text{C} \sim 70^\circ\text{C}$.

9.3 TEST SETUP LAYOUT

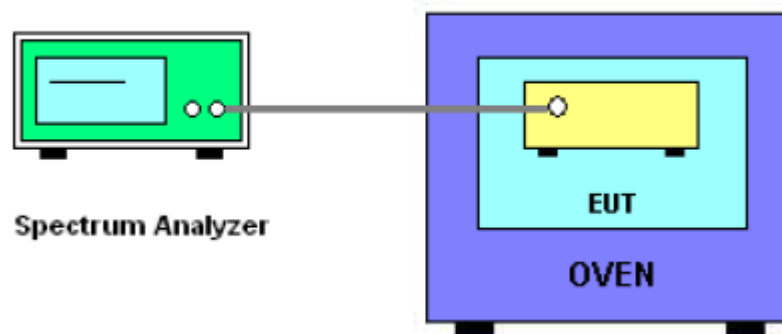

9.4 EUT OPERATION DURING TEST

1. The EUT was programmed to be in continuously un-modulation transmitting mode.
2. The has two antennas, and the worst data is Antenna 1, only shown Antenna 1 Plot.

9.5 TEST RESULTS

EUT :	wifi extender	Model Name. :	805600
Temperature :	25 °C	Relative Humidity :	56%
Pressure :	1012 hPa	Test Voltage :	DC 5V powered by Adapter AC 120V/60Hz
Test Mode :	TX Frequency Band I (5150-5250MHz)		

Voltage vs. Frequency Stability

TEST CONDITIONS				Reference Frequency: 5180MHz			
				f	fc	Max. Deviation (MHz)	Max. Deviation (ppm)
T nom (°C)	20	V nom (V)	5.00	5180.0017	5180	0.0017	0.3243
		V max (V)	5.75	5180.0016	5180	0.0016	0.3114
		V min (V)	4.25	5180.0010	5180	0.0010	0.1874
Limits				Within 5150-5250MHz			
Result				Complies			

Temperature vs. Frequency Stability

TEST CONDITIONS				Reference Frequency: 5180MHz			
				f	fc	Max. Deviation (MHz)	Max. Deviation (ppm)
V nom (V)	5	T (°C)	-20	5180.0019	5180	0.0019	0.3744
		T (°C)	-10	5180.0011	5180	0.0011	0.2104
		T (°C)	0	5180.0014	5180	0.0014	0.2785
		T (°C)	10	5180.0019	5180	0.0019	0.3592
		T (°C)	20	5180.0000	5180	0.0000	0.0005
		T (°C)	30	5180.0006	5180	0.0006	0.1103
		T (°C)	40	5180.0012	5180	0.0012	0.2391
		T (°C)	50	5180.0006	5180	0.0006	0.1068
		T (°C)	60	5180.0003	5180	0.0003	0.0486
		T (°C)	70	5180.0005	5180	0.0005	0.0924
Limits				Within 5150-5250MHz			
Result				Complies			

Voltage vs. Frequency Stability

TEST CONDITIONS				Reference Frequency: 5200MHz			
				f	fc	Max. Deviation (MHz)	Max. Deviation (ppm)
T nom (°C)	20	V nom (V)	5.00	5200.0018	5200	0.0018	0.3544
		V max (V)	5.75	5200.0011	5200	0.0011	0.2188
		V min (V)	4.25	5200.0004	5200	0.0004	0.0696
Limits				Within 5150-5250MHz			
Result				Complies			

Temperature vs. Frequency Stability

TEST CONDITIONS				Reference Frequency: 5200MHz			
				f	fc	Max. Deviation (MHz)	Max. Deviation (ppm)
V nom (V)	5	T (°C)	-20	5200.0015	5200	0.0015	0.2873
		T (°C)	-10	5200.0010	5200	0.0010	0.1967
		T (°C)	0	5200.0017	5200	0.0017	0.3336
		T (°C)	10	5200.0013	5200	0.0013	0.2518
		T (°C)	20	5200.0006	5200	0.0006	0.1154
		T (°C)	30	5200.0007	5200	0.0007	0.1398
		T (°C)	40	5200.0007	5200	0.0007	0.1259
		T (°C)	50	5200.0017	5200	0.0017	0.3268
		T (°C)	60	5200.0006	5200	0.0006	0.1134
		T (°C)	70	5200.0008	5200	0.0008	0.1456
Limits				Within 5150-5250MHz			
Result				Complies			

Voltage vs. Frequency Stability

TEST CONDITIONS				Reference Frequency: 5240MHz			
				f	fc	Max. Deviation (MHz)	Max. Deviation (ppm)
T nom (°C)	20	V nom (V)	5.00	5240.0020	5240	0.0020	0.3742
		V max (V)	5.75	5240.0007	5240	0.0007	0.1262
		V min (V)	4.25	5240.0004	5240	0.0004	0.0857
Limits				Within 5150-5250MHz			
Result				Complies			

Temperature vs. Frequency Stability

TEST CONDITIONS				Reference Frequency: 5240MHz			
				f	fc	Max. Deviation (MHz)	Max. Deviation (ppm)
V nom (V)	5	T (°C)	-20	5240.0010	5240	0.0010	0.1978
		T (°C)	-10	5240.0007	5240	0.0007	0.1366
		T (°C)	0	5240.0015	5240	0.0015	0.2818
		T (°C)	10	5240.0002	5240	0.0002	0.0405
		T (°C)	20	5240.0001	5240	0.0001	0.0188
		T (°C)	30	5240.0018	5240	0.0018	0.3392
		T (°C)	40	5240.0009	5240	0.0009	0.1649
		T (°C)	50	5240.0019	5240	0.0019	0.3627
		T (°C)	60	5240.0007	5240	0.0007	0.1325
		T (°C)	70	5240.0008	5240	0.0008	0.1492
Limits				Within 5150-5250MHz			
Result				Complies			

EUT :	wifi extender	Model Name. :	805600
Temperature :	25 °C	Relative Humidity :	56%
Pressure :	1012 hPa	Test Voltage :	DC 5V powered by Adapter AC 120V/60Hz
Test Mode :	TX Frequency(5745-5850MHz)		

Voltage vs. Frequency Stability

TEST CONDITIONS				Reference Frequency: 5745MHz			
				f	fc	Max. Deviation (MHz)	Max. Deviation (ppm)
T nom (°C)	20	V nom (V)	5.00	5745.0005	5745	0.0005	0.0844
		V max (V)	5.75	5745.0010	5745	0.0010	0.1766
		V min (V)	4.25	5745.0006	5745	0.0006	0.0968
Limits				Within 5745-5850MHz			
Result				Complies			

Temperature vs. Frequency Stability

TEST CONDITIONS				Reference Frequency: 5745MHz			
				f	fc	Max. Deviation (MHz)	Max. Deviation (ppm)
V nom (V)	5	T (°C)	-20	5745.0012	5745	0.0012	0.2070
		T (°C)	-10	5745.0007	5745	0.0007	0.1286
		T (°C)	0	5745.0017	5745	0.0017	0.3034
		T (°C)	10	5745.0001	5745	0.0001	0.0217
		T (°C)	20	5745.0020	5745	0.0020	0.3481
		T (°C)	30	5745.0003	5745	0.0003	0.0491
		T (°C)	40	5745.0019	5745	0.0019	0.3391
		T (°C)	50	5745.0012	5745	0.0012	0.2128
		T (°C)	60	5745.0014	5745	0.0014	0.2454
		T (°C)	70	5745.0009	5745	0.0009	0.1486
Limits				Within 5745-5850MHz			
Result				Complies			

Voltage vs. Frequency Stability

TEST CONDITIONS				Reference Frequency: 5785MHz			
				f	fc	Max. Deviation (MHz)	Max. Deviation (ppm)
T nom (°C)	20	V nom (V)	5.00	5785.0006	5785	0.00065	-0.1116
		V max (V)	5.75	5785.0019	5785	0.00188	-0.3252
		V min (V)	4.25	5785.0003	5785	0.00027	-0.0470
Limits				Within 5745-5850MHz			
Result				Complies			

Temperature vs. Frequency Stability

TEST CONDITIONS				Reference Frequency: 5785MHz			
				f	fc	Max. Deviation (MHz)	Max. Deviation (ppm)
V nom (V)	5	T (°C)	-20	5785.0017	5785	0.0017	0.2889
		T (°C)	-10	5785.0017	5785	0.0017	0.2987
		T (°C)	0	5785.0005	5785	0.0005	0.0922
		T (°C)	10	5785.0010	5785	0.0010	0.1708
		T (°C)	20	5785.0017	5785	0.0017	0.2997
		T (°C)	30	5785.0013	5785	0.0013	0.2169
		T (°C)	40	5785.0013	5785	0.0013	0.2165
		T (°C)	50	5785.0005	5785	0.0005	0.0899
		T (°C)	60	5785.0007	5785	0.0007	0.1159
		T (°C)	70	5785.0017	5785	0.0017	0.2889
Limits				Within 5745-5850MHz			
Result				Complies			

Voltage vs. Frequency Stability

TEST CONDITIONS				Reference Frequency: 5825MHz			
				f	fc	Max. Deviation (MHz)	Max. Deviation (ppm)
T nom (°C)	20	V nom (V)	5.00	5825.0019	5825	0.0019	0.3238
		V max (V)	5.75	5825.0007	5825	0.0007	0.1176
		V min (V)	4.25	5825.0019	5825	0.0019	0.3302
Limits				Within 5745-5850MHz			
Result				Complies			

Temperature vs. Frequency Stability

TEST CONDITIONS				Reference Frequency: 5825MHz			
				f	fc	Max. Deviation (MHz)	Max. Deviation (ppm)
V nom (V)	5	T (°C)	-20	5825.0011	5825	0.0011	0.1852
		T (°C)	-10	5825.0011	5825	0.0011	0.1832
		T (°C)	0	5825.0003	5825	0.0003	0.0523
		T (°C)	10	5825.0008	5825	0.0008	0.1364
		T (°C)	20	5825.0016	5825	0.0016	0.2787
		T (°C)	30	5825.0014	5825	0.0014	0.2385
		T (°C)	40	5825.0019	5825	0.0019	0.3292
		T (°C)	50	5825.0014	5825	0.0014	0.2408
		T (°C)	60	5825.0007	5825	0.0007	0.1132
		T (°C)	70	5825.0006	5825	0.0006	0.0980
Limits				Within 5745-5850MHz			
Result				Complies			

10. ANTENNA REQUIREMENT

10.1 STANDARD REQUIREMENT

15.203 requirement: For intentional device, according to 15.203: an intentional radiator shall be designed to ensure that no antenna other than that furnished by the responsible party shall be used with the device.

10.2 EUT ANTENNA

The EUT antenna is permanent attached Antenna 1: Rod antenna, Antenna 2: PCB Antenna (Gain: 2.5dBi).

It comply with the standard requirement.

END OF REPORT