



# **RADIO TEST REPORT**

## **FCC ID: 2AITF-BTHSAH8**

**Product:** Avantree Apico  
**Trade Name:** N/A  
**Model No.:** BTHS-AH8-BLK  
**Serial Model:** N/A  
**Report No.:** NTEK-2016NT07066985F  
**Issue Date:** 26 Jul. 2016

### **Prepared for**

Avantree Technology Co., Ltd.  
The 4th Floor, Yuepeng Building, No.1019 Jiabin Rd, Luohu  
District, Shenzhen, Guangdong, China.

### **Prepared by**

NTEK TESTING TECHNOLOGY CO., LTD.  
1/F, Building E, Fenda Science Park, Sanwei Community,  
Xixiang Street Bao'an District, Shenzhen, P.R. China  
Tel.: +86-0755-61156588  
Fax.: +86-0755-61156599  
Website: [www.ntek.org.cn](http://www.ntek.org.cn)

## TABLE OF CONTENTS

<b>1</b>	<b>TEST RESULT CERTIFICATION .....</b>	<b>3</b>
<b>2</b>	<b>SUMMARY OF TEST RESULTS.....</b>	<b>4</b>
<b>3</b>	<b>FACILITIES AND ACCREDITATIONS .....</b>	<b>5</b>
3.1	FACILITIES.....	5
3.2	LABORATORY ACCREDITATIONS AND LISTINGS .....	5
3.3	MEASUREMENT UNCERTAINTY .....	5
<b>4</b>	<b>GENERAL DESCRIPTION OF EUT .....</b>	<b>6</b>
<b>5</b>	<b>DESCRIPTION OF TEST MODES .....</b>	<b>8</b>
<b>6</b>	<b>SETUP OF EQUIPMENT UNDER TEST .....</b>	<b>9</b>
6.1	BLOCK DIAGRAM CONFIGURATION OF TEST SYSTEM.....	9
6.2	SUPPORT EQUIPMENT.....	10
6.3	EQUIPMENTS LIST FOR ALL TEST ITEMS.....	11
<b>7</b>	<b>TEST REQUIREMENTS .....</b>	<b>12</b>
7.1	CONDUCTED EMISSIONS TEST .....	12
7.2	RADIATED SPURIOUS EMISSION .....	17
7.3	NUMBER OF HOPPING CHANNEL.....	28
7.4	HOPPING CHANNEL SEPARATION MEASUREMENT .....	30
7.5	AVERAGE TIME OF OCCUPANCY (DWELL TIME) .....	36
7.6	20DB BANDWIDTH TEST .....	43
7.7	PEAK OUTPUT POWER.....	49
7.8	CONDUCTED BAND EDGE MEASUREMENT.....	56
7.9	ANTENNA APPLICATION .....	64



### 1 TEST RESULT CERTIFICATION

Applicant's name .....	Avantree Technology Co., Ltd.
Address .....	The 4th Floor, Yuepeng Building, No.1019 Jiabin Rd, Luohu District, Shenzhen, Guangdong,China.
Manufacture's Name .....	Avantree Technology Co., Ltd.
Address .....	The 4th Floor, Yuepeng Building, No.1019 Jiabin Rd, Luohu District, Shenzhen, Guangdong,China.
Product description	
Product name .....	Avantree Apico
Model and/or type reference .....	BTHS-AH8-BLK
Serial Model .....	N/A

Measurement Procedure Used:

APPLICABLE STANDARDS	
STANDARD/ TEST PROCEDURE	TEST RESULT
FCC 47 CFR Part 2, Subpart J:2015 FCC 47 CFR Part 15, Subpart C:2015 KDB 174176 D01 Line Conducted FAQ v01r01 ANSI C63.10-2013 DA 00-705	Complied

This device described above has been tested by NTEK Testing Technology Co., Ltd., and the test results show that the equipment under test (EUT) is in compliance with the FCC requirements. And it is applicable only to the tested sample identified in the report.

This report shall not be reproduced except in full, without the written approval of NTEK Testing Technology Co., Ltd., this document may be altered or revised by NTEK Testing Technology Co., Ltd., personnel only, and shall be noted in the revision of the document.

The test results of this report relate only to the tested sample identified in this report.

Date of Test : 6 Jul. 2016 ~ 26 Jul. 2016

Testing Engineer : *Eileen Liu.*  
(Eileen Liu)

Technical Manager : *Jason chen*  
(Jason Chen)

Authorized Signatory : *Sam . chen*  
(Sam Chen)

## 2 SUMMARY OF TEST RESULTS

FCC Part15 (15.247), Subpart C			
Standard Section	Test Item	Verdict	Remark
15.207	Conducted Emission	PASS	
15.247(d) 15.209	Radiated Spurious Emission	PASS	
15.247(a)(1)	Hopping Channel Separation	PASS	
15.247(b)(1)	Peak Output Power	PASS	
15.247(a)(iii)	Number of Hopping Frequency	PASS	
15.247(a)(iii)	Dwell Time	PASS	
15.247(a)(1)	Bandwidth	PASS	
15.205	Restricted Band	PASS	
15.247(d)	Band Edge	PASS	
15.203	Antenna Requirement	PASS	

Remark:

1. "N/A" denotes test is not applicable in this Test Report.
2. All test items were verified and recorded according to the standards and without any deviation during the test.

### 3 FACILITIES AND ACCREDITATIONS

#### 3.1 FACILITIES

All measurement facilities used to collect the measurement data are located at 1/F, Building E, Fenda Science Park, Sanwei Community, Xixiang Street, Bao'an District, Shenzhen P.R. China.

The sites are constructed in conformance with the requirements of ANSI C63.7, ANSI C63.10 and CISPR Publication 22.

#### 3.2 LABORATORY ACCREDITATIONS AND LISTINGS

Site Description

EMC Lab. : Accredited by CNAS, 2014.09.04  
 The certificate is valid until 2017.09.03  
 The Laboratory has been assessed and proved to be in compliance with CNAS-CL01:2006 (identical to ISO/IEC 17025:2005)  
 The Certificate Registration Number is L5516.

Accredited by FCC, September 6, 2013  
 The Certificate Registration Number is 238937.

Accredited by Industry Canada, August 29, 2012  
 The Certificate Registration Number is 9270A-1.

Name of Firm : NTEK Testing Technology Co., Ltd  
 Site Location : 1/F, Building E, Fenda Science Park, Sanwei Community, Xixiang Street, Bao'an District, Shenzhen P.R. China.

#### 3.3 MEASUREMENT UNCERTAINTY

The reported uncertainty of measurement  $y \pm U$ , where expanded uncertainty  $U$  is based on a standard uncertainty multiplied by a coverage factor of  $k=2$ , providing a level of confidence of approximately 95 %.

No.	Item	Uncertainty
1	Conducted Emission Test	$\pm 1.38\text{dB}$
2	RF power, conducted	$\pm 0.16\text{dB}$
3	Spurious emissions, conducted	$\pm 0.21\text{dB}$
4	All emissions, radiated(<1G)	$\pm 4.68\text{dB}$
5	All emissions, radiated(>1G)	$\pm 4.89\text{dB}$
6	Temperature	$\pm 0.5^\circ\text{C}$
7	Humidity	$\pm 2\%$

#### 4 GENERAL DESCRIPTION OF EUT

Product Feature and Specification	
Equipment	Avantree Apico
Trade Name	N/A
FCC ID	2AITF-BTHSAH8
Model No.	BTHS-AH8-BLK
Serial Model	N/A
Model Difference	N/A
Operating Frequency	2402MHz~2480MHz
Modulation	GFSK,π/4-DQPSK, 8DPSK
Number of Channels	79 Channels
Antenna Type	MULTILAYER CERAMIC ANTENNA
Antenna Gain	2.0 dBi
Power supply	<input checked="" type="checkbox"/> DC supply: DC 3.7V/35mAh from Li-ion Battery or DC 5V from USB Port.
	<input type="checkbox"/> Adapter supply: N/A
HW Version	
SW Version	

Note: Based on the application, features, or specification exhibited in User's Manual, the EUT is considered as an ITE/Computing Device. More details of EUT technical specification, please refer to the User's Manual.



## 5 DESCRIPTION OF TEST MODES

To investigate the maximum EMI emission characteristics generates from EUT, the test system was pre-scanning tested base on the consideration of following EUT operation mode or test configuration mode which possible have effect on EMI emission level. Each of these EUT operation mode(s) or test configuration mode(s) mentioned above was evaluated respectively.

The Transmitter was operated in the normal operating mode. The TX frequency was fixed which was for the purpose of the measurements.

Test of channel included the lowest and middle and highest frequency to perform the test, then record on this report.

Those data rates (1Mbps for GFSK modulation; 2Mbps for  $\pi/4$ -DQPSK modulation; 3Mbps for 8DPSK modulation) were used for all test.

The EUT was pretested with 3 orientations placed on the table for the radiated emission measurement –X, Y, and Z-plane. The Y-plane results were found as the worst case and were shown in this report.

Carrier Frequency and Channel list:

Channel	Frequency(MHz)
0	2402
1	2403
...	...
39	2441
40	2442
...	...
77	2479
78	2480

Note:  $f_c=2402\text{MHz}+k \times 1\text{MHz}$   $k=0$  to 78

The following summary table is showing all test modes to demonstrate in compliance with the standard.

For AC Conducted Emission	
Final Test Mode	Description
Mode 1	normal link mode

Note: AC power line Conducted Emission was tested under maximum output power.

For Radiated Test Cases	
Final Test Mode	Description
Mode 1	normal link mode
Mode 2	CH00(2402MHz)
Mode3	CH39(2441MHz)
Mode 4	CH78(2480MHz)

Note: For radiated test cases, the worst mode data rate 1Mbps was reported only, because this data rate has the highest RF output power at preliminary tests, and no other significantly frequencies found in conducted spurious emission.

For Conducted Test Cases	
Final Test Mode	Description
Mode 1	normal link mode
Mode 2	CH00(2402MHz)
Mode 3	CH39(2441MHz)
Mode 4	CH78(2480MHz)

Note: The engineering test program was provided and the EUT was programmed to be in continuously transmitting mode.



## 6 SETUP OF EQUIPMENT UNDER TEST

### 6.1 BLOCK DIAGRAM CONFIGURATION OF TEST SYSTEM

For AC Conducted Emission Mode

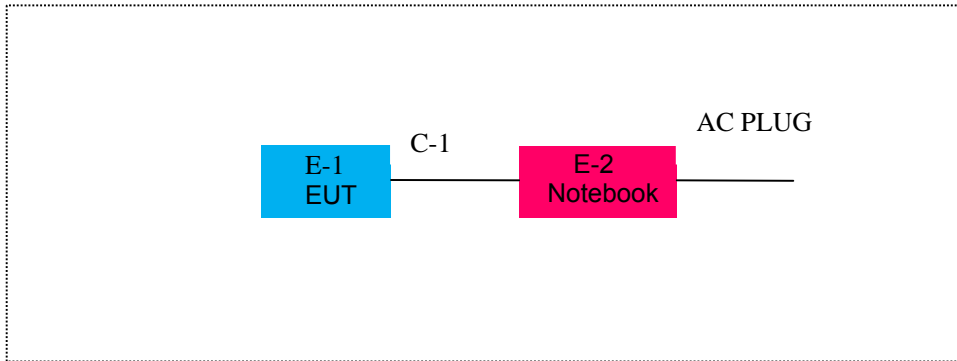

For Radiated Test Cases

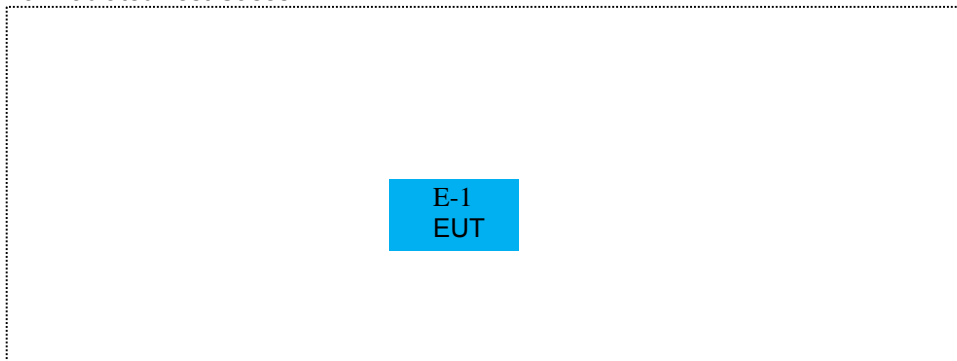

For Conducted Test Cases

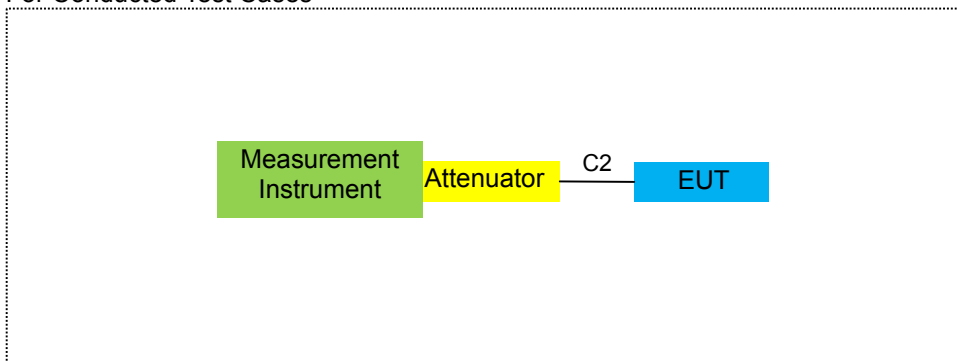

**6.2 SUPPORT EQUIPMENT**

The EUT has been tested as an independent unit together with other necessary accessories or support units. The following support units or accessories were used to form a representative test configuration during the tests.

Item	Equipment	Mfr/Brand	Model/Type No.	FCC ID	Note
E-1	Avantree Apico	N/A	BTHS-AH8-BLK	2AITF-BTHSAH8	EUT
E-2	Notebook	Lenove	Thinkpad Edge E430	N/A	Peripherals

Item	Cable Type	Shielded Type	Ferrite Core	Length
C-1	NO	NO	NO	1.2m
C-2	RF Cable	NO	NO	0.5m

**Notes:**

- (1) The support equipment was authorized by Declaration of Confirmation.
- (2) For detachable type I/O cable should be specified the length in cm in 『Length』 column.
- (3) “YES” is means “shielded” “with core”; “NO” is means “unshielded” “without core”.

**6.3 EQUIPMENTS LIST FOR ALL TEST ITEMS**

**Radiation Test equipment**

Item	Kind of Equipment	Manufacturer	Type No.	Serial No.	Last calibration	Calibrated until	Calibration period
1	Spectrum Analyzer	Agilent	E4407B	MY45108040	2016.07.06	2017.07.05	1 year
2	Test Receiver	R&S	ESPI	101318	2016.06.07	2017.06.06	1 year
3	Bilog Antenna	TESEQ	CBL6111D	31216	2016.07.06	2017.07.05	1 year
4	50Ω Coaxial Switch	Anritsu	MP59B	6200264416	2016.06.07	2017.06.06	1 year
5	Spectrum Analyzer	ADVANTEST	R3132	150900201	2016.06.07	2017.06.06	1 year
6	Horn Antenna	EM	EM-AH-10180	2011071402	2016.07.06	2017.07.05	1 year
7	Horn Ant	Schwarzbeck	BBHA 9170	9170-181	2016.07.06	2017.07.05	1 year
8	Amplifier	EM	EM-30180	060538	2015.12.22	2016.12.21	1 year
9	Loop Antenna	ARA	PLA-1030/B	1029	2016.06.08	2017.06.07	1 year
10	Power Meter	R&S	NRVS	100696	2016.07.06	2017.07.05	1 year
11	Power Sensor	R&S	URV5-Z4	0395.1619.05	2016.07.06	2017.07.05	1 year
12	Test Cable	N/A	R-01	N/A	2016.07.06	2017.07.05	1 year
13	Test Cable	N/A	R-02	N/A	2016.07.06	2017.07.05	1 year

**Conduction Test equipment**

Item	Kind of Equipment	Manufacturer	Type No.	Serial No.	Last calibration	Calibrated until	Calibration period
1	Test Receiver	R&S	ESCI	101160	2016.06.06	2017.06.05	1 year
2	LISN	R&S	ENV216	101313	2015.08.24	2016.08.23	1 year
3	LISN	EMCO	3816/2	00042990	2015.08.24	2016.08.23	1 year
4	50Ω Coaxial Switch	Anritsu	MP59B	6200264417	2016.06.07	2017.06.06	1 year
5	Passive Voltage Probe	R&S	ESH2-Z3	100196	2016.06.07	2017.06.06	1 year
6	Absorbing clamp	R&S	MOS-21	100423	2016.06.08	2017.06.07	1 year
7	Test Cable	N/A	C01	N/A	2016.06.08	2017.06.07	1 year
8	Test Cable	N/A	C02	N/A	2016.06.08	2017.06.07	1 year
9	Test Cable	N/A	C03	N/A	2016.06.08	2017.06.07	1 year
1	Attenuation	MCE	24-10-34	BN9258	2016.06.08	2017.06.07	1 year

Note: Each piece of equipment is scheduled for calibration once a year.

## 7 TEST REQUIREMENTS

### 7.1 CONDUCTED EMISSIONS TEST

#### 7.1.1 Applicable Standard

According to FCC Part 15.207(a) and KDB 174176 D01 Line Conducted FAQ v01r01

#### 7.1.2 Conformance Limit

Frequency(MHz)	Conducted Emission Limit	
	Quasi-peak	Average
0.15-0.5	66-56*	56-46*
0.5-5.0	56	46
5.0-30.0	60	50

Note: 1. \*Decreases with the logarithm of the frequency  
 2. The lower limit shall apply at the transition frequencies  
 3. The limit decreases in line with the logarithm of the frequency in the range of 0.15 to 0.50MHz.

#### 7.1.3 Test Configuration

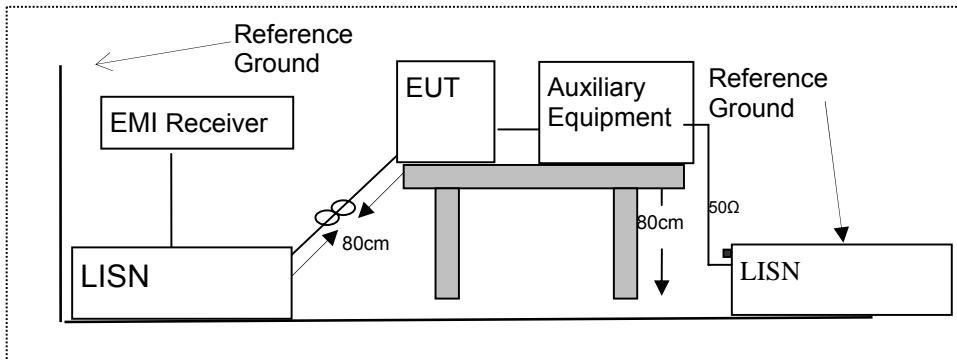

#### 7.1.4 Test Procedure

According to the requirements in Section 13.1.4.1 of ANSI C63.10-2013 Conducted emissions the EUT measured in the frequency range between 0.15 MHz and 30 MHz using CISPR Quasi-Peak and average detector mode.

1. The EUT was placed 0.4 meter from the conducting wall of the shielding room.
2. The EUT was placed on a table which is 0.8m above ground plane.
3. Connect EUT to the power mains through a line impedance stabilization network (LISN). All other support equipments powered from additional LISN(s). The LISN provide 50 Ohm/ 50uH of coupling impedance for the measuring instrument.
4. Interconnecting cables that hang closer than 40 cm to the ground plane shall be folded back and forth in the center forming a bundle 30 to 40cm long.
5. I/O cables that are not connected to a peripheral shall be bundled in the center. The end of the cable may be terminated, if required, using the correct terminating impedance. The overall length shall not exceed 1 m.
6. LISN at least 80 cm from nearest part of EUT chassis.
7. The frequency range from 150KHz to 30MHz was searched.
8. Set the test-receiver system to Peak Detect Function and specified bandwidth(IF bandwidth=9KHz) with Maximum Hold Mode
9. For the actual test configuration, please refer to the related Item –EUT Test Photos.

#### 7.1.5 Test Results

Pass

### 7.1.6 Test Results

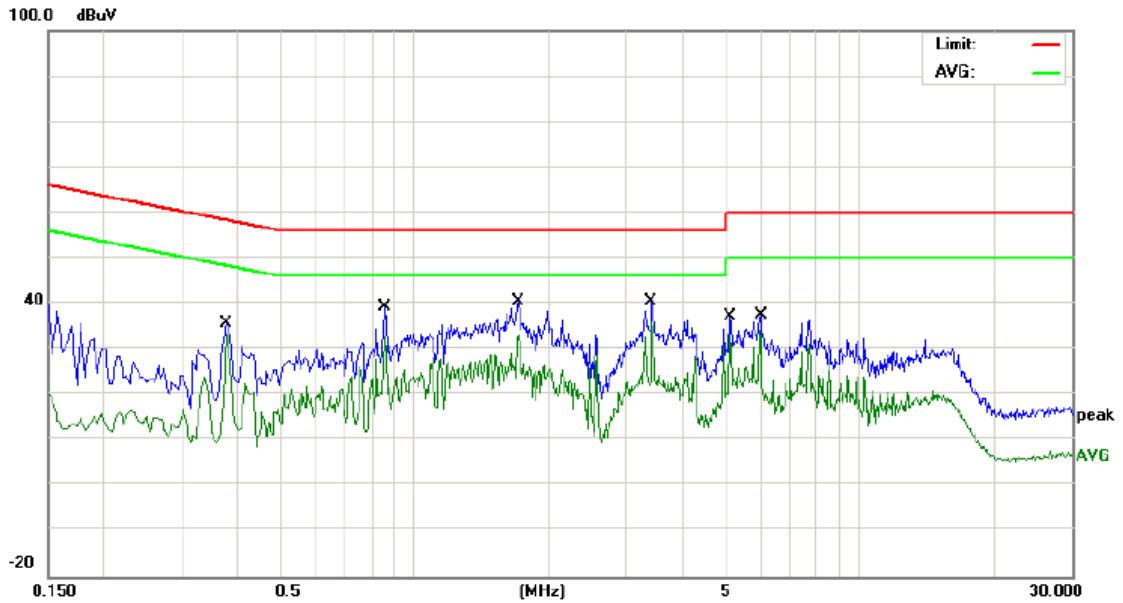

Site: | Phase: **L1** | Temperature: 22  
 Limit: FCC Part 15B (0.15-30MHz) Main QP | Power: AC 120V/60Hz | Humidity: 51 %  
 Mode: Mode 1  
 Note:

No. Mk.	Freq. MHz	Reading Level dBuV	Correct Factor dB	Measurement dBuV	Limit dBuV	Over dB	Detector	Comment
1	0.3780	25.46	10.06	35.52	58.32	-22.80	QP	
2	0.3780	23.16	10.06	33.22	48.32	-15.10	AVG	
3	0.8578	29.53	9.82	39.35	56.00	-16.65	QP	
4	0.8578	22.89	9.82	32.71	46.00	-13.29	AVG	
5	1.7098	30.82	9.76	40.58	56.00	-15.42	QP	
6	1.7098	23.11	9.76	32.87	46.00	-13.13	AVG	
7	3.4140	30.75	9.74	40.49	56.00	-15.51	QP	
8 *	3.4140	26.21	9.74	35.95	46.00	-10.05	AVG	
9	5.1379	27.47	9.76	37.23	60.00	-22.77	QP	
10	5.1379	23.57	9.76	33.33	50.00	-16.67	AVG	
11	5.9739	27.79	9.76	37.55	60.00	-22.45	QP	
12	5.9739	24.39	9.76	34.15	50.00	-15.85	AVG	

\*:Maximum data    x:Over limit    !:over margin

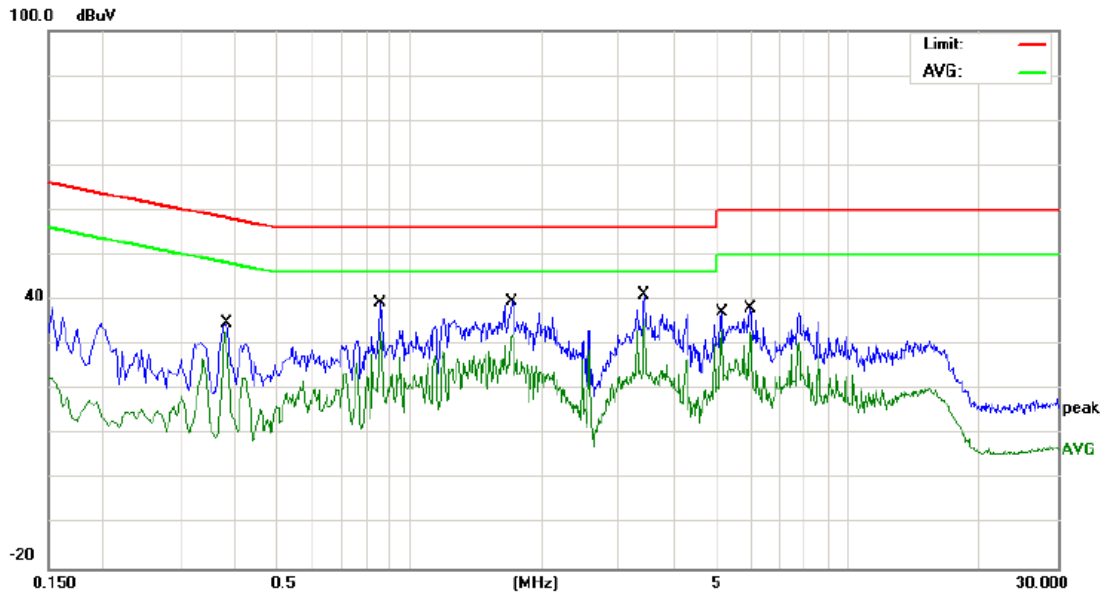

Site: Phase: N Temperature: 22  
 Limit: FCC Part 15B (0.15-30MHz) Main QP Power: AC 120V/60Hz Humidity: 51 %  
 Mode: Mode 1  
 Note:

No.	Mk.	Freq. MHz	Reading Level dBuV	Correct Factor dB	Measure- ment dBuV	Limit dBuV	Over dB	Detector	Comment
1		0.3780	24.64	10.07	34.71	58.32	-23.61	QP	
2		0.3780	22.67	10.07	32.74	48.32	-15.58	AVG	
3		0.8579	29.44	9.84	39.28	56.00	-16.72	QP	
4		0.8579	22.76	9.84	32.60	46.00	-13.40	AVG	
5		1.7099	29.70	9.78	39.48	56.00	-16.52	QP	
6		1.7099	22.40	9.78	32.18	46.00	-13.82	AVG	
7		3.4180	31.22	9.73	40.95	56.00	-15.05	QP	
8	*	3.4180	26.03	9.73	35.76	46.00	-10.24	AVG	
9		5.1418	27.49	9.73	37.22	60.00	-22.78	QP	
10		5.1418	23.40	9.73	33.13	50.00	-16.87	AVG	
11		5.9778	28.29	9.73	38.02	60.00	-21.98	QP	
12		5.9778	22.82	9.73	32.55	50.00	-17.45	AVG	

\*:Maximum data    x:Over limit    !:over margin

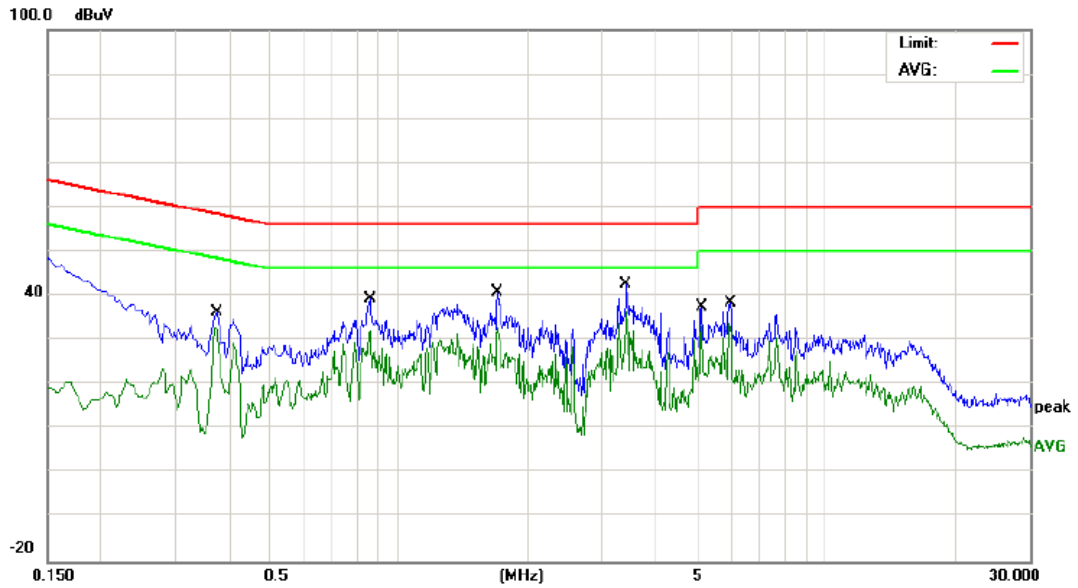

Site: \_\_\_\_\_ Phase: **L1** Temperature: 22  
 Limit: FCC Part 15B\_(0.15-30MHz) \_Main\_QP Power: AC 240V/50Hz Humidity: 51 %  
 Mode: Mode 1  
 Note:

No. Mk.	Freq. MHz	Reading Level dBuV	Correct Factor dB	Measurement dBuV	Limit dBuV	Over dB	Detector	Comment
1	0.3699	26.30	10.07	36.37	58.50	-22.13	QP	
2	0.3699	22.68	10.07	32.75	48.50	-15.75	AVG	
3	0.8539	29.42	9.82	39.24	56.00	-16.76	QP	
4	0.8539	22.15	9.82	31.97	46.00	-14.03	AVG	
5	1.7019	31.11	9.77	40.88	56.00	-15.12	QP	
6	1.7019	22.89	9.77	32.66	46.00	-13.34	AVG	
7	3.4100	32.86	9.74	42.60	56.00	-13.40	QP	
8 *	3.4100	26.41	9.74	36.15	46.00	-9.85	AVG	
9	5.1178	27.60	9.76	37.36	60.00	-22.64	QP	
10	5.1178	23.38	9.76	33.14	50.00	-16.86	AVG	
11	5.9499	28.66	9.76	38.42	60.00	-21.58	QP	
12	5.9499	24.16	9.76	33.92	50.00	-16.08	AVG	

\*:Maximum data x:Over limit !:over margin

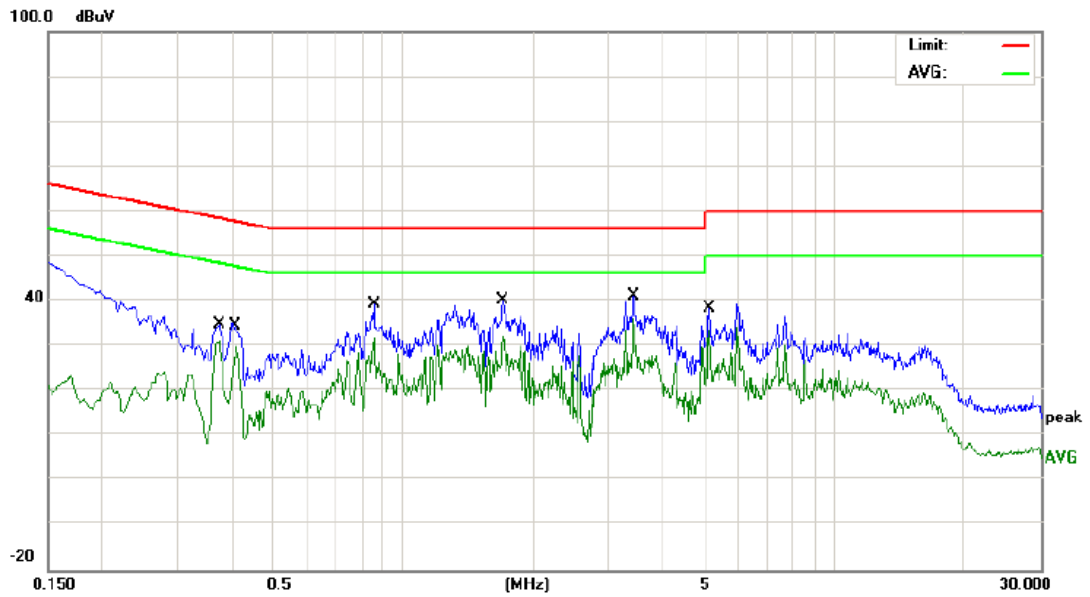

Site: \_\_\_\_\_ Phase: **N** Temperature: 22  
 Limit: FCC Part 15B (0.15-30MHz) Main QP Power: AC 240V/50Hz Humidity: 51 %  
 Mode: Mode 1  
 Note:

No. Mk.	Freq. MHz	Reading Level dBuV	Correct Factor dB	Measurement dBuV	Limit dBuV	Over dB	Detector	Comment
1	0.3738	24.56	10.07	34.63	58.41	-23.78	QP	
2	0.3738	21.10	10.07	31.17	48.41	-17.24	AVG	
3	0.4099	25.16	10.03	35.19	57.65	-22.46	QP	
4	0.4099	19.81	10.03	29.84	47.65	-17.81	AVG	
5	0.8539	29.28	9.84	39.12	56.00	-16.88	QP	
6	0.8539	21.91	9.84	31.75	46.00	-14.25	AVG	
7	1.7019	30.29	9.79	40.08	56.00	-15.92	QP	
8	1.7019	22.39	9.79	32.18	46.00	-13.82	AVG	
9	3.4140	31.21	9.73	40.94	56.00	-15.06	QP	
10 *	3.4140	26.13	9.73	35.86	46.00	-10.14	AVG	
11	5.1219	28.72	9.73	38.45	60.00	-21.55	QP	
12	5.1219	23.74	9.73	33.47	50.00	-16.53	AVG	

\*:Maximum data x:Over limit l:over margin



## 7.2 RADIATED SPURIOUS EMISSION

### 7.2.1 Applicable Standard

According to FCC Part 15.247(d) and 15.209 and DA 00-705

### 7.2.2 Conformance Limit

According to FCC Part 15.247(d): radiated emissions which fall in the restricted bands, as defined in §15.205(a), must also comply with the radiated emission limits specified in §15.209(a) (see §15.205(c)).

According to FCC Part 15.205, Restricted bands

MHz	MHz	MHz	GHz
0.090-0.110	16.42-16.423	399.9-410	4.5-5.15
10.495-0.505	16.69475-16.69525	608-614	5.35-5.46
2.1735-2.1905	16.80425-16.80475	960-1240	7.25-7.75
4.125-4.128	25.5-25.67	1300-1427	8.025-8.5
4.17725-4.17775	37.5-38.25	1435-1626.5	9.0-9.2
4.20725-4.20775	73-74.6	1645.5-1646.5	9.3-9.5
6.215-6.218	74.8-75.2	1660-1710	10.6-12.7
6.26775-6.26825	123-138	2200-2300	14.47-14.5
8.291-8.294	149.9-150.05	2310-2390	15.35-16.2
8.362-8.366	156.52475-156.52525	2483.5-2500	17.7-21.4
8.37625-8.38675	156.7-156.9	2690-2900	22.01-23.12
8.41425-8.41475	162.0125-167.17	3260-3267	23.6-24.0
12.29-12.293	167.72-173.2	3332-3339	31.2-31.8
12.51975-12.52025	240-285	3345.8-3358	36.43-36.5
12.57675-12.57725	322-335.4	3600-4400	(2)
13.36-13.41			

20dBc in any 100 kHz bandwidth outside the operating frequency band. In case the emission fall within the restricted band specified on 15.205(a), then the 15.209(a) limit in the table below has to be followed.

Restricted Frequency(MHz)	Field Strength (µV/m)	Field Strength (dBµV/m)	Measurement Distance
0.009~0.490	2400/F(KHz)	20 log (uV/m)	300
0.490~1.705	2400/F(KHz)	20 log (uV/m)	30
1.705~30.0	30	29.5	30
30-88	100	40	3
88-216	150	43.5	3
216-960	200	46	3
Above 960	500	54	3

Limits of Radiated Emission Measurement(Above 1000MHz)

Frequency(MHz)	Class B (dBuV/m) (at 3M)	
	PEAK	AVERAGE
Above 1000	74	54

Remark :1. Emission level in dBuV/m=20 log (uV/m)

2. Measurement was performed at an antenna to the closed point of EUT distance of meters.

3. Distance extrapolation factor =40log(Specific distance/ test distance)( dB);  
Limit line=Specific limits(dBuV) + distance extrapolation factor.

### 7.2.3 Measuring Instruments

The Measuring equipment is listed in the section 6.3 of this test report.

### 7.2.4 Test Configuration

(a) For radiated emissions below 30MHz

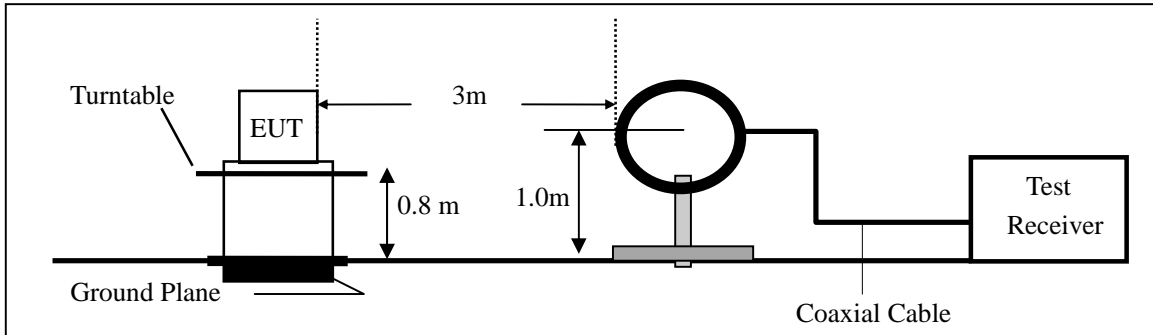

(b) For radiated emissions from 30MHz to 1000MHz

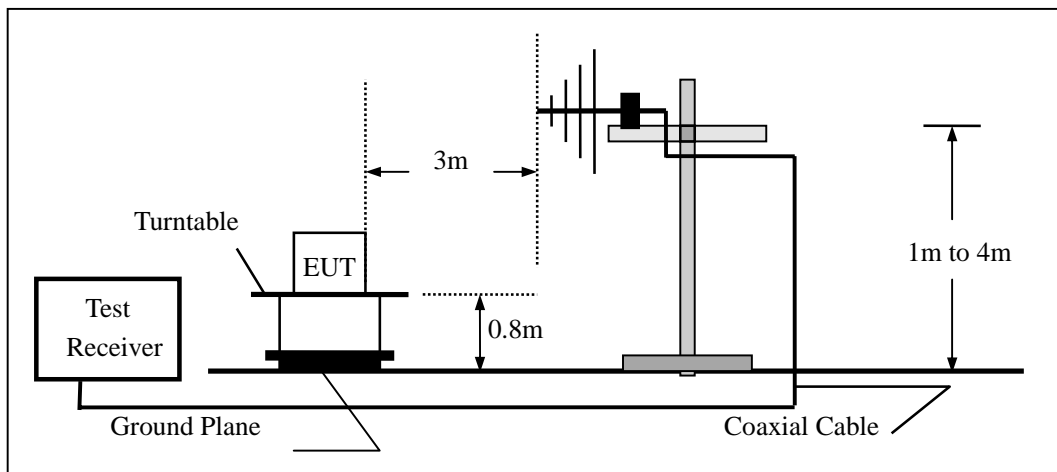

(c) For radiated emissions above 1000MHz

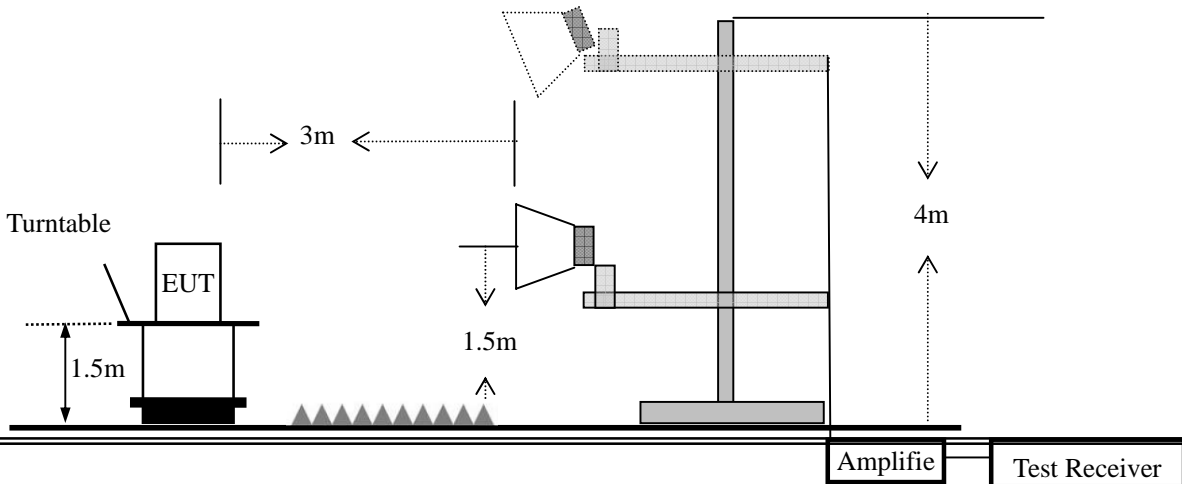

**7.2.5 Test Procedure**

The test site semi-anechoic chamber has met the requirement of NSA tolerance 4 dB according to the standards: ANSI C63.10-2013. The test distance is 3m. The setup is according to the requirements in Section 13.1.4.1 of ANSI C63.10-2013 and CAN/CSA-CEI/IEC CISPR 22.

This test is required for any spurious emission that falls in a Restricted Band, as defined in Section 15.205. It must be performed with the highest gain of each type of antenna proposed for use with the EUT.

Use the following spectrum analyzer settings:

Spectrum Parameter	Setting
Attenuation	Auto
Start Frequency	1000 MHz
Stop Frequency	10th carrier harmonic
RB / VB (emission in restricted band)	1 MHz / 1 MHz for Peak, 1 MHz / 10Hz for Average

Receiver Parameter	Setting
Attenuation	Auto
Start ~ Stop Frequency	9kHz~150kHz / RB 200Hz for QP
Start ~ Stop Frequency	150kHz~30MHz / RB 9kHz for QP
Start ~ Stop Frequency	30MHz~1000MHz / RB 120kHz for QP

- The measuring distance of at 3 m shall be used for measurements at frequency up to 1GHz. For frequencies above 1GHz, any suitable measuring distance may be used.
- The EUT was placed on the top of a rotating table 0.8 m for below 1GHz and 1.5m for above 1GHz the ground at a 3 meter. The table was rotated 360 degrees to determine the position of the highest radiation.
- The height of the equipment or of the substitution antenna shall be 0.8 m for below 1GHz and 1.5m for above 1GHz; the height of the test antenna shall vary between 1 m to 4 m. Both horizontal and vertical polarizations of the antenna are set to make the measurement.
- The initial step in collecting conducted emission data is a spectrum analyzer peak detector mode pre-scanning the measurement frequency range. Significant peaks are then marked and then Quasi Peak detector mode re-measured.
- If the Peak Mode measured value compliance with and lower than Quasi Peak Mode Limit, the EUT shall be deemed to meet QP Limits and then no additional QP Mode measurement performed.
- For the actual test configuration, please refer to the related Item –EUT Test Photos.

Note:

Both horizontal and vertical antenna polarities were tested and performed pretest to three orthogonal axis. The worst case emissions were reported

During the radiated emission test, the Spectrum Analyzer was set with the following configurations:

Frequency Band (MHz)	Function	Resolution bandwidth	Video Bandwidth
30 to 1000	QP	120 kHz	300 kHz
Above 1000	Peak	1 MHz	1 MHz
	Average	1 MHz	10 Hz

Note: for the frequency ranges below 30 MHz, a narrower RBW is used for these ranges but the measured value should add a RBW correction factor (RBWCF) where  $RBWCF [dB] = 10 \cdot \lg(100 [kHz] / \text{narrower RBW} [kHz])$ . , the narrower RBW is 1 kHz and RBWCF is 20 dB for the frequency 9 kHz to 150 kHz, and the narrower RBW is 10 kHz and RBWCF is 10 dB for the frequency 150 kHz to 30 MHz.

**7.2.6 Test Results**

■ Spurious Emission below 30MHz (9KHz to 30MHz)

EUT:	Avantree Apico	Model No.:	BTHS-AH8-BLK
Temperature:	20 °C	Relative Humidity:	48%
Test Mode:	Mode1/Mode2/Mode3	Test By:	Eileen Liu

Freq. (MHz)	Ant.Pol. H/V	Emission Level(dBuV/m)		Limit 3m(dBuV/m)		Over(dB)	
		PK	AV	PK	AV	PK	AV
--	--	--	--	--	--	--	--

Note: the amplitude of spurious emission that is attenuated by more than 20dB below the permissible limit has no need to be reported.

Distance extrapolation factor = $20\log(\text{Specific distance/ test distance})$ ( dB);

Limit line=Specific limits(dBuV) + distance extrapolation factor

- Spurious Emission below 1GHz (30MHz to 1GHz)  
All the modulation modes have been tested, and the worst result was report as below:

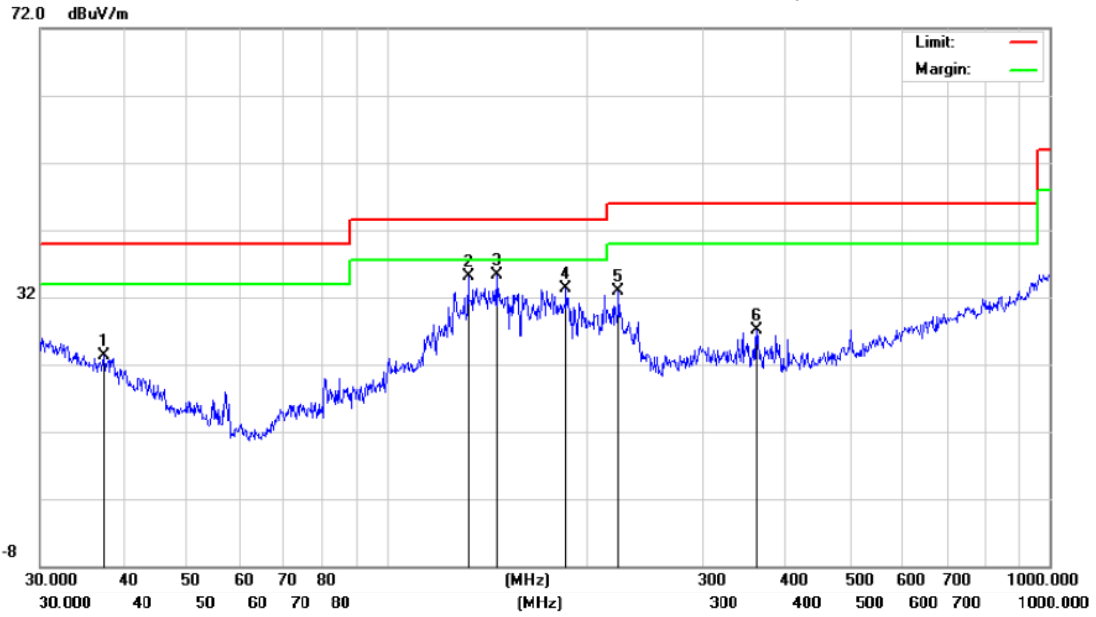

Site NTEK 9\*6\*6 Chamber #1      Polarization: *Vertical*      Temperature: 24  
 Limit: FCC\_PART15\_B\_03m\_QP      Power: AC 120V/60Hz      Humidity: 50 %  
 Mode: BT LINK MODE  
 Note:

No. Mk.	Freq. MHz	Reading Level dBuV	Correct Factor dB	Measurement dBuV/m	Limit dBuV/m	Over dB	Antenna Height cm	Table Degree	Detector	Comment
1	31.6202	7.95	19.66	27.61	40.00	-12.39			QP	
2	119.8555	17.56	11.60	29.16	43.50	-14.34			QP	
3 *	204.9550	20.75	12.85	33.60	43.50	-9.90			QP	
4	359.1859	17.19	15.62	32.81	46.00	-13.19			QP	
5	504.7062	16.73	18.67	35.40	46.00	-10.60			QP	
6	810.2653	11.19	24.15	35.34	46.00	-10.66			QP	

\*:Maximum data    x:Over limit    !:over margin

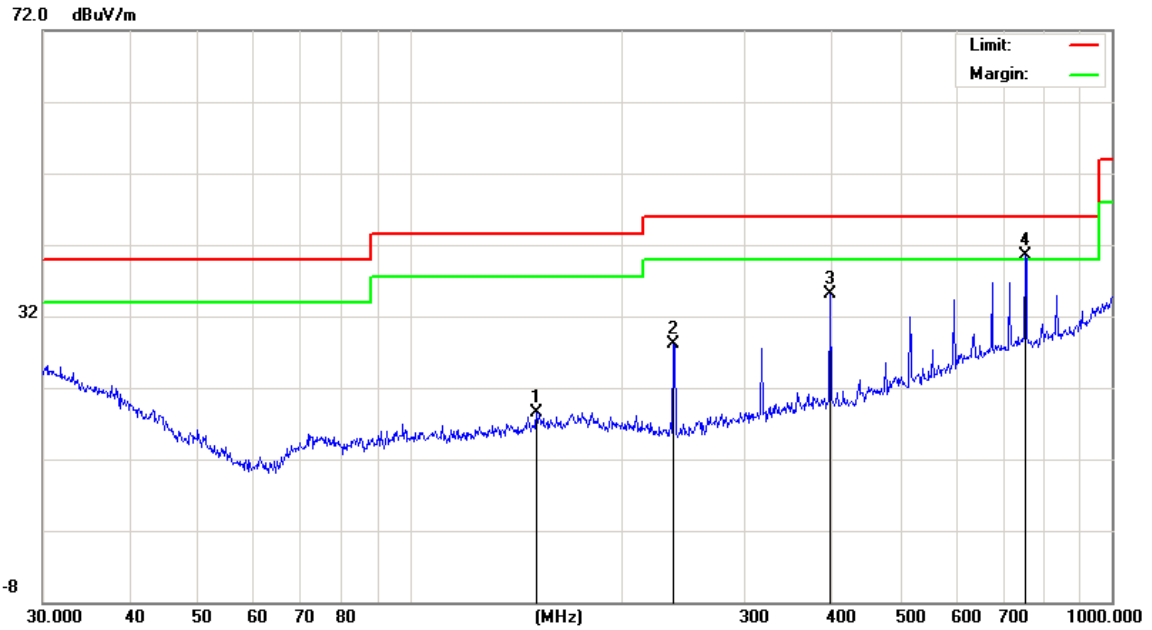

Site NTEK 9\*6\*6 Chamber #1  
 Limit: FCC\_PART15\_B\_03m\_QP

Polarization: *Horizontal*  
 Power: AC 120V/60Hz

Temperature: 24  
 Humidity: 50 %

Mode: BT LINK MODE

Note:

No.	Mk.	Freq. MHz	Reading Level dBuV	Correct Factor dB	Measure- ment dBuV/m	Limit dBuV/m	Over dB	Antenna Height cm	Table Degree degree	Comment
1		191.7450	22.72	12.61	35.33	43.50	-8.17	QP		
2	*	204.9550	27.55	12.85	40.40	43.50	-3.10	QP		
3	!	214.5142	25.61	12.31	37.92	43.50	-5.58	QP		
4		312.1792	19.91	14.31	34.22	46.00	-11.78	QP		
5		360.4476	19.69	15.65	35.34	46.00	-10.66	QP		
6		455.9057	20.25	17.44	37.69	46.00	-8.31	QP		

\*:Maximum data    x:Over limit    !:over margin

■ Spurious Emission Above 1GHz (1GHz to 25GHz)

EUT:	Avantree Apico	Model No.:	BTHS-AH8-BLK
Temperature:	20 °C	Relative Humidity:	48%
Test Mode:	Mode1/Mode2/Mode3/Mode4	Test By:	Eileen Liu

All the modulation modes have been tested, and the worst result was report as below:

Frequency (MHz)	Meter Reading (dBμV)	Factor (dB)	Emission Level (dBμV/m)	Limits (dBμV/m)	Margin (dB)	Remark	Comment
Low Channel (2402 MHz)-Above 1G							
4804.198	60.13	-3.64	56.49	74.00	-17.51	Pk	Vertical
4804.198	42.25	-3.64	38.61	54.00	-15.39	AV	Vertical
7206.269	60.47	-0.95	59.52	74.00	-14.48	Pk	Vertical
7206.269	42.51	-0.95	41.56	54.00	-12.44	AV	Vertical
4804.417	60.29	-3.64	56.65	74.00	-17.35	Pk	Horizontal
4804.417	43.35	-3.64	39.71	54.00	-14.29	AV	Horizontal
7206.326	60.68	-0.95	59.73	74.00	-14.27	Pk	Horizontal
7206.326	42.64	-0.95	41.69	54.00	-12.31	AV	Horizontal
Mid Channel (2441 MHz)-Above 1G							
4882.191	58.97	-3.68	55.29	74.00	-18.71	Pk	Vertical
4882.191	45.61	-3.68	41.93	54.00	-12.07	AV	Vertical
7323.429	59.85	-0.82	59.03	74.00	-14.97	Pk	Vertical
7323.429	43.63	-0.82	42.81	54.00	-11.19	AV	Vertical
4882.142	59.76	-3.68	56.08	74.00	-17.92	Pk	Horizontal
4882.142	42.14	-3.68	38.46	54.00	-15.54	AV	Horizontal
7323.783	61.18	-0.82	60.36	74.00	-13.64	Pk	Horizontal
7323.783	42.26	-0.82	41.44	54.00	-12.56	AV	Horizontal
High Channel (2480 MHz)- Above 1G							
4960.122	57.87	-3.59	54.28	74.00	-19.72	Pk	Vertical
4960.122	42.16	-3.59	38.57	54.00	-15.43	AV	Vertical
7440.145	58.96	-0.68	58.28	74.00	-15.72	Pk	Vertical
7440.145	42.32	-0.68	41.64	54.00	-12.36	AV	Vertical
4960.348	59.93	-3.59	56.34	74.00	-17.66	Pk	Horizontal
4960.348	42.14	-3.59	38.55	54.00	-15.45	AV	Horizontal
7440.427	58.75	-0.68	58.07	74.00	-15.93	Pk	Horizontal
7440.427	41.61	-0.68	40.93	54.00	-13.07	AV	Horizontal

Note: (1) All Readings are Peak Value (VBW=3MHz) and Peak Value (VBW=10Hz).  
 (2) Emission Level= Reading Level+Probe Factor +Cable Loss.  
 (3)All other emissions more than 20dB below the limit.

■ Spurious Emission in Restricted Band 2310-2390MHz and 2483.5-2500MHz

EUT:	Avantree Apico	Model No.:	BTHS-AH8-BLK
Temperature:	20 °C	Relative Humidity:	48%
Test Mode:	Mode1/Mode2/Mode3/Mode4	Test By:	Eileen Liu

All the modulation modes have been tested, and the worst result was report as below:

Frequency (MHz)	Meter Reading (dBμV)	Factor (dB)	Emission Level (dBμV/m)	Limits (dBμV/m)	Margin (dB)	Detector Type	Comment
1Mbps Non-hopping							
2390	57.27	-13.06	44.21	74	-29.79	Pk	Vertical
2390	50.32	-13.06	37.26	54	-16.74	AV	Vertical
2390	58.43	-13.06	45.37	74	-28.63	Pk	Horizontal
2390	51.36	-13.06	38.3	54	-15.7	AV	Horizontal
2483.5	61.87	-12.78	49.09	74	-24.91	Pk	Vertical
2483.5	50.42	-12.78	37.64	54	-16.36	AV	Vertical
2483.5	60.37	-12.78	47.59	74	-26.41	Pk	Horizontal
2483.5	50.45	-12.78	37.67	54	-16.33	AV	Horizontal
1Mbps hopping							
2390	59.67	-13.06	46.61	74	-27.39	Pk	Vertical
2390	50.25	-13.06	37.19	54	-16.81	AV	Vertical
2390	56.22	-13.06	43.16	74	-30.84	Pk	Horizontal
2390	50.72	-13.06	37.66	54	-16.34	AV	Horizontal
2483.5	58.63	-12.78	45.85	74	-28.15	Pk	Vertical
2483.5	50.82	-12.78	38.04	54	-15.96	AV	Vertical
2483.5	59.17	-12.78	46.39	74	-27.61	Pk	Horizontal
2483.5	50.38	-12.78	37.6	54	-16.4	AV	Horizontal

Note: (1) All other emissions more than 20dB below the limit.



EUT:	Avantree Apico	Model No.:	BTHS-AH8-BLK
Temperature:	20 °C	Relative Humidity:	48%
Test Mode:	Mode1/Mode2/Mode3/Mode4	Test By:	Eileen Liu

All the modulation modes have been tested, and the worst result was report as below:

Frequency (MHz)	Meter Reading (dBµV)	Factor (dB)	Emission Level (dBµV/m)	Limits (dBµV/m)	Margin (dB)	Detector Type	Comment
2Mbps Non-hopping							
2390	61.49	-13.06	48.43	74	-25.57	Pk	Vertical
2390	50.31	-13.06	37.25	54	-16.75	AV	Vertical
2390	62.37	-13.06	49.31	74	-24.69	Pk	Horizontal
2390	49.54	-13.06	36.48	54	-17.52	AV	Horizontal
2483.5	60.37	-12.78	47.59	74	-26.41	Pk	Vertical
2483.5	51.39	-12.78	38.61	54	-15.39	AV	Vertical
2483.5	60.17	-12.78	47.39	74	-26.61	Pk	Horizontal
2483.5	50.11	-12.78	37.33	54	-16.67	AV	Horizontal
2Mbps hopping							
2390	61.31	-13.06	48.25	74	-25.75	Pk	Vertical
2390	50.36	-13.06	37.3	54	-16.7	AV	Vertical
2390	62.18	-13.06	49.12	74	-24.88	Pk	Horizontal
2390	51.68	-13.06	38.62	54	-15.38	AV	Horizontal
2483.5	60.29	-12.78	47.51	74	-26.49	Pk	Vertical
2483.5	51.34	-12.78	38.56	54	-15.44	AV	Vertical
2483.5	58.64	-12.78	45.86	74	-28.14	Pk	Horizontal
2483.5	53.69	-12.78	40.91	54	-13.09	AV	Horizontal

Note: (1) All other emissions more than 20dB below the limit.

EUT:	Avantree Apico	Model No.:	BTHS-AH8-BLK
Temperature:	20 °C	Relative Humidity:	48%
Test Mode:	Mode1/Mode2/Mode3/Mode4	Test By:	Eileen Liu

All the modulation modes have been tested, and the worst result was report as below:

Frequency (MHz)	Meter Reading (dBµV)	Factor (dB)	Emission Level (dBµV/m)	Limits (dBµV/m)	Margin (dB)	Detector Type	Comment
3Mbps Non-hopping							
2390	68.02	-13.06	54.96	74	-19.04	Pk	Vertical
2390	57.33	-13.06	44.27	54	-9.73	AV	Vertical
2390	63.45	-13.06	50.39	74	-23.61	Pk	Horizontal
2390	54.02	-13.06	40.96	54	-13.04	AV	Horizontal
2483.5	69.11	-12.78	56.33	74	-17.67	Pk	Vertical
2483.5	50.32	-12.78	37.54	54	-16.46	AV	Vertical
2483.5	65.03	-12.78	52.25	74	-21.75	Pk	Horizontal
2483.5	52.41	-12.78	39.63	54	-14.37	AV	Horizontal
3Mbps hopping							
2390	62.44	-13.06	49.38	74	-24.62	Pk	Vertical
2390	53.69	-13.06	40.63	54	-13.37	AV	Vertical
2390	62.47	-13.06	49.41	74	-24.59	Pk	Horizontal
2390	55.02	-13.06	41.96	54	-12.04	AV	Horizontal
2483.5	61.69	-12.78	48.91	74	-25.09	Pk	Vertical
2483.5	57.44	-12.78	44.66	54	-9.34	AV	Vertical
2483.5	65.69	-12.78	52.91	74	-21.09	Pk	Horizontal
2483.5	55.85	-12.78	43.07	54	-10.93	AV	Horizontal

Note: (1) All other emissions more than 20dB below the limit.

■ Spurious Emission in Restricted Band 3260MMHz-18000MHz

EUT:	Avantree Apico	Model No.:	BTHS-AH8-BLK
Temperature:	20 °C	Relative Humidity:	48%
Test Mode:	Mode1/Mode2/Mode3/Mode4	Test By:	Eileen Liu

All the modulation modes have been tested, and the worst result was report as below:

Frequency (MHz)	Meter Reading (dBµV)	Factor (dB)	Emission Level (dBµV/m)	Limits (dBµV/m)	Margin (dB)	Detector Type	Comment
1Mbps Non-hopping							
3315	59.46	-13.06	46.4	74	-27.6	Pk	Vertical
3315	50.24	-13.06	37.18	54	-16.82	AV	Vertical
3315	58.52	-13.06	45.46	74	-28.54	Pk	Horizontal
3315	50.26	-13.06	37.2	54	-16.8	AV	Horizontal
3428	61.57	-12.78	48.79	74	-25.21	Pk	Vertical
3428	50.47	-12.78	37.69	54	-16.31	AV	Vertical
3428	60.31	-12.78	47.53	74	-26.47	Pk	Horizontal
3428	50.46	-12.78	37.68	54	-16.32	AV	Horizontal
17245	63.24	-12.24	51	74	-23	Pk	Vertical
17245	53.43	-12.24	41.19	54	-12.81	AV	Vertical
17245	64.37	-12.24	52.13	74	-21.87	Pk	Horizontal
17245	54.52	-12.24	42.28	54	-11.72	AV	Horizontal
1Mbps hopping							
3315	57.05	-13.06	43.99	74	-30.01	Pk	Vertical
3315	48.36	-13.06	35.3	54	-18.7	AV	Vertical
3315	54.52	-13.06	41.46	74	-32.54	Pk	Horizontal
3315	48.17	-13.06	35.11	54	-18.89	AV	Horizontal
3428	58.12	-12.78	45.34	74	-28.66	Pk	Vertical
3428	48.28	-12.78	35.5	54	-18.5	AV	Vertical
3428	62.41	-12.78	49.63	74	-24.37	Pk	Horizontal
3428	50.35	-12.78	37.57	54	-16.43	AV	Horizontal
17245	63.26	-12.24	51.02	74	-22.98	Pk	Vertical
17245	53.41	-12.24	41.17	54	-12.83	AV	Vertical
17245	64.25	-12.24	52.01	74	-21.99	Pk	Horizontal
17245	54.22	-12.24	41.98	54	-12.02	AV	Horizontal

Note: (1) All other emissions more than 20dB below the limit.

**7.3 NUMBER OF HOPPING CHANNEL**

**7.3.1 Applicable Standard**

According to FCC Part 15.247(a)(1) (iii)and DA 00-705

**7.3.2 Conformance Limit**

Frequency hopping systems in the 2400-2483.5MHz band shall use at least 15 channels.

**7.3.3 Measuring Instruments**

The Measuring equipment is listed in the section 6.3 of this test report.

**7.3.4 Test Setup**

Please refer to Section 6.1 of this test report.

**7.3.5 Test Procedure**

The testing follows ANSI C63.10-2013 clause 7.8.3  
 The RF output of EUT was connected to the spectrum analyzer by RF cable and attenuator.  
 The path loss was compensated to the results for each measurement.  
 Set to the maximum power setting and enable the EUT transmit continuously.  
 The EUT must have its hopping function enabled.  
 Use the following spectrum analyzer settings:  
 Span = the frequency band of operation  
 RBW  $\geq$  1% of the span  
 VBW  $\geq$  RBW  
 Sweep = auto  
 Detector function = peak  
 Trace = max hold

**7.3.6 Test Results**

EUT:	Avantree Apico	Model No.:	BTHS-AH8-BLK
Temperature:	20 °C	Relative Humidity:	48%
Test Mode:	Mode1/Mode2/Mode3	Test By:	Eileen Liu

Number of Hopping (Channel)	Adaptive Frequency hopping (Channel)	limit	Verdict
79	20	$\geq$ 15	Pass

Number of Hopping Channel Plot

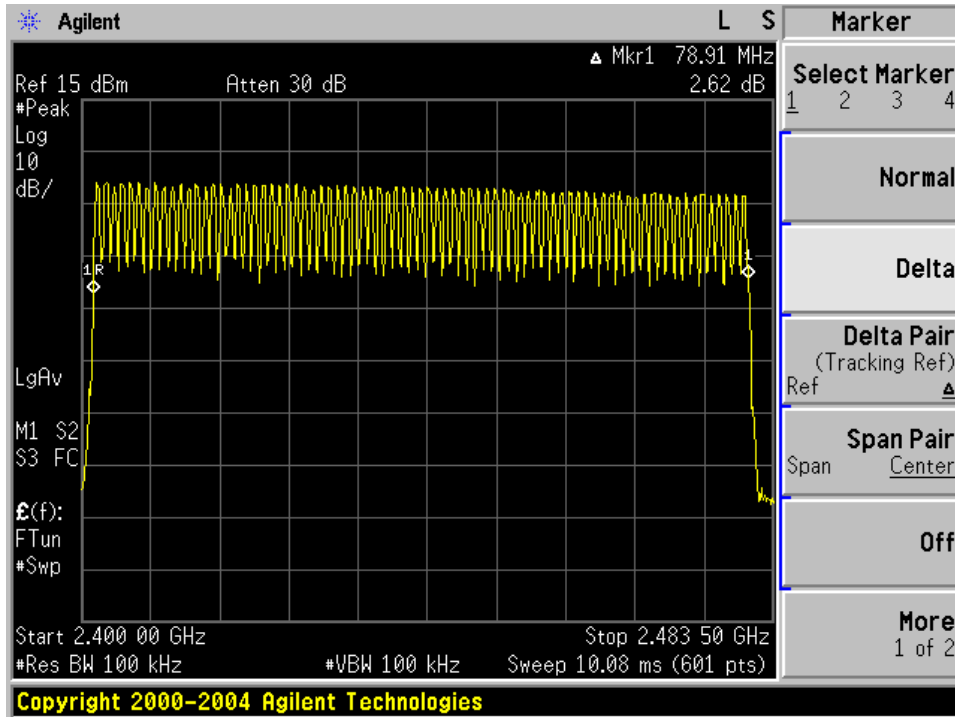

## 7.4 HOPPING CHANNEL SEPARATION MEASUREMENT

### 7.4.1 Applicable Standard

According to FCC Part 15.247(a)(1) and DA 00-705

### 7.4.2 Conformance Limit

Frequency hopping systems operating in the 2400-2483.5MHz band shall have hopping channel carrier frequencies that are separated by 25kHz or two-thirds of the 20dB bandwidth of the hopping channel, whichever is greater.

### 7.4.3 Measuring Instruments

The Measuring equipment is listed in the section 6.3 of this test report.

### 7.4.4 Test Setup

Please refer to Section 6.1 of this test report.

### 7.4.5 Test Procedure

The testing follows ANSI C63.10-2013 clause 7.8.2

The RF output of EUT was connected to the spectrum analyzer by RF cable and attenuator.

The path loss was compensated to the results for each measurement.

Set to the maximum power setting and enable the EUT transmit continuously.

The EUT was operating in controlled its channel.

Use the following spectrum analyzer settings:

Span = Measurement Bandwidth or Channel Separation

RBW  $\geq$  30KHz

VBW  $\geq$  3\*RBW

Sweep = auto

Detector function = peak

Trace = max hold

### 7.4.6 Test Results

EUT:	Avantree Apico	Model No.:	BTHS-AH8-BLK
Temperature:	20 °C	Relative Humidity:	48%
Test Mode:	Mode1/Mode2/Mode3/Mode4	Test By:	Eileen Liu

Modulation Mode	Channel Number	Channel Frequency (MHz)	Measurement Bandwidth (kHz)	Limit (kHz)		Verdict
				Limit 1	Limit 2	
GFSK	0	2402	1004	>865.551	20dB BW	PASS
	39	2441	1004	>863.212	20dB BW	PASS
	78	2480	1000	>877.879	20dB BW	PASS
$\pi/4$ -DQPSK	0	2402	1004	>836.667	2/3 of 20dB BW	PASS
	39	2441	996	>835.333	2/3 of 20dB BW	PASS
	78	2480	1000	>838.667	2/3 of 20dB BW	PASS
8DPSK	0	2402	1000	>813.333	2/3 of 20dB BW	PASS
	39	2441	1004	>815.333	2/3 of 20dB BW	PASS
	78	2480	996	>812.000	2/3 of 20dB BW	PASS

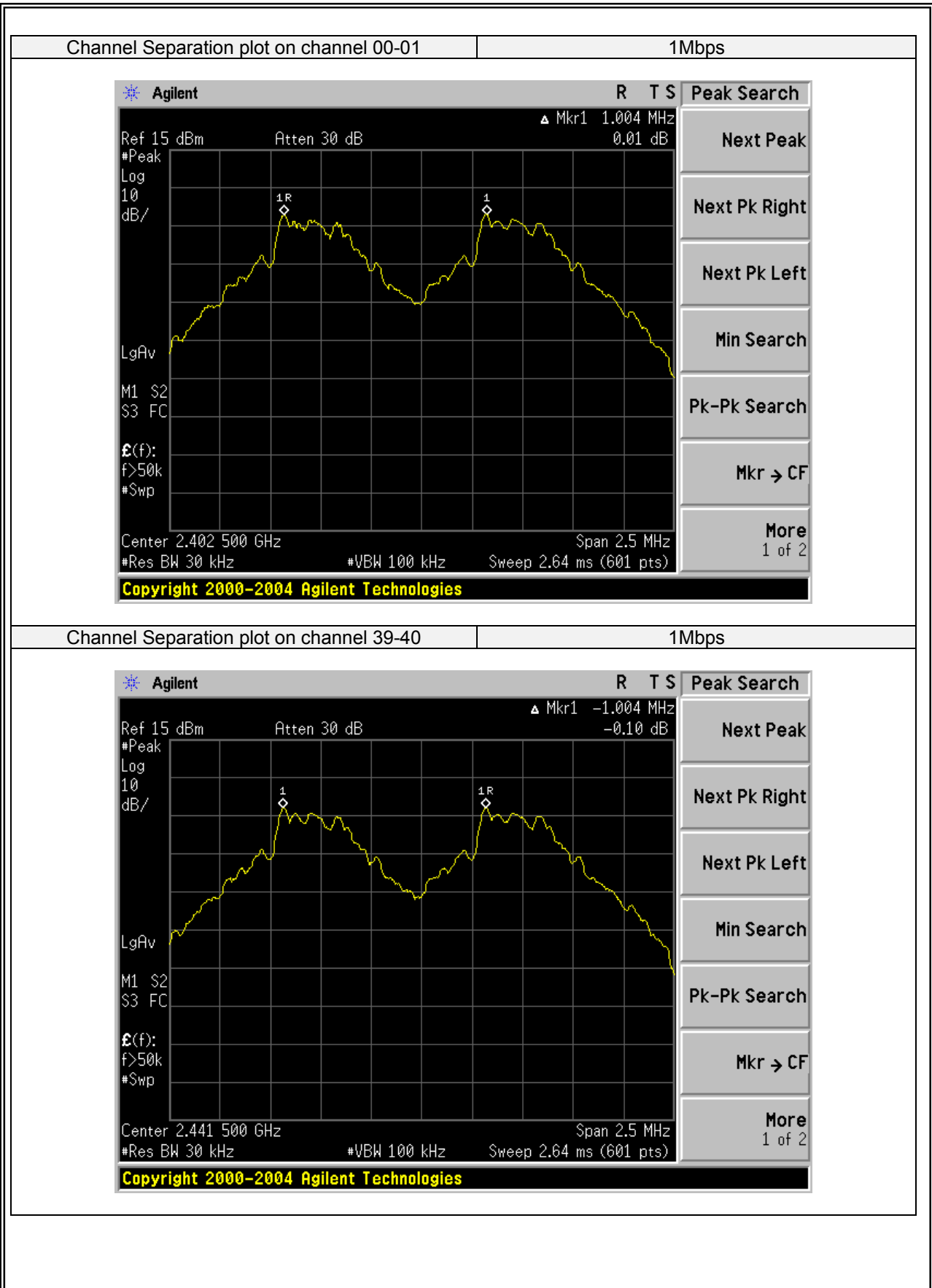

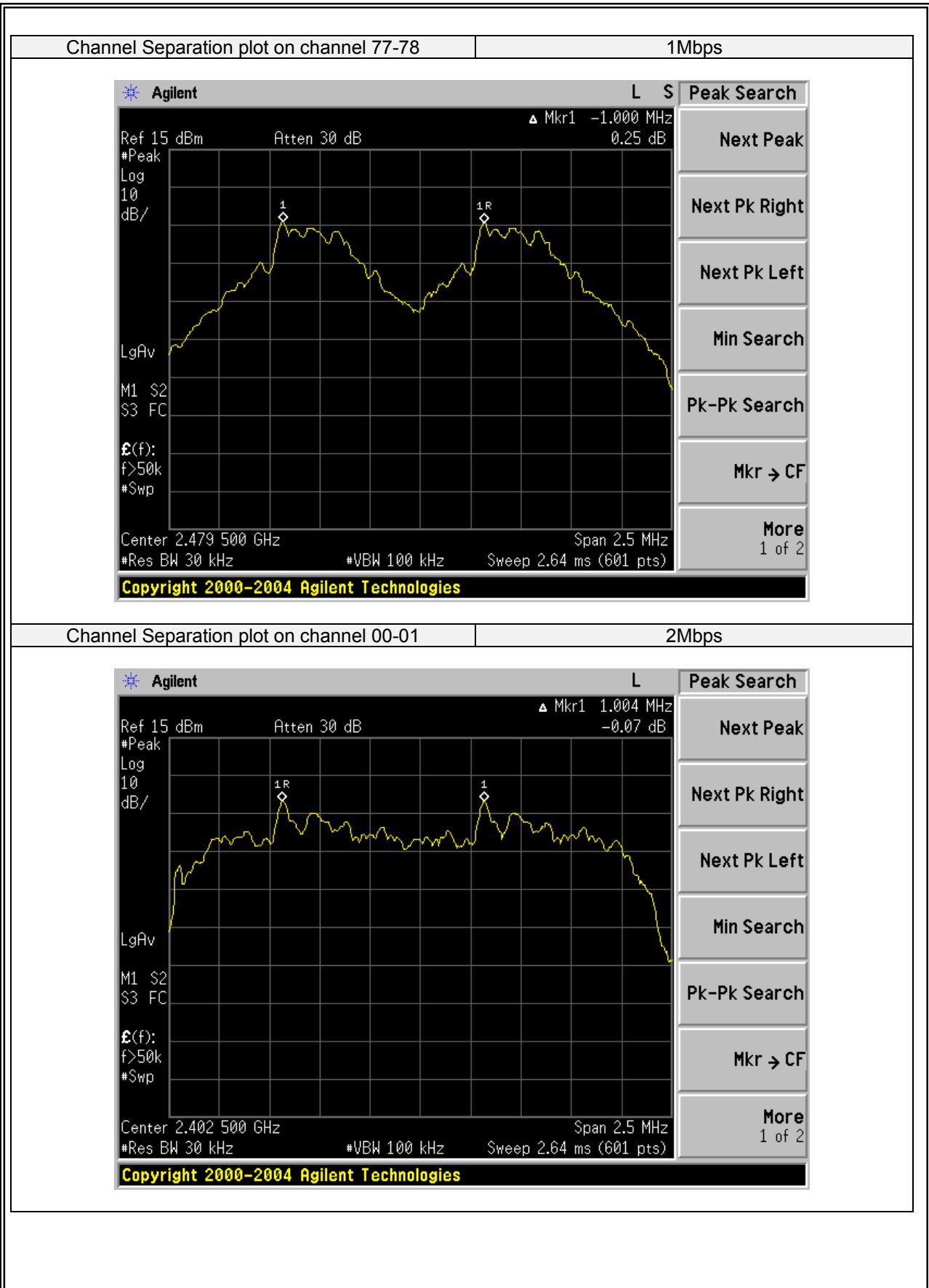



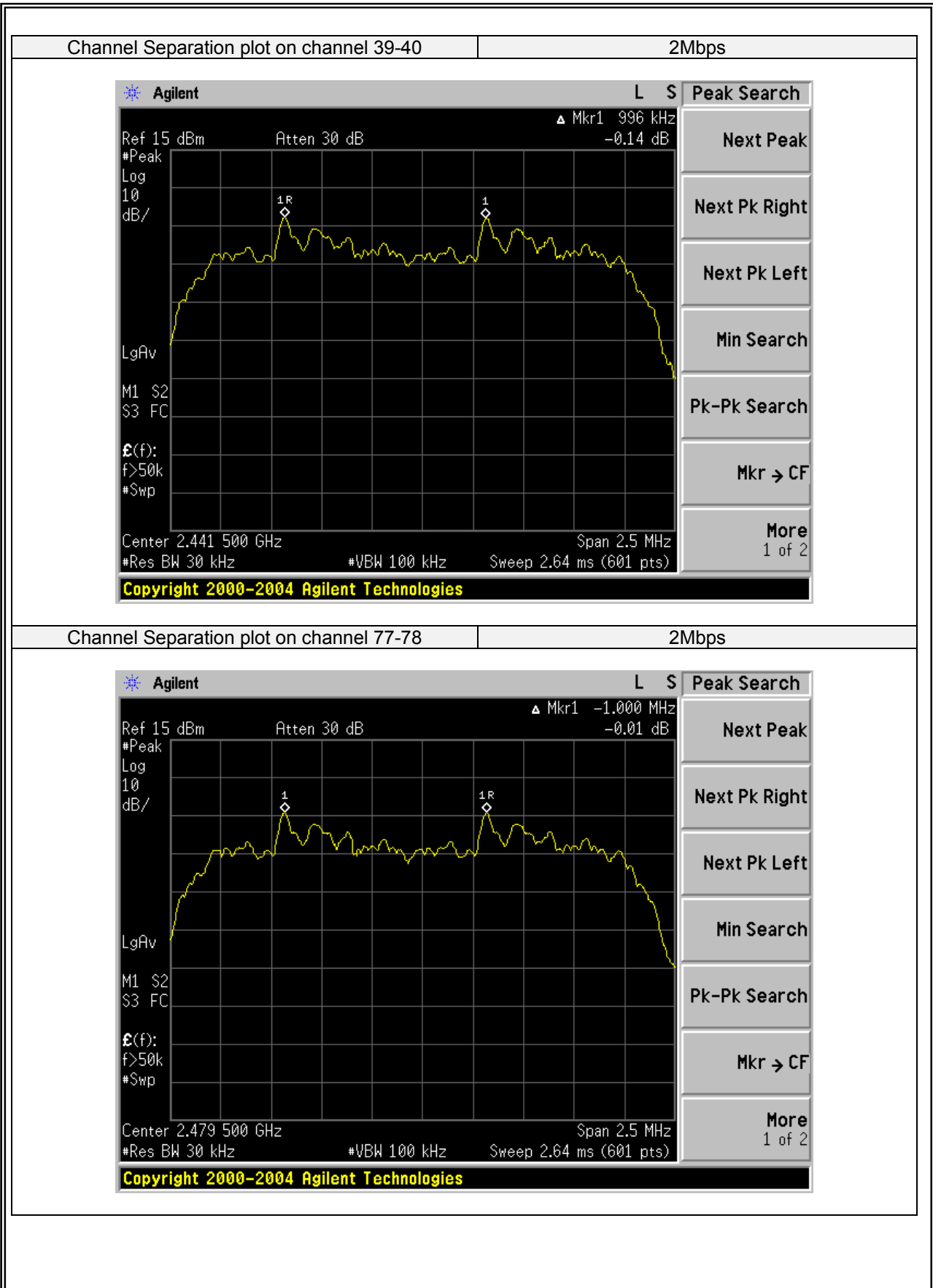

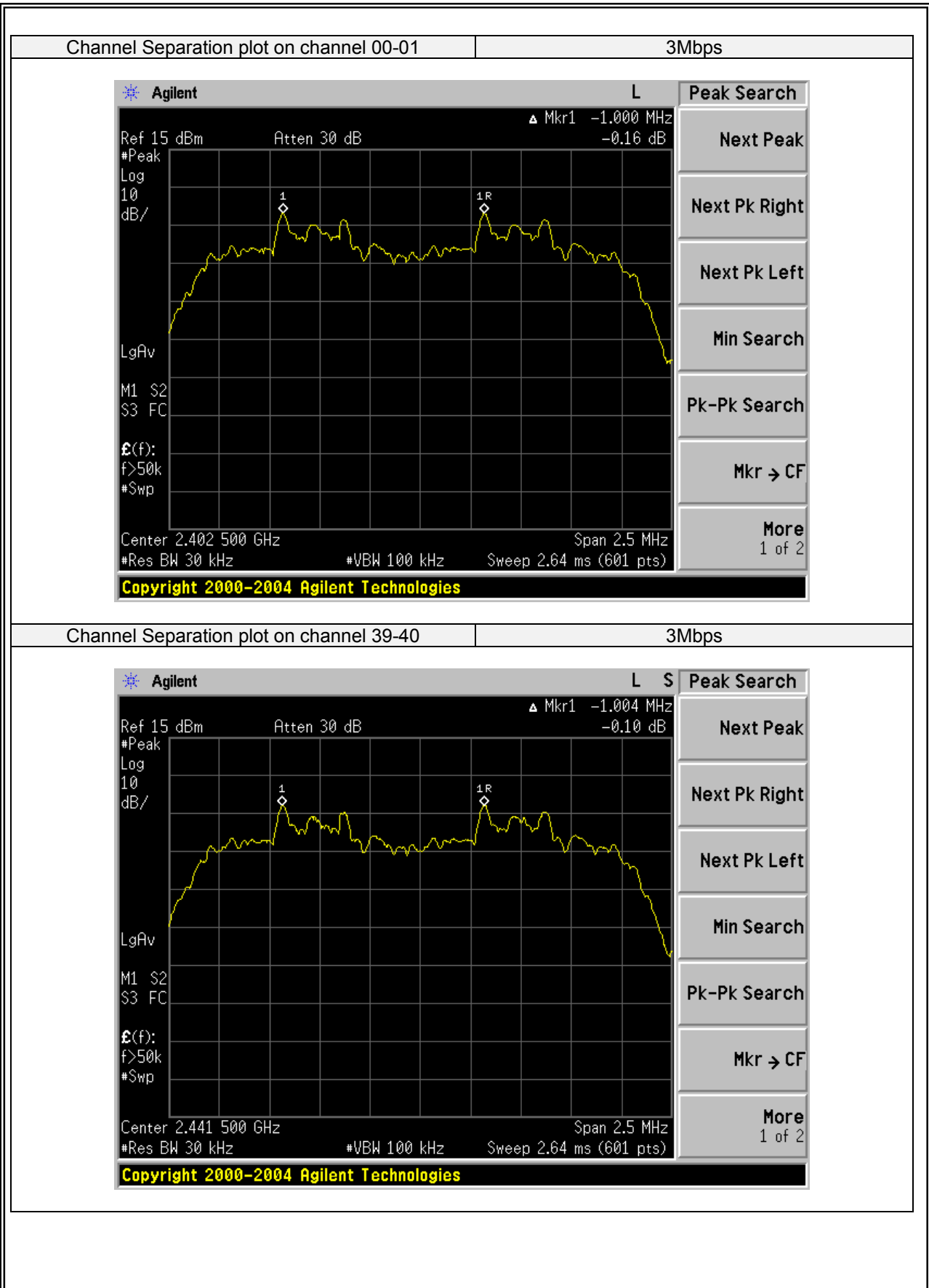

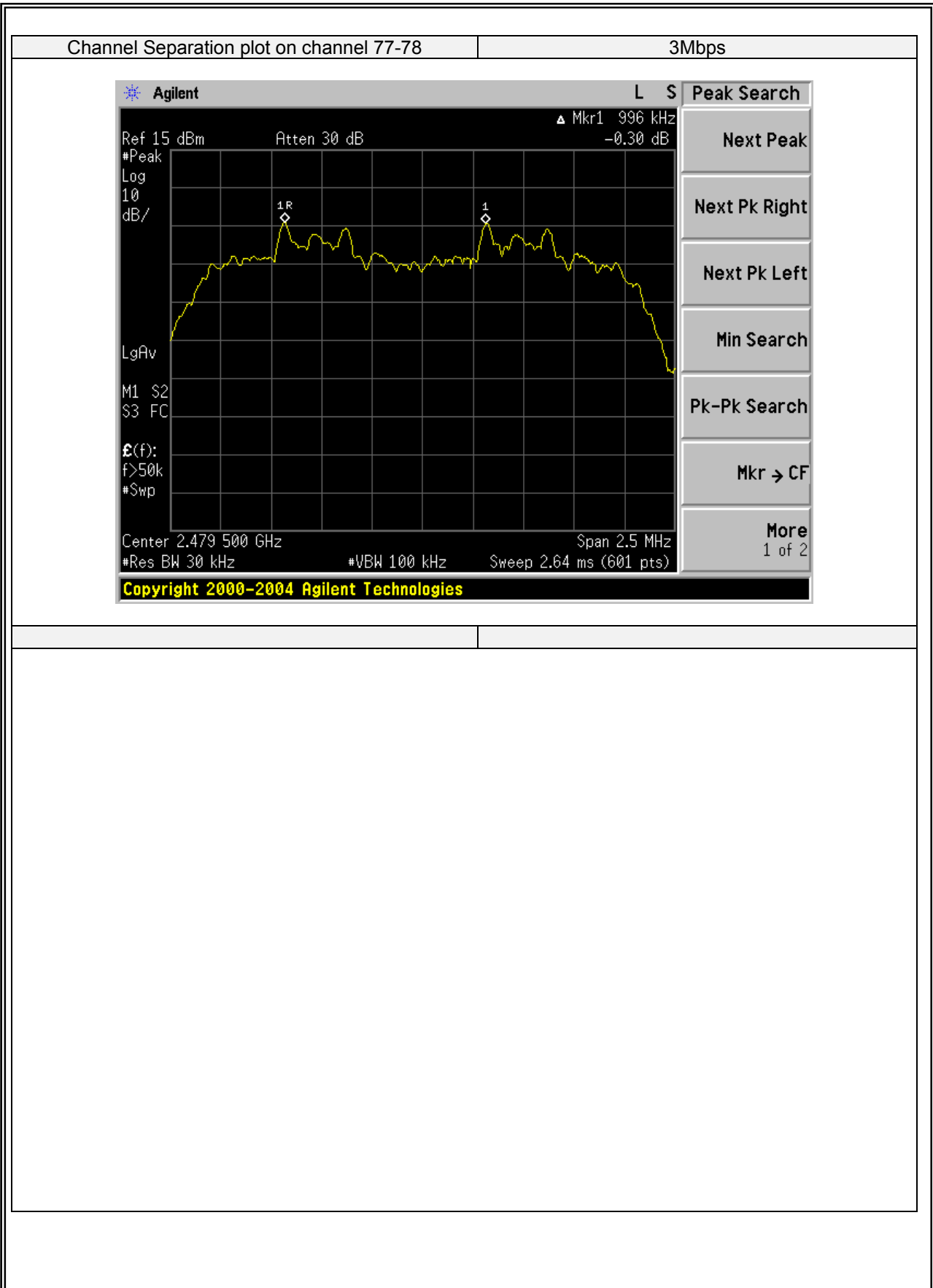

## **7.5 AVERAGE TIME OF OCCUPANCY (DWELL TIME)**

### **7.5.1 Applicable Standard**

According to FCC Part 15.247(a)(1)(iii) and DA 00-705

### **7.5.2 Conformance Limit**

The average time of occupancy on any channel shall not be greater than 0.4s within a period of 0.4s multiplied by the number of hopping channels employed.

### **7.5.3 Measuring Instruments**

The Measuring equipment is listed in the section 6.3 of this test report.

### **7.5.4 Test Setup**

Please refer to Section 6.1 of this test report.

### **7.5.5 Test Procedure**

The testing follows ANSI C63.10-2013 clause 7.8.4

The RF output of EUT was connected to the spectrum analyzer by RF cable and attenuator.

The path loss was compensated to the results for each measurement.

Set to the maximum power setting and enable the EUT transmit continuously.

The EUT must have its hopping function enabled.

Use the following spectrum analyzer settings:

Span = zero span, centered on a hopping channel

RBW  $\geq$  1MHz

VBW  $\geq$  RBW

Sweep = as necessary to capture the entire dwell time per hopping channel

Detector function = peak

Trace = max hold

Measure the maximum time duration of one single pulse.

Set the EUT for DH5, DH3 and DH1 packet transmitting.

Measure the maximum time duration of one single pulse.

**7.5.6 Test Results**

EUT:	Avantree Apico	Model No.:	BTHS-AH8-BLK
Temperature:	20 °C	Relative Humidity:	48%
Test Mode:	Mode1/Mode2/Mode3/Mode4	Test By:	Eileen Liu

Modulation Mode	Channel Number	Packet type	Mode	Hops Over Occupancy Time (ms)	Pulse width (ms)	dwll time (ms)	Limit (ms)	Verdict
GFSK	39	DH1	Normal	320.00	0.520	166.400	<400	PASS
	39		AFH	160.00	0.520	83.200	<400	PASS
	39	DH3	Normal	160.00	1.733	277.280	<400	PASS
	39		AFH	80.00	1.733	138.640	<400	PASS
	39	DH5	Normal	106.67	2.990	318.943	<400	PASS
	39		AFH	53.33	2.990	159.457	<400	PASS
π/4-DQPSK	39	2DH1	Normal	320.00	0.477	152.640	<400	PASS
	39		AFH	160.00	0.477	76.320	<400	PASS
	39	2DH3	Normal	160.00	1.712	273.920	<400	PASS
	39		AFH	80.00	1.712	136.960	<400	PASS
	39	2DH5	Normal	106.67	2.968	316.597	<400	PASS
	39		AFH	53.33	2.968	158.283	<400	PASS
8DPSK	39	3DH1	Normal	320.00	0.520	166.400	<400	PASS
	39		AFH	160.00	0.520	83.200	<400	PASS
	39	3DH3	Normal	160.00	1.733	277.280	<400	PASS
	39		AFH	80.00	1.733	138.640	<400	PASS
	39	3DH5	Normal	106.67	3.012	321.290	<400	PASS
	39		AFH	53.33	3.012	160.630	<400	PASS

Note:

A Period Time = (channel number)\*0.4

DH1 Time Slot: Reading \* (1600/2)\*31.6/(channel number)

DH3 Time Slot: Reading \* (1600/4)\*31.6/(channel number)

DH5 Time Slot: Reading \* (1600/6)\*31.6/(channel number)

For Example:

- In normal mode, hopping rate is 1600 hops/s with 6 slots in 79 hopping channels. With channel hopping rate (1600 / 6 / 79) in Occupancy Time Limit (0.4 x 79) (s), Hops Over Occupancy Time comes to (1600 / 6 / 79) x (0.4 x 79) = 106.67 hops.
- In AFH mode, hopping rate is 800 hops/s with 6 slots in 20 hopping channels. With channel hopping rate (800 / 6 / 20) in Occupancy Time Limit (0.4 x 20) (s), Hops Over Occupancy Time comes to (800 / 6 / 20) x (0.4 x 20) = 53.33 hops.
- Dwell Time(s) = Hops Over Occupancy Time (hops) x Package Transfer Time

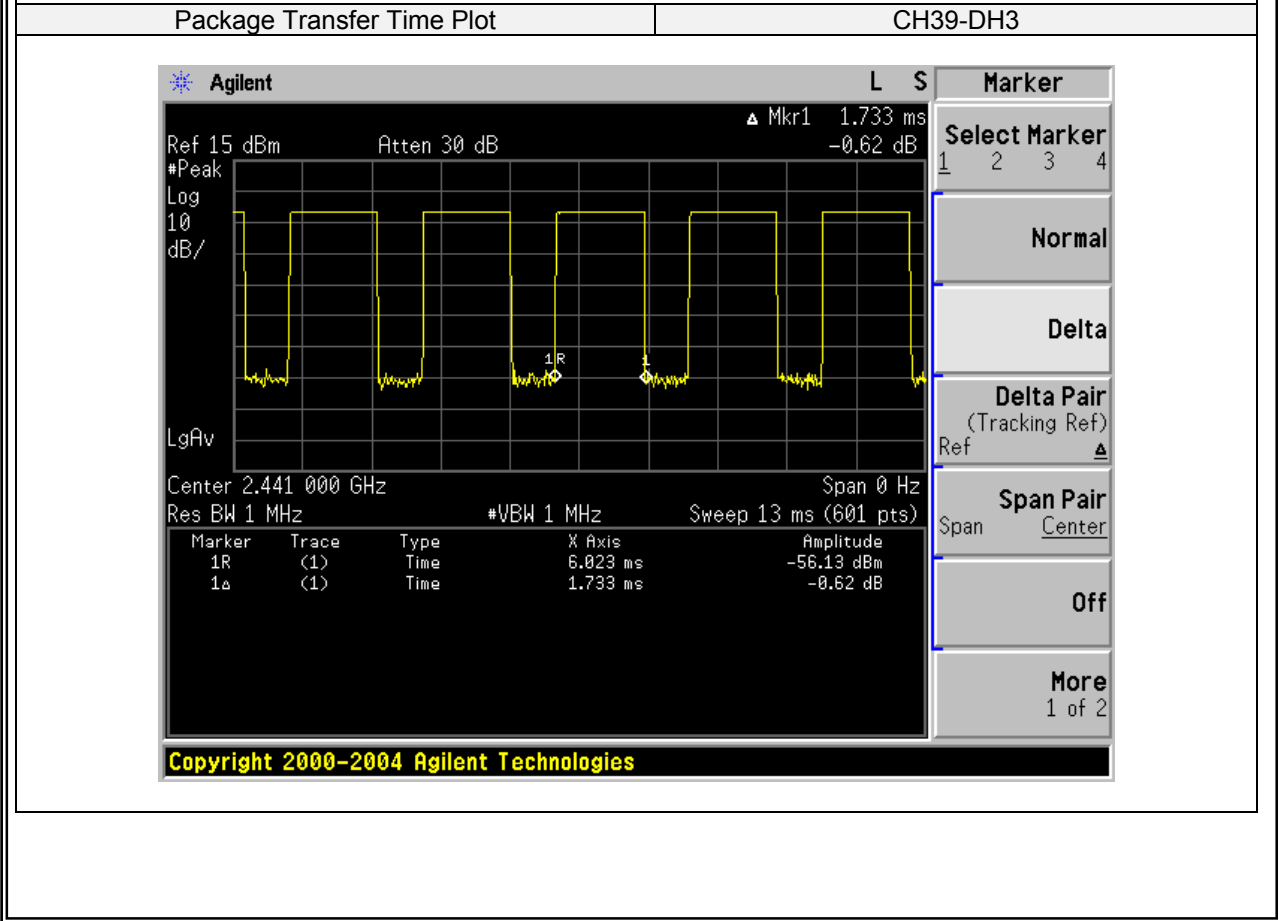
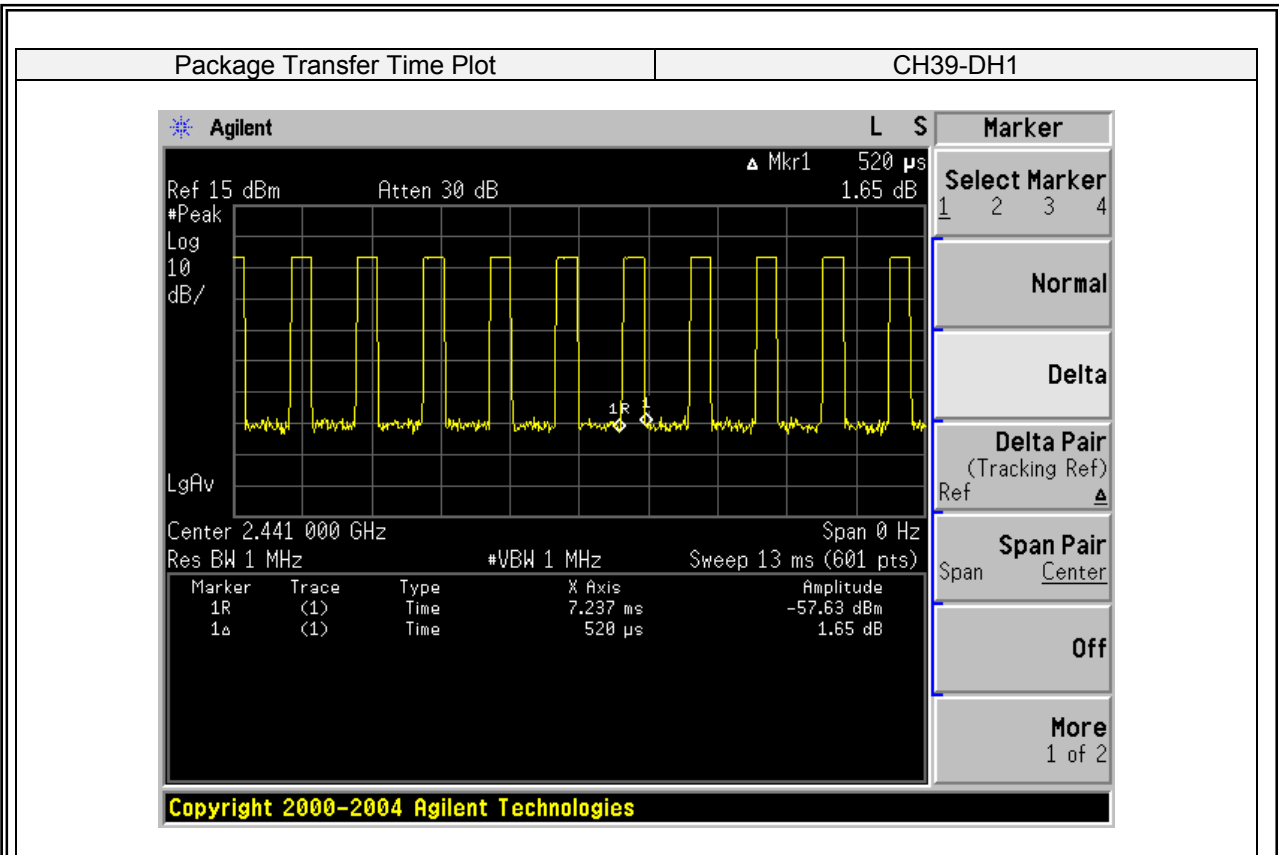

Package Transfer Time Plot

CH39-DH5

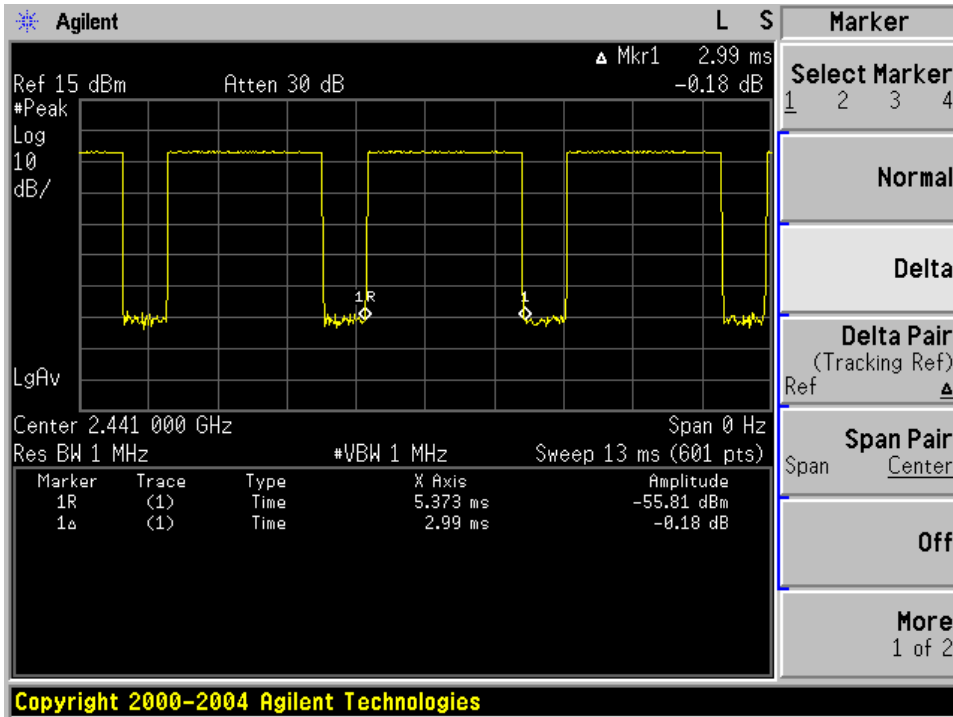

Package Transfer Time Plot

CH39-2DH1

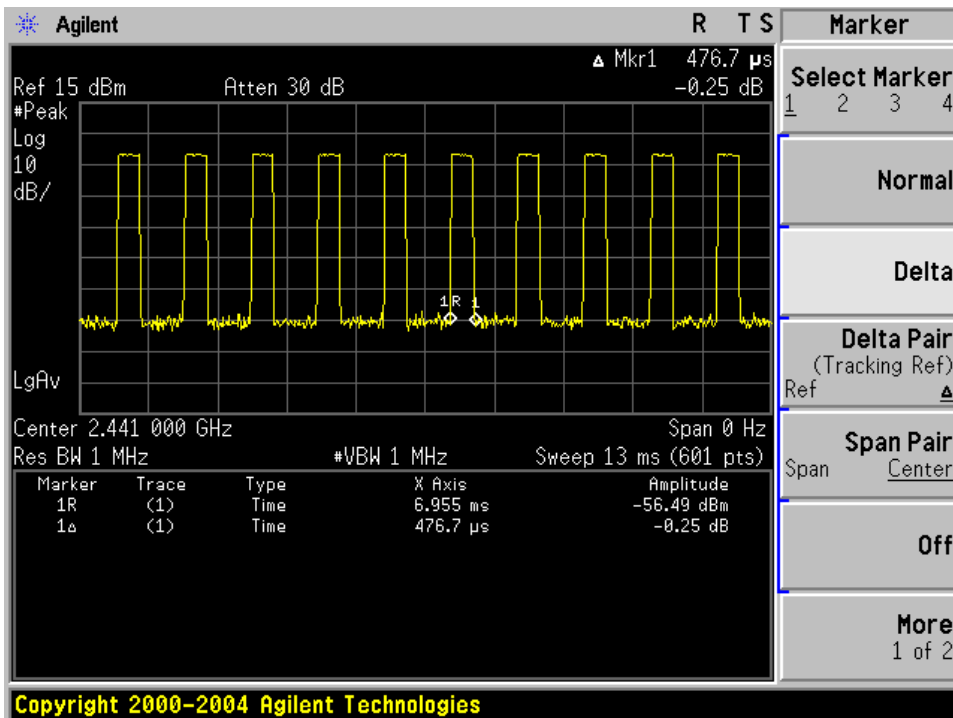

Package Transfer Time Plot

CH39-2DH3

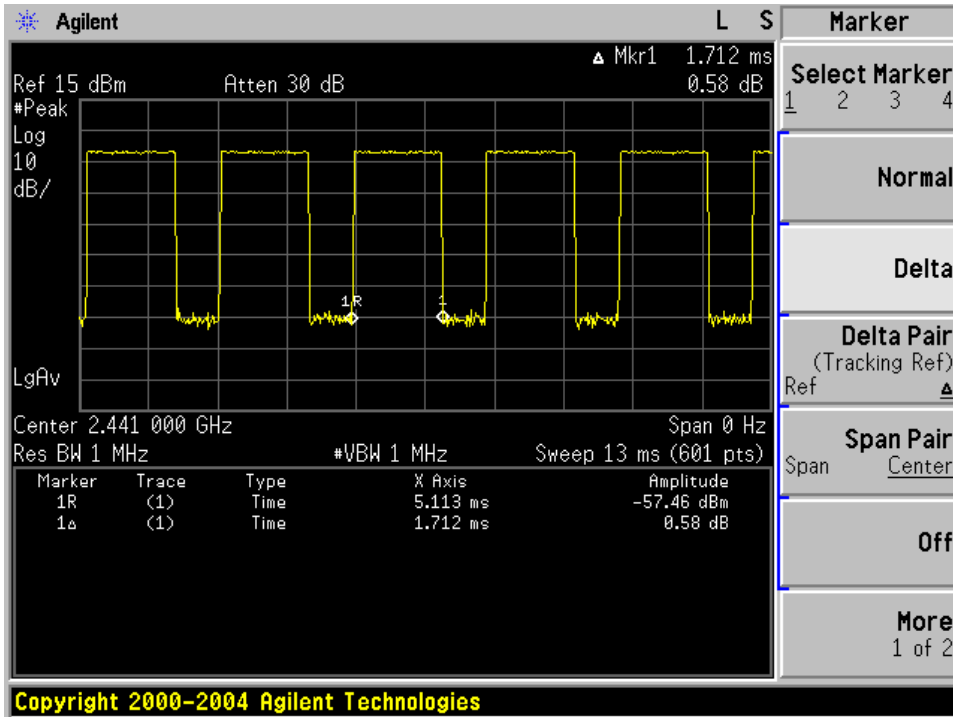

Package Transfer Time Plot

CH39-2DH5

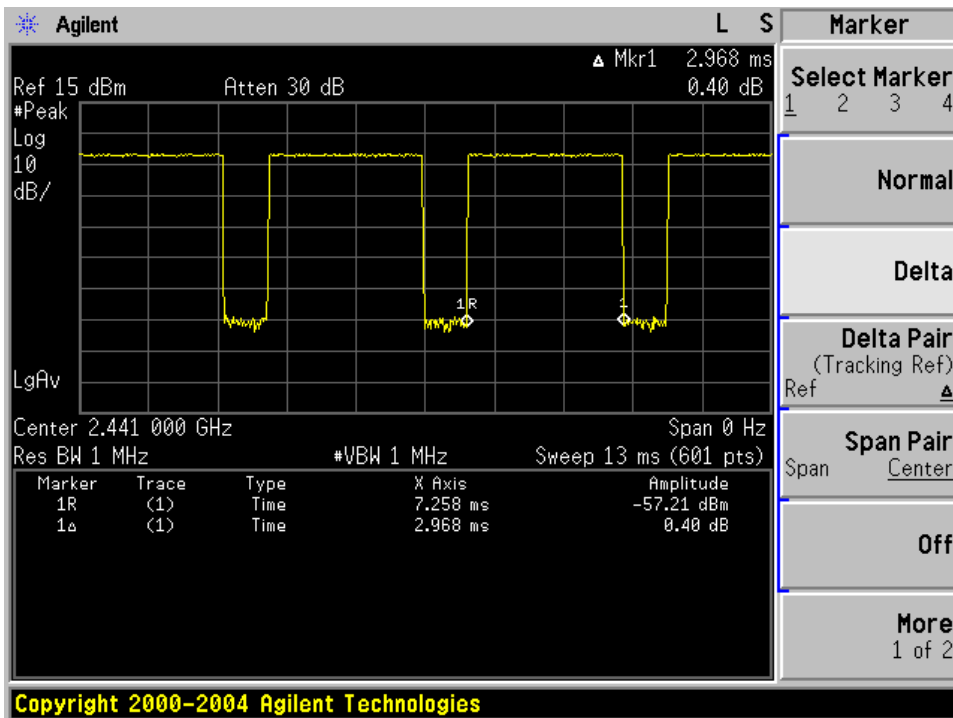



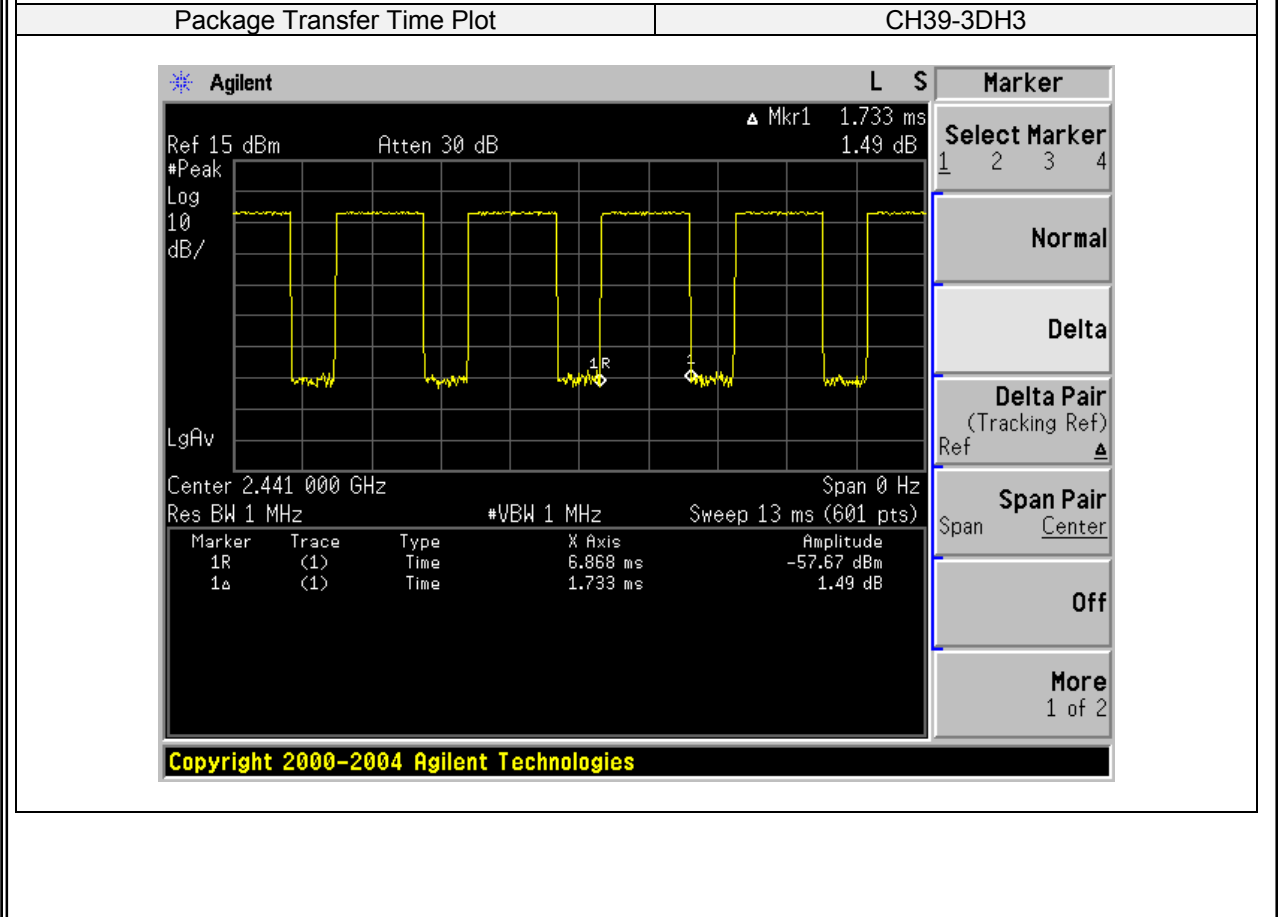
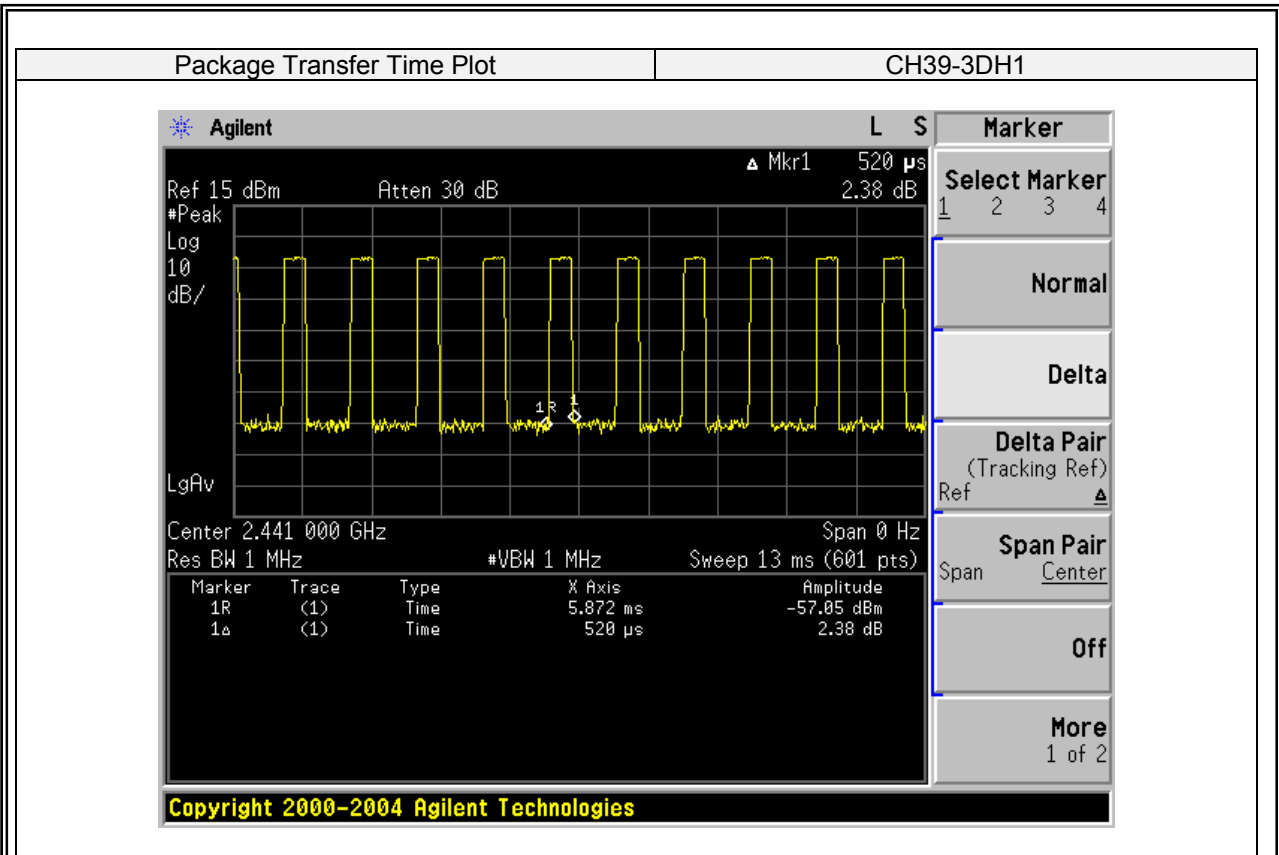

Package Transfer Time Plot

CH39-3DH5

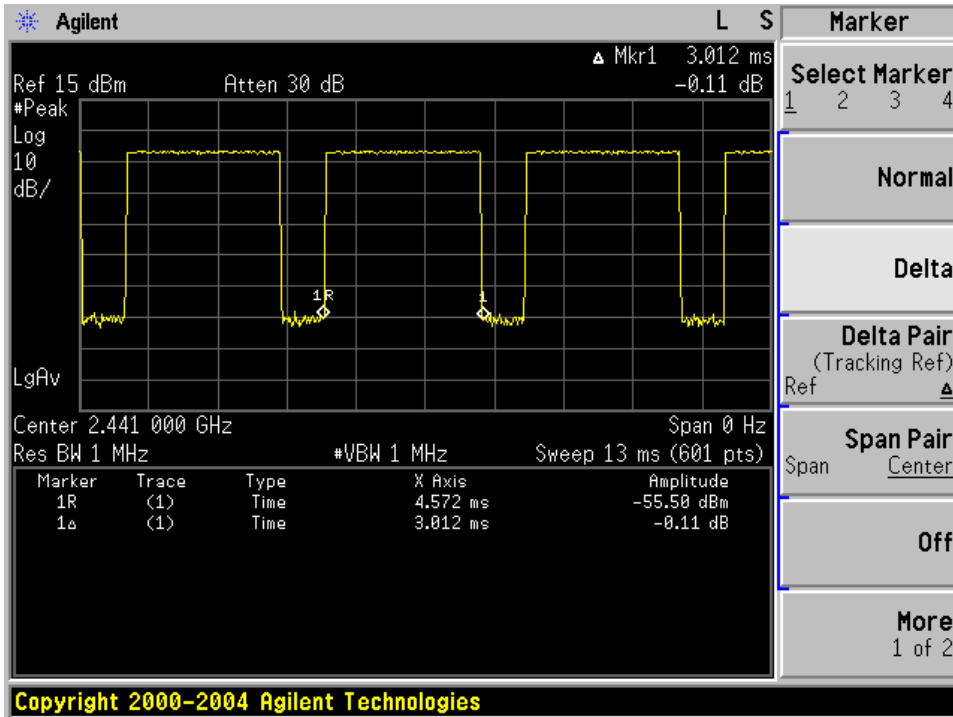

**7.6 20DB BANDWIDTH TEST**

**7.6.1 Applicable Standard**

According to FCC Part 15.247(a)(1) and DA 00-705

**7.6.2 Conformance Limit**

No limit requirement.

**7.6.3 Measuring Instruments**

The Measuring equipment is listed in the section 6.3 of this test report.

**7.6.4 Test Setup**

Please refer to Section 6.1 of this test report.

**7.6.5 Test Procedure**

The testing follows ANSI C63.10-2013 clause 6.9.2  
 The RF output of EUT was connected to the spectrum analyzer by RF cable and attenuator.  
 The path loss was compensated to the results for each measurement.  
 Set to the maximum power setting and enable the EUT transmit continuously.  
 The EUT was operating in controlled its channel.  
 Use the following spectrum analyzer settings:  
 Span = approximately 2 to 3 times the 20 dB bandwidth, centered on a hopping channel  
 RBW ≥ 1% of the 20 dB bandwidth  
 VBW ≥ RBW  
 Sweep = auto  
 Detector function = peak  
 Trace = max hold

**7.6.6 Test Results**

EUT:	Avantree Apico	Model No.:	BTHS-AH8-BLK
Temperature:	20 °C	Relative Humidity:	48%
Test Mode:	Mode1/Mode2/Mode3/Mode4	Test By:	Eileen Liu

Test Channel	Frequency (MHz)	Measurement Bandwidth (KHz)	Limit (kHz)	Verdict
<b>1Mbps</b>				
00	2402	865.551	N/A	PASS
39	2441	863.212	N/A	PASS
78	2480	877.879	N/A	PASS
<b>2Mbps</b>				
00	2402	1255.000	N/A	PASS
39	2441	1253.000	N/A	PASS
78	2480	1258.000	N/A	PASS
<b>3Mbps</b>				
00	2402	1220.000	N/A	PASS
39	2441	1223.000	N/A	PASS
78	2480	1218.000	N/A	PASS

Note: N/A (Not Applicable)





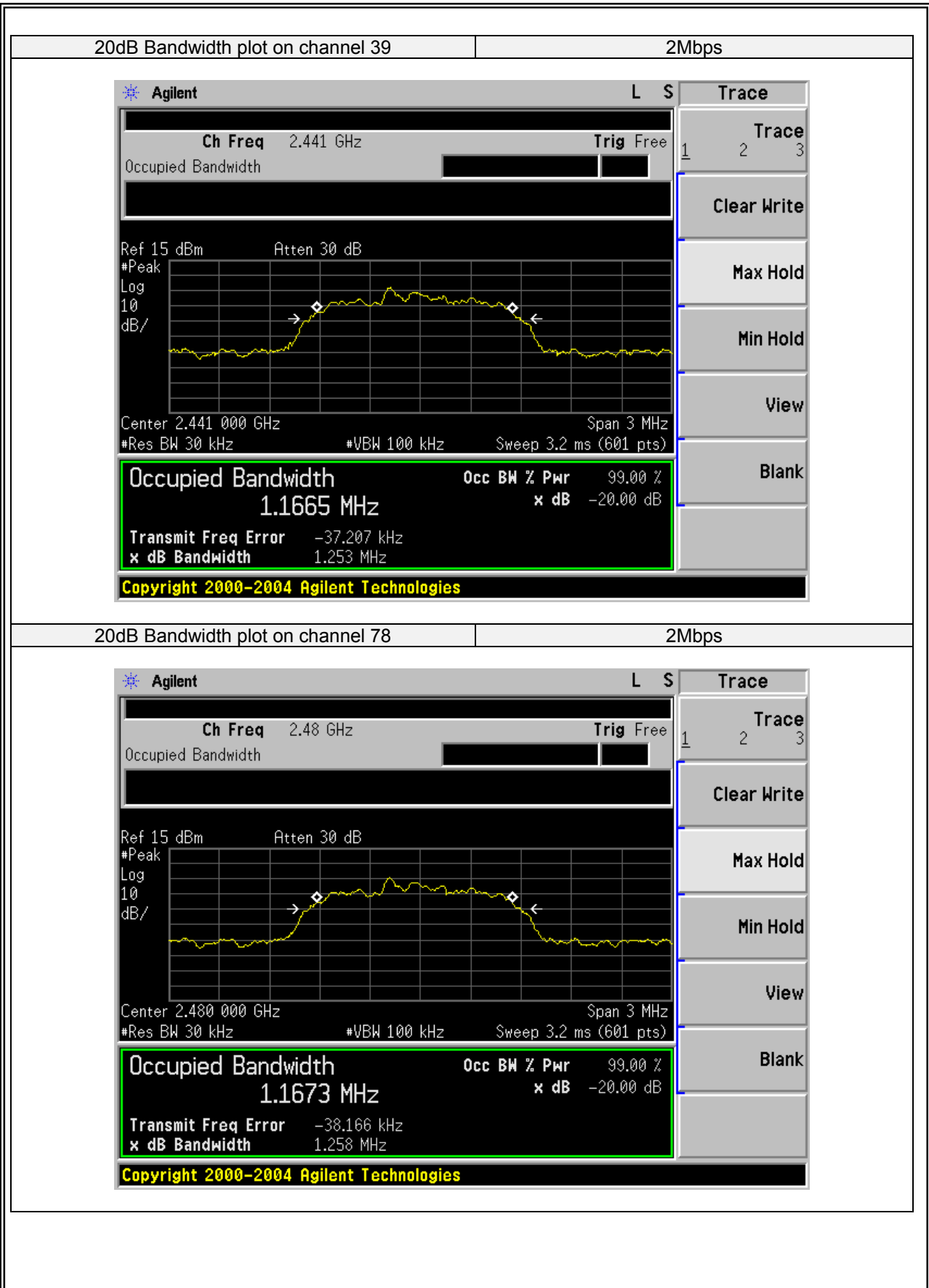

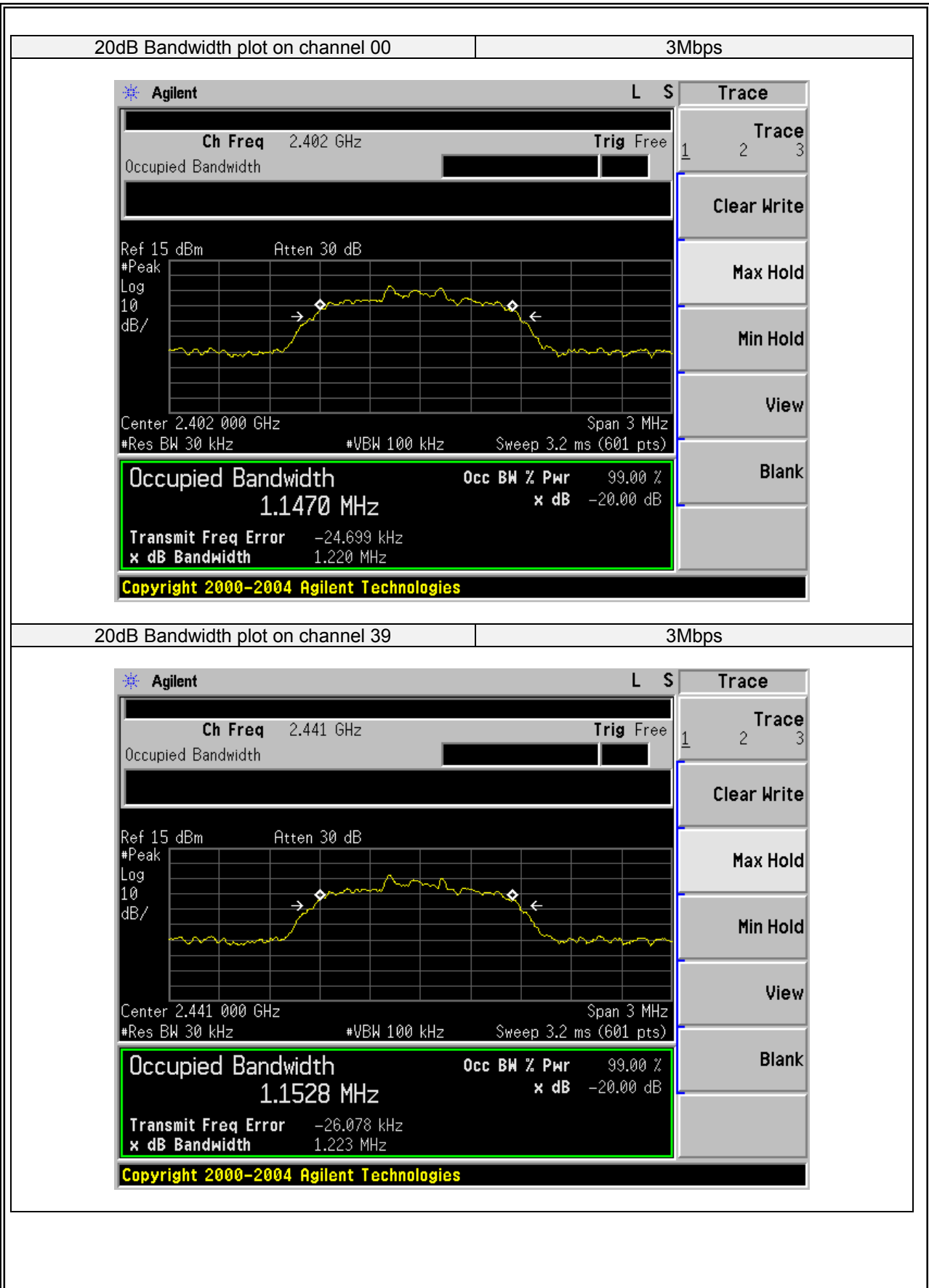

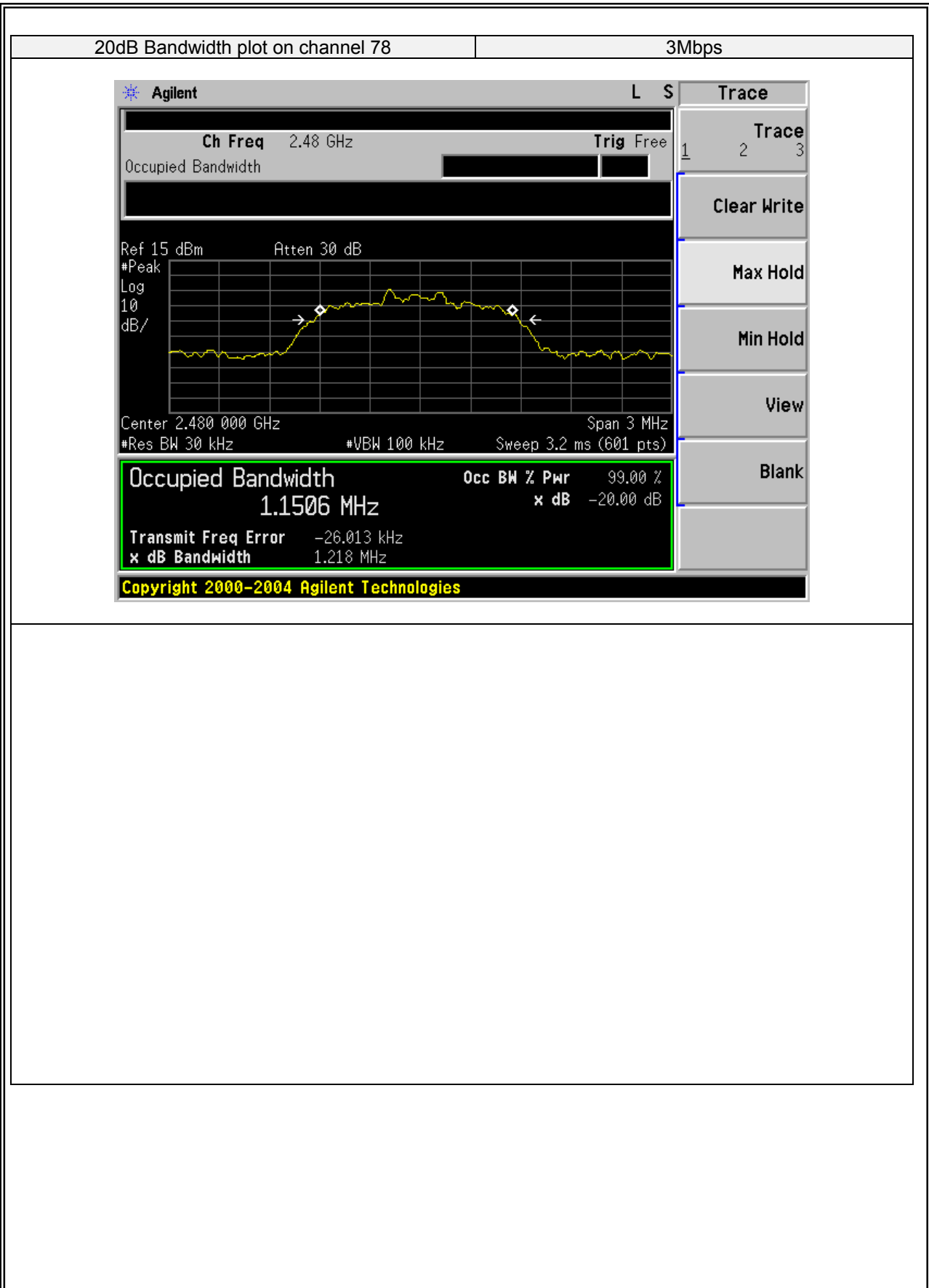



## **7.7 PEAK OUTPUT POWER**

### **7.7.1 Applicable Standard**

According to FCC Part 15.247(b)(1) and DA 00-705

### **7.7.2 Conformance Limit**

The maximum peak conducted output power of the intentional radiator shall not exceed the following: (1) For frequency hopping systems operating in the 2400-2483.5 MHz band employing at least 75 non-overlapping hopping channels, and all frequency hopping systems in the 5725-5850 MHz band: 1 watt. For all other frequency hopping systems in the 2400-2483.5 MHz band 0.125 watts.

### **7.7.3 Measuring Instruments**

The Measuring equipment is listed in the section 6.3 of this test report.

### **7.7.4 Test Setup**

Please refer to Section 6.1 of this test report.

### **7.7.5 Test Procedure**

The testing follows ANSI C63.10-2013 clause 7.8.5.

The RF output of EUT was connected to the spectrum analyzer by RF cable and attenuator.

The path loss was compensated to the results for each measurement.

Set to the maximum power setting and enable the EUT transmit continuously.

The EUT was operating in controlled its channel.

Use the following spectrum analyzer settings:

Span = approximately 5 times the 20 dB bandwidth, centered on a hopping channel

RBW  $\geq$  the 20 dB bandwidth of the emission being measured

VBW  $\geq$  RBW

Sweep = auto

Detector function = peak

Trace = max hold

**7.7.6 Test Results**

EUT:	Avantree Apico	Model No.:	BTHS-AH8-BLK
Temperature:	20 °C	Relative Humidity:	48%
Test Mode:	Mode1/Mode2/Mode3/Mode4	Test By:	Eileen Liu

Test Channel	Frequency (MHz)	Power Setting	Peak Output Power (dBm)	LIMIT (dBm)	Verdict
<b>1Mbps</b>					
00	2402	Default	1.58	30	PASS
39	2441	Default	1.11	30	PASS
78	2480	Default	0.77	30	PASS
<b>2Mbps</b>					
00	2402	Default	0.97	20.97	PASS
39	2441	Default	0.84	20.97	PASS
78	2480	Default	0.11	20.97	PASS
<b>3Mbps</b>					
00	2402	Default	1.49	20.97	PASS
39	2441	Default	0.73	20.97	PASS
78	2480	Default	-0.52	20.97	PASS

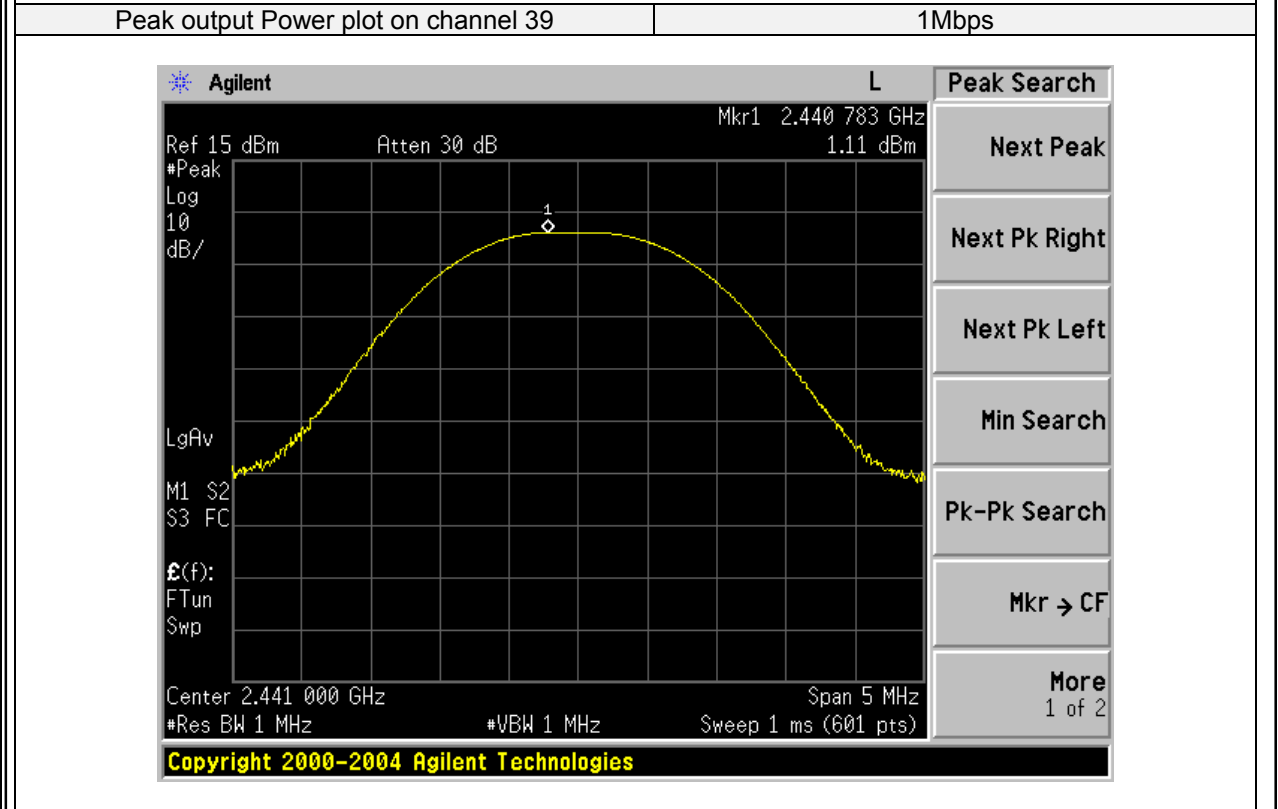
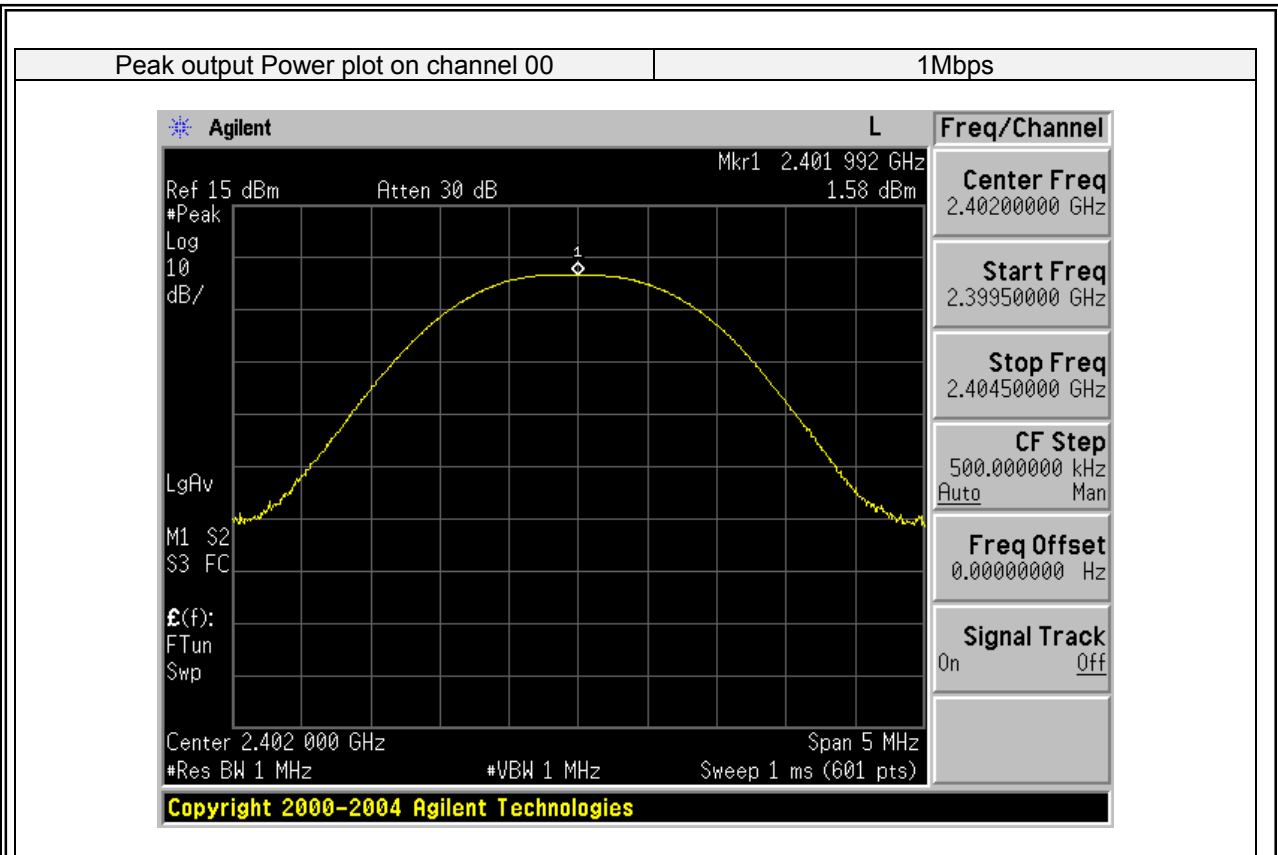

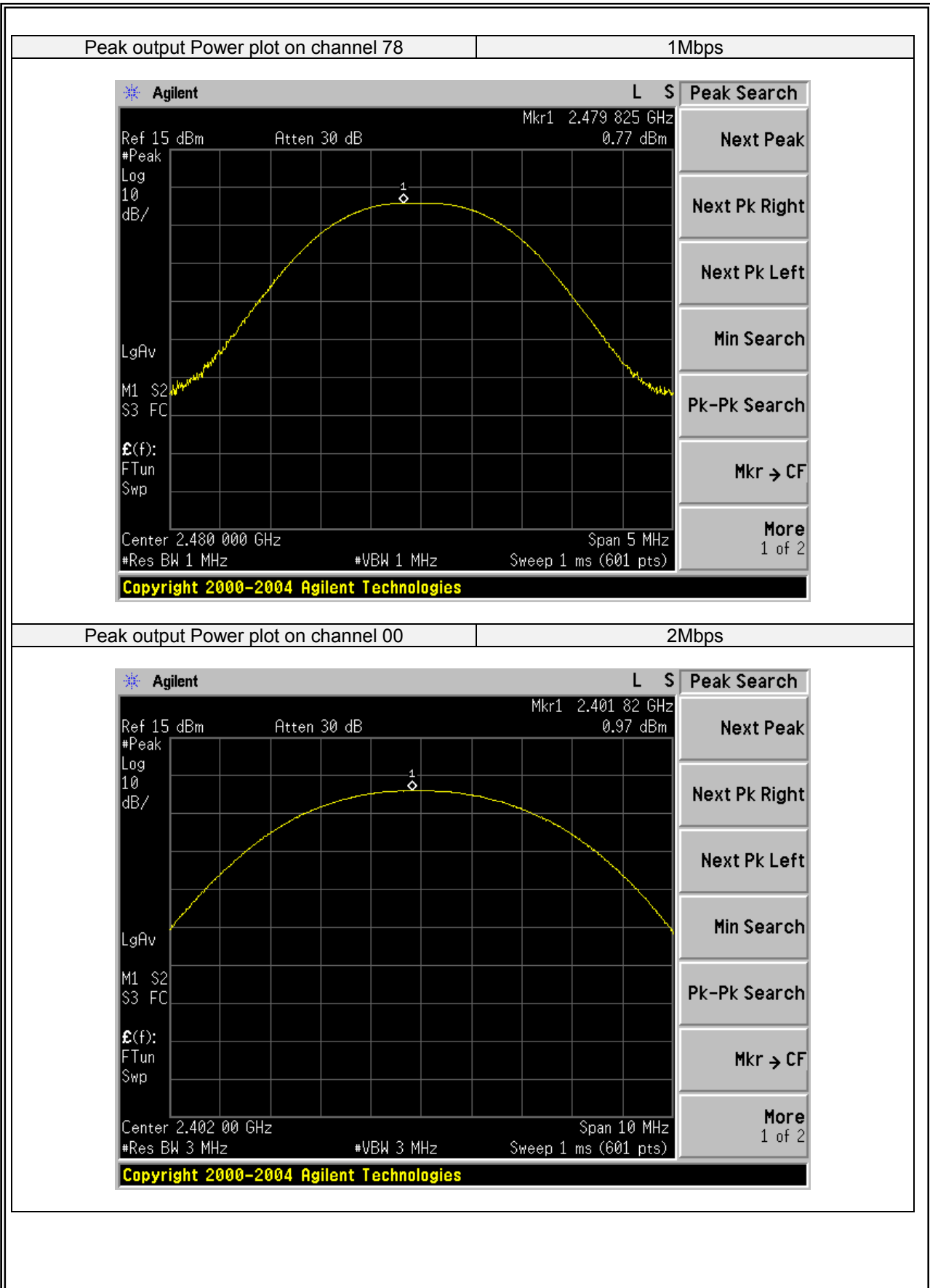

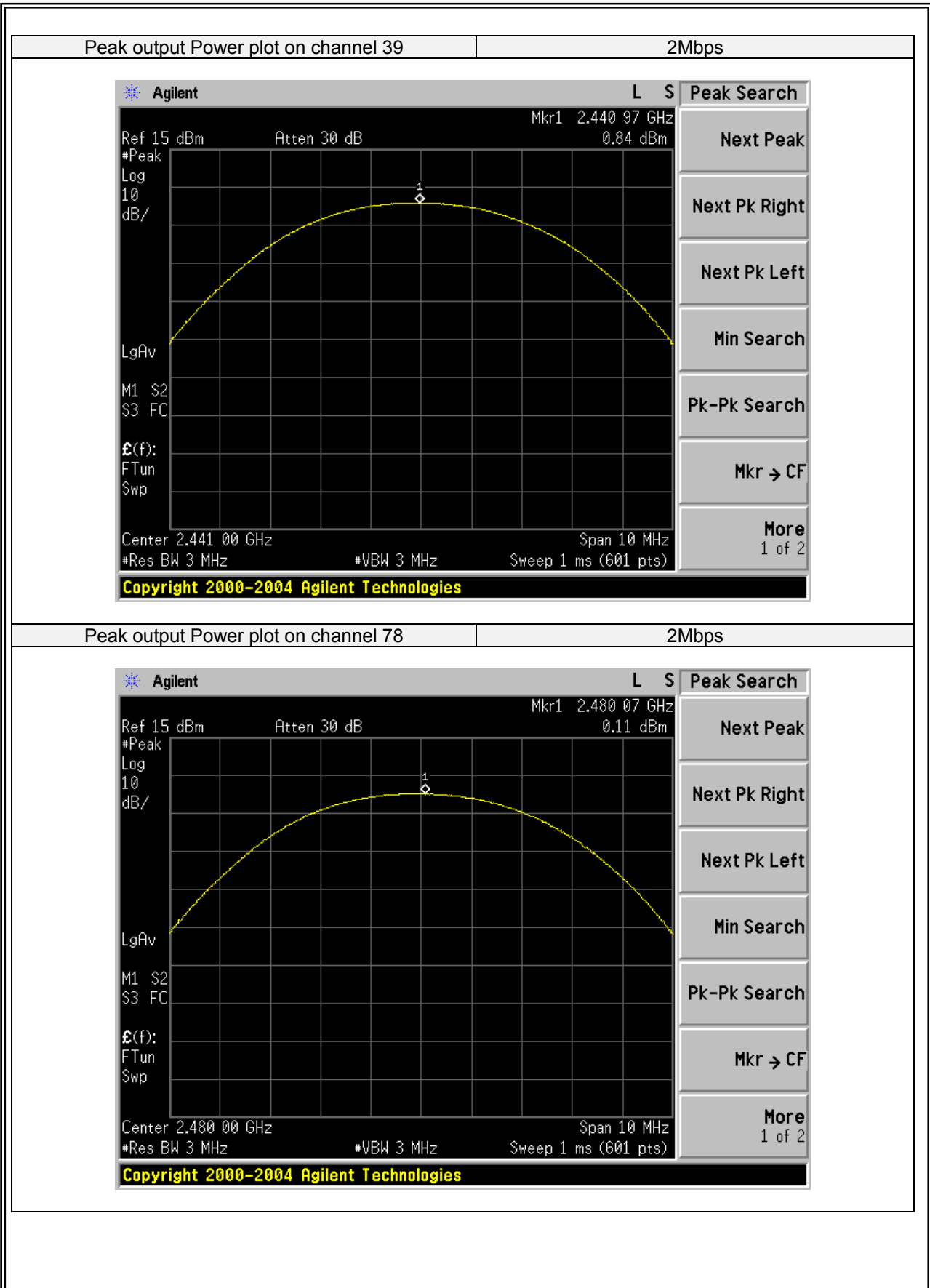

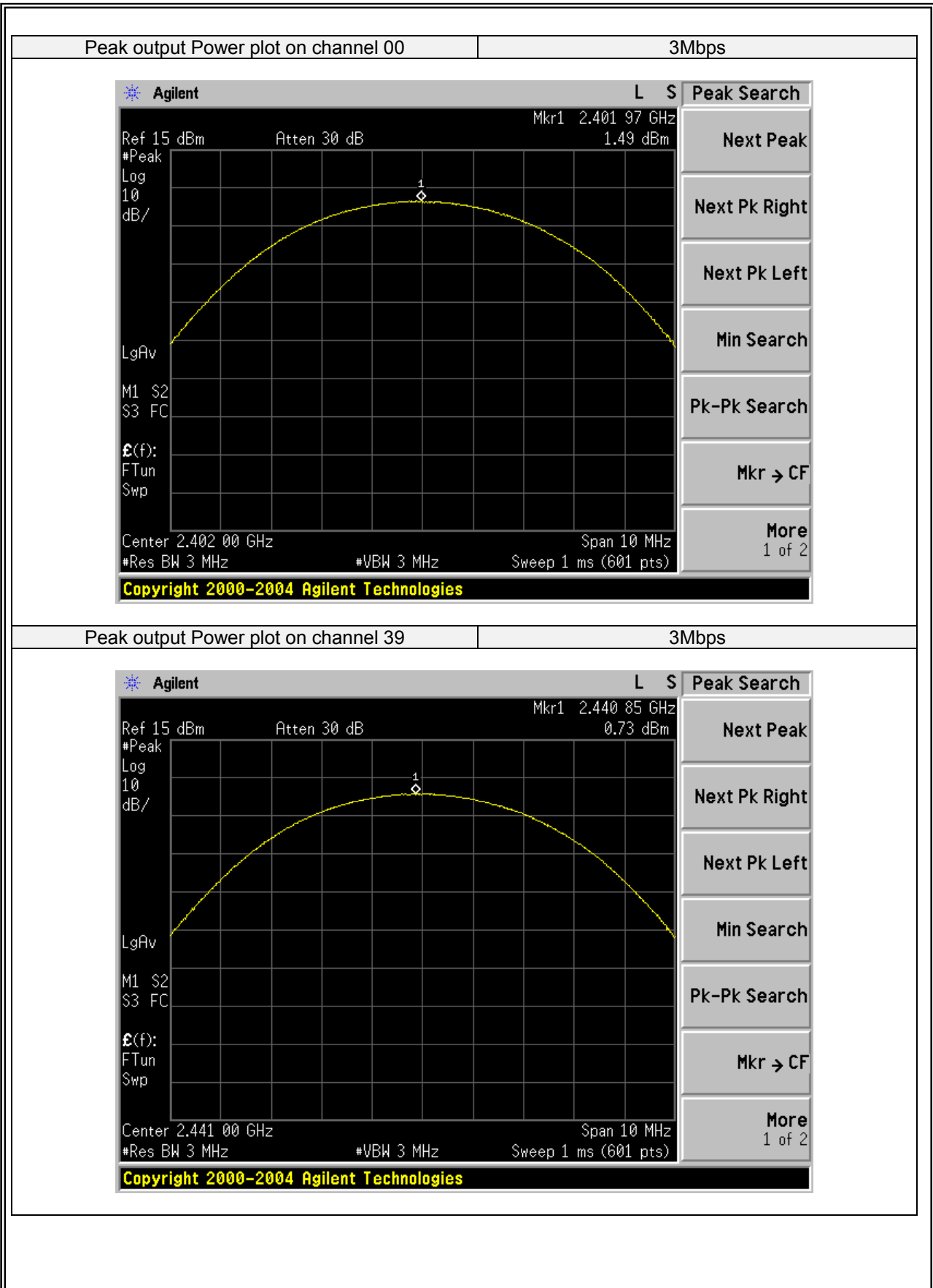

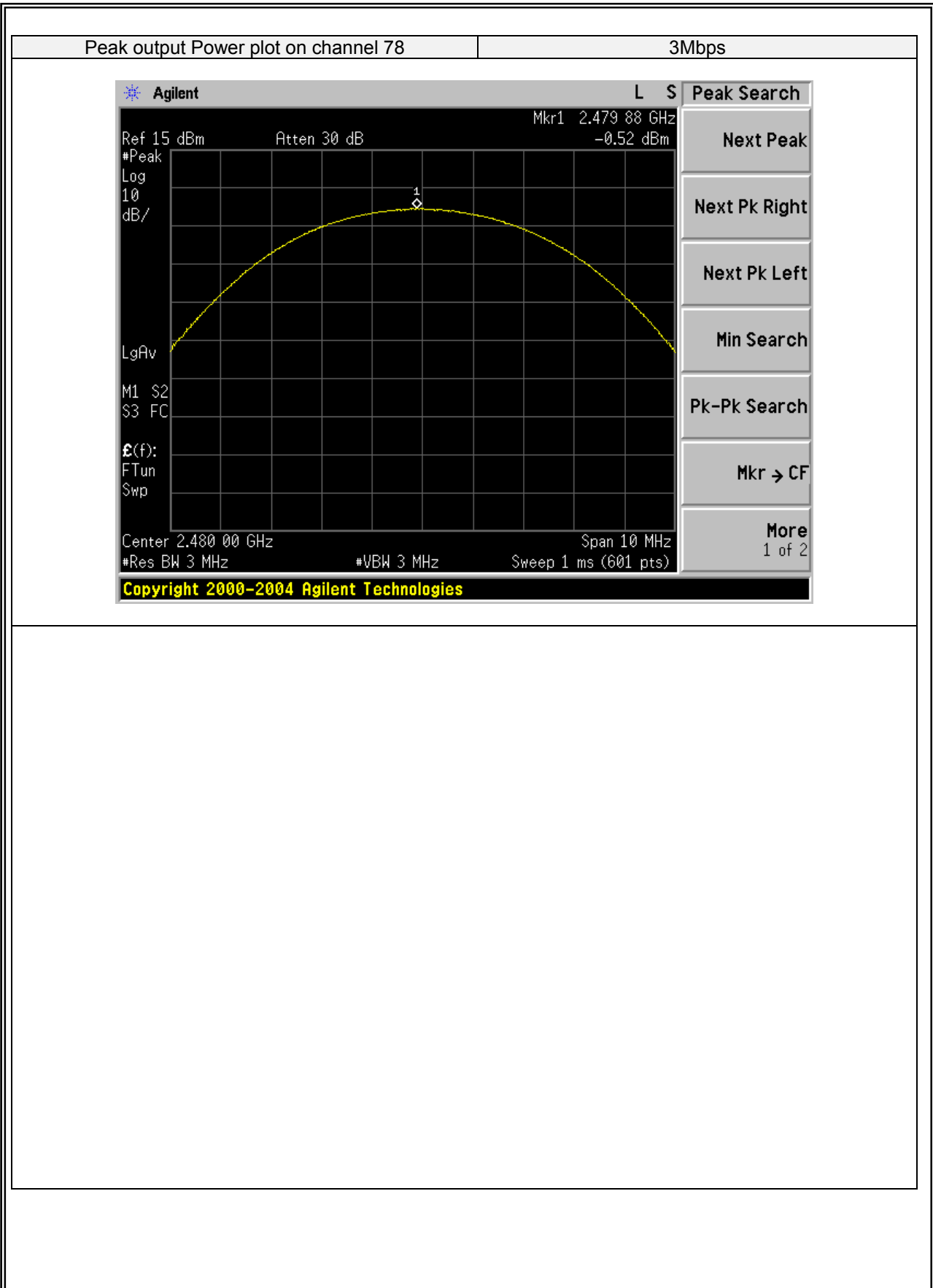

## **7.8 CONDUCTED BAND EDGE MEASUREMENT**

### **7.8.1 Applicable Standard**

According to FCC Part 15.247(d) and DA 00-705

### **7.8.2 Conformance Limit**

In any 100 kHz bandwidth outside the frequency band in which the spread spectrum or digitally modulated intentional radiator is operating, the radio frequency power that is produced by the intentional radiator shall be at least 20 dB below that in the 100 kHz bandwidth within the band that contains the highest level of the desired power, based on either an RF conducted or a radiated measurement, provided the transmitter demonstrates compliance with the peak conducted power limits. If the transmitter complies with the conducted power limits based on the use of RMS averaging over a time interval, as permitted under paragraph (b)(3) of this section, the attenuation required under this paragraph shall be 30 dB instead of 20 dB. Attenuation below the general limits specified in §15.209(a) is not required. In addition, radiated emissions which fall in the restricted bands, as defined in §15.205(a), must also comply with the radiated emission limits specified in §15.209(a) (see §15.205(c)).

### **7.8.3 Measuring Instruments**

The Measuring equipment is listed in the section 6.3 of this test report.

### **7.8.4 Test Setup**

Please refer to Section 6.1 of this test report.

### **7.8.5 Test Procedure**

The testing follows ANSI C63.10-2013 clause 7.8.6.

The RF output of EUT was connected to the spectrum analyzer by RF cable and attenuator.

The path loss was compensated to the results for each measurement.

Set to the maximum power setting and enable the EUT transmit continuously.

The EUT must have its hopping function enabled.

Use the following spectrum analyzer settings:

Span = approximately 5 times the 20 dB bandwidth, centered on a hopping channel

RBW = 100KHz

VBW = 300KHz

Band edge emissions must be at least 20 dB down from the highest emission level within the authorized band as measured with a 100kHz RBW. The attenuation shall be 30 dB instead of 20 dB when RMS conducted output power procedure is used.

Measure the highest amplitude appearing on spectral display and set it as a reference level. Plot the graph with marking the highest point and edge frequency.

Repeat above procedures until all measured frequencies were complete.



**7.8.6 Test Results**

EUT:	Avantree Apico	Model No.:	BTHS-AH8-BLK
Temperature:	20 °C	Relative Humidity:	48%
Test Mode:	Mode1/Mode2/Mode3/Mode4	Test By:	Eileen Liu

Note: Hopping enabled and disabled have evaluated, and the worst data was reported

BDR mode (GFSK): Band Edge-Low Channel

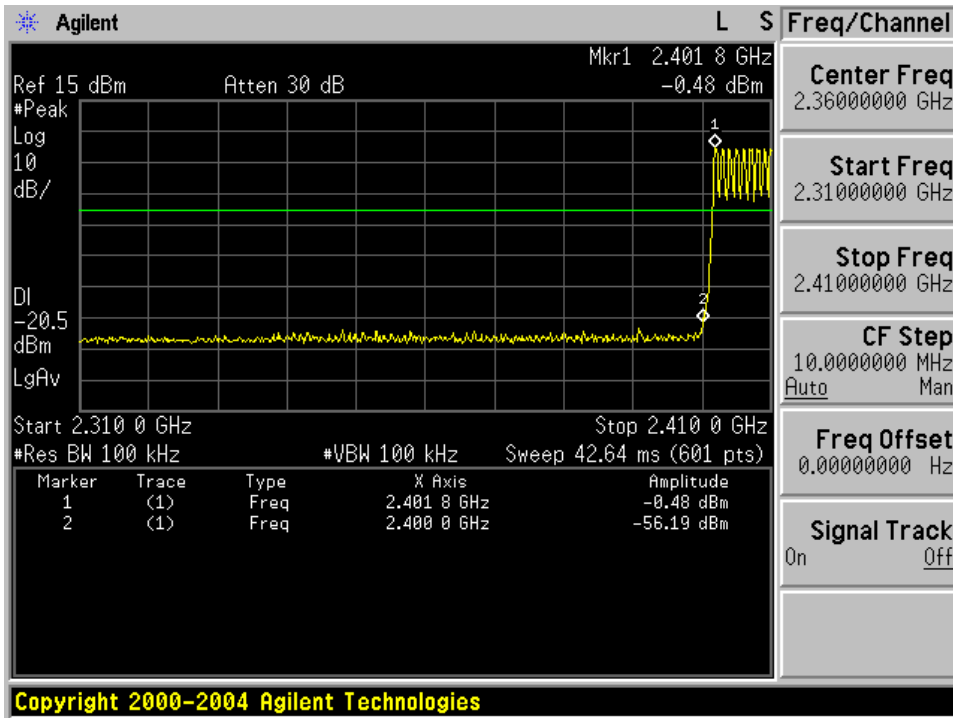
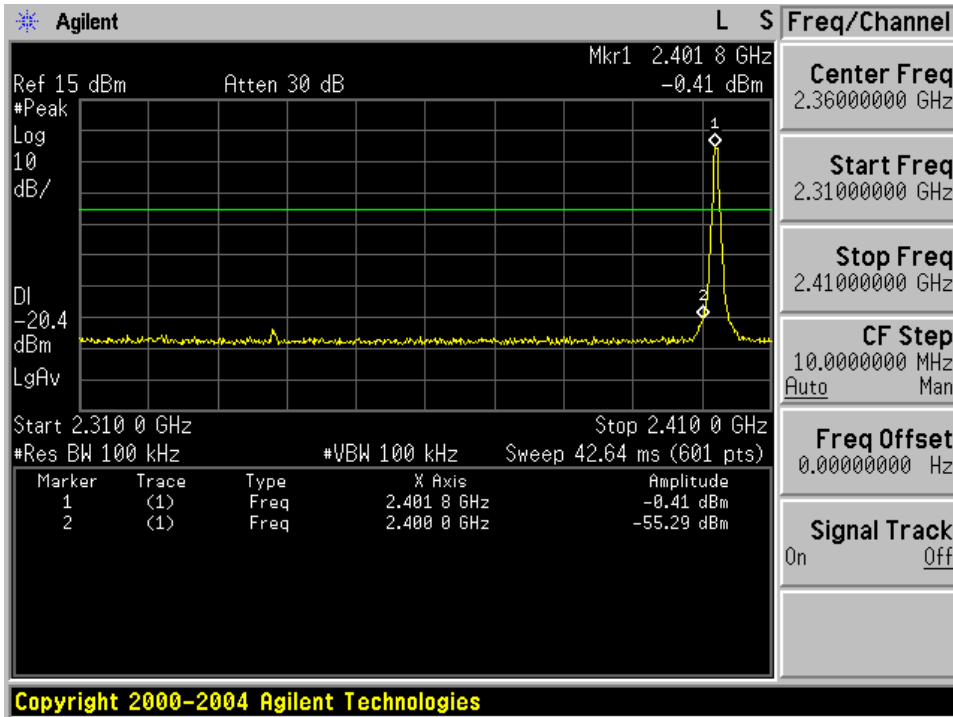

BDR mode (GFSK): Band Edge-High Channel

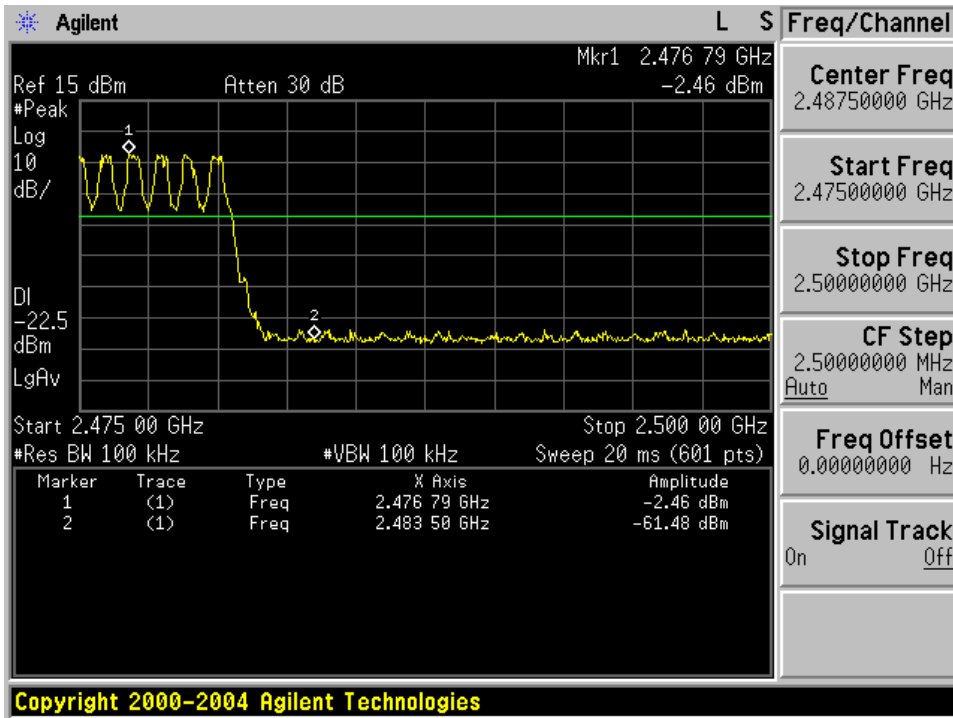
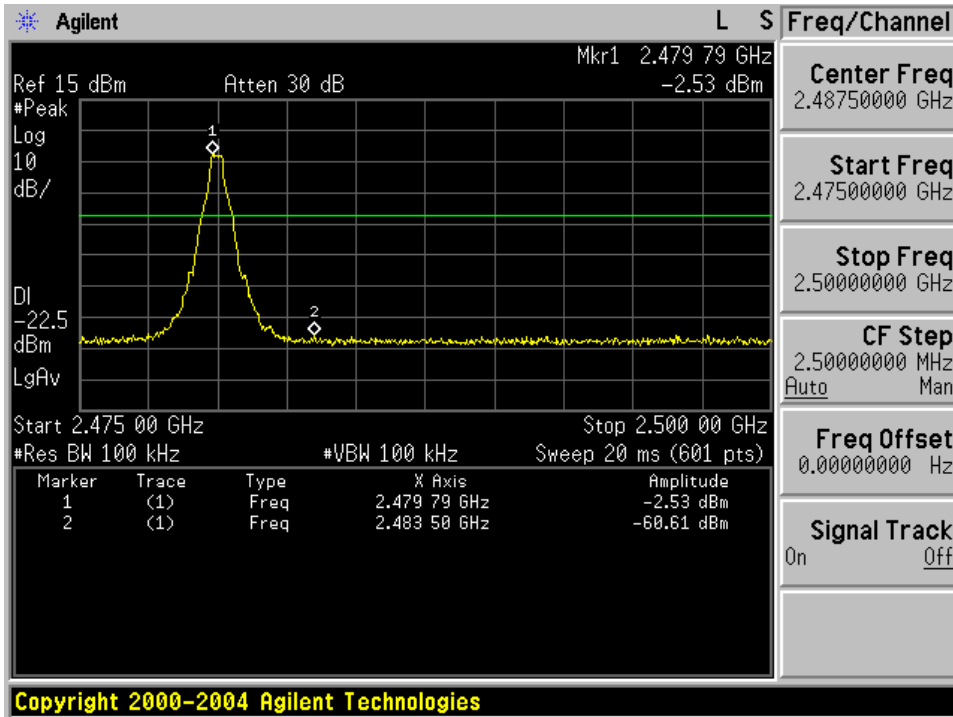

EDR mode ( $\pi/4$ -DQPSK): Band Edge-Low Channel

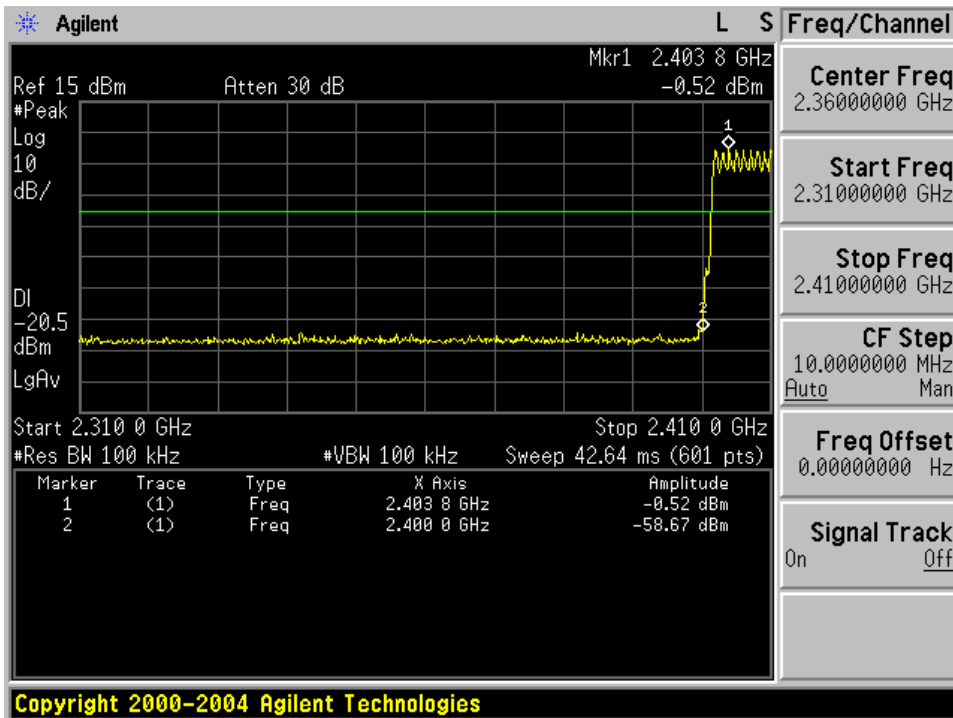
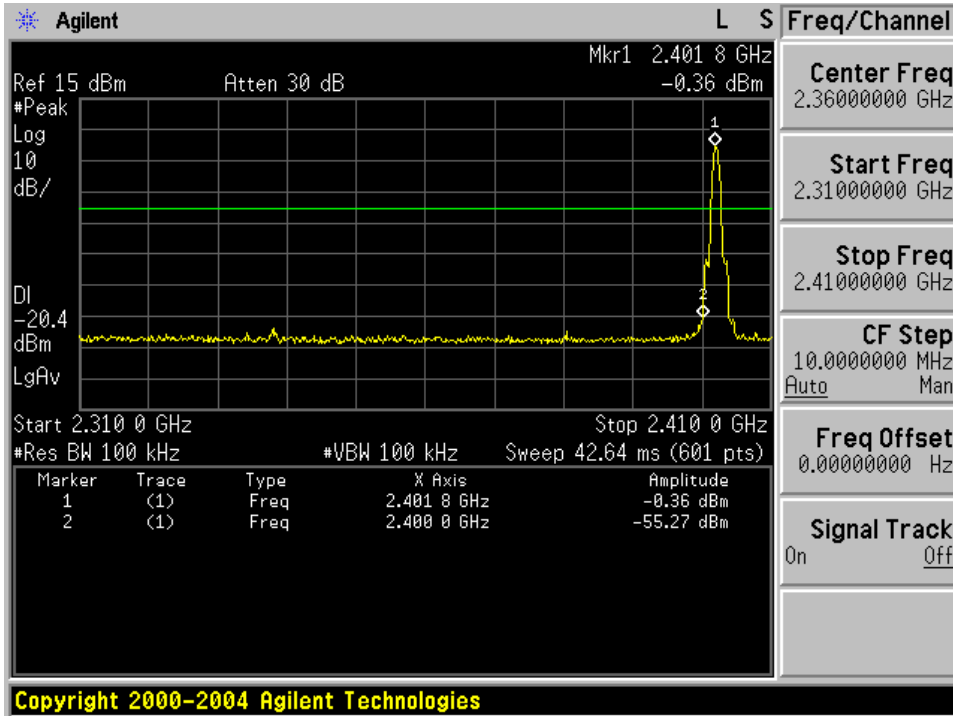

EDR mode ( $\pi/4$ -DQPSK): Band Edge- High Channel

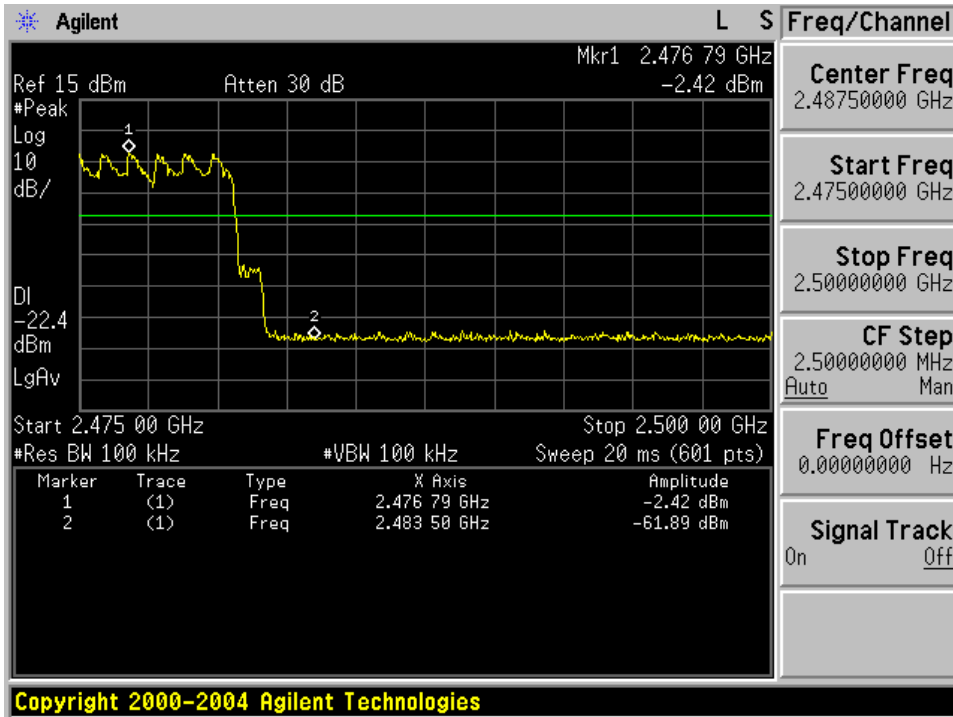
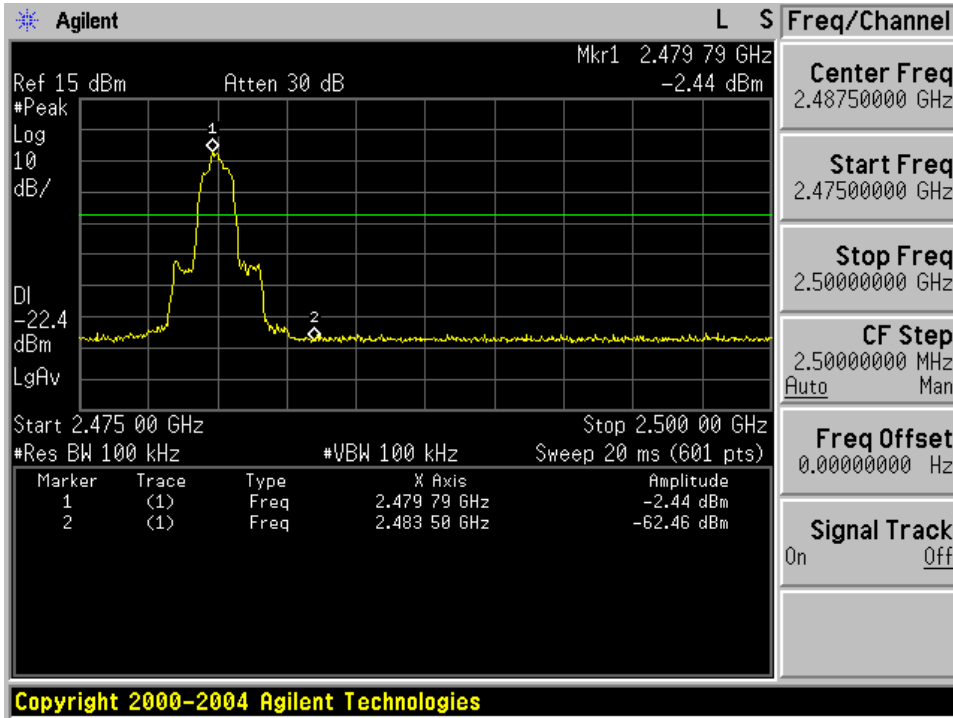

EDR mode (8DPSK): Band Edge-Low Channel

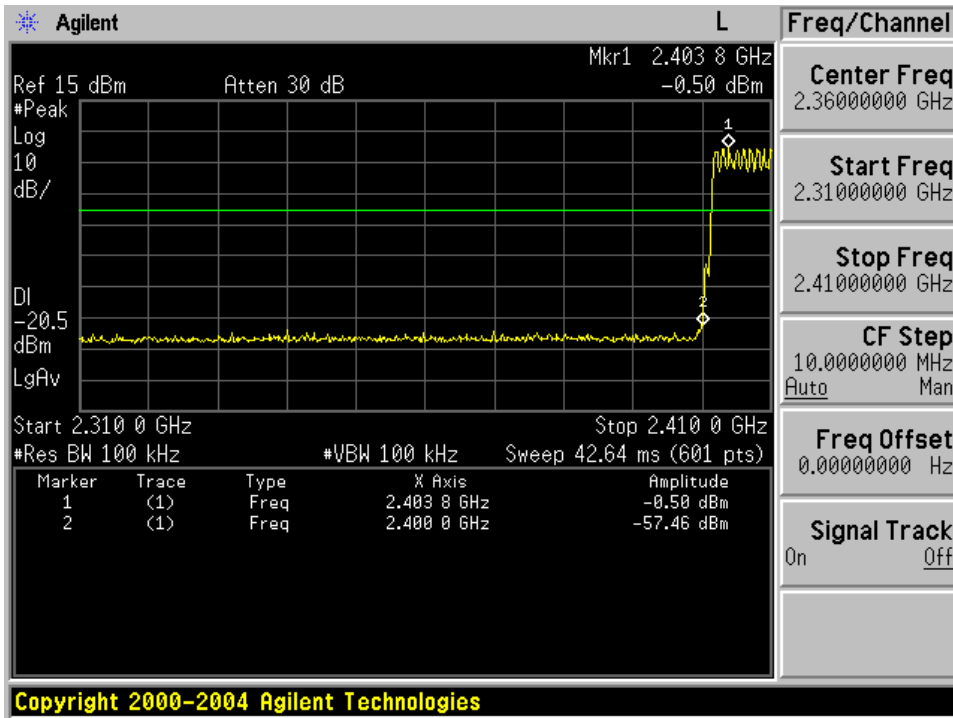
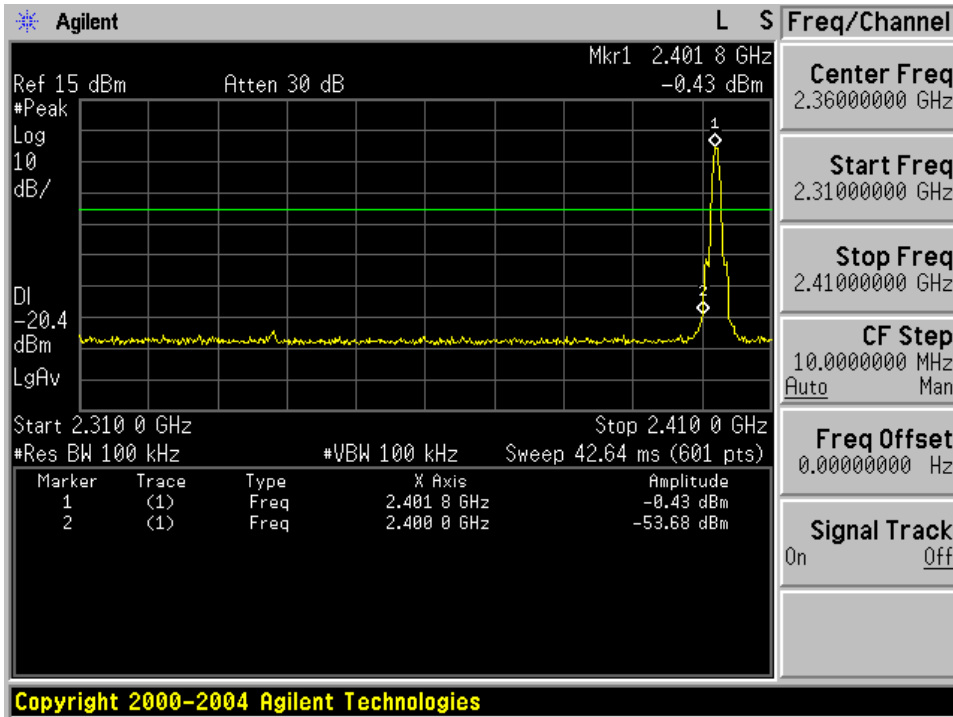

EDR mode (8DPSK): Band Edge- High Channel

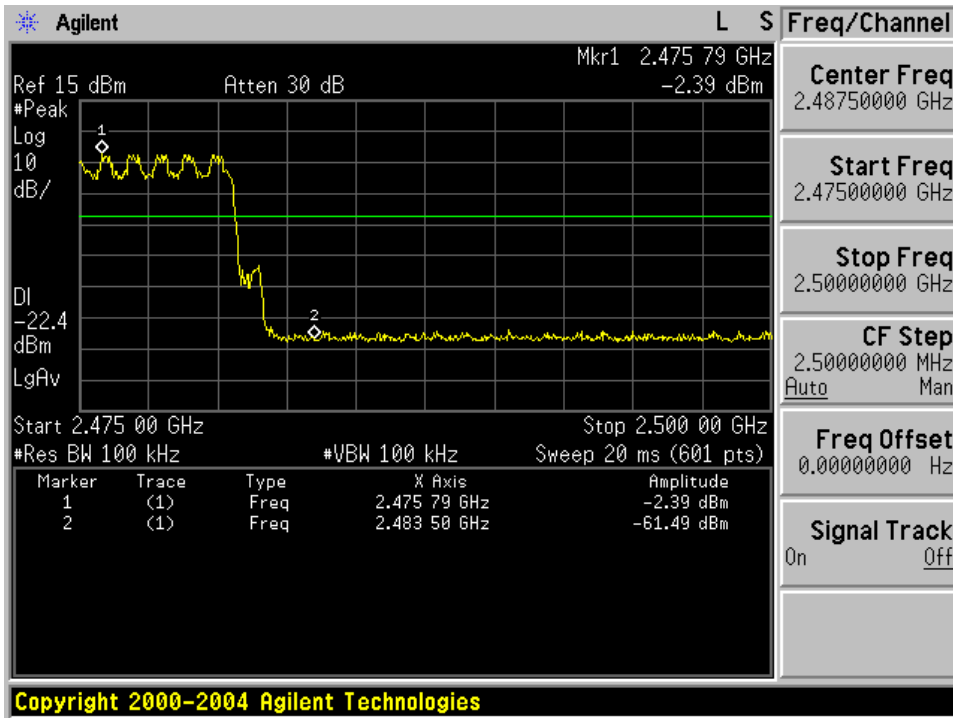
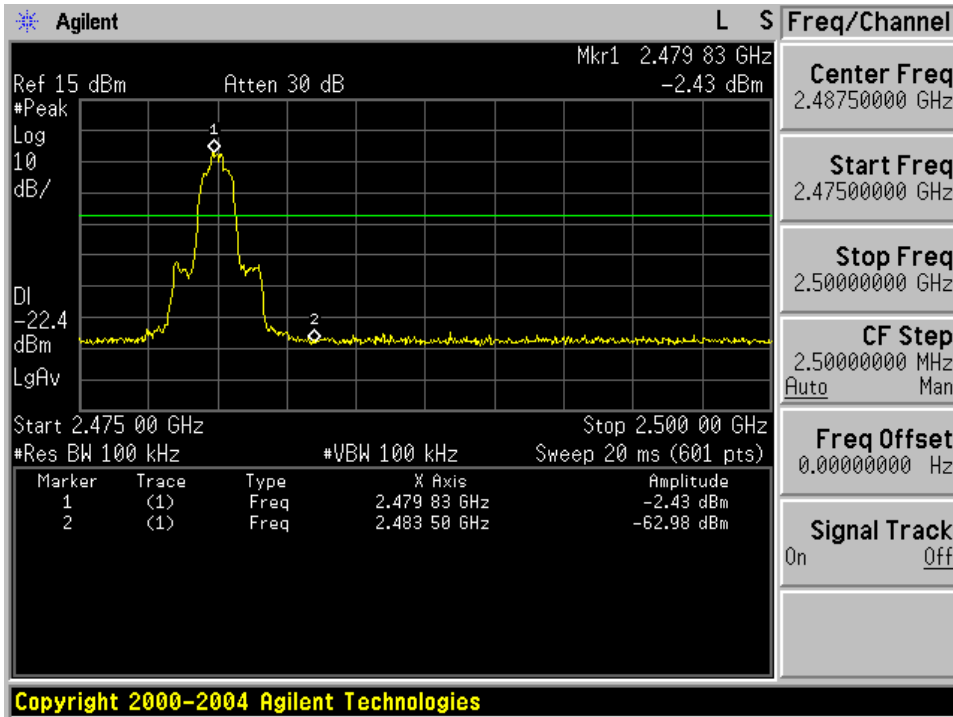

## **7.9 ANTENNA APPLICATION**

### **7.9.1 Antenna Requirement**

15.203 requirement: For intentional device, according to 15.203: an intentional radiator shall be designed to ensure that no antenna other than that furnished by the responsible party shall be used with the device.

### **7.9.2 Result**

The EUT antenna is permanent attached antenna. It comply with the standard requirement.

END OF REPORT