

FCC TEST REPORT

For

SHENZHEN MAGICSEE TECHNOLOGY CO., LTD.

Android TV box

Model No.: N5, N5MAX, N6MAX

Prepared For : SHENZHEN MAGICSEE TECHNOLOGY CO., LTD.
Address : No 242 Building 4, Xixiang Road, Baoan District, Shenzhen City,
Guangdong Province, China

Prepared By : Shenzhen Anbotek Compliance Laboratory Limited
Address : 1/F, Building D, Sogood Science and Technology Park, Sanwei
community, Hangcheng Street, Bao'an District, Shenzhen, Guangdong,
China.518102
Tel: (86) 755-26066440 Fax: (86) 755-26014772

Report Number : SZAWW180831003-02
Date of Receipt : Aug. 31, 2018
Date of Test : Aug. 31~Sept. 28, 2018
Date of Report : Sept. 28, 2018

Contents

| | |
|---|----|
| 1. General Information..... | 4 |
| 1.1. Client Information..... | 4 |
| 1.2. Description of Device (EUT)..... | 4 |
| 1.3. Auxiliary Equipment Used During Test..... | 5 |
| 1.4. Description of Test Modes..... | 6 |
| 1.5. List of channels..... | 7 |
| 1.6. Description Of Test Setup..... | 8 |
| 1.7. Test Equipment List..... | 9 |
| 1.8. Description of Test Facility..... | 10 |
| 2. Summary of Test Results..... | 11 |
| 3. Conducted Emission Test..... | 12 |
| 3.1. Test Standard and Limit..... | 12 |
| 3.2. Test Setup..... | 12 |
| 3.3. Test Procedure..... | 12 |
| 3.4. Test Data..... | 12 |
| 4. Radiation Spurious Emission and Band Edge..... | 17 |
| 4.1. Test Standard and Limit..... | 17 |
| 4.2. Test Setup..... | 18 |
| 4.3. Test Procedure..... | 19 |
| 4.4. Test Data..... | 19 |
| 5. Maximum Peak Output Power Test..... | 40 |
| 5.1. Test Standard and Limit..... | 40 |
| 5.2. Test Setup..... | 40 |
| 5.3. Test Procedure..... | 40 |
| 5.4. Test Data..... | 40 |
| 6. Occupy Bandwidth Test..... | 42 |
| 6.1. Test Standard..... | 42 |
| 6.2. Test Setup..... | 42 |
| 6.3. Test Procedure..... | 42 |
| 6.4. Test Data..... | 42 |
| 7. Power Spectral Density Test..... | 60 |
| 7.1. Test Standard and Limit..... | 60 |
| 7.2. Test Setup..... | 60 |
| 7.3. Test Procedure..... | 60 |
| 7.4. Test Data..... | 60 |
| 8. Antenna Requirement..... | 69 |
| 8.1. Test Standard and Requirement..... | 69 |
| 8.2. Antenna Connected Construction..... | 70 |
| APPENDIX I -- TEST SETUP PHOTOGRAPH..... | 71 |
| APPENDIX II -- EXTERNAL PHOTOGRAPH..... | 73 |
| APPENDIX III -- INTERNAL PHOTOGRAPH..... | 77 |

TEST REPORT

Applicant : SHENZHEN MAGICSEE TECHNOLOGY CO., LTD.
Manufacturer : SHENZHEN MAGICSEE TECHNOLOGY CO., LTD.
Product Name : Android TV box
Model No. : N5, N5MAX, N6MAX
Trade Mark : Magicsee
Rating(s) : (via adapter input: AC 100~240V, 50/60Hz ,0.5A; output: DC 5V, 2A)
Test Standard(s) : **FCC Part15 Subpart E 2016, Paragraph 15.407**
Test Method(s) : **ANSI C63.10: 2013**
KDB 789033 D02 General UNII Test Procedures New Rules v01r04

The device described above is tested by Shenzhen Anbotek Compliance Laboratory Limited to determine the maximum emission levels emanating from the device and the severe levels of the device can endure and its performance criterion. The measurement results are contained in this test report and Shenzhen Anbotek Compliance Laboratory Limited is assumed full of responsibility for the accuracy and completeness of these measurements. Also, this report shows that the EUT (Equipment Under Test) is technically compliant with the FCC Part 15 Subpart E requirements.

This report applies to above tested sample only and shall not be reproduced in part without written approval of Shenzhen Anbotek Compliance Laboratory Limited.

Date of Test

Aug. 31~Sept. 28, 2018

Prepared by



Oliay Yang

(Engineer / Oliay Yang)

Reviewer

Snowy Meng

(Supervisor / Snowy Meng)

Approved & Authorized Signer

Sally Zhang

(Manager / Sally Zhang)

1. General Information

1.1. Client Information

| | | |
|--------------|---|---|
| Applicant | : | SHENZHEN MAGICSEE TECHNOLOGY CO., LTD. |
| Address | : | No 242 Building 4, Xixiang Road, Baoan District, Shenzhen City, Guangdong Province, China |
| Manufacturer | : | SHENZHEN MAGICSEE TECHNOLOGY CO., LTD. |
| Address | : | No 242 Building 4, Xixiang Road, Baoan District, Shenzhen City, Guangdong Province, China |
| Factory | : | SHENZHEN MAGICSEE TECHNOLOGY CO., LTD. |
| Address | : | No 242 Building 4, Xixiang Road, Baoan District, Shenzhen City, Guangdong Province, China |

1.2. Description of Device (EUT)

| | | | |
|--|---|--|---|
| Product Name | : | Android TV box | |
| Model No. | : | N5, N5MAX, N6MAX (Note: All samples are the same except the solutions, so we prepare "N5" for test only.) | |
| Trade Mark | : | Magicsee | |
| Test Power Supply | : | AC 240V, 60Hz for adapter/ AC 120V, 60Hz for adapter | |
| Product Description | : | Operation Frequency: | WIFI 5G: 5745MHz~5825MHz / 5755MHz~5795MHz/ 5775MHz |
| | : | Number of Channel: | WIFI 5G: 5 Channels for 802.11a 5 Channels for 802.11n(HT20) 5 Channels for 802.11ac(HT20) 2 Channels for 802.11n(HT40) 2 Channels for 802.11ac(HT40) 1 Channels for 802.11ac(HT80) |
| | : | Modulation Type: | OFDM with BPSK/QPSK/16QAM/64QAM for 802.11a/b/g/n; OFDM with BPSK/QPSK/16QAM/64QAM/ 256QAM for 802.11ac |
| | : | Antenna Type: | FPCB Antenna |
| | : | Antenna Gain(Peak): | 2.5 dBi |
| <p>Remark: 1) For a more detailed features description, please refer to the manufacturer's specifications or the User's Manual. 2) This report is for Wifi 5.8G.</p> | | | |

1.3. Auxiliary Equipment Used During Test

| | | |
|----------|---|--|
| Keyboard | : | Manufacturer: DELL |
| | | M/N: SK-8120 S/N: CN-0DJ365-71616-49J-0MVR-A00 Input Rating: DC 5V, 0.05A CE, FCC, VCCI, KCC, TUV-GS Cable: 1.8m, unshielded |
| Mouse | : | Manufacturer: DELL |
| | | M/N: MS111-T S/N: CN-0KW2YH-71616-488-1CBJ Input Rating: DC 5V, 0.1A Cable: 1.8m, unshielded CE, FCC, VCCI, KCC, TUV-GS |
| Adapter | : | Model: DZD-5020 |
| | | Input: 100~240Vac 50/60Hz Output: DC 5V, 2000mA |
| TV | : | Manufacturer: SONY |
| | | M/N: KDL-26EX550 S/N: 1012240 CE, FCC: DOC |

1.4. Description of Test Modes

To investigate the maximum EMI emission characteristics generated from EUT, the test system was pre-scanning tested based on the consideration of following EUT operation mode or test configuration mode which possibly have effect on EMI emission level. Each of these EUT operation mode(s) or test configuration mode(s) mentioned above was evaluated respectively.

| Mode | Test channel | Frequency (MHz) |
|------------------------|--------------|-----------------|
| OFDM(802.11a/n20/ac20) | CH 149 | 5745MHz |
| | CH 157 | 5785MHz |
| | CH 165 | 5825MHz |
| OFDM(802.11n40/ac40) | CH 151 | 5755MHz |
| | CH159 | 5795MHz |
| OFDM(802.11ac80) | CH 155 | 5775MHz |

Note:

1. The measurements are performed at the highest, middle, lowest available channels.
2. The EUT has been tested as an independent unit. And Continual Transmitting in maximum power.
3. For the relevant Conducted Measurement, the temporary antenna connector is used during the measurement. Antenna Connector Impedance: 50 Ω , Cable Loss: 1.0 dB
4. The EUT was programmed to be in continuously transmitting mode and the transmit duty cycle is more than 98%

1.5. List of channels

802.11a/n20/ac20

| Channel | Freq. (MHz) | Channel | Freq. (MHz) |
|---------|----------------|---------|----------------|
| 149 | 5745 | 153 | 5765 |
| 157 | 5785 | 161 | 5805 |
| 165 | 5825 | | |

802.11n40/ac40

| Channel | Freq. (MHz) | Channel | Freq. (MHz) |
|---------|----------------|---------|----------------|
| 151 | 5755 | 159 | 5795 |

802.11ac80

| Channel | Freq. (MHz) |
|---------|----------------|
| 155 | 5775 |

1.6. Description Of Test Setup

CE

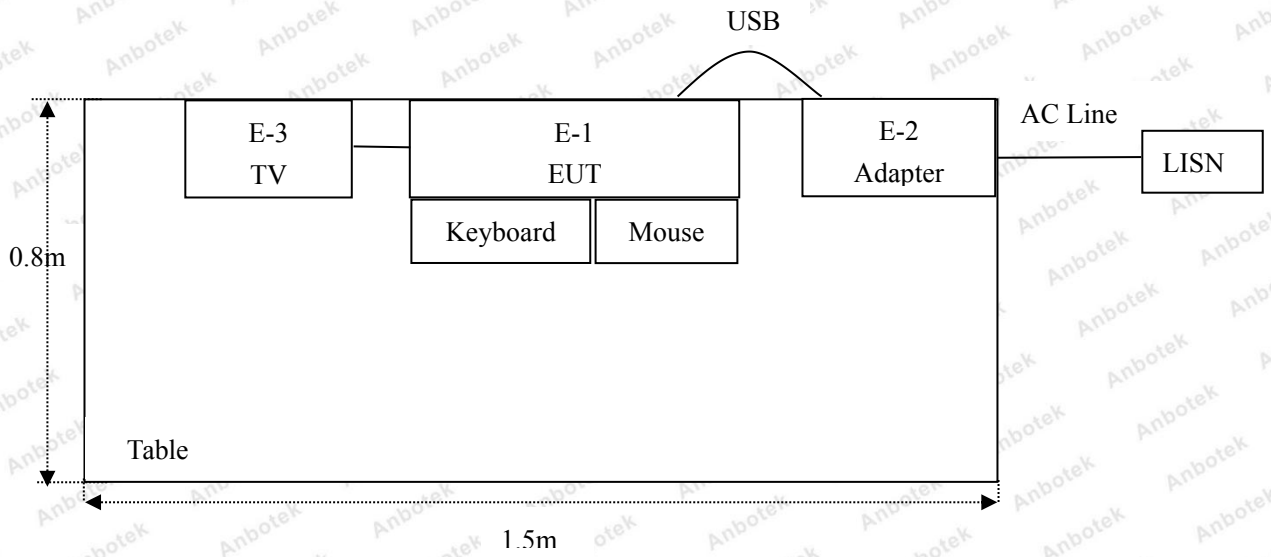

RE

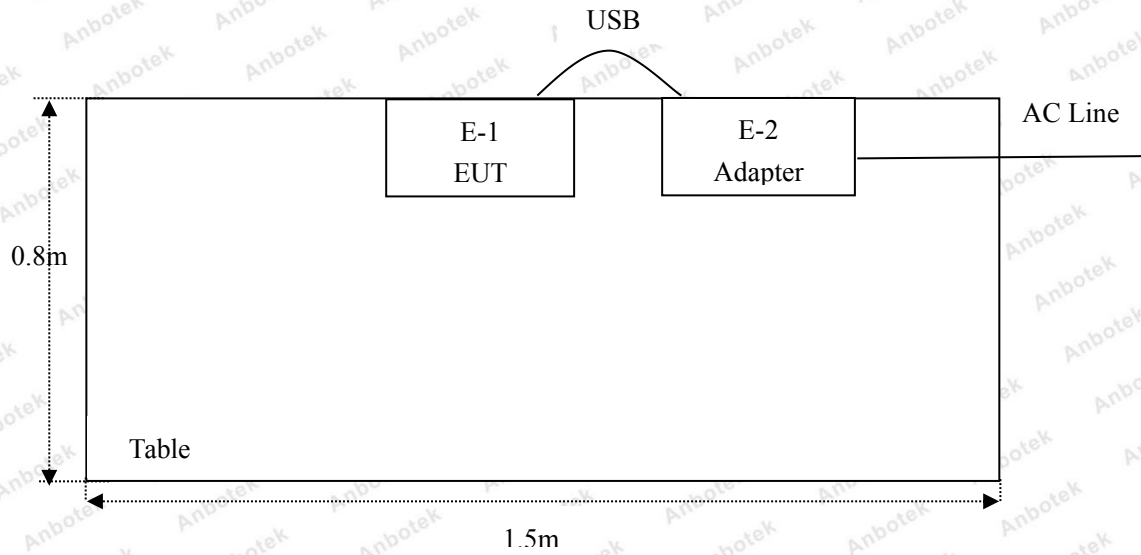

1.7. Test Equipment List

| Item | Equipment | Manufacturer | Model No. | Serial No. | Last Cal. | Cal. Interval |
|------|--|----------------------------|------------|---------------|---------------|---------------|
| 1. | L.I.S.N. Artificial Mains Network | Rohde & Schwarz | ENV216 | 100055 | Nov. 17, 2017 | 1 Year |
| 2. | EMI Test Receiver | Rohde & Schwarz | ESCI | 100627 | Nov. 17, 2017 | 1 Year |
| 3. | RF Switching Unit | Compliance Direction | RSU-M2 | 38303 | Nov. 17, 2017 | 1 Year |
| 4. | Spectrum Analysis | Agilent | E4407B | US39390582 | Nov. 17, 2017 | 1 Year |
| 5. | MAX Spectrum Analysis | Agilent | N9020A | MY51170037 | Nov. 18, 2017 | 1 Year |
| 6. | Preamplifier | SKET Electronic | BK1G18G30D | KD17503 | Nov. 17, 2017 | 1 Year |
| 7. | Double Ridged Horn Antenna | Instruments corporation | GTH-0118 | 351600 | Nov. 20, 2017 | 1 Year |
| 8. | Bilog Broadband Antenna | Schwarzbeck | VULB9163 | VULB 9163-289 | Nov. 20, 2017 | 1 Year |
| 9. | Loop Antenna | Schwarzbeck | HFH2-Z2 | 100047 | Nov. 17, 2017 | 1 Year |
| 10. | Horn Antenna | Schwarzbeck | BBHA9170 | 9170-375 | Nov. 17, 2017 | 1 Year |
| 11. | Pre-amplifier | SONOMA | 310N | 186860 | Nov. 17, 2017 | 1 Year |
| 12. | EMI Test Software EZ-EMC | SHURPLE | N/A | N/A | N/A | N/A |
| 13. | RF Test Control System | YIHENG | YH3000 | 2017430 | Nov. 18, 2017 | 1 Year |
| 14. | Power Sensor | DAER | RPR3006W | 15I00041SN045 | Nov. 17, 2017 | 1 Year |
| 15. | Power Sensor | DAER | RPR3006W | 15I00041SN046 | Nov. 17, 2017 | 1 Year |
| 16. | MXA Spectrum Analysis | Agilent | N9020A | MY51170037 | Nov. 18, 2017 | 1 Year |
| 17. | MXG RF Vector Signal Generator | Agilent | N5182A | MY48180656 | Nov. 18, 2017 | 1 Year |
| 18. | Signal Generator | Agilent | E4421B | MY41000743 | Nov. 18, 2017 | 1 Year |
| 19. | DC Power Supply | LW | TPR-6410D | 349315 | Nov. 01, 2017 | 1 Year |
| 20. | Constant Temperature Humidity Chamber | Sertep | ZJ-HWHS80B | ZJ-17042804 | Nov. 01, 2017 | 1 Year |

1.8. Description of Test Facility

The test facility is recognized, certified, or accredited by the following organizations:

FCC-Designation No.: CN5023

Shenzhen Anbotek Compliance Laboratory Limited, EMC Laboratory has been registered and fully described in a report filed with the (FCC) Federal Communications Commission. The acceptance letter from the FCC is maintained in our files. Designation CN5023, July 31, 2017.

ISED-Registration No.: 8058A-1

Shenzhen Anbotek Compliance Laboratory Limited, EMC Laboratory has been registered and fully described in a report filed with the (ISED) Innovation, Science and Economic Development Canada. The acceptance letter from the ISED is maintained in our files. Registration 8058A-1, June 13, 2016.

Test Location

Shenzhen Anbotek Compliance Laboratory Limited.

1/F, Building D, Sogood Science and Technology Park, Sanwei community, Hangcheng Street, Bao'an District, Shenzhen, Guangdong, China.518102

2. Summary of Test Results

| Standard | Test Type | Result |
|-----------------|--------------------------------|--------|
| 15.207 & 15.407 | Conducted Emission | PASS |
| 15.205/15.209 | Spurious Emission | PASS |
| 15.407(b) | Band Edge | PASS |
| 15.407(a)(5) | Occupancy Bandwidth | PASS |
| 15.407(a)(1)(3) | Maximum Conducted Output Power | PASS |
| 15.407(a)(1)(3) | Peak Power Spectral Density | PASS |
| 15.203/15.407g | Antenna Requirement | PASS |

3. Conducted Emission Test

3.1. Test Standard and Limit

| | | | |
|---------------|----------------------------------|--------------------------------|---------------|
| Test Standard | FCC Part15 Section 15.207&15.407 | | |
| Test Limit | Frequency | Maximum RF Line Voltage (dBuV) | |
| | | Quasi-peak Level | Average Level |
| | 150kHz~500kHz | 66 ~ 56 * | 56 ~ 46 * |
| | 500kHz~5MHz | 56 | 46 |
| | 5MHz~30MHz | 60 | 50 |

Remark: (1) *Decreasing linearly with logarithm of the frequency.
(2) The lower limit shall apply at the transition frequency.

3.2. Test Setup

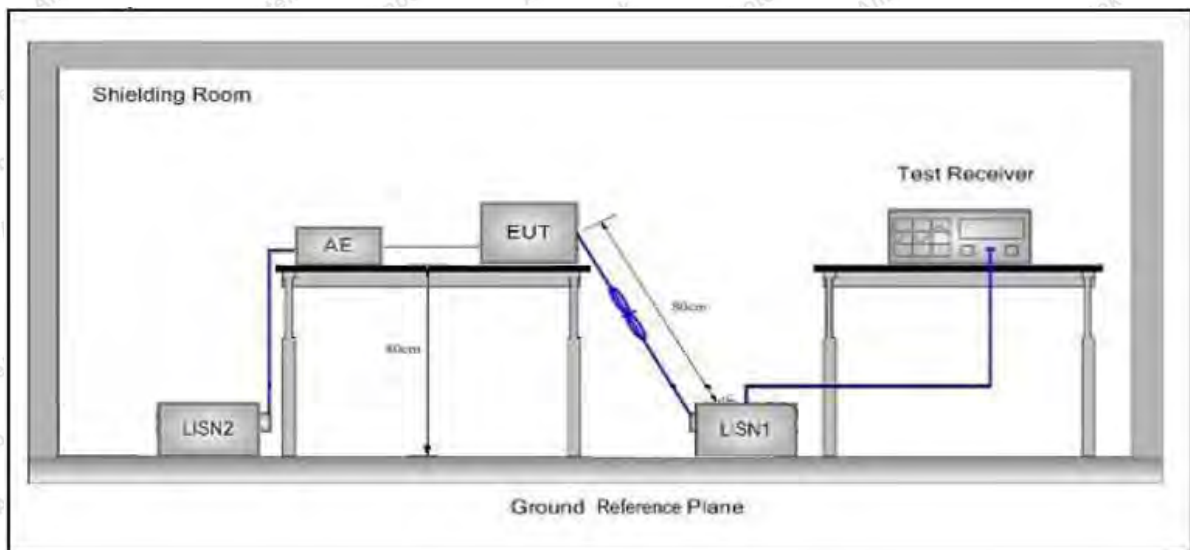

3.3. Test Procedure

The EUT system is connected to the power mains through a line impedance stabilization network (L.I.S.N.). This provides a 50ohm coupling impedance for the EUT system. Please refer the block diagram of the test setup and photographs. Both sides of AC line are checked to find out the maximum conducted emission. In order to find the maximum emission levels, the relative positions of equipment and all of the interface cables shall be changed according to FCC ANSI C63.10-2013 on Conducted Emission Measurement.

The bandwidth of test receiver (ESCI) set at 9kHz.

The frequency range from 150kHz to 30MHz is checked.

3.4. Test Data

Please to see the following pages

Conducted Emission Test Data

Test Site: 1# Shielded Room
 Operating Condition: Keeping TX mode
 Test Specification: AC 240V, 60Hz for adapter
 Comment: Live Line
 Tem.: 24.3°C Hum.: 58%

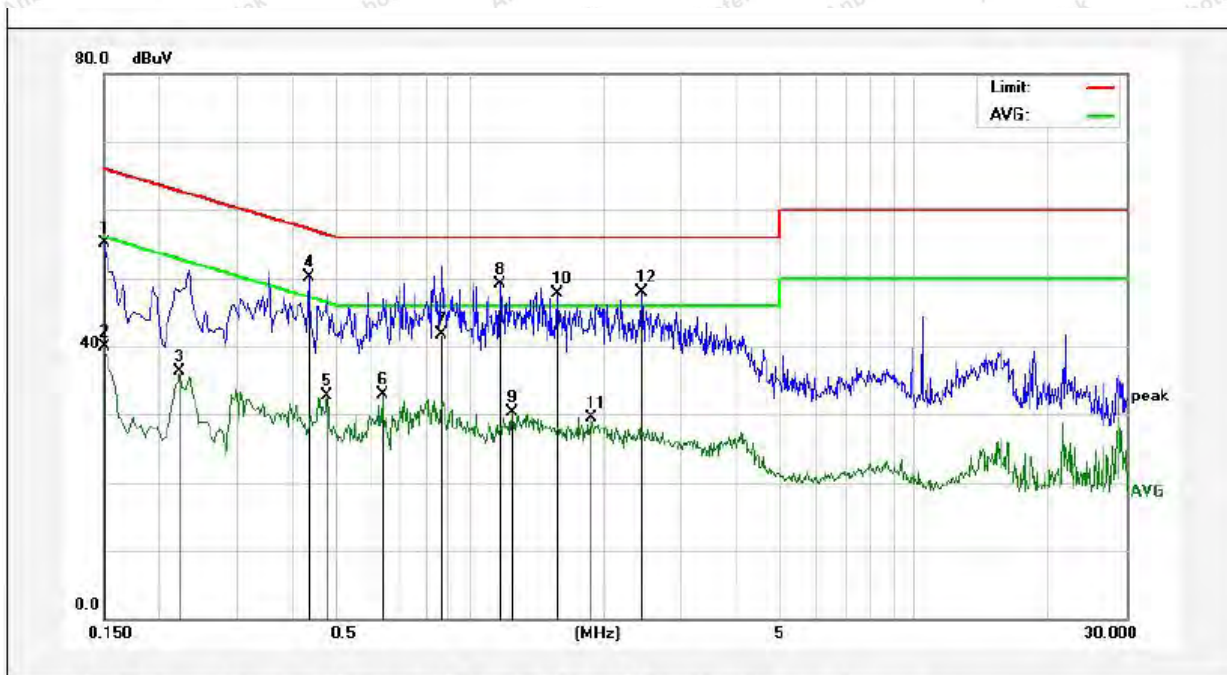

| No. | Freq. (MHz) | Reading (dBuV) | Factor (dB) | Result (dBuV) | Limit dBuV | Over Limit (dB) | Detector | Remark |
|-----|-------------|----------------|-------------|---------------|------------|-----------------|----------|--------|
| 1 | 0.1500 | 35.26 | 19.90 | 55.16 | 65.99 | -10.83 | QP | |
| 2 | 0.1500 | 19.95 | 19.90 | 39.85 | 55.99 | -16.14 | AVG | |
| 3 | 0.2220 | 16.35 | 19.89 | 36.24 | 52.74 | -16.50 | AVG | |
| 4 | 0.4340 | 30.25 | 19.95 | 50.20 | 57.18 | -6.98 | QP | |
| 5 | 0.4780 | 12.68 | 19.97 | 32.65 | 46.37 | -13.72 | AVG | |
| 6 | 0.6340 | 12.92 | 20.02 | 32.94 | 46.00 | -13.06 | AVG | |
| 7 | 0.8660 | 21.54 | 20.08 | 41.62 | 56.00 | -14.38 | QP | |
| 8 | 1.1700 | 28.96 | 20.12 | 49.08 | 56.00 | -6.92 | QP | |
| 9 | 1.2460 | 10.18 | 20.12 | 30.30 | 46.00 | -15.70 | AVG | |
| 10 | 1.5700 | 27.60 | 20.13 | 47.73 | 56.00 | -8.27 | QP | |
| 11 | 1.8740 | 9.44 | 20.14 | 29.58 | 46.00 | -16.42 | AVG | |
| 12 | 2.4420 | 27.68 | 20.15 | 47.83 | 56.00 | -8.17 | QP | |

Conducted Emission Test Data

Test Site: 1# Shielded Room
 Operating Condition: Keeping TX mode
 Test Specification: AC 240V, 60Hz for adapter
 Comment: Neutral Line
 Tem.: 24.3°C Hum.: 58%

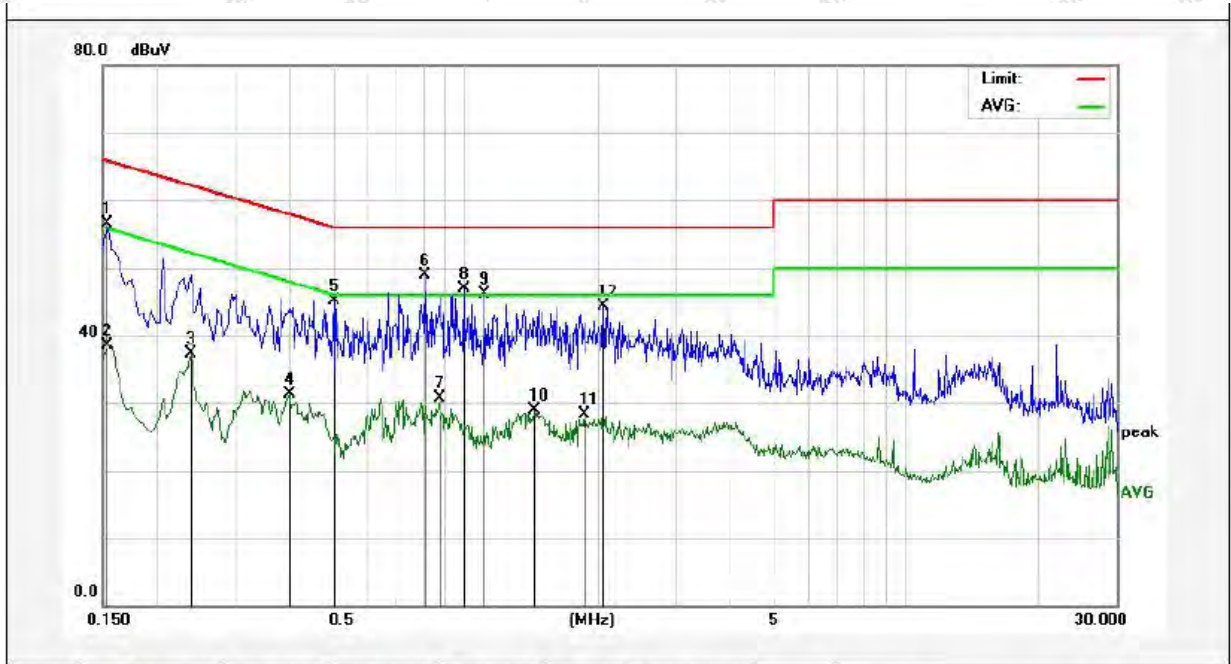

| No. | Freq. (MHz) | Reading (dBuV) | Factor (dB) | Result (dBuV) | Limit dBuV | Over Limit (dB) | Detector | Remark |
|-----|-------------|----------------|-------------|---------------|------------|-----------------|----------|--------|
| 1 | 0.1539 | 36.65 | 19.90 | 56.55 | 65.78 | -9.23 | QP | |
| 2 | 0.1539 | 18.69 | 19.90 | 38.59 | 55.78 | -17.19 | AVG | |
| 3 | 0.2380 | 17.32 | 19.89 | 37.21 | 52.16 | -14.95 | AVG | |
| 4 | 0.3980 | 11.37 | 19.93 | 31.30 | 47.89 | -16.59 | AVG | |
| 5 | 0.5020 | 25.11 | 19.98 | 45.09 | 56.00 | -10.91 | QP | |
| 6 | 0.8100 | 28.81 | 20.07 | 48.88 | 56.00 | -7.12 | QP | |
| 7 | 0.8740 | 10.70 | 20.09 | 30.79 | 46.00 | -15.21 | AVG | |
| 8 | 0.9940 | 26.69 | 20.12 | 46.81 | 56.00 | -9.19 | QP | |
| 9 | 1.1060 | 25.92 | 20.12 | 46.04 | 56.00 | -9.96 | QP | |
| 10 | 1.4380 | 8.81 | 20.13 | 28.94 | 46.00 | -17.06 | AVG | |
| 11 | 1.8620 | 8.09 | 20.14 | 28.23 | 46.00 | -17.77 | AVG | |
| 12 | 2.0579 | 24.25 | 20.14 | 44.39 | 56.00 | -11.61 | QP | |

Conducted Emission Test Data

Test Site: 1# Shielded Room
 Operating Condition: Keeping TX mode
 Test Specification: AC 120V, 60Hz via adapter
 Comment: Live Line
 Tem.: 24.3°C Hum.: 58%

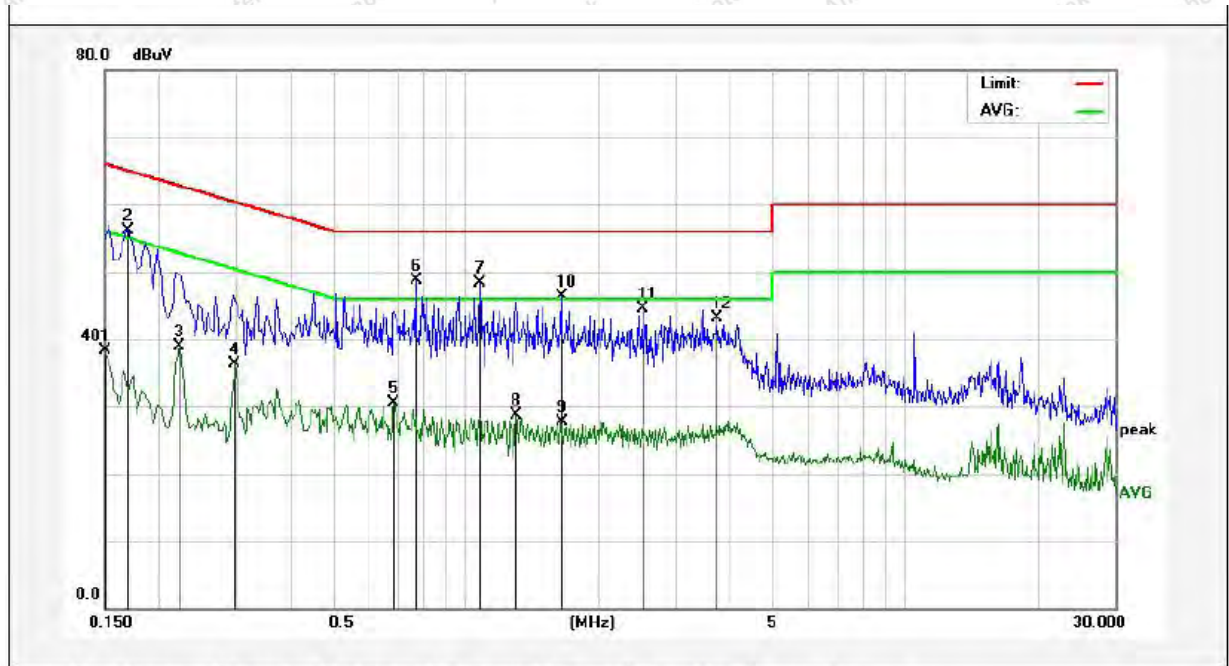

| No. | Freq. (MHz) | Reading (dBuV) | Factor (dB) | Result (dBuV) | Limit dBuV | Over Limit (dB) | Detector | Remark |
|-----|-------------|----------------|-------------|---------------|------------|-----------------|----------|--------|
| 1 | 0.1500 | 18.34 | 19.90 | 38.24 | 55.99 | -17.75 | AVG | |
| 2 | 0.1700 | 36.30 | 19.90 | 56.20 | 64.96 | -8.76 | QP | |
| 3 | 0.2220 | 19.11 | 19.89 | 39.00 | 52.74 | -13.74 | AVG | |
| 4 | 0.2980 | 16.38 | 19.89 | 36.27 | 50.30 | -14.03 | AVG | |
| 5 | 0.6860 | 10.48 | 20.04 | 30.52 | 46.00 | -15.48 | AVG | |
| 6 | 0.7700 | 28.57 | 20.06 | 48.63 | 56.00 | -7.37 | QP | |
| 7 | 1.0740 | 28.25 | 20.12 | 48.37 | 56.00 | -7.63 | QP | |
| 8 | 1.2980 | 8.57 | 20.13 | 28.70 | 46.00 | -17.30 | AVG | |
| 9 | 1.6380 | 7.61 | 20.13 | 27.74 | 46.00 | -18.26 | AVG | |
| 10 | 1.6460 | 26.11 | 20.13 | 46.24 | 56.00 | -9.76 | QP | |
| 11 | 2.5140 | 24.30 | 20.15 | 44.45 | 56.00 | -11.55 | QP | |
| 12 | 3.7380 | 22.88 | 20.17 | 43.05 | 56.00 | -12.95 | QP | |

Conducted Emission Test Data

Test Site: 1# Shielded Room
 Operating Condition: Keeping TX mode
 Test Specification: AC 120V, 60Hz via adapter
 Comment: Neutral Line
 Tem.: 24.3°C Hum.: 58%

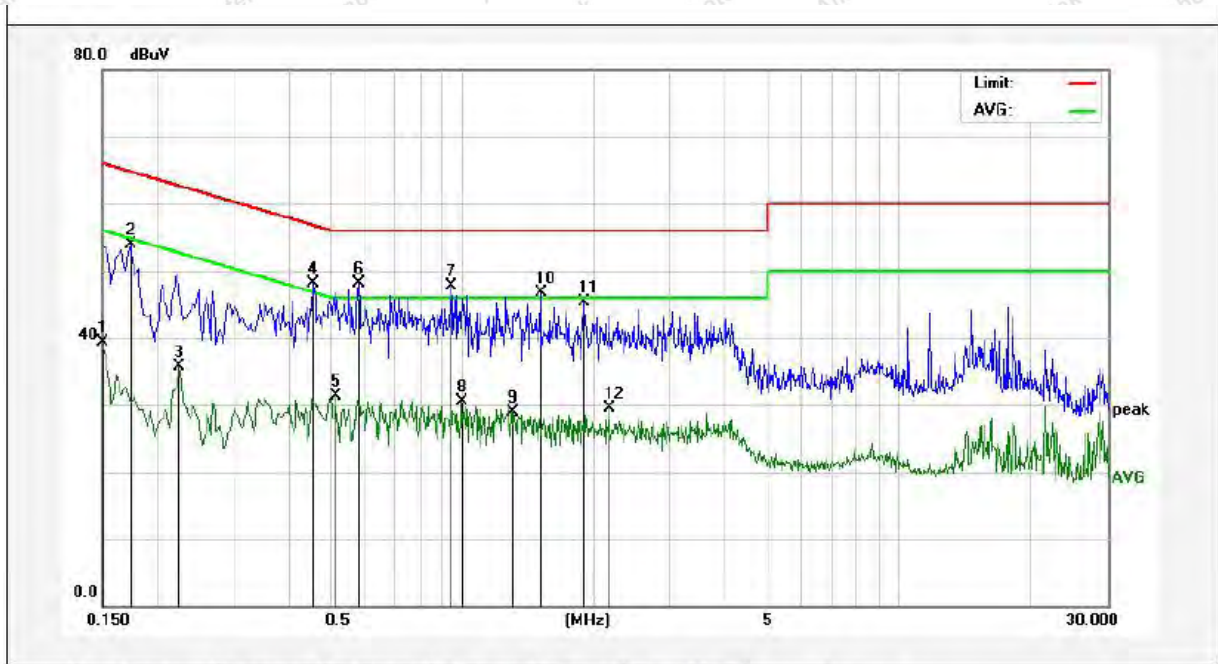

| No. | Freq. (MHz) | Reading (dBuV) | Factor (dB) | Result (dBuV) | Limit dBuV | Over Limit (dB) | Detector | Remark |
|-----|-------------|----------------|-------------|---------------|------------|-----------------|----------|--------|
| 1 | 0.1500 | 19.42 | 19.90 | 39.32 | 55.99 | -16.67 | AVG | |
| 2 | 0.1740 | 34.08 | 19.90 | 53.98 | 64.76 | -10.78 | QP | |
| 3 | 0.2260 | 15.81 | 19.89 | 35.70 | 52.59 | -16.89 | AVG | |
| 4 | 0.4580 | 28.09 | 19.96 | 48.05 | 56.73 | -8.68 | QP | |
| 5 | 0.5140 | 11.33 | 19.98 | 31.31 | 46.00 | -14.69 | AVG | |
| 6 | 0.5820 | 28.10 | 20.00 | 48.10 | 56.00 | -7.90 | QP | |
| 7 | 0.9460 | 27.58 | 20.11 | 47.69 | 56.00 | -8.31 | QP | |
| 8 | 0.9980 | 10.29 | 20.12 | 30.41 | 46.00 | -15.59 | AVG | |
| 9 | 1.3140 | 8.87 | 20.13 | 29.00 | 46.00 | -17.00 | AVG | |
| 10 | 1.5140 | 26.48 | 20.13 | 46.61 | 56.00 | -9.39 | QP | |
| 11 | 1.9020 | 25.13 | 20.14 | 45.27 | 56.00 | -10.73 | QP | |
| 12 | 2.1700 | 9.41 | 20.14 | 29.55 | 46.00 | -16.45 | AVG | |

4. Radiation Spurious Emission and Band Edge

4.1. Test Standard and Limit

| | |
|---------------|---|
| Test Standard | FCC Part15 C Section 15.209, 15.205 and 15.407, KDB 789033 D02 General UNII Test Procedures New Rules v01r04 |
|---------------|---|

Unwanted spurious emissions fallen in restricted bands per FCC Part15.205 shall comply with the general field strength limits set forth in § 15.209 as below table,

| | Frequency (MHz) | Field strength (microvolt/meter) | Limit (dBuV/m) | Remark | Measurement distance (m) |
|------------|-------------------|----------------------------------|----------------|------------|--------------------------|
| Test Limit | 0.009MHz~0.490MHz | 2400/F(kHz) | - | - | 300 |
| | 0.490MHz-1.705MHz | 24000/F(kHz) | - | - | 30 |
| | 1.705MHz-30MHz | 30 | - | - | 30 |
| | 30MHz~88MHz | 100 | 40.0 | Quasi-peak | 3 |
| | 88MHz~216MHz | 150 | 43.5 | Quasi-peak | 3 |
| | 216MHz~960MHz | 200 | 46.0 | Quasi-peak | 3 |
| | 960MHz~1000MHz | 500 | 54.0 | Quasi-peak | 3 |
| | Above 1000MHz | 500 | 54.0 | Average | 3 |

Remark:

- (1)The lower limit shall apply at the transition frequency.
- (2) 15.35(b), Unless otherwise specified, the limit on peak radio frequency emissions is 20dB above the maximum permitted average emission limit applicable to the equipment under test. This peak limit applies to the total peak emission level radiated by the device.
- (3) Above 1GHz limit: $E[\text{dB}\mu\text{V}/\text{m}] = \text{EIRP}[\text{dBm}] + 95.2 = 68.2 \text{ dB}\mu\text{V}/\text{m}$, for $\text{EIPR}[\text{dBm}] = -27\text{dBm}$.

For transmitters operating in the 5.725-5.85GHz band:

15.407(b)(4)(i) All emissions shall be limited to a level of -27dBm/MHz at 75MHz or more above or below the band edge increasing linearly to 10dBm/MHz at 25MHz above or below the band edge, and from 25MHz above or below the band edge increasing linearly to a level of 15.6dBm/MHz at 5MHz above or below the band edge, and from 5MHz above or below the band edge increasing linearly to a level of 27dBm/MHz at the band edge.

KDB789033 D02 v01r04 (G)(2)(c)

(i) Sections 15.407(b)(1) to (b)(3) specify the unwanted emission limits for the U-NII-1 and U-NII-2 bands. As specified, emissions above 1000 MHz that are outside of the restricted bands are subject to a peak emission limit of -27dBm/MHz.³

(ii) Section 15.407(b)(4) specifies the unwanted emission limit for the U-NII-3 band. A band emissions mask is specified in Section 15.407(b)(4)(i). The emission limits are in terms of a Peak detector. An alternative to the band emissions mask is specified in Section 15.407(b)(4)(ii). The alternative limits are based on the highest antenna gain specified in the filing. There are also marketing and importation restrictions for the devices using the alternative limit.⁴

Note 3: An out-of-band emission that complies with both the average and peak limits of Section 15.209 is not required to satisfy the -27 dBm/MHz peak emission limit.

Note 4: Only devices with antenna gains of 10 dBi or less may be approved using the emission limits specified in Section 15.247(d) till March 2, 2018; all other devices operating in this band must use the mask specified in Section 15.407(b)(4)(i).

4.2. Test Setup

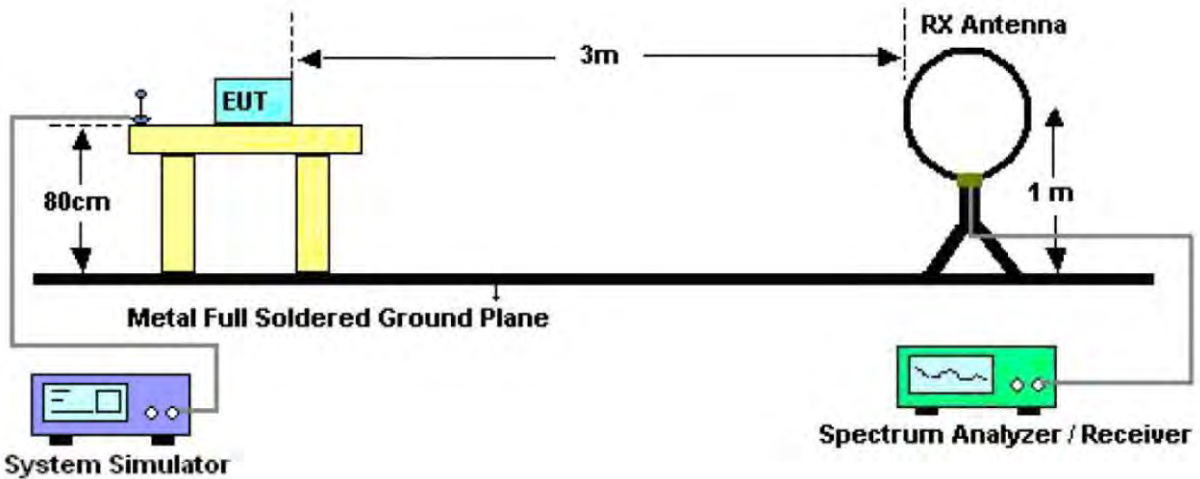

Figure 1. Below 30MHz

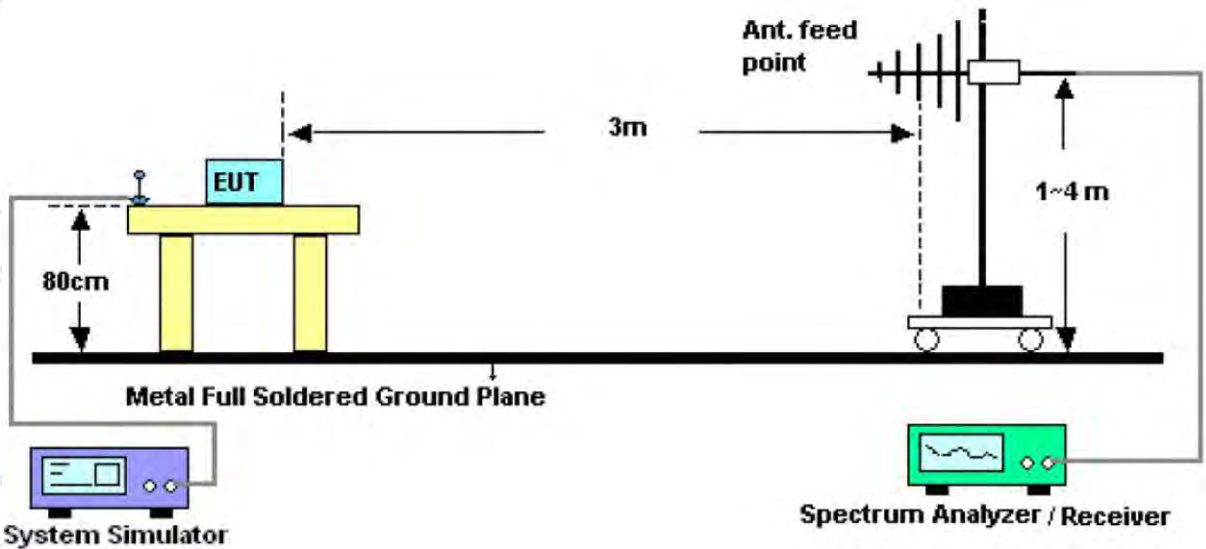

Figure 2. 30MHz to 1GHz

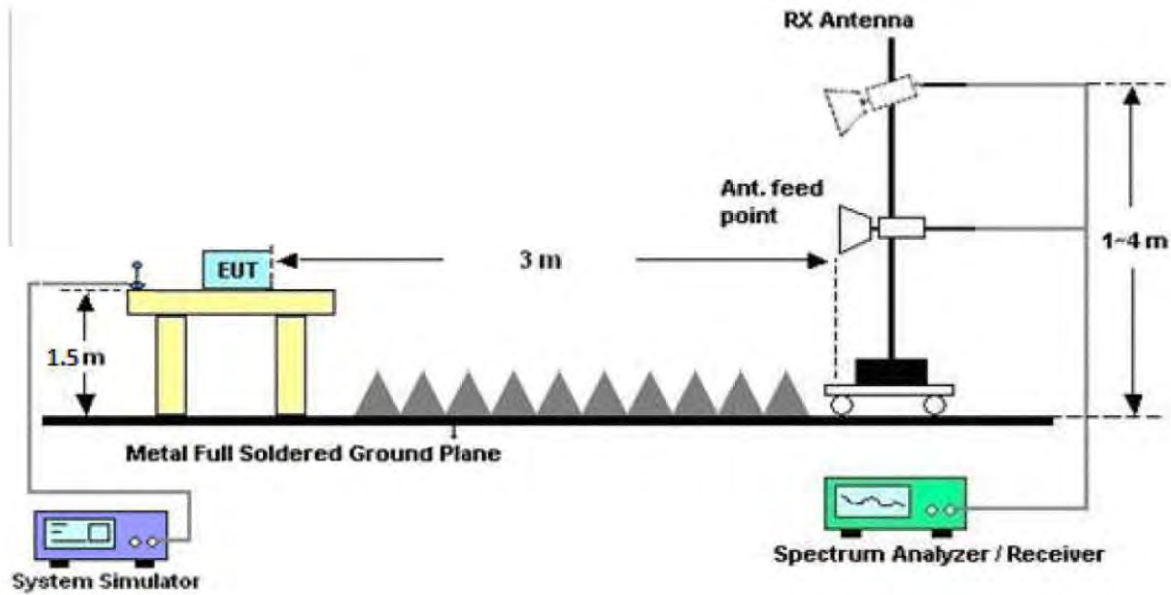

Figure 3. Above 1 GHz

4.3. Test Procedure

For below 1GHz: The EUT is placed on a turntable, which is 0.8m above the ground plane.

For above 1GHz: The EUT is placed on a turntable, which is 1.5m above the ground plane.

The turn table can rotate 360 degrees to determine the position of the maximum emission level. The EUT is set 3 meters away from the receiving antenna which is mounted on a antenna tower. The antenna can be moved up and down from 1 to 4 meters to find out the maximum emission level. Rotated the EUT through three orthogonal axes to determine the maximum emissions, both horizontal and vertical polarization of the antenna are set on test. The EUT is tested in 9*6*6 Chamber. The device is evaluated in xyz orientation.

For 9kHz to 150kHz, Set the spectrum analyzer as:

RBW = 200Hz, VBW =1kHz, Detector= Quasi-Peak, Trace mode= Max hold, Sweep- auto couple.

For 150kHz to 30MHz, Set the spectrum analyzer as:

RBW = 9KHz, VBW =30kHz, Detector= Quasi-Peak, Trace mode= Max hold, Sweep- auto couple.

For 30MHz to 1000MHz, Set the spectrum analyzer as:

RBW = 100kHz, VBW =300kHz, Detector= Quasi-Peak, Trace mode= Max hold, Sweep- auto couple.

For above 1GHz, Set the spectrum analyzer as:

RBW =1MHz, VBW =1MHz, Detector= Peak, Trace mode= Max hold, Sweep- auto couple.

RBW =1MHz, VBW =10Hz, Detector= Average, Trace mode= Max hold, Sweep- auto couple.

4.4. Test Data

PASS

The test results of 9kHz-30MHz and above 18000MHz are attenuated more than 20dB below the permissible limits, so the results don't record in the report.

Test Results (30~1000MHz)

Job No.: SZAWW180831003-01 Temp.(°C)/Hum.(%RH): 24.3°C/55%RH
 Standard: FCC PART 15C Power Source: AC 240V, 60Hz for adapter
 Test Mode: Keeping TX mode Polarization: Horizontal

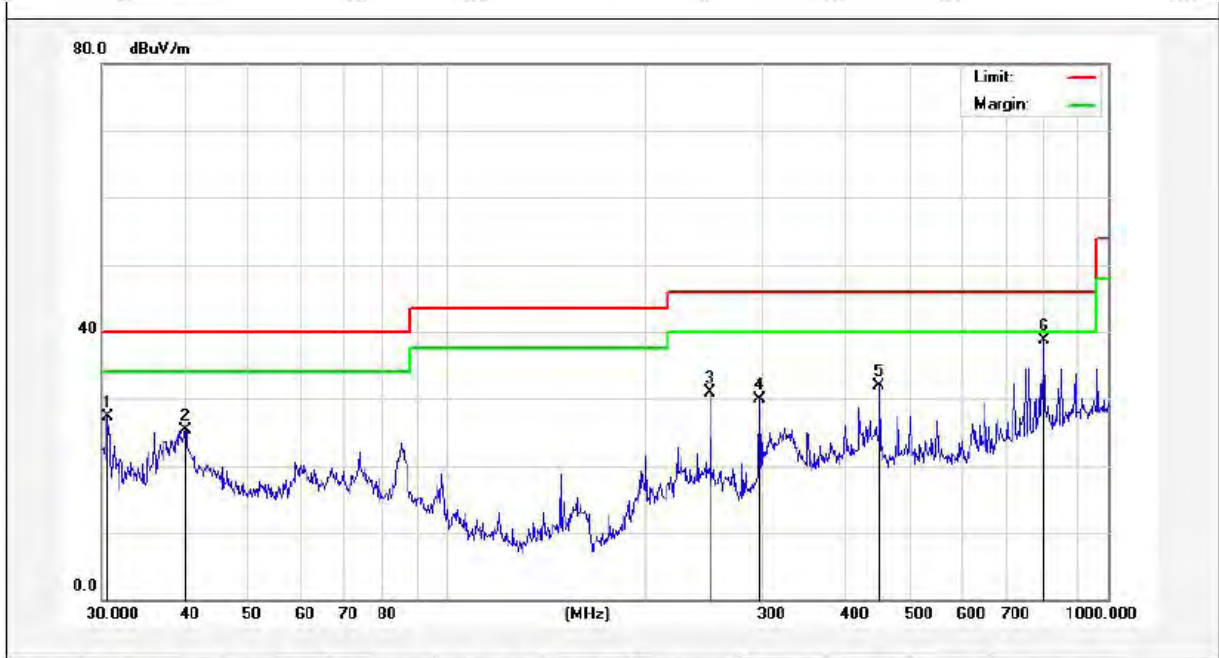

| No. | Freq. (MHz) | Reading (dBuV/m) | Factor (dB/m) | Result (dBuV/m) | Limit (dBuV/) | Over Limit (dB) | Detector | Height (cm) | degree (deg) | Remark |
|-----|-------------|------------------|---------------|-----------------|---------------|-----------------|----------|-------------|--------------|--------|
| 1 | 30.6379 | 43.85 | -16.61 | 27.24 | 40.00 | -12.76 | QP | 300 | 12 | |
| 2 | 40.1347 | 35.78 | -10.42 | 25.36 | 40.00 | -14.64 | QP | 300 | 41 | |
| 3 | 250.3012 | 49.45 | -18.56 | 30.89 | 46.00 | -15.11 | QP | 300 | 227 | |
| 4 | 297.2241 | 47.64 | -17.76 | 29.88 | 46.00 | -16.12 | QP | 300 | 304 | |
| 5 | 451.1350 | 44.15 | -12.15 | 32.00 | 46.00 | -14.00 | QP | 300 | 247 | |
| 6 | 801.7863 | 45.22 | -6.54 | 38.68 | 46.00 | -7.32 | QP | 300 | 330 | |

Test Results (30~1000MHz)

Job No.: SZAWW180831003-01 Temp.(°C)/Hum.(%RH): 24.3°C/55%RH
 Standard: FCC PART 15C Power Source: AC 240V, 60Hz for adapter
 Test Mode: Keeping TX mode Polarization: Vertical



| No. | Freq. (MHz) | Reading (dBUV/m) | Factor (dB/m) | Result (dBUV/m) | Limit (dBUV/) | Over Limit (dB) | Detector | Height (cm) | degree (deg) | Remark |
|-----|-------------|------------------|---------------|-----------------|---------------|-----------------|----------|-------------|--------------|--------|
| 1 | 39.9942 | 47.04 | -10.37 | 36.67 | 40.00 | -3.33 | QP | 300 | 1 | |
| 2 | 59.8588 | 40.72 | -15.38 | 25.34 | 40.00 | -14.66 | QP | 300 | 117 | |
| 3 | 98.1419 | 38.00 | -15.86 | 22.14 | 43.50 | -21.36 | QP | 300 | 235 | |
| 4 | 199.9856 | 43.23 | -15.87 | 27.36 | 43.50 | -16.14 | QP | 300 | 181 | |
| 5 | 250.3012 | 46.93 | -14.04 | 32.89 | 46.00 | -13.11 | QP | 300 | 338 | |
| 6 | 297.2241 | 49.81 | -14.76 | 35.05 | 46.00 | -10.95 | QP | 300 | 314 | |

Test Results (30~1000MHz)

Job No.: SZAWW180831003-01 Temp.(°C)/Hum.(%RH): 24.3°C/55%RH
 Standard: FCC PART 15C Power Source: AC 120V, 60Hz for adapter
 Test Mode: Keeping TX mode Polarization: Horizontal

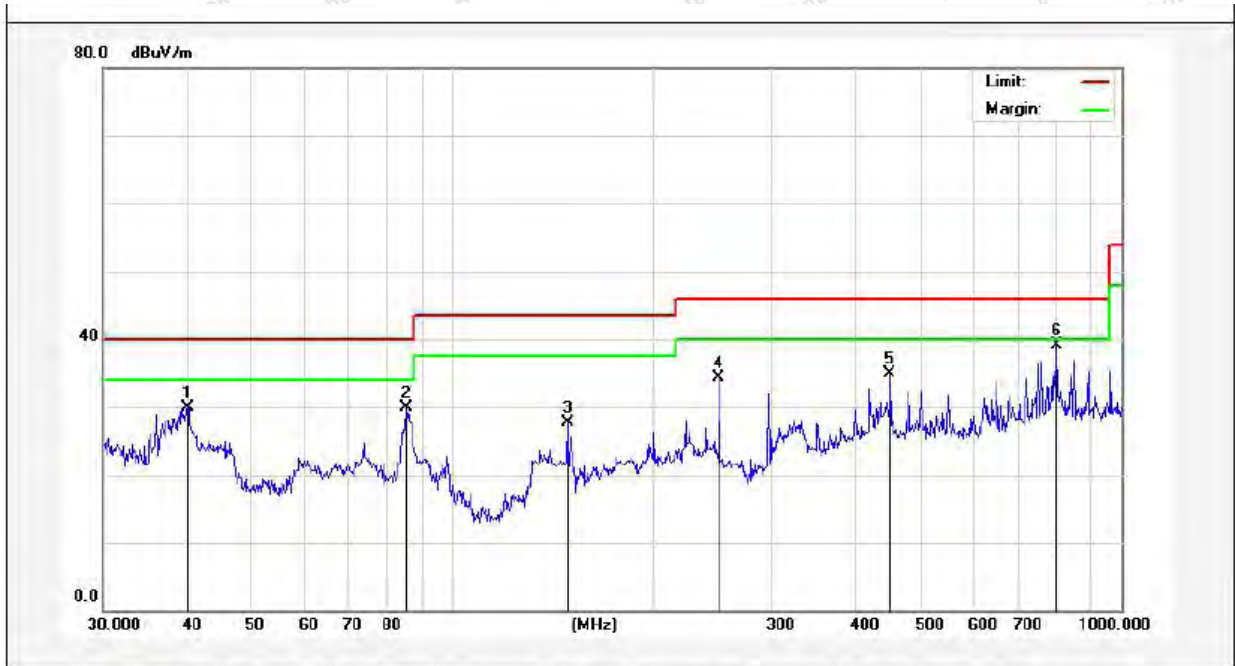

| No. | Freq. (MHz) | Reading (dBuV/m) | Factor (dB/m) | Result (dBuV/m) | Limit (dBuV/) | Over Limit (dB) | Detector | Height (cm) | degree (deg) | Remark |
|-----|-------------|------------------|---------------|-----------------|---------------|-----------------|----------|-------------|--------------|--------|
| 1 | 40.1347 | 40.28 | -10.42 | 29.86 | 40.00 | -10.14 | QP | 300 | 33 | |
| 2 | 85.2980 | 50.38 | -20.49 | 29.89 | 40.00 | -10.11 | QP | 300 | 85 | |
| 3 | 148.4410 | 51.00 | -23.36 | 27.64 | 43.50 | -15.86 | QP | 300 | 342 | |
| 4 | 250.3011 | 52.95 | -18.56 | 34.39 | 46.00 | -11.61 | QP | 300 | 241 | |
| 5 | 451.1349 | 47.15 | -12.15 | 35.00 | 46.00 | -11.00 | QP | 300 | 168 | |
| 6 | 801.7862 | 45.72 | -6.54 | 39.18 | 46.00 | -6.82 | QP | 300 | 53 | |

Test Results (30~1000MHz)

Job No.: SZAWW180831003-01 Temp.(°C)/Hum.(%RH): 24.3°C/55%RH
 Standard: FCC PART 15C Power Source: AC 120V, 60Hz for adapter
 Test Mode: Keeping TX mode Polarization: Vertical



| No. | Freq. (MHz) | Reading (dBuV/m) | Factor (dB/m) | Result (dBuV/m) | Limit (dBuV/m) | Over Limit (dB) | Detector | Height (cm) | degree (deg) | Remark |
|-----|-------------|------------------|---------------|-----------------|----------------|-----------------|----------|-------------|--------------|--------|
| 1 | 39.8541 | 46.97 | -10.49 | 36.48 | 40.00 | -3.52 | QP | 300 | 0 | |
| 2 | 68.3907 | 50.21 | -18.93 | 31.28 | 40.00 | -8.72 | QP | 300 | 35 | |
| 3 | 250.3011 | 52.43 | -14.04 | 38.39 | 46.00 | -7.61 | QP | 300 | 88 | |
| 4 | 297.2241 | 52.81 | -14.76 | 38.05 | 46.00 | -7.95 | QP | 300 | 175 | |
| 5 | 480.5276 | 45.83 | -11.53 | 34.30 | 46.00 | -11.70 | QP | 300 | 281 | |
| 6 | 625.0779 | 47.40 | -9.05 | 38.35 | 46.00 | -7.65 | QP | 300 | 336 | |

Test Results (Above 1000MHz)

| | | | |
|------------|--------------|---------------|--------|
| Test mode: | IEEE 802.11a | Test channel: | Low CH |
|------------|--------------|---------------|--------|

Peak value:

| Frequency (MHz) | Read Level (dBuV) | Antenna Factor (dB/m) | Cable Loss (dB) | Preamp Factor (dB) | Level (dBuV/m) | Limit Line (dBuV/m) | Over Limit (dB) | Pol. |
|-----------------|-------------------|-----------------------|-----------------|--------------------|----------------|---------------------|-----------------|------|
| 11490.00 | 42.32 | 31.98 | 17.08 | 33.91 | 57.47 | 74.00 | -16.53 | V |
| 17235.00 | 35.02 | 32.65 | 20.03 | 34.85 | 52.85 | 68.20 | -15.35 | V |
| 11490.00 | 37.65 | 31.98 | 17.08 | 33.91 | 52.80 | 74.00 | -21.20 | H |
| 17235.00 | 35.78 | 32.65 | 20.03 | 34.85 | 53.61 | 68.20 | -14.59 | H |

Average value:

| Frequency (MHz) | Read Level (dBuV) | Antenna Factor (dB/m) | Cable Loss (dB) | Preamp Factor (dB) | Level (dBuV/m) | Limit Line (dBuV/m) | Over Limit (dB) | Pol. |
|-----------------|-------------------|-----------------------|-----------------|--------------------|----------------|---------------------|-----------------|------|
| 11490.00 | 31.32 | 31.98 | 17.08 | 33.91 | 46.47 | 54.00 | -7.53 | V |
| 17235.00 | 28.35 | 32.65 | 20.03 | 34.85 | 46.18 | 54.00 | -7.82 | V |
| 11490.00 | 28.31 | 31.98 | 17.08 | 33.91 | 43.46 | 54.00 | -10.54 | H |
| 17235.00 | 27.36 | 32.65 | 20.03 | 34.85 | 45.19 | 54.00 | -8.81 | H |

| | | | |
|------------|--------------|---------------|--------|
| Test mode: | IEEE 802.11a | Test channel: | Mid CH |
|------------|--------------|---------------|--------|

Peak value:

| Frequency (MHz) | Read Level (dBuV) | Antenna Factor (dB/m) | Cable Loss (dB) | Preamp Factor (dB) | Level (dBuV/m) | Limit Line (dBuV/m) | Over Limit (dB) | Pol. |
|-----------------|-------------------|-----------------------|-----------------|--------------------|----------------|---------------------|-----------------|------|
| 11570.00 | 40.06 | 32.44 | 17.18 | 33.91 | 55.77 | 74.00 | -18.23 | V |
| 17355.00 | 36.45 | 32.78 | 20.12 | 34.86 | 54.49 | 68.20 | -13.71 | V |
| 11570.00 | 38.53 | 32.44 | 17.18 | 33.91 | 54.24 | 74.00 | -19.76 | H |
| 17355.00 | 35.96 | 32.78 | 20.12 | 34.86 | 54.00 | 68.20 | -14.20 | H |

Average value:

| Frequency (MHz) | Read Level (dBuV) | Antenna Factor (dB/m) | Cable Loss (dB) | Preamp Factor (dB) | Level (dBuV/m) | Limit Line (dBuV/m) | Over Limit (dB) | Pol. |
|-----------------|-------------------|-----------------------|-----------------|--------------------|----------------|---------------------|-----------------|------|
| 11570.00 | 30.02 | 32.44 | 17.18 | 33.91 | 45.73 | 54.00 | -8.27 | V |
| 17355.00 | 28.36 | 32.78 | 20.12 | 34.86 | 46.40 | 54.00 | -7.60 | V |
| 11570.00 | 30.01 | 32.44 | 17.18 | 33.91 | 45.72 | 54.00 | -8.28 | H |
| 17355.00 | 29.34 | 32.78 | 20.12 | 34.86 | 47.38 | 54.00 | -6.62 | H |

| | | | |
|------------|--------------|---------------|---------|
| Test mode: | IEEE 802.11a | Test channel: | High CH |
|------------|--------------|---------------|---------|

Peak value:

| Frequency (MHz) | Read Level (dBuV) | Antenna Factor (dB/m) | Cable Loss (dB) | Preamp Factor (dB) | Level (dBuV/m) | Limit Line (dBuV/m) | Over Limit (dB) | Pol. |
|-----------------|-------------------|-----------------------|-----------------|--------------------|----------------|---------------------|-----------------|------|
| 11650.00 | 40.06 | 32.59 | 18.02 | 33.92 | 56.75 | 74.00 | -17.25 | V |
| 17475.00 | 39.25 | 32.87 | 20.15 | 34.88 | 57.39 | 68.20 | -10.81 | V |
| 11650.00 | 41.32 | 32.59 | 18.02 | 33.92 | 58.01 | 74.00 | -15.99 | H |
| 17475.00 | 40.21 | 32.87 | 20.15 | 34.88 | 58.35 | 68.20 | -9.85 | H |

Average value:

| Frequency (MHz) | Read Level (dBuV) | Antenna Factor (dB/m) | Cable Loss (dB) | Preamp Factor (dB) | Level (dBuV/m) | Limit Line (dBuV/m) | Over Limit (dB) | Pol. |
|-----------------|-------------------|-----------------------|-----------------|--------------------|----------------|---------------------|-----------------|------|
| 11650.00 | 30.21 | 32.59 | 18.02 | 33.92 | 46.90 | 54.00 | -7.10 | V |
| 17475.00 | 30.11 | 32.87 | 20.15 | 34.88 | 48.25 | 54.00 | -5.75 | V |
| 11650.00 | 29.65 | 32.59 | 18.02 | 33.92 | 46.34 | 54.00 | -7.66 | H |
| 17475.00 | 29.35 | 32.87 | 20.15 | 34.88 | 47.49 | 54.00 | -6.51 | H |

| | | | |
|------------|--------------------|---------------|--------|
| Test mode: | IEEE 802.11n(HT20) | Test channel: | Low CH |
|------------|--------------------|---------------|--------|

Peak value:

| Frequency (MHz) | Read Level (dBuV) | Antenna Factor (dB/m) | Cable Loss (dB) | Preamp Factor (dB) | Level (dBuV/m) | Limit Line (dBuV/m) | Over Limit (dB) | Pol. |
|-----------------|-------------------|-----------------------|-----------------|--------------------|----------------|---------------------|-----------------|------|
| 11490.00 | 39.81 | 31.98 | 17.08 | 33.91 | 54.96 | 74.00 | -19.04 | V |
| 17235.00 | 36.21 | 32.65 | 20.03 | 34.85 | 54.04 | 68.20 | -14.16 | V |
| 11490.00 | 37.15 | 31.98 | 17.08 | 33.91 | 52.30 | 74.00 | -21.70 | H |
| 17235.00 | 36.25 | 32.65 | 20.03 | 34.85 | 54.08 | 68.20 | -14.12 | H |

Average value:

| Frequency (MHz) | Read Level (dBuV) | Antenna Factor (dB/m) | Cable Loss (dB) | Preamp Factor (dB) | Level (dBuV/m) | Limit Line (dBuV/m) | Over Limit (dB) | Pol. |
|-----------------|-------------------|-----------------------|-----------------|--------------------|----------------|---------------------|-----------------|------|
| 11490.00 | 31.12 | 31.98 | 17.08 | 33.91 | 46.27 | 54.00 | -7.73 | V |
| 17235.00 | 28.32 | 32.65 | 20.03 | 34.85 | 46.15 | 54.00 | -7.85 | V |
| 11490.00 | 30.57 | 31.98 | 17.08 | 33.91 | 45.72 | 54.00 | -8.28 | H |
| 17235.00 | 28.35 | 32.65 | 20.03 | 34.85 | 46.18 | 54.00 | -7.82 | H |

| | | | |
|------------|--------------------|---------------|--------|
| Test mode: | IEEE 802.11n(HT20) | Test channel: | Mid CH |
|------------|--------------------|---------------|--------|

Peak value:

| Frequency (MHz) | Read Level (dBuV) | Antenna Factor (dB/m) | Cable Loss (dB) | Preamp Factor (dB) | Level (dBuV/m) | Limit Line (dBuV/m) | Over Limit (dB) | Pol. |
|-----------------|-------------------|-----------------------|-----------------|--------------------|----------------|---------------------|-----------------|------|
| 11570.00 | 40.35 | 32.44 | 17.18 | 33.91 | 56.06 | 74.00 | -17.94 | V |
| 17355.00 | 39.12 | 32.78 | 20.12 | 34.86 | 57.16 | 68.20 | -11.04 | V |
| 11570.00 | 38.35 | 32.44 | 17.18 | 33.91 | 54.06 | 74.00 | -19.94 | H |
| 17355.00 | 36.12 | 32.78 | 20.12 | 34.86 | 54.16 | 68.20 | -14.04 | H |

Average value:

| Frequency (MHz) | Read Level (dBuV) | Antenna Factor (dB/m) | Cable Loss (dB) | Preamp Factor (dB) | Level (dBuV/m) | Limit Line (dBuV/m) | Over Limit (dB) | Pol. |
|-----------------|-------------------|-----------------------|-----------------|--------------------|----------------|---------------------|-----------------|------|
| 11570.00 | 29.13 | 32.44 | 17.18 | 33.91 | 44.84 | 54.00 | -9.16 | V |
| 17355.00 | 27.32 | 32.78 | 20.12 | 34.86 | 45.36 | 54.00 | -8.64 | V |
| 11570.00 | 29.03 | 32.44 | 17.18 | 33.91 | 44.74 | 54.00 | -9.26 | H |
| 17355.00 | 28.36 | 32.78 | 20.12 | 34.86 | 46.40 | 54.00 | -7.60 | H |

| | | | |
|------------|--------------------|---------------|---------|
| Test mode: | IEEE 802.11n(HT20) | Test channel: | High CH |
|------------|--------------------|---------------|---------|

Peak value:

| Frequency (MHz) | Read Level (dBuV) | Antenna Factor (dB/m) | Cable Loss (dB) | Preamp Factor (dB) | Level (dBuV/m) | Limit Line (dBuV/m) | Over Limit (dB) | Pol. |
|-----------------|-------------------|-----------------------|-----------------|--------------------|----------------|---------------------|-----------------|------|
| 11650.00 | 41.21 | 32.59 | 18.02 | 33.92 | 57.90 | 74.00 | -16.10 | V |
| 17475.00 | 38.35 | 32.87 | 20.15 | 34.88 | 56.49 | 68.20 | -11.71 | V |
| 11650.00 | 36.23 | 32.59 | 18.02 | 33.92 | 52.92 | 74.00 | -21.08 | H |
| 17475.00 | 38.13 | 32.87 | 20.15 | 34.88 | 56.27 | 68.20 | -11.93 | H |

Average value:

| Frequency (MHz) | Read Level (dBuV) | Antenna Factor (dB/m) | Cable Loss (dB) | Preamp Factor (dB) | Level (dBuV/m) | Limit Line (dBuV/m) | Over Limit (dB) | Pol. |
|-----------------|-------------------|-----------------------|-----------------|--------------------|----------------|---------------------|-----------------|------|
| 11650.00 | 31.25 | 32.59 | 18.02 | 33.92 | 47.94 | 54.00 | -6.06 | V |
| 17475.00 | 32.41 | 32.87 | 20.15 | 34.88 | 50.55 | 54.00 | -3.45 | V |
| 11650.00 | 29.32 | 32.59 | 18.02 | 33.92 | 46.01 | 54.00 | -7.99 | H |
| 17475.00 | 28.74 | 32.87 | 20.15 | 34.88 | 46.88 | 54.00 | -7.12 | H |

| | | | |
|------------|--------------------|---------------|--------|
| Test mode: | IEEE 802.11n(ac20) | Test channel: | Low CH |
|------------|--------------------|---------------|--------|

Peak value:

| Frequency (MHz) | Read Level (dBuV) | Antenna Factor (dB/m) | Cable Loss (dB) | Preamp Factor (dB) | Level (dBuV/m) | Limit Line (dBuV/m) | Over Limit (dB) | Pol. |
|-----------------|-------------------|-----------------------|-----------------|--------------------|----------------|---------------------|-----------------|------|
| 11490.00 | 41.87 | 31.98 | 17.08 | 33.91 | 57.02 | 74.00 | -16.98 | V |
| 17235.00 | 35.23 | 32.65 | 20.03 | 34.85 | 53.06 | 68.20 | -15.14 | V |
| 11490.00 | 38.46 | 31.98 | 17.08 | 33.91 | 53.61 | 74.00 | -20.39 | H |
| 17235.00 | 35.05 | 32.65 | 20.03 | 34.85 | 52.88 | 68.20 | -15.32 | H |

Average value:

| Frequency (MHz) | Read Level (dBuV) | Antenna Factor (dB/m) | Cable Loss (dB) | Preamp Factor (dB) | Level (dBuV/m) | Limit Line (dBuV/m) | Over Limit (dB) | Pol. |
|-----------------|-------------------|-----------------------|-----------------|--------------------|----------------|---------------------|-----------------|------|
| 11490.00 | 32.16 | 31.98 | 17.08 | 33.91 | 47.31 | 54.00 | -6.69 | V |
| 17235.00 | 29.34 | 32.65 | 20.03 | 34.85 | 47.17 | 54.00 | -6.83 | V |
| 11490.00 | 30.25 | 31.98 | 17.08 | 33.91 | 45.40 | 54.00 | -8.60 | H |
| 17235.00 | 27.22 | 32.65 | 20.03 | 34.85 | 45.05 | 54.00 | -8.95 | H |

| | | | |
|------------|--------------------|---------------|--------|
| Test mode: | IEEE 802.11n(ac20) | Test channel: | Mid CH |
|------------|--------------------|---------------|--------|

Peak value:

| Frequency (MHz) | Read Level (dBuV) | Antenna Factor (dB/m) | Cable Loss (dB) | Preamp Factor (dB) | Level (dBuV/m) | Limit Line (dBuV/m) | Over Limit (dB) | Pol. |
|-----------------|-------------------|-----------------------|-----------------|--------------------|----------------|---------------------|-----------------|------|
| 11570.00 | 40.73 | 32.44 | 17.18 | 33.91 | 56.44 | 74.00 | -17.56 | V |
| 17355.00 | 37.41 | 32.78 | 20.12 | 34.86 | 55.45 | 68.20 | -12.75 | V |
| 11570.00 | 39.22 | 32.44 | 17.18 | 33.91 | 54.93 | 74.00 | -19.07 | H |
| 17355.00 | 36.10 | 32.78 | 20.12 | 34.86 | 54.14 | 68.20 | -14.06 | H |

Average value:

| Frequency (MHz) | Read Level (dBuV) | Antenna Factor (dB/m) | Cable Loss (dB) | Preamp Factor (dB) | Level (dBuV/m) | Limit Line (dBuV/m) | Over Limit (dB) | Pol. |
|-----------------|-------------------|-----------------------|-----------------|--------------------|----------------|---------------------|-----------------|------|
| 11570.00 | 30.35 | 32.44 | 17.18 | 33.91 | 46.06 | 54.00 | -7.94 | V |
| 17355.00 | 27.49 | 32.78 | 20.12 | 34.86 | 45.53 | 54.00 | -8.47 | V |
| 11570.00 | 29.42 | 32.44 | 17.18 | 33.91 | 45.13 | 54.00 | -8.87 | H |
| 17355.00 | 27.15 | 32.78 | 20.12 | 34.86 | 45.19 | 54.00 | -8.81 | H |

| | | | |
|------------|--------------------|---------------|---------|
| Test mode: | IEEE 802.11n(ac20) | Test channel: | High CH |
|------------|--------------------|---------------|---------|

Peak value:

| Frequency (MHz) | Read Level (dBuV) | Antenna Factor (dB/m) | Cable Loss (dB) | Preamp Factor (dB) | Level (dBuV/m) | Limit Line (dBuV/m) | Over Limit (dB) | Pol. |
|-----------------|-------------------|-----------------------|-----------------|--------------------|----------------|---------------------|-----------------|------|
| 11650.00 | 40.34 | 32.59 | 18.02 | 33.92 | 57.03 | 74.00 | -16.97 | V |
| 17475.00 | 38.56 | 32.87 | 20.15 | 34.88 | 56.70 | 68.20 | -11.50 | V |
| 11650.00 | 39.22 | 32.59 | 18.02 | 33.92 | 55.91 | 74.00 | -18.09 | H |
| 17475.00 | 37.25 | 32.87 | 20.15 | 34.88 | 55.39 | 68.20 | -12.81 | H |

Average value:

| Frequency (MHz) | Read Level (dBuV) | Antenna Factor (dB/m) | Cable Loss (dB) | Preamp Factor (dB) | Level (dBuV/m) | Limit Line (dBuV/m) | Over Limit (dB) | Pol. |
|-----------------|-------------------|-----------------------|-----------------|--------------------|----------------|---------------------|-----------------|------|
| 11650.00 | 30.17 | 32.59 | 18.02 | 33.92 | 46.86 | 54.00 | -7.14 | V |
| 17475.00 | 28.14 | 32.87 | 20.15 | 34.88 | 46.28 | 54.00 | -7.72 | V |
| 11650.00 | 28.85 | 32.59 | 18.02 | 33.92 | 45.54 | 54.00 | -8.46 | H |
| 17475.00 | 27.42 | 32.87 | 20.15 | 34.88 | 45.56 | 54.00 | -8.44 | H |

| | | | |
|------------|--------------------|---------------|--------|
| Test mode: | IEEE 802.11n(HT40) | Test channel: | Low CH |
|------------|--------------------|---------------|--------|

Peak value:

| Frequency (MHz) | Read Level (dBuV) | Antenna Factor (dB/m) | Cable Loss (dB) | Preamp Factor (dB) | Level (dBuV/m) | Limit Line (dBuV/m) | Over Limit (dB) | Pol. |
|-----------------|-------------------|-----------------------|-----------------|--------------------|----------------|---------------------|-----------------|------|
| 11510.00 | 37.76 | 31.98 | 17.08 | 33.91 | 52.91 | 74.00 | -21.09 | V |
| 17265.00 | 35.87 | 32.65 | 20.03 | 34.85 | 53.70 | 68.20 | -14.50 | V |
| 11510.00 | 37.63 | 31.98 | 17.08 | 33.91 | 52.78 | 74.00 | -21.22 | H |
| 17265.00 | 35.74 | 32.65 | 20.03 | 34.85 | 53.57 | 68.20 | -14.63 | H |

Average value:

| Frequency (MHz) | Read Level (dBuV) | Antenna Factor (dB/m) | Cable Loss (dB) | Preamp Factor (dB) | Level (dBuV/m) | Limit Line (dBuV/m) | Over Limit (dB) | Pol. |
|-----------------|-------------------|-----------------------|-----------------|--------------------|----------------|---------------------|-----------------|------|
| 11510.00 | 30.11 | 31.98 | 17.08 | 33.91 | 45.26 | 54.00 | -8.74 | V |
| 17265.00 | 28.83 | 32.65 | 20.03 | 34.85 | 46.66 | 54.00 | -7.34 | V |
| 11510.00 | 30.11 | 31.98 | 17.08 | 33.91 | 45.26 | 54.00 | -8.74 | H |
| 17265.00 | 27.34 | 32.65 | 20.03 | 34.85 | 45.17 | 54.00 | -8.83 | H |

| | | | |
|------------|--------------------|---------------|---------|
| Test mode: | IEEE 802.11n(HT40) | Test channel: | High CH |
|------------|--------------------|---------------|---------|

Peak value:

| Frequency (MHz) | Read Level (dBuV) | Antenna Factor (dB/m) | Cable Loss (dB) | Preamp Factor (dB) | Level (dBuV/m) | Limit Line (dBuV/m) | Over Limit (dB) | Pol. |
|-----------------|-------------------|-----------------------|-----------------|--------------------|----------------|---------------------|-----------------|------|
| 11590.00 | 42.25 | 32.59 | 18.02 | 33.92 | 58.94 | 74.00 | -15.06 | V |
| 17385.00 | 39.12 | 32.87 | 20.15 | 34.88 | 57.26 | 68.20 | -10.94 | V |
| 11590.00 | 37.41 | 32.59 | 18.02 | 33.92 | 54.10 | 74.00 | -19.90 | H |
| 17385.00 | 38.53 | 32.87 | 20.15 | 34.88 | 56.67 | 68.20 | -11.53 | H |

Average value:

| Frequency (MHz) | Read Level (dBuV) | Antenna Factor (dB/m) | Cable Loss (dB) | Preamp Factor (dB) | Level (dBuV/m) | Limit Line (dBuV/m) | Over Limit (dB) | Pol. |
|-----------------|-------------------|-----------------------|-----------------|--------------------|----------------|---------------------|-----------------|------|
| 11590.00 | 32.13 | 32.59 | 18.02 | 33.92 | 48.82 | 54.00 | -5.18 | V |
| 17385.00 | 29.49 | 32.87 | 20.15 | 34.88 | 47.63 | 54.00 | -6.37 | V |
| 11590.00 | 31.47 | 32.59 | 18.02 | 33.92 | 48.16 | 54.00 | -5.84 | H |
| 17385.00 | 28.41 | 32.78 | 20.12 | 34.86 | 46.45 | 54.00 | -7.55 | H |

| | | | |
|------------|---------------------|---------------|--------|
| Test mode: | IEEE 802.11ac(HT40) | Test channel: | Low CH |
|------------|---------------------|---------------|--------|

Peak value:

| Frequency (MHz) | Read Level (dBuV) | Antenna Factor (dB/m) | Cable Loss (dB) | Preamp Factor (dB) | Level (dBuV/m) | Limit Line (dBuV/m) | Over Limit (dB) | Pol. |
|-----------------|-------------------|-----------------------|-----------------|--------------------|----------------|---------------------|-----------------|------|
| 11510.00 | 37.48 | 31.98 | 17.08 | 33.91 | 52.63 | 74.00 | -21.37 | V |
| 17265.00 | 35.27 | 32.65 | 20.03 | 34.85 | 53.10 | 68.20 | -15.10 | V |
| 11510.00 | 37.21 | 31.98 | 17.08 | 33.91 | 52.36 | 74.00 | -21.64 | H |
| 17265.00 | 35.53 | 32.65 | 20.03 | 34.85 | 53.36 | 68.20 | -14.84 | H |

Average value:

| Frequency (MHz) | Read Level (dBuV) | Antenna Factor (dB/m) | Cable Loss (dB) | Preamp Factor (dB) | Level (dBuV/m) | Limit Line (dBuV/m) | Over Limit (dB) | Pol. |
|-----------------|-------------------|-----------------------|-----------------|--------------------|----------------|---------------------|-----------------|------|
| 11510.00 | 31.24 | 31.98 | 17.08 | 33.91 | 46.39 | 54.00 | -7.61 | V |
| 17265.00 | 28.35 | 32.65 | 20.03 | 34.85 | 46.18 | 54.00 | -7.82 | V |
| 11510.00 | 30.34 | 31.98 | 17.08 | 33.91 | 45.49 | 54.00 | -8.51 | H |
| 17265.00 | 27.69 | 32.65 | 20.03 | 34.85 | 45.52 | 54.00 | -8.48 | H |

| | | | |
|------------|---------------------|---------------|---------|
| Test mode: | IEEE 802.11ac(HT40) | Test channel: | High CH |
|------------|---------------------|---------------|---------|

Peak value:

| Frequency (MHz) | Read Level (dBuV) | Antenna Factor (dB/m) | Cable Loss (dB) | Preamp Factor (dB) | Level (dBuV/m) | Limit Line (dBuV/m) | Over Limit (dB) | Pol. |
|-----------------|-------------------|-----------------------|-----------------|--------------------|----------------|---------------------|-----------------|------|
| 11590.00 | 41.78 | 32.59 | 18.02 | 33.92 | 58.47 | 74.00 | -15.53 | V |
| 17385.00 | 38.47 | 32.87 | 20.15 | 34.88 | 56.61 | 68.20 | -11.59 | V |
| 11590.00 | 39.27 | 32.59 | 18.02 | 33.92 | 55.96 | 74.00 | -18.04 | H |
| 17385.00 | 37.42 | 32.87 | 20.15 | 34.88 | 55.56 | 68.20 | -12.64 | H |

Average value:

| Frequency (MHz) | Read Level (dBuV) | Antenna Factor (dB/m) | Cable Loss (dB) | Preamp Factor (dB) | Level (dBuV/m) | Limit Line (dBuV/m) | Over Limit (dB) | Pol. |
|-----------------|-------------------|-----------------------|-----------------|--------------------|----------------|---------------------|-----------------|------|
| 11590.00 | 31.78 | 32.59 | 18.02 | 33.92 | 48.47 | 54.00 | -5.53 | V |
| 17385.00 | 28.89 | 32.87 | 20.15 | 34.88 | 47.03 | 54.00 | -6.97 | V |
| 11590.00 | 30.27 | 32.59 | 18.02 | 33.92 | 46.96 | 54.00 | -7.04 | H |
| 17385.00 | 28.35 | 32.78 | 20.12 | 34.86 | 46.39 | 54.00 | -7.61 | H |

| | | | |
|------------|---------------------|---------------|--|
| Test mode: | IEEE 802.11ac(HT80) | Test channel: | |
|------------|---------------------|---------------|--|

Peak value:

| Frequency (MHz) | Read Level (dBuV) | Antenna Factor (dB/m) | Cable Loss (dB) | Preamp Factor (dB) | Level (dBuV/m) | Limit Line (dBuV/m) | Over Limit (dB) | Pol. |
|-----------------|-------------------|-----------------------|-----------------|--------------------|----------------|---------------------|-----------------|------|
| 11550.00 | 41.29 | 32.44 | 17.18 | 33.91 | 57.00 | 74.00 | -17.00 | V |
| 17325.00 | 36.49 | 32.78 | 20.12 | 34.86 | 54.53 | 68.20 | -13.67 | V |
| 11550.00 | 38.73 | 32.44 | 17.18 | 33.91 | 54.44 | 74.00 | -19.56 | H |
| 17325.00 | 35.47 | 32.78 | 20.12 | 34.86 | 53.51 | 68.20 | -14.69 | H |

Average value:

| Frequency (MHz) | Read Level (dBuV) | Antenna Factor (dB/m) | Cable Loss (dB) | Preamp Factor (dB) | Level (dBuV/m) | Limit Line (dBuV/m) | Over Limit (dB) | Pol. |
|-----------------|-------------------|-----------------------|-----------------|--------------------|----------------|---------------------|-----------------|------|
| 11550.00 | 30.19 | 32.44 | 17.18 | 33.91 | 45.90 | 54.00 | -8.10 | V |
| 17325.00 | 28.25 | 32.78 | 20.12 | 34.86 | 46.29 | 54.00 | -7.71 | V |
| 11550.00 | 30.04 | 32.44 | 17.18 | 33.91 | 45.75 | 54.00 | -8.25 | H |
| 17325.00 | 27.93 | 32.78 | 20.12 | 34.86 | 45.97 | 54.00 | -8.03 | H |

Note:

1. Final Level = Receiver Read level + Antenna Factor + Cable Loss - Preamplifier Factor

Radiated Band Edge:

| Test Mode: 802.11a | | | | | | | | |
|--------------------|-------------------|-----------------------|-----------------|--------------------|----------------|----------------|-----------------|------|
| Peak Value | | | | | | | | |
| Frequency (MHz) | Read Level (dBUV) | Antenna Factor (dB/m) | Cable Loss (dB) | Preamp Factor (dB) | Level (dBUV/m) | Limit (dBUV/m) | Over Limit (dB) | Pol. |
| 5725.00 | 42.30 | 28.65 | 13.58 | 31.04 | 53.49 | 68.20 | -14.71 | H |
| 5850.00 | 43.20 | 29.16 | 14.68 | 31.96 | 55.08 | 68.20 | -13.12 | H |
| 5725.00 | 42.31 | 28.65 | 13.58 | 31.04 | 53.50 | 68.20 | -14.70 | V |
| 5850.00 | 43.25 | 29.16 | 14.68 | 31.96 | 55.13 | 68.20 | -13.07 | V |
| Average Value | | | | | | | | |
| Frequency (MHz) | Read Level (dBUV) | Antenna Factor (dB/m) | Cable Loss (dB) | Preamp Factor (dB) | Level (dBUV/m) | Limit (dBUV/m) | Over Limit (dB) | Pol. |
| 5725.00 | 34.72 | 28.65 | 13.58 | 31.04 | 45.91 | 54.00 | -8.09 | H |
| 5850.00 | 35.48 | 29.16 | 14.68 | 31.96 | 47.36 | 54.00 | -6.64 | H |
| 5725.00 | 35.14 | 28.65 | 13.58 | 31.04 | 46.33 | 54.00 | -7.67 | V |
| 5850.00 | 36.21 | 29.16 | 14.68 | 31.96 | 48.09 | 54.00 | -5.91 | V |

| Test Mode: 802.11n20 | | | | | | | | |
|----------------------|-------------------|-----------------------|-----------------|--------------------|----------------|----------------|-----------------|------|
| Peak Value | | | | | | | | |
| Frequency (MHz) | Read Level (dBUV) | Antenna Factor (dB/m) | Cable Loss (dB) | Preamp Factor (dB) | Level (dBUV/m) | Limit (dBUV/m) | Over Limit (dB) | Pol. |
| 5725.00 | 41.67 | 28.65 | 13.58 | 31.04 | 52.86 | 68.20 | -15.34 | H |
| 5850.00 | 42.15 | 29.16 | 14.68 | 31.96 | 54.03 | 68.20 | -14.17 | H |
| 5725.00 | 42.35 | 28.65 | 13.58 | 31.04 | 53.54 | 68.20 | -14.66 | V |
| 5850.00 | 43.07 | 29.16 | 14.68 | 31.96 | 54.95 | 68.20 | -13.25 | V |
| Average Value | | | | | | | | |
| Frequency (MHz) | Read Level (dBUV) | Antenna Factor (dB/m) | Cable Loss (dB) | Preamp Factor (dB) | Level (dBUV/m) | Limit (dBUV/m) | Over Limit (dB) | Pol. |
| 5725.00 | 34.25 | 28.65 | 13.58 | 31.04 | 45.44 | 54.00 | -8.56 | H |
| 5850.00 | 35.78 | 29.16 | 14.68 | 31.96 | 47.66 | 54.00 | -6.34 | H |
| 5725.00 | 34.74 | 28.65 | 13.58 | 31.04 | 45.93 | 54.00 | -8.07 | V |
| 5850.00 | 36.05 | 29.16 | 14.68 | 31.96 | 47.93 | 54.00 | -6.07 | V |

| Test Mode: 802.11ac20 | | | | | | | | |
|-----------------------|-------------------|-----------------------|-----------------|--------------------|----------------|----------------|-----------------|------|
| Peak Value | | | | | | | | |
| Frequency (MHz) | Read Level (dBuV) | Antenna Factor (dB/m) | Cable Loss (dB) | Preamp Factor (dB) | Level (dBuV/m) | Limit (dBuV/m) | Over Limit (dB) | Pol. |
| 5725.00 | 41.29 | 28.65 | 13.58 | 31.04 | 52.48 | 68.20 | -15.72 | H |
| 5850.00 | 42.64 | 29.16 | 14.68 | 31.96 | 54.52 | 68.20 | -13.68 | H |
| 5725.00 | 43.31 | 28.65 | 13.58 | 31.04 | 54.50 | 68.20 | -13.70 | V |
| 5850.00 | 42.77 | 29.16 | 14.68 | 31.96 | 54.65 | 68.20 | -13.55 | V |
| Average Value | | | | | | | | |
| Frequency (MHz) | Read Level (dBuV) | Antenna Factor (dB/m) | Cable Loss (dB) | Preamp Factor (dB) | Level (dBuV/m) | Limit (dBuV/m) | Over Limit (dB) | Pol. |
| 5725.00 | 33.78 | 28.65 | 13.58 | 31.04 | 44.97 | 54.00 | -9.03 | H |
| 5850.00 | 34.64 | 29.16 | 14.68 | 31.96 | 46.52 | 54.00 | -7.48 | H |
| 5725.00 | 34.12 | 28.65 | 13.58 | 31.04 | 45.31 | 54.00 | -8.69 | V |
| 5850.00 | 35.44 | 29.16 | 14.68 | 31.96 | 47.32 | 54.00 | -6.68 | V |

| Test Mode: 802.11n40 | | | | | | | | |
|----------------------|-------------------|-----------------------|-----------------|--------------------|----------------|----------------|-----------------|------|
| Peak Value | | | | | | | | |
| Frequency (MHz) | Read Level (dBuV) | Antenna Factor (dB/m) | Cable Loss (dB) | Preamp Factor (dB) | Level (dBuV/m) | Limit (dBuV/m) | Over Limit (dB) | Pol. |
| 5725.00 | 41.47 | 28.65 | 13.58 | 31.04 | 52.66 | 68.20 | -15.54 | H |
| 5850.00 | 42.61 | 29.16 | 14.68 | 31.96 | 54.49 | 68.20 | -13.71 | H |
| 5725.00 | 41.77 | 28.65 | 13.58 | 31.04 | 52.96 | 68.20 | -15.24 | V |
| 5850.00 | 43.81 | 29.16 | 14.68 | 31.96 | 55.69 | 68.20 | -12.51 | V |
| Average Value | | | | | | | | |
| Frequency (MHz) | Read Level (dBuV) | Antenna Factor (dB/m) | Cable Loss (dB) | Preamp Factor (dB) | Level (dBuV/m) | Limit (dBuV/m) | Over Limit (dB) | Pol. |
| 5725.00 | 33.53 | 28.65 | 13.58 | 31.04 | 44.72 | 54.00 | -9.28 | H |
| 5850.00 | 34.25 | 29.16 | 14.68 | 31.96 | 46.13 | 54.00 | -7.87 | H |
| 5725.00 | 33.78 | 28.65 | 13.58 | 31.04 | 44.97 | 54.00 | -9.03 | V |
| 5850.00 | 35.13 | 29.16 | 14.68 | 31.96 | 47.01 | 54.00 | -6.99 | V |

| Test Mode: 802.11ac40 | | | | | | | | |
|-----------------------|-------------------|-----------------------|-----------------|--------------------|----------------|----------------|-----------------|------|
| Peak Value | | | | | | | | |
| Frequency (MHz) | Read Level (dBuV) | Antenna Factor (dB/m) | Cable Loss (dB) | Preamp Factor (dB) | Level (dBuV/m) | Limit (dBuV/m) | Over Limit (dB) | Pol. |
| 5725.00 | 41.25 | 28.65 | 13.58 | 31.04 | 52.44 | 68.20 | -15.76 | H |
| 5850.00 | 42.37 | 29.16 | 14.68 | 31.96 | 54.25 | 68.20 | -13.95 | H |
| 5725.00 | 41.54 | 28.65 | 13.58 | 31.04 | 52.73 | 68.20 | -15.47 | V |
| 5850.00 | 43.41 | 29.16 | 14.68 | 31.96 | 55.29 | 68.20 | -12.91 | V |
| Average Value | | | | | | | | |
| Frequency (MHz) | Read Level (dBuV) | Antenna Factor (dB/m) | Cable Loss (dB) | Preamp Factor (dB) | Level (dBuV/m) | Limit (dBuV/m) | Over Limit (dB) | Pol. |
| 5725.00 | 33.47 | 28.65 | 13.58 | 31.04 | 44.66 | 54.00 | -9.34 | H |
| 5850.00 | 34.61 | 29.16 | 14.68 | 31.96 | 46.49 | 54.00 | -7.51 | H |
| 5725.00 | 33.62 | 28.65 | 13.58 | 31.04 | 44.81 | 54.00 | -9.19 | V |
| 5850.00 | 35.01 | 29.16 | 14.68 | 31.96 | 46.89 | 54.00 | -7.11 | V |

| Test Mode: 802.11ac80 | | | | | | | | |
|-----------------------|-------------------|-----------------------|-----------------|--------------------|----------------|----------------|-----------------|------|
| Peak Value | | | | | | | | |
| Frequency (MHz) | Read Level (dBuV) | Antenna Factor (dB/m) | Cable Loss (dB) | Preamp Factor (dB) | Level (dBuV/m) | Limit (dBuV/m) | Over Limit (dB) | Pol. |
| 5725.00 | 41.63 | 28.65 | 13.58 | 31.04 | 52.82 | 68.20 | -15.38 | H |
| 5850.00 | 42.49 | 29.16 | 14.68 | 31.96 | 54.37 | 68.20 | -13.83 | H |
| 5725.00 | 41.21 | 28.65 | 13.58 | 31.04 | 52.40 | 68.20 | -15.80 | V |
| 5850.00 | 43.82 | 29.16 | 14.68 | 31.96 | 55.70 | 68.20 | -12.50 | V |
| Average Value | | | | | | | | |
| Frequency (MHz) | Read Level (dBuV) | Antenna Factor (dB/m) | Cable Loss (dB) | Preamp Factor (dB) | Level (dBuV/m) | Limit (dBuV/m) | Over Limit (dB) | Pol. |
| 5725.00 | 33.65 | 28.65 | 13.58 | 31.04 | 44.84 | 54.00 | -9.16 | H |
| 5850.00 | 34.45 | 29.16 | 14.68 | 31.96 | 46.33 | 54.00 | -7.67 | H |
| 5725.00 | 33.72 | 28.65 | 13.58 | 31.04 | 44.91 | 54.00 | -9.09 | V |
| 5850.00 | 35.31 | 29.16 | 14.68 | 31.96 | 47.19 | 54.00 | -6.81 | V |

For conducted test:



802.11a: Band Edge, Left Side



802.11a: Band Edge, Right Side



802.11n(20): Band Edge, Left Side



802.11n(20): Band Edge, Right Side

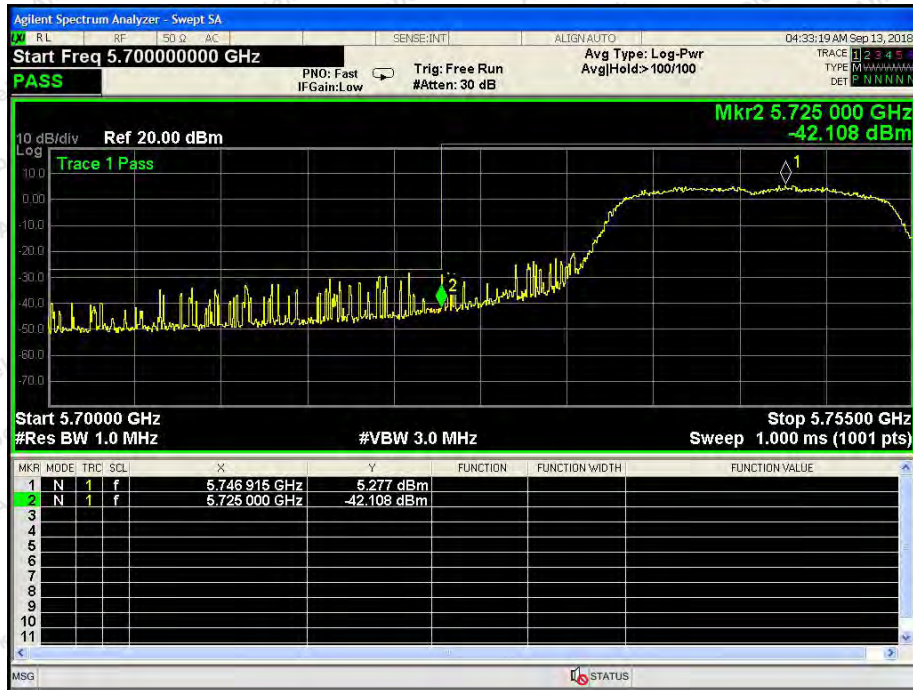

802.11ac(20): Band Edge, Left Side



802.11ac(20): Band Edge, Right Side



802.11n(40): Band Edge, Left Side



802.11n(40): Band Edge, Right Side



802.11ac(40): Band Edge, Left Side



802.11ac(40): Band Edge, Right Side



802.11ac(80): Band Edge

5. Maximum Peak Output Power Test

5.1. Test Standard and Limit

| | |
|---------------|--|
| Test Standard | FCC Part15 C Section 15.407 (a)(1) (3) |
| Test Limit | 30dBm (1W) |

5.2. Test Setup

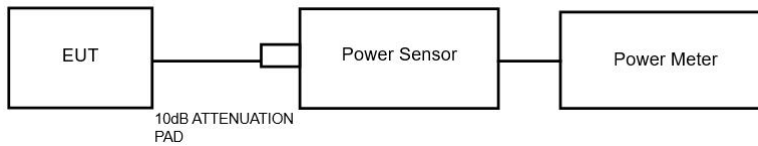

5.3. Test Procedure

1. The Transmitter output (antenna port) was connected to the power meter.
2. Turn on the EUT and power meter and then record the power value.
3. Repeat above procedures on all channels needed to be tested.

Note: The cable loss and attenuator loss were offset into measure device as an amplitude offset.

5.4. Test Data

| | | | |
|--------------|-----------------------------|-------------|--------------------|
| Test Item | : Max. peak output power | Test Mode | : CH Low ~ CH High |
| Test Voltage | : AC 120V, 60Hz for adapter | Temperature | : 24°C |
| Test Result | : PASS | Humidity | : 55%RH |

| Mode | Channel Frequency (MHz) | Peak Power output (dBm) | Correctional Limit (dBm) | Results |
|------------|-------------------------|-------------------------|--------------------------|---------|
| 802.11a | 5745 | 15.13 | 30 | PASS |
| | 5785 | 14.10 | 30 | PASS |
| | 5825 | 13.32 | 30 | PASS |
| 802.11n20 | 5745 | 15.94 | 30 | PASS |
| | 5785 | 14.03 | 30 | PASS |
| | 5825 | 13.41 | 30 | PASS |
| 802.11ac20 | 5745 | 15.12 | 30 | PASS |
| | 5785 | 13.33 | 30 | PASS |
| | 5825 | 12.72 | 30 | PASS |
| 802.11n40 | 5755 | 14.05 | 30 | PASS |
| | 5795 | 13.15 | 30 | PASS |
| 802.11ac40 | 5755 | 14.39 | 30 | PASS |
| | 5795 | 12.50 | 30 | PASS |
| 802.11ac80 | 5775 | 12.61 | 30 | PASS |

6. Occupy Bandwidth Test

6.1. Test Standard

| | |
|---------------|--|
| Test Standard | FCC Part15 C Section 15.403(i), 15.407 (e) |
|---------------|--|

6.2. Test Setup

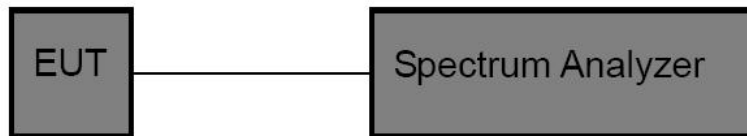

6.3. Test Procedure

1. Place the EUT on the table and set it in the transmitting mode.
2. Remove the antenna from the EUT and then connect a low loss RF cable from the antenna port to the spectrum analyzer.

3. Set the spectrum analyzer as:

26 dB & 99% bandwidth

- RBW = approximately 1% of the emission bandwidth;
- Set the VBW > RBW;
- Detector = Peak
- Trace mode = Max hold.
- Sweep - auto couple.

6 dB bandwidth

- RBW = 100kHz;
- Set the video bandwidth (VBW) ≥ 3 RBW;
- Detector = Peak
- Trace mode = Max hold.
- Sweep - auto couple.

4. Measure the maximum width of the emission that is 26dB /6dB down from the maximum of the emission. Compare this with the RBW setting of the analyzer.

5. Repeat until all the rest channels are investigated.

6.4. Test Data

| | | | |
|--------------|-----------------------------|-------------|--------------------|
| Test Item | : 6dB & 26dB BW | Test Mode | : CH Low ~ CH High |
| Test Voltage | : AC 120V, 60Hz for adapter | Temperature | : 24°C |
| Test Result | : PASS | Humidity | : 55%RH |

| Mode | Channel Frequency (MHz) | 6dB BW(MHz) | Limit | Results |
|------------|-------------------------|-------------|---------|---------|
| 802.11a | 5745 | 15.14 | >0.5MHz | PASS |
| | 5785 | 15.16 | | PASS |
| | 5825 | 15.16 | | PASS |
| 802.11n20 | 5745 | 15.12 | | PASS |
| | 5785 | 15.14 | | PASS |
| | 5825 | 15.15 | | PASS |
| 802.11ac20 | 5745 | 15.12 | | PASS |
| | 5785 | 15.18 | | PASS |
| | 5825 | 15.17 | | PASS |
| 802.11n40 | 5755 | 33.91 | | PASS |
| | 5795 | 35.13 | | PASS |
| 802.11ac40 | 5755 | 35.15 | | PASS |
| | 5795 | 35.15 | | PASS |
| 802.11ac80 | 5775 | 72.76 | | PASS |

| Mode | Channel Frequency (MHz) | 26dB BW(MHz) | 99% Bandwidth (MHz) |
|------------|-------------------------|--------------|---------------------|
| 802.11a | 5745 | 18.85 | 16.889 |
| | 5785 | 18.98 | 16.655 |
| | 5825 | 18.98 | 16.604 |
| 802.11n20 | 5745 | 19.58 | 17.884 |
| | 5785 | 19.68 | 17.829 |
| | 5825 | 20.31 | 17.694 |
| 802.11ac20 | 5745 | 19.73 | 17.849 |
| | 5785 | 19.72 | 17.816 |
| | 5825 | 20.02 | 17.826 |
| 802.11n40 | 5755 | 35.19 | 36.203 |
| | 5795 | 40.50 | 36.160 |
| 802.11ac40 | 5755 | 39.82 | 36.199 |
| | 5795 | 40.89 | 36.172 |
| 802.11ac80 | 5775 | 80.92 | 75.499 |



6dB Bandwidth



Test Mode: 802.11a--Low



Test Mode: 802.11a---Middle

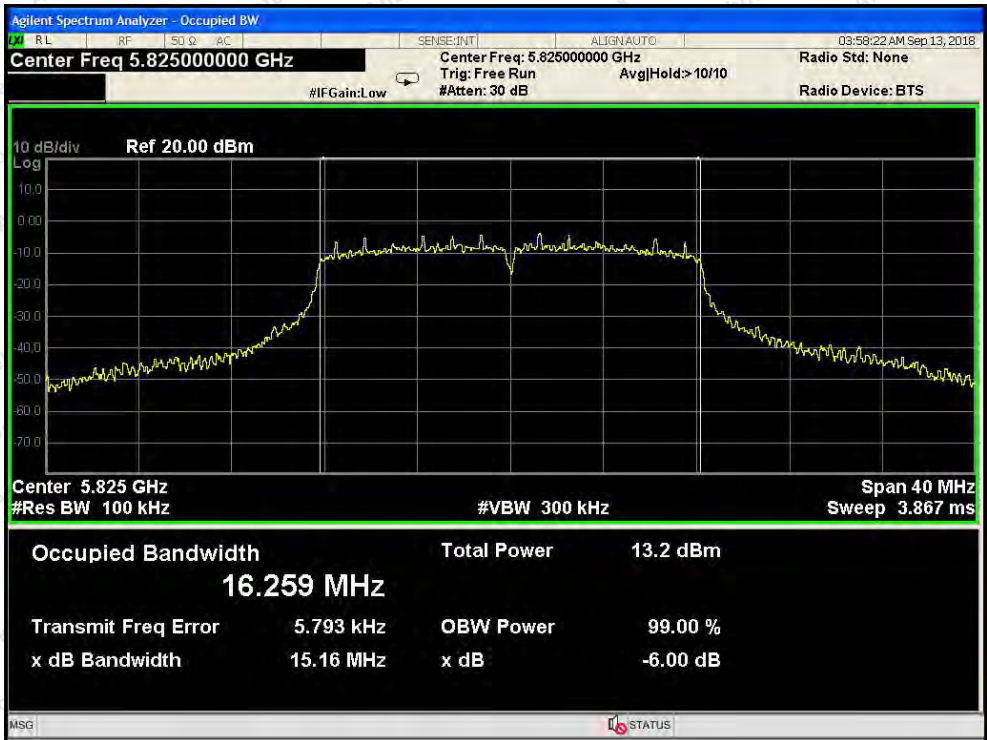

Test Mode: 802.11a---High

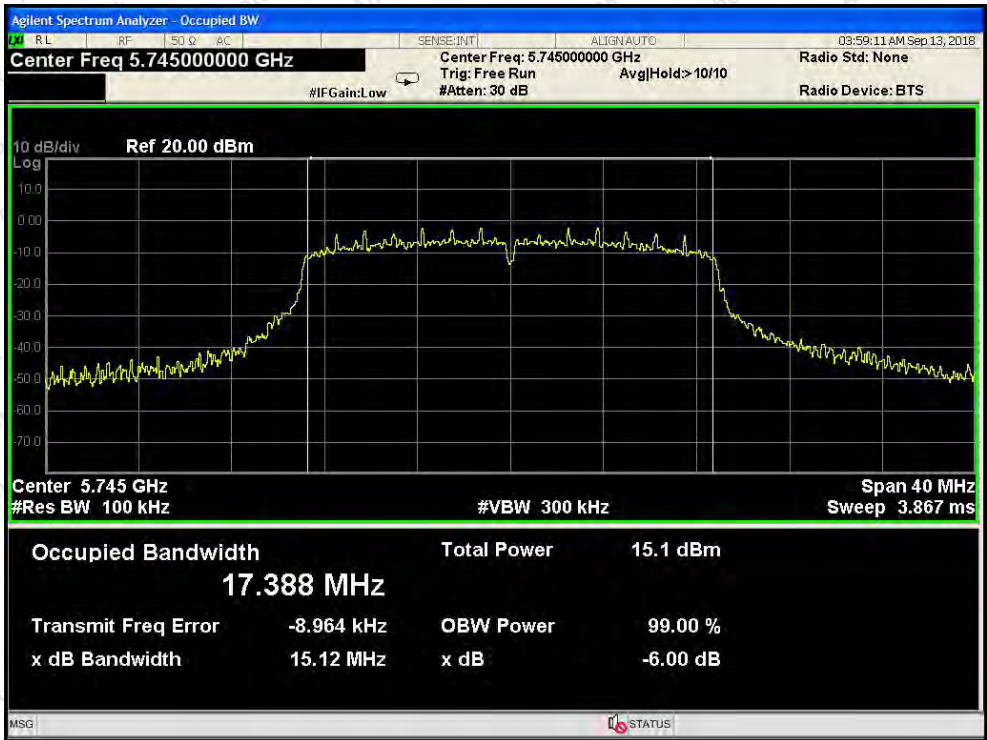

Test Mode: 802.11n20---Low

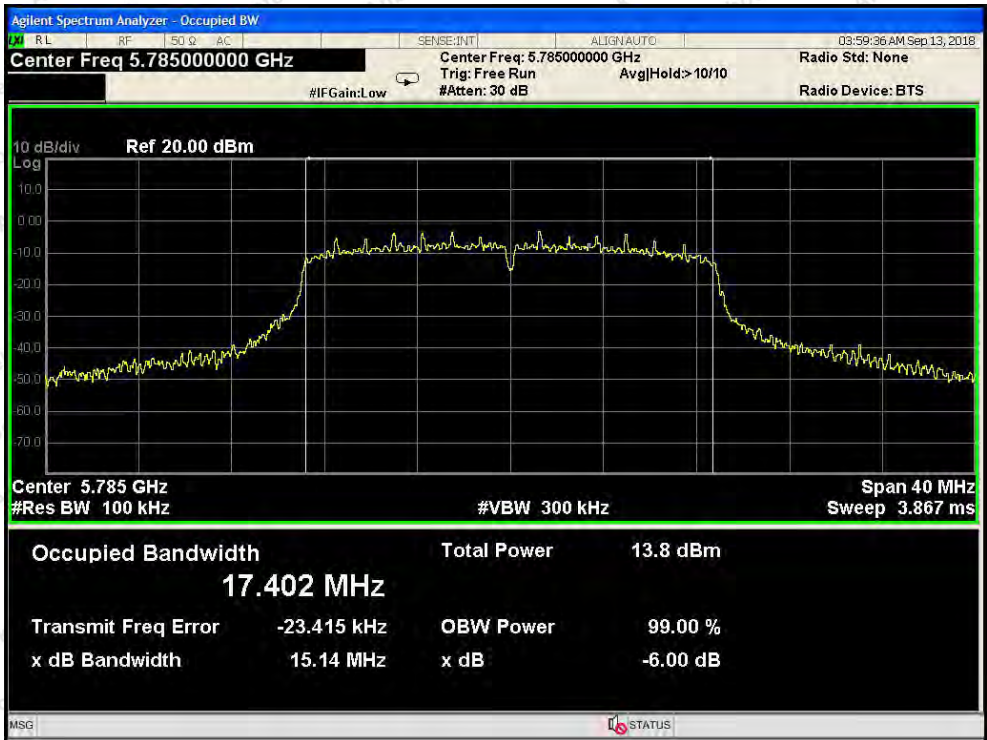

Test Mode: 802.11n20---Middle

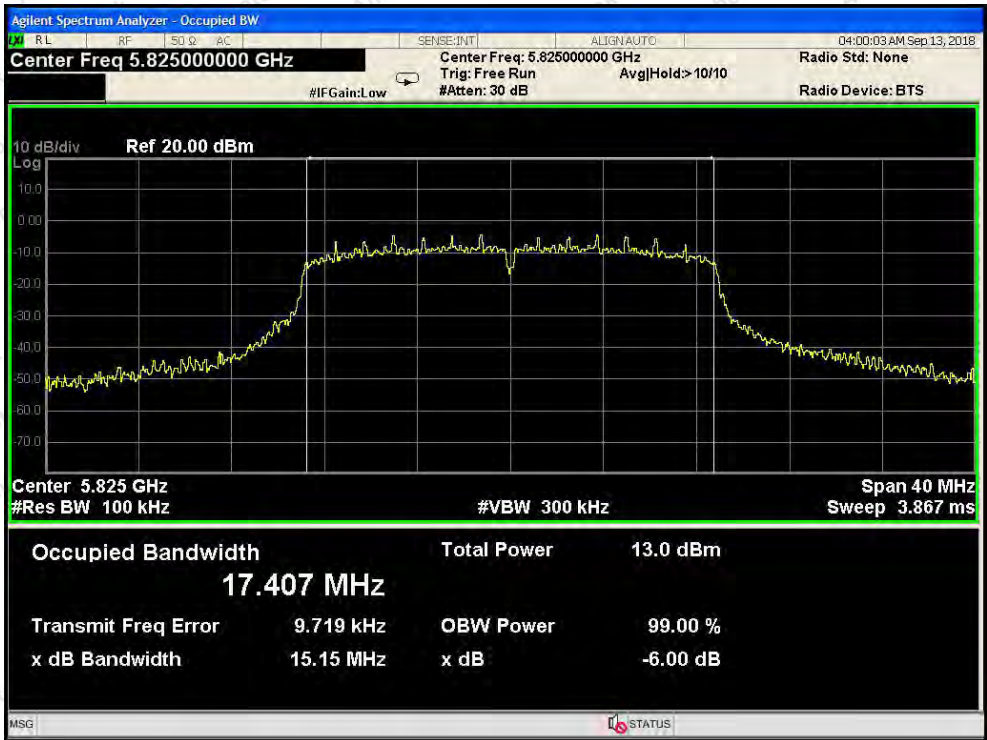

Test Mode: 802.11n20---High

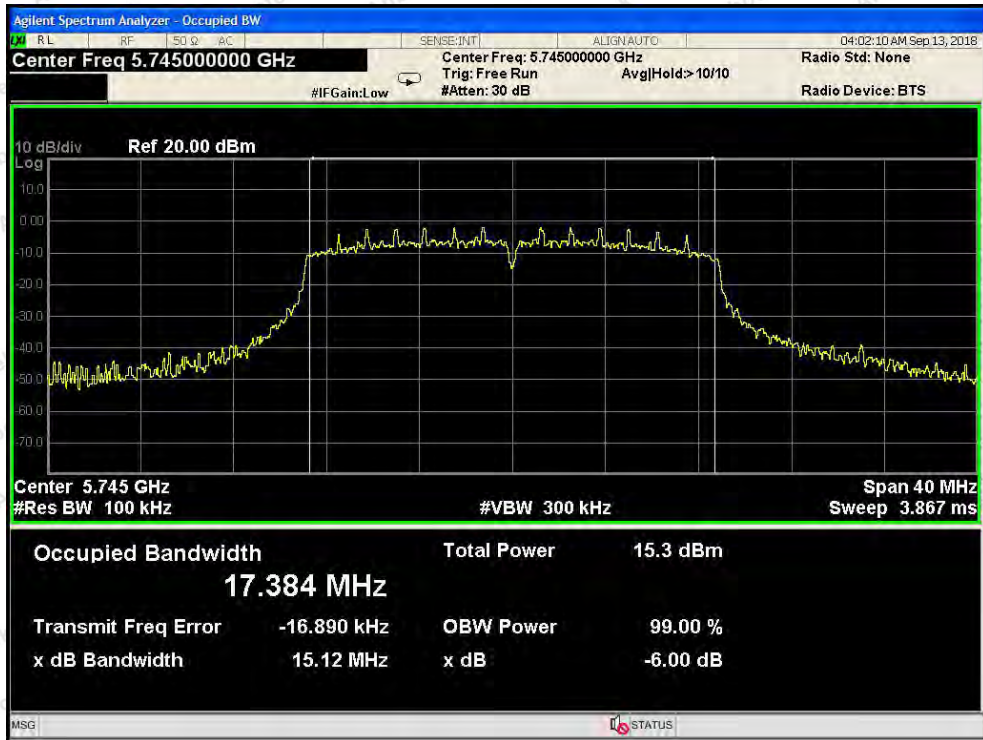

Test Mode: 802.11ac20--Low



Test Mode: 802.11ac20---Middle

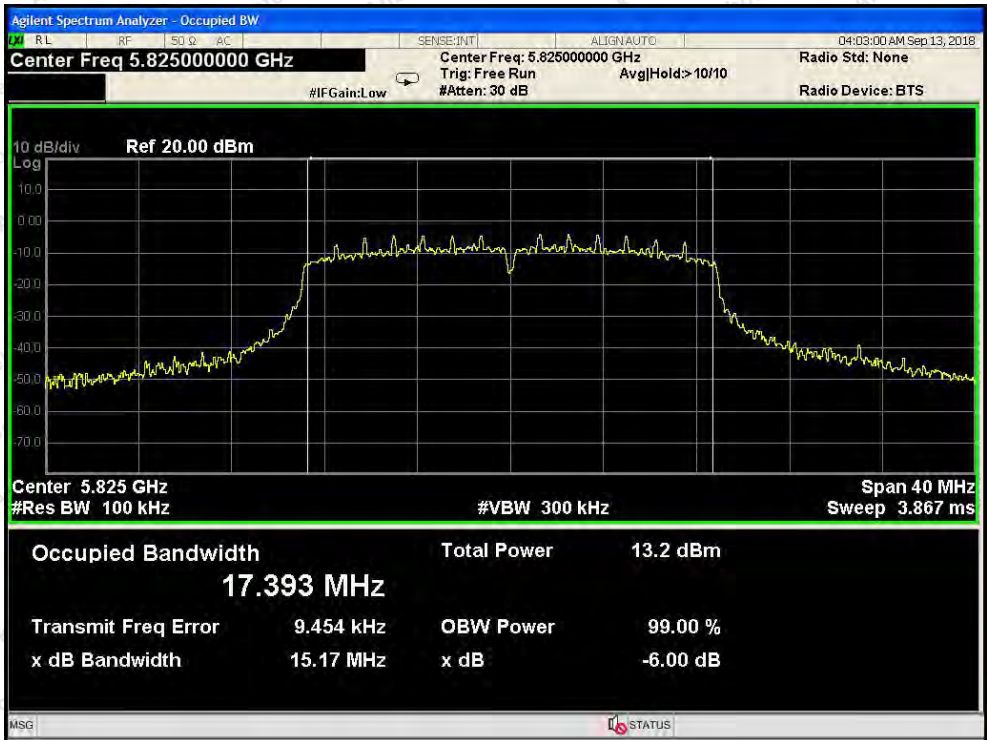

Test Mode: 802.11ac20---High

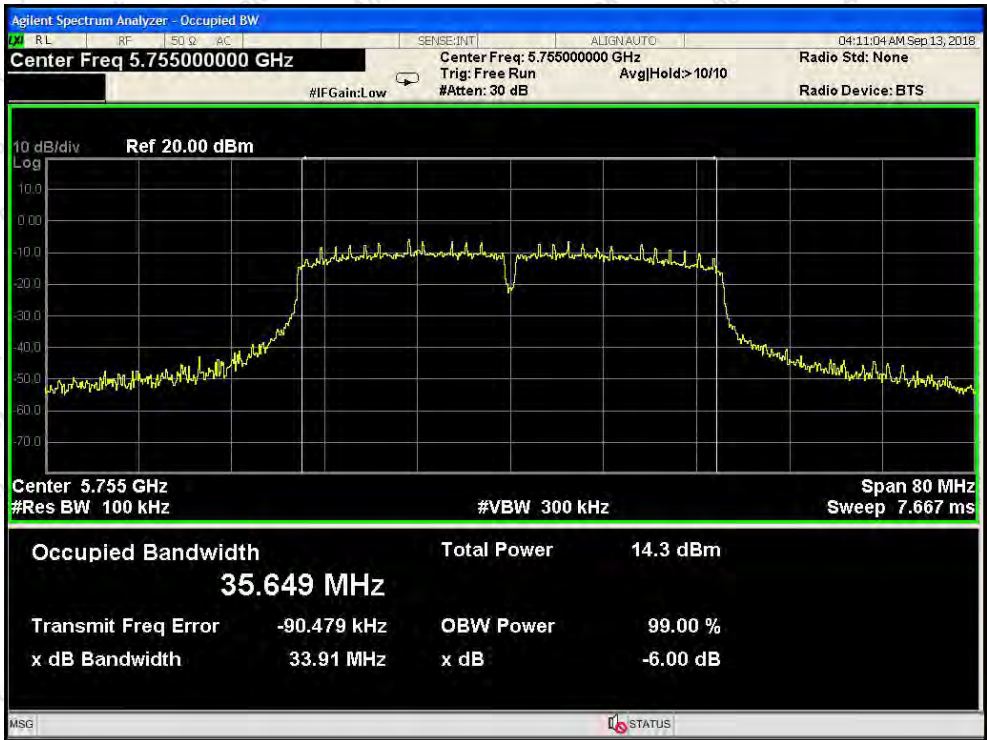

Test Mode: 802.11n40---Low

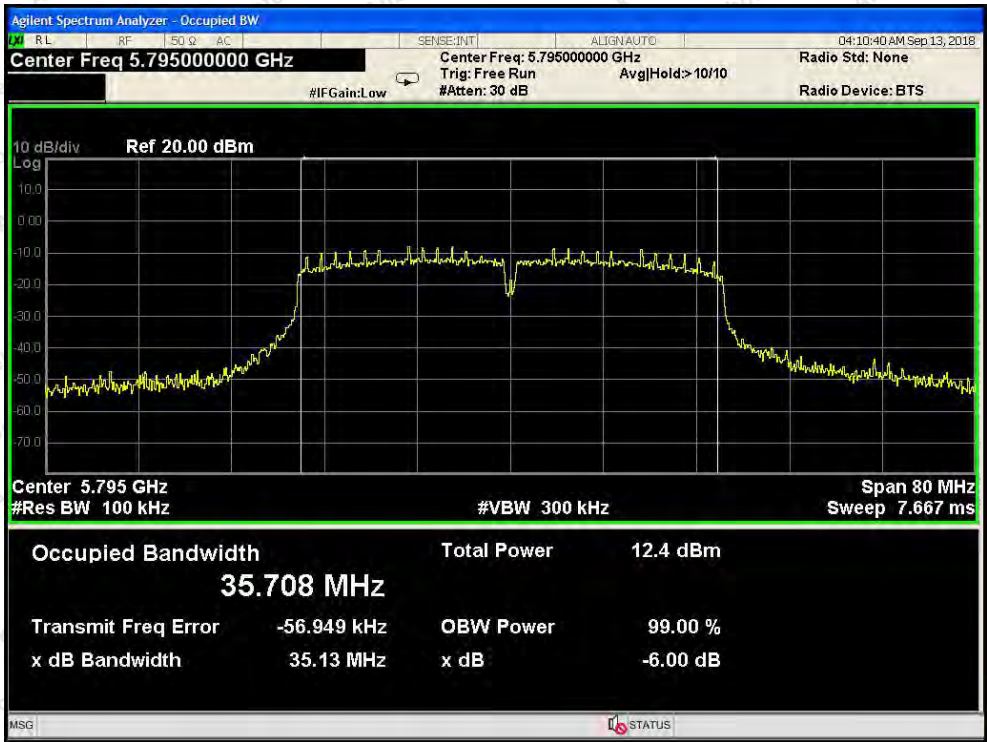

Test Mode: 802.11n40---High

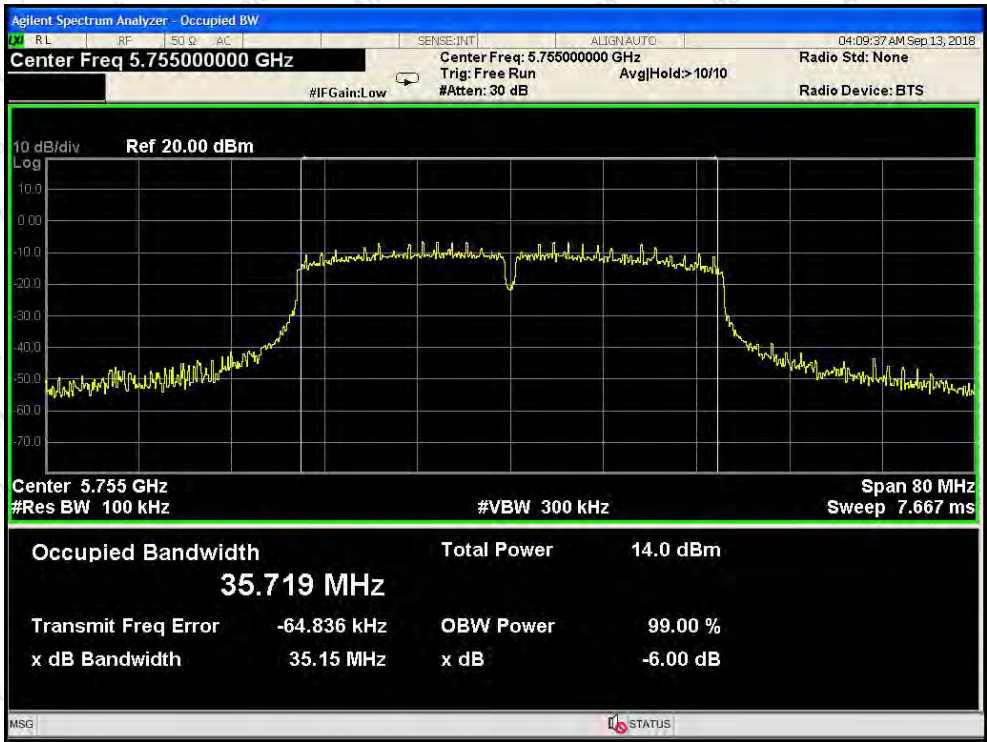

Test Mode: 802.11ac40---Low

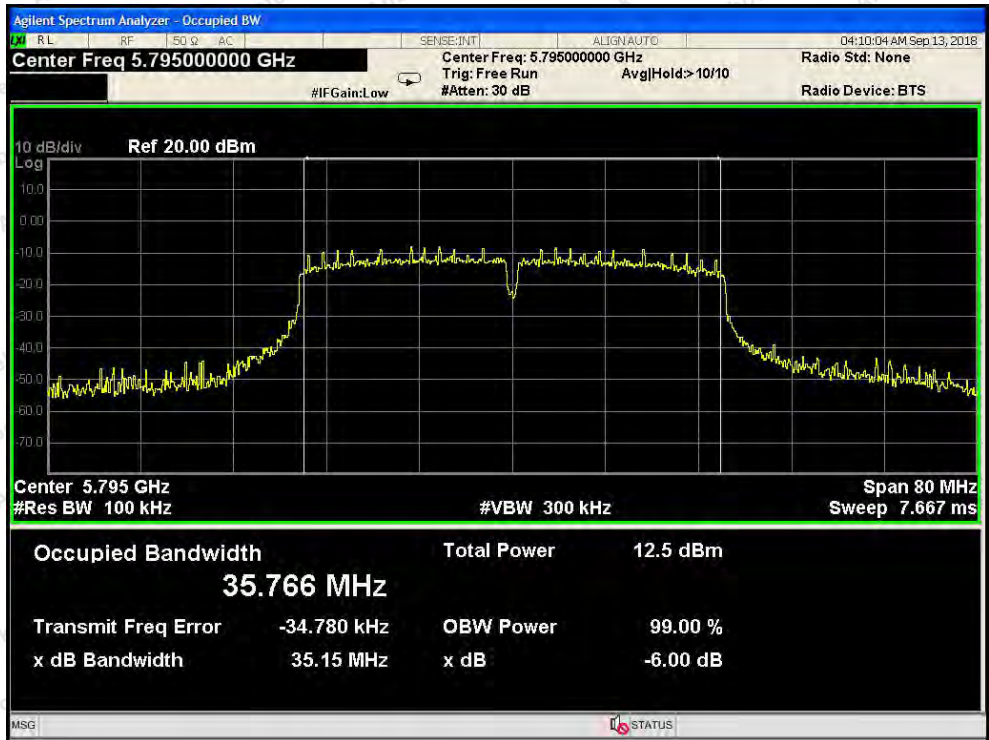

Test Mode: 802.11ac40---High

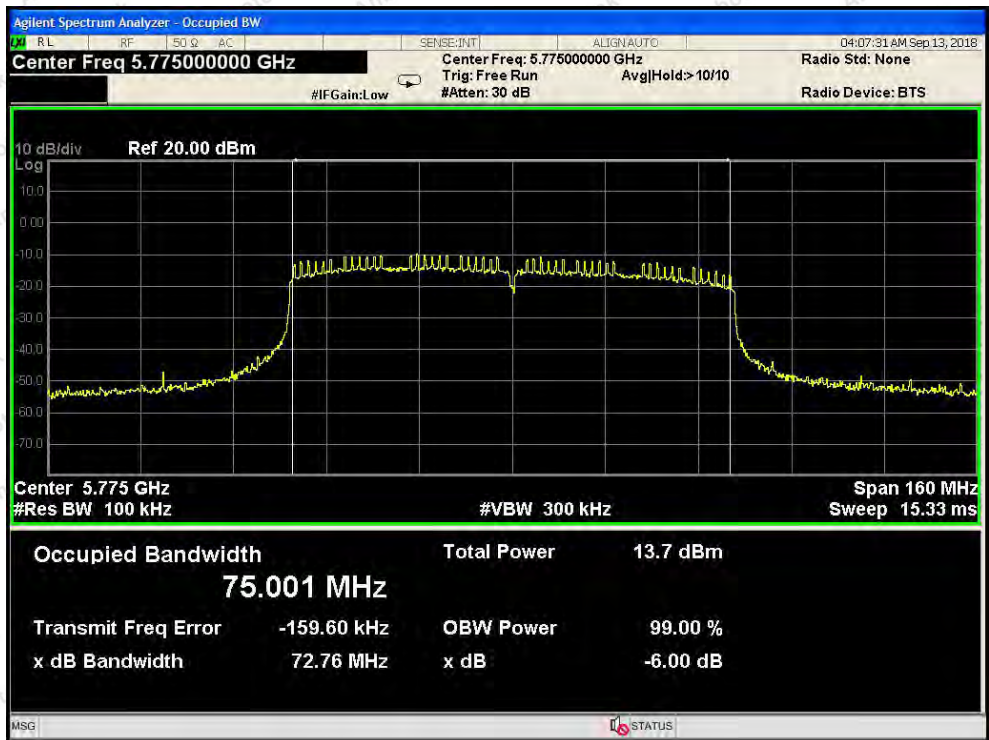

Test Mode: 802.11ac80

26dB & 99% Bandwidth



Test Mode: 802.11a--Low



Test Mode: 802.11a---Middle

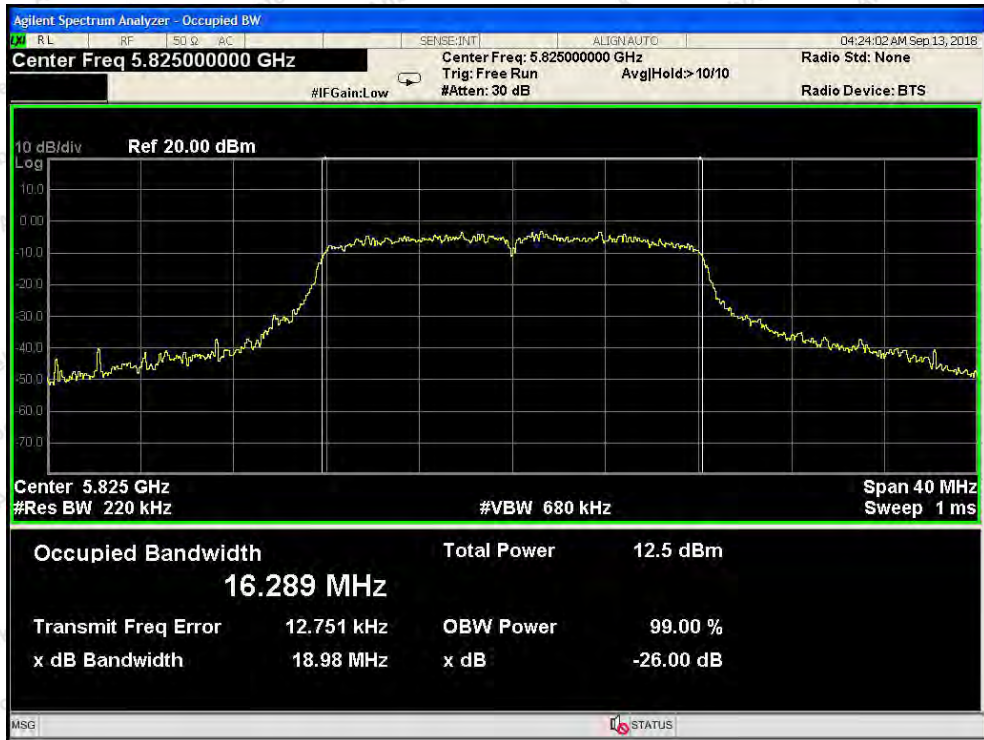

Test Mode: 802.11a---High



Test Mode: 802.11n20---Low



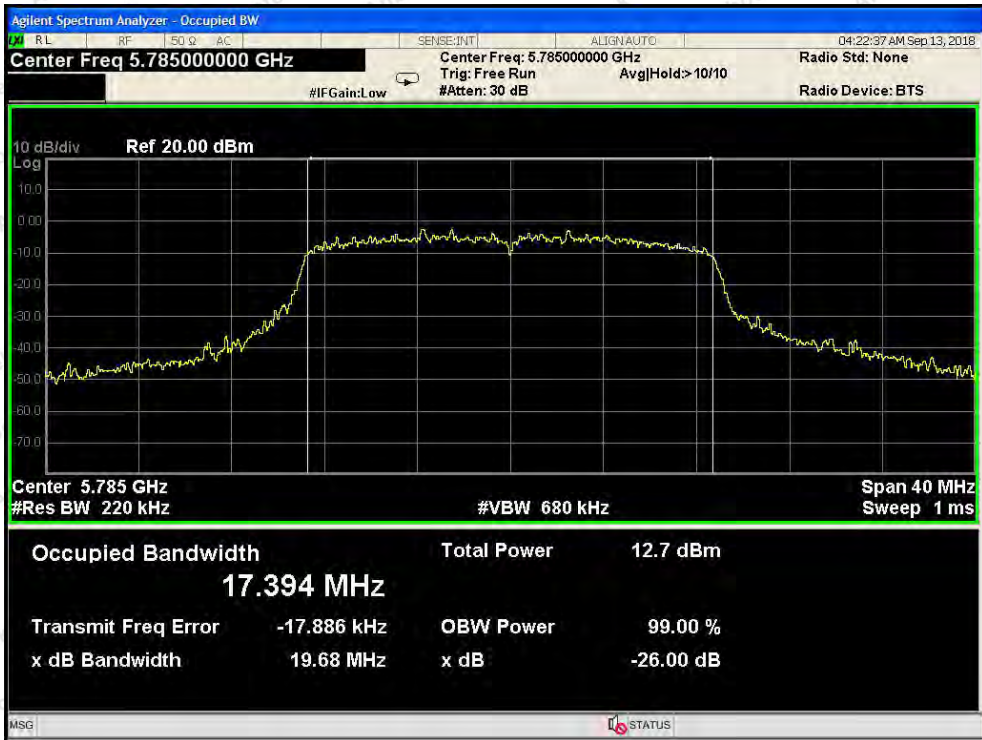

Test Mode: 802.11n20---Middle

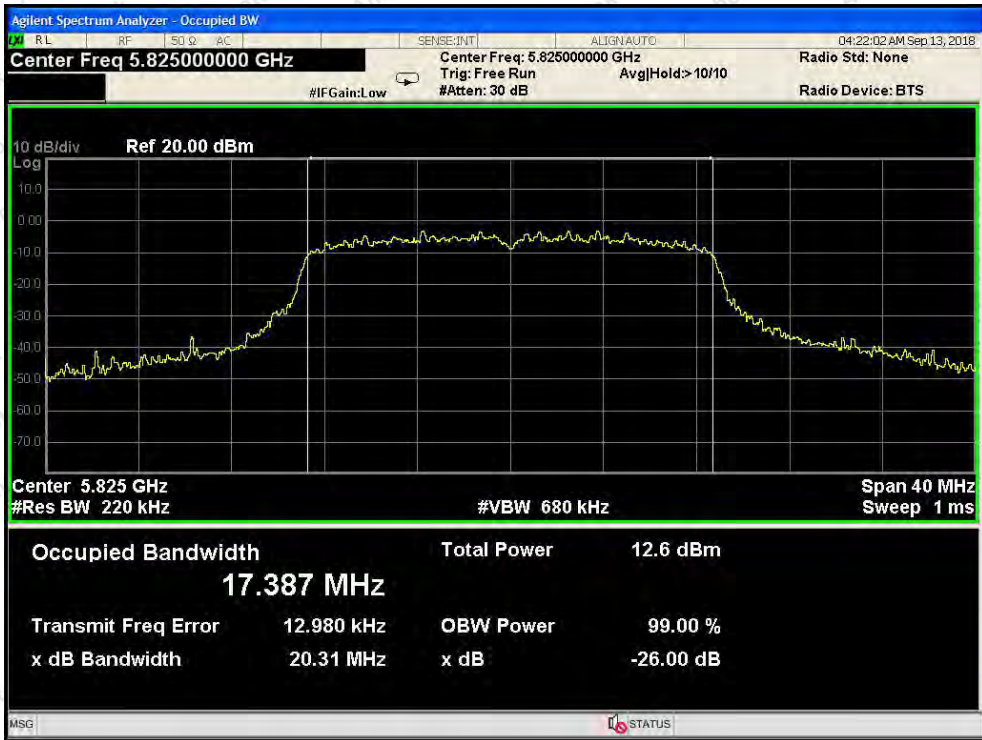

Test Mode: 802.11n20---High

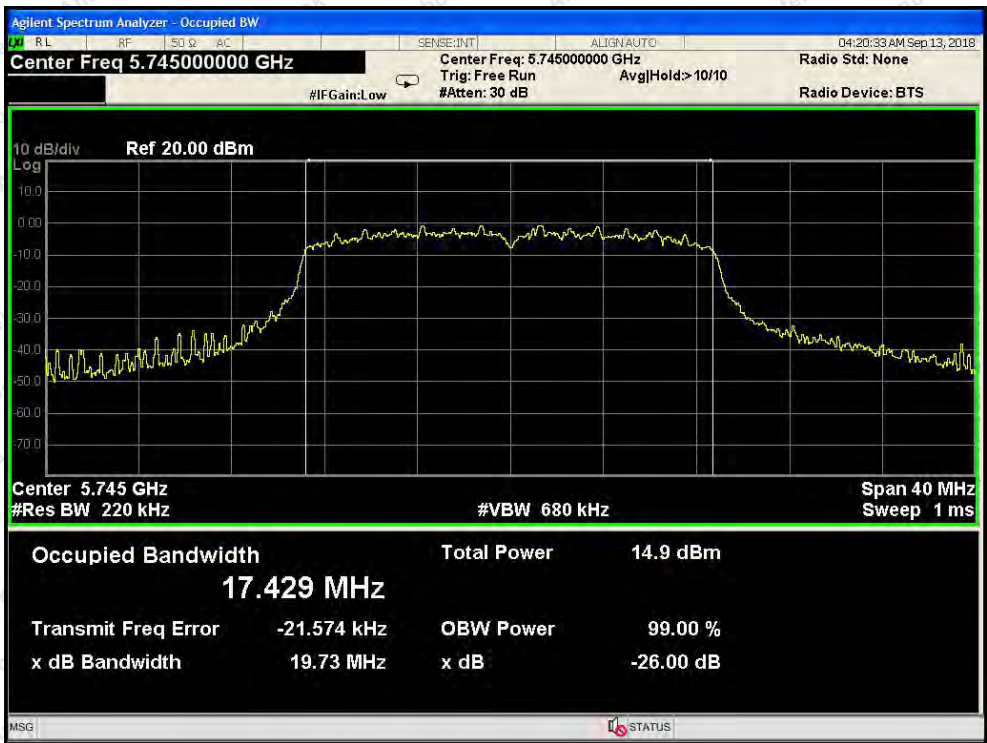

Test Mode: 802.11ac20--Low



Test Mode: 802.11ac20---Middle

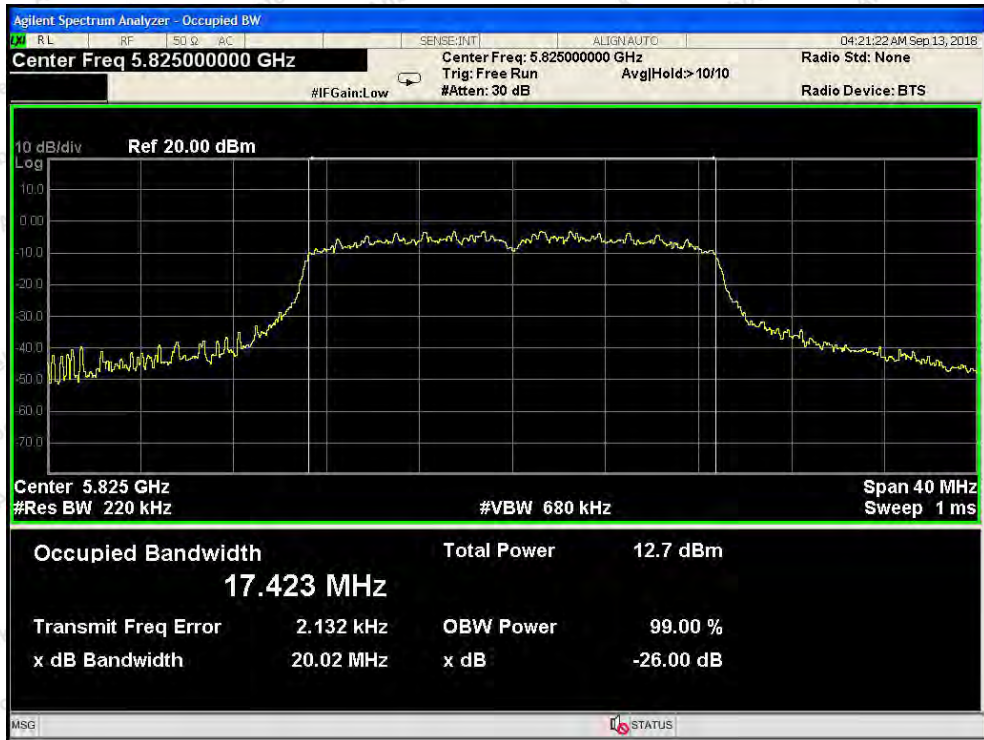

Test Mode: 802.11ac20---High



Test Mode: 802.11n40---Low

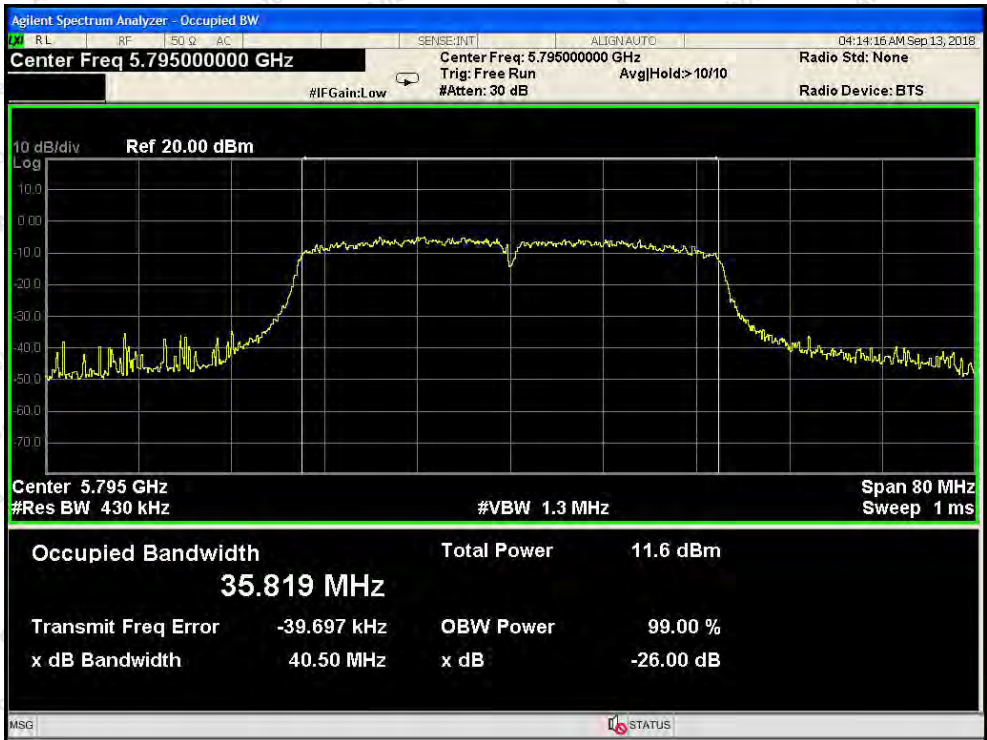

Test Mode: 802.11n40---High

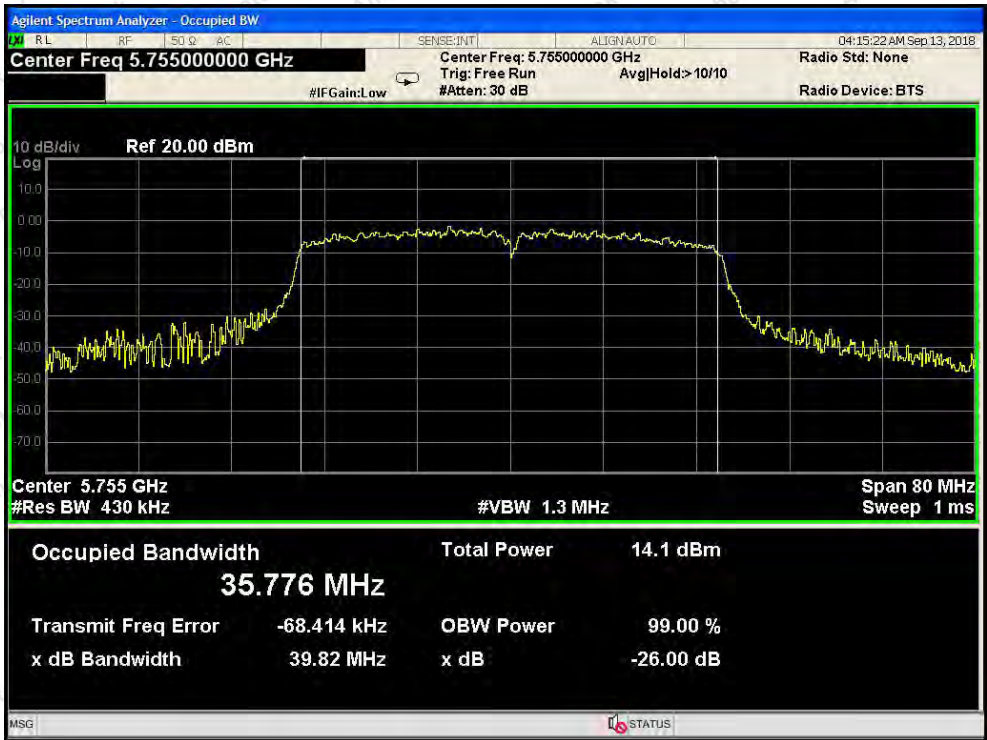

Test Mode: 802.11ac40---Low

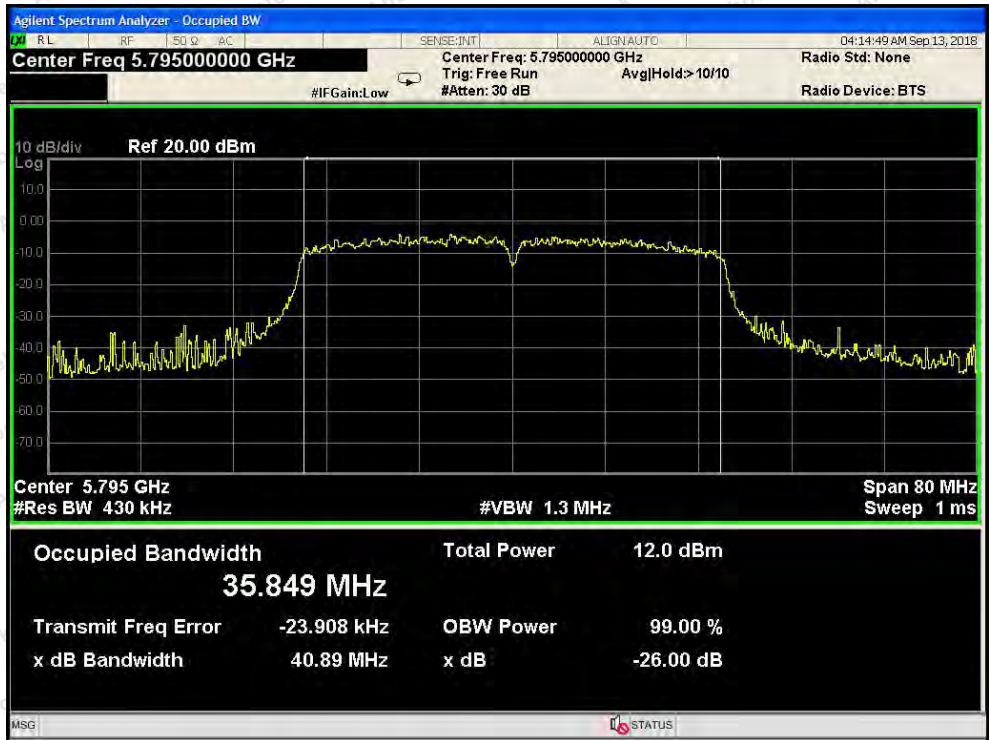

Test Mode: 802.11ac40---High

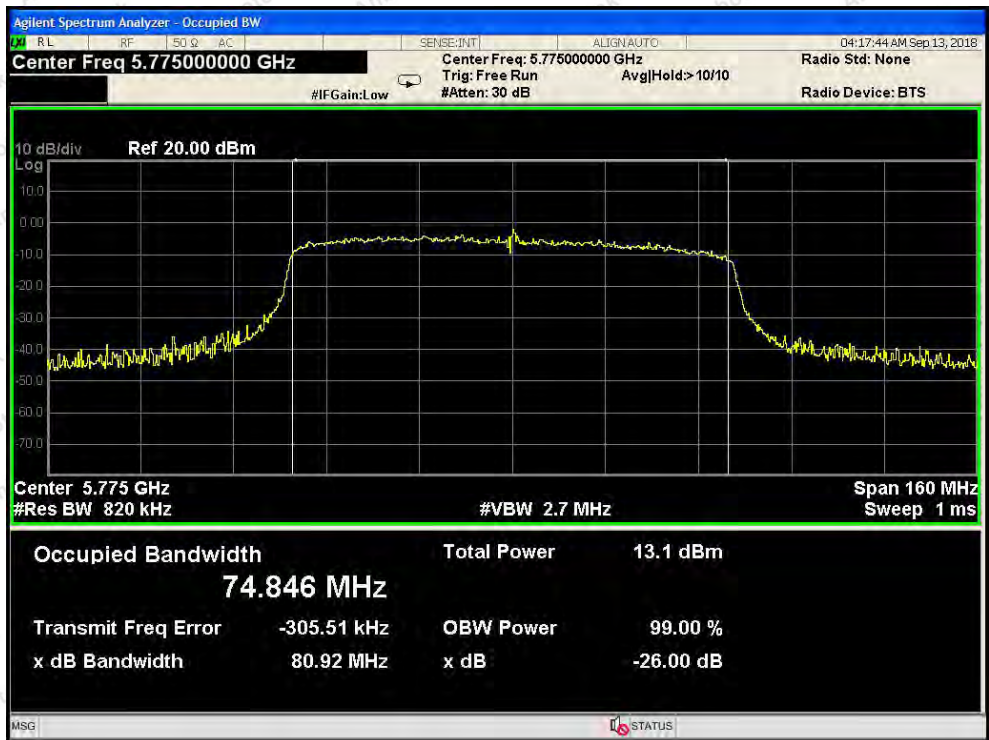

Test Mode: 802.11ac80

7. Power Spectral Density Test

7.1. Test Standard and Limit

| | |
|---------------|-------------------------------------|
| Test Standard | FCC Part15 C Section 15.407 (a) (3) |
| Test Limit | not exceed 30dBm/500kHz |

7.2. Test Setup

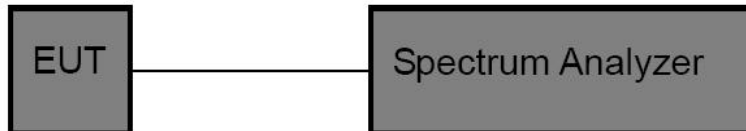

7.3. Test Procedure

For devices operating in the bands 5.15-5.25 GHz, 5.25-5.35 GHz, and 5.47-5.725 GHz, the above procedures make use of 1 MHz RBW to satisfy directly the 1 MHz reference bandwidth specified in § 15.407(a)(5). For devices operating in the band 5.725-5.85 GHz, the rules specify a measurement bandwidth of 500 kHz. Many spectrum analyzers do not have 500 kHz RBW, thus a narrower RBW may need to be used. The rules permit the use of a RBWs less than 1 MHz, or 500 kHz, “provided that the measured power is integrated over the full reference bandwidth” to show the total power over the specified measurement bandwidth (i.e., 1 MHz, or 500 kHz).

1. The EUT is directly connected to the spectrum analyzer;
2. Set RBW =510KHz;
3. Set VBW ≥ 3 RBW;
3. Set the span to encompass the entire emissions bandwidth (EBW) of the signal;
5. Detector=RMS;
6. Sweep time= auto couple;
7. Trace mode=max. hold;

7.4. Test Data

| | | | |
|--------------|-----------------------------|-------------|--------------------|
| Test Item | : Power Spectral Density | Test Mode | : CH Low ~ CH High |
| Test Voltage | : AC 120V, 60Hz for adapter | Temperature | : 24°C |
| Test Result | : PASS | Humidity | : 55%RH |

| Test Mode | Channel Frequency (MHz) | Final Power Spectral Density (dBm) | Correctional Limit (dBm) | Results |
|------------|-------------------------|------------------------------------|--------------------------|---------|
| 802.11a | 5745 | 1.230 | 30 | PASS |
| | 5785 | 0.093 | 30 | PASS |
| | 5825 | -0.540 | 30 | PASS |
| 802.11n20 | 5745 | 0.988 | 30 | PASS |
| | 5785 | 0.182 | 30 | PASS |
| | 5825 | -1.469 | 30 | PASS |
| 802.11ac20 | 5745 | 0.858 | 30 | PASS |
| | 5785 | -1.097 | 30 | PASS |
| | 5825 | -1.820 | 30 | PASS |
| 802.11n40 | 5755 | -3.107 | 30 | PASS |
| | 5795 | -4.594 | 30 | PASS |
| 802.11ac40 | 5755 | -2.586 | 30 | PASS |
| | 5795 | -4.459 | 30 | PASS |
| 802.11ac80 | 5775 | -7.537 | 30 | PASS |



Test Mode: 802.11a--Low



Test Mode: 802.11a---Middle



Test Mode: 802.11a---High



Test Mode: 802.11n20---Low



Test Mode: 802.11n20---Middle



Test Mode: 802.11n20---High



Test Mode: 802.11ac20--Low



Test Mode: 802.11ac20---Middle



Test Mode: 802.11ac20---High



Test Mode: 802.11n40---Low



Test Mode: 802.11n40---High



Test Mode: 802.11ac40---Low



Test Mode: 802.11ac40---High



Test Mode: 802.11ac80

8. Antenna Requirement

8.1. Test Standard and Requirement

| | |
|---------------|---|
| Test Standard | FCC Part15 Section 15.203 /15.407 |
| Requirement | <p>1) 15.203 requirement: An intentional radiator shall be designed to ensure that no antenna other than that furnished by the responsible party shall be used with the device. The use of a permanently attached antenna or of an antenna that uses a unique coupling to the intentional radiator, the manufacturer may design the unit so that a broken antenna can be replaced by the user, but the use of a standard antenna jack or electrical connector is prohibited.</p> <p>2) 15.407 requirement: An intentional radiator shall be designed to ensure that no antenna other than that furnished by the responsible party shall be used with the device. The use of a permanently attached antenna or of an antenna that uses a unique coupling to the intentional radiator shall be considered sufficient to comply with the provisions of this section. The manufacturer may design the unit so that a broken antenna can be replaced by the user, but the use of a standard antenna jack or electrical connector is prohibited. This requirement does not apply to carrier current devices or to devices operated under the provisions of §15.211, §15.213, §15.217, §15.219, or §15.221. Further, this requirement does not apply to intentional radiators that must be professionally installed, such as perimeter protection systems and some field disturbance sensors, or to other intentional radiators which, in accordance with §15.31(d), must be measured at the installation site. However, the installer shall be responsible for ensuring that the proper antenna is employed so that the limits in this part are not exceeded.</p> |

8.2. Antenna Connected Construction

The WIFI antenna is an FPCB Antenna which permanently attached, and the best case gain of the antenna is 2.5 dBi each antenna (It is reduced power treatment). It complies with the standard requirement.



APPENDIX I-- TEST SETUP PHOTOGRAPH

Photo of Conducted Emission Measurement



Photo of Radiation Emission Test

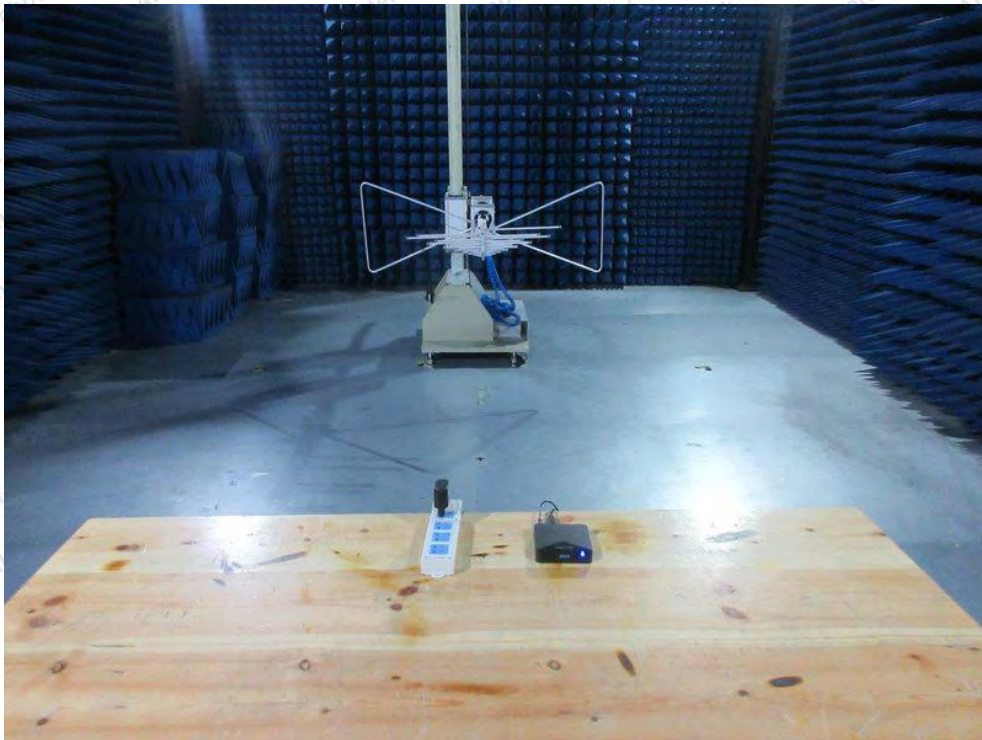



APPENDIX II -- EXTERNAL PHOTOGRAPH









APPENDIX III -- INTERNAL PHOTOGRAPH

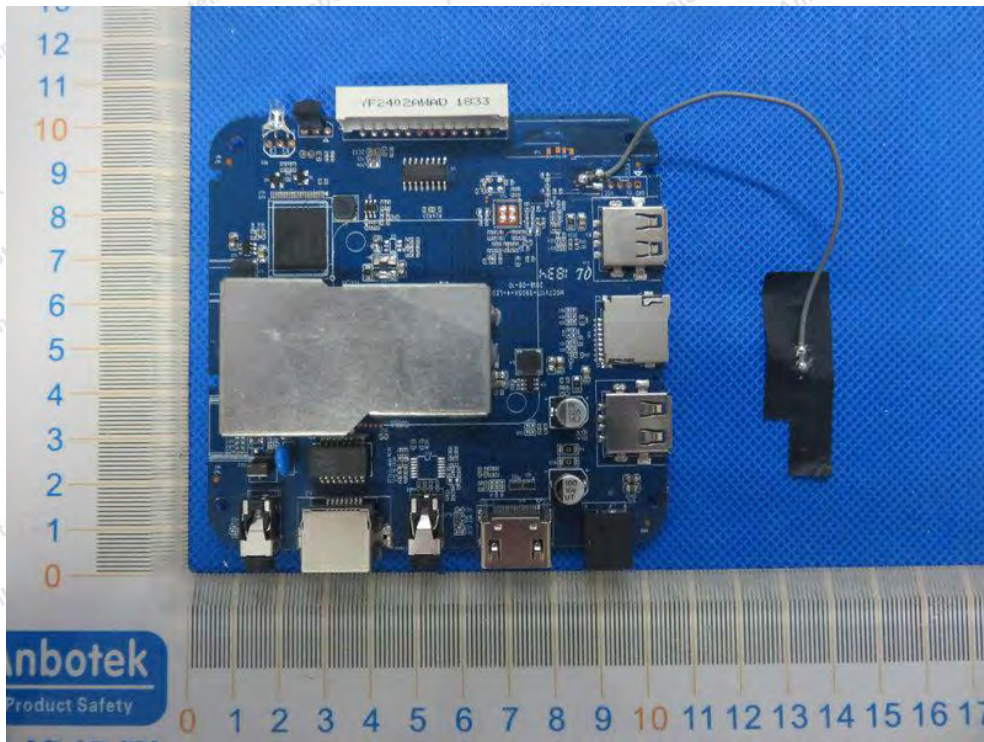

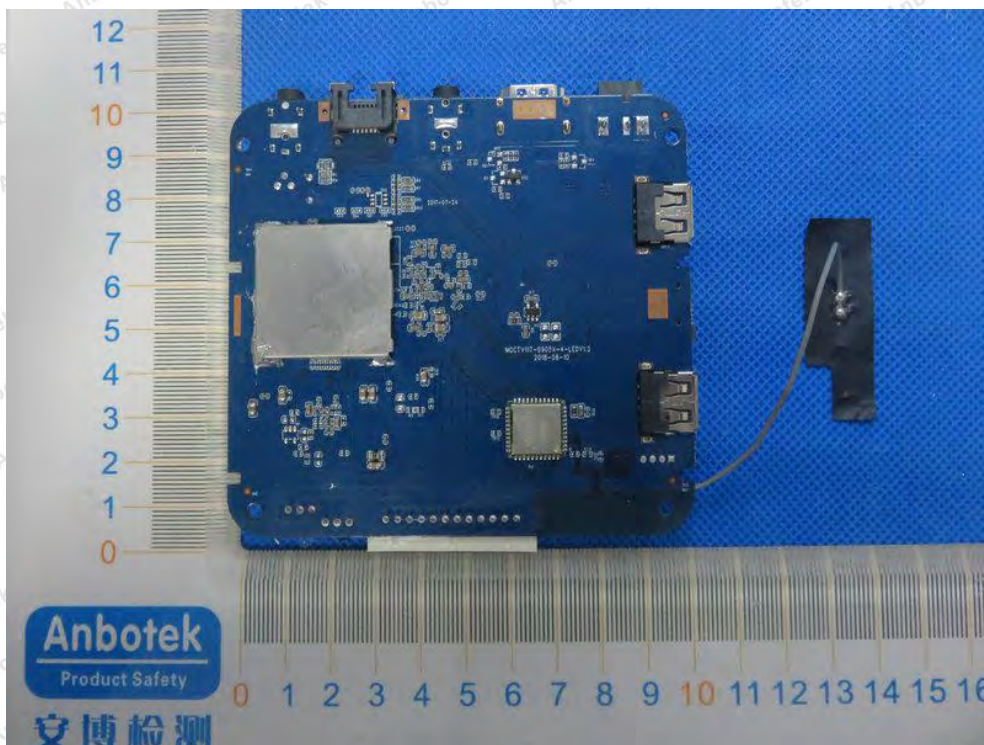

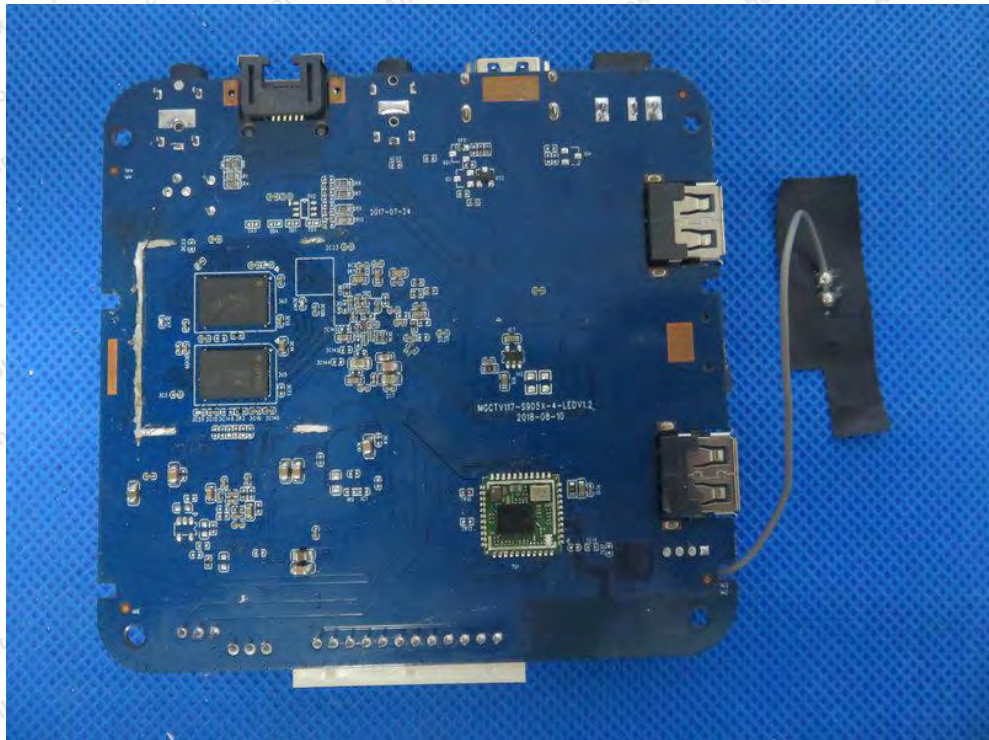
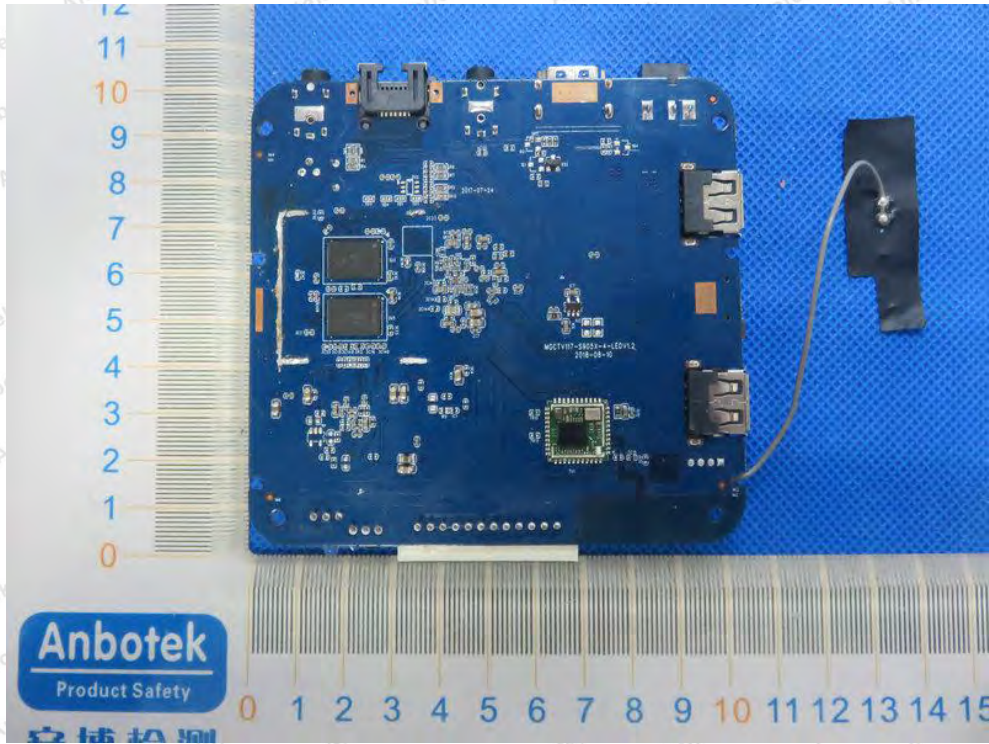

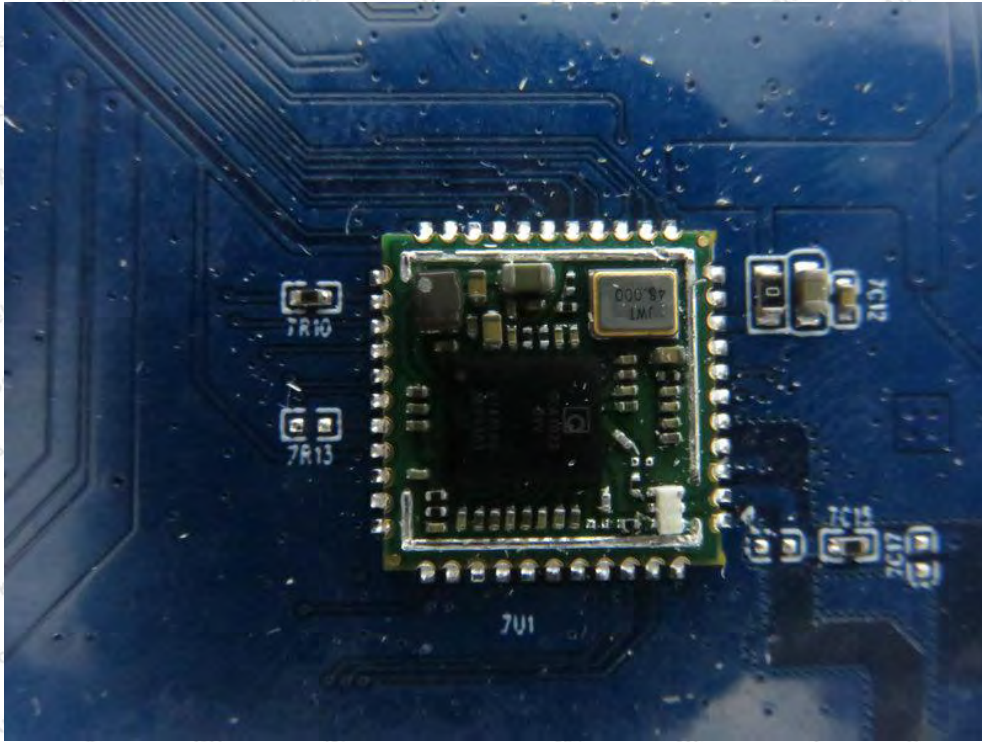

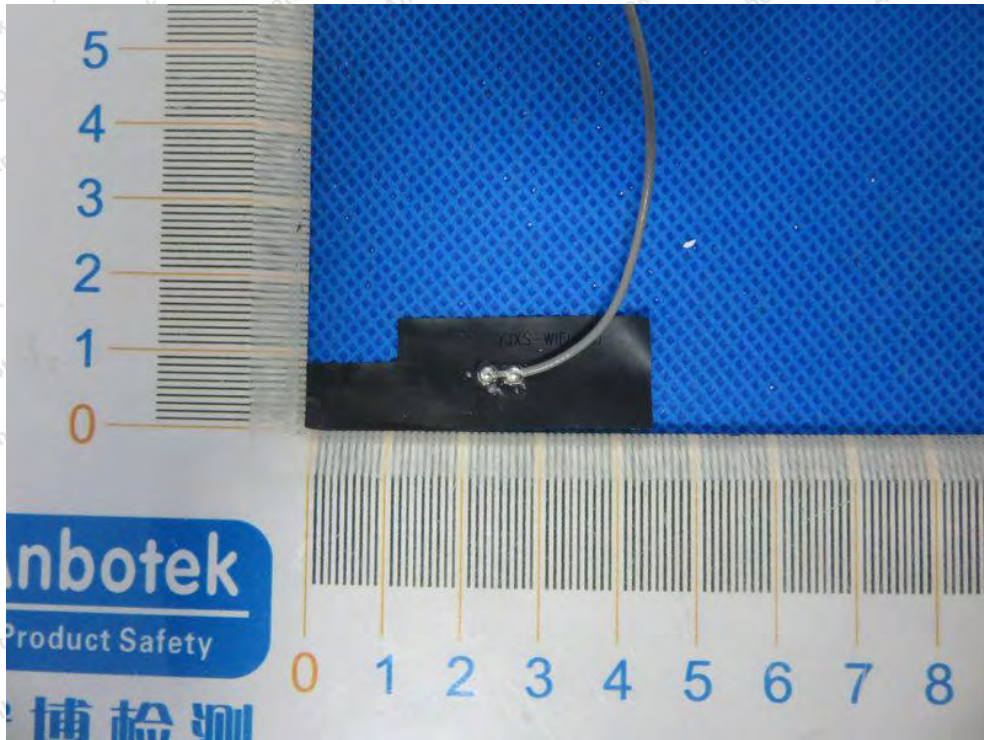
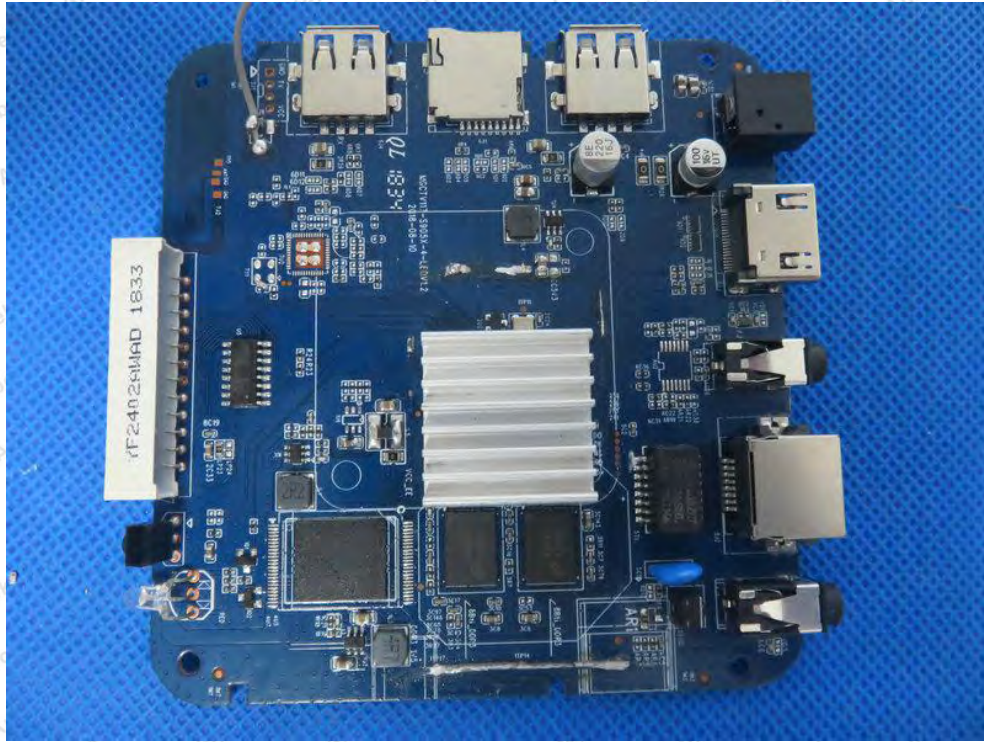

----- End of Report -----