

FCC TEST REPORT

For
SHENZHEN MAGICSEE TECHNOLOGY CO., LTD.
Android TV box
Model No.: N5, N5MAX, N6MAX

Prepared For : SHENZHEN MAGICSEE TECHNOLOGY CO., LTD.
Address : No 242 Building 4, Xixiang Road, Baoan District, Shenzhen City,
Guangdong Province, China

Prepared By : Shenzhen Anbotek Compliance Laboratory Limited
Address : 1/F, Building D, Sogood Science and Technology Park, Sanwei
community, Hangcheng Street, Bao'an District, Shenzhen, Guangdong,
China.518102
Tel: (86) 755-26066440 Fax: (86) 755-26014772

Report Number : SZAWW180831003-01
Date of Receipt : Aug. 31, 2018
Date of Test : Aug. 31~Sept. 28, 2018
Date of Report : Sept. 28, 2018

Contents

1. General Information.....	5
1.1. Client Information.....	5
1.2. Description of Device (EUT).....	5
1.3. Auxiliary Equipment Used During Test.....	6
1.4. Description of Test Modes.....	7
1.5. List of channels.....	8
1.6. Description Of Test Setup.....	9
1.7. Test Equipment List.....	10
1.8. Description of Test Facility.....	11
2. Summary of Test Results.....	12
3. Conducted Emission Test.....	13
3.1. Test Standard and Limit.....	13
3.2. Test Setup.....	13
3.3. Test Procedure.....	13
3.4. Test Data.....	13
4. Radiation Spurious Emission and Band Edge.....	18
4.1. Test Standard and Limit.....	18
4.2. Test Setup.....	18
4.3. Test Procedure.....	19
4.4. Test Data.....	20
5. Maximum Peak Output Power Test.....	32
5.1. Test Standard and Limit.....	32
5.2. Test Setup.....	32
5.3. Test Procedure.....	32
5.4. Test Data.....	32
6. 6DB Occupy Bandwidth Test.....	36
6.1. Test Standard and Limit.....	36
6.2. Test Setup.....	36
6.3. Test Procedure.....	36
6.4. Test Data.....	36
7. Power Spectral Density Test.....	44
7.1. Test Standard and Limit.....	44
7.2. Test Setup.....	44
7.3. Test Procedure.....	44
7.4. Test Data.....	44
8. 100kHz Bandwidth of Frequency Band Edge Requirement.....	51
8.1. Test Standard and Limit.....	51
8.2. Test Setup.....	51
8.3. Test Procedure.....	51
8.4. Test Data.....	51
9. Antenna Requirement.....	62
9.1. Test Standard and Requirement.....	62

9.2. Antenna Connected Construction..... 62
APPENDIX I -- TEST SETUP PHOTOGRAPH..... 63
APPENDIX II -- EXTERNAL PHOTOGRAPH..... 65
APPENDIX III -- INTERNAL PHOTOGRAPH..... 69

TEST REPORT

Applicant : SHENZHEN MAGICSEE TECHNOLOGY CO., LTD.
Manufacturer : SHENZHEN MAGICSEE TECHNOLOGY CO., LTD.
Product Name : Android TV box
Model No. : N5, N5MAX, N6MAX
Trade Mark : Magicsee
Rating(s) : (via adapter input: AC 100~240V, 50/60Hz ,0.5A; output: DC 5V, 2A)

Test Standard(s) : **FCC Part15 Subpart C 2017, Section 15.247**
Test Method(s) : **ANSI C63.10: 2013, KDB558074 D01 DTS Meas Guidance v04**

The device described above is tested by Shenzhen Anbotek Compliance Laboratory Limited to determine the maximum emission levels emanating from the device and the severe levels of the device can endure and its performance criterion. The measurement results are contained in this test report and Shenzhen Anbotek Compliance Laboratory Limited is assumed full of responsibility for the accuracy and completeness of these measurements. Also, this report shows that the EUT (Equipment Under Test) is technically compliant with the FCC Part 15 Subpart C requirements.

This report applies to above tested sample only and shall not be reproduced in part without written approval of Shenzhen Anbotek Compliance Laboratory Limited.

Date of Test Aug. 31~Sept. 28, 2018

Prepared by

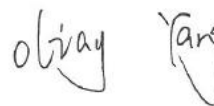

(Engineer / Oliay Yang)

Reviewer

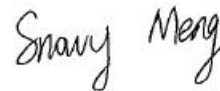

(Supervisor / Snowy Meng)

Approved & Authorized Signer



(Manager / Sally Zhang)

1. General Information

1.1. Client Information

Applicant	:	SHENZHEN MAGICSEE TECHNOLOGY CO., LTD.
Address	:	No 242 Building 4, Xixiang Road, Baoan District, Shenzhen City, Guangdong Province, China
Manufacturer	:	SHENZHEN MAGICSEE TECHNOLOGY CO., LTD.
Address	:	No 242 Building 4, Xixiang Road, Baoan District, Shenzhen City, Guangdong Province, China
Factory	:	SHENZHEN MAGICSEE TECHNOLOGY CO., LTD.
Address	:	No 242 Building 4, Xixiang Road, Baoan District, Shenzhen City, Guangdong Province, China

1.2. Description of Device (EUT)

Product Name	:	Android TV box
Model No.	:	N5, N5MAX, N6MAX (Note: All samples are the same except the solutions, so we prepare "N5" for test only.)
Trade Mark	:	Magicsee
Test Power Supply	:	AC 240V, 60Hz for adapter/ AC 120V, 60Hz for adapter
Test Sample No.	:	S1(Normal Sample), S2(Engineering Sample)
Product Description	Operation Frequency:	802.11b/ g/ n(HT20) 2412-2462MHz 802.11n(HT40) 2422-2452MHz
	Number of Channel:	11 Channels for 802.11b/ g/ n(HT20) 7 Channels for 802.11n(HT40)
	Modulation Type:	802.11b CCK; 802.11g/n OFDM
	Antenna Type:	FPCB Antenna
	Antenna Gain(Peak):	2.5 dBi
<p>Remark: 1) For a more detailed features description, please refer to the manufacturer's specifications or the User's Manual. 2) This report is for Wifi 2.4G.</p>		

1.3. Auxiliary Equipment Used During Test

Keyboard	:	Manufacturer: DELL
		M/N: SK-8120 S/N: CN-0DJ365-71616-49J-0MVR-A00 Input Rating: DC 5V, 0.05A CE, FCC, VCCI, KCC, TUV-GS Cable: 1.8m, unshielded
Mouse	:	Manufacturer: DELL M/N: MS111-T S/N: CN-0KW2YH-71616-488-1CBJ Input Rating: DC 5V, 0.1A Cable: 1.8m, unshielded CE, FCC, VCCI, KCC, TUV-GS
Adapter	:	Model: DZD-5020 Input: 100~240Vac 50/60Hz Output: DC 5V, 2000mA
TV	:	Manufacturer: SONY M/N: KDL-26EX550 S/N: 1012240 CE, FCC: DOC

1.4. Description of Test Modes

To investigate the maximum EMI emission characteristics generated from EUT, the test system was pre-scanned based on the consideration of following EUT operation mode or test configuration mode which possibly have effect on EMI emission level. Each of these EUT operation mode(s) or test configuration mode(s) mentioned above was evaluated respectively.

RADIATED EMISSION TEST (BELOW 1GHz):

Pre-Scan has been conducted to determine the worst-case mode from all possible combinations between available modulations, data rates, XYZ axis and antenna ports (if EUT with antenna diversity architecture).

Following channel(s) was (were) selected for the final test as listed below.

Mode	Available Channel	Test Channel	Modulation Tech.	Modulation Type	Data Rate (Mbps)
802.11b	1 to 11	1	CCK	DBPSK	1.0

For the test results, only the worst case was shown in test report.

RADIATED EMISSION TEST (ABOVE 1GHz):

Pre-Scan has been conducted to determine the worst-case mode from all possible combinations between available modulations, data rates, XYZ axis and antenna ports (if EUT with antenna diversity architecture).

Following channel(s) was (were) selected for the final test as listed below.

Mode	Available Channel	Test Channel	Modulation Tech.	Modulation Type	Data Rate (Mbps)
802.11b	1 to 11	1, 6, 11	CCK	DBPSK	1.0
802.11g	1 to 11	1, 6, 11	OFDM	BPSK	6.0
802.11n HT20	1 to 11	1, 6, 11	OFDM	BPSK	6.5
802.11n HT40	3 to 9	3, 6, 9	OFDM	BPSK	13.5

POWER LINE CONDUCTED EMISSION TEST:

The EUT was tested with the following mode

EUT configure mode	Test Mode
-	Keeping TX mode

BANDEDGE MEASUREMENT:

Pre-Scan has been conducted to determine the worst-case mode from all possible combinations between available modulations, data rates and antenna ports (if EUT with antenna diversity architecture).

Following channel(s) was (were) selected for the final test as listed below.

Mode	Available Channel	Test Channel	Modulation Tech.	Modulation Type	Data Rate (Mbps)
802.11b	1 to 11	1, 11	CCK	DBPSK	1.0
802.11g	1 to 11	1, 11	OFDM	BPSK	6.0
802.11n HT20	1 to 11	1, 11	OFDM	BPSK	6.5
802.11n HT40	3 to 9	3, 9	OFDM	BPSK	13.5

ANTENNA PORT CONDUCTED MEASUREMENT:

This item includes all test value of each mode, but only includes spectrum plot of worst value of each mode.

Pre-Scan has been conducted to determine the worst-case mode from all possible combinations between available modulations, data rates and antenna ports (if EUT with antenna diversity architecture).

Following channel(s) was (were) selected for the final test as listed below.

Mode	Available Channel	Test Channel	Modulation Tech.	Modulation Type	Data Rate (Mbps)
802.11b	1 to 11	1, 6, 11	CCK	DBPSK	1.0
802.11g	1 to 11	1, 6, 11	OFDM	BPSK	6.0
802.11n HT20	1 to 11	1, 6, 11	OFDM	BPSK	6.5
802.11n HT40	3 to 9	3,6, 9	OFDM	BPSK	13.5

1.5. List of channels

Channel	Freq. (MHz)	Channel	Freq. (MHz)	Channel	Freq. (MHz)	Channel	Freq. (MHz)
01	2412	04	2427	07	2442	10	2457
02	2417	05	2432	08	2447	11	2462
03	2422	06	2437	09	2452		

1.6. Description Of Test Setup

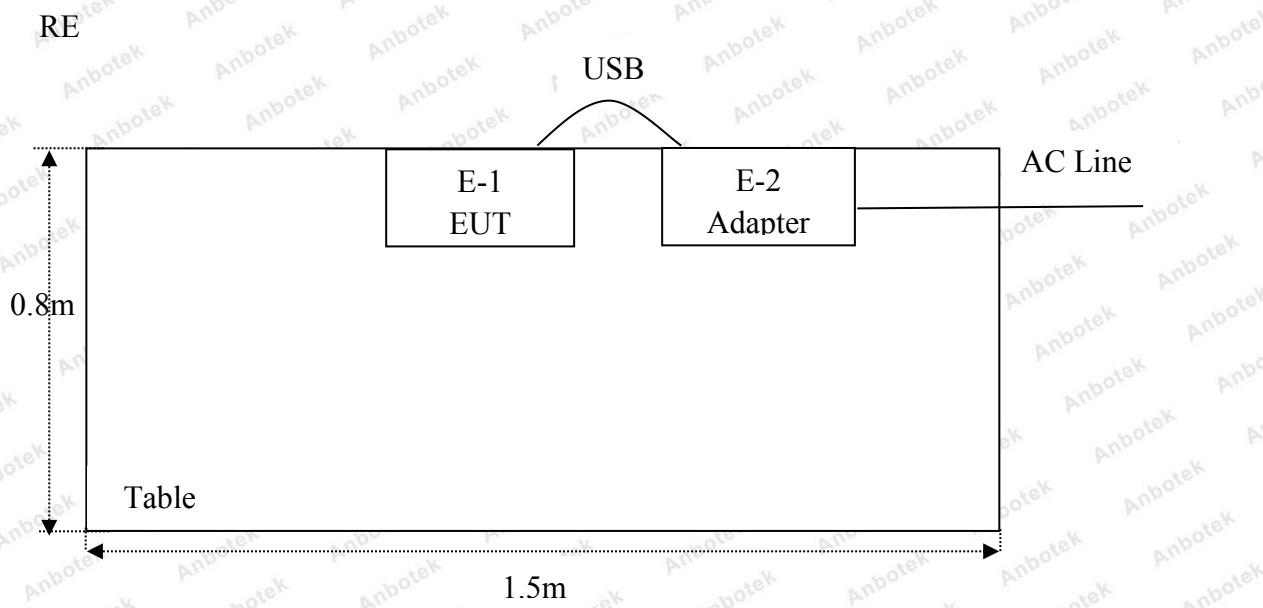
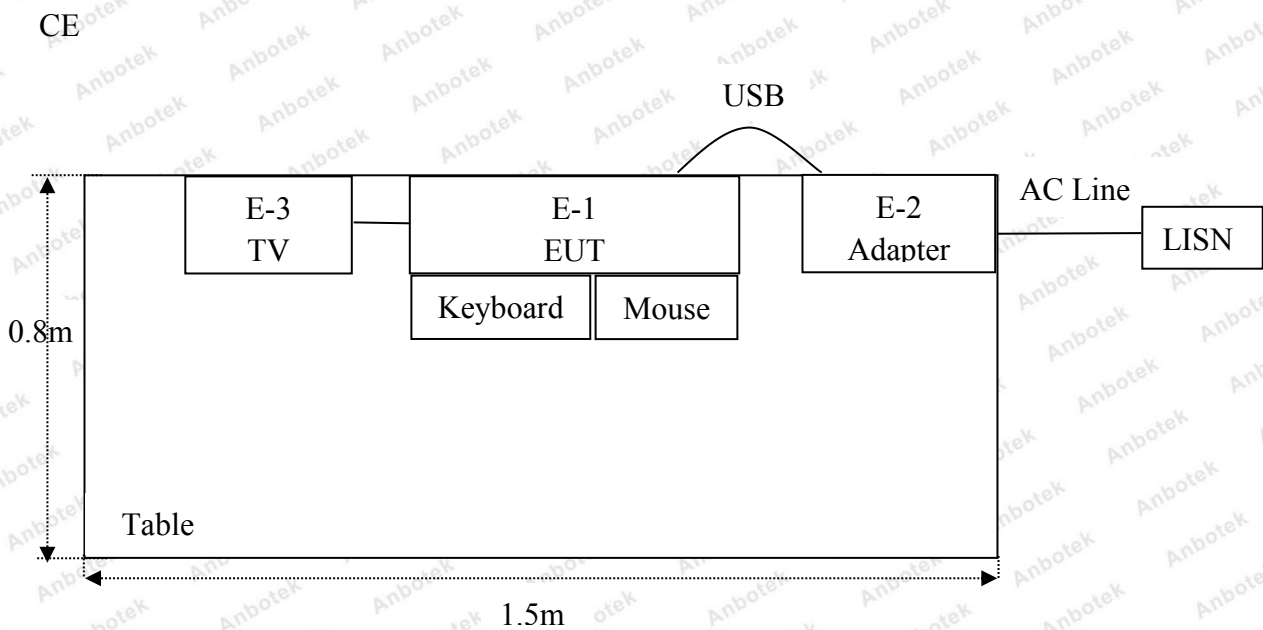

1.7. Test Equipment List

Item	Equipment	Manufacturer	Model No.	Serial No.	Last Cal.	Cal. Interval
1.	L.I.S.N. Artificial Mains Network	Rohde & Schwarz	ENV216	100055	Nov. 17, 2017	1 Year
2.	EMI Test Receiver	Rohde & Schwarz	ESCI	100627	Nov. 17, 2017	1 Year
3.	RF Switching Unit	Compliance Direction	RSU-M2	38303	Nov. 17, 2017	1 Year
4.	Spectrum Analysis	Agilent	E4407B	US39390582	Nov. 17, 2017	1 Year
5.	MAX Spectrum Analysis	Agilent	N9020A	MY51170037	Nov. 18, 2017	1 Year
6.	Preamplifier	SKET Electronic	BK1G18G30D	KD17503	Nov. 17, 2017	1 Year
7.	Double Ridged Horn Antenna	Instruments corporation	GTH-0118	351600	Nov. 20, 2017	1 Year
8.	Bilog Broadband Antenna	Schwarzbeck	VULB9163	VULB 9163-289	Nov. 20, 2017	1 Year
9.	Loop Antenna	Schwarzbeck	HFH2-Z2	100047	Nov. 17, 2017	1 Year
10.	Horn Antenna	Schwarzbeck	BBHA9170	9170-375	Nov. 17, 2017	1 Year
11.	Pre-amplifier	SONOMA	310N	186860	Nov. 17, 2017	1 Year
12.	EMI Test Software EZ-EMC	SHURPLE	N/A	N/A	N/A	N/A
13.	RF Test Control System	YIHENG	YH3000	2017430	Nov. 18, 2017	1 Year
14.	Power Sensor	DAER	RPR3006W	15I00041SN045	Nov. 17, 2017	1 Year
15.	Power Sensor	DAER	RPR3006W	15I00041SN046	Nov. 17, 2017	1 Year
16.	MXA Spectrum Analysis	Agilent	N9020A	MY51170037	Nov. 18, 2017	1 Year
17.	MXG RF Vector Signal Generator	Agilent	N5182A	MY48180656	Nov. 18, 2017	1 Year
18.	Signal Generator	Agilent	E4421B	MY41000743	Nov. 18, 2017	1 Year
19.	DC Power Supply	LW	TPR-6410D	349315	Nov. 01, 2017	1 Year
20.	Constant Temperature Humidity Chamber	Sertep	ZJ-HWHS80B	ZJ-17042804	Nov. 01, 2017	1 Year

1.8. Description of Test Facility

The test facility is recognized, certified, or accredited by the following organizations:

FCC-Registration No.: 184111

Shenzhen Anbotek Compliance Laboratory Limited, EMC Laboratory has been registered and fully described in a report filed with the (FCC) Federal Communications Commission. The acceptance letter from the FCC is maintained in our files. Registration No. 184111, July 31, 2017.

ISED-Registration No.: 8058A-1

Shenzhen Anbotek Compliance Laboratory Limited, EMC Laboratory has been registered and fully described in a report filed with the (ISED) Innovation, Science and Economic Development Canada. The acceptance letter from the ISED is maintained in our files. Registration 8058A-1, June 13, 2016.

Test Location

Shenzhen Anbotek Compliance Laboratory Limited.

1/F, Building D, Sogood Science and Technology Park, Sanwei community, Hangcheng Street, Bao'an District, Shenzhen, Guangdong, China.518102

2. Summary of Test Results

Standard Section	Test Item	Result
15.203/15.247(c)	Antenna Requirement	PASS
15.207	Conducted Emission	PASS
15.205/15.209	Spurious Emission	PASS
15.247(b)(3)	Conducted Peak Output Power	PASS
15.247(a)(2)	6dB Occupied Bandwidth	PASS
15.247(e)	Power Spectral Density	PASS
15.247(d)	Band Edge	PASS
<p>Remark: "N/A" is an abbreviation for Not Applicable. This device is a dash-cam, which is intended to be installed on a vehicle only, not connect to the public utility under normal use. 15.207 test is exempted.</p>		

3. Conducted Emission Test

3.1. Test Standard and Limit

Test Standard	FCC Part15 Section 15.207		
Test Limit	Frequency	Maximum RF Line Voltage (dBuV)	
		Quasi-peak Level	Average Level
	150kHz~500kHz	66 ~ 56 *	56 ~ 46 *
	500kHz~5MHz	56	46
	5MHz~30MHz	60	50
Remark: (1) *Decreasing linearly with logarithm of the frequency. (2) The lower limit shall apply at the transition frequency.			

3.2. Test Setup

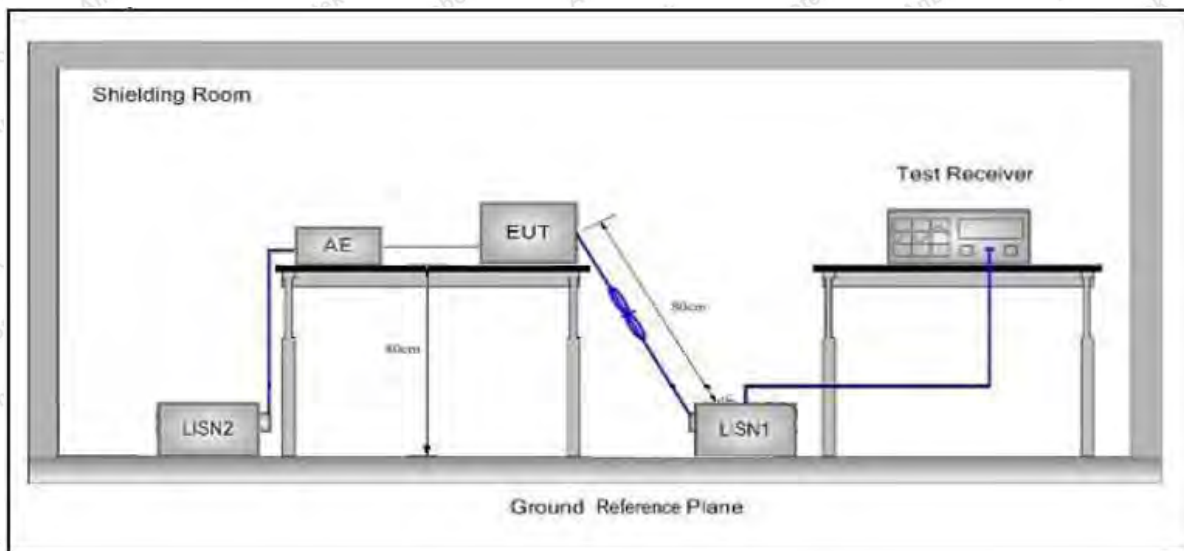

3.3. Test Procedure

The EUT system is connected to the power mains through a line impedance stabilization network (L.I.S.N.). This provides a 50ohm coupling impedance for the EUT system. Please refer the block diagram of the test setup and photographs. Both sides of AC line are checked to find out the maximum conducted emission. In order to find the maximum emission levels, the relative positions of equipment and all of the interface cables shall be changed according to FCC ANSI C63.10-2013 on Conducted Emission Measurement.

The bandwidth of test receiver (ESCI) set at 9kHz.

The frequency range from 150kHz to 30MHz is checked.

3.4. Test Data

Please to see the following pages.

Conducted Emission Test Data

Test Site: 1# Shielded Room
 Operating Condition: Keeping TX mode
 Test Specification: AC 240V, 60Hz for adapter
 Comment: Live Line
 Tem.: 24.3°C Hum.: 58%

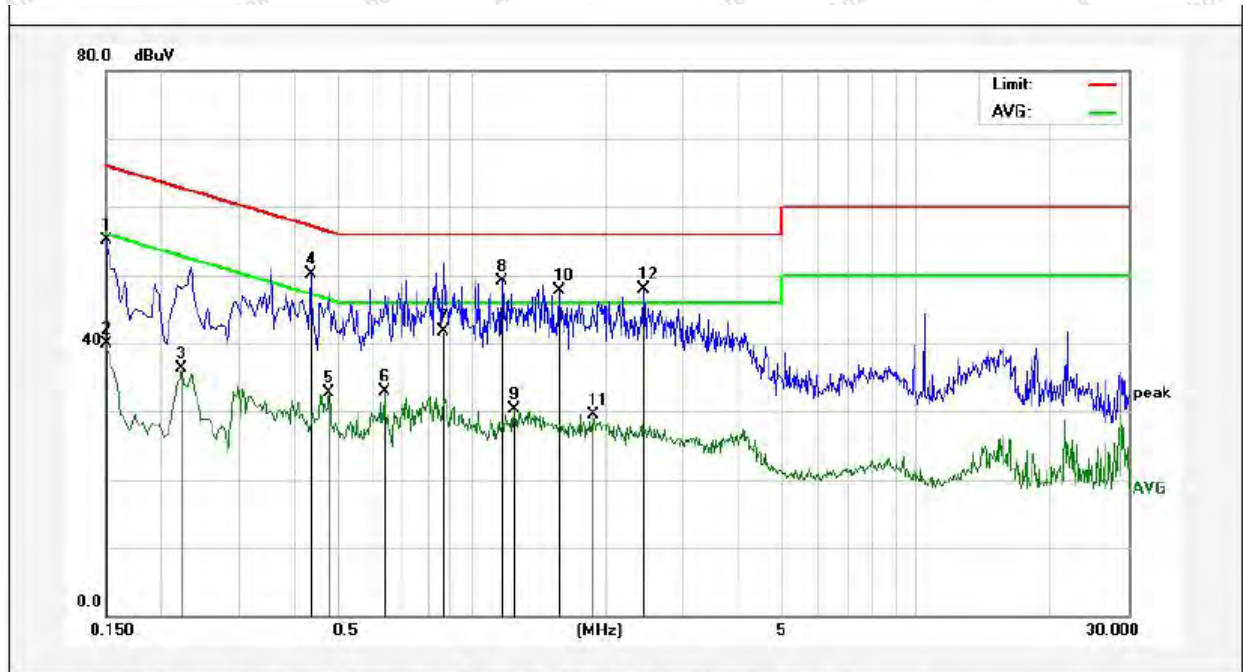

No.	Freq. (MHz)	Reading (dBuV)	Factor (dB)	Result (dBuV)	Limit dBuV	Over Limit (dB)	Detector	Remark
1	0.1500	35.26	19.90	55.16	65.99	-10.83	QP	
2	0.1500	19.95	19.90	39.85	55.99	-16.14	AVG	
3	0.2220	16.35	19.89	36.24	52.74	-16.50	AVG	
4	0.4340	30.25	19.95	50.20	57.18	-6.98	QP	
5	0.4780	12.68	19.97	32.65	46.37	-13.72	AVG	
6	0.6340	12.92	20.02	32.94	46.00	-13.06	AVG	
7	0.8660	21.54	20.08	41.62	56.00	-14.38	QP	
8	1.1700	28.96	20.12	49.08	56.00	-6.92	QP	
9	1.2460	10.18	20.12	30.30	46.00	-15.70	AVG	
10	1.5700	27.60	20.13	47.73	56.00	-8.27	QP	
11	1.8740	9.44	20.14	29.58	46.00	-16.42	AVG	
12	2.4420	27.68	20.15	47.83	56.00	-8.17	QP	

Conducted Emission Test Data

Test Site: 1# Shielded Room
 Operating Condition: Keeping TX mode
 Test Specification: AC 240V, 60Hz for adapter
 Comment: Neutral Line
 Tem.: 24.3°C Hum.: 58%

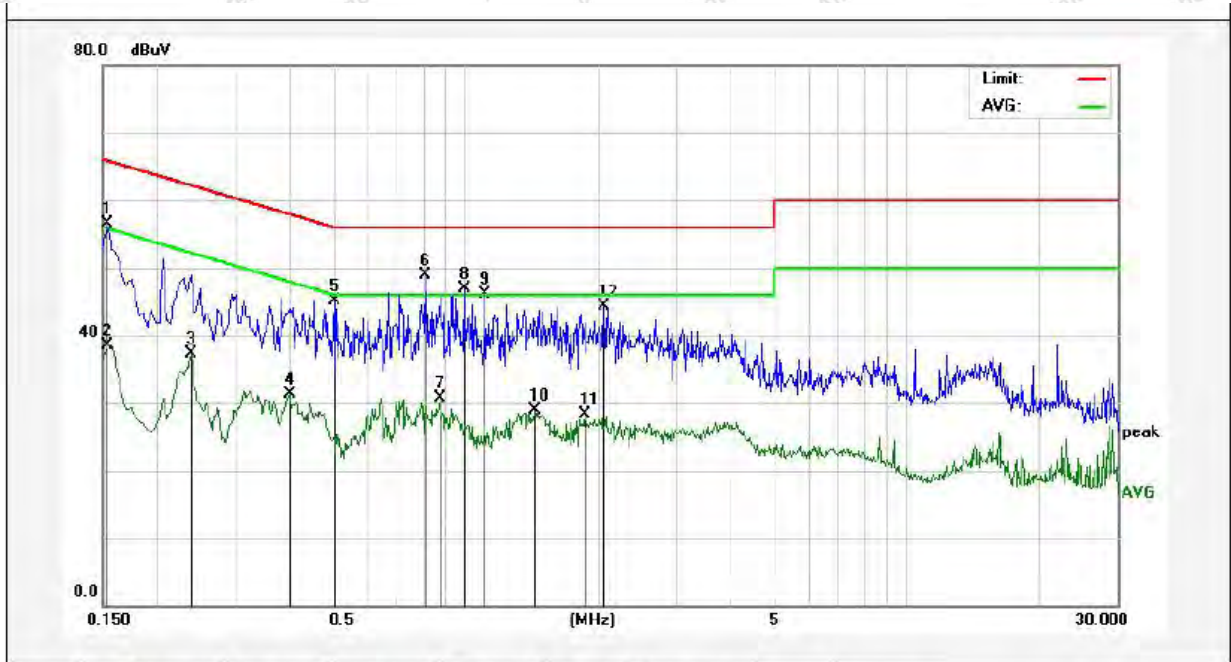

No.	Freq. (MHz)	Reading (dBuV)	Factor (dB)	Result (dBuV)	Limit dBuV	Over Limit (dB)	Detector	Remark
1	0.1539	36.65	19.90	56.55	65.78	-9.23	QP	
2	0.1539	18.69	19.90	38.59	55.78	-17.19	AVG	
3	0.2380	17.32	19.89	37.21	52.16	-14.95	AVG	
4	0.3980	11.37	19.93	31.30	47.89	-16.59	AVG	
5	0.5020	25.11	19.98	45.09	56.00	-10.91	QP	
6	0.8100	28.81	20.07	48.88	56.00	-7.12	QP	
7	0.8740	10.70	20.09	30.79	46.00	-15.21	AVG	
8	0.9940	26.69	20.12	46.81	56.00	-9.19	QP	
9	1.1060	25.92	20.12	46.04	56.00	-9.96	QP	
10	1.4380	8.81	20.13	28.94	46.00	-17.06	AVG	
11	1.8620	8.09	20.14	28.23	46.00	-17.77	AVG	
12	2.0579	24.25	20.14	44.39	56.00	-11.61	QP	

Conducted Emission Test Data

Test Site: 1# Shielded Room
 Operating Condition: Keeping TX mode
 Test Specification: AC 120V, 60Hz via adapter
 Comment: Live Line
 Tem.: 24.3°C Hum.: 58%

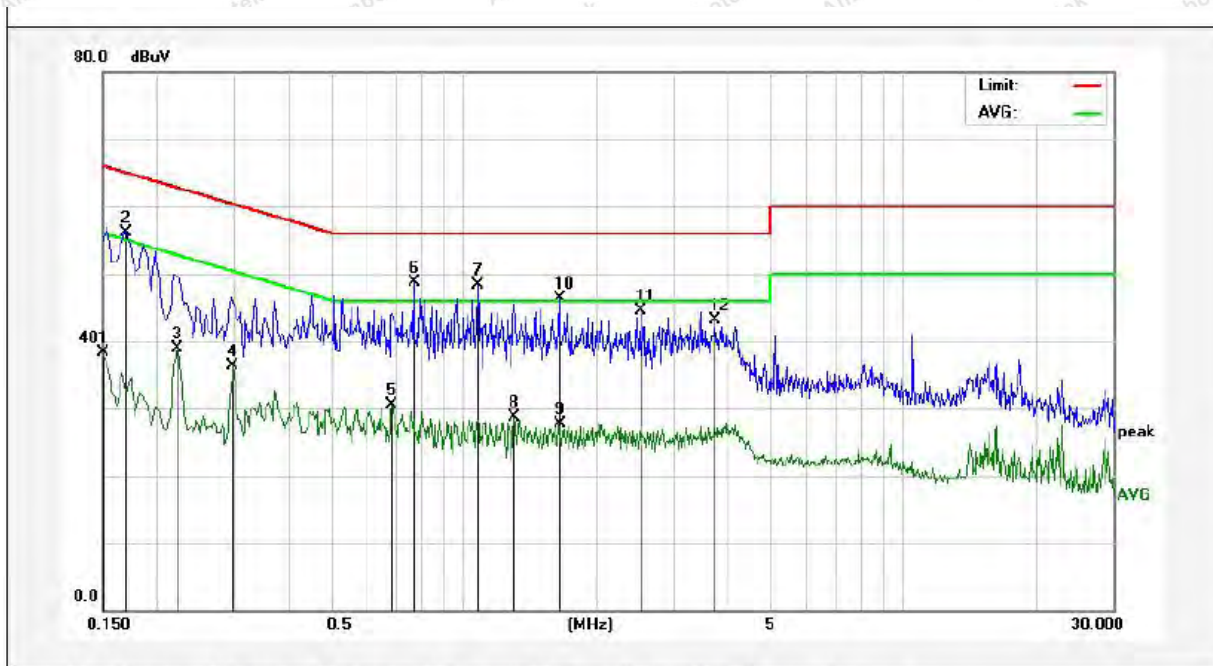

No.	Freq. (MHz)	Reading (dBUV)	Factor (dB)	Result (dBUV)	Limit dBUV	Over Limit (dB)	Detector	Remark
1	0.1500	18.34	19.90	38.24	55.99	-17.75	AVG	
2	0.1700	36.30	19.90	56.20	64.96	-8.76	QP	
3	0.2220	19.11	19.89	39.00	52.74	-13.74	AVG	
4	0.2980	16.38	19.89	36.27	50.30	-14.03	AVG	
5	0.6860	10.48	20.04	30.52	46.00	-15.48	AVG	
6	0.7700	28.57	20.06	48.63	56.00	-7.37	QP	
7	1.0740	28.25	20.12	48.37	56.00	-7.63	QP	
8	1.2980	8.57	20.13	28.70	46.00	-17.30	AVG	
9	1.6380	7.61	20.13	27.74	46.00	-18.26	AVG	
10	1.6460	26.11	20.13	46.24	56.00	-9.76	QP	
11	2.5140	24.30	20.15	44.45	56.00	-11.55	QP	
12	3.7380	22.88	20.17	43.05	56.00	-12.95	QP	

Conducted Emission Test Data

Test Site: 1# Shielded Room
 Operating Condition: Keeping TX mode
 Test Specification: AC 120V, 60Hz via adapter
 Comment: Neutral Line
 Tem.: 24.3°C Hum.: 58%

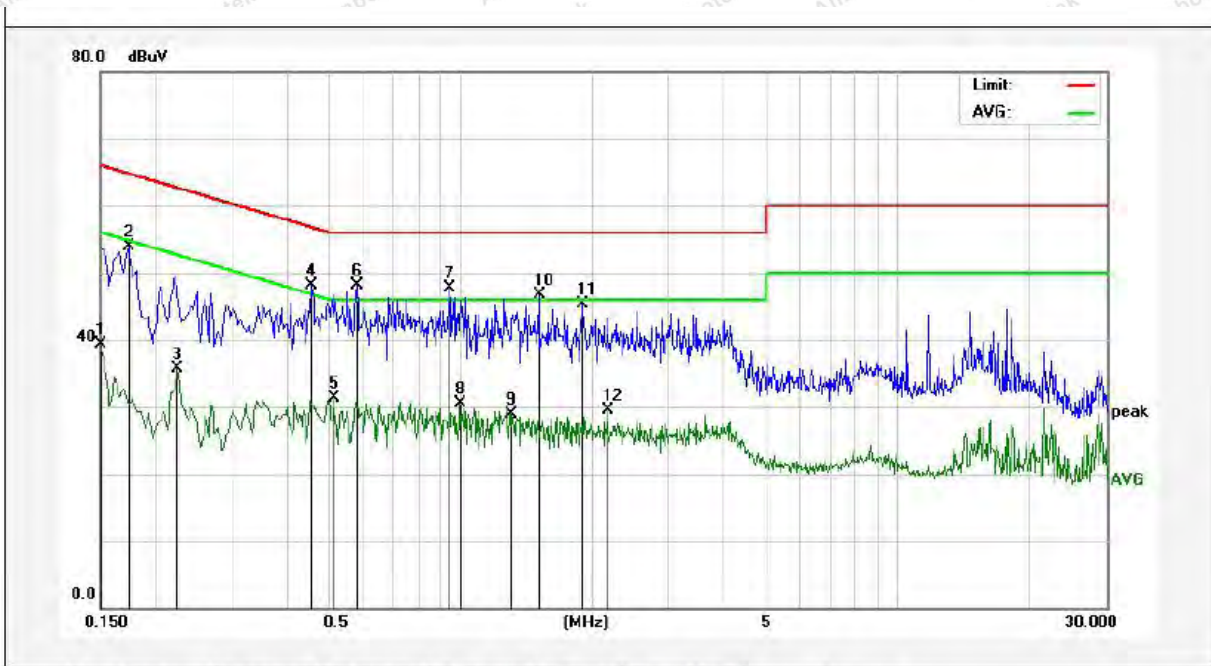

No.	Freq. (MHz)	Reading (dBuV)	Factor (dB)	Result (dBuV)	Limit dBuV	Over Limit (dB)	Detector	Remark
1	0.1500	19.42	19.90	39.32	55.99	-16.67	AVG	
2	0.1740	34.08	19.90	53.98	64.76	-10.78	QP	
3	0.2260	15.81	19.89	35.70	52.59	-16.89	AVG	
4	0.4580	28.09	19.96	48.05	56.73	-8.68	QP	
5	0.5140	11.33	19.98	31.31	46.00	-14.69	AVG	
6	0.5820	28.10	20.00	48.10	56.00	-7.90	QP	
7	0.9460	27.58	20.11	47.69	56.00	-8.31	QP	
8	0.9980	10.29	20.12	30.41	46.00	-15.59	AVG	
9	1.3140	8.87	20.13	29.00	46.00	-17.00	AVG	
10	1.5140	26.48	20.13	46.61	56.00	-9.39	QP	
11	1.9020	25.13	20.14	45.27	56.00	-10.73	QP	
12	2.1700	9.41	20.14	29.55	46.00	-16.45	AVG	

4. Radiation Spurious Emission and Band Edge

4.1. Test Standard and Limit

Test Standard	FCC Part15 C Section 15.209 and 15.205				
Test Limit	Frequency (MHz)	Field strength (microvolt/meter)	Limit (dBuV/m)	Remark	Measurement distance (m)
	0.009MHz~0.490MHz	2400/F(kHz)	-	-	300
	0.490MHz-1.705MHz	24000/F(kHz)	-	-	30
	1.705MHz-30MHz	30	-	-	30
	30MHz~88MHz	100	40.0	Quasi-peak	3
	88MHz~216MHz	150	43.5	Quasi-peak	3
	216MHz~960MHz	200	46.0	Quasi-peak	3
	960MHz~1000MHz	500	54.0	Quasi-peak	3
	Above 1000MHz	500	54.0	Average	3
-		74.0	Peak	3	

Remark:

(1)The lower limit shall apply at the transition frequency.

(2) 15.35(b), Unless otherwise specified, the limit on peak radio frequency emissions is 20dB above the maximum permitted average emission limit applicable to the equipment under test. This peak limit applies to the total peak emission level radiated by the device.

4.2. Test Setup

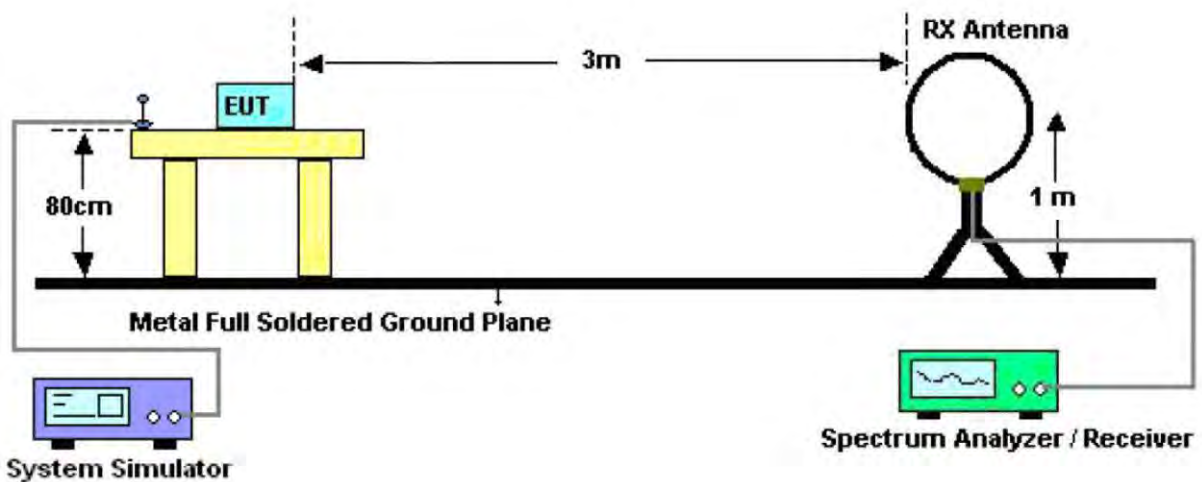

Figure 1. Below 30MHz

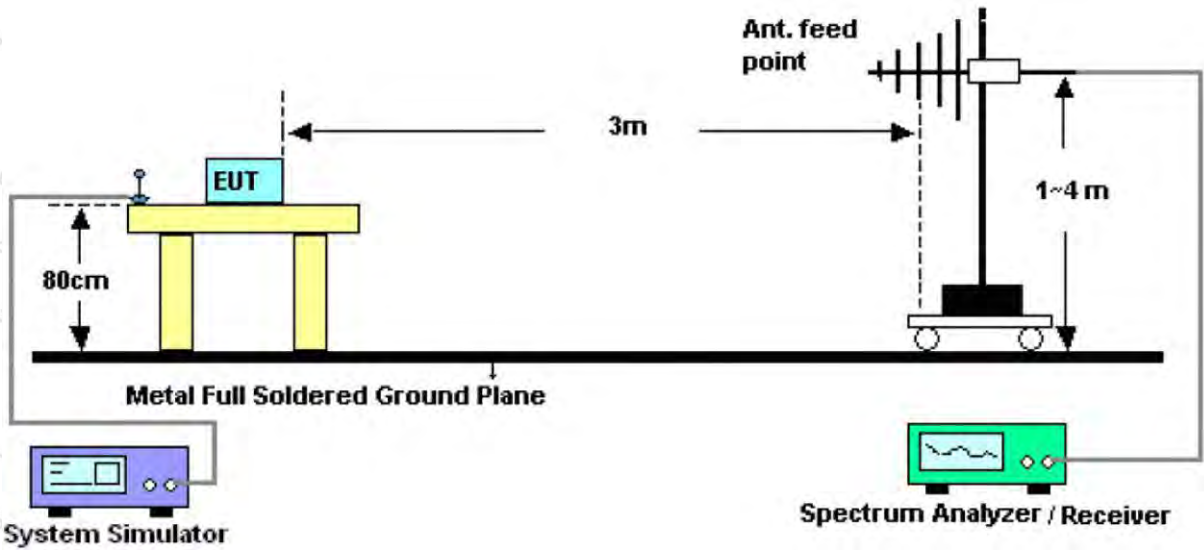

Figure 2. 30MHz to 1GHz

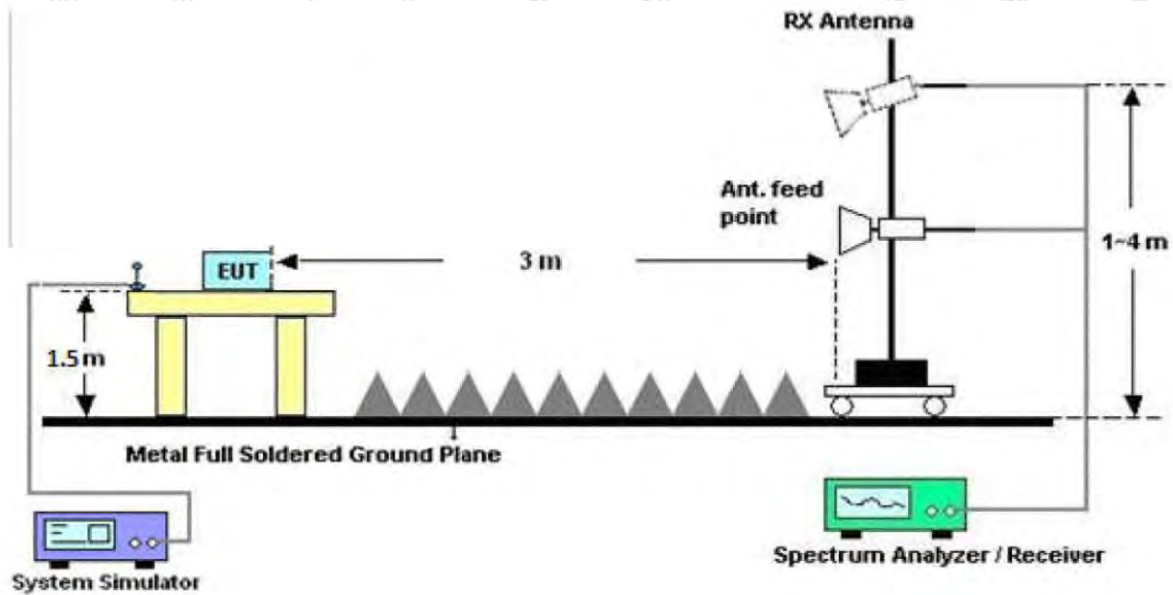

Figure 3. Above 1 GHz

4.3. Test Procedure

For below 1GHz: The EUT is placed on a turntable, which is 0.8m above the ground plane.

For above 1GHz: The EUT is placed on a turntable, which is 1.5m above the ground plane.

The turn table can rotate 360 degrees to determine the position of the maximum emission level. The EUT is set 3 meters away from the receiving antenna which is mounted on a antenna tower. The antenna can be moved up and down from 1 to 4 meters to find out the maximum emission level. Rotated the EUT through three orthogonal axes to determine the maximum emissions, both horizontal and vertical polarization of the antenna are set on test. The EUT is tested in 9*6*6 Chamber. The device is evaluated in xyz orientation.

For the radiated emission test above 1GHz:

Place the measurement antenna away from each area of the EUT determined to be a source of emissions at the specified measurement distance, while keeping the measurement antenna aimed at the source of emissions at each frequency of significant emissions, with polarization oriented for

maximum response. The measurement antenna may have to be higher or lower than the EUT, depending on the radiation pattern of the emission and staying aimed at the emission source for receiving the maximum signal. The final measurement antenna elevation shall be that which maximizes the emissions. The measurement antenna elevation for maximum emissions shall be restricted to a range of heights of from 1 m to 4 m above the ground or reference ground plane.

For 9kHz to 150kHz, Set the spectrum analyzer as:

RBW = 200Hz, VBW = 1kHz, Detector= Quasi-Peak, Trace mode= Max hold, Sweep- auto couple.

For 150kHz to 30MHz, Set the spectrum analyzer as:

RBW = 9KHz, VBW = 30kHz, Detector= Quasi-Peak, Trace mode= Max hold, Sweep- auto couple.

For 30MHz to 1000MHz, Set the spectrum analyzer as:

RBW = 100kHz, VBW = 300kHz, Detector= Quasi-Peak, Trace mode= Max hold, Sweep- auto couple.

For above 1GHz, Set the spectrum analyzer as:

RBW = 1MHz, VBW = 1MHz, Detector= Peak, Trace mode= Max hold, Sweep- auto couple.

RBW = 1MHz, VBW = 10Hz, Detector= Average, Trace mode= Max hold, Sweep- auto couple.

4.4. Test Data

PASS

During the test, Pre-scan all kind of the place mode (X-axis, Y-axis, Z-axis), and found the X-axis is the worst case.

The test results of 9kHz-30MHz was attenuated more than 20dB below the permissible limits, so the results don't record in the report.

Test Results (30~1000MHz)

Job No.: SZAWW180831003-01 Temp.(°C)/Hum.(%RH): 24.3°C/55%RH
 Standard: FCC PART 15C Power Source: AC 240V, 60Hz for adapter
 Test Mode: Keeping TX mode Polarization: Horizontal

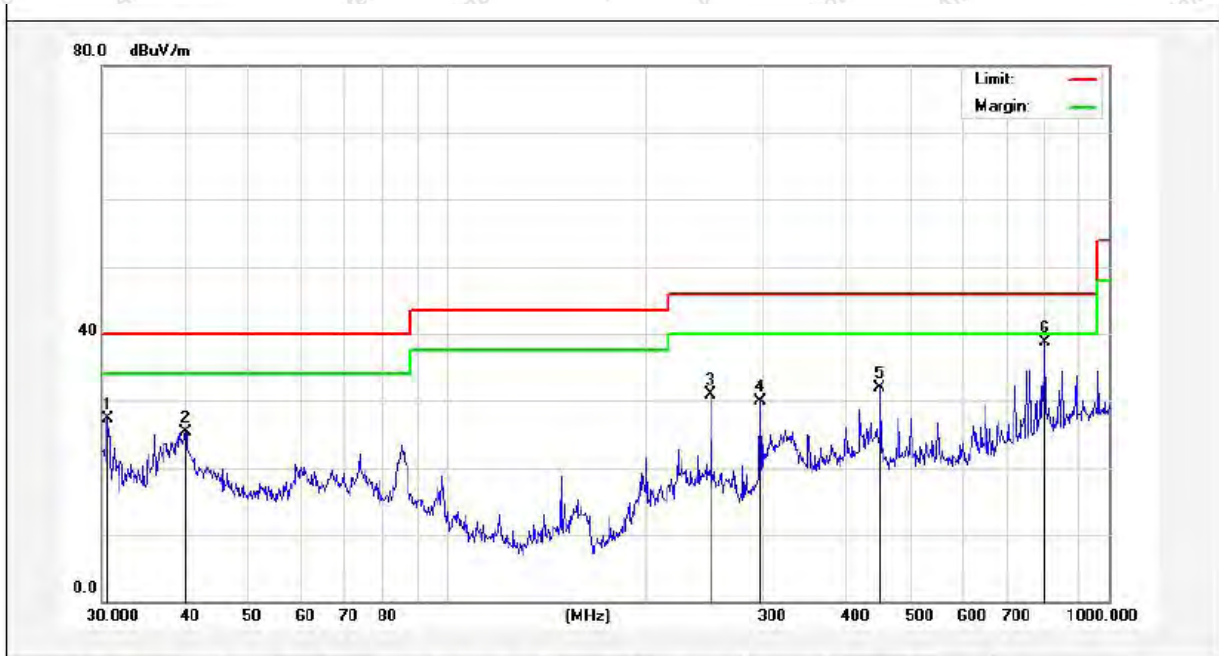

No.	Freq. (MHz)	Reading (dBuV/m)	Factor (dB/m)	Result (dBuV/m)	Limit (dBuV/)	Over Limit (dB)	Detector	Height (cm)	degree (deg)	Remark
1	30.6379	43.85	-16.61	27.24	40.00	-12.76	QP	300	12	
2	40.1347	35.78	-10.42	25.36	40.00	-14.64	QP	300	41	
3	250.3012	49.45	-18.56	30.89	46.00	-15.11	QP	300	227	
4	297.2241	47.64	-17.76	29.88	46.00	-16.12	QP	300	304	
5	451.1350	44.15	-12.15	32.00	46.00	-14.00	QP	300	247	
6	801.7863	45.22	-6.54	38.68	46.00	-7.32	QP	300	330	

Test Results (30~1000MHz)

Job No.: SZAWW180831003-01 Temp.(°C)/Hum.(%RH): 24.3°C/55%RH
 Standard: FCC PART 15C Power Source: AC 240V, 60Hz for adapter
 Test Mode: Keeping TX mode Polarization: Vertical



No.	Freq. (MHz)	Reading (dBUV/m)	Factor (dB/m)	Result (dBUV/m)	Limit (dBUV/)	Over Limit (dB)	Detector	Height (cm)	degree (deg)	Remark
1	39.9942	47.04	-10.37	36.67	40.00	-3.33	QP	300	1	
2	59.8588	40.72	-15.38	25.34	40.00	-14.66	QP	300	117	
3	98.1419	38.00	-15.86	22.14	43.50	-21.36	QP	300	235	
4	199.9856	43.23	-15.87	27.36	43.50	-16.14	QP	300	181	
5	250.3012	46.93	-14.04	32.89	46.00	-13.11	QP	300	338	
6	297.2241	49.81	-14.76	35.05	46.00	-10.95	QP	300	314	

Test Results (30~1000MHz)

Job No.: SZAWW180831003-01 Temp.(°C)/Hum.(%RH): 24.3°C/55%RH
 Standard: FCC PART 15C Power Source: AC 120V, 60Hz for adapter
 Test Mode: Keeping TX mode Polarization: Horizontal

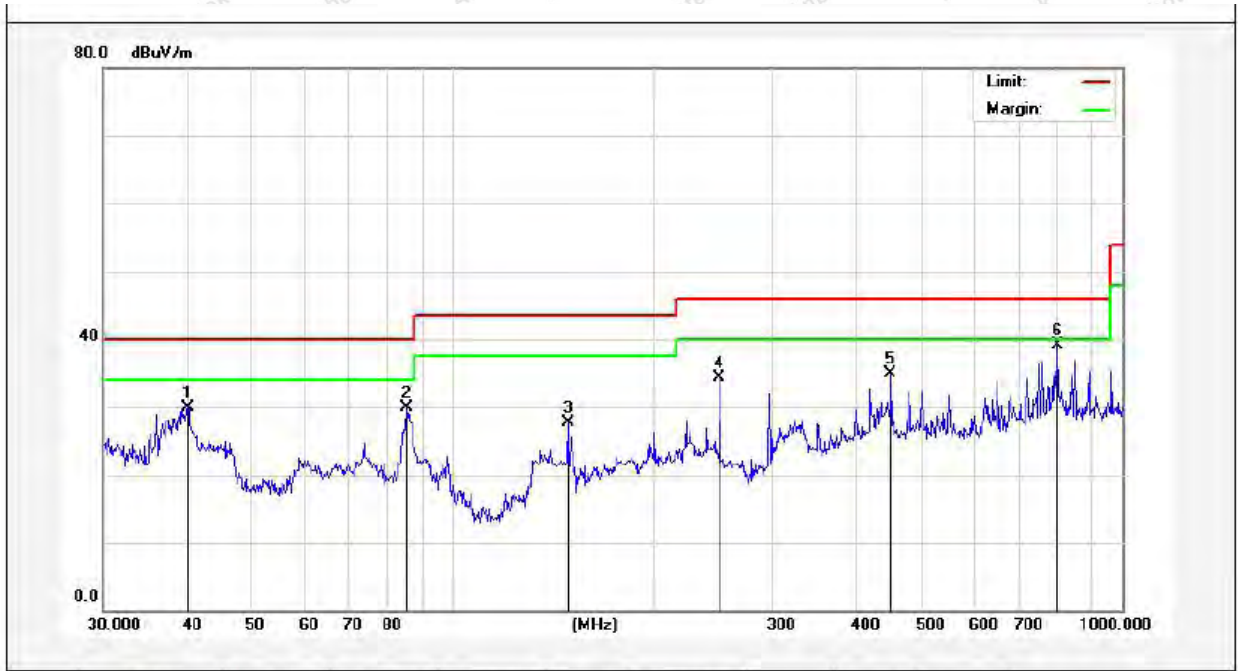

No.	Freq. (MHz)	Reading (dBuV/m)	Factor (dB/m)	Result (dBuV/m)	Limit (dBuV/)	Over Limit (dB)	Detector	Height (cm)	degree (deg)	Remark
1	40.1347	40.28	-10.42	29.86	40.00	-10.14	QP	300	33	
2	85.2980	50.38	-20.49	29.89	40.00	-10.11	QP	300	85	
3	148.4410	51.00	-23.36	27.64	43.50	-15.86	QP	300	342	
4	250.3011	52.95	-18.56	34.39	46.00	-11.61	QP	300	241	
5	451.1349	47.15	-12.15	35.00	46.00	-11.00	QP	300	168	
6	801.7862	45.72	-6.54	39.18	46.00	-6.82	QP	300	53	

Test Results (30~1000MHz)

Job No.: SZAWW180831003-01 Temp.(°C)/Hum.(%RH): 24.3°C/55%RH
 Standard: FCC PART 15C Power Source: AC 120V, 60Hz for adapter
 Test Mode: Keeping TX mode Polarization: Vertical



No.	Freq. (MHz)	Reading (dBuV/m)	Factor (dB/m)	Result (dBuV/m)	Limit (dBuV/m)	Over Limit (dB)	Detector	Height (cm)	degree (deg)	Remark
1	39.8541	46.97	-10.49	36.48	40.00	-3.52	QP	300	0	
2	68.3907	50.21	-18.93	31.28	40.00	-8.72	QP	300	35	
3	250.3011	52.43	-14.04	38.39	46.00	-7.61	QP	300	88	
4	297.2241	52.81	-14.76	38.05	46.00	-7.95	QP	300	175	
5	480.5276	45.83	-11.53	34.30	46.00	-11.70	QP	300	281	
6	625.0779	47.40	-9.05	38.35	46.00	-7.65	QP	300	336	

Test Results (Above 1000MHz)

Test Mode: 802.11b Mode					Test channel: Lowest			
Peak Value								
Frequency (MHz)	Read Level (dBuV)	Antenna Factor (dB/m)	Cable Loss (dB)	Preamp Factor (dB)	Level (dBuV/m)	Limit (dBuV/m)	Over Limit (dB)	Pol.
4824.00	40.73	34.13	6.61	34.09	47.38	74.00	-26.62	V
7236.00	34.50	37.14	7.74	34.51	44.87	74.00	-29.13	V
9648.00	32.91	39.35	9.26	34.80	46.72	74.00	-27.28	V
12060.00	*					74.00		V
14472.00	*					74.00		V
16884.00	*					74.00		V
4824.00	39.33	34.13	6.61	34.09	45.98	74.00	-28.02	H
7236.00	34.21	37.14	7.74	34.51	44.58	74.00	-29.42	H
9648.00	32.48	39.35	9.26	34.80	46.29	74.00	-27.71	H
12060.00	*					74.00		H
14472.00	*					74.00		H
16884.00	*					74.00		H
Average Value								
Frequency (MHz)	Read Level (dBuV)	Antenna Factor (dB/m)	Cable Loss (dB)	Preamp Factor (dB)	Level (dBuV/m)	Limit (dBuV/m)	Over Limit (dB)	Pol.
4824.00	29.78	34.13	6.61	34.09	36.43	54.00	-17.57	V
7236.00	23.35	37.14	7.74	34.51	33.72	54.00	-20.28	V
9648.00	23.25	39.35	9.26	34.80	37.06	54.00	-16.94	V
12060.00	*					54.00		V
14472.00	*					54.00		V
16884.00	*					54.00		V
4824.00	28.85	34.13	6.61	34.09	35.50	54.00	-18.50	H
7236.00	22.79	37.14	7.74	34.51	33.16	54.00	-20.84	H
9648.00	22.22	39.35	9.26	34.80	36.03	54.00	-17.97	H
12060.00	*					54.00		H
14472.00	*					54.00		H
16884.00	*					54.00		H

Test Results (Above 1000MHz)

Test Mode: 802.11b Mode					Test channel: Middle			
Peak Value								
Frequency (MHz)	Read Level (dBuV)	Antenna Factor (dB/m)	Cable Loss (dB)	Preamp Factor (dB)	Level (dBuV/m)	Limit (dBuV/m)	Over Limit (dB)	Pol.
4874.00	39.71	34.35	6.67	34.09	46.64	74.00	-27.36	V
7311.00	34.52	37.21	7.77	34.53	44.97	74.00	-29.03	V
9748.00	33.90	39.45	9.33	34.80	47.88	74.00	-26.12	V
12185.00	*					74.00		V
14622.00	*					74.00		V
17059.00	*					74.00		V
4874.00	40.14	34.35	6.67	34.09	47.07	74.00	-26.93	H
7311.00	33.13	37.21	7.77	34.53	43.58	74.00	-30.42	H
9748.00	33.77	39.45	9.33	34.80	47.75	74.00	-26.25	H
12185.00	*					74.00		H
14622.00	*					74.00		H
17059.00	*					74.00		H
Average Value								
Frequency (MHz)	Read Level (dBuV)	Antenna Factor (dB/m)	Cable Loss (dB)	Preamp Factor (dB)	Level (dBuV/m)	Limit (dBuV/m)	Over Limit (dB)	Pol.
4874.00	30.54	34.35	6.67	34.09	37.47	54.00	-16.53	V
7311.00	22.83	37.21	7.77	34.53	33.28	54.00	-20.72	V
9748.00	23.14	39.45	9.33	34.80	37.12	54.00	-16.88	V
12185.00	*					54.00		V
14622.00	*					54.00		V
17059.00	*					54.00		V
4874.00	30.23	34.35	6.67	34.09	37.16	54.00	-16.84	H
7311.00	22.21	37.21	7.77	34.53	32.66	54.00	-21.34	H
9748.00	23.48	39.45	9.33	34.80	37.46	54.00	-16.54	H
12185.00	*					54.00		H
14622.00	*					54.00		H
17059.00	*					54.00		H

Test Results (Above 1000MHz)

Test Mode: 802.11b Mode					Test channel: Highest			
Peak Value								
Frequency (MHz)	Read Level (dBuV)	Antenna Factor (dB/m)	Cable Loss (dB)	Preamp Factor (dB)	Level (dBuV/m)	Limit (dBuV/m)	Over Limit (dB)	Pol.
4924.00	45.51	34.57	6.74	34.09	52.73	74.00	-21.27	V
7386.00	35.36	37.29	7.80	34.55	45.90	74.00	-28.10	V
9848.00	37.31	39.55	9.41	34.81	51.46	74.00	-22.54	V
12310.00	*					74.00		V
14772.00	*					74.00		V
17234.00	*					74.00		V
4924.00	44.72	34.57	6.74	34.09	51.94	74.00	-22.06	H
7386.00	34.21	37.29	7.80	34.55	44.75	74.00	-29.25	H
9848.00	33.46	39.55	9.41	34.81	47.61	74.00	-26.39	H
12310.00	*					74.00		H
14772.00	*					74.00		H
17234.00	*					74.00		H
Average Value								
Frequency (MHz)	Read Level (dBuV)	Antenna Factor (dB/m)	Cable Loss (dB)	Preamp Factor (dB)	Level (dBuV/m)	Limit (dBuV/m)	Over Limit (dB)	Pol.
4924.00	36.37	34.57	6.74	34.09	43.59	54.00	-10.41	V
7386.00	25.26	37.29	7.80	34.55	35.80	54.00	-18.20	V
9848.00	25.80	39.55	9.41	34.81	39.95	54.00	-14.05	V
12310.00	*					54.00		V
14772.00	*					54.00		V
17234.00	*					54.00		V
4924.00	35.05	34.57	6.74	34.09	42.27	54.00	-11.73	H
7386.00	23.59	37.29	7.80	34.55	34.13	54.00	-19.87	H
9848.00	22.71	39.55	9.41	34.81	36.86	54.00	-17.14	H
12310.00	*					54.00		H
14772.00	*					54.00		H
17234.00	*					54.00		H

Remark:

1. During the test, pre-scan the 802.11b,g,n(HT20N),n(HT40N) mode, and found the 802.11b mode is worse case , the report only record this mode.
2. Level =Receiver Read level + Antenna Factor + Cable Loss – Preamplifier Factor
3. “*”, means this data is the too weak instrument of signal is unable to test.

Radiated Band Edge:

Test Mode: 802.11b Mode					Test channel: Lowest			
Peak Value								
Frequency (MHz)	Read Level (dBuV)	Antenna Factor (dB/m)	Cable Loss (dB)	Preamplifier Factor (dB)	Level (dBuV/m)	Limit (dBuV/m)	Over Limit (dB)	Pol.
2390.00	52.50	29.15	3.41	34.01	51.05	74.00	-22.95	H
2400.00	61.80	29.16	3.43	34.01	60.38	74.00	-13.62	H
2390.00	54.24	29.15	3.41	34.01	52.79	74.00	-21.21	V
2400.00	63.82	29.16	3.43	34.01	62.40	74.00	-11.60	V
Average Value								
Frequency (MHz)	Read Level (dBuV)	Antenna Factor (dB/m)	Cable Loss (dB)	Preamplifier Factor (dB)	Level (dBuV/m)	Limit (dBuV/m)	Over Limit (dB)	Pol.
2390.00	39.02	29.15	3.41	34.01	37.57	54.00	-16.43	H
2400.00	47.40	29.16	3.43	34.01	45.98	54.00	-8.02	H
2390.00	40.90	29.15	3.41	34.01	39.45	54.00	-14.55	V
2400.00	48.59	29.16	3.43	34.01	47.17	54.00	-6.83	V

Test Mode: 802.11b Mode					Test channel: Highest			
Peak Value								
Frequency (MHz)	Read Level (dBuV)	Antenna Factor (dB/m)	Cable Loss (dB)	Preamplifier Factor (dB)	Level (dBuV/m)	Limit (dBuV/m)	Over Limit (dB)	Pol.
2483.50	53.52	29.28	3.53	34.03	52.30	74.00	-21.70	H
2500.00	49.08	29.30	3.56	34.03	47.91	74.00	-26.09	H
2483.50	55.95	29.28	3.53	34.03	54.73	74.00	-19.27	V
2500.00	51.75	29.30	3.56	34.03	50.58	74.00	-23.42	V
Average Value								
Frequency (MHz)	Read Level (dBuV)	Antenna Factor (dB/m)	Cable Loss (dB)	Preamplifier Factor (dB)	Level (dBuV/m)	Limit (dBuV/m)	Over Limit (dB)	Pol.
2483.50	39.51	29.28	3.53	34.03	38.29	54.00	-15.71	H
2500.00	35.45	29.30	3.56	34.03	34.28	54.00	-19.72	H
2483.50	41.53	29.28	3.53	34.03	40.31	54.00	-13.69	V
2500.00	37.36	29.30	3.56	34.03	36.19	54.00	-17.81	V

Remark:

1. Level = Receiver Read level + Antenna Factor + Cable Loss – Preamplifier Factor

Radiated Band Edge:

Test Mode: 802.11g Mode					Test channel: Lowest			
Peak Value								
Frequency (MHz)	Read Level (dBuV)	Antenna Factor (dB/m)	Cable Loss (dB)	Preamp Factor (dB)	Level (dBuV/m)	Limit (dBuV/m)	Over Limit (dB)	Pol.
2390.00	51.52	27.53	5.47	33.92	50.60	74.00	-23.40	H
2400.00	60.50	27.55	5.49	29.93	63.61	74.00	-10.39	H
2390.00	53.20	27.53	5.47	33.92	52.28	74.00	-21.72	V
2400.00	62.26	27.55	5.49	29.93	65.37	74.00	-8.63	V
Average Value								
Frequency (MHz)	Read Level (dBuV)	Antenna Factor (dB/m)	Cable Loss (dB)	Preamp Factor (dB)	Level (dBuV/m)	Limit (dBuV/m)	Over Limit (dB)	Pol.
2390.00	38.32	27.53	5.47	33.92	37.40	54.00	-16.60	H
2400.00	46.60	27.55	5.49	29.93	49.71	54.00	-4.29	H
2390.00	40.13	27.53	5.47	33.92	39.21	54.00	-14.79	V
2400.00	47.72	27.55	5.49	29.93	50.83	54.00	-3.17	V

Test Mode: 802.11g Mode					Test channel: Highest			
Peak Value								
Frequency (MHz)	Read Level (dBuV)	Antenna Factor (dB/m)	Cable Loss (dB)	Preamp Factor (dB)	Level (dBuV/m)	Limit (dBuV/m)	Over Limit (dB)	Pol.
2483.50	52.13	29.28	3.53	34.03	50.91	74.00	-23.09	H
2500.00	47.99	29.30	3.56	34.03	46.82	74.00	-27.18	H
2483.50	54.36	29.28	3.53	34.03	53.14	74.00	-20.86	V
2500.00	50.48	29.30	3.56	34.03	49.31	74.00	-24.69	V
Average Value								
Frequency (MHz)	Read Level (dBuV)	Antenna Factor (dB/m)	Cable Loss (dB)	Preamp Factor (dB)	Level (dBuV/m)	Limit (dBuV/m)	Over Limit (dB)	Pol.
2483.50	38.67	29.28	3.53	34.03	37.45	54.00	-16.55	H
2500.00	34.79	29.30	3.56	34.03	33.62	54.00	-20.38	H
2483.50	40.60	29.28	3.53	34.03	39.38	54.00	-14.62	V
2500.00	36.67	29.30	3.56	34.03	35.50	54.00	-18.50	V

Remark:

1. Level = Receiver Read level + Antenna Factor + Cable Loss – Preamplifier Factor

Radiated Band Edge:

Test Mode: 802.11n20 Mode					Test channel: Lowest			
Peak Value								
Frequency (MHz)	Read Level (dBuV)	Antenna Factor (dB/m)	Cable Loss (dB)	Preamp Factor (dB)	Level (dBuV/m)	Limit (dBuV/m)	Over Limit (dB)	Pol.
2390.00	51.53	27.53	5.47	33.92	50.61	74.00	-23.39	H
2400.00	60.50	27.55	5.49	29.93	63.61	74.00	-10.39	H
2390.00	53.20	27.53	5.47	33.92	52.28	74.00	-21.72	V
2400.00	62.27	27.55	5.49	29.93	65.38	74.00	-8.62	V
Average Value								
Frequency (MHz)	Read Level (dBuV)	Antenna Factor (dB/m)	Cable Loss (dB)	Preamp Factor (dB)	Level (dBuV/m)	Limit (dBuV/m)	Over Limit (dB)	Pol.
2390.00	38.33	27.53	5.47	33.92	37.41	54.00	-16.59	H
2400.00	46.61	27.55	5.49	29.93	49.72	54.00	-4.28	H
2390.00	40.14	27.53	5.47	33.92	39.22	54.00	-14.78	V
2400.00	47.72	27.55	5.49	29.93	50.83	54.00	-3.17	V

Test Mode: 802.11n20 Mode					Test channel: Highest			
Peak Value								
Frequency (MHz)	Read Level (dBuV)	Antenna Factor (dB/m)	Cable Loss (dB)	Preamp Factor (dB)	Level (dBuV/m)	Limit (dBuV/m)	Over Limit (dB)	Pol.
2483.50	52.14	29.28	3.53	34.03	50.92	74.00	-23.08	H
2500.00	48.00	29.30	3.56	34.03	46.83	74.00	-27.17	H
2483.50	54.37	29.28	3.53	34.03	53.15	74.00	-20.85	V
2500.00	50.49	29.30	3.56	34.03	49.32	74.00	-24.68	V
Average Value								
Frequency (MHz)	Read Level (dBuV)	Antenna Factor (dB/m)	Cable Loss (dB)	Preamp Factor (dB)	Level (dBuV/m)	Limit (dBuV/m)	Over Limit (dB)	Pol.
2483.50	38.67	29.28	3.53	34.03	37.45	54.00	-16.55	H
2500.00	34.80	29.30	3.56	34.03	33.63	54.00	-20.37	H
2483.50	40.61	29.28	3.53	34.03	39.39	54.00	-14.61	V
2500.00	36.67	29.30	3.56	34.03	35.50	54.00	-18.50	V

Remark:

1. Level = Receiver Read level + Antenna Factor + Cable Loss – Preamplifier Factor

Radiated Band Edge:

Test Mode: 802.11n40 Mode					Test channel: Lowest			
Peak Value								
Frequency (MHz)	Read Level (dBuV)	Antenna Factor (dB/m)	Cable Loss (dB)	Preamp Factor (dB)	Level (dBuV/m)	Limit (dBuV/m)	Over Limit (dB)	Pol.
2390.00	50.29	27.53	5.47	33.92	49.37	74.00	-24.63	H
2400.00	58.85	27.55	5.49	29.93	61.96	74.00	-12.04	H
2390.00	51.88	27.53	5.47	33.92	50.96	74.00	-23.04	V
2400.00	60.28	27.55	5.49	29.93	63.39	74.00	-10.61	V
Average Value								
Frequency (MHz)	Read Level (dBuV)	Antenna Factor (dB/m)	Cable Loss (dB)	Preamp Factor (dB)	Level (dBuV/m)	Limit (dBuV/m)	Over Limit (dB)	Pol.
2390.00	37.44	27.53	5.47	33.92	36.52	54.00	-17.48	H
2400.00	45.59	27.55	5.49	29.93	48.70	54.00	-5.30	H
2390.00	39.15	27.53	5.47	33.92	38.23	54.00	-15.77	V
2400.00	46.61	27.55	5.49	29.93	49.72	54.00	-4.28	V

Test Mode: 802.11n40 Mode					Test channel: Highest			
Peak Value								
Frequency (MHz)	Read Level (dBuV)	Antenna Factor (dB/m)	Cable Loss (dB)	Preamp Factor (dB)	Level (dBuV/m)	Limit (dBuV/m)	Over Limit (dB)	Pol.
2483.50	50.36	29.28	3.53	34.03	49.14	74.00	-24.86	H
2500.00	46.63	29.30	3.56	34.03	45.46	74.00	-28.54	H
2483.50	52.34	29.28	3.53	34.03	51.12	74.00	-22.88	V
2500.00	48.88	29.30	3.56	34.03	47.71	74.00	-26.29	V
Average Value								
Frequency (MHz)	Read Level (dBuV)	Antenna Factor (dB/m)	Cable Loss (dB)	Preamp Factor (dB)	Level (dBuV/m)	Limit (dBuV/m)	Over Limit (dB)	Pol.
2483.50	37.60	29.28	3.53	34.03	36.38	54.00	-17.62	H
2500.00	33.96	29.30	3.56	34.03	32.79	54.00	-21.21	H
2483.50	39.43	29.28	3.53	34.03	38.21	54.00	-15.79	V
2500.00	35.79	29.30	3.56	34.03	34.62	54.00	-19.38	V

Remark:

1. Level = Receiver Read level + Antenna Factor + Cable Loss – Preamplifier Factor

5. Maximum Peak Output Power Test

5.1. Test Standard and Limit

Test Standard	FCC Part15 C Section 15.247 (b)(3)
Test Limit	30dBm

5.2. Test Setup

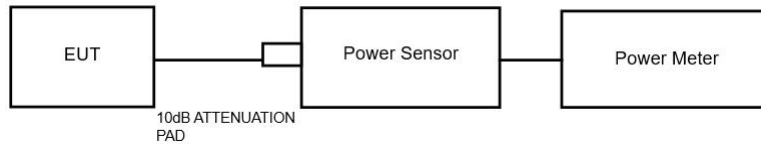

5.3. Test Procedure

1. The Transmitter output (antenna port) was connected to the power meter.
2. Turn on the EUT and power meter and then record the power value.
3. Repeat above procedures on all channels needed to be tested.

Note: The cable loss and attenuator loss were offset into measure device as amplitude offset.

5.4. Test Data

Test Item	: Max. peak output power	Test Mode	: CH Low ~ CH High
Test Voltage	: AC 120V, 60Hz for adapter	Temperature	: 24°C
Test Result	: PASS	Humidity	: 55%RH

Test Channel	Frequency (MHz)	Maximum Peak Conducted Output Power (PK) (dBm)	Limit dBm	Results
TX 802.11b Mode				
CH01	2412	17.62	30	PASS
CH06	2437	17.23	30	PASS
CH11	2462	17.56	30	PASS
TX 802.11g Mode				
CH01	2412	16.75	30	PASS
CH06	2437	16.45	30	PASS
CH11	2462	15.20	30	PASS
TX 802.11n(20) Mode				
CH01	2412	15.34	30	PASS
CH06	2437	15.75	30	PASS
CH11	2462	12.33	30	PASS
TX 802.11n(40) Mode				
CH03	2422	14.87	30	PASS
CH06	2437	14.23	30	PASS
CH09	2452	14.32	30	PASS

Note: For power test the duty cycle is 100% in continuous transmitting mode. Please see the plot of next page

Duty Cycle

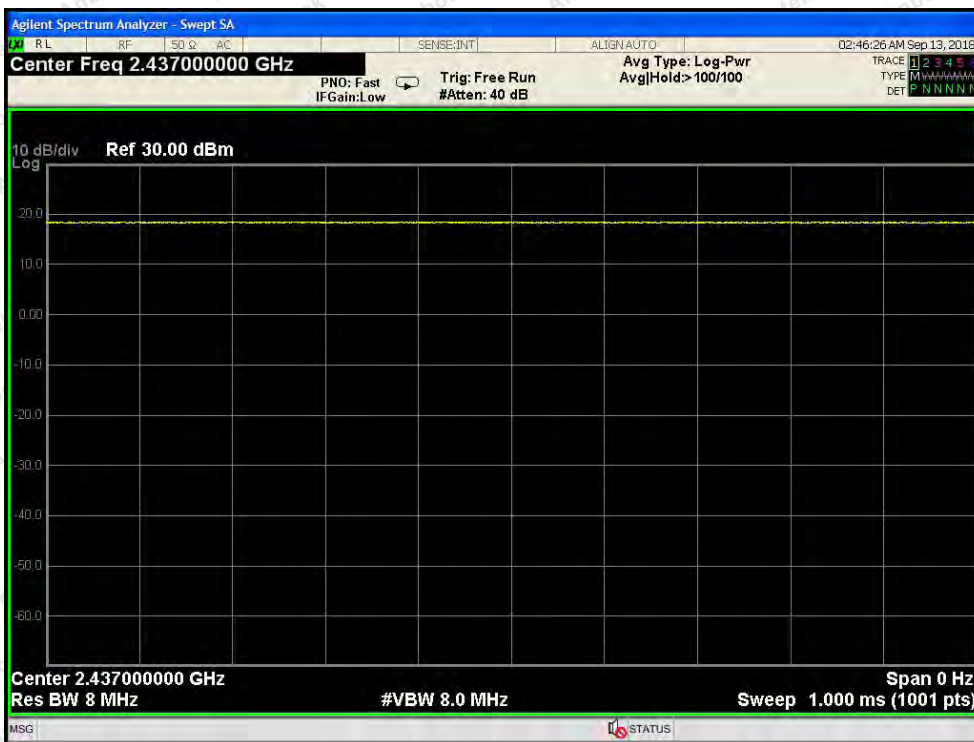

802.11b mode

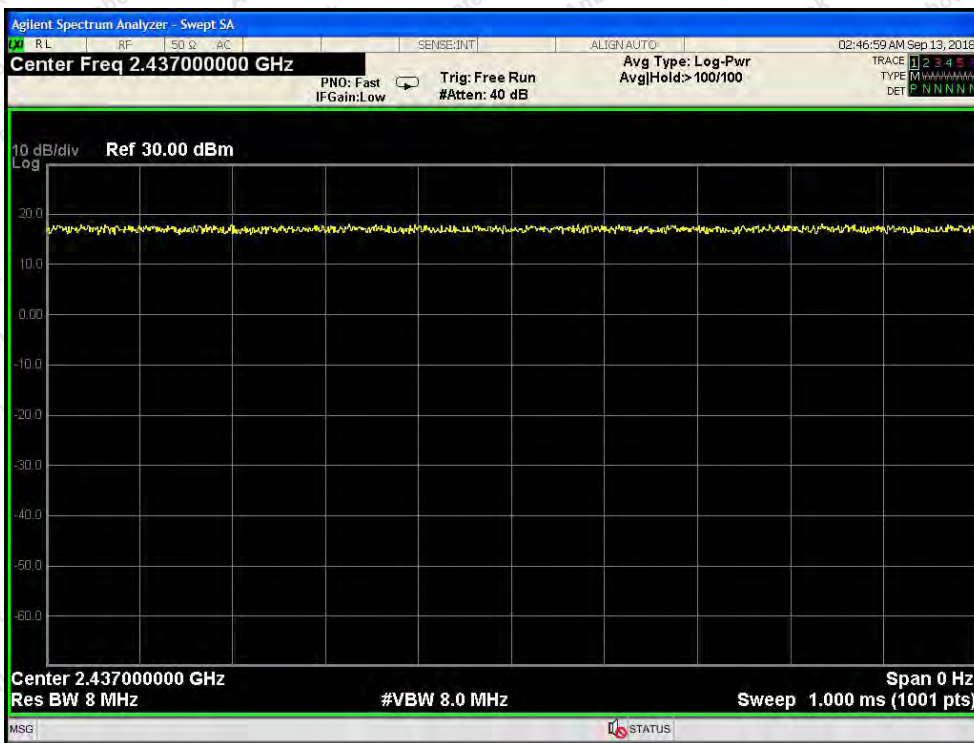

802.11g mode

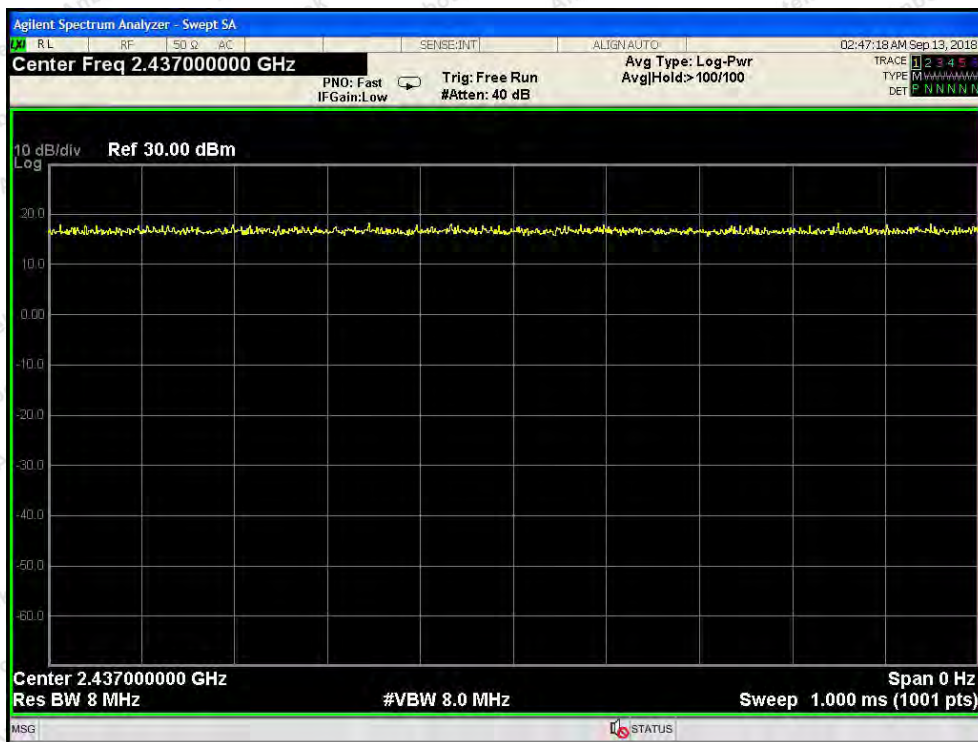

802.11n(HT20) mode

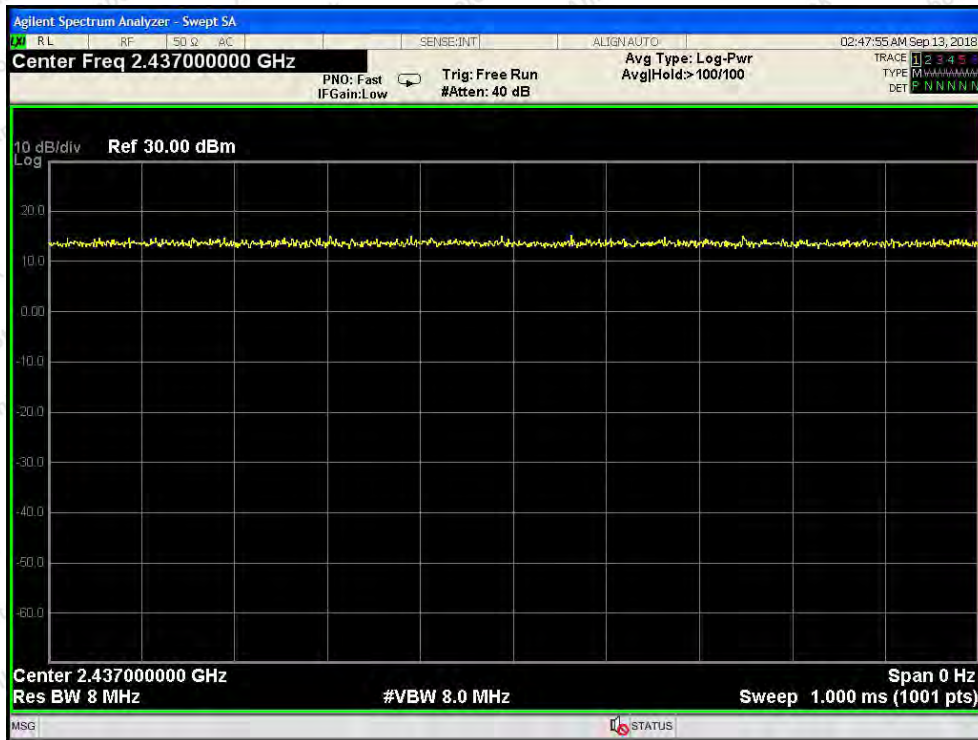

802.11n(HT40) mode

6. 6DB Occupy Bandwidth Test

6.1. Test Standard and Limit

Test Standard	FCC Part15 C Section 15.247 (a)(2)
Test Limit	>500kHz

6.2. Test Setup

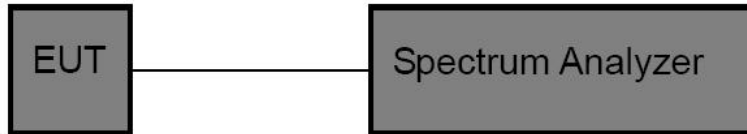

6.3. Test Procedure

1. Place the EUT on the table and set it in the transmitting mode.
2. Remove the antenna from the EUT and then connect a low loss RF cable from the antenna port to the spectrum analyzer.
3. Set the spectrum analyzer as:
 RBW= 100kHz, VBW \geq 3*RBW =300kHz
 Detector= Peak
 Trace mode= Max hold.
 Sweep- auto couple.
4. Mark the peak frequency and -6dB (upper and lower) frequency.
5. Repeat until all the rest channels are investigated.

6.4. Test Data

Test Item	: 6dB Bandwidth	Test Mode	: CH Low ~ CH High
Test Voltage	: AC 120V, 60Hz for adapter	Temperature	: 24°C
Test Result	: PASS	Humidity	: 55%RH

Mode	Channel	Frequency (MHz)	Bandwidth (MHz)	Limit (kHz)	Results
802.11b	Low	2412	8.107	>500	PASS
	Middle	2437	8.112		PASS
	High	2462	8.115		PASS
802.11g	Low	2412	15.150	>500	PASS
	Middle	2437	15.170		PASS
	High	2462	15.160		PASS
802.11n20	Low	2412	15.160	>500	PASS
	Middle	2437	15.430		PASS
	High	2462	15.460		PASS
802.11n40	Low	2422	35.130	>500	PASS
	Middle	2437	35.080		PASS
	High	2452	35.140		PASS



802.11b mode : Lowest



802.11b mode : Middle



802.11b mode : Highest



802.11g mode : Lowest



802.11g mode : Middle

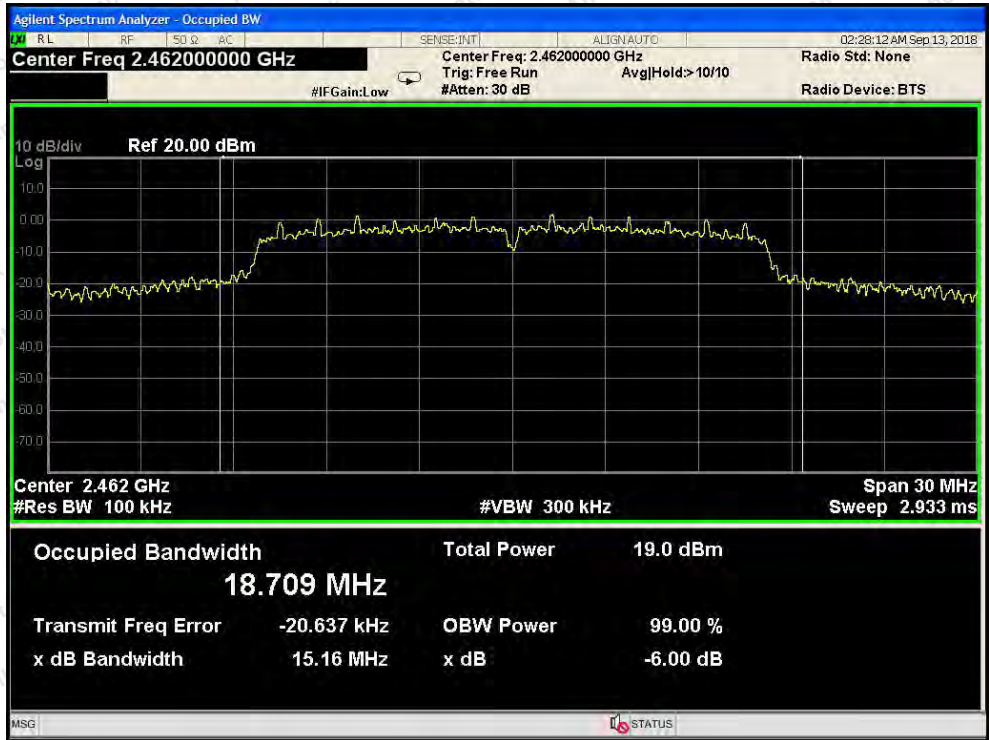

802.11g mode : Highest

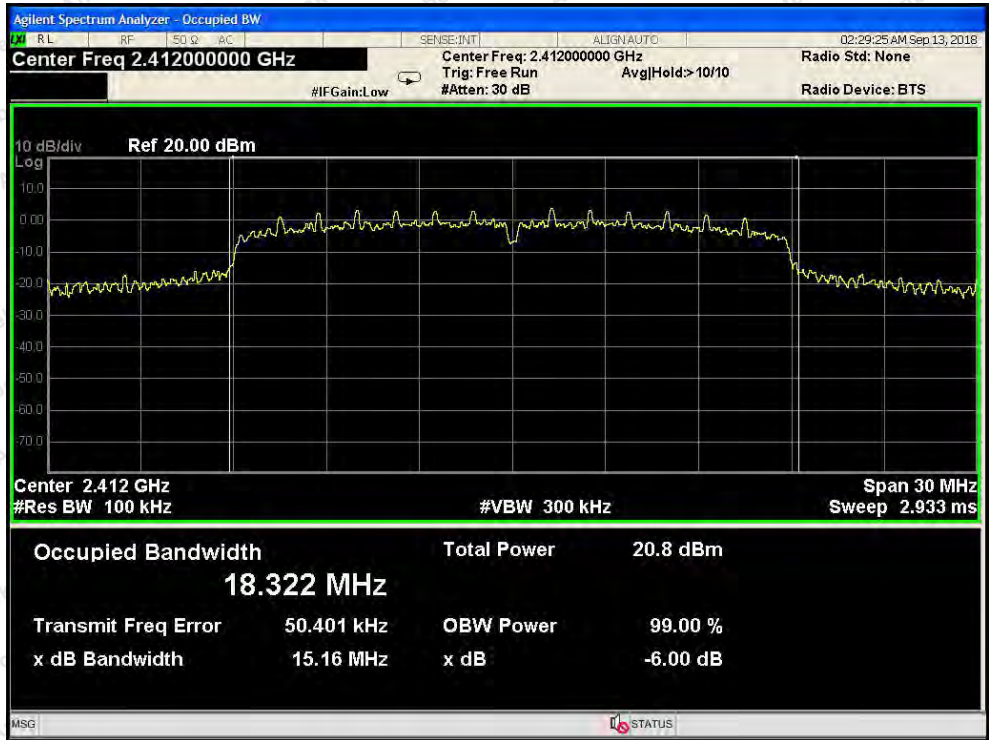

802.11n20 mode : Lowest



802.11n20 mode : Middle



802.11n20 mode : Highest

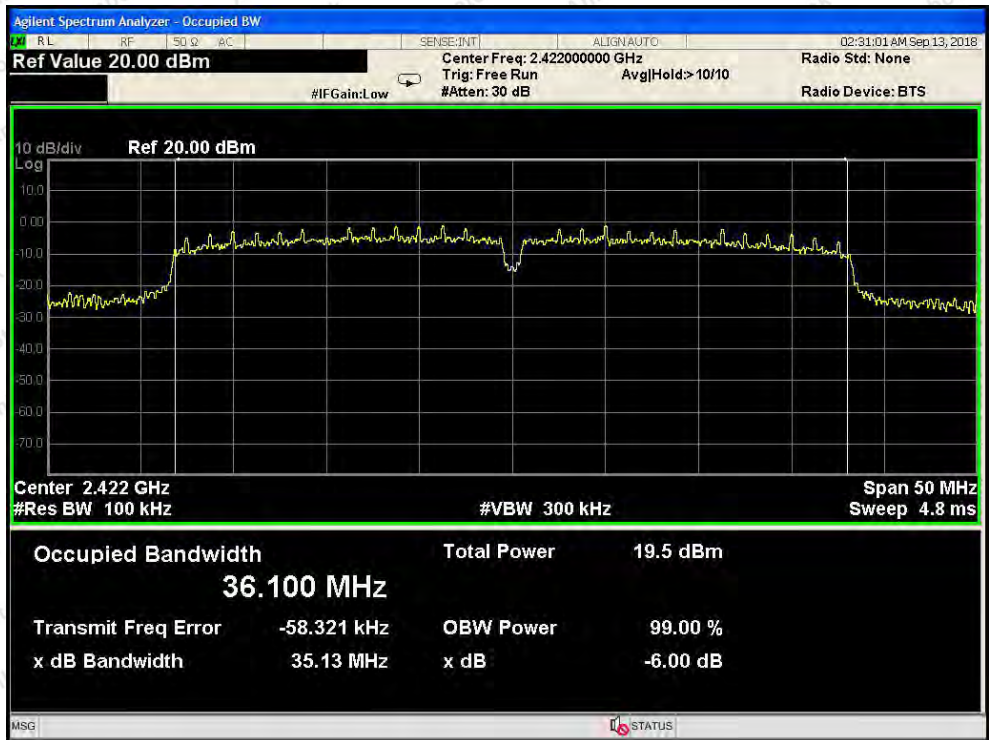

802.11n40 mode : Lowest



802.11n40 mode : Middle



802.11n40 mode : Highest

7. Power Spectral Density Test

7.1. Test Standard and Limit

Test Standard	FCC Part15 C Section 15.247 (e)
Test Limit	8dBm/3KHz

7.2. Test Setup

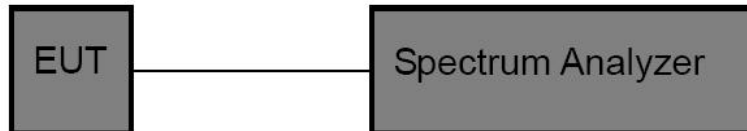

7.3. Test Procedure

1. Place the EUT on the table and set it in transmitting mode. Remove the antenna from the EUT and then connect a low loss RF cable from the antenna port to the spectrum analyzer.
2. Set the spectrum analyzer as RBW = 3kHz, VBW = 10kHz, Span = 1.5xDTS BW
3. Record the max. reading.
4. Repeat the above procedure until the measurements for all frequencies are completed.

7.4. Test Data

Test Item	: Power Spectral Density	Test Mode	: CH Low ~ CH High
Test Voltage	: AC 120V, 60Hz for adapter	Temperature	: 24°C
Test Result	: PASS	Humidity	: 55%RH

Mode	Channel	Frequency (MHz)	PPSD (dBm/3KHz)	Limit (dBm/3KHz)	Results
802.11b	Low	2412	-10.533	8.00	PASS
	Middle	2437	-12.134	8.00	PASS
	High	2462	-12.417	8.00	PASS
802.11g	Low	2412	-14.161	8.00	PASS
	Middle	2437	-15.045	8.00	PASS
	High	2462	-16.004	8.00	PASS
802.11n20	Low	2412	-14.237	8.00	PASS
	Middle	2437	-14.264	8.00	PASS
	High	2462	-16.242	8.00	PASS
802.11n40	Low	2422	-17.436	8.00	PASS
	Middle	2437	-17.961	8.00	PASS
	High	2452	-16.993	8.00	PASS



802.11b mode : Lowest



802.11b mode : Middle



802.11b mode : Highest



802.11g mode : Lowest



802.11g mode : Middle

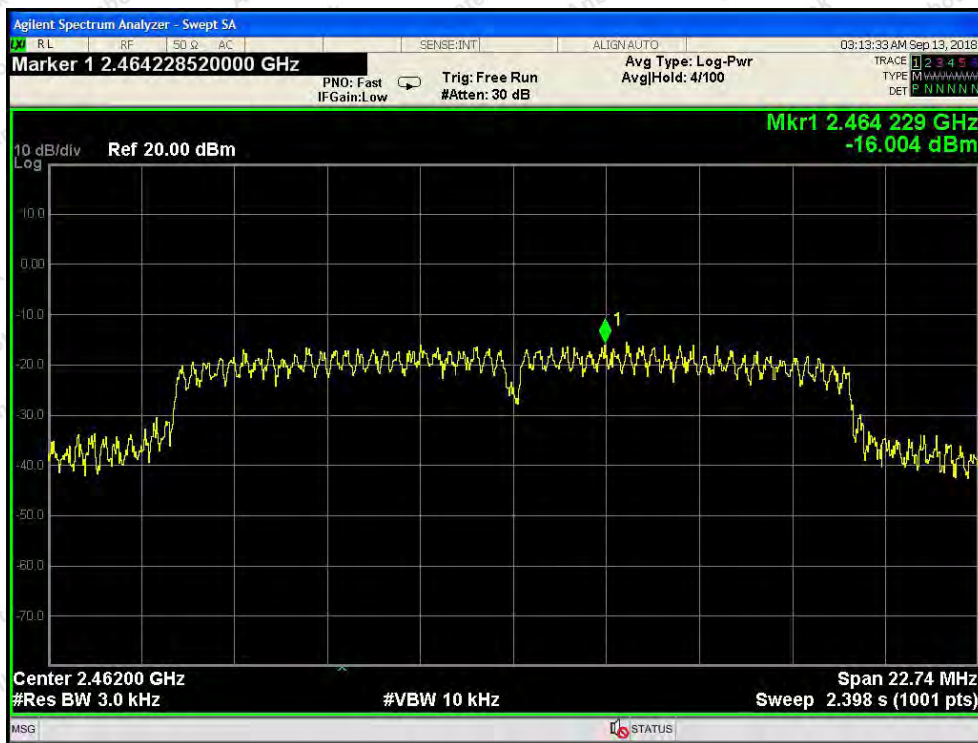

802.11g mode : Highest



802.11n20 mode : Lowest

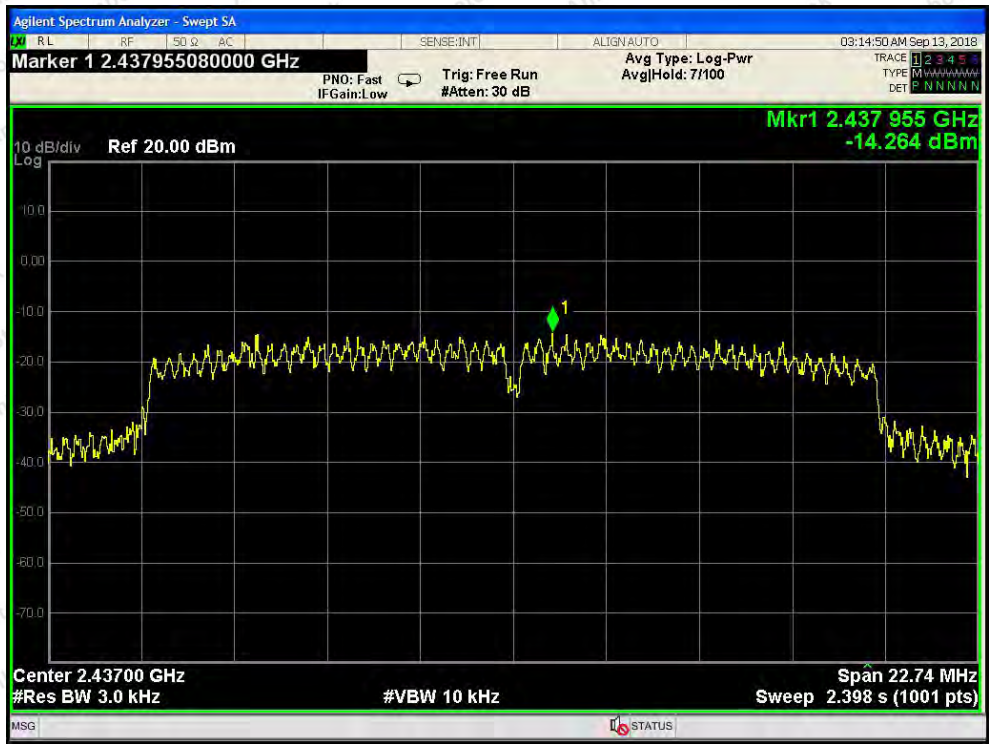

802.11n20 mode : Middle



802.11n20 mode : Highest



802.11n40 mode : Lowest

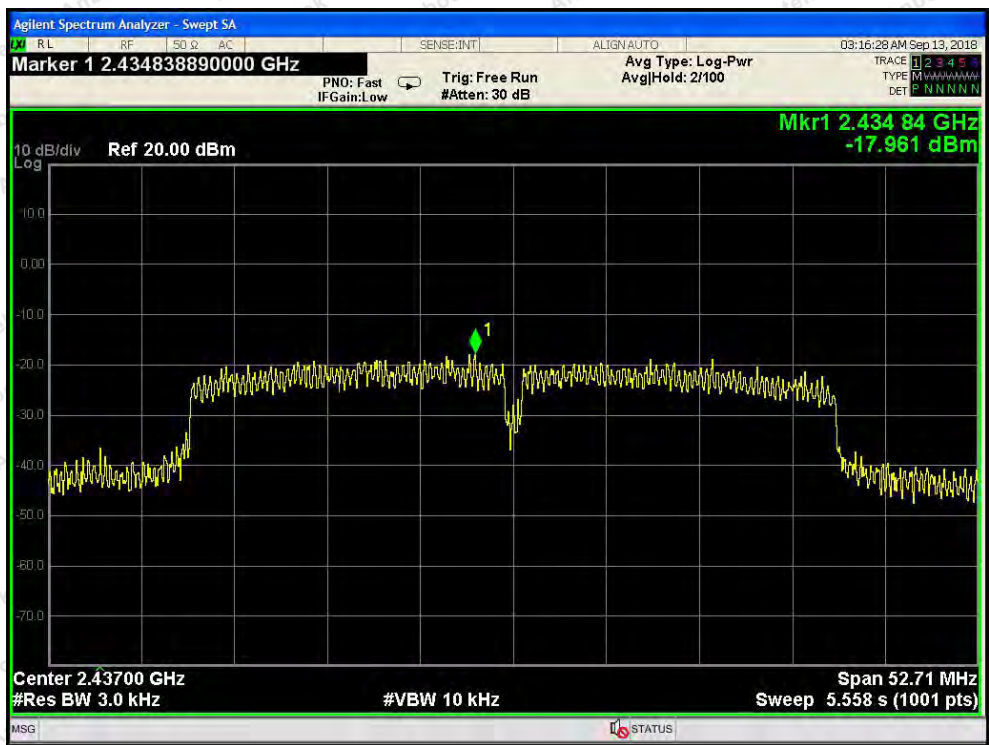

802.11n40 mode : Middle



802.11n40 mode : Highest

8. 100kHz Bandwidth of Frequency Band Edge Requirement

8.1. Test Standard and Limit

Test Standard	FCC Part15 C Section 15.247 (d)
Test Limit	in any 100 kHz bandwidth outside the frequency bands in which the spread spectrum intentional radiator in operating, the radio frequency power that is produced by the intentional radiator shall be at least 20dB below that in the 100kHz bandwidth within the band that contains the highest level of the desired power, In addition, radiated emissions which fall in the restricted bands, as defined in §15.205(a), must also comply with the radiated emission limits specified in 15.209(a).

8.2. Test Setup

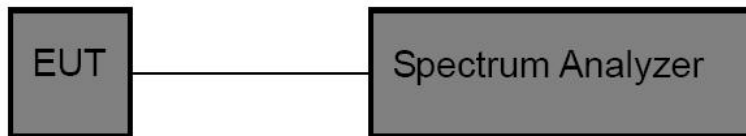

8.3. Test Procedure

Using the following spectrum analyzer setting:

1. Set the RBW = 100KHz.
2. Set the VBW = 300KHz.
3. Sweep time = auto couple.
4. Detector function = peak.
5. Trace mode = max hold.
6. Allow trace to fully stabilize.

8.4. Test Data

Test Item	: Band edge	Test Mode	: CH Low ~ CH High
Test Voltage	: AC 120V, 60Hz for adapter	Temperature	: 24°C
Test Result	: PASS	Humidity	: 55%RH

Mode	Frequency Band (MHz)	Delta Peak to Band Emission (dBc)	Limit (dBc)	Results
802.11b	2412	35.386	>20	PASS
	2462	50.245	>20	PASS
802.11g	2412	22.067	>20	PASS
	2462	32.603	>20	PASS
802.11n20	2412	22.970	>20	PASS
	2462	33.219	>20	PASS
802.11n40	2422	23.911	>20	PASS
	2452	24.635	>20	PASS



802.11b mode : Lowest



802.11b mode : Highest



802.11g mode : Lowest



802.11g mode : Highest



802.11n20 mode : Lowest



802.11n20 mode : Highest



802.11n40 mode : Lowest



802.11n40 mode : Highest

Conducted Emission Method

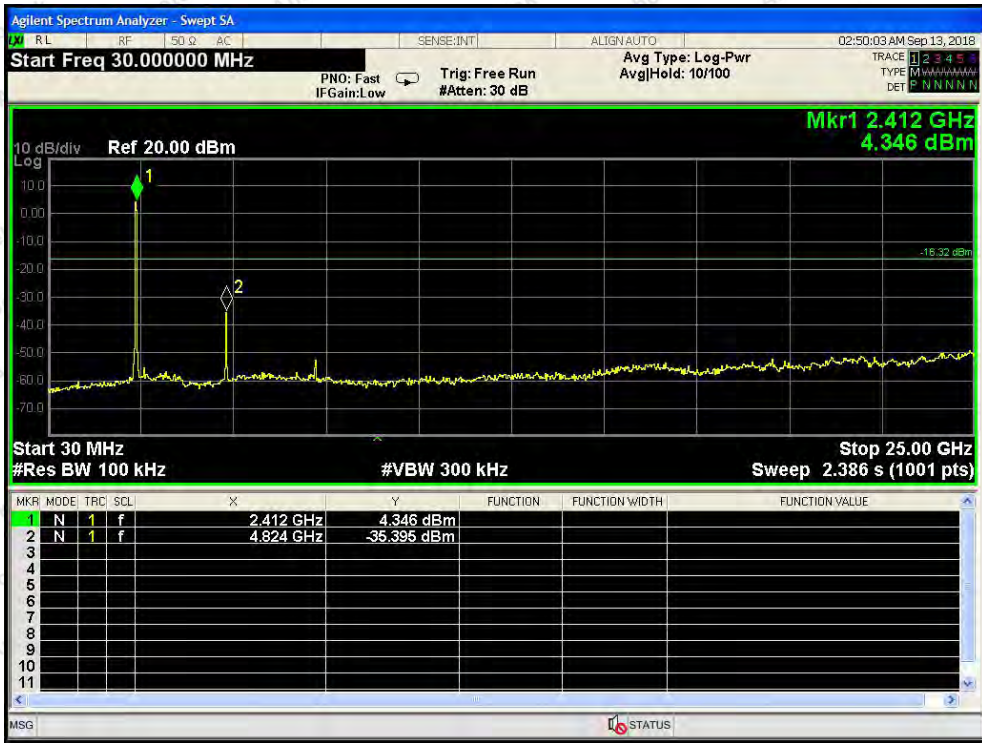

802.11b mode : Lowest

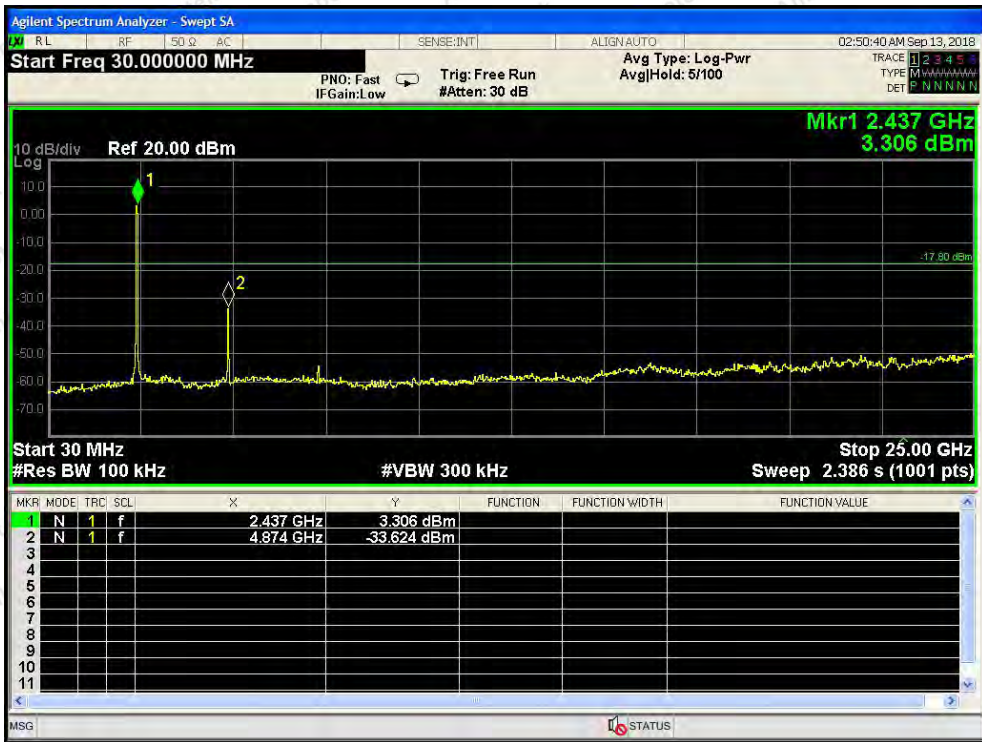

802.11b mode : Middle

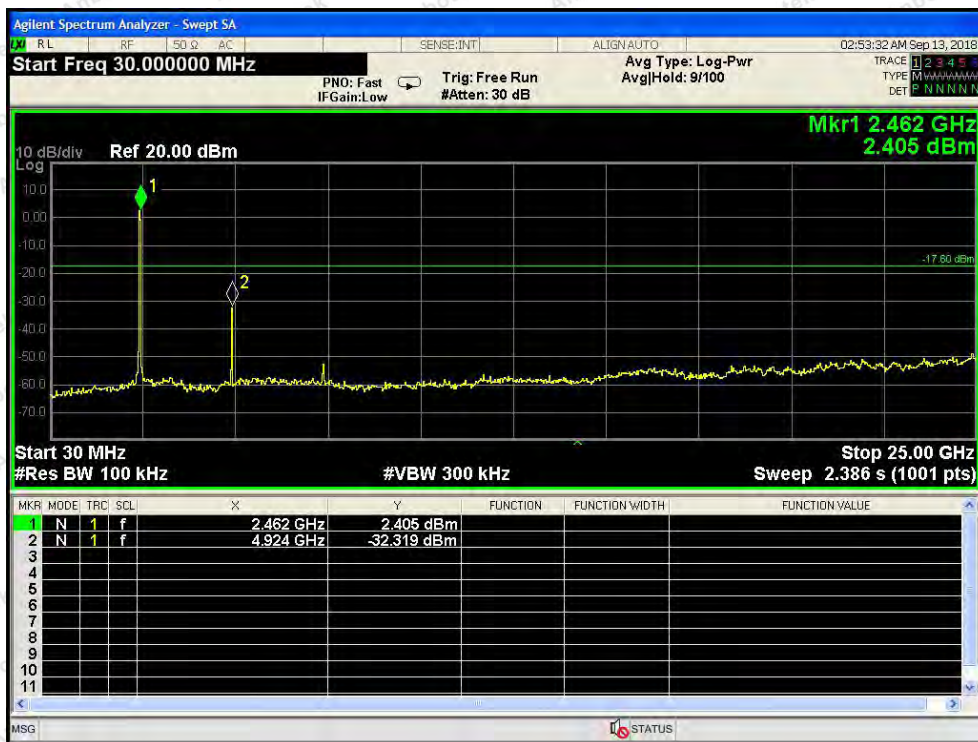

802.11b mode : Highest

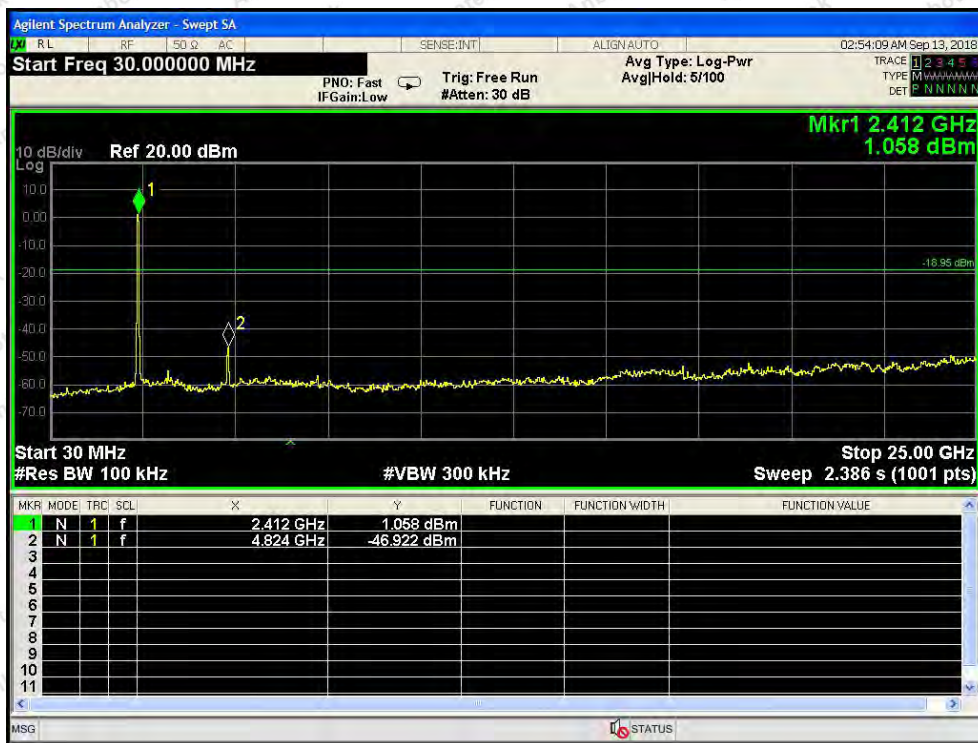

802.11g mode : Lowest

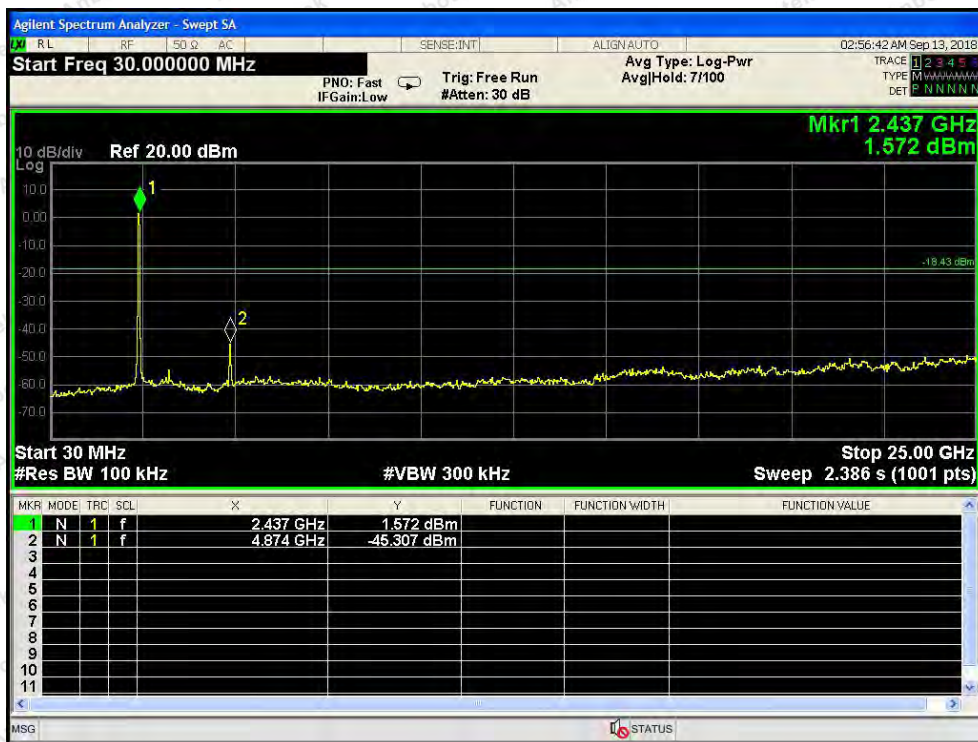

802.11g mode : Middle

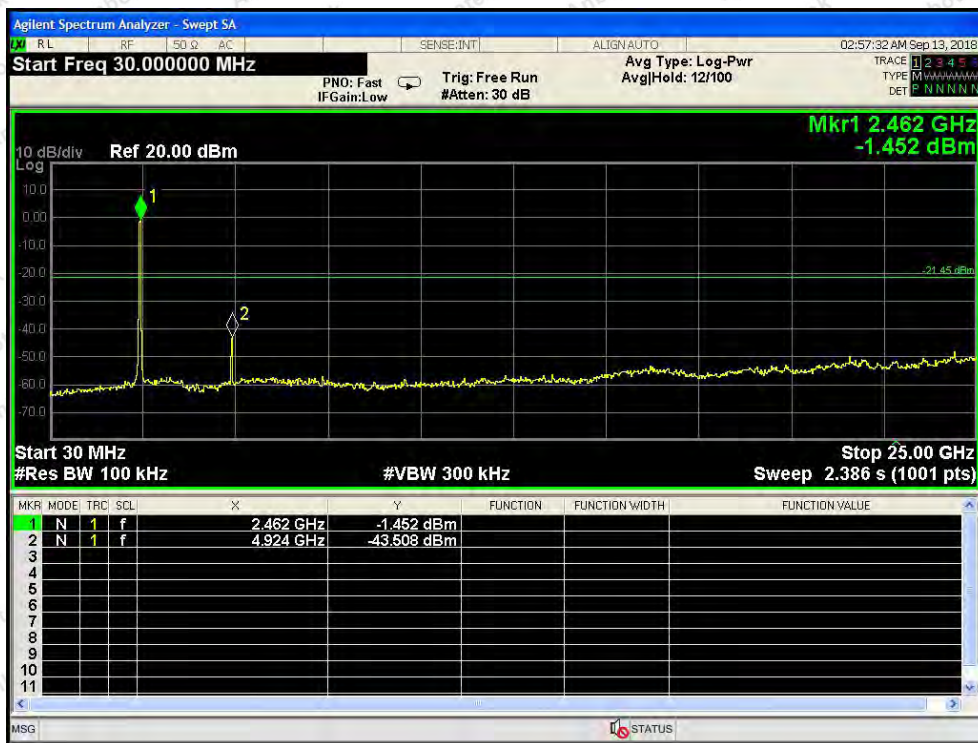

802.11g mode : Highest



802.11n20 mode : Lowest

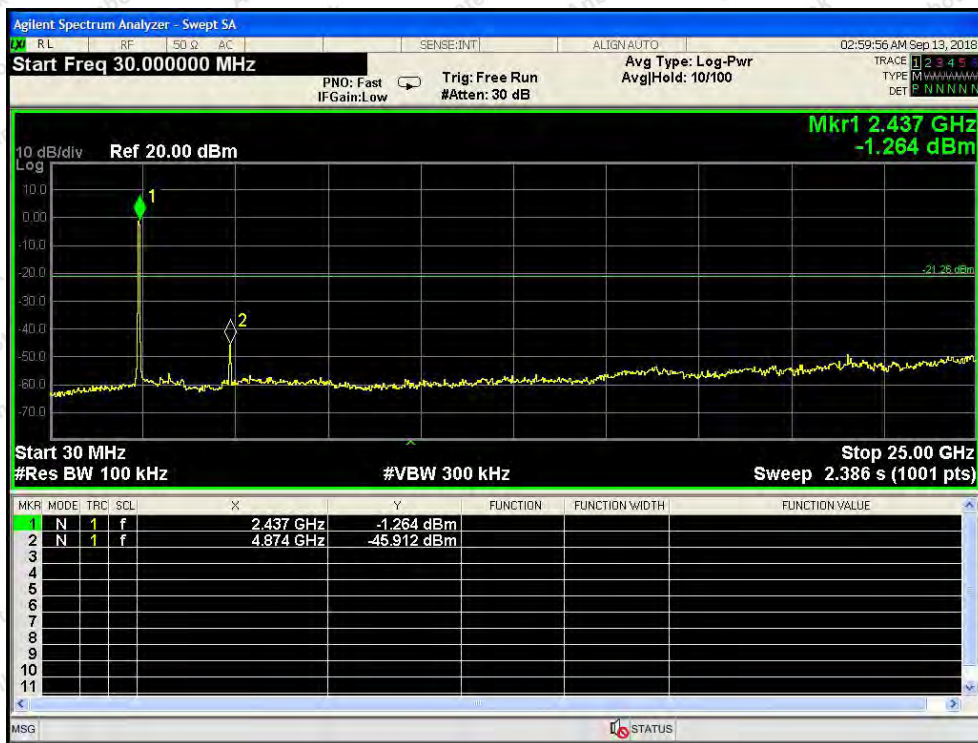

802.11n20 mode : Middle

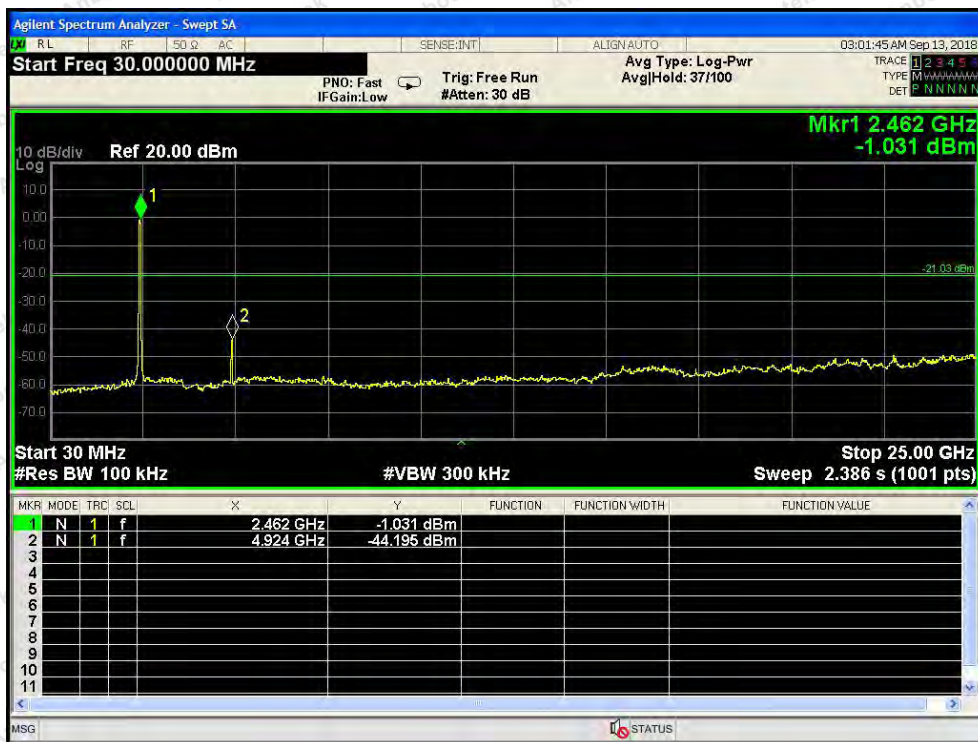

802.11n20 mode : Highest

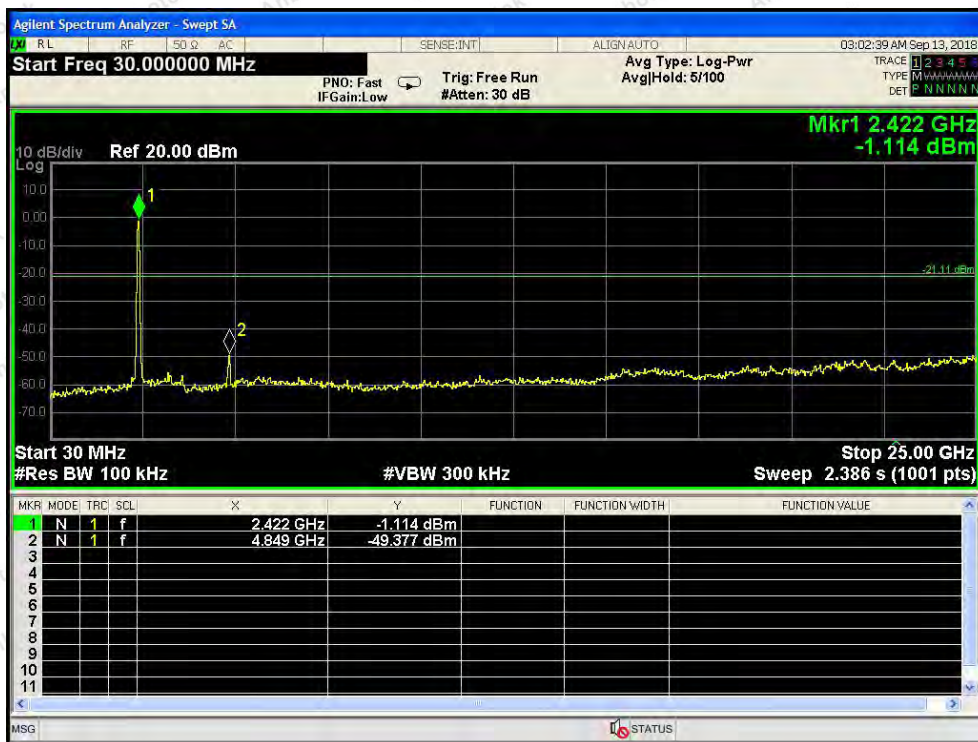

802.11n40 mode : Lowest

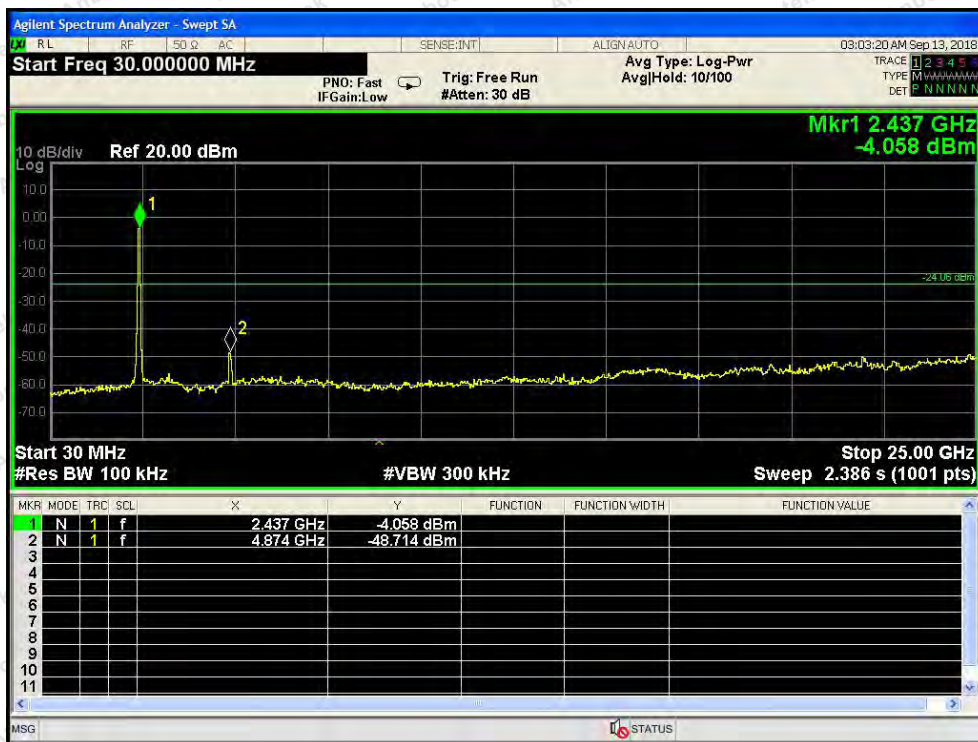

802.11n40 mode : Middle

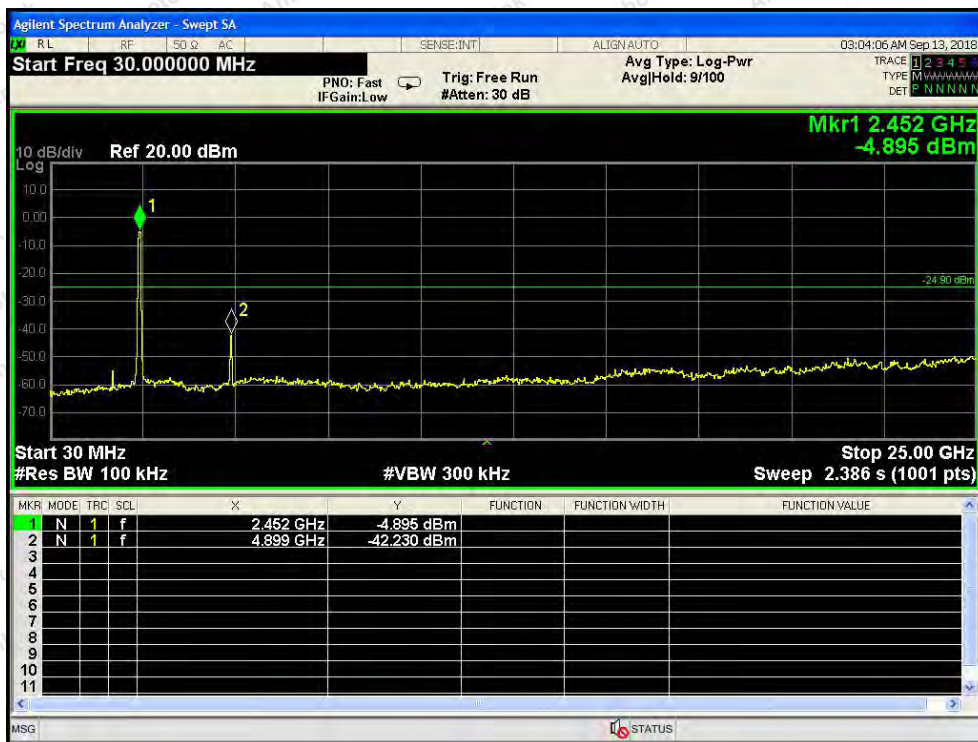

802.11n40 mode : Highest

9. Antenna Requirement

9.1. Test Standard and Requirement

Test Standard	FCC Part15 Section 15.203 /247(c)
Requirement	<p>1) 15.203 requirement: An intentional radiator shall be designed to ensure that no antenna other than that furnished by the responsible party shall be used with the device. The use of a permanently attached antenna or of an antenna that uses a unique coupling to the intentional radiator, the manufacturer may design the unit so that a broken antenna can be replaced by the user, but the use of a standard antenna jack or electrical connector is prohibited.</p> <p>2) 15.247(c) (1)(i) requirement: Systems operating in the 2400-2483.5 MHz band that is used exclusively for fixed. Point-to-point operations may employ transmitting antennas with directional gain greater than 6dBi provided the maximum conducted output power of the intentional radiator is reduced by 1 dB for every 3 dB that the directional gain of the antenna exceeds 6 dBi.</p>

9.2. Antenna Connected Construction

The WIFI antenna is a FPCB Antenna which permanently attached, and the best case gain of the antenna is 2.5 dBi It complies with the standard requirement.



APPENDIX I-- TEST SETUP PHOTOGRAPH

Photo of Conducted Emission Measurement



Photo of Radiation Emission Test

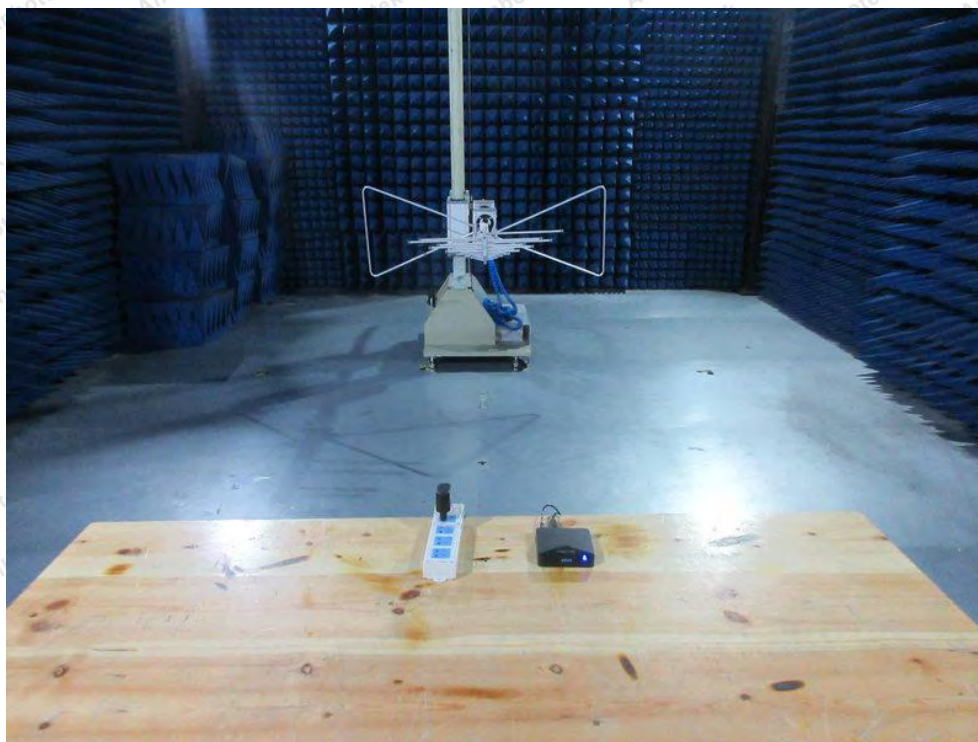

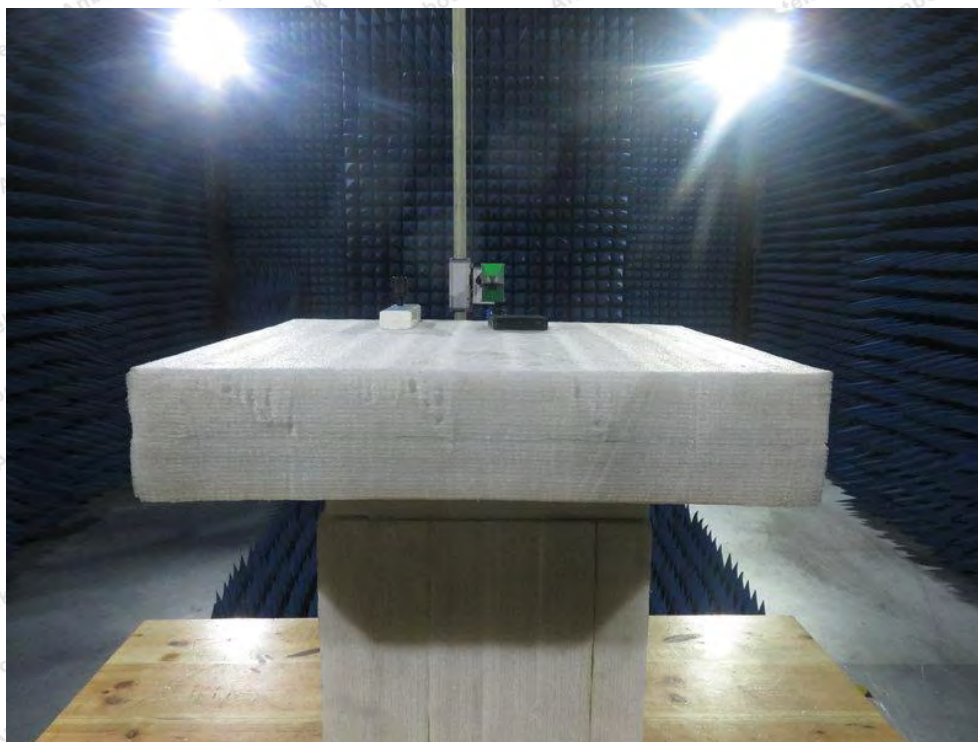

APPENDIX II -- EXTERNAL PHOTOGRAPH









APPENDIX III -- INTERNAL PHOTOGRAPH

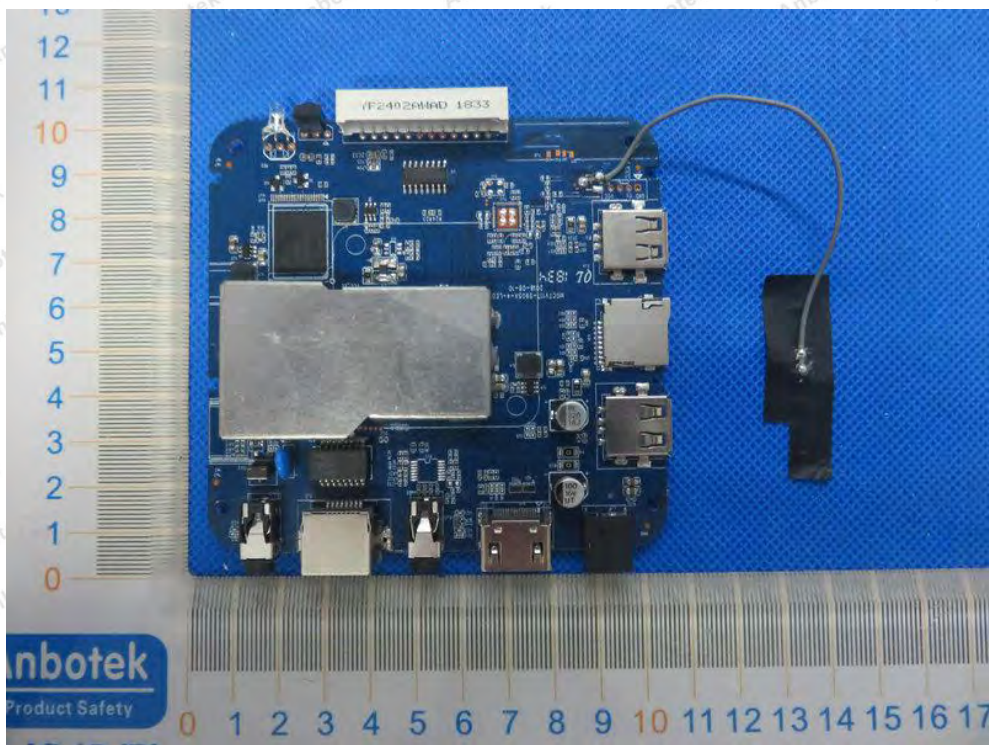

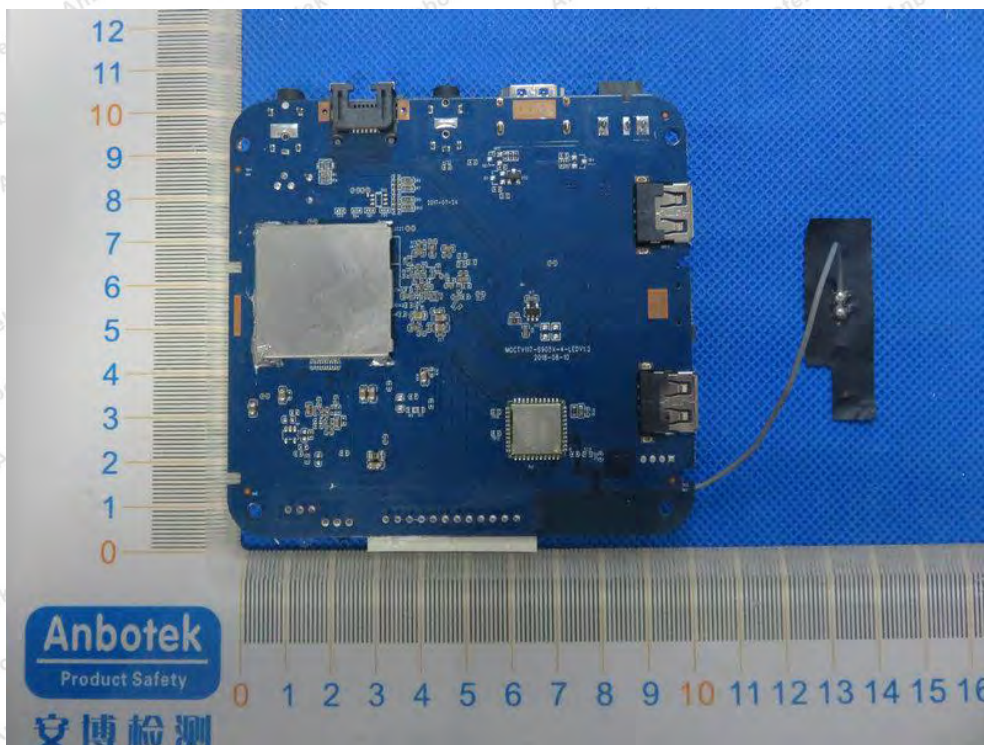

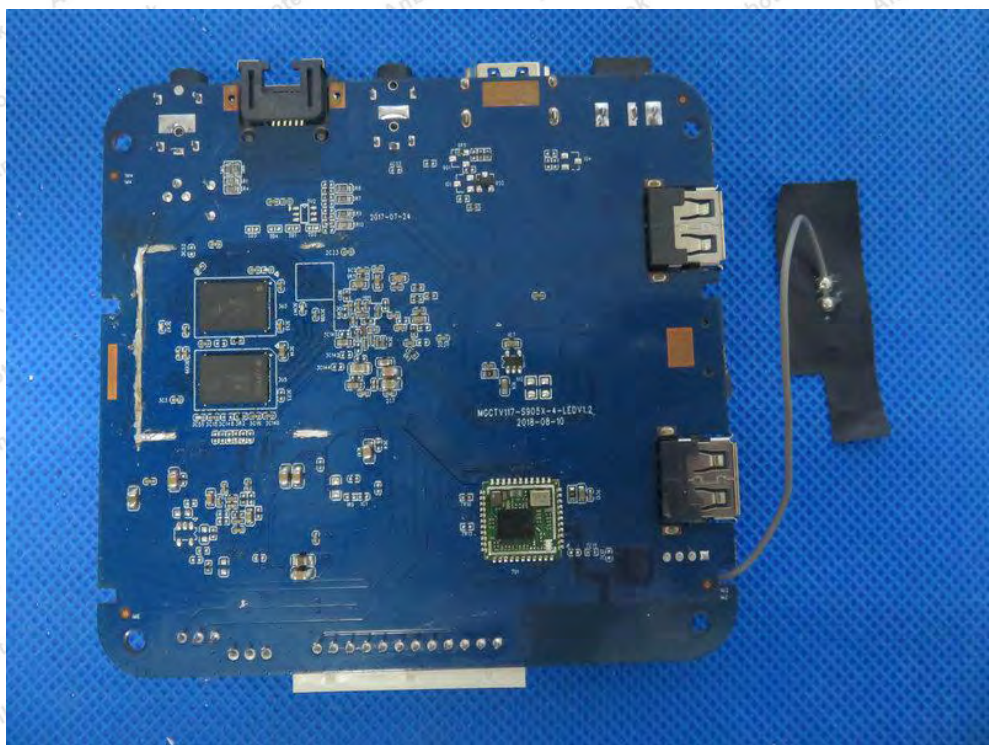
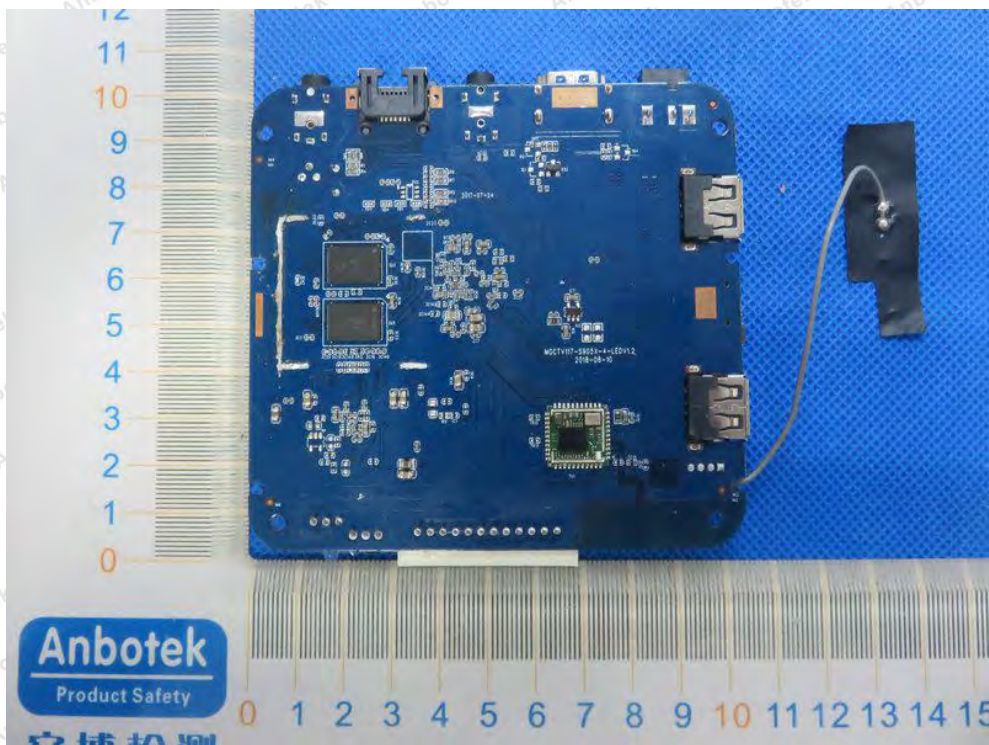

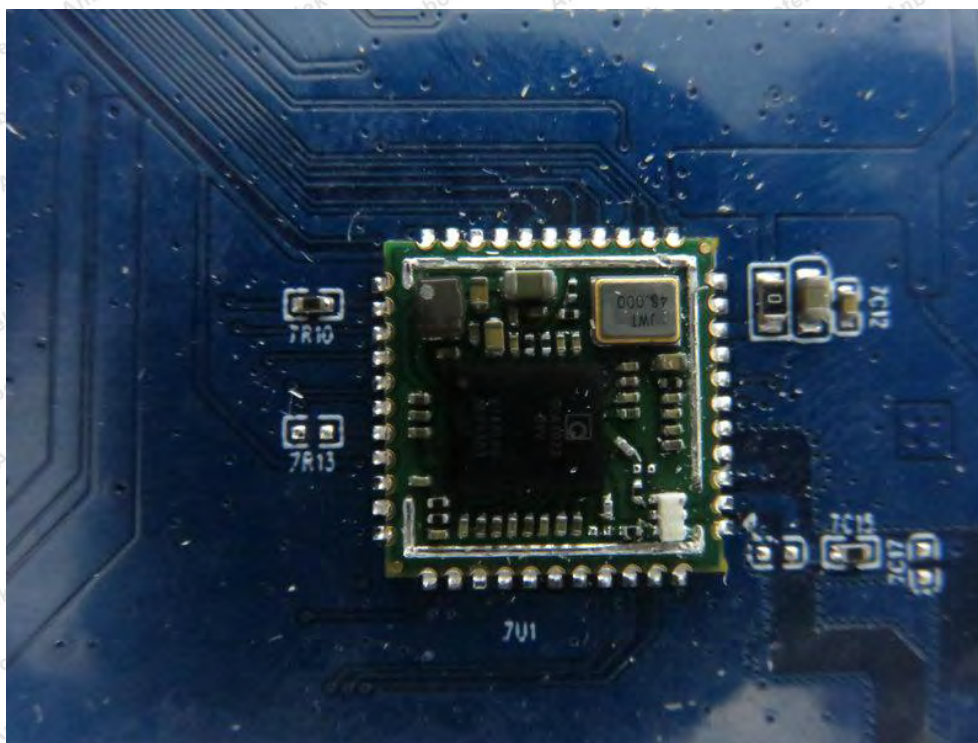

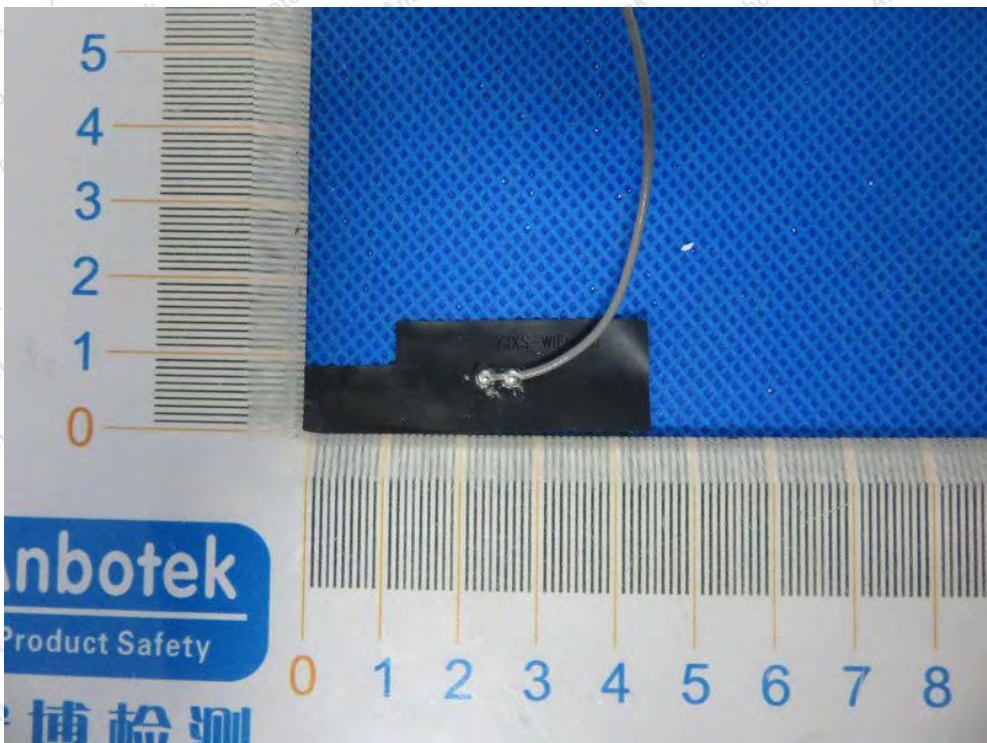
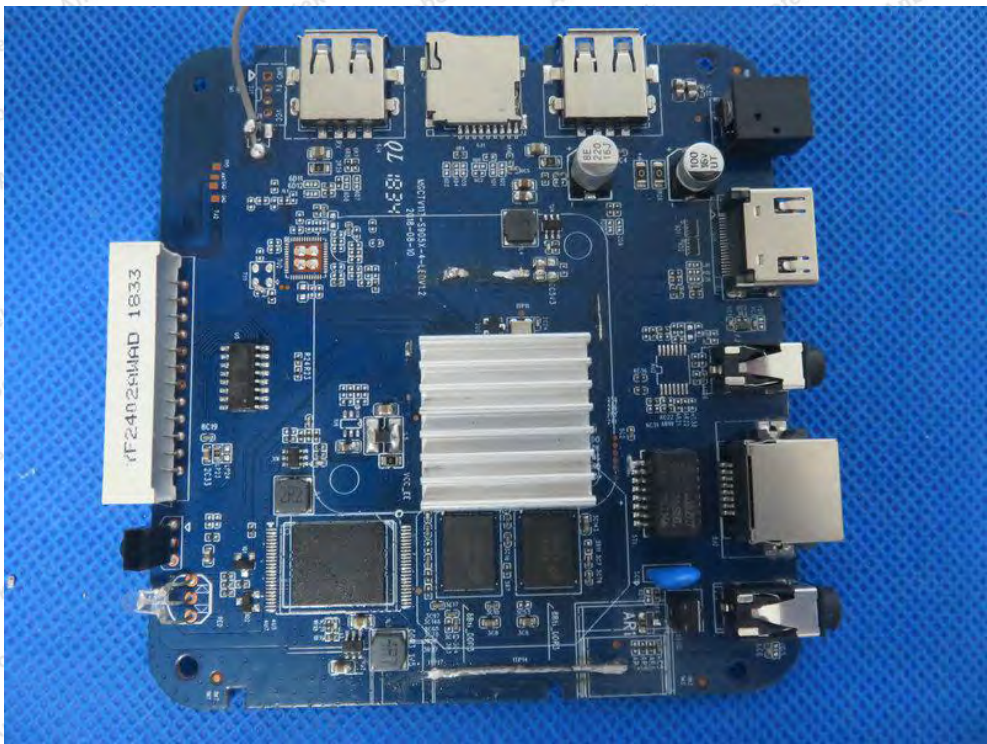

----- End of Report -----