

FCC SAR Test Report

Product : Wearable video camera
 Trade mark : Spectacles
 Model/Type reference : 002
 Report Number : 180808004SAR-1
 Date of Issue : Aug. 20, 2018
 FCC ID : 2AIRN-002
 Test Standards : FCC 47 CFR Part 2 §2.1093
 ANSI/IEEE C95.1-1992
 IEEE Std 1528-2013
 Test result : PASS

Prepared for:

Snap Inc.

63 Market Street, Venice, CA 90291, USA

Prepared by:

Shenzhen UnionTrust Quality and Technology Co., Ltd.

**16/F, Block A, Building 6, Baoneng Science and Technology Park,
 Qingxiang Road No.1, Longhua New District, Shenzhen, China**

TEL: +86-755-2823 0888

FAX: +86-755-2823 0886

Tested by:

Robing Luo

Robing Luo

Engineer



Approved by:

Billy Li

Technical Director

Reviewed by:

Ricky Xu

Ricky Xu

Supervisor

Date:

Aug. 20, 2018



Shenzhen UnionTrust Quality and Technology Co., Ltd.

Address: 16/F, Block A, Building 6, Baoneng Science and Technology Park, Qingxiang Road No.1, Longhua New District, Shenzhen, China
 Tel: +86-755-28230888 Fax: +86-755-28230886 E-mail: info@uttlab.com [Http://www.uttlab.com](http://www.uttlab.com)

Version

Version No.	Date	Description
V1.0	Aug. 20, 2018	Original



Shenzhen UnionTrust Quality and Technology Co., Ltd.

Address: 16/F, Block A, Building 6, Baoneng Science and Technology Park, Qingxiang Road No.1, Longhua New District, Shenzhen, China
Tel: +86-755-28230888 Fax: +86-755-28230886 E-mail: info@uttlab.com [Http://www.uttlab.com](http://www.uttlab.com)

Contents

	Page
1 GENERAL INFORMATION	5
1.1 STATEMENT OF COMPLIANCE.....	5
1.2 EUT DESCRIPTION.....	5
1.2.1 General Description.....	5
1.2.2 Wireless Technologies.....	6
1.2.3 List of Accessory.....	6
1.3 MAXIMUM CONDUCTED POWER	7
1.4 OTHER INFORMATION.....	8
1.5 TESTING LOCATION	8
1.6 TEST FACILITY	8
1.7 GUIDANCE STANDARD	9
2 SPECIFIC ABSORPTION RATE (SAR).....	10
2.1 INTRODUCTION.....	10
2.2 SAR DEFINITION.....	10
2.3 SAR LIMITS	10
3 SAR MEASUREMENT SYSTEM	11
3.1 SPEAG DASY SYSTEM	11
3.1.1 Robot	11
3.1.2 Probe	12
3.1.3 Data Acquisition Electronics (DAE)	12
3.1.4 Phantom	13
3.1.5 Device Holder	14
3.1.6 System Validation Dipoles	14
3.2 SAR SCAN PROCEDURE.....	15
3.2.1 SAR Reference Measurement (drift)	15
3.2.2 Area Scan	15
3.2.3 Zoom Scan	15
3.2.4 SAR Drift Measurement.....	16
3.3 TEST EQUIPMENT	17
3.4 MEASUREMENT UNCERTAINTY.....	18
3.5 TISSUE DIELECTRIC PARAMETER MEASUREMENT & SYSTEM VERIFICATION	19
3.5.1 Tissue Simulating Liquids.....	19
3.5.2 System Check Description	21
3.5.3 Tissue Verification.....	22
3.5.4 System Verification	22
4 SAR MEASUREMENT EVALUATION.....	23
4.1 EUT CONFIGURATION AND SETTING.....	23
4.1.1 WLAN Configuration and Testing	23
4.2 EUT TESTING POSITION.....	25
4.2.1 Head Exposure Conditions.....	25
4.2.2 Body Exposure Conditions	25
4.3 MEASURED CONDUCTED POWER RESULT	26
4.3.1 Conducted Power of WLAN	26
4.3.2 Conducted Power of BT	28
4.4 SAR TEST EXCLUSION EVALUATIONS	29
4.4.1 Standalone SAR Test Exclusion Considerations	29
4.4.2 Estimated SAR Calculation	30
4.5 SAR TESTING RESULTS.....	31
4.5.1 SAR Test Reduction Considerations	31
4.5.2 SAR Results for Head Exposure Condition (Separation Distance is 0 cm)	32

4.5.3 SAR Results for Body Exposure Condition (Separation Distance is 0 cm)..... 34

4.6 SAR MEASUREMENT VARIABILITY 36

4.6.1 Repeated Measurement..... 36

4.6.2 DUT Holder Perturbations 37

- Appendix A. SAR Plots of System Verification**
- Appendix B. SAR Plots of SAR Measurement**
- Appendix C. Calibration Certificate for Probe and Dipole**
- Appendix D. Photographs of EUT and Setup**



1 General Information

1.1 Statement of Compliance

The maximum results of Specific Absorption Rate (SAR) found during testing for the EUT are as follows:

Veronica

Equipment Class	Mode	Highest Reported Head SAR _{1g} (0 cm Gap) (W/kg)	Highest Reported Body SAR _{1g} (0 cm Gap) (W/kg)
DTS	2.4G WLAN	0.94	0.91
NII	5.2G WLAN	0.90	0.78
	5.3G WLAN	N/A	N/A
	5.6G WLAN	1.17	0.69
	5.8G WLAN	1.10	0.76
DSS	Bluetooth	N/A	N/A

Nico

Equipment Class	Mode	Highest Reported Head SAR _{1g} (0 cm Gap) (W/kg)	Highest Reported Body SAR _{1g} (0 cm Gap) (W/kg)
DTS	2.4G WLAN	1.00	0.69
NII	5.2G WLAN	0.83	1.00
	5.3G WLAN	N/A	N/A
	5.6G WLAN	1.14	1.13
	5.8G WLAN	1.05	1.06
DSS	Bluetooth	N/A	N/A

1.2 EUT Description

1.2.1 General Description

Product Name	Wearable video camera
Trade mark	Spectacles
Model No.(EUT)	002
FCC ID	2AIRN-002
HW Version	N/A
SW Version	N/A
Tx Frequency Bands (Unit: MHz)	WLAN: 2412 ~ 2462, 5180 ~ 5240, 5260 ~ 5320, 5500 ~ 5700, 5745 ~ 5825 Bluetooth: 2402 ~ 2480
Antenna Type	Fixed Internal Antenna
EUT Stage	Identical Prototype
Declaration of Differences	One model have two styles "Nico" and "Veronica", and SAR testing of each style is performed to demonstrate compliance;

1.2.2 Wireless Technologies

2.4G WLAN	802.11b 802.11g 802.11n (HT20/HT40)
5G WLAN	802.11a 802.11n (HT20/HT40) 802.11ac (VHT20/VHT40/VHT80)
Bluetooth	V3.0 (BR+EDR) V4.2 (LE)

1.2.3 List of Accessory

Battery	Model Name	SC03
	Power Rating	3.8Vdc, 96mAh

1.3 Maximum Conducted Power

The maximum conducted average power (Unit: dBm) including tune-up tolerance is shown as below.

Mode	2.4G WLAN
802.11b	13.0
802.11g	13.0
802.11n HT20	13.0
802.11n HT40	13.0

Mode	5.2G WLAN	5.3G WLAN	5.6G WLAN	5.8G WLAN
802.11a	10.0	10.0	10.0	10.0
802.11n HT20	10.0	10.0	10.0	10.0
802.11n HT40	10.0	10.0	10.0	10.0
802.11ac VHT20	10.0	10.0	10.0	10.0
802.11ac VHT40	10.0	10.0	10.0	10.0
802.11ac VHT80	10.0	10.0	10.0	10.0

Mode		2.4G Bluetooth
V3.0 (BR + EDR)	GFSK	9.5
	$\pi/4$ -DQPSK	9.5
	8-DPSK	8.5
V4.2 (LE)	GFSK	-1.0

1.4 Other Information

Sample Received Date:	Aug. 14, 2018
Sample tested Date:	Aug. 16, 2018 ~ Aug. 20, 2018

1.5 Testing Location

Shenzhen UnionTrust Quality and Technology Co., Ltd.	
Address: Address: 16/F, Block A, Building 6, Baoneng Science and Technology Park, Qingxiang Road No.1, Longhua New District, Shenzhen, China	
Telephone: +86-755-28230888	Fax: +86-755-28230886
Mail: info@uttlab.com	Website: Http://www.uttlab.com

1.6 Test Facility

The test facility is recognized, certified, or accredited by the following organizations:

CNAS-Lab Code: L9069

The measuring equipment utilized to perform the tests documented in this report has been calibrated once a year or in accordance with the manufacturer's recommendations, and is traceable under the ISO/IEC/EN 17025 to international or national standards. Equipment has been calibrated by accredited calibration laboratories.

IC-Registration No.: 21600-1

The 3m Semi-anechoic chamber of Shenzhen UnionTrust Quality and Technology Co., Ltd. has been registered by Certification and Engineering Bureau of Industry Canada for radio equipment testing with Registration No.: 21600-1.

A2LA-Lab Certificate No.: 4312.01

Shenzhen UnionTrust Quality and Technology Co., Ltd. has been accredited by A2LA for technical competence in the field of electrical testing, and proved to be in compliance with ISO/IEC 17025: 2005 General Requirements for the Competence of Testing and Calibration Laboratories and any additional program requirements in the identified field of testing.

FCC Accredited Lab.

Designation Number: CN1194

Test Firm Registration Number: 259480

Shenzhen UnionTrust Quality and Technology Co., Ltd.

Address: 16/F, Block A, Building 6, Baoneng Science and Technology Park, Qingxiang Road No.1, Longhua New District, Shenzhen, China
 Tel: +86-755-28230888 Fax: +86-755-28230886 E-mail: info@uttlab.com [Http://www.uttlab.com](http://www.uttlab.com)

1.7 Guidance Standard

The tests documented in this report were performed in accordance with FCC 47 CFR Part 2 §2.1093, IEEE Std 1528-2013, ANSI/IEEE C95.1-1992, the following FCC Published RF exposure KDB procedures:

KDB 865664 D01 v01r04

KDB 865664 D02 v01r02

KDB 248227 D01 v02r02

KDB 447498 D01 v06

The equipment have been tested by **Shenzhen UnionTrust Quality and Technology Co., Ltd.**, and found compliance with the requirement of the above standards.

2 Specific Absorption Rate (SAR)

2.1 Introduction

SAR is related to the rate at which energy is absorbed per unit mass in an object exposed to a radio field. The SAR distribution in a biological body is complicated and is usually carried out by experimental techniques or numerical modeling, by appropriate techniques, to produce specific absorption rates (SARs) as averaged over the whole-body, any 1 g or any 10 g of tissue (defined as a tissue volume in the shape of a cube). All SAR values are to be averaged over any six-minute period. When portable device was used within 20 cm of the user's body, SAR evaluation of the device will be required. The SAR limit in chapter 2.3.

2.2 SAR Definition

The SAR definition is the time derivative (rate) of the incremental energy (dW) absorbed by (dissipated in) an incremental mass (dm) contained in a volume element (dv) of a given density (ρ). The equation description is as below:

$$SAR = \frac{d}{dt} \left(\frac{dW}{dm} \right) = \frac{d}{dt} \left(\frac{dW}{\rho dv} \right)$$

SAR is expressed in units of Watts per kilogram (W/kg)

SAR measurement can be related to the electrical field in the tissue by

$$SAR = \frac{\sigma |E|^2}{\rho}$$

Where: σ is the conductivity of the tissue, ρ is the mass density of the tissue and E is the RMS electrical field strength.

2.3 SAR Limits

(A) Limits for Occupational/Controlled Exposure (W/kg)

Whole-Body	Partial-Body	Hands, Wrists, Feet and Ankles
0.4	8.0	20.0

(B) Limits for General Population/Uncontrolled Exposure (W/kg)

Whole-Body	Partial-Body	Hands, Wrists, Feet and Ankles
0.08	1.6	4.0

Note:

1. Whole-Body SAR is averaged over the entire body, partial-body SAR is averaged over any 1 gram of tissue defined as a tissue volume in the shape of a cube. SAR for hands, wrists, feet and ankles is averaged over any 10 grams of tissue defined as a tissue volume in the shape of a cube.
2. At frequencies above 6.0 GHz, SAR limits are not applicable and MPE limits for power density should be applied at 5 cm or more from the transmitting device.
3. The SAR limit is specified in FCC 47 CFR Part 2 §2.1093, ANSI/IEEE C95.1-1992.

Shenzhen UnionTrust Quality and Technology Co., Ltd.

3 SAR Measurement System

3.1 SPEAG DASY System

DASY system consists of high precision robot, probe alignment sensor, phantom, robot controller, controlled measurement server and near-field probe. The robot includes six axes that can move to the precision position of the DASY5 software defined. The DASY software can define the area that is detected by the probe. The robot is connected to controlled box. Controlled measurement server is connected to the controlled robot box. The DAE includes amplifier, signal multiplexing, AD converter, offset measurement and surface detection. It is connected to the Electro-optical coupler (ECO). The ECO performs the conversion from the optical into digital electric signal of the DAE and transfers data to the PC.

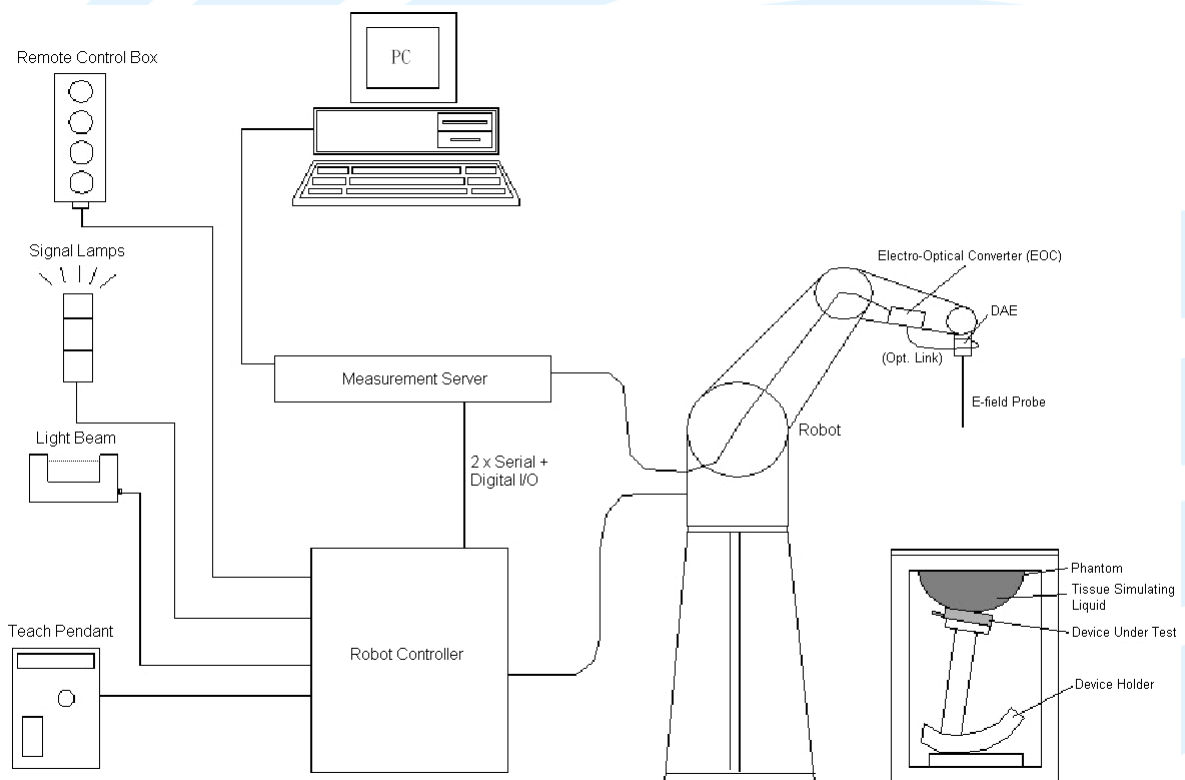

DASY Measurement System

3.1.1 Robot

The DASY system uses the high precision robots from Stäubli SA (France). For the 6-axis controller system, the robot controller version (DASY5: CS8c) from Stäubli is used. The Stäubli robot series have many features that are important for our application:

- High precision (repeatability ± 0.035 mm)
- High reliability (industrial design)
- Jerk-free straight movements
- Low ELF interference (the closed metallic construction shields against motor control fields)

3.1.2 Probe

The SAR measurement is conducted with the dosimetric probe. The probe is specially designed and calibrated for use in liquid with high permittivity. The dosimetric probe has special calibration in liquid at different frequency.

Model	EX3DV4	
Construction	Symmetrical design with triangular core. Built-in shielding against static charges. PEEK enclosure material (resistant to organic solvents, e.g., DGBE).	
Frequency	10 MHz to 6 GHz Linearity: ± 0.2 dB	
Directivity	± 0.3 dB in HSL (rotation around probe axis) ± 0.5 dB in tissue material (rotation normal to probe axis)	
Dynamic Range	10 μ W/g to 100 mW/g Linearity: ± 0.2 dB (noise: typically < 1 μ W/g)	
Dimensions	Overall length: 337 mm (Tip: 20 mm) Tip diameter: 2.5 mm (Body: 12 mm) Typical distance from probe tip to dipole centers: 1 mm	

Model	ES3DV3	
Construction	Symmetrical design with triangular core. Interleaved sensors. Built-in shielding against static charges. PEEK enclosure material (resistant to organic solvents, e.g., DGBE).	
Frequency	10 MHz to 4 GHz Linearity: ± 0.2 dB	
Directivity	± 0.2 dB in HSL (rotation around probe axis) ± 0.3 dB in tissue material (rotation normal to probe axis)	
Dynamic Range	5 μ W/g to 100 mW/g Linearity: ± 0.2 dB	
Dimensions	Overall length: 337 mm (Tip: 20 mm) Tip diameter: 3.9 mm (Body: 12 mm) Distance from probe tip to dipole centers: 2.0 mm	

3.1.3 Data Acquisition Electronics (DAE)

Model	DAE3, DAE4	
Construction	Signal amplifier, multiplexer, A/D converter and control logic. Serial optical link for communication with DASY embedded system (fully remote controlled). Two step probe touch detector for mechanical surface detection and emergency robot stop.	
Measurement Range	-100 to +300 mV (16 bit resolution and two range settings: 4mV, 400mV)	
Input Offset Voltage	$< 5\mu$ V (with auto zero)	
Input Bias Current	< 50 fA	
Dimensions	60 x 60 x 68 mm	

3.1.4 Phantom

Model	Twin SAM	
Construction	The shell corresponds to the specifications of the Specific Anthropomorphic Mannequin (SAM) phantom defined in IEEE 1528 and IEC 62209-1. It enables the dosimetric evaluation of left and right hand phone usage as well as body mounted usage at the flat phantom region. A cover prevents evaporation of the liquid. Reference markings on the phantom allow the complete setup of all predefined phantom positions and measurement grids by teaching three points with the robot.	
Material	Vinylester, glass fiber reinforced (VE-GF)	
Shell Thickness	2 ± 0.2 mm (6 ± 0.2 mm at ear point)	
Dimensions	Length: 1000 mm Width: 500 mm Height: adjustable feet	
Filling Volume	approx. 25 liters	

Model	ELI	
Construction	Phantom for compliance testing of handheld and body-mounted wireless devices in the frequency range of 30 MHz to 6 GHz. ELI is fully compatible with the IEC 62209-2 standard and all known tissue simulating liquids. ELI has been optimized regarding its performance and can be integrated into our standard phantom tables. A cover prevents evaporation of the liquid. Reference markings on the phantom allow installation of the complete setup, including all predefined phantom positions and measurement grids, by teaching three points. The phantom is compatible with all SPEAG dosimetric probes and dipoles.	
Material	Vinylester, glass fiber reinforced (VE-GF)	
Shell Thickness	2.0 ± 0.2 mm (bottom plate)	
Dimensions	Major axis: 600 mm Minor axis: 400 mm	
Filling Volume	approx. 30 liters	

3.1.5 Device Holder

Model	Mounting Device	
Construction	In combination with the Twin SAM Phantom or ELI4, the Mounting Device enables the rotation of the mounted transmitter device in spherical coordinates. Rotation point is the ear opening point. Transmitter devices can be easily and accurately positioned according to IEC, IEEE, FCC or other specifications. The device holder can be locked for positioning at different phantom sections (left head, right head, flat).	
Material	POM	

Model	Laptop Extensions Kit	
Construction	Simple but effective and easy-to-use extension for Mounting Device that facilitates the testing of larger devices according to IEC 62209-2 (e.g., laptops, cameras, etc.). It is lightweight and fits easily on the upper part of the Mounting Device in place of the phone positioner.	
Material	POM, Acrylic glass, Foam	

3.1.6 System Validation Dipoles

Model	D-Serial	
Construction	Symmetrical dipole with 1/4 balun. Enables measurement of feed point impedance with NWA. Matched for use near flat phantoms filled with tissue simulating solutions.	
Frequency	750 MHz to 5800 MHz	
Return Loss	> 20 dB	
Power Capability	> 100 W (f < 1GHz), > 40 W (f > 1GHz)	

3.2 SAR Scan Procedure

3.2.1 SAR Reference Measurement (drift)

Prior to the SAR test, local SAR shall be measured at a stationary reference point where the SAR exceeds the lower detection limit of the measurement system.

3.2.2 Area Scan

Measurement procedures for evaluating the SAR of wireless device start with a coarse measurement grid to determine the approximate location of the local peak SAR values. This is known as the area-scan procedure. All antennas and radiating structures that may contribute to the measured SAR or influence the SAR distribution must be included in the area scan. The area scan measurement resolution must enable the extrapolation algorithms of the SAR system to correctly identify the peak SAR location(s) for subsequent zoom scan measurements to correctly determine the 1-g SAR. Area scans are performed at a constant distance from the phantom surface, determined by the measurement frequencies. When a measured peak is closer than 1/2 the zoom scan volume dimension (x, y) from the edge of the area scan region, unless the entire peak and gram-averaging volume are both captured within the zoom scan volume, the area scan must be repeated by shifting and expanding the area scan region to ensure all peaks are away from the area scan boundary. The area scan resolutions specified in the table below must be applied to the SAR measurements.

	≤ 3 GHz	> 3 GHz
Maximum distance from closest measurement point (geometric center of probe sensors) to phantom surface	5 mm ± 1 mm	1/2 · δ · ln(2) mm ± 0.5 mm
Maximum probe angle from probe axis to phantom surface normal at the measurement location	30° ± 1°	20° ± 1°
Maximum area scan spatial resolution: Δx _{Area} , Δy _{Area}	≤ 2 GHz: ≤ 15 mm 2 – 3 GHz: ≤ 12 mm	3 – 4 GHz: ≤ 12 mm 4 – 6 GHz: ≤ 10 mm
	When the x or y dimension of the test device, in the measurement plane orientation, is smaller than the above, the measurement resolution must be ≤ the corresponding x or y dimension of the test device with at least one measurement point on the test device.	

3.2.3 Zoom Scan

To evaluate the peak spatial-average SAR values with respect to 1 g or 10 g cubes, fine resolution volume scans, called zoom scans, are performed at the peak SAR locations identified during the area scan. If the cube volume within the zoom scan chosen to calculate the peak spatial-average SAR touches any boundary of the zoom-scan volume, the zoom scan shall be repeated with the center of the zoom-scan volume shifted to the new maximum SAR location. For any secondary peaks found in the area scan that are within 2 dB of the maximum peak and are not within this zoom scan, the zoom scan shall be performed for such peaks, unless the peak spatial-average SAR at the location of the maximum peak is more than 2 dB below the applicable SAR limit (i.e., 1 W/kg for a 1.6 W/kg 1 g limit, or 1.26 W/kg for a 2 W/kg 10 g limit). The zoom scan resolutions specified in the table below must be applied to the SAR measurements.

Shenzhen UnionTrust Quality and Technology Co., Ltd.

			≤ 3 GHz	> 3 GHz
Maximum zoom scan spatial resolution: $\Delta x_{Zoom}, \Delta y_{Zoom}$			≤ 2 GHz: ≤ 8 mm 2 – 3 GHz: ≤ 5 mm*	3 – 4 GHz: ≤ 5 mm* 4 – 6 GHz: ≤ 4 mm*
Maximum zoom Scan spatial resolution, normal to phantom surface	uniform grid: $\Delta Z_{Zoom}(n)$		≤ 5 mm	3 – 4 GHz: ≤ 4 mm 4 – 5 GHz: ≤ 3 mm 5 – 6 GHz: ≤ 2 mm
	graded grid	$\Delta Z_{Zoom}(1)$: between 1 ST two points closest to phantom surface	≤ 4 mm	3 – 4 GHz: ≤ 3 mm 4 – 5 GHz: ≤ 2.5 mm 5 – 6 GHz: ≤ 2 mm
		$\Delta Z_{Zoom}(n>1)$: between subsequent points	≤ 1.5 · $\Delta Z_{Zoom}(n-1)$ mm	
Minimum zoom scan volume	x, y, z	≥ 30 mm	3 – 4 GHz: ≥ 28 mm 4 – 5 GHz: ≥ 25 mm 5 – 6 GHz: ≥ 22 mm	
Note: δ is the penetration depth of a plane-wave at normal incidence to the tissue medium; see IEEE Std 1528-2013 for details. * When zoom scan is required and the reported SAR from the area scan based 1-g SAR estimation procedures of KDB Publication 447498 is ≤ 1.4 W/kg, ≤ 8 mm, ≤ 7 mm and ≤ 5 mm zoom scan resolution may be applied, respectively, for 2 GHz to 3 GHz, 3 GHz to 4 GHz and 4 GHz to 6 GHz.				

3.2.4 SAR Drift Measurement

The local SAR (or conducted power) shall be measured at exactly the same location as in 3.2.1 section. The absolute value of the measurement drift (the difference between the SAR measured in 3.2.1 and 3.2.4 section) shall be recorded. The SAR drift shall be kept within ± 5%.

3.3 Test Equipment

Equipment	Manufacturer	Model	SN	Cal. Date	Cal. Interval
System Validation Dipole	SPEAG	D2450V2	809	Mar. 22, 2018	3 Year
System Validation Dipole	SPEAG	D5GHzV2	1040	Jun. 28, 2018	3 Year
Dosimetric E-Field Probe	SPEAG	ES3DV3	3240	Mar. 28, 2018	1 Year
Dosimetric E-Field Probe	SPEAG	EX3DV4	3578	Mar. 28, 2018	1 Year
Data Acquisition Electronics	SPEAG	DAE3	420	Mar. 22, 2018	1 Year
ENA Series Network Analyzer	Agilent	8753ES	MY40000519	Sep. 28, 2017	1 Year
EXG-B RF Analog Signal Generator	KEYSIGHT	N5171B	MY53051777	Dec. 10, 2017	1 Year
USB Wideband Power Sensor	KEYSIGHT	U2021XA	MY55430035	Dec. 10, 2017	1 Year
USB Wideband Power Sensor	KEYSIGHT	U2021XA	MY55430023	Dec. 10, 2017	1 Year
Thermometer	Shanghai Gao Zhi Precision Instrument Co., Ltd.	HB6801	120100323	Mar. 29, 2018	1 Year
Amplifier	SATIMO	Amplifier	MODU-023-A-0003	N/A	N/A
Coupler	REBES	TC-05180-10 S	161221001	09. 18, 2017	1 Year

3.4 Measurement Uncertainty

Per KDB 865664 D01 SAR Measurement 100 MHz to 6 GHz, when the highest measured 1-g SAR within a frequency band is < 1.5 W/kg, the extensive SAR measurement uncertainty analysis described in IEEE Std 1528-2013 is not required in SAR reports submitted for equipment approval.



3.5 Tissue Dielectric Parameter Measurement & System Verification

3.5.1 Tissue Simulating Liquids

The temperature of the tissue-equivalent medium used during measurement must also be within 18 °C to 25 °C and within ± 2 °C of the temperature when the tissue parameters are characterized. The dielectric parameters must be measured before the tissue-equivalent medium is used in a series of SAR measurements. The parameters should be re-measured after each 3 - 4 days of use; or earlier if the dielectric parameters can become out of tolerance.

The depth of tissue-equivalent liquid in a phantom must be ≥ 15.0 cm with ≤ ± 0.5 cm variation for SAR measurements ≤ 3 GHz and ≥ 10.0 cm with ≤ ± 0.5 cm variation for measurements > 3 GHz. The nominal dielectric values of the tissue simulating liquids in the phantom and the tolerance of 5% are listed in Table-3.1.



Photo of Liquid Height

Table-3.1 Tissue Dielectric Parameters for Head and Body

Target Frequency (MHz)	Head		Body	
	ϵ_r	σ (S/m)	ϵ_r	σ (S/m)
750	41.9	0.89	55.5	0.96
835	41.5	0.90	55.2	0.97
900	41.5	0.97	55.0	1.05
1450	40.5	1.20	54.0	1.30
1640	40.3	1.29	53.8	1.40
1750	40.1	1.37	53.4	1.49
1800	40.0	1.40	53.3	1.52
1900	40.0	1.40	53.3	1.52
2000	40.0	1.40	53.3	1.52
2300	39.5	1.67	52.9	1.81
2450	39.2	1.80	52.7	1.95
2600	39.0	1.96	52.5	2.16
3500	37.9	2.91	51.3	3.31
5200	36.0	4.66	49.0	5.30
5300	35.9	4.76	48.9	5.42
5500	35.6	4.96	48.6	5.65
5600	35.5	5.07	48.5	5.77
5800	35.3	5.27	48.2	6.00

(ϵ_r = relative permittivity, σ = conductivity and ρ = 1000 kg/m³)

The following table gives the recipes for tissue simulating liquids.

Table-3.2 Recipes of Tissue Simulating Liquid

Tissue Type	Bactericide	DGBE	HEC	NaCl	Sucrose	Triton X-100	Water	Diethylene Glycol Mono-hexylether
H750	0.2	-	0.2	1.4	57.0	-	41.1	-
H835	0.1	-	1.0	1.4	57.0	-	40.5	-
H900	0.1	-	1.0	1.5	56.5	-	40.9	-
H1450	-	45.5	-	0.7	-	-	53.8	-
H1640	-	45.8	-	0.5	-	-	53.7	-
H1750	-	44.5	-	0.3	-	-	55.2	-
H1800	-	44.9	-	0.2	-	-	54.9	-
H1900	-	44.9	-	0.2	-	-	54.9	-
H2000	-	50	-	-	-	-	50	-
H2300	-	44.9	-	0.1	-	-	55.0	-
H2450	-	45.0	-	0.1	-	-	54.9	-
H2600	-	45.1	-	0.1	-	-	54.8	-
H3500	-	8.0	-	0.2	-	20.0	71.8	-
H5G	-	-	-	-	-	17.2	65.52	17.3
B750	0.2	-	0.2	0.8	48.8	-	50.0	-
B835	0.2	-	0.2	0.9	48.5	-	50.2	-
B900	0.2	-	0.2	0.9	48.2	-	50.5	-
B1450	-	34.0	-	0.3	-	-	65.7	-
B1640	-	32.5	-	0.3	-	-	67.2	-
B1750	-	29.4	-	0.4	-	-	70.2	-
B1800	-	29.5	-	0.4	-	-	70.1	-
B1900	-	29.5	-	0.3	-	-	70.2	-
B2000	-	30.0	-	0.2	-	-	69.8	-
B2300	-	31.0	-	0.1	-	-	68.9	-
B2450	-	31.4	-	0.1	-	-	68.5	-
B2600	-	31.8	-	0.1	-	-	68.1	-
B3500	-	28.8	-	0.1	-	-	71.1	-
B5G	-	-	-	-	-	10.7	78.6	10.7

3.5.2 System Check Description

The system check procedure provides a simple, fast, and reliable test method that can be performed daily or before every SAR measurement. The objective here is to ascertain that the measurement system has acceptable accuracy and repeatability. This test requires a flat phantom and a radiating source. The system verification setup is shown as below.

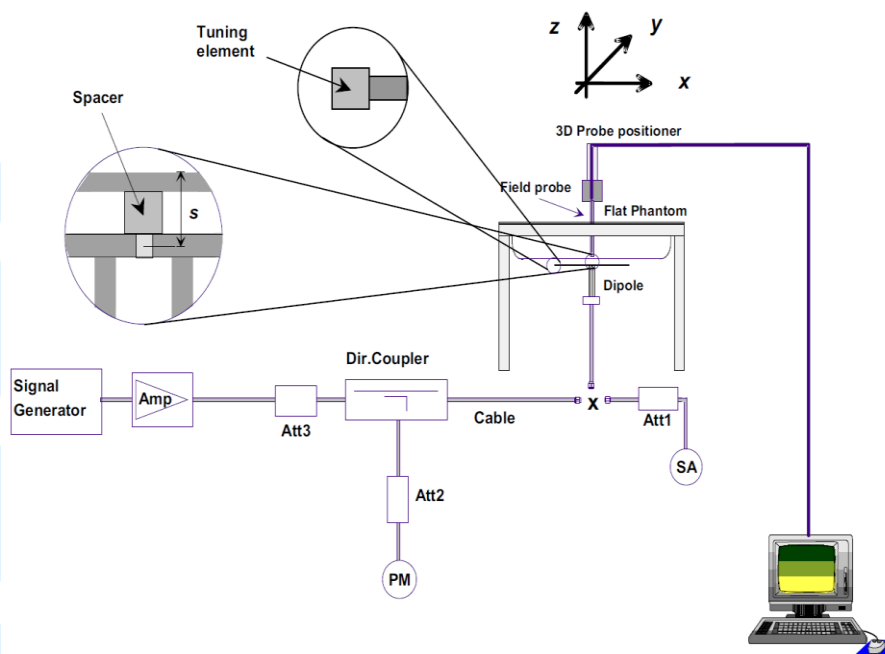

System Verification Setup

3.5.3 Tissue Verification

The measuring results for tissue simulating liquid are shown as below.

Test Date	Tissue Type	Frequency (MHz)	Liquid Temp. (°C)	Measured Conductivity (σ)	Measured Permittivity (ϵ_r)	Target Conductivity (σ)	Target Permittivity (ϵ_r)	Conductivity Deviation (%)	Permittivity Deviation (%)
Aug. 19, 2018	Head	2450	22.0	1.854	37.997	1.80	39.20	3.00	-3.07
Aug. 17, 2018	Head	5200	22.1	4.703	37.093	4.66	36.00	0.92	3.04
Aug. 18, 2018	Head	5600	22.4	5.210	36.221	5.07	35.50	2.76	2.03
Aug. 18, 2018	Head	5800	22.4	5.442	35.768	5.27	35.30	3.26	1.33
Aug. 20, 2018	Body	2450	21.9	2.028	52.823	1.95	52.70	4.00	0.23
Aug. 16, 2018	Body	5200	21.8	5.244	49.469	5.30	49.00	-1.06	0.96
Aug. 16, 2018	Body	5600	21.8	5.852	48.725	5.77	48.50	1.42	0.46
Aug. 17, 2018	Body	5800	21.7	6.113	48.226	6.00	48.20	1.88	0.05

Note:

The dielectric properties of the tissue simulating liquid must be measured within 24 hours before the SAR testing and within $\pm 5\%$ of the target values. The variation of the liquid temperature must be within $\pm 2^\circ\text{C}$ during the test.

3.5.4 System Verification

The measuring result for system verification is tabulated as below.

Test Date	Tissue Type	Frequency (MHz)	1W Target SAR-1g (W/kg)	Measured SAR-1g (W/kg)	Normalized to 1W SAR-1g (W/kg)	Deviation (%)	Dipole S/N	Probe S/N	DAE S/N
Aug. 19, 2018	Head	2450	52.20	0.498	49.80	-4.60	809	3240	420
Aug. 17, 2018	Head	5200	78.80	8.350	83.50	5.96	1040	3578	420
Aug. 18, 2018	Head	5600	85.30	8.700	87.00	1.99	1040	3578	420
Aug. 18, 2018	Head	5800	80.60	8.280	82.80	2.73	1040	3578	420
Aug. 20, 2018	Body	2450	50.70	0.461	46.10	-9.07	809	3240	420
Aug. 16, 2018	Body	5200	75.20	0.756	75.60	0.53	1040	3578	420
Aug. 16, 2018	Body	5600	81.50	0.814	81.40	-0.12	1040	3578	420
Aug. 17, 2018	Body	5800	77.30	0.841	84.10	8.80	1040	3578	420

Note:

Comparing to the reference SAR value, the validation data should be within its specification of 10%. The result indicates the system check can meet the variation criterion and the plots can be referred to Appendix A of this report.

4 SAR Measurement Evaluation

4.1 EUT Configuration and Setting

4.1.1 WLAN Configuration and Testing

In general, various vendor specific external test software and chipset based internal test modes are typically used for SAR measurement. These chipset based test mode utilities are generally hardware and manufacturer dependent, and often include substantial flexibility to reconfigure or reprogram a device. A Wi-Fi device must be configured to transmit continuously at the required data rate, channel bandwidth and signal modulation, using the highest transmission duty factor supported by the test mode tools for SAR measurement. The test frequencies established using test mode must correspond to the actual channel frequencies. When 802.11 frame gaps are accounted for in the transmission, a maximum transmission duty factor of 92 - 96% is typically achievable in most test mode configurations. A minimum transmission duty factor of 85% is required to avoid certain hardware and device implementation issues related to wide range SAR scaling. In addition, a periodic transmission duty factor is required for current generation SAR systems to measure SAR correctly. The reported SAR must be scaled to 100% transmission duty factor to determine compliance at the maximum tune-up tolerance limit.

According to KDB 248227 D01, this device has installed WLAN engineering testing software which can provide continuous transmitting RF signal. During WLAN SAR testing, this device was operated to transmit continuously at the maximum transmission duty with specified transmission mode, operating frequency, lowest data rate, and maximum output power.

Initial Test Configuration

An initial test configuration is determined for OFDM transmission modes in 2.4 GHz and 5 GHz bands according to the channel bandwidth, modulation and data rate combination(s) with the highest maximum output power specified for production units in each standalone and aggregated frequency band. When the same maximum power is specified for multiple transmission modes in a frequency band, the largest channel bandwidth, lowest order modulation, lowest data rate and lowest order 802.11a/g/n/ac mode is used for SAR measurement, on the highest measured output power channel in the initial test configuration, for each frequency band.

Subsequent Test Configuration

SAR measurement requirements for the remaining 802.11 transmission mode configurations that have not been tested in the initial test configuration are determined separately for each standalone and aggregated frequency band, in each exposure condition, according to the maximum output power specified for production units. Additional power measurements may be required to determine if SAR measurements are required for subsequent highest output power channels in a subsequent test configuration. When the highest reported SAR for the initial test configuration according to the initial test position or fixed exposure position requirements, is adjusted by the ratio of the subsequent test configuration to initial test configuration specified maximum output power and the adjusted SAR is ≤ 1.2 W/kg, SAR is not required for that subsequent test configuration.

SAR Test Configuration and Channel Selection

When multiple channel bandwidth configurations in a frequency band have the same specified maximum output power, the initial test configuration is using largest channel bandwidth, lowest order modulation, lowest data rate, and lowest order 802.11 mode (i.e., 802.11a is chosen over 802.11n then 802.11ac or 802.11g is chosen over 802.11n). After an initial test configuration is determined, if multiple test channels have the same measured

Shenzhen UnionTrust Quality and Technology Co., Ltd.

maximum output power, the channel chosen for SAR measurement is determined according to the following.

- 1) The channel closest to mid-band frequency is selected for SAR measurement.
- 2) For channels with equal separation from mid-band frequency; for example, high and low channels or two mid-band channels, the higher frequency (number) channel is selected for SAR measurement.

Test Reduction for U-NII-1 (5.2 GHz) and U-NII-2A (5.3 GHz) Bands

For devices that operate in both U-NII bands using the same transmitter and antenna(s), SAR test reduction is determined according to the following.

- 1) When the same maximum output power is specified for both bands, begin SAR measurement in U-NII-2A band by applying the OFDM SAR requirements. If the highest reported SAR for a test configuration is ≤ 1.2 W/kg, SAR is not required for U-NII-1 band for that configuration (802.11 mode and exposure condition).
- 2) When different maximum output power is specified for the bands, begin SAR measurement in the band with higher specified maximum output power. The highest reported SAR for the tested configuration is adjusted by the ratio of lower to higher specified maximum output power for the two bands. When the adjusted SAR is ≤ 1.2 W/kg, SAR is not required for the band with lower maximum output power in that test configuration.

4.2 EUT Testing Position

4.2.1 Head Exposure Conditions

RF Exposure Conditions	Test Position	Separation Distance	SAR test exclusion
Head	Front Face	0 cm	Note
	Rear Face		
	Left Side		
	Right Side		
	Top Side		
	Bottom Side		

Note: The distance is over 5cm between left side and antenna, so left Side was not tested for SAR.

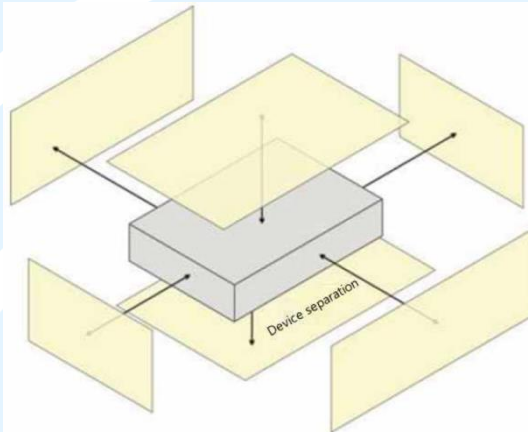

Fig-4.1 Test Positions

4.2.2 Body Exposure Conditions

RF Exposure Conditions	Test Position	Separation Distance	SAR test exclusion
Body	Front Face	0 cm	Note
	Rear Face		
	Left Side		
	Right Side		
	Top Side		
	Bottom Side		

Note: The distance is over 5cm between left side and antenna, so left Side was not tested for SAR.

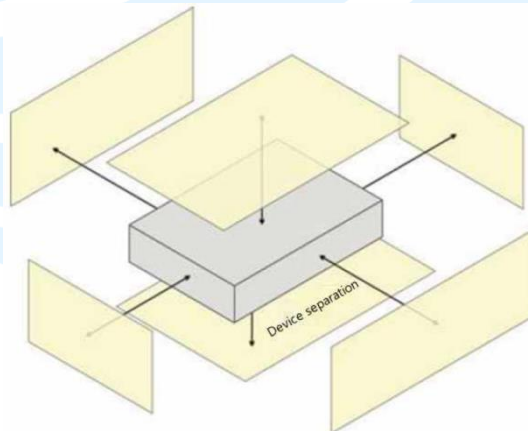

Fig-4.2 Test Positions

4.3 Measured Conducted Power Result

4.3.1 Conducted Power of WLAN

Mode		Channel	Frequency (MHz)	Average Power (dBm)
2.4G	802.11b	1	2412	12.65
		6	2437	12.30
		11	2462	11.84
	802.11g	1	2412	11.79
		6	2437	11.56
		11	2462	11.13
	802.11n (HT20)	1	2412	12.15
		6	2437	11.93
		11	2462	11.41
	802.11n (HT40)	3	2422	12.13
		6	2437	11.62
		9	2452	12.35

Mode		Channel	Frequency (MHz)	Average Power (dBm)	
802.11a	5.2G	36	5180	9.40	
		40	5200	9.41	
		44	5220	9.43	
		48	5240	9.30	
	5.3G	52	5260	9.17	
		56	5280	8.71	
		60	5300	8.72	
		64	5320	8.59	
	5.6G	100	5500	8.48	
		116	5580	9.46	
		132	5660	9.32	
		140	5700	9.35	
	5.8G	149	5745	8.31	
		157	5785	8.53	
			165	5825	8.87

Mode		Channel	Frequency (MHz)	Average Power (dBm)
802.11n (HT20)	5.2G	36	5180	9.05
		40	5200	9.11
		44	5220	9.18
		48	5240	9.11
	5.3G	52	5260	8.84
		56	5280	8.44
		60	5300	8.48
		64	5320	8.33
	5.6G	100	5500	8.27
		116	5580	9.33
		132	5660	9.21
		140	5700	9.15
	5.8G	149	5745	9.68
157		5785	8.85	
165		5825	8.64	

Mode		Channel	Frequency (MHz)	Average Power (dBm)
802.11n (HT40)	5.2G	38	5190	9.50
		46	5230	9.32
	5.3G	54	5270	8.80
		62	5310	8.74
	5.6G	102	5510	8.24
		110	5550	9.31
		134	5670	9.67
	5.8G	151	5755	9.44
		159	5795	9.09

Mode		Channel	Frequency (MHz)	Average Power (dBm)
802.11ac (VHT20)	5.2G	36	5180	9.03
		40	5200	9.12
		44	5220	9.17
		48	5240	9.10
	5.3G	52	5260	8.82
		56	5280	8.41
		60	5300	8.45
		64	5320	8.35
	5.6G	100	5500	8.23
		116	5580	9.30
		132	5660	9.14
		140	5700	9.08
	5.8G	149	5745	9.53
157		5785	8.57	
165		5825	8.46	

Shenzhen UnionTrust Quality and Technology Co., Ltd.

 Address: 16/F, Block A, Building 6, Baoneng Science and Technology Park, Qingxiang Road No.1, Longhua New District, Shenzhen, China
 Tel: +86-755-28230888 Fax: +86-755-28230886 E-mail: info@uttlab.com [Http://www.uttlab.com](http://www.uttlab.com)

Mode		Channel	Frequency (MHz)	Average Power (dBm)
802.11ac (VHT40)	5.2G	38	5190	9.11
		46	5230	9.02
	5.3G	54	5270	8.37
		62	5310	8.58
	5.6G	102	5510	8.27
		110	5550	9.18
		134	5670	9.31
	5.8G	151	5755	9.24
		159	5795	8.77

Mode		Channel	Frequency (MHz)	Average Power (dBm)
802.11ac (VHT80)	5.2G	42	5210	9.22
	5.3G	58	5290	8.20
	5.6G	106	5530	9.15
	5.8G	155	5775	9.66

4.3.2 Conducted Power of BT

Mode		Channel	Frequency (MHz)	Average Power (dBm)
V3.0 (BR + EDR)	GFSK	0	2402	8.99
		39	2441	9.00
		78	2480	8.48
	$\pi/4$ -DQPSK	0	2402	8.30
		39	2441	8.35
		78	2480	7.82
	8-DPSK	0	2402	7.36
		39	2441	7.37
		78	2480	6.78

Mode		Channel	Frequency (MHz)	Average Power (dBm)
V4.2 (LE)	LE	0	2402	-2.66
		19	2440	-2.55
		39	2480	-2.42

4.4 SAR Test Exclusion Evaluations

4.4.1 Standalone SAR Test Exclusion Considerations

According to KDB 447498 D01, the SAR test exclusion condition is based on source-based time-averaged maximum conducted output power, adjusted for tune-up tolerance, and the minimum test separation distance required for the exposure conditions. The 1-g and 10-g SAR test exclusion thresholds are determined by the following:

- a) For 100 MHz to 6 GHz and test separation distances ≤ 50 mm:

$$\frac{\text{Max. Tune up Power}_{(mW)}}{\text{Min. Test Separation Distance}_{(mm)}} \times \sqrt{f_{(GHz)}} \leq 3.0 \text{ for SAR-1g, } \leq 7.5 \text{ for SAR-10g}$$

When the minimum test separation distance is < 5 mm, a distance of 5 mm is applied to determine SAR test exclusion.

- b) For 100 MHz to 1500 MHz and test separation distances > 50 mm:

$$\{[\text{Threshold for 50 mm in step a)}] + [(\text{test separation distance} - 50 \text{ mm}) \cdot (f_{(MHz)}/150)]\} \text{ mW}$$

- c) For > 1500 MHz and ≤ 6 GHz and test separation distances > 50 mm:

$$\{[\text{Threshold for 50 mm in step a)}] + [(\text{test separation distance} - 50 \text{ mm}) \cdot 10]\} \text{ mW}$$

When the calculated result in step a) is ≤ 3.0 for SAR-1g exposure condition, or ≤ 7.5 for SAR-10g exposure condition, the SAR testing exclusion is applied.

When the device output power is less than the calculated result (power threshold, mW) shown in in step b) and c), the SAR testing exclusion is applied.

Mode	Max. Tune-up Power (dBm)	Max. Tune-up Power (mW)	Head			Body		
			Ant. to Surface (mm)	Calculated Result	Require SAR Testing?	Ant. to Surface (mm)	Calculated Result	Require SAR Testing?
BT	9.5	8.91	5	2.8	No	5	2.8	No

4.4.2 Estimated SAR Calculation

According to KDB 447498 D01, when an antenna qualifies for the standalone SAR test exclusion and also transmits simultaneously with other antennas, the standalone SAR value must be estimated according to the following to determine the simultaneous transmission SAR test exclusion criteria:

a) For test separation distances ≤ 50 mm:

$$Estimated\ SAR = \frac{Max.\ Tune\ up\ Power_{(mW)}}{Min.\ Test\ Separation\ Distance_{(mm)}} \times \frac{\sqrt{f(GHz)}}{x}$$

Where $x = 7.5$ for 1-g SAR and $x = 18.75$ for 10-g SAR.

b) For test separation distances > 50 mm, 0.4 W/kg for 1-g SAR and 1.0 W/kg for 10-g SAR.

Mode / Band	Frequency (GHz)	Max. Tune-up Power (dBm)	Test Position	Separation Distance (mm)	Estimated SAR (W/kg)
BT (DSS)	2.48	9.5	Head	5	0.37
BT (DSS)	2.48	9.5	Body	5	0.37

4.5 SAR Testing Results

4.5.1 SAR Test Reduction Considerations

KDB 447498 D01 General RF Exposure Guidance

Testing of other required channels within the operating mode of a frequency band is not required when the *reported* SAR for the mid-band or highest output power channel is:

- a) ≤ 0.8 W/kg or 2.0 W/kg, for 1-g or 10-g respectively, when the transmission band is ≤ 100 MHz
- b) ≤ 0.6 W/kg or 1.5 W/kg, for 1-g or 10-g respectively, when the transmission band is between 100 MHz and 200 MHz
- c) ≤ 0.4 W/kg or 1.0 W/kg, for 1-g or 10-g respectively, when the transmission band is ≥ 200 MHz

KDB 248227 D01 Wi-Fi SAR

- a) For handsets operating next to ear, hotspot mode or mini-tablet configurations, the initial test position procedures were applied. The test position with the highest extrapolated peak SAR will be used as the initial test position. When the reported SAR of initial test position is ≤ 0.4 W/kg, SAR testing for remaining test positions is not required. Otherwise, SAR is evaluated at the subsequent highest peak SAR positions until the reported SAR result is ≤ 0.8 W/kg or all test positions are measured.
- b) For WLAN 2.4 GHz, the highest measured maximum output power channel for DSSS was selected for SAR measurement. When the reported SAR is ≤ 0.8 W/kg, no further SAR testing is required. Otherwise, SAR is evaluated at the next highest measured output power channel. When any reported SAR is > 1.2 W/kg, SAR is required for the third channel. For OFDM modes (802.11g/n), SAR is not required when the highest reported SAR for DSSS is adjusted by the ratio of OFDM to DSSS specified maximum output power and it is ≤ 1.2 W/kg.
- c) For WLAN 5 GHz, the initial test configuration was selected according to the transmission mode with the highest maximum output power. When the reported SAR of initial test configuration is > 0.8 W/kg, SAR is required for the subsequent highest measured output power channel until the reported SAR result is ≤ 1.2 W/kg or all required channels are measured. For other transmission modes, SAR is not required when the highest reported SAR for initial test configuration is adjusted by the ratio of subsequent test configuration to initial test configuration specified maximum output power and it is ≤ 1.2 W/kg.

4.5.2 SAR Results for Head Exposure Condition (Separation Distance is 0 cm)

Veronica

Plot No.	Band	Mode	Test Position	Ch.	Max. Tune-up Power (dBm)	Measured Conducted Power (dBm)	Power Drift (dB)	Measured SAR-1g (W/kg)	Scaling Factor	Scaled SAR-1g (W/kg)
	802.11b	-	Front Face	1	13.0	12.65	-0.06	0.705	1.08	0.76
	802.11b	-	Rear Face Close	1	13.0	12.65	0.06	0.303	1.08	0.33
	802.11b	-	Rear Face Open	1	13.0	12.65	0.03	0.112	1.08	0.12
1	802.11b	-	Right Side	1	13.0	12.65	-0.08	0.864	1.08	0.94
	802.11b	-	Top Side	1	13.0	12.65	0.02	0.168	1.08	0.18
	802.11b	-	Bottom Side	1	13.0	12.65	-0.04	0.014	1.08	0.02
	802.11b	-	Right Side	6	13.0	12.30	-0.03	0.723	1.17	0.85
	802.11b	-	Right Side	1	13.0	12.65	0.02	0.858	1.08	0.93
	802.11n	HT40	Front Face	38	10.0	9.50	0.02	0.636	1.12	0.71
	802.11n	HT40	Rear Face Close	38	10.0	9.50	-0.05	0.015	1.12	0.02
	802.11n	HT40	Rear Face Open	38	10.0	9.50	0.06	0.012	1.12	0.01
	802.11n	HT40	Right Side	38	10.0	9.50	0.02	0.754	1.12	0.85
	802.11n	HT40	Top Side	38	10.0	9.50	0.01	0.025	1.12	0.03
	802.11n	HT40	Bottom Side	38	10.0	9.50	-0.07	0.012	1.12	0.01
2	802.11n	HT40	Right Side	46	10.0	9.32	0.02	0.772	1.17	0.90
	802.11n	HT40	Front Face	134	10.0	9.67	-0.02	1.04	1.08	1.12
	802.11n	HT40	Rear Face Close	134	10.0	9.67	0.05	0.019	1.08	0.02
	802.11n	HT40	Rear Face Open	134	10.0	9.67	0.06	0.014	1.08	0.02
3	802.11n	HT40	Right Side	134	10.0	9.67	0.08	1.08	1.08	1.17
	802.11n	HT40	Top Side	134	10.0	9.67	-0.04	0.032	1.08	0.03
	802.11n	HT40	Bottom Side	134	10.0	9.67	0.06	0.016	1.08	0.02
	802.11n	HT40	Right Side	110	10.0	9.18	0.05	0.42	1.21	0.51
	802.11n	HT40	Front Face	110	10.0	9.18	0.00	0.709	1.21	0.86
	802.11n	HT40	Right Side	134	10.0	9.67	0.01	1.01	1.08	1.09
4	802.11n	HT20	Front Face	149	10.0	9.68	-0.02	1.02	1.08	1.10
	802.11n	HT20	Rear Face Close	149	10.0	9.68	0.06	0.017	1.08	0.02
	802.11n	HT20	Rear Face Open	149	10.0	9.68	0.01	0.012	1.08	0.01
	802.11n	HT20	Right Side	149	10.0	9.68	0.03	0.6	1.08	0.65
	802.11n	HT20	Top Side	149	10.0	9.68	0.08	0.03	1.08	0.03
	802.11n	HT20	Bottom Side	149	10.0	9.68	0.09	0.015	1.08	0.02
	802.11n	HT20	Front Face	157	10.0	8.85	0.08	0.823	1.30	1.07
	802.11n	HT20	Front Face	149	10.0	9.68	0.03	0.989	1.08	1.06

Nico

Plot No.	Band	Mode	Test Position	Ch.	Max. Tune-up Power (dBm)	Measured Conducted Power (dBm)	Power Drift (dB)	Measured SAR-1g (W/kg)	Scaling Factor	Scaled SAR-1g (W/kg)
6	802.11b	-	Front Face	1	13.0	12.65	-0.04	0.923	1.08	1.00
	802.11b	-	Rear Face Close	1	13.0	12.65	-0.12	0.326	1.08	0.35
	802.11b	-	Rear Face Open	1	13.0	12.65	0.01	0.124	1.08	0.13
	802.11b	-	Right Side	1	13.0	12.65	0.07	0.624	1.08	0.68
	802.11b	-	Top Side	1	13.0	12.65	-0.06	0.131	1.08	0.14
	802.11b	-	Bottom Side	1	13.0	12.65	0.10	0.025	1.08	0.03
	802.11b	-	Front Face	6	13.0	12.30	-0.07	0.802	1.17	0.94
	802.11b	-	Front Face	1	13.0	12.65	0.02	0.918	1.08	1.00
	802.11n	HT40	Front Face	38	10.0	9.50	0.04	0.621	1.12	0.70
	802.11n	HT40	Rear Face Close	38	10.0	9.50	0.05	0.034	1.12	0.04
	802.11n	HT40	Rear Face Open	38	10.0	9.50	0.02	0.01	1.12	0.01
6	802.11n	HT40	Right Side	38	10.0	9.50	0.07	0.744	1.12	0.83
	802.11n	HT40	Top Side	38	10.0	9.50	-0.15	0.112	1.12	0.13
	802.11n	HT40	Bottom Side	38	10.0	9.50	0.03	0.035	1.12	0.04
	802.11n	HT40	Right Side	46	10.0	9.32	0.01	0.645	1.17	0.75
7	802.11n	HT40	Front Face	134	10.0	9.67	-0.02	1.06	1.08	1.14
	802.11n	HT40	Rear Face Close	134	10.0	9.67	0.05	0.044	1.08	0.05
	802.11n	HT40	Rear Face Open	134	10.0	9.67	0.04	0.013	1.08	0.01
	802.11n	HT40	Right Side	134	10.0	9.67	0.11	1.01	1.08	1.09
	802.11n	HT40	Top Side	134	10.0	9.67	0.09	0.145	1.08	0.16
	802.11n	HT40	Bottom Side	134	10.0	9.67	0.03	0.046	1.08	0.05
	802.11n	HT40	Right Side	110	10.0	9.18	0.07	0.91	1.21	1.10
	802.11n	HT40	Front Face	110	10.0	9.18	-0.04	0.725	1.21	0.88
	802.11n	HT40	Front Face	134	10.0	9.67	0.01	1.01	1.08	1.09
8	802.11n	HT20	Front Face	149	10.0	9.68	-0.07	0.978	1.08	1.05
	802.11n	HT20	Rear Face Close	149	10.0	9.68	0.08	0.041	1.08	0.04
	802.11n	HT20	Rear Face Open	149	10.0	9.68	0.01	0.011	1.08	0.01
	802.11n	HT20	Right Side	149	10.0	9.68	0.08	0.796	1.08	0.86
	802.11n	HT20	Top Side	149	10.0	9.68	0.18	0.134	1.08	0.14
	802.11n	HT20	Bottom Side	149	10.0	9.68	0.05	0.042	1.08	0.05
	802.11n	HT20	Front Face	157	10.0	8.85	0.04	0.801	1.30	1.04
	802.11n	HT20	Right Side	157	10.0	8.85	0.01	0.578	1.30	0.75
	802.11n	HT20	Front Face	149	10.0	9.68	0.01	0.967	1.08	1.04

4.5.3 SAR Results for Body Exposure Condition (Separation Distance is 0 cm)

Veronica

Plot No.	Band	Mode	Test Position	Ch.	Max. Tune-up Power (dBm)	Measured Conducted Power (dBm)	Power Drift (dB)	Measured SAR-1g (W/kg)	Scaling Factor	Scaled SAR-1g (W/kg)
	802.11b	-	Front Face	1	13.0	12.65	-0.02	0.667	1.08	0.72
	802.11b	-	Rear Face Close	1	13.0	12.65	0.03	0.326	1.08	0.35
	802.11b	-	Rear Face Open	1	13.0	12.65	0.02	0.189	1.08	0.20
9	802.11b	-	Right Side	1	13.0	12.65	-0.03	0.836	1.08	0.91
	802.11b	-	Top Side	1	13.0	12.65	-0.18	0.154	1.08	0.17
	802.11b	-	Bottom Side	1	13.0	12.65	0.10	0.013	1.08	0.01
	802.11b	-	Right Side	6	13.0	12.30	0.01	0.754	1.17	0.89
	802.11b	-	Right Side	1	13.0	12.65	0.04	0.829	1.08	0.90
	802.11n	HT40	Front Face	38	10.0	9.50	-0.08	0.608	1.12	0.68
	802.11n	HT40	Rear Face Close	38	10.0	9.50	0.11	0.049	1.12	0.05
	802.11n	HT40	Rear Face Open	38	10.0	9.50	0.01	0.013	1.12	0.01
10	802.11n	HT40	Right Side	38	10.0	9.50	-0.05	0.694	1.12	0.78
	802.11n	HT40	Top Side	38	10.0	9.50	0.17	0.13	1.12	0.15
	802.11n	HT40	Bottom Side	38	10.0	9.50	0.03	0.018	1.12	0.02
11	802.11n	HT40	Front Face	134	10.0	9.67	0.04	0.642	1.08	0.69
	802.11n	HT40	Rear Face Close	134	10.0	9.67	0.02	0.063	1.08	0.07
	802.11n	HT40	Rear Face Open	134	10.0	9.67	0.01	0.011	1.08	0.01
	802.11n	HT40	Right Side	134	10.0	9.67	0.16	0.557	1.08	0.60
	802.11n	HT40	Top Side	134	10.0	9.67	0.04	0.169	1.08	0.18
	802.11n	HT40	Bottom Side	134	10.0	9.67	0.02	0.023	1.08	0.02
12	802.11n	HT20	Front Face	149	10.0	9.68	-0.03	0.709	1.08	0.76
	802.11n	HT20	Rear Face Close	149	10.0	9.68	0.05	0.06	1.08	0.06
	802.11n	HT20	Rear Face Open	149	10.0	9.68	0.04	0.015	1.08	0.02
	802.11n	HT20	Right Side	149	10.0	9.68	0.00	0.703	1.08	0.76
	802.11n	HT20	Top Side	149	10.0	9.68	0.01	0.16	1.08	0.17
	802.11n	HT20	Bottom Side	149	10.0	9.68	0.04	0.022	1.08	0.02

Nico

Plot No.	Band	Mode	Test Position	Ch.	Max. Tune-up Power (dBm)	Measured Conducted Power (dBm)	Power Drift (dB)	Measured SAR-1g (W/kg)	Scaling Factor	Scaled SAR-1g (W/kg)
13	802.11b	-	Front Face	1	13.0	12.65	-0.08	0.634	1.08	0.69
	802.11b	-	Rear Face Close	1	13.0	12.65	0.04	0.235	1.08	0.25
	802.11b	-	Rear Face Open	1	13.0	12.65	0.01	0.107	1.08	0.12
	802.11b	-	Right Side	1	13.0	12.65	-0.04	0.497	1.08	0.54
	802.11b	-	Top Side	1	13.0	12.65	0.02	0.108	1.08	0.12
	802.11b	-	Bottom Side	1	13.0	12.65	0.11	0.017	1.08	0.02
14	802.11n	HT40	Front Face	38	10.0	9.50	-0.08	0.702	1.12	0.79
	802.11n	HT40	Rear Face Close	38	10.0	9.50	-0.15	0.09	1.12	0.10
	802.11n	HT40	Rear Face Open	38	10.0	9.50	0.03	0.019	1.12	0.02
	802.11n	HT40	Right Side	38	10.0	9.50	0.08	0.887	1.12	1.00
	802.11n	HT40	Top Side	38	10.0	9.50	-0.07	0.102	1.12	0.11
	802.11n	HT40	Bottom Side	38	10.0	9.50	0.06	0.041	1.12	0.05
	802.11n	HT40	Right Side	46	10.0	9.32	0.00	0.837	1.17	0.98
802.11n	HT40	Right Side	38	10.0	9.50	0.07	0.879	1.12	0.99	
15	802.11n	HT40	Front Face	134	10.0	9.67	0.00	0.646	1.08	0.70
	802.11n	HT40	Rear Face Close	134	10.0	9.67	-0.15	0.118	1.08	0.13
	802.11n	HT40	Rear Face Open	134	10.0	9.67	-0.01	0.021	1.08	0.02
	802.11n	HT40	Right Side	134	10.0	9.67	0.08	1.05	1.08	1.13
	802.11n	HT40	Top Side	134	10.0	9.67	0.06	0.133	1.08	0.14
	802.11n	HT40	Bottom Side	134	10.0	9.67	0.07	0.054	1.08	0.06
	802.11n	HT40	Right Side	110	10.0	9.18	0.09	0.82	1.21	0.99
802.11n	HT40	Right Side	134	10.0	9.67	0.03	1.01	1.08	1.09	
16	802.11n	HT20	Front Face	149	10.0	9.68	0.01	0.714	1.08	0.77
	802.11n	HT20	Rear Face Close	149	10.0	9.68	-0.15	0.111	1.08	0.12
	802.11n	HT20	Rear Face Open	149	10.0	9.68	0.01	0.025	1.08	0.03
	802.11n	HT20	Right Side	149	10.0	9.68	0.06	0.985	1.08	1.06
	802.11n	HT20	Top Side	149	10.0	9.68	-0.05	0.126	1.08	0.14
	802.11n	HT20	Bottom Side	149	10.0	9.68	0.03	0.051	1.08	0.05
	802.11n	HT20	Right Side	157	10.0	8.85	0.09	0.806	1.30	1.05
802.11n	HT20	Right Side	149	10.0	9.68	0.03	0.978	1.08	1.05	

4.6 SAR Measurement Variability

4.6.1 Repeated Measurement

According to KDB 865664 D01, SAR measurement variability was assessed for each frequency band, which is determined by the SAR probe calibration point and tissue-equivalent medium used for the device measurements. When both head and body tissue-equivalent media are required for SAR measurements in a frequency band, the variability measurement procedures should be applied to the tissue medium with the highest measured SAR, using the highest measured SAR configuration for that tissue-equivalent medium. Alternatively, if the highest measured SAR for both head and body tissue-equivalent media are ≤ 1.45 W/kg and the ratio of these highest SAR values, i.e., largest divided by smallest value, is ≤ 1.10 , the highest SAR configuration for either head or body tissue-equivalent medium may be used to perform the repeated measurement. These additional measurements are repeated after the completion of all measurements requiring the same head or body tissue-equivalent medium in a frequency band. The test device should be returned to ambient conditions (normal room temperature) with the battery fully charged before it is re-mounted on the device holder for the repeated measurement(s) to minimize any unexpected variations in the repeated results.

SAR repeated measurement procedure:

1. When the highest measured SAR is < 0.80 W/kg, repeated measurement is not required.
2. When the highest measured SAR is ≥ 0.80 W/kg, repeat that measurement once.
3. If the ratio of largest to smallest SAR for the original and first repeated measurements is > 1.20 , or when the original or repeated measurement is ≥ 1.45 W/kg, perform a second repeated measurement.
4. If the ratio of largest to smallest SAR for the original, first and second repeated measurements is > 1.20 , and the original, first or second repeated measurement is ≥ 1.5 W/kg, perform a third repeated measurement.

Veronica

Band	Mode	Test Position	Ch.	Original Measured SAR-1g (W/kg)	1st Repeated SAR-1g (W/kg)	L/S Ratio	2nd Repeated SAR-1g (W/kg)	L/S Ratio	3rd Repeated SAR-1g (W/kg)	L/S Ratio
Head Exposure Condition										
802.11b	-	Right Side	1	0.864	0.858	1.01	N/A	N/A	N/A	N/A
802.11n	HT40	Right Side	134	1.08	1.01	1.07	N/A	N/A	N/A	N/A
802.11n	HT20	Front Face	149	1.02	0.989	1.03	N/A	N/A	N/A	N/A
Body Exposure Condition										
802.11b	-	Right Side	1	0.836	0.829	1.01	N/A	N/A	N/A	N/A

Nico

Band	Mode	Test Position	Ch.	Original Measured SAR-1g (W/kg)	1st Repeated SAR-1g (W/kg)	L/S Ratio	2nd Repeated SAR-1g (W/kg)	L/S Ratio	3rd Repeated SAR-1g (W/kg)	L/S Ratio
Head Exposure Condition										
802.11b	-	Front Face	1	0.923	0.918	1.01	N/A	N/A	N/A	N/A
802.11n	HT40	Front Face	134	1.06	1.01	1.05	N/A	N/A	N/A	N/A
802.11n	HT20	Front Face	149	0.978	0.967	1.01	N/A	N/A	N/A	N/A
Body Exposure Condition										
802.11n	HT40	Right Side	38	0.887	0.879	1.01	N/A	N/A	N/A	N/A
802.11n	HT40	Right Side	134	1.05	1.01	1.04	N/A	N/A	N/A	N/A
802.11n	HT20	Right Side	149	0.985	0.978	1.01	N/A	N/A	N/A	N/A

Shenzhen UnionTrust Quality and Technology Co., Ltd.

4.6.2 DUT Holder Perturbations

Depending on antenna locations, buttons locations on phones or device, form factor (e.g. dongles etc.), the measured SAR could be influenced by the relative positions of the test device and its holder.

When the highest reported SAR of an antenna is > 1.2 W/kg, holder perturbation verification is required, using the highest SAR configuration among all applicable frequency bands with and without the device holder.

All the measured SAR are less than 1.2 W/kg, so the holder perturbation verification is not required.

*** End of Report ***

The test report is effective only with both signature and specialized stamp. The result(s) shown in this report refer only to the sample(s) tested. Without written approval of UnionTrust, this report can't be reproduced except in full.



Appendix A. SAR Plots of System Verification

The plots for system verification with largest deviation for each SAR system combination are shown as follows.



Appendix B. SAR Plots of SAR Measurement

The SAR plots for highest measured SAR in each exposure configuration, wireless mode and frequency band combination, and measured SAR > 1.5 W/kg are shown as follows.



Appendix C. Calibration Certificate for Probe and Dipole

The calibration certificates are shown as follows.



Appendix D. Photographs of EUT and Setup

