

FCC&ISED RF TEST REPORT
No. 171200800SHA-001

Applicant : Snap Inc.
63 Market Street, Venice, CA 90291, USA

Product Name : Wearable video camera

Type/Model : 002

TEST RESULT : PASS

SUMMARY

The equipment complies with the requirements according to the following standard(s) or specification:

47CFR Part 15 (2016): Radio Frequency Devices (Subpart C)

ANSI C63.10 (2013): American National Standard of Procedures for Compliance Testing of Unlicensed Wireless Devices

RSS-247 Issue 2 (February 2017): Digital Transmission Systems (DTSS), Frequency Hopping Systems (FHSs) and Licence-Exempt Local Area Network (LE-LAN) Devices

RSS-Gen Issue 4 (November 2014): General Requirements for Compliance of Radio Apparatus

Date of issue: March 2, 2018

Prepared by:



Wade Zhang (Project engineer)

Reviewed by:

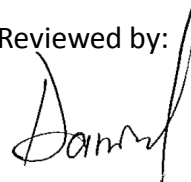

Daniel Zhao (Reviewer)

Content

SUMMARY	1
REVISION HISTORY	3
1 GENERAL INFORMATION	4
1.1 IDENTIFICATION OF THE EUT	4
1.2 TECHNICAL SPECIFICATION	4
1.3 DESCRIPTION OF TEST FACILITY	5
2 TEST SPECIFICATIONS	6
2.1 STANDARDS OR SPECIFICATION	6
2.2 MODE OF OPERATION DURING THE TEST.....	6
2.3 TEST SOFTWARE LIST	7
2.4 TEST PERIPHERALS LIST	7
2.5 INSTRUMENT LIST	8
2.6 TEST SUMMARY	9
2.7 MEASUREMENT UNCERTAINTY	10
3 MINIMUM 6DB BANDWIDTH	11
3.1 LIMIT	11
3.2 TEST CONFIGURATION	11
3.3 TEST PROCEDURE AND TEST SETUP	11
3.4 TEST PROTOCOL	12
4 MAXIMUM CONDUCTED OUTPUT POWER	14
4.1 TEST LIMIT	14
4.2 TEST CONFIGURATION	14
4.3 TEST PROCEDURE AND TEST SETUP	14
4.4 TEST PROTOCOL	15
5 POWER SPECTRUM DENSITY	17
5.1 TEST LIMIT	17
5.2 TEST CONFIGURATION	17
5.3 TEST PROCEDURE AND TEST SETUP	18
5.4 TEST PROTOCOL	19
6 EMISSION OUTSIDE THE FREQUENCY BAND	21
6.1 TEST LIMIT	21
6.2 TEST CONFIGURATION	21
6.3 TEST PROCEDURE AND TEST SETUP	22
6.4 TEST PROTOCOL	23
7 RADIATED EMISSIONS	30
7.1 TEST LIMIT	30
7.2 TEST CONFIGURATION	30
7.3 TEST PROCEDURE AND TEST SETUP	31
7.4 TEST PROTOCOL	32
8 POWER LINE CONDUCTED EMISSION	35
8.1 LIMIT	35
8.2 TEST CONFIGURATION	35
8.3 TEST PROCEDURE AND TEST SET UP	36
8.4 TEST PROTOCOL	37

Revision History

Issue No.	Version	Description	Date Issued
171200800SHA-001	Rev. 01	Initial issue of report	March 2, 2018

1 GENERAL INFORMATION

1.1 Identification of the EUT

Product Name : Wearable video camera
Type/model : 002
FCC ID : 2AIRN-002
IC : 22922-002

1.2 Technical Specification

Operation Frequency : 2402-2480MHz
Band
Type of Modulation : GFSK
EUT Modes of Modulation : Bluetooth 4.2 (BLE)
Transfer Rate : 1Mbps
Power Class : Class II
Channel Number : 40 (0-39)
Description of EUT : The EUT is a wearable video camera which support WIFI and Bluetooth 4.2 technology, there have only one mode, we tested it and listed the BLE result in this report.
Antenna : Internal Monopole antenna, 4.2dBi Peak gain
Rating : DC 5V
Category of EUT : Class B
EUT type : Table top
 Floor standing
Sample received date : December 12, 2017
Date of test : December 12, 2017 ~ January 10, 2018

Antenna Requirement: An intentional radiator shall be designed to ensure that no antenna other than that furnished by the responsible party shall be used with the device. The use of a permanently attached antenna or of an antenna that uses a unique coupling to the intentional radiator shall be considered sufficient to comply with the provisions of this section. The manufacturer may design the unit so that a broken antenna can be replaced by the user, but the use of a standard antenna jack or electrical connector is prohibited.

The EUT used an internal monopole antenna and used a no-standard electrical connector, so fulfill these requirements.

1.3 Description of Test Facility

Name : Intertek Testing Services Shanghai
Address : Building 86, No. 1198 Qinzhou Road(North), Shanghai 200233, P.R.
China
Telephone : 86 21 61278200
Telefax : 86 21 54262353

The test facility is : CNAS Accreditation Lab
recognized, certified, or
accredited by these Registration No. CNAS L0139
organizations FCC Accredited Lab
Designation Number: CN1175
IC Registration Lab
Registration code No.: 2042B-1
VCCI Registration Lab
Registration No.: R-4243, G-845, C-4723, T-2252
NVLAP Accreditation Lab
NVLAP LAB CODE: 200849-0
A2LA Accreditation Lab
Certificate Number: 3309.02

2 TEST SPECIFICATIONS

2.1 Standards or specification

47CFR Part 15 (2016)
ANSI C63.10 (2013)
RSS-247 Issue 2 (February 2017)
RSS-Gen Issue 4 (November 2014)
KDB 558074 (v04)

2.2 Mode of operation during the test

While testing transmitting mode of EUT, the internal modulation and continuously transmission was applied.

The lowest, middle and highest channel were tested as representatives.

Frequency Band (MHz)				2402 ~ 2480			
Channel	Frequency (MHz)	Channel	Frequency (MHz)	Channel	Frequency (MHz)	Channel	Frequency (MHz)
0	2402	10	2422	20	2442	30	2462
1	2404	11	2424	21	2444	31	2464
2	2406	12	2426	22	2446	32	2466
3	2408	13	2428	23	2448	33	2468
4	2410	14	2430	24	2450	34	2470
5	2412	15	2432	25	2452	35	2472
6	2414	16	2434	26	2454	36	2474
7	2416	17	2436	27	2456	37	2476
8	2418	18	2438	28	2458	38	2478
9	2420	19	2440	29	2460	39	2480

Data rate VS Power:

The test setting software is offered by the manufactory. The pre-scan for the conducted power with all rates in each modulation and bands was used, and the worst case was found and used in all test cases.

Test software and Power Setting parameter			
Test Software	Command		
Working Mode	BLE		
Test Channel	2402MHz	2440MHz	2480MHz
Power Setting	8000	9300	A700

There have the following test modes:

Radiated test mode:

Mode 1: EUT transmitted signal with internal antenna;

Conducted test mode:

Mode 2: EUT transmitted signal from PCBA RF port connected to SPA directly;

We have verified all test modes, and choose the mode 1 for radiated RF test and mode 2 for conducted RF test as representatively to list the results in this report.

2.3 Test software list

Test Items	Software	Manufacturer	Version
Conducted emission	ESxS-K1	R&S	V2.1.0
Radiated emission	ES-K1	R&S	V1.71

2.4 Test peripherals list

Item No.	Name	Band and Model	Description
1	Laptop computer	HP ProBook 6470b	100-240V AC, 50/60Hz FCC DOC
2	AC-DC adaptor	KA25	100-240VAC, DC5V1A FCC VOC
3	RF Board	NA	NA

2.5 Instrument list

Conducted Emission					
Used	Equipment	Manufacturer	Type	Internal no.	Due date
<input checked="" type="checkbox"/>	Test Receiver	R&S	ESCS 30	EC 2107	2018-10-18
<input checked="" type="checkbox"/>	A.M.N.	R&S	ESH2-Z5	EC 3119	2018-12-01
<input checked="" type="checkbox"/>	Shielded room	Zhongyu	-	EC 2838	2019-01-08
Radiated Emission					
Used	Equipment	Manufacturer	Type	Internal no.	Due date
<input checked="" type="checkbox"/>	Test Receiver	R&S	ESIB 26	EC 3045	2018-10-18
<input checked="" type="checkbox"/>	Bilog Antenna	TESEQ	CBL 6112D	EC 4206	2018-05-30
<input checked="" type="checkbox"/>	Horn antenna	R&S	HF 906	EC 3049	2018-09-22
<input checked="" type="checkbox"/>	Horn antenna	ETS	3117	EC 4792-1	2018-08-23
<input checked="" type="checkbox"/>	Horn antenna	TOYO	HAP18-26W	EC 4792-3	2020-07-09
<input checked="" type="checkbox"/>	Pre-amplifier	R&S	Pre-amp 18	EC5881	2018-06-19
<input checked="" type="checkbox"/>	Semi-anechoic chamber	Albatross project	-	EC 3048	2018-09-08
RF test					
Used	Equipment	Manufacturer	Type	Internal no.	Due date
<input checked="" type="checkbox"/>	PXA Signal Analyzer	Keysight	N9030A	EC 5338	2018-09-10
<input checked="" type="checkbox"/>	Power sensor	Agilent	U2021XA	EC 5338-1	2018-03-03
<input checked="" type="checkbox"/>	Vector Signal Generator	Agilent	N5182B	EC 5175	2018-03-06
<input checked="" type="checkbox"/>	MXG Analog Signal Generator	Agilent	N5181A	EC 5338-2	2018-03-03
<input checked="" type="checkbox"/>	Test Receiver	R&S	ESCI 7	EC 4501	2018-02-23
Additional instrument					
Used	Equipment	Manufacturer	Type	Internal no.	Due date
<input checked="" type="checkbox"/>	Therom-Hygrograph	ZJ1-2A	S.M.I.F.	EC 3323	2018-06-14
<input checked="" type="checkbox"/>	Therom-Hygrograph	ZJ1-2A	S.M.I.F.	EC 3324	2018-04-09
<input checked="" type="checkbox"/>	Therom-Hygrograph	ZJ1-2A	S.M.I.F.	EC 3325	2018-03-23
<input checked="" type="checkbox"/>	Pressure meter	YM3	Shanghai Mengde	EC 3320	2018-06-28

2.6 Test Summary

This report applies to tested sample only. The test results have been compared directly with the limits, and the measurement uncertainty is recorded. This report shall not be reproduced in part without written approval of Intertek Testing Service Shanghai Limited.

TEST ITEM	FCC REFERANCE	IC REFERANCE	RESULT
Minimum 6dB Bandwidth & Occupied bandwidth	15.247(a)(2)	RSS-247 Issue 2 Clause 5.2	Pass
Maximum peak output power	15.247(b)	RSS-247 Issue 2 Clause 5.4	Pass
Power spectrum density	15.247(e)	RSS-247 Issue 2 Clause 5.2	Pass
Radiated emission	15.205 & 15.209	RSS-247 Issue 2 Clause 5.5	Pass
Emission outside the frequency band	15.247(d)	RSS-Gen Issue 4 Clause 8.9	Pass
Power line conducted emission	15.207	RSS-Gen Issue 4 Clause 8.8	Pass
Occupied bandwidth	-	RSS-Gen Issue 4 Clause 6.6	Tested

Notes: 1: NA =Not Applicable

2: This report is for the exclusive use of Intertek's Client and is provided pursuant to the agreement between Intertek and its Client. Intertek's responsibility and liability are limited to the terms and conditions of the agreement. Intertek assumes no liability to any party, other than to the Client in accordance with the agreement, for any loss, expense or damage occasioned by the use of this report. Only the Client is authorized to permit copying or distribution of this report and then only in its entirety. Any use of the Intertek name or one of its marks for the sale or advertisement of the tested material, product or service must first be approved in writing by Intertek. The observations and test results in this report are relevant only to the sample tested. This report by itself does not imply that the material, product, or service is or has ever been under an Intertek certification program.

2.7 Measurement uncertainty

The measurement uncertainty represents an expanded uncertainty expressed at approximately the 95% confidence level using a coverage factor of k=2.

Test item	Measurement uncertainty
Maximum peak output power	± 0.74dB
Radiated Emissions in restricted frequency bands below 1GHz	± 4.90dB
Radiated Emissions in restricted frequency bands above 1GHz	± 5.02dB
Emission outside the frequency band	± 2.89dB
Power line conducted emission	± 3.19dB

3 Minimum 6dB Bandwidth

Test result: Pass

3.1 Limit

For systems using digital modulation techniques that may operate in the 902 - 928 MHz, 2400 - 2483.5 MHz and 5725 - 5850 MHz bands, the minimum 6 dB bandwidth shall be at least 500 kHz.

3.2 Test Configuration

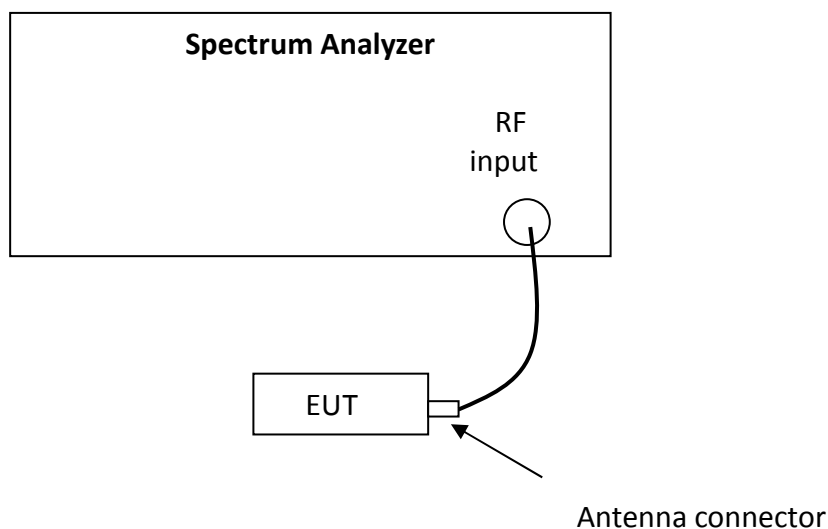

3.3 Test Procedure and test setup

The minimum 6dB bandwidth per FCC §15.247(a)(2) is measured using the Spectrum Analyzer according to DTS test procedure of "KDB558074 D01 DTS Meas Guidance" for compliance to FCC 47CFR 15.247 requirements (clause 8.2).

- a) Set RBW = 100 kHz.
- b) Set the video bandwidth (VBW) $\geq 3 \times$ RBW.
- c) Detector = Peak.
- d) Trace mode = max hold.
- e) Sweep = auto couple.
- f) Allow the trace to stabilize.
- g) Measure the maximum width of the emission that is constrained by the frequencies associated with the two outermost amplitude points (upper and lower frequencies) that are attenuated by 6 dB relative to the maximum level measured in the fundamental emission.

3.4 Test Protocol

Temperature: 25 °C
Relative Humidity: 55 %

Modulation	Frequency (MHz)	Minimum 6dB Bandwidth (KHz)	Limits (KHz)
BLE	2402	561.9	> 500
	2440	563.1	> 500
	2480	563.0	> 500

Modulation	Frequency (MHz)	99% Occupied Bandwidth (MHz)
BLE	2402	1.0856
	2440	1.0895
	2480	1.0925

Test Plots:

Channel L

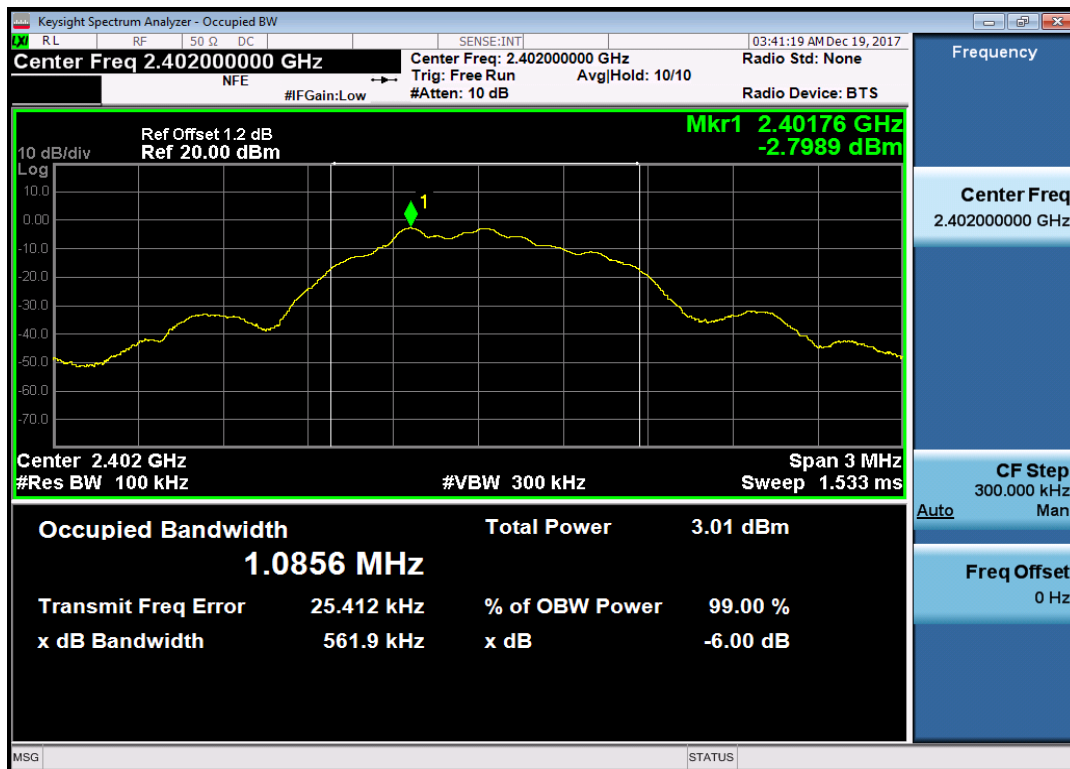

Channel M

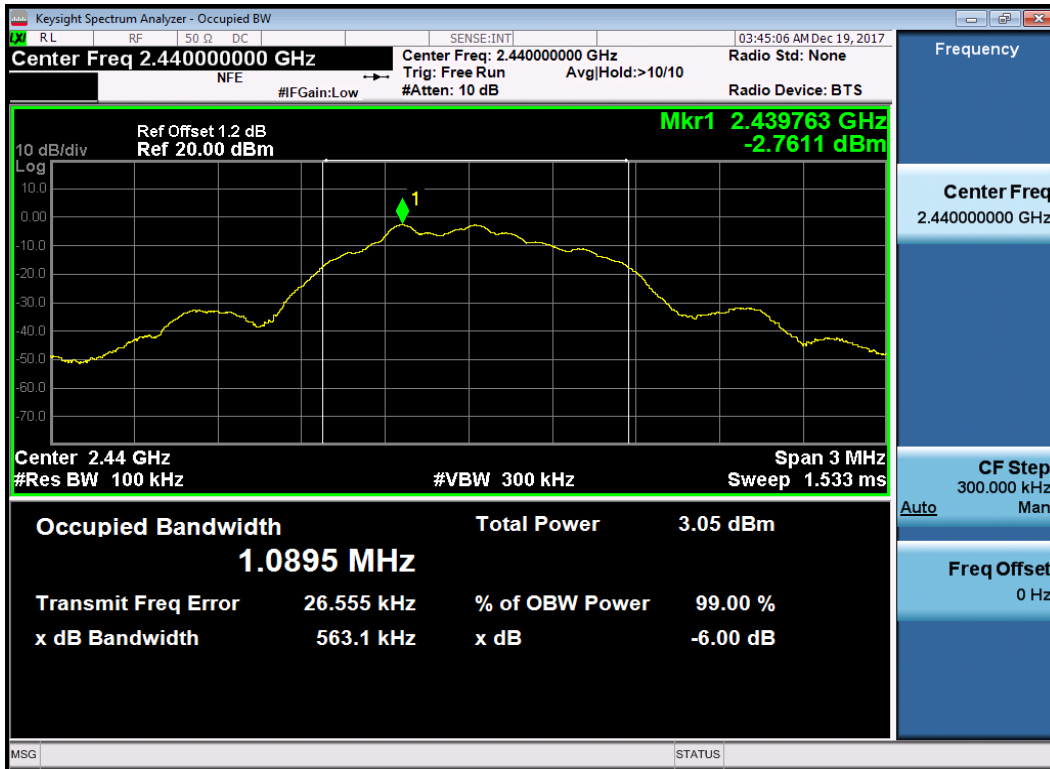

Channel H

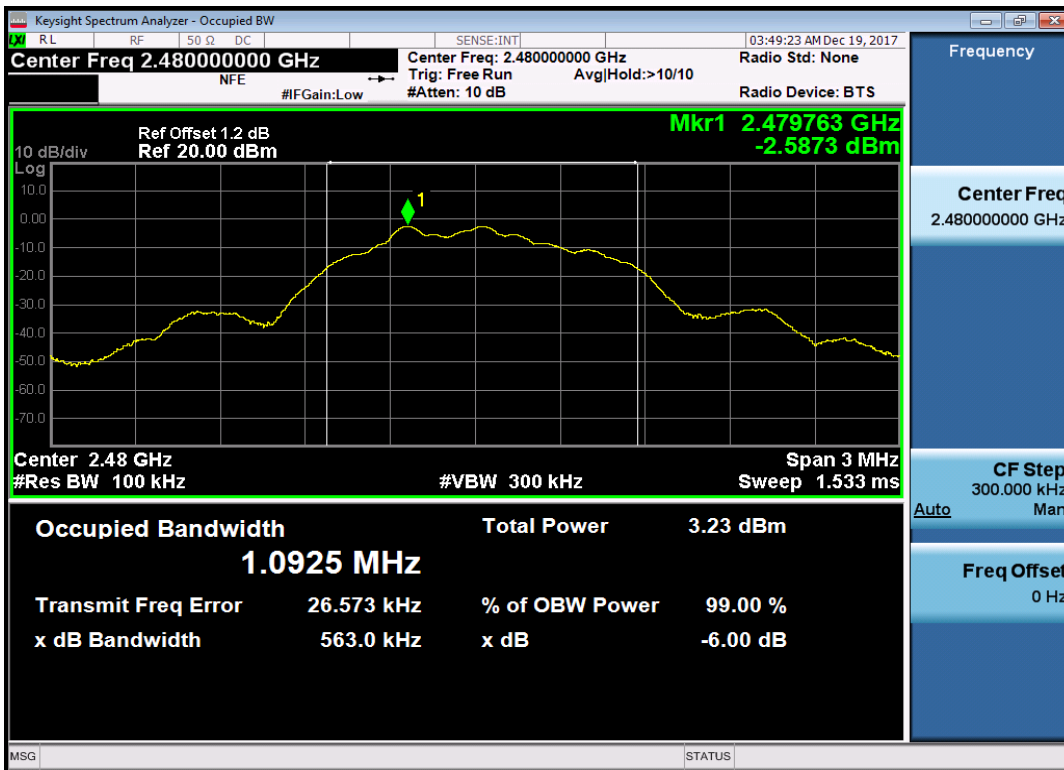

4 Maximum Conducted Output power

Test result: Pass

4.1 Test limit

- For frequency hopping systems operating in the 2400-2483.5 MHz band employing at least 75 non-overlapping hopping channels, and all frequency hopping systems in the 5725-5850 MHz band: 1 watt
- For all other frequency hopping systems in the 2400-2483.5 MHz band: 0.125 watts
- For systems using digital modulation in the 902-928 MHz, 2400-2483.5 MHz, and 5725-5850 MHz bands: 1 Watt and the e.i.r.p. shall not exceed 4 W.

4.2 Test Configuration

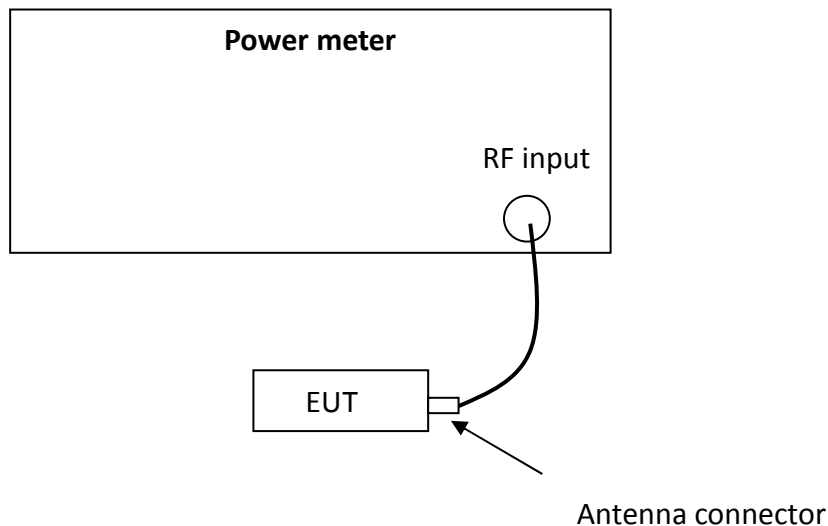

4.3 Test procedure and test setup

- a) Set the RBW \geq DTS bandwidth.
- b) Set VBW $\geq 3 \times$ RBW.
- c) Set span $\geq 3 \times$ RBW
- d) Sweep time = auto couple.
- e) Detector = peak.
- f) Trace mode = max hold.
- g) Allow trace to fully stabilize.
- h) Use peak marker function to determine the peak amplitude level.

4.4 Test protocol

Temperature: 25 °C
Relative Humidity: 55 %

Modulation	Frequency (MHz)	MaxConducted Power (dBm)	Limit (dBm)
BLE	2402	-2.659	30
	2440	-2.549	30
	2480	-2.417	30

Conclusion: The maximum EIRP = $-2.417\text{dBm} + 4.2\text{dBi} = 1.783\text{dBm} = 0.002\text{W}$ which is lower than the limit of 4W listed in RSS-247.

Test Plots:

Channel L

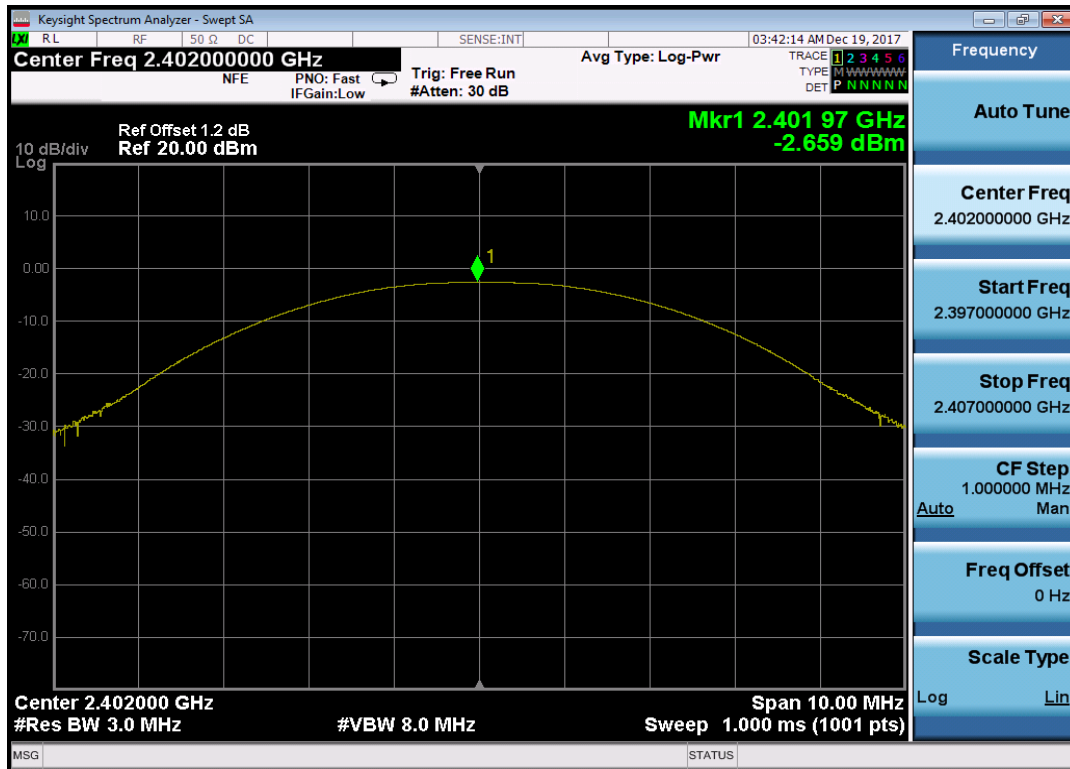

Channel M



Channel H

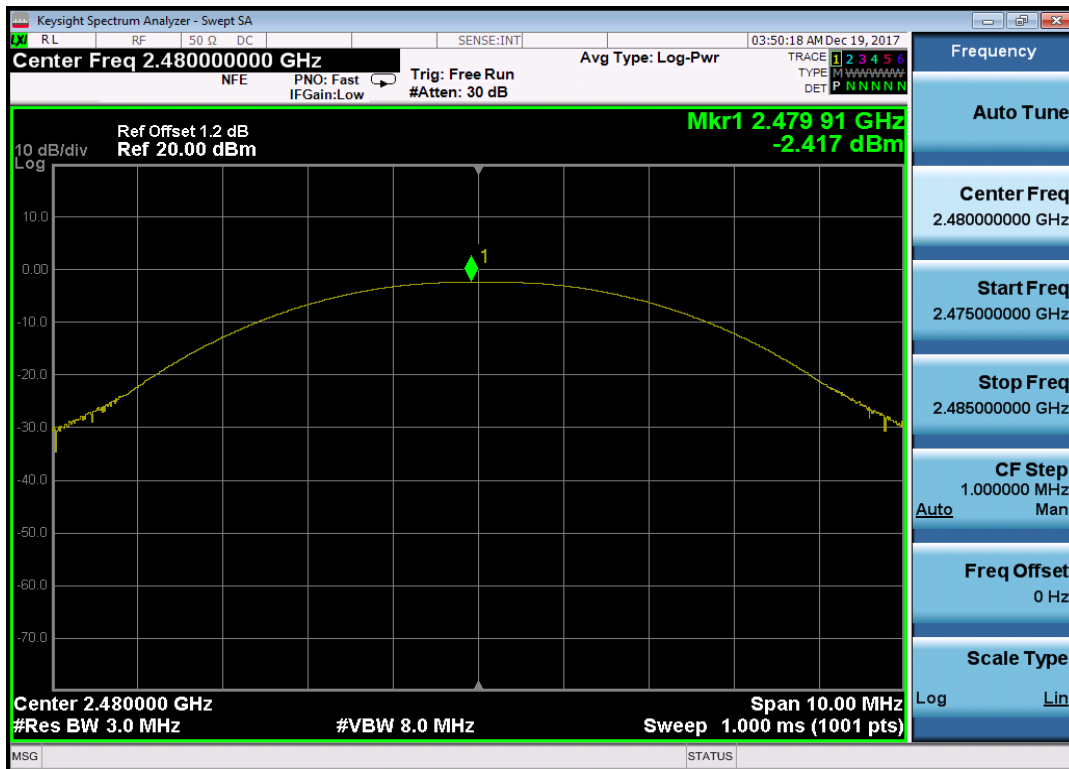

5 Power spectrum density

Test result:Pass

5.1 Test limit

For digitally modulated systems, the power spectral density conducted from the intentional radiator to the antenna shall not be greater than 8dBm in any 3kHz band during any time interval of continuous transmission.

If the transmitting antenna of directional gain greater than 6dBi is used, the power shall be reduced by the amount in dB that the directional gain of the antenna exceeds 6dBi. If there have a beam forming type, the limit should be the minimum of 8dBm/3kHz and $8 + (6 - \text{antenna gain} - \text{beam forming gain})$.

5.2 Test Configuration

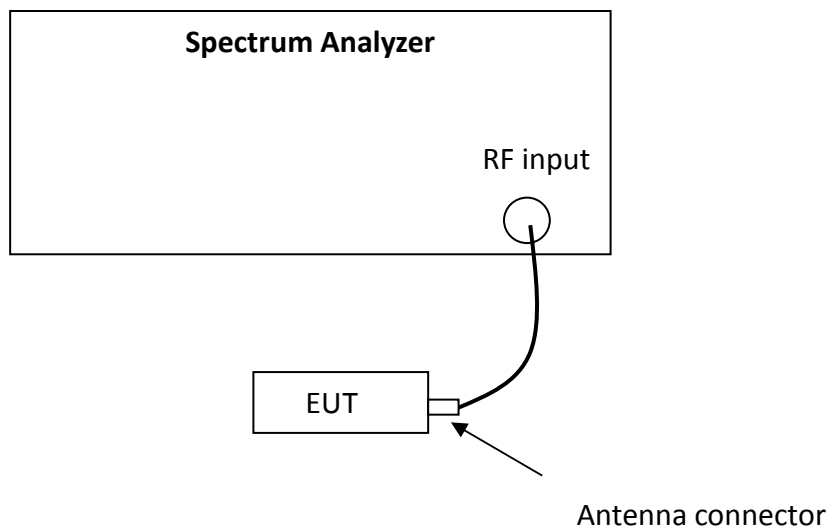

5.3 Test procedure and test setup

- a) Set analyzer center frequency to DTS channel center frequency.
- b) Set the span to 1.5 times the DTS bandwidth.
- c) Set the RBW to: $3 \text{ kHz} \leq \text{RBW} \leq 100 \text{ kHz}$.
- d) Set the VBW $\geq 3 \times \text{RBW}$.
- e) Detector = peak.
- f) Sweep time = auto couple.
- g) Trace mode = max hold.
- h) Allow trace to fully stabilize.
- i) Use the peak marker function to determine the maximum amplitude level within the RBW.
- j) If measured value exceeds limit, reduce RBW (no less than 3 kHz) and repeat.

5.4 Test Protocol

Temperature: 25 °C
Relative Humidity: 55 %

Modulation	Frequency (MHz)	Maximum Power spectrum density (dBm/3KHz)	Limit (dBm/3KHz)
BLE	2402	-19.476	8
	2440	-19.352	8
	2480	-19.190	8

Test Plots:

Channel L

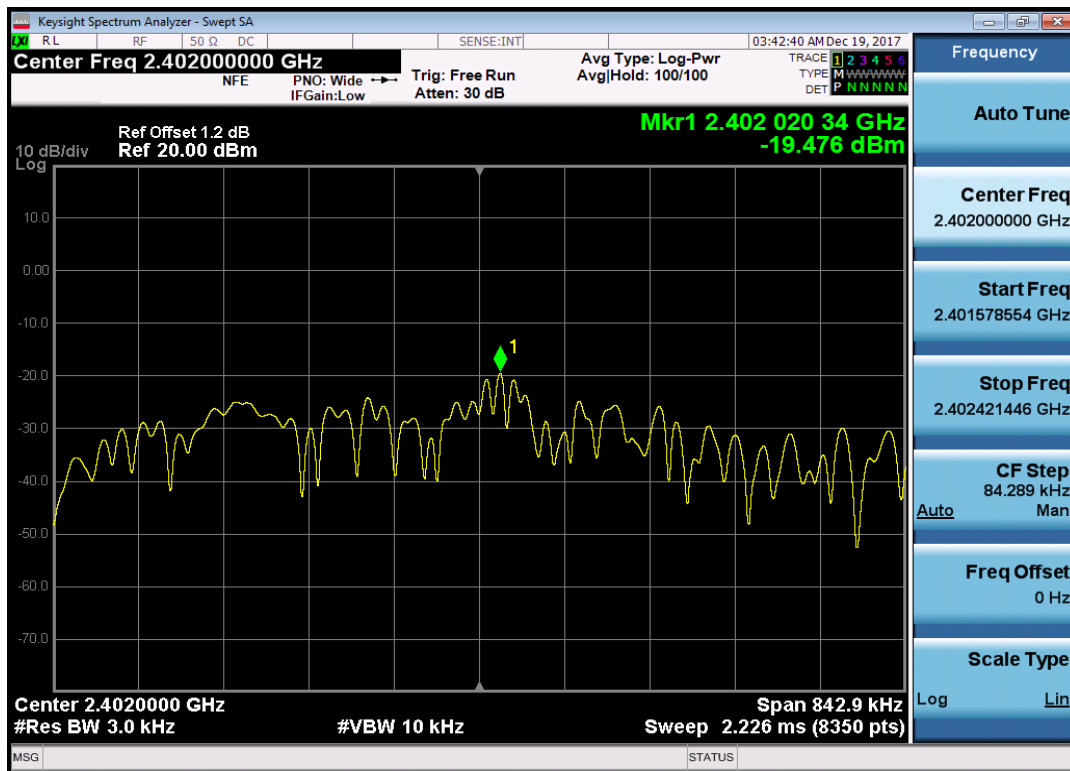

Channel M

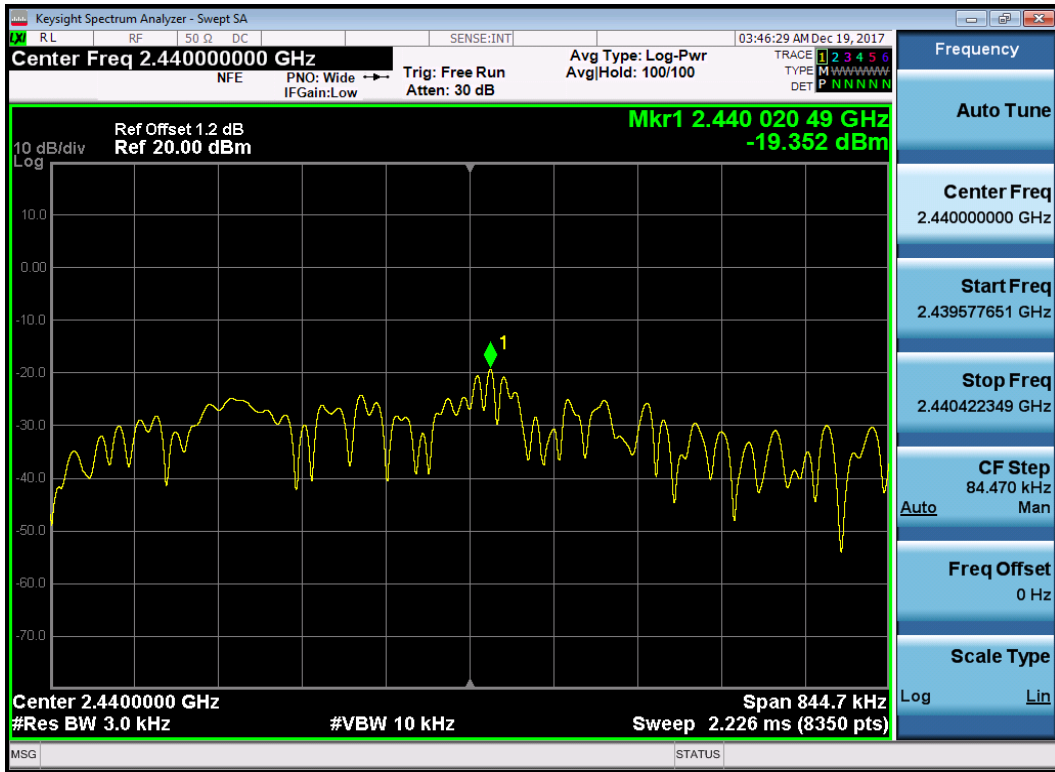

Channel H

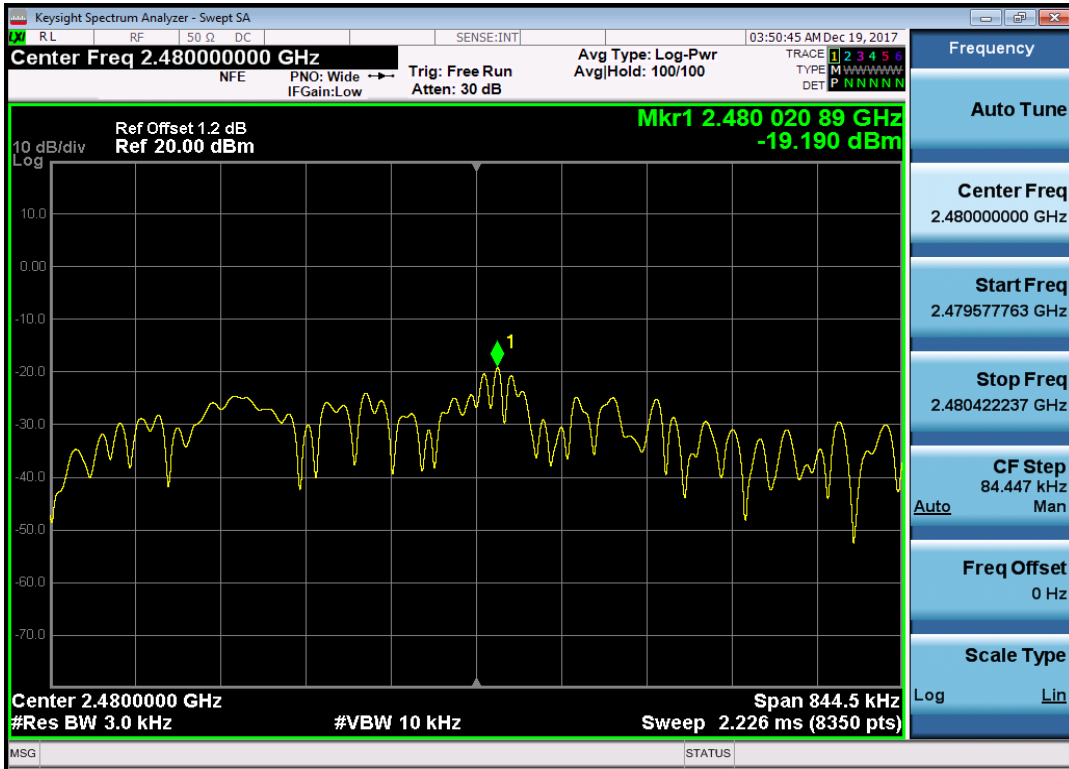

6 Emission outside the frequency band

Test result: Pass

6.1 Test limit

In any 100kHz bandwidth outside the frequency band in which the spread spectrum intentional radiator is operating, the radio frequency power that is produced by the intentional radiator shall be at least 20dB below that in the 100kHz bandwidth within the band that contains the highest level of the desired power.

6.2 Test Configuration

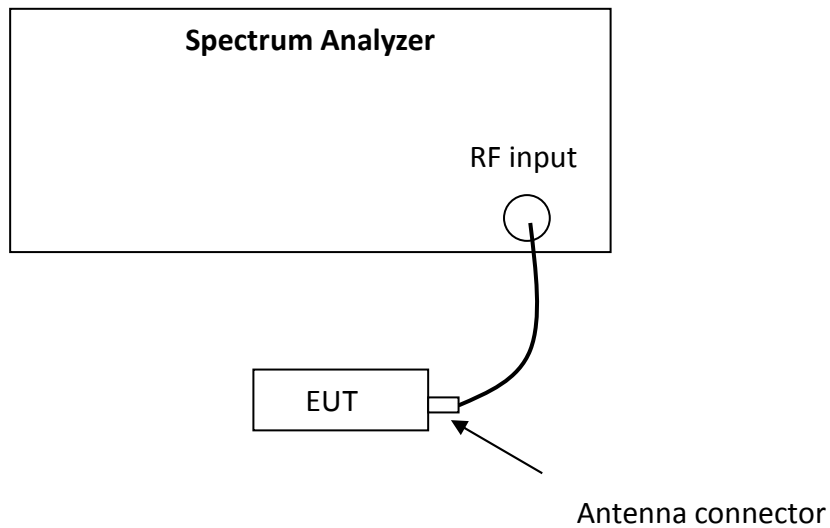

6.3 Test procedure and test setup

The EUT was tested according to DTS test procedure of “KDB558074 D01 DTS Meas Guidance” (clause 11.0) for compliance to FCC 47CFR 15.247 requirements.

Reference level measurement

Establish a reference level by using the following procedure:

- a) Set instrument center frequency to DTS channel center frequency.
- b) Set the span to ≥ 1.5 times the *DTS bandwidth*.
- c) Set the RBW = 100 kHz.
- d) Set the VBW $\geq 3 \times$ RBW.
- e) Detector = peak.
- f) Sweep time = auto couple.
- g) Trace mode = max hold.
- h) Allow trace to fully stabilize.
- i) Use the peak marker function to determine the maximum PSD level.

Note that the channel found to contain the maximum PSD level can be used to establish the reference level.

Emission level measurement

- a) Set the center frequency and span to encompass frequency range to be measured.
- b) Set the RBW = 100 kHz.
- c) Set the VBW $\geq 3 \times$ RBW.
- d) Detector = peak.
- e) Sweep time = auto couple.
- f) Trace mode = max hold.
- g) Allow trace to fully stabilize.
- h) Use the peak marker function to determine the maximum amplitude level.

Ensure that the amplitude of all unwanted emissions outside of the authorized frequency band (excluding restricted frequency bands) are attenuated by at least the minimum requirements specified in 11.1 a) or 11.1 b). Report the three highest emissions relative to the limit.

6.4 Test Protocol

Temperature: 25 °C
Relative Humidity: 55 %

Channel L

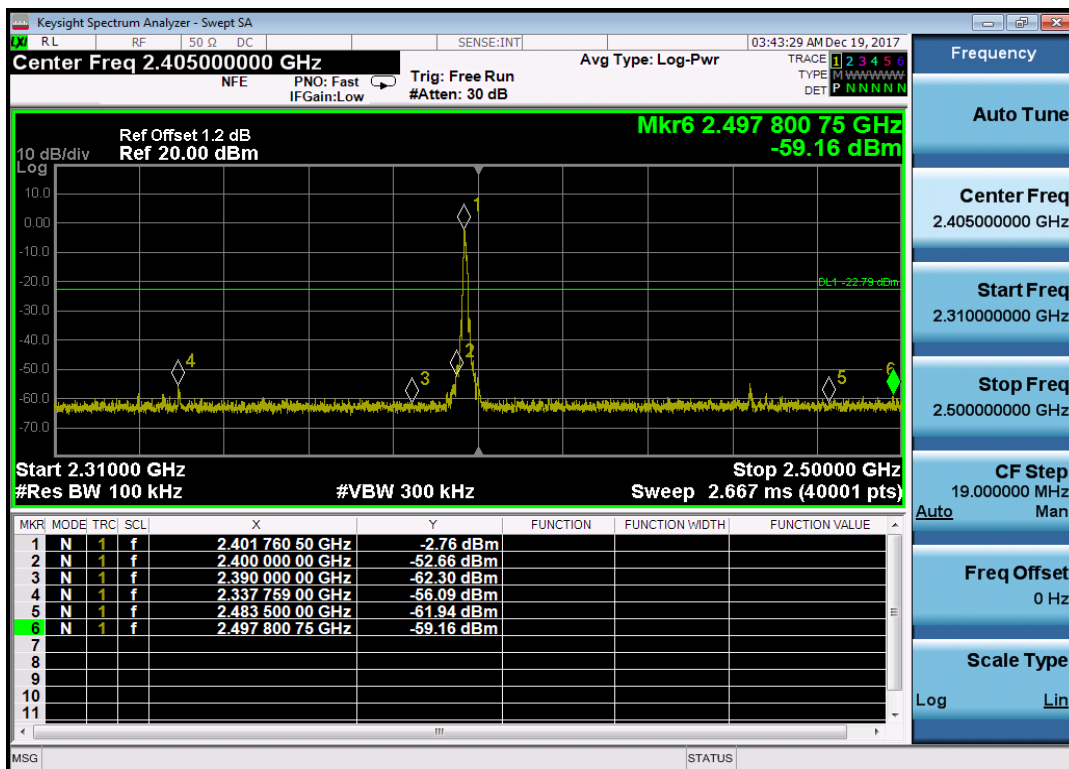
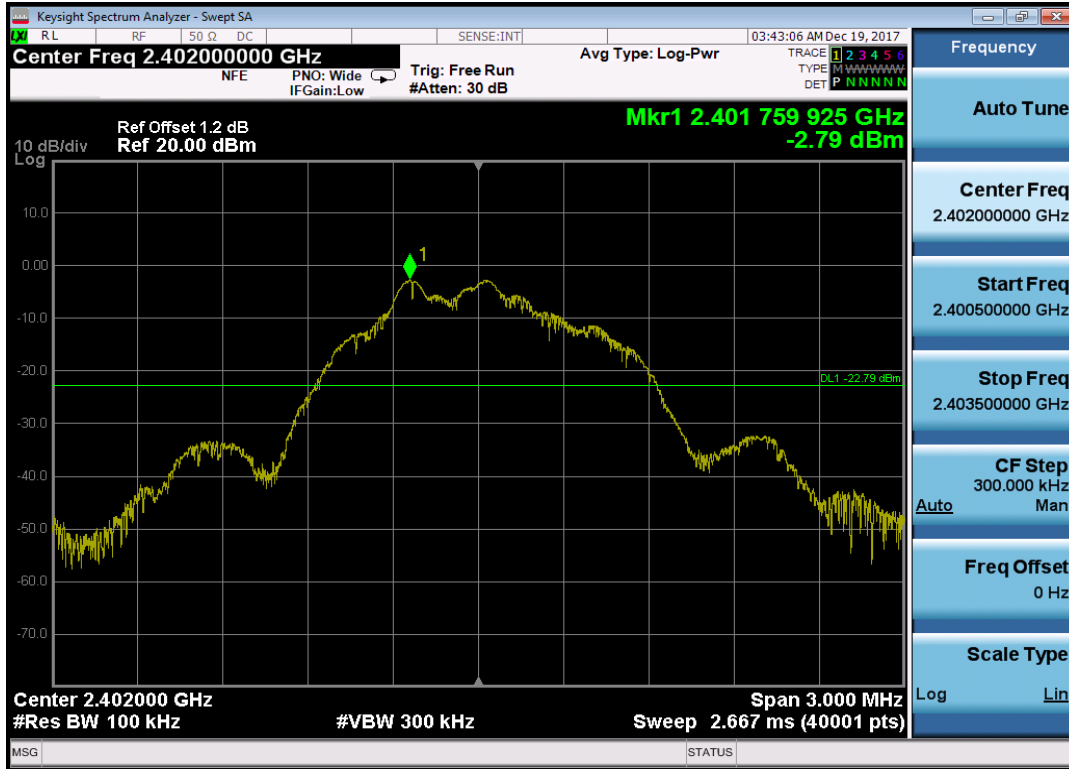

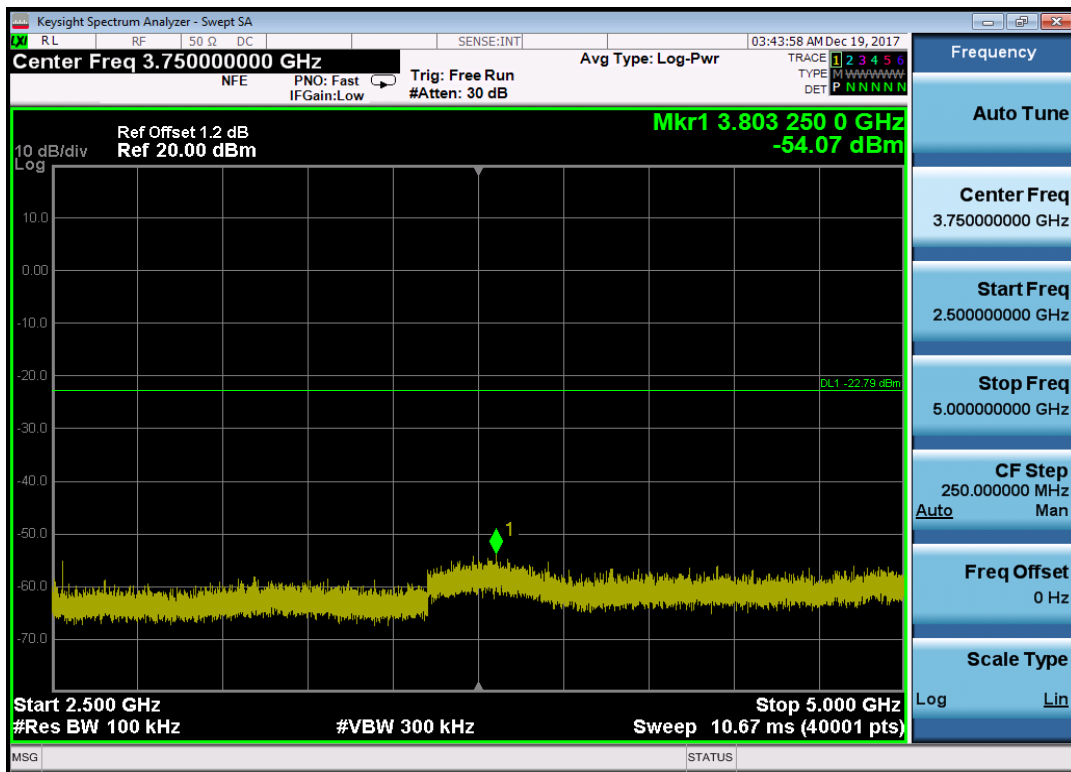
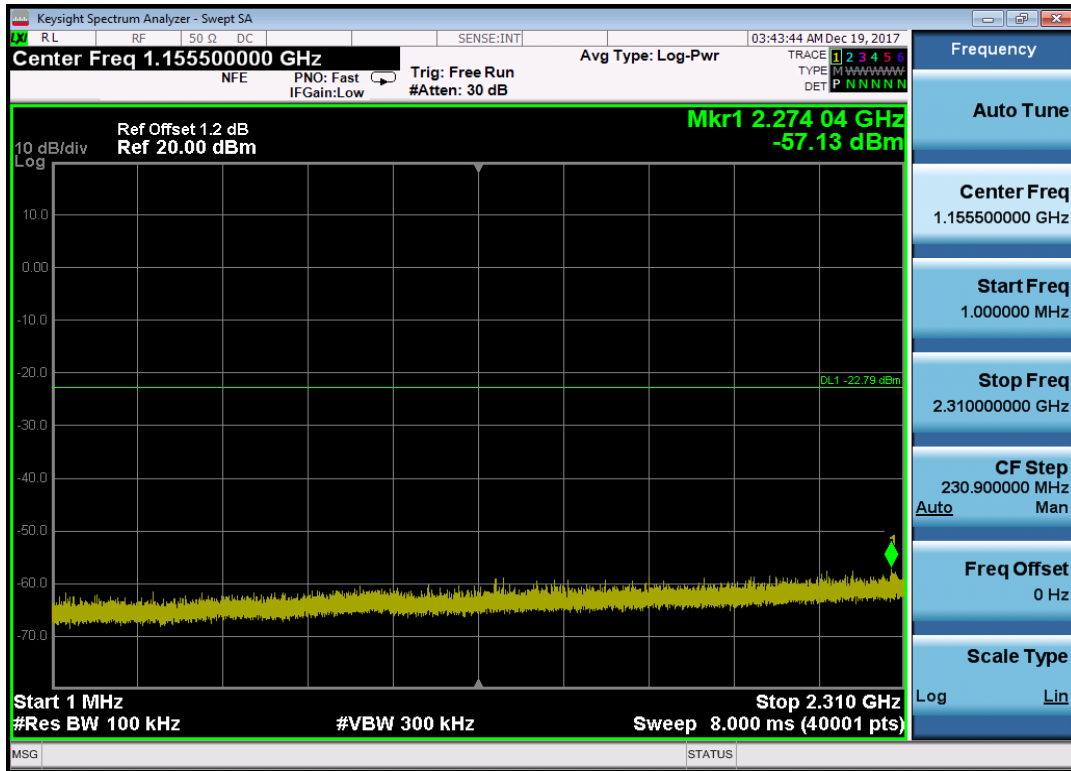

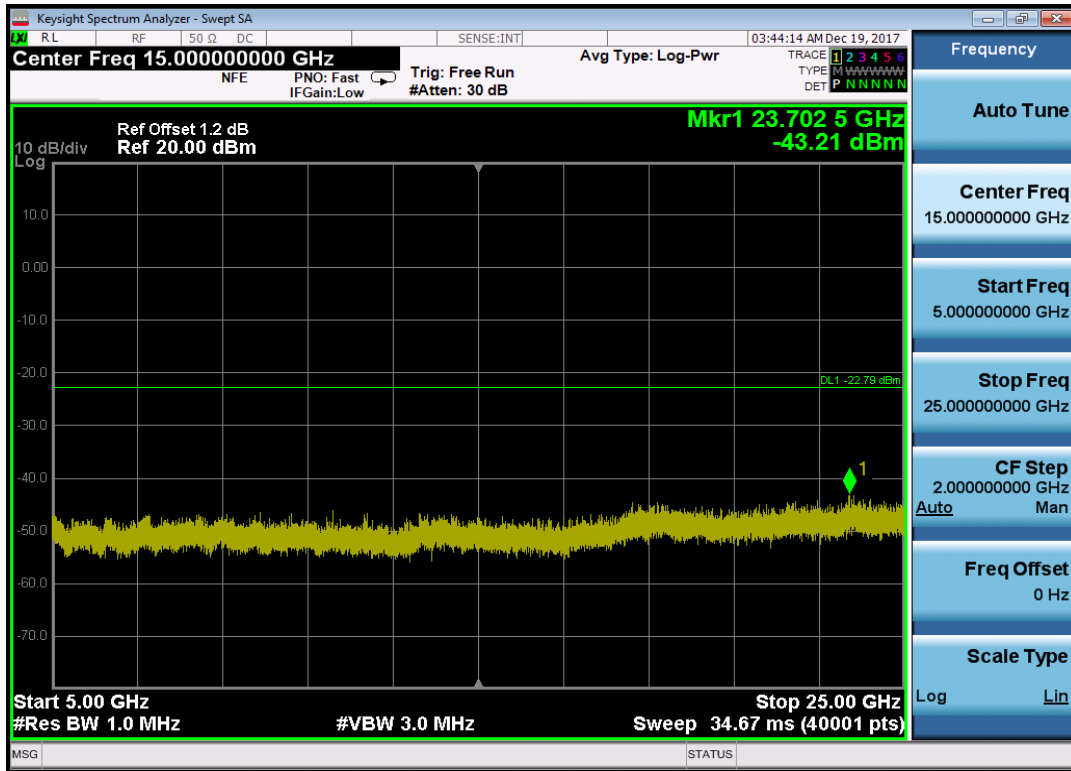

Channel M



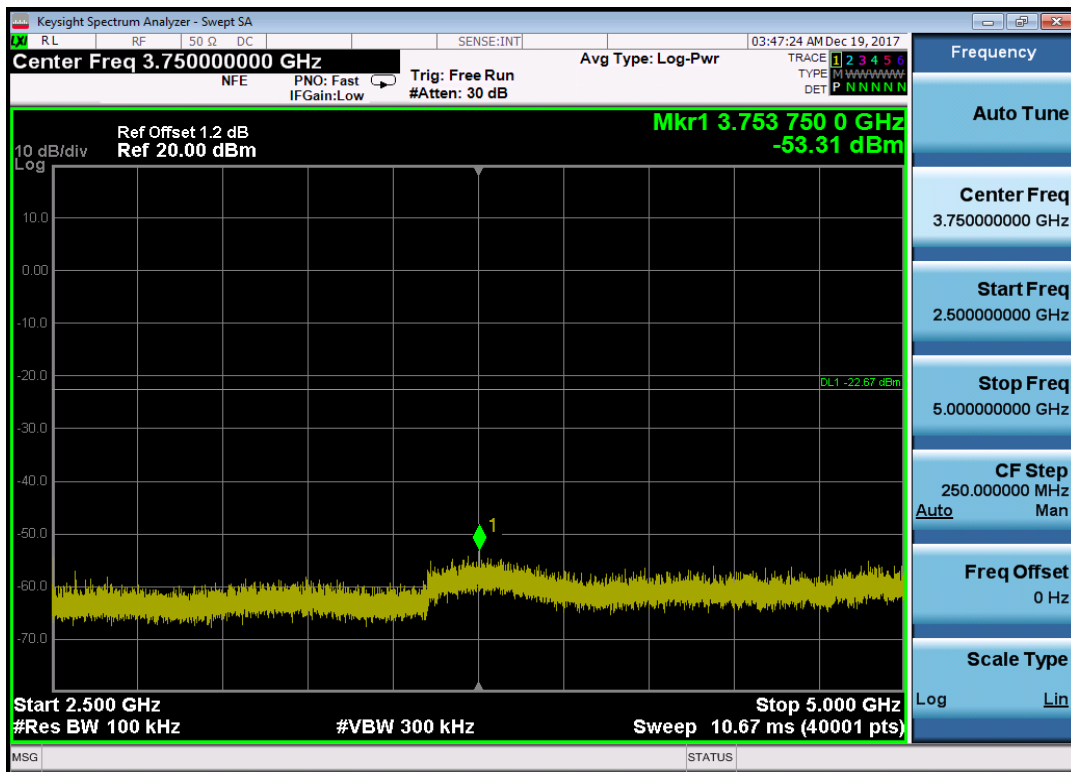
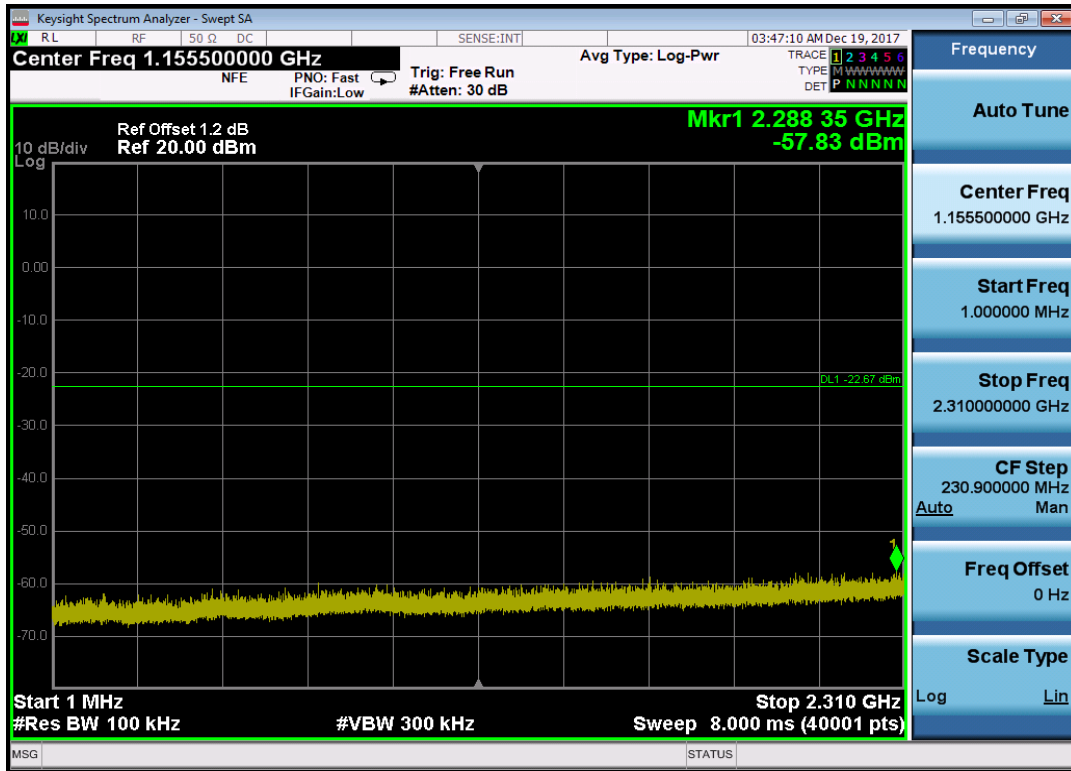

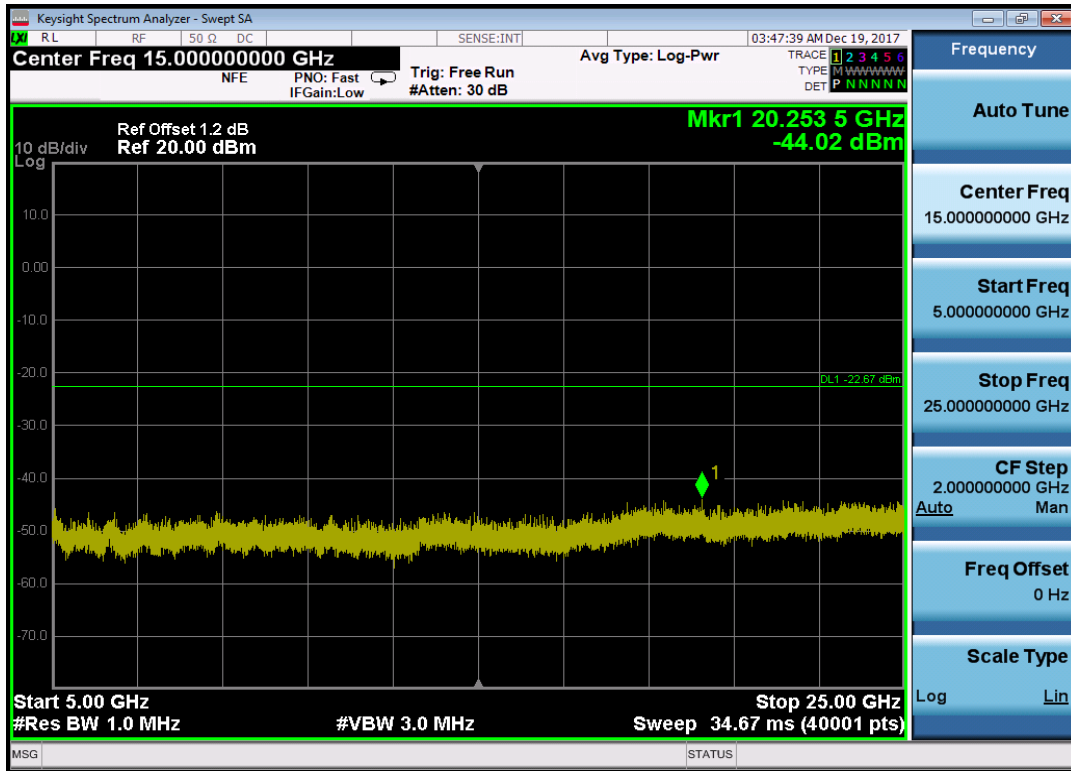

Channel H



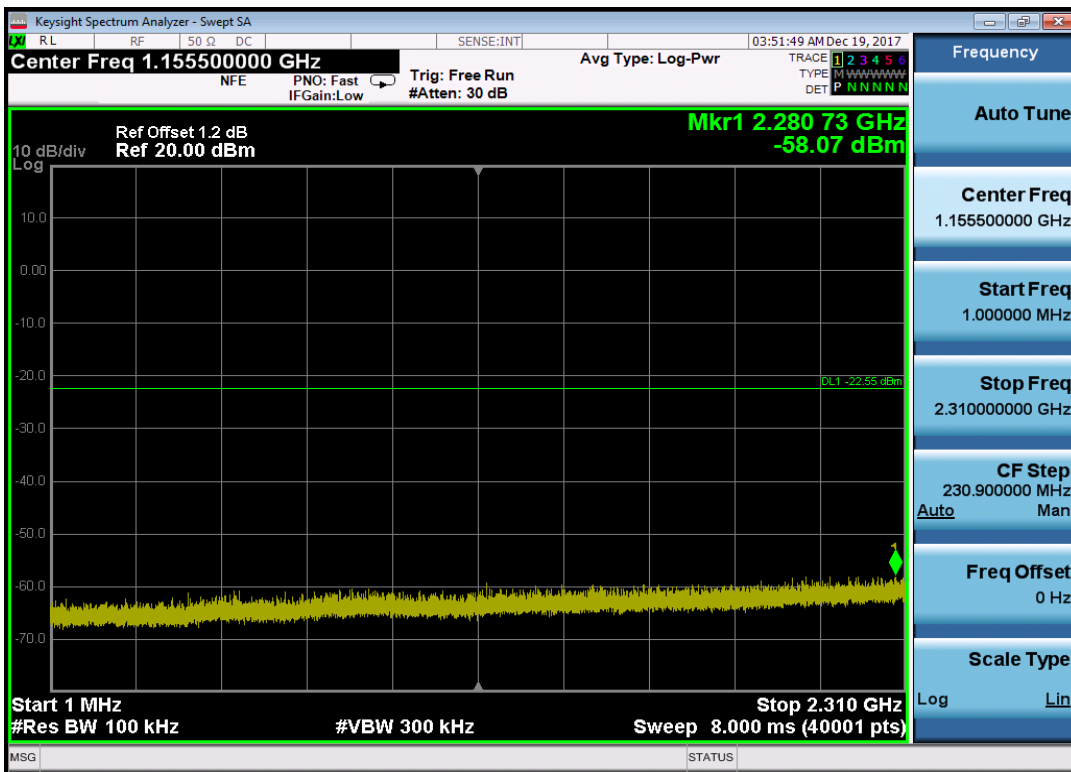
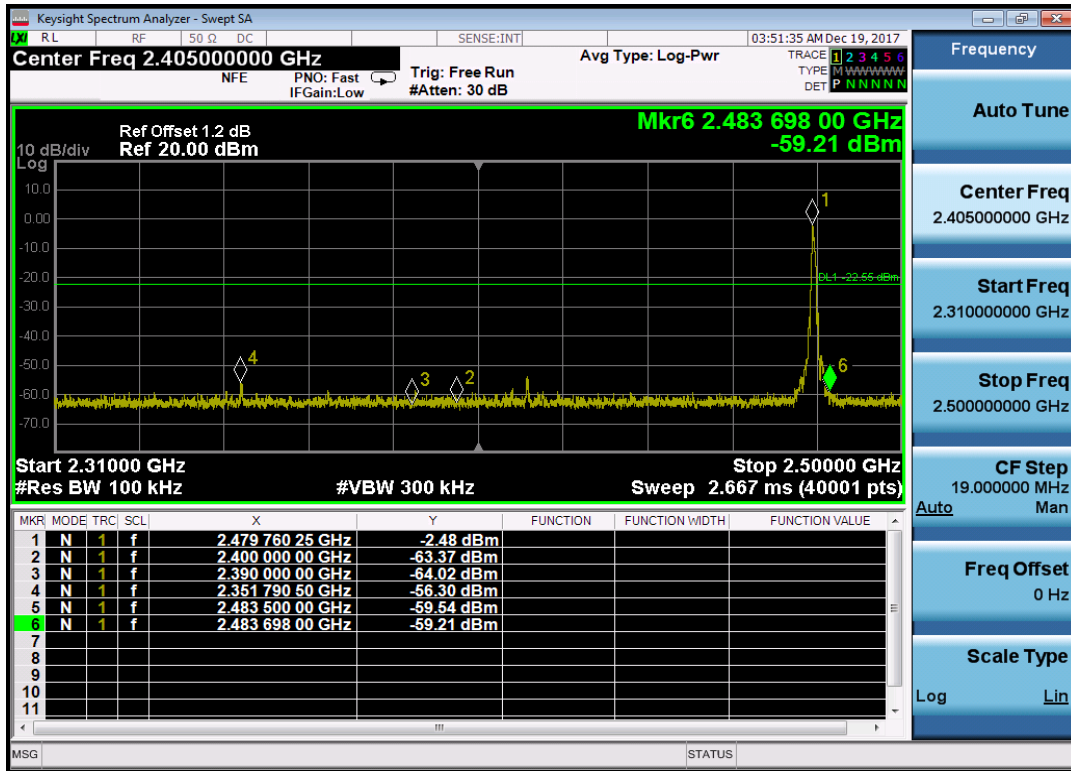

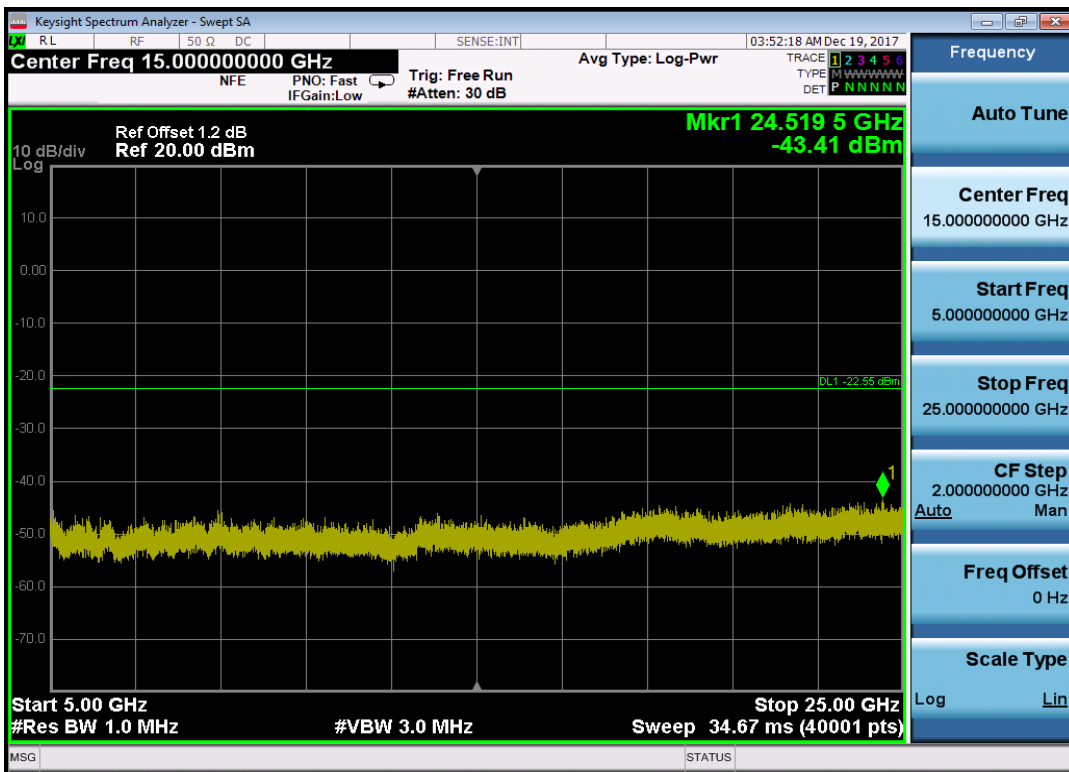
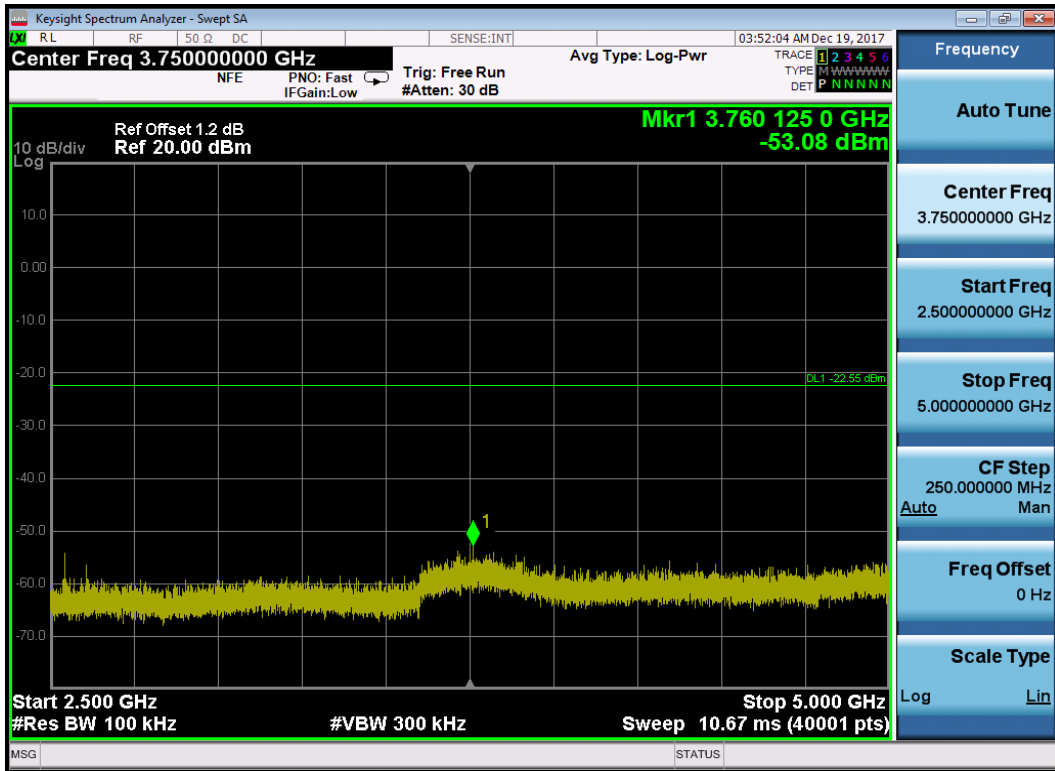

7 Radiated Emissions

Test result: Pass

7.1 Test limit

The radiated emissions which fall in the restricted bands, as defined in §15.205(a), must also comply with the radiated emission limits specified in §15.209(a) showed as below:

Frequencies (MHz)	Field Strength (microvolts/meter)	Measurement Distance (meters)
0.009 ~ 0.490	2400/F(kHz)	300
0.490 ~ 1.705	24000/F(kHz)	30
1.705 ~ 30.0	30	30
30 ~ 88	100	3
88 ~ 216	150	3
216 ~ 960	200	3
Above 960	500	3

7.2 Test Configuration

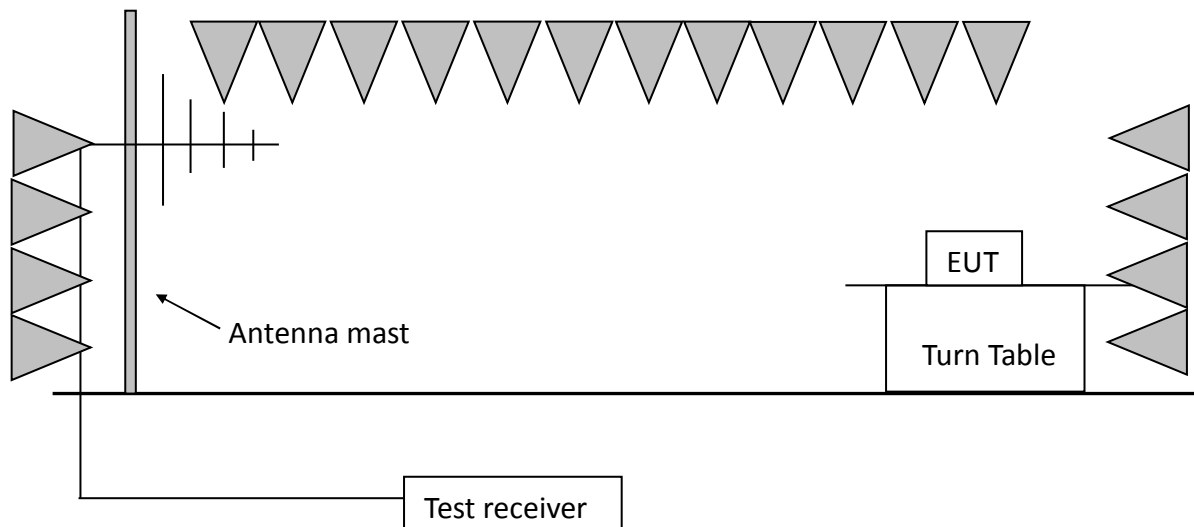

7.3 Test procedure and test setup

The measurement was applied in a semi-anechoic chamber. While testing for spurious emission higher than 1GHz, if applied, the pre-amplifier would be equipped just at the output terminal of the antenna.

Tabletop devices shall be placed on a nonconducting platform with nominal top surface dimensions 1 m by 1.5 m. For emissions testing at or below 1 GHz, the table height shall be 80 cm above the reference ground plane. For emission measurements above 1 GHz, the table height shall be 1.5 m.

The turntable rotated 360 degrees to determine the position of the maximum emission level. The EUT was set 3 meters away from the receiving antenna which was mounted on an antenna mast. The antenna moved up and down between from 1meter to 4 meters to find out the maximum emission level.

The EUT was tested according to DTS test procedure of KDB558074 D01 DTS "Meas Guidance" for compliance to FCC 47CFR 15.247 requirements.

The radiated emission was measured using the Spectrum Analyzer with the resolutions bandwidth set as:

RBW = 300 Hz, VBW = 1 kHz (9 kHz~150 kHz);
RBW = 10 kHz, VBW = 30 kHz (150 kHz~30MHz);
RBW = 100 kHz, VBW = 300 kHz (30MHz~1GHz for PK)
RBW = 1MHz, VBW = 3MHz (>1GHz for PK);

Remark:

1. Factor= Antenna Factor + Cable Loss (-Amplifier, is employed)
2. Measured level= Original Receiver Reading + Factor
3. Margin = Limit – Measured level
4. If the PK measured level is lower than AV limit, the AV test can be elided.

Example:

Assuming Antenna Factor = 30.20dB/m, Cable Loss = 2.00dB,
Gain of Preamplifier = 32.00dB, Original Receiver Reading = 10dBuV.
Then Factor = 30.20 + 2.00 – 32.00 = 0.20dB/m;
Measured level = 10dBuV + 0.20dB/m = 10.20dBuV/m
Assuming limit = 54dBuV/m,
Measured level = 10.20dBuV/m, then Margin = 54 - 10.20 = 43.80dBuV/m.

7.4 Test Protocol

Temperature: 25 °C
Relative Humidity: 55 %

The low frequency, which started from 9 kHz to 30MHz, was pre-scanned and the result which was 20dB lower than the limit line per 15.31(o) was not reported.

The worst waveform from 30MHz to 1000MHz is listed as below:

Horizontal

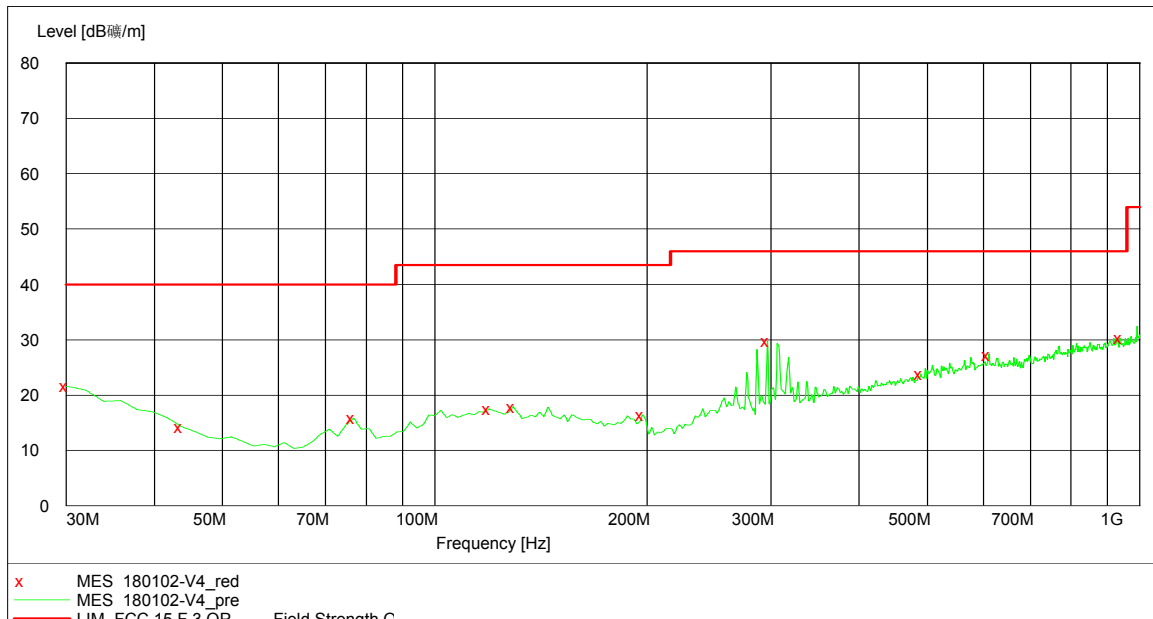

Vertical

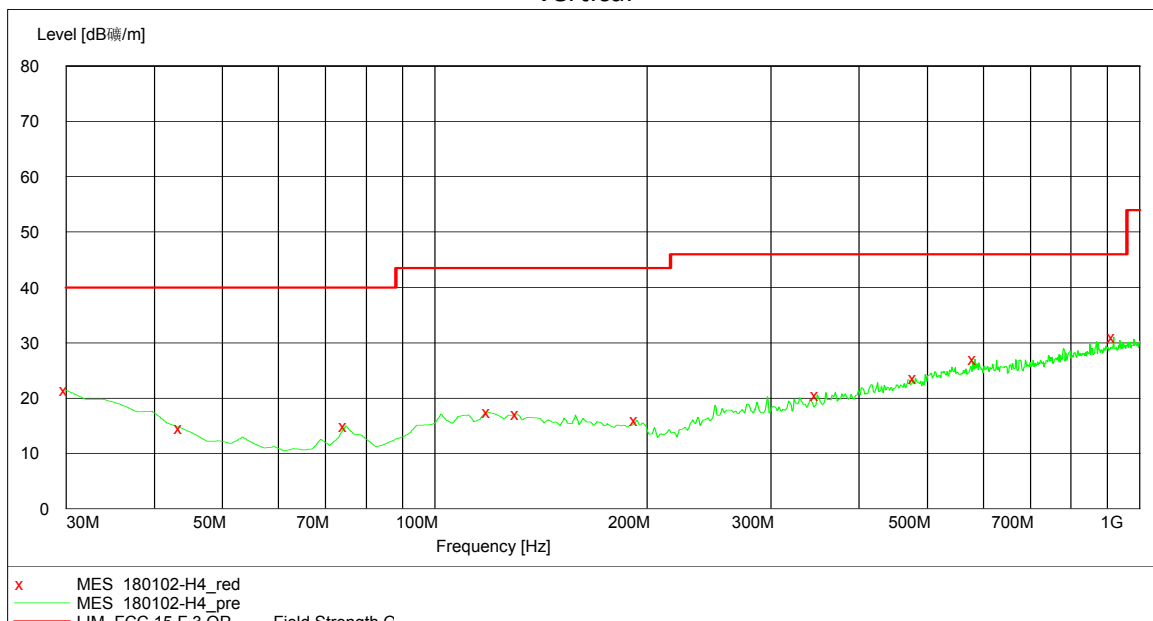

Test data 30MHz~1GHz:

Polarization	Frequency (MHz)	Measured level (dB μ V/m)	Correct Factor (dB/m)	Limits (dB μ V/m)	Margin (dB)	Detector
H	30.00	21.6	19.2	40.0	18.4	PK
	43.61	14.3	11.6	40.0	25.7	PK
	76.65	15.8	7.6	40.0	24.2	PK
	119.42	17.5	13.3	43.5	26.0	PK
	129.14	17.9	12.9	43.5	25.6	PK
	197.17	16.4	10.7	43.5	27.1	PK
	296.31	29.7	14.6	46.0	16.3	PK
	488.76	23.8	19.1	46.0	22.2	PK
	611.22	27.3	20.6	46.0	18.7	PK
	939.74	30.3	23.4	46.0	15.7	PK
V	30.00	21.4	19.2	40.0	18.6	PK
	43.61	14.6	11.6	40.0	25.4	PK
	74.71	14.9	7.5	40.0	25.1	PK
	119.42	17.4	13.3	43.5	26.1	PK
	131.08	17.0	12.8	43.5	26.5	PK
	193.29	16.0	10.6	43.5	27.5	PK
	348.80	20.5	16.0	46.0	25.5	PK
	480.98	23.6	18.9	46.0	22.4	PK
	584.01	27.0	20.4	46.0	19.0	PK
	918.36	31.0	23.2	46.0	15.0	PK

Test result above 1GHz:

The emission was conducted from 1GHz to 25GHz.

CH	Antenna	Frequency (MHz)	Correct Factor (dB/m)	Corrected Reading (dBuV/m)	Limit (dBuV/m)	Margin (dB)	Detector
L	H	2402.00	30.70	94.70	Fundamental	/	PK
	V	2402.00	30.70	90.30	Fundamental	/	PK
	H	2390.00	30.30	50.30	74.00	23.70	PK
	H	2390.00	30.30	42.30	54.00	11.70	AV
	H	4804.00	-1.50	45.60	74.00	28.40	PK
	H	7206.00	3.50	43.30	74.00	30.70	PK
	V	2390.00	30.30	45.50	74.00	28.50	PK
	V	2390.00	30.30	39.10	54.00	14.90	AV
	V	4804.00	-1.50	42.30	74.00	31.70	PK
	V	7206.00	3.50	40.50	74.00	33.50	PK
M	H	2440.00	30.70	94.40	Fundamental	/	PK
	V	2440.00	30.70	90.20	Fundamental	/	PK
	H	4880.00	-1.10	45.40	74.00	28.60	PK
	H	7320.00	3.60	43.70	74.00	30.30	PK
	V	4880.00	-1.10	43.80	74.00	30.20	PK
	V	7320.00	3.60	43.30	74.00	30.70	PK
H	H	2480.00	30.70	95.10	Fundamental	/	PK
	V	2480.00	30.70	90.30	Fundamental	/	PK
	H	2483.50	30.80	48.60	74.00	25.40	PK
	H	2483.50	30.80	41.40	54.00	12.60	AV
	V	2483.50	30.80	45.10	74.00	28.90	PK
	V	2483.50	30.80	38.80	54.00	15.20	AV
	H	4960.00	-0.80	45.60	74.00	28.40	PK
	H	7440.00	3.80	46.30	74.00	27.70	PK
	V	4960.00	-0.80	44.20	74.00	29.80	PK
	V	7440.00	3.80	45.70	74.00	28.30	PK

8 Power line conducted emission

Test result: Pass

8.1 Limit

Frequency of Emission (MHz)	Conducted Limit (dBuV)	
	QP	AV
0.15-0.5	66 to 56*	56 to 46 *
0.5-5	56	46
5-30	60	50

* Decreases with the logarithm of the frequency.

8.2 Test configuration

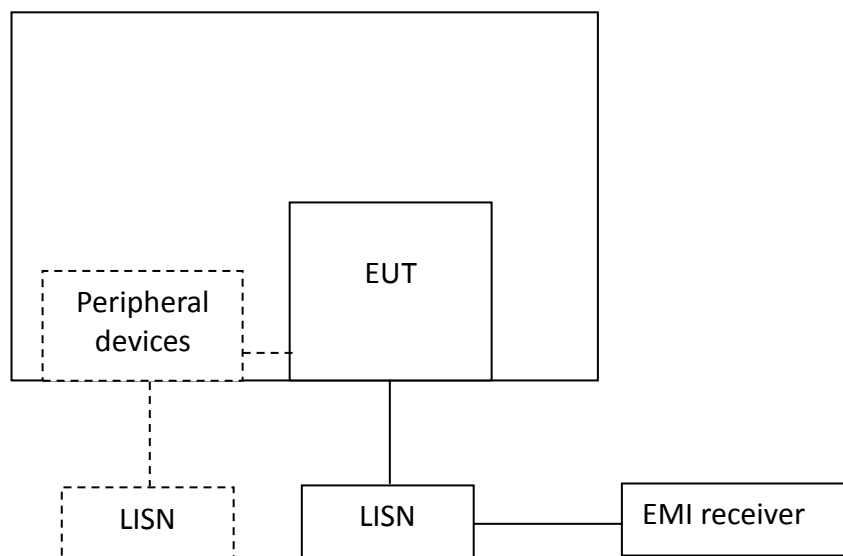

For table top equipment, wooden support is 0.8m height table

For floor standing equipment, wooden support is 0.1m height rack.

8.3 Test procedure and test set up

Measured levels of ac power-line conducted emission shall be the emission voltages from the voltage probe, where permitted, or across the 50 Ω LISN port (to which the EUT is connected), where permitted, terminated into a 50 Ω measuring instrument. All emission voltage and current measurements shall be made on each current-carrying conductor at the plug end of the EUT power cord by the use of mating plugs and receptacles on the LISN, if used. Equipment shall be tested with power cords that are normally supplied or recommended by the manufacturer and that have electrical and shielding characteristics that are the same as those cords normally supplied or recommended by the manufacturer. For those measurements using a LISN, the 50 Ω measuring port is terminated by a measuring instrument having 50 Ω input impedance. All other ports are terminated in 50 Ω loads.

Tabletop devices shall be placed on a platform of nominal size 1 m by 1.5 m, raised 80 cm above the reference ground plane. The vertical conducting plane or wall of an RF-shielded (screened) room shall be located 40 cm to the rear of the EUT. Floor-standing devices shall be placed either directly on the reference ground-plane or on insulating material as described in ANSI C63.4. All other surfaces of tabletop or floor-standing EUTs shall be at least 80 cm from any other grounded conducting surface, including the case or cases of one or more LISNs.

The bandwidth of the test receiver is set at 9 kHz.

8.4 Test protocol

Temperature: 22 °C
Relative Humidity: 52 %

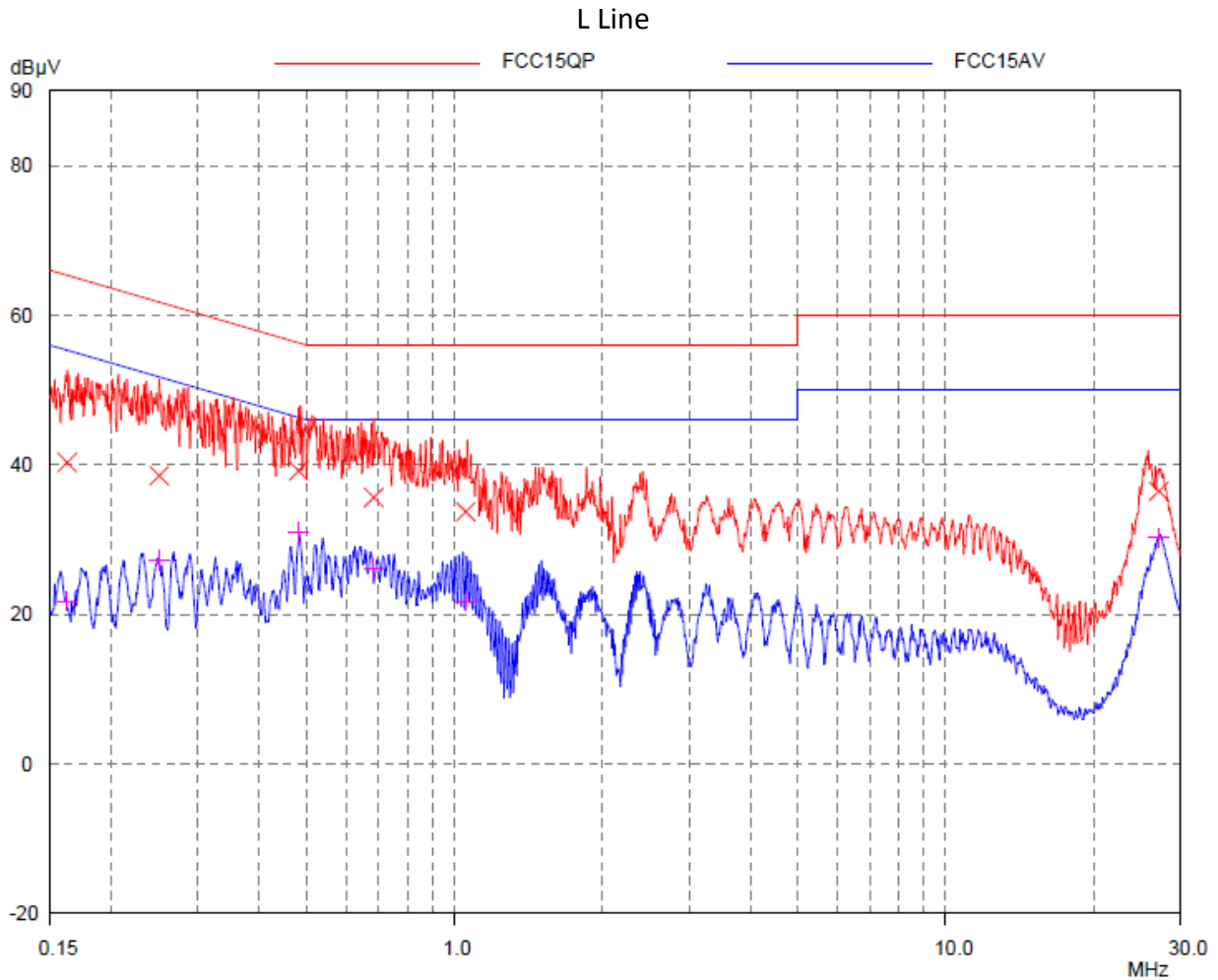

Test Data:

Frequency (MHz)	Quasi-peak			Average		
	level dB(µV)	Limit dB(µV)	Margin (dB)	level dB(µV)	limit dB(µV)	Margin (dB)
0.162	40.33	65.34	25.01	21.76	55.34	33.58
0.250	38.55	61.76	23.21	27.27	51.76	24.49
0.481	39.23	56.32	17.09	31.05	46.32	15.27
0.684	35.62	56.00	20.38	26.19	46.00	19.81
1.052	33.72	56.00	22.28	21.75	46.00	24.25
27.126	36.48	60.00	23.52	30.28	50.00	19.72

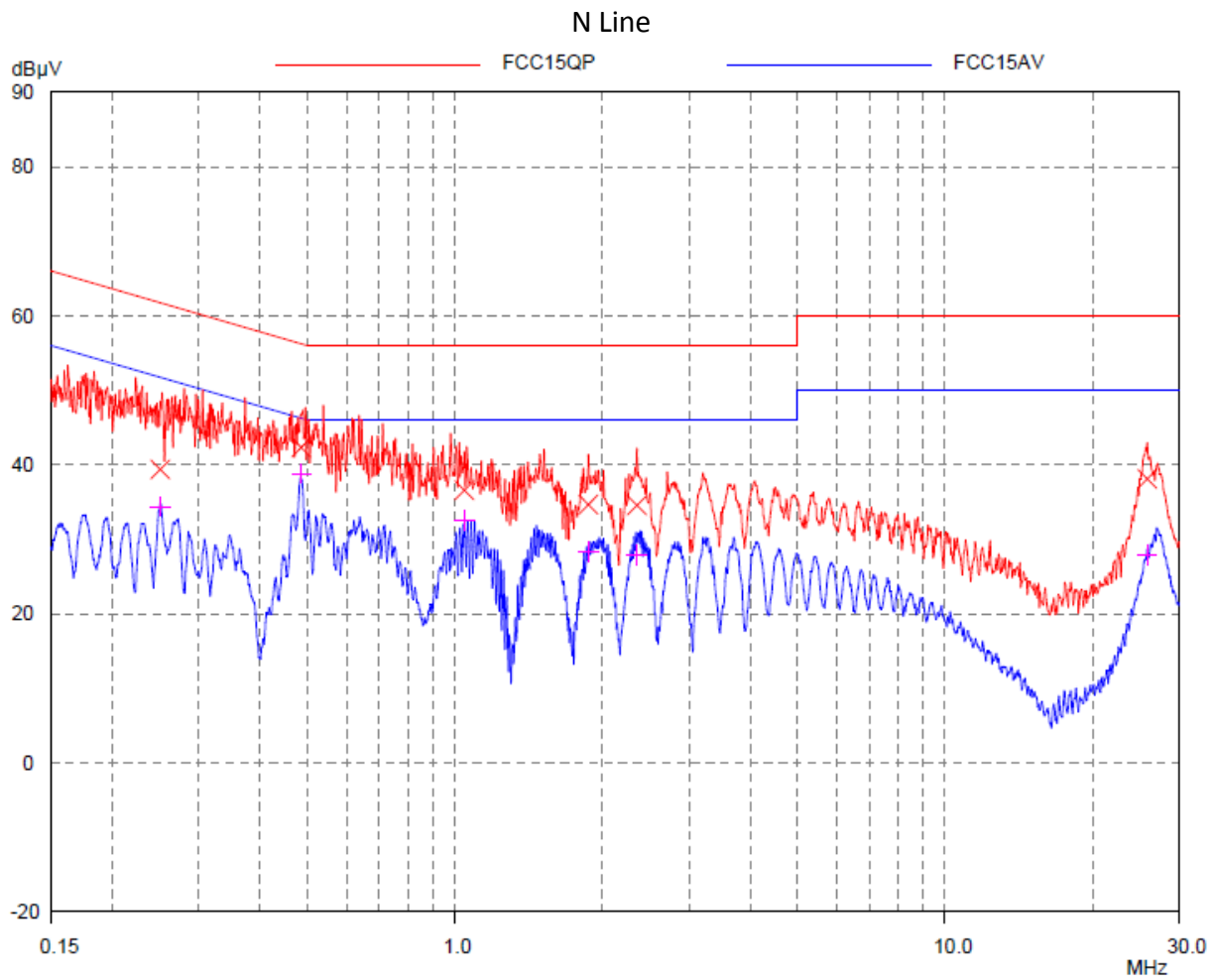

Test Data:

Frequency (MHz)	Quasi-peak			Average		
	level dB(µV)	Limit dB(µV)	Margin (dB)	level dB(µV)	limit dB(µV)	Margin (dB)
0.250	39.40	61.76	22.36	34.40	51.76	17.36
0.485	42.36	56.25	13.89	38.79	46.25	7.46
1.044	36.61	56.00	19.39	32.57	46.00	13.43
1.870	34.68	56.00	21.32	28.33	46.00	17.67
2.348	34.58	56.00	21.42	27.87	46.00	18.13
25.857	38.11	60.00	21.89	27.92	50.00	22.08