

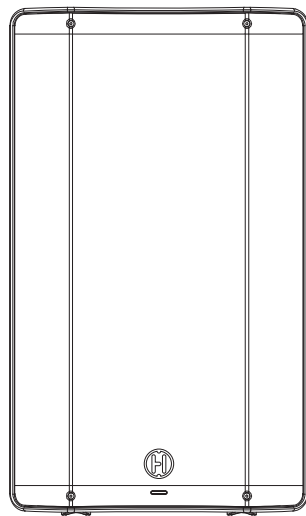

HARBINGER

V4000 SERIES
OWNER'S MANUAL



V4112

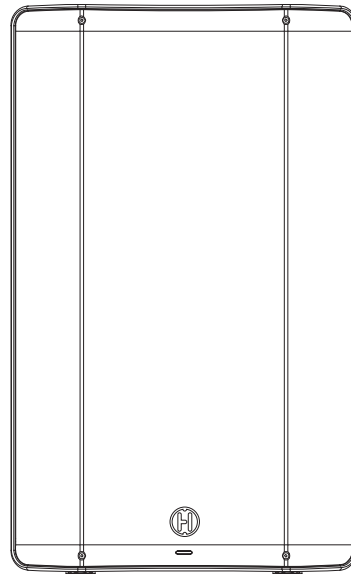

V4115

VARI
S E R I E S



QUICK START GUIDE: SINGLE V4112/V4115

VARI Series speakers can be used as Main Speakers or Monitor Speakers.

SETTING UP / HELPFUL TIPS

- Position the VARI speaker in the desired location, and ensure the speaker is stable.
- Make sure the Power Switch is off.
- Turn Channel 1, 2, and 3 knobs to minimum.
- Turn Bass and Treble to center/straight up.

MAKING THE CONNECTIONS

- Connect sources to Channel 1, 2 and 3 input jacks as desired. (All these input jacks can be used at once, along with Bluetooth audio input.)

CHECK SWITCHES

- Check that Mono / Stereo Master / Link In switch is set to Mono.
- Check that Channel 1 and Channel 2 switches match sources: Mic for microphones, Guitar for acoustic guitar or pedalboard output, Line for mixers, keyboards and other electronics.

POWERING UP

- Power on any devices connected to input jacks.
- Turn up the output volume of all sources.
- Turn Channel 1, 2 and 3 knobs to desired levels.

BLUETOOTH AUDIO INPUT

- From your Bluetooth audio source device, look for V4112 or V4115 and select it.
- See next page for Bluetooth Troubleshooting in case of difficulty.

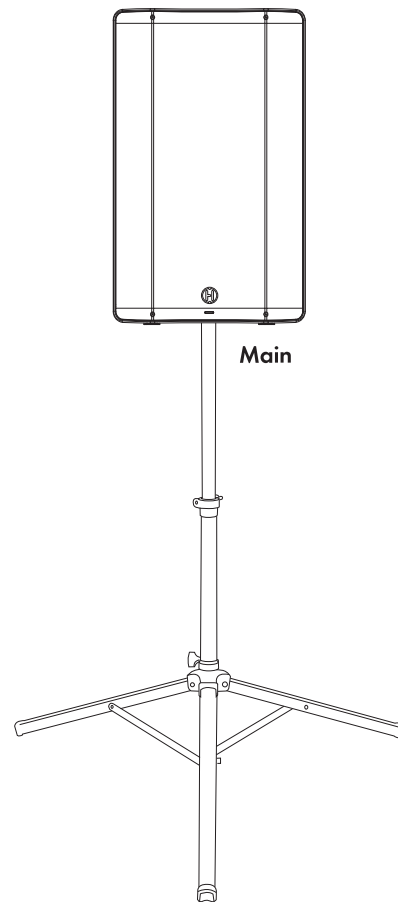
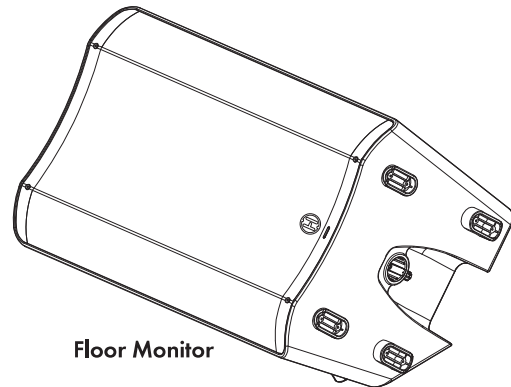

Speaker stand not included



HARBINGER

SMART STEREO™ WITH V4112/V4115

A pair of VARI 4112 or 4115 speakers can operate together as a Smart Stereo™ system, giving you control of the sound and volume of both speakers from the first master speaker, and optimally distributing all audio inputs to both speakers for rich stereo sound.

Channel 1 and 2 inputs are routed mono to both VARI's, while all Channel 3 inputs are routed in split stereo to the VARI's.

- 1 Connect all inputs and make all sound settings on the first (left) unit only. The second (right) unit's inputs and controls are all disabled when it is set to Link In.
- 2 Set the switch on first unit to Stereo Master.
- 3 Set the switch on second unit to Link In.
- 4 Connect an XLR (microphone) cable from the first unit's OUT jack to the second unit's LINK IN.

BLUETOOTH® TROUBLESHOOTING

These steps should resolve any Bluetooth trouble you may encounter:

- Power off the V4112 or V4115 and leave it off
- On your Apple iOS device
 1. Open Settings app, select Bluetooth
 2. If V4112 or V4115 is listed under MY DEVICES, touch info button, tap to Forget This Device
 3. Turn off Bluetooth, wait 10 seconds, turn on Bluetooth
- On your Android device
 1. Open Settings, select Bluetooth
 2. If V4112 or V4115 is listed under Paired Devices, touch gear icon, and tap to Unpair
 3. Turn off Bluetooth, wait 10 seconds, turn on Bluetooth
- Then power on your V4112 or V4115, and Bluetooth LED should flash
- You should now be able to connect to V4112 or V4115 via Bluetooth

V4112/V4115 BACK PANEL



1 MASTER VOLUME

Turn this knob to set volume from the speaker

Press knob to access DSP parameters on the display

Follow the instructions on the display to adjust DSP parameters

2 CHANNEL 1 AND 2 KNOBS

These knobs set the volume for the inputs below them

3 MIC/GUITAR/LINE SWITCHES

Set these to match the type of source connected to the input below them

- Mic: for microphones, or line level sources with low output volumes
- Guitar: for acoustic guitar or guitar pedal board
- Line: for line level sources

4 CHANNEL 1 AND 2 INPUT JACKS

Connect XLR or 1/4-inch cables

5 CHANNEL 3 KNOB

Sets the volume for all the inputs below, including Bluetooth audio, aux and line inputs

6 BLUETOOTH AUDIO INPUT

Bluetooth audio input is automatically enabled each time you turn the speaker on, will automatically reconnect to the previous Bluetooth audio source if it is available, and will otherwise be available for Bluetooth pairing from a source audio device such as a smartphone.

- To pair, look for V4112 or V4115 from your Bluetooth audio source device.
- LED is lit solid when currently paired, blinking when available for pairing, and off if Bluetooth has been disabled by a press of the Bluetooth Off button.
- On/Pair button forces any currently connected Bluetooth audio source to disconnect, and makes the speaker available for pairing.
- Off button disables Bluetooth. (Bluetooth will be re-enabled next time you turn power off and on, or if you press the On/Pair button.)

7 AUX INPUT

Audio from smartphones, computers and other consumer audio devices can be connected here

8 BALANCED LINE INPUTS

Balanced or unbalanced line level sources can be connected here

9 BASS AND TREBLE KNOBS

Adjust the sound of your speaker

10 MONO / STEREO MASTER / LINK IN SWITCH

- Mono: This speaker will output mono audio, and send mono audio to the OUT jack so it's available for any other speaker or sound system.
- Stereo Master: This speaker will operate as the master speaker of a Smart Stereo(TM) pair. Use a mic cable to connect this speaker's OUT to the LINK IN jack of a second speaker of the same type. All inputs should be connected to the first master speaker, which will also set the volume and tone of both speakers.
- Link In: Use this setting for the second speaker of a Smart Stereo(TM) pair. The audio from the LINK IN will be routed directly to the power amp and speaker, with all other inputs and controls being ignored. This jack feeds directly through to the power amp, bypassing all volume and tone controls of the amplifier.

11 DIRECT OUT JACK

Sends out mono audio

12 LINK IN JACK

Activated only when **10** switch is set to LINK IN

13 LINK OUT JACK

- Mono: sends out mono audio
- Stereo Master: sends out right audio, for second speaker's LINK IN
- Link In: sends out the same audio received at the LINK IN jack

14 Connect power cable here.

15 If the speaker will not power on and you suspect its fuse may have blown, turn off the power switch, and open the fuse compartment using a small flat blade screwdriver. If metal strip in fuse is broken, replace with T6.3 L/250V type only.

16 Switches the power on and off



HARBINGER

SPECIFICATIONS

HARBINGER VARI Series		V4112	V4115
Amplifier	DSP	Selectable Voicing (Standard, Vocal Boost, Live, Floor Monitor/Wall) and Bass and Treble knobs all control the internal DSP to customize the sound	Selectable Voicing (Standard, Vocal Boost, Live, Floor Monitor/Wall) and Bass and Treble knobs all control the internal DSP to customize the sound
	Limiter	Transparent, dynamic DSP limiter for ideal sound quality and system protection at maximum volume	Transparent, dynamic DSP limiter for ideal sound quality and system protection at maximum volume
	Smart Stereo	A pair of speakers can be connected for unified volume and tone control from the first master speaker, with optimal distribution of mono and audio signals between both speakers	A pair of speakers can be connected for unified volume and tone control from the first master speaker, with optimal distribution of mono and audio signals between both speakers
	Input 1	XLR and 1/4-inch TRS balanced/unbalanced compatible audio input with Mic/Guitar/Line Switch and Input Gain Control	XLR and 1/4-inch TRS balanced/unbalanced compatible audio input with Mic/Guitar/Line Switch and Input Gain Control
	Input 2	XLR and 1/4-inch TRS balanced/unbalanced compatible audio input with Mic/Guitar/Line Switch and Input Gain Control	XLR and 1/4-inch TRS balanced/unbalanced compatible audio input with Mic/Guitar/Line Switch and Input Gain Control
	Input 3	Stereo Line: Left/mono and right 1/4-inch TRS balanced/unbalanced compatible audio line inputs Aux: 1/8-inch mini TRS unbalanced input (-10dB) Bluetooth Audio: with On/Pair and Off buttons plus LED	Stereo Line: Left/mono and right 1/4-inch TRS balanced/unbalanced compatible audio line inputs Aux: 1/8-inch mini TRS unbalanced input (-10dB) Bluetooth Audio: with On/Pair and Off buttons plus LED
	Link In	XLR balanced +4dBv audio input	XLR balanced +4dBv audio input
	Out Jack	XLR balanced +4dBv audio output	XLR balanced +4dBv audio output
	Power Output	4000 Watts Peak	4000 Watts Peak
	Bass EQ Knob	+/-12dB Shelf, 100Hz	+/-12dB Shelf, 100Hz
	Treble EQ Knob	+/-12dB Shelf at 10kHz	+/-12dB Shelf at 10kHz
	Volume	volume control per channel	volume control per channel
	Power Input	115V/60 Hz	115V/60 Hz
	Features		Removable AC Power Cord
		Front LED, configurable to indicate power or power/limiter	Front LED, configurable to indicate power or power/limiter
		Color LCD display for DSP control	Color LCD display for DSP control
Speaker	Type	12" 2-way vented design	15" 2-way vented design
	Frequency Response	40-20K Hz	40-20K Hz
	Max SPL@1M	129 dB	130dB
	HF Driver	Compression Driver, 8 Ohm	Compression Driver, 8 Ohm
	LF Driver	12" Driver, 4 Ohm	15" Driver, 4 Ohm
	Cabinet	Polypropolene, with rubber surfaced handles and feet	Polypropolene, with rubber surfaced handles and feet
	Grille	1.2mm steel	1.2mm steel
	Suspension Points	3	3
	Pole Mount	35mm stand pole with M6 screw	35mm stand pole with M6 screw
Dimensions and Weights	Product Dimensions	14.2" x 14.2" x 24.1"	16.5" x 15.0" x 27.1"
	Packaging Size	18.1" x 18.1" x 28.1"	20.1" x 19.5" x 31.1"
	Net Weight	35 pounds	41 pounds
	Gross Weight	45 pounds	50 pounds



HARBINGER

IMPORTANT SAFETY INSTRUCTIONS

Please keep this instruction manual for future reference and for the duration of owning the VARI powered loudspeaker. Please carefully read and understand the instructions inside this owner's manual before attempting to operate your new powered loudspeaker.

This instruction manual includes essential safety information regarding the use and maintenance of the amplifier. Take special care to heed all warning symbols and signs inside this manual and those printed on the amplifier on the back of the loudspeaker.

WARNING

TO PREVENT FIRE OR SHOCK HAZARD, DO NOT EXPOSE THE AMPLIFIER TO WATER/MOISTURE, NOR SHOULD YOU OPERATE THE AMPLIFIER NEAR ANY WATER SOURCE.

The exclamation point triangular symbol is intended to alert the user to the presence of important operating and maintenance(servicing) instructions in the user manual accompanying the Amplifier.

The lightning flash with an arrow triangular symbol is intended to alert the user to the presence of non-insulated "dangerous voltage" within the product's enclosure, and may be of sufficient magnitude to constitute a risk of electric shock.

WARNING

Handle the power supply cord with care.

Do not damage or deform it as it may cause electric shock or malfunction when used. Hold the plug attachment when removing from wall outlet. Do not pull on the power cord.

IMPORTANT SAFETY PRECAUTIONS

1. Read these instructions.
2. Keep these instructions.
3. Heed all warnings.
4. Follow all Instructions.
5. Do not use this apparatus near water.
6. Clean only with dry cloth.
7. Do not block any ventilation openings. Install in accordance with the manufacturer's instructions. DO NOT turn on the VARI amplifier module before connecting all other external devices.
8. Do not install near any heat sources such as radiators, heat registers, stoves, or other apparatus (including amplifiers) that produce heat.
9. Do not defeat the safety purpose of the polarized or grounding-type plug. A polarized plug has two blades with one wider than the other. A grounding type plug has two blades and a third grounding prong. The wide blade or the third prong is provided for your safety. If the provided plug does not fit into your outlet, consult an electrician for replacement of the obsolete outlet.
10. Protect the power cord from being walked on or pinched particularly at plugs, convenience receptacles, and the point where they exit from the apparatus.
11. Only use attachment/accessories specified by the manufacturer.
12. Use only the cart, stand, tripod, bracket or table specified by the manufacturer, or sold with the apparatus. When a cart is used, use caution when moving the cart/apparatus combination to avoid injury from tip-over. 
13. Unplug this apparatus during lightning storms or when unused for long periods of time.



14. Refer all servicing to qualified service personnel. Servicing is required when the apparatus has been damaged in any way, such as power-supply cord or plug is damaged, liquid has been spilled or objects have fallen into the apparatus, the apparatus has been exposed to rain or moisture, does not operate normally, or has been dropped.
15. POWER SOURCES - This product should be operated only from the type of power source indicated on the rating label. If you are not sure of the type of power supply to your home, consult your product dealer or local power company.
16. WALL OR CEILING MOUNTING - The product should never be mounted to a wall or ceiling.
17. Where the mains plug or an appliance coupler is used as the disconnect device, the disconnect device shall remain readily operable.
18. OBJECT AND LIQUID ENTRY - Care should be taken so that objects do not fall and liquids are not spilled into the enclosure through openings.
19. Water and Moisture: This product should be kept away from direct contact with liquids. The apparatus shall not be exposed to dripping or splashing and that no objects filled with liquids, such as vases, shall be placed on the apparatus.
20. Keep the speaker system out of extended or intense direct sun light.
21. No containers filled with any type of liquid should be placed on or near the speaker system.
22. SERVICING - The user should not attempt any service to the speaker and/or amplifier beyond that described in the operating instructions. All other servicing should be referred to qualified service personnel.
23. VENTILATION - Slots and openings in the amplifier are provided for ventilation and to ensure reliable operation of the product and to protect it from overheating. These openings must not be blocked or covered. The openings should never be blocked by placing the product on a bed, sofa, rug, or other similar surface. This product should not be placed in a built-in installation such as a bookcase or rack.
24. Protective earthing terminal: The apparatus should be connected to a main socket outlet with a protective earthing connection. 
25. ACCESSORIES - Do not place this product on an unstable cart, stand, tripod, bracket, or table. The product may fall, causing serious injury to a child or adult, and serious damage to the product. Use only with a cart, stand, tripod, bracket, or table recommended by the manufacturer, or sold with the product.
26. When moving or not using the appliance, secure the power cord (e.g., wrap it with a cable tie). Be careful not to damage the power cord. Before using it again, make sure the power cord has not been damaged. If the power cord has been damaged at all, bring the unit and cord to a qualified service technician for repair or replacement as specified by the manufacturer.
27. LIGHTNING - For added protection during a lightning storm, or when it is left unattended and unused for long periods of time, unplug it from the wall outlet. This will prevent damage to the product due to lightning and power-line surges.
28. REPLACEMENT PARTS - When replacement parts are required, be sure the service technician has used replacement parts specified by the manufacturer or have the same characteristics as the original part. Unauthorized substitutions may result in fire, electric shock, or other hazards.



HARBINGER

IMPORTANT SAFETY INSTRUCTIONS

To prevent electric shock, do not use a polarized plug with an extension cord, receptacle or other outlet unless the blades can be fully inserted to prevent blade exposure.

	CAUTION RISK OF ELECTRIC SHOCK DO NOT OPEN	AVIS RISQUE DE CHOC ELECTRIQUE NE PAS OUVRIR	
CAUTION: To reduce the risk of electric shock, do not remove chassis. No user-serviceable parts inside. Refer servicing to qualified service personnel.			
AVERTISSEMENT: Pour réduire les risques d'incendie et d'électrocution, ne pas exposer ce matériel à la pluie ou à l'humidité.			



THIS SYMBOL IS INTENDED TO ALERT THE USER TO THE PRESENCE OF IMPORTANT OPERATING AND MAINTENANCE (SERVICING) INSTRUCTIONS IN THE LITERATURE ACCOMPANYING THE UNIT.



APPARATUS SHALL NOT BE EXPOSED TO DRIPPING OR SPLASHING AND THAT NO OBJECTS FILLED WITH LIQUIDS, SUCH AS VASES, SHALL BE PLACED ON THE APPARATUS.

HEARING DAMAGE AND PROLONGED EXPOSURE TO EXCESSIVE SPLs

Harbinger VARI Series powered loudspeakers are capable of producing extremely loud volume levels that can cause permanent hearing damage to performers, production crews or the audience. Hearing protection is recommended during long-term exposure to high SPLs (sound pressure levels).

Remember, if it hurts, it is definitely too loud! Long term exposure to high SPLs first causes temporary threshold shifts; limiting your ability to hear the actual loudness and exercise good judgment. Repeated long term exposure to high SPLs will cause permanent hearing loss.

Please note the recommended exposure limits in the accompanying table. More information about these limits is available on the US government Occupational Safety and Health (OSHA) website at: www.osha.gov.

Permissible Noise Exposures (1)

Duration per day, hours	Sound level dBA slow response
8	90
6	92
4	95
3	97
2	100
1.5	102
1	105
0.5	110
0.25 or less	115

FCC STATEMENTS

This device complies with Part 15 of the FCC Rules. Operation is subject to the following two conditions:

- (1) This device may not cause harmful interference
 - (2) this device must accept any interference received, including interference that may cause undesired operation.
1. Caution: Changes or modifications to this unit not expressly approved by the party responsible for compliance could void the user's authority to operate the equipment.
 2. Note: This equipment has been tested and found to comply with the limits for a Class B digital device, pursuant to Part 15 of the FCC Rules. These limits are designed to provide reasonable protection against harmful interference in a residential installation. This equipment generate, uses,

and can radiate radio frequency energy and, in not installed and used in accordance with the instructions, may cause harmful interference to radio communications. However, there is no guarantee that interference will not occur in a particular installation. If this equipment does cause harmful interference to radio or television reception, which can be determined by turning the equipment off and on, the user is encouraged to try to correct the interference by one or more of the following measures:

- Reorient or relocate the receiving antenna
- Increase the separation between the equipment and receiver
- Connect the equipment into an outlet on a circuit different from that to which the receiver is connected
- Consult the dealer or an experienced radio/TV technician for help

FCC Radiation Exposure Statement:

This equipment complies with FCC radiation exposure limits set forth for an uncontrolled environment. This equipment should be installed and operated

with minimum distance 20cm between the radiator your body.



HARBINGER

WARRANTY/CUSTOMER SUPPORT

2 YEAR HARBINGER LIMITED WARRANTY

Harbinger provides, to the original purchaser, a two (2) year limited warranty on materials and workmanship on all Harbinger cabinets, loudspeaker and amplifier components from the date of purchase.

For warranty support, please visit our website at www.HarbingerProAudio.com, or contact our Support Team at **888-286-1809** for assistance. Harbinger will repair or replace the unit at Harbinger's discretion.

This warranty does not cover service or parts to repair damage caused by neglect, abuse, normal wear and tear and cosmetic appearance to the cabinetry not directly attributed to defects in materials or workmanship. Also excluded from coverage are damages caused directly or indirectly due to any service, repair(s), or modifications of the cabinet, which has not been authorized or approved by Harbinger. This two (2) year warranty does not cover service or parts to repair damage caused by accident, disaster, misuse, abuse, burnt voice-coils, over-powering, negligence, inadequate packing or inadequate shipping procedures.

The sole and exclusive remedy of the foregoing limited warranty shall be limited to the repair or replacement of any defective or non-conforming component. All warranties including, but not limited to, the express warranty and the implied warranties of merchantability and fitness for a particular purpose are limited to the two (2) year warranty period. Some states do not allow limitation on how long an implied warranty lasts, so the above limitation may not apply to you. There are no express warranties beyond those stated here. In the event that applicable law does not allow the limitation of the duration of the implied warranties to the warranty period, then the duration of the implied warranties shall be limited to as long as is provided by applicable law. No warranties apply after that period.

Retailer and manufacturer shall not be liable for damages based upon inconvenience, loss of use of product, loss of time, interrupted operation or commercial loss or any other incidental or consequential damages including but not limited to lost profits, downtime, goodwill, damage to or replacement of equipment and property, and any costs of recovering, reprogramming, or reproducing any program or data stored in equipment that is used with Harbinger products. This guarantee gives you specific legal rights; you may have other legal rights, which vary from state to state.

Harbinger
P.O. Box 5111, Thousand Oaks, CA 91359-5111

All trademarks and registered trademarks mentioned herein are recognized as the property of their respective holders.

1901-18333938

**MISSING
—OR—
DAMAGED
PARTS?**

HAVE QUESTIONS?

**CALL
888-286-1809
TOLL FREE**

**—HAVE—
ASSEMBLY
QUESTIONS?**

OR VISIT OUR WEBSITE AT: HARBINGERPROAUDIO.COM