

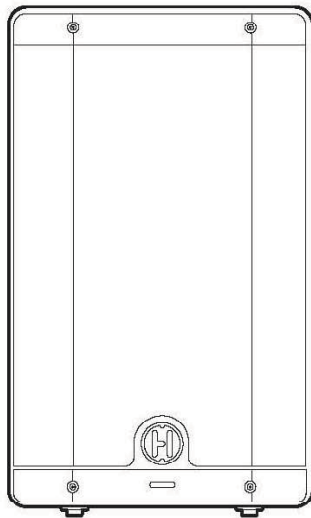

HARBINGER

VARI
LIVE

V2408, V2410, VS12
OWNER'S MANUAL



V2408





TABLE OF CONTENTS

VARI V2408 and V2410	3-5
VS12	6-7
Specifications	8-9
Safety	10-11
Warranty/Customer Support	12

WELCOME

The Harbinger VARI V2408 and V2410 Powered Speakers and VS12 Powered Subwoofer each combine sound optimizing DSP and versatile inputs, outputs and controls, delivering premium sound reproduction with great flexibility.

V2408 8-inch 2-way Powered Speaker with Bluetooth® Audio Input

- 8-inch speaker plus high precision high frequency compression driver
- Bluetooth® audio input, dual mic/instrument inputs, dedicated stereo line input and aux input – all available simultaneously
- DSP providing selectable tunings, easily adjustable Bass and Treble, Sub Cut filter for optimal sound with a subwoofer, a transparent and dynamic limiter, and high precision crossover for extremely accurate, high fidelity sound
- Innovative Smart Stereo capability, with easy volume and tone control for both speakers from the master unit
- Versatile cabinet allowing free-standing, pole-mounted, and lay-flat floor monitor placement

VS12 12-inch Powered Subwoofer with DSP Sound Tuning

- Add a VS12 to any powered speaker setup to bring high impact low frequency response
- DSP provides a transparent and dynamic limiter, and high precision crossover for extremely accurate, high fidelity sound
- Time Aligning Delay ensures you can easily get the maximum bass response in any setup
- Includes adjustable crossover and polarity for optimal pairing with any powered speakers

ALSO AVAILABLE.

When you need to step up to even more sound reproduction power, check out the VARI 3000 Series models and VS18 subwoofer.

V3412 12-inch 2-way Powered Speaker with App Control

- Bigger Sound: A larger 12-inch speaker, and significantly more power and maximum volume than V2408 or V2410 can achieve
- App Control: adjust the sound wirelessly, while standing in front of the VARI, and save customized sound settings to VARI for access any time, with or without the app
- More Voicings: 5 different Voicings, including Club and Speech, let you modify the sound for common applications

V3415 15-inch 2-way Powered Speaker with App Control

- All the same DSP, input, output, control and usage capabilities as the V3412
- A larger 15-inch speaker, delivering additional volume

VS18 18-inch Powered Subwoofer with Easy-Roll Casters

- Add a VS18 to bring high impact to your powered speaker setup
- DSP provides a transparent and dynamic limiter, and high precision crossover for extremely accurate, high fidelity sound
- Time Aligning Delay ensures you can easily get the maximum bass response in any setup
- Includes adjustable crossover and polarity for optimal pairing with any powered speakers



HARBINGER

QUICK START GUIDE: SINGLE V2408/V2410

SETTING UP / HELPFUL TIPS

- Position the VARI speaker in the desired location, and ensure the speaker is stable.
- Make sure the Power Switch is off.
- Turn Input 1, 2, and 3 knobs to minimum.
- Turn Bass and Treble to center/straight up.

MAKING THE CONNECTIONS

- Connect sources to Input 1, 2 and 3 input jacks as desired. (All these input jacks can be used at once, along with Bluetooth® audio input.)

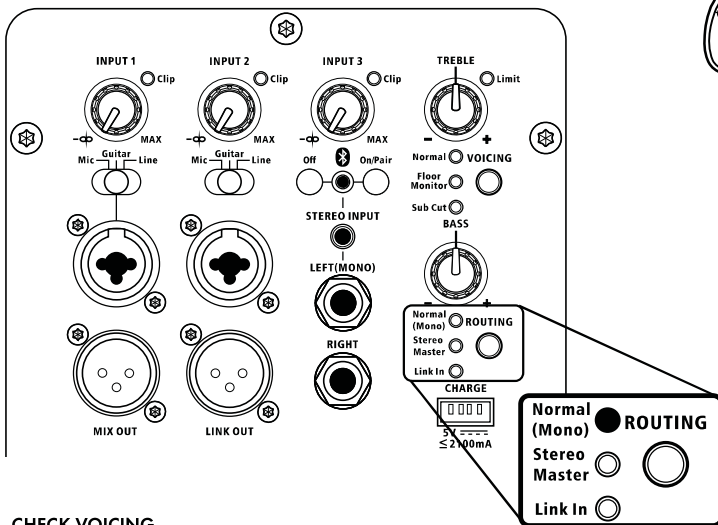

VARI Series speakers can be used as Main Speakers or Floor Monitor Speakers.

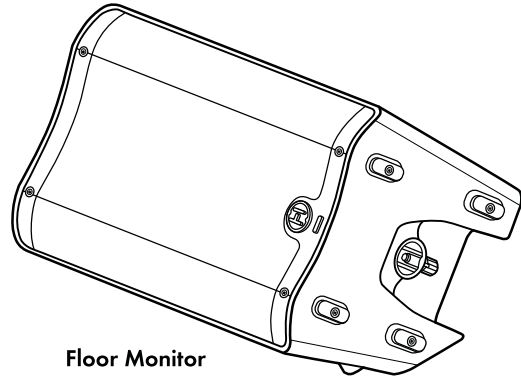

Floor Monitor

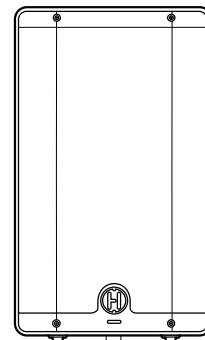

Main

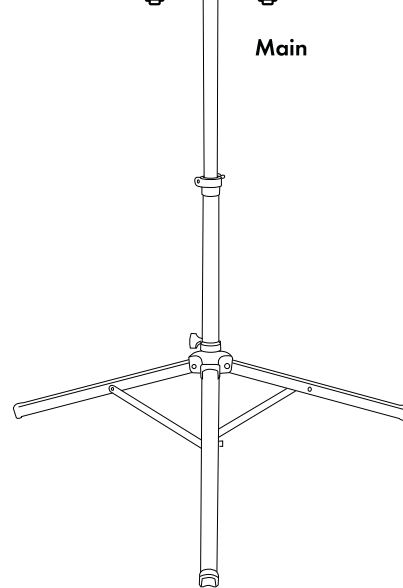

Speaker stand not included

CHECK VOICING

- NORMAL: Check that Normal LED for VOICING is lit for most uses.
- FLOOR MONITOR: If using VARI on its side as a floor monitor, press VOICING so Floor Monitor LED is lit.
- SUB CUT: For use with a subwoofer (see the following 2 pages for details and example setup).

CHECK ROUTING

- Set to Normal (Mono) for most uses.
- See following pages for other routing options.

CHECK INPUTS

- Check that Input 1 and Input 2 switches match sources:
Mic for microphones, Guitar for acoustic guitar or pedalboard output,
Line for mixers, keyboards and other electronics.
- If any Clip LED lights, turn down that input's knob.

POWERING UP

- Power on any devices connected to input jacks.
- Turn up the output volume of all sources.
- Turn Input 1, 2 and 3 knobs to desired levels.

BLUETOOTH® AUDIO INPUT

- From your Bluetooth® audio source device, look for VARI V2408 or VARI V2410 and select it.
- See next page for Bluetooth® Troubleshooting in case of difficulty.

FRONT LED LIGHT

- Front LED will light white to show when speaker is powered on.
- When front LED lights red, limiter is being triggered, and Input 1, 2, and 3 knobs may need to be turned down.



HARBINGER

SMART STEREO WITH V2408/V2410

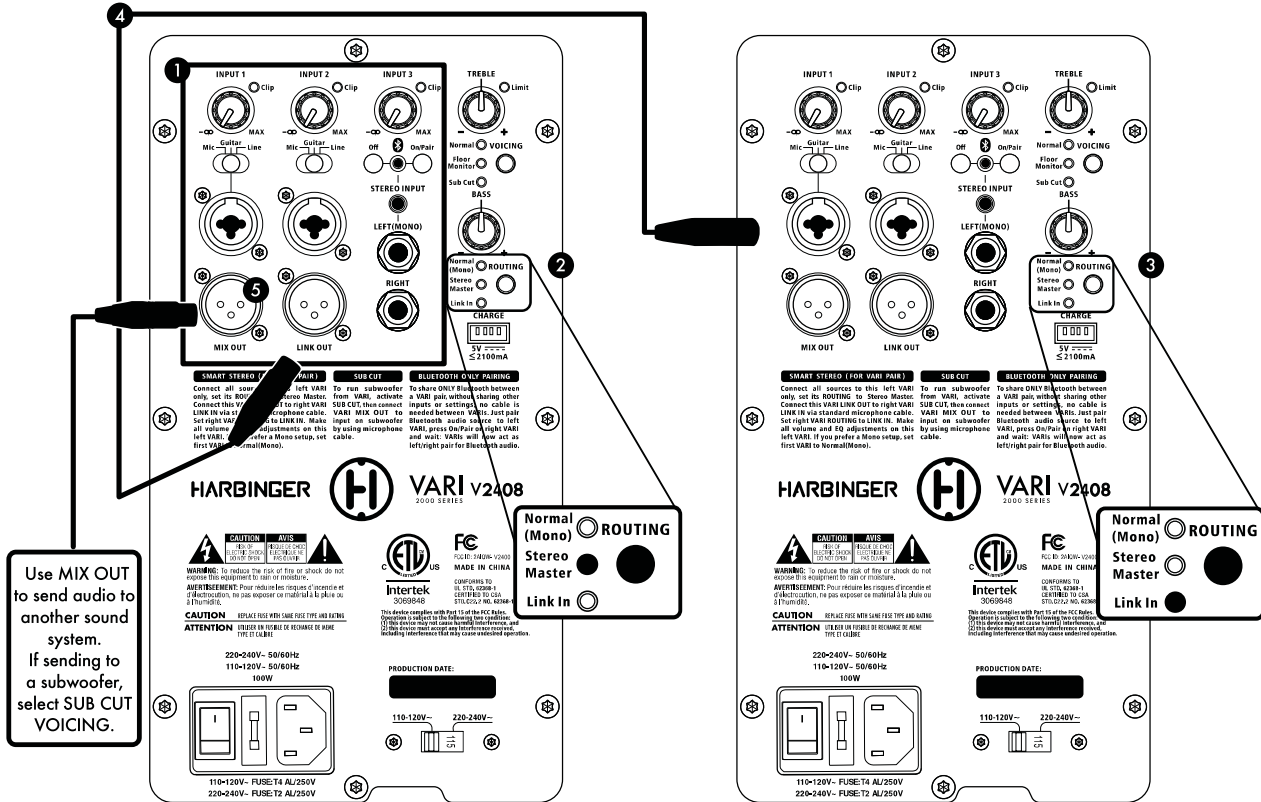

A pair of VARI V2408 or V2410 speakers can operate together as a Smart Stereo system, giving you control of the sound and volume of both speakers from the first master speaker, and optimally distributing all audio inputs to both speakers for rich stereo sound.

Inputs 1 and 2 are routed mono to both VARI's, while Input 3 is routed in split stereo to the VARI's.

- 1 Connect all inputs and make all sound settings on the first (left) unit only. The second (right) unit's Input 2, Input 3 and controls are all disabled when it is set to Link In.
- 2 Set the ROUTING function on first unit to Stereo Master.
- 3 Set the ROUTING function on second unit to Link In.
- 4 Connect an XLR (microphone) cable from the first unit's LINK OUT jack to the second unit's INPUT 1 jack.
- 5 OUTPUT jack of the first speaker can optionally be connected to VS12 or other subwoofer, or to send audio to another sound system.
- 6 If MIX OUT jack is connected to VS12, VS18 or other subwoofer, select SUB CUT Voicing. V2408/V2410 will then crossover the audio, to keep high frequencies for itself, and send low frequencies to the sub.

BLUETOOTH® TROUBLESHOOTING

These steps should resolve any Bluetooth® trouble you may encounter:

- Power off the V2408 or V2410 and leave it off
- On your Apple iOS device
 1. Open Settings app, select Bluetooth®
 2. If VARI V2408 or VARI V2410 is listed under MY DEVICES, touch info button, tap to Forget This Device
 3. Turn off Bluetooth®, wait 10 seconds, turn on Bluetooth®
- On your Android device
 1. Open Settings, select Bluetooth®
 2. If VARI V2408 or VARI V2410 is listed under Paired Devices, touch gear icon, and tap to Unpair
 3. Turn off Bluetooth®, wait 10 seconds, turn on Bluetooth®
- Then power on your V2408 or V2410, and Bluetooth® LED should flash
- You should now be able to connect to V2408 or V2410 via Bluetooth®



HARBINGER

V2408/V2410 BACK PANEL

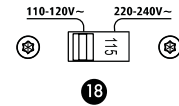
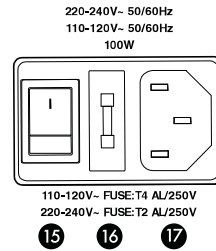
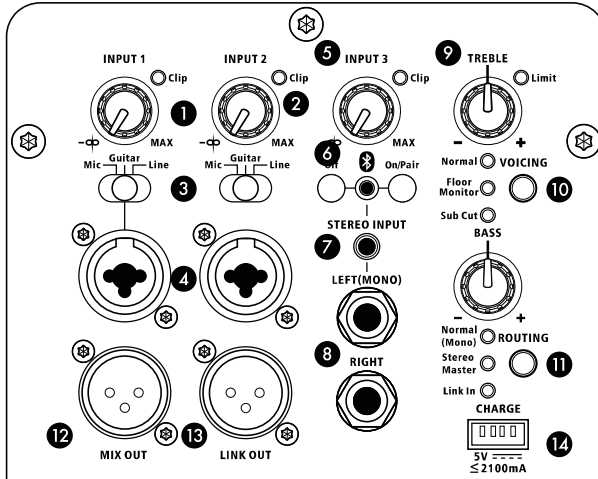

1 INPUT 1 AND 2 KNOBS

These knobs set the volume for the inputs below them.

2 CLIP LEDS

If a Clip LED lights, turn down that input knob, to avoid distorted sound.

3 MIC/GUITAR/LINE SWITCHES

Set these to match the type of source connected to the input below them:

- Mic: for microphones, or line level sources with low output volumes.
- Guitar: for acoustic guitar or guitar pedal board.
- Line: for line level sources.

4 INPUT 1 AND 2 INPUT JACKS

Connect XLR or 1/4-inch cables.

5 INPUT 3 KNOB

Sets the volume for all the inputs below, including Bluetooth® audio, Stereo (AUX) Input and line inputs.

6 BLUETOOTH® AUDIO INPUT

Press the On/Pair button to enable Bluetooth® and initiate pairing mode:

- To pair, look for VARI V2408 or VARI V2410 from your Bluetooth® audio source device.
- LED is lit solid when currently paired, blinking when available for pairing, and off if Bluetooth® has been disabled by a press of the Bluetooth® Off button.
- On/Pair button forces any currently connected Bluetooth® audio source to disconnect, and makes the speaker available for pairing.
- Off button disables Bluetooth®.
- Bluetooth On/Off status when turning power off will be remembered and restored when turning power on.

7 STEREO (AUX) INPUT

This input accepts a stereo or mono unbalanced audio input.

8 BALANCED LINE INPUTS

Balanced or unbalanced line level sources can be connected here.

9 BASS AND TREBLE KNOBS

Adjust the sound of your speaker.

10 VOICING

Pressing the button selects from the VOICINGS:

- Normal: for general use including music playback
- Floor Monitor: for floor monitor use, also may be helpful to avoid excessive bass from wall mounted speakers
- Sub Cut: for feeding a subwoofer, see (12) for details

11 ROUTING

- Normal (Mono): This speaker will output mono audio.
- Stereo Master: This speaker will operate as the master (left) speaker of a Smart Stereo pair. Use a mic cable to connect this speaker's LINK OUT to the INPUT 1 jack of a second speaker of the same type. All inputs should be connected to the first master speaker, which will also set the volume and tone of both speakers.
- Link In: Use this setting for the second speaker of a Smart Stereo pair. The audio from INPUT 1 will be routed directly to the power amp and speaker, with all other inputs and controls being ignored. This can also be used to accept mono audio from a previous speaker, with that previous speaker determining volume and tone.

12 MIX OUT JACK

- Outputs mono audio.
- When SUB CUT is selected, V2408/V2410 will then crossover the audio, to keep high frequencies for itself, and send low frequencies to the subwoofer.

13 LINK OUT JACK

- When ROUTING is set to Smart Stereo, this jack outputs right only audio to feed a second (right) speaker.
- When ROUTING is set to Normal (Mono), this jack outputs mono audio to feed a second speaker.

14 CHARGE JACK

Provides power for mobile devices.

15 Switches the power on and off.

16 If the speaker will not power on and you suspect its fuse may have blown, turn off the power switch, and open the fuse compartment using a small flat blade screwdriver. If metal strip in fuse is broken, replace with T4 AL 250V fuse (for 100-120 volt use), or T2 AL/250V fuse (for 220-240 volt use).

17 Connect power cable here.

18 Configures speaker for your territory's voltage. 100-120V is the standard in the USA.



HARBINGER

VS12 QUICK START GUIDE

SETTING UP / HELPFUL TIPS

- Position the VS12 in the desired location, and ensure the speaker is stable.
- Make sure the Power Switch is off.
- Make certain VOLUME knob is turned down.

MAKING THE CONNECTIONS

- See illustrations of common setups below.
- See facing page information regarding Level switch.

CROSSOVER FREQUENCY

- Turn the knob to select a frequency for the crossover.
- Recommended settings for common sizes of speakers are indicated.

POLARITY/LEVEL

- For initial use, Polarity should be set to NORMAL.
- For initial use, Level should be set to -10.

POWERING UP

- Turn on the power to any devices plugged into Input 1 or Input 2.
- Power ON the VS12.
- Slowly turn the VOLUME knob to 12 o'clock.
- If sources are connected to INPUT 1 or INPUT 2, slowly turn up the source volume to the desired level.

SIGNAL/LIMIT/LEVEL

- The SIGNAL LED will light green when input audio is detected.
- If the limiter is triggered, the LIMIT LED will turn RED, indicating the VOLUME knob should be turned down to avoid distorted sound.
- If the LIMIT LED comes on when the VOLUME knob is already at a low level, try setting the LEVEL switch to +4, and see information regarding LEVEL switch on facing page.

POLARITY/TIME ALIGNING DELAY

- Set up your system, and play audio through the system to evaluate the low frequency response.
- Try POLARITY set to NORMAL, then REVERSE, and leave the switch on the setting that provides more low frequency impact.
- Turn TIME ALIGNING DELAY knob until the maximum sub bass is heard.

LINKING MULTIPLE SUBWOOFERS

- If linking multiple subwoofers, plug the OUTPUT connection(s) of the first subwoofer to the INPUT connection(s) of second subwoofer, and continue the daisy chain to the next speaker.
- Switch Output Crossover of first subwoofer to Full-Range Output.
- Turn the power on in the order of the audio signal to prevent unwanted "pops". Turn the power off in the opposite order.

HOOK UP DIAGRAMS

VS12 in-line with audio source

Set VS12 crossover to match the size of speakers you are sending audio to, or as speaker manufacturer recommends

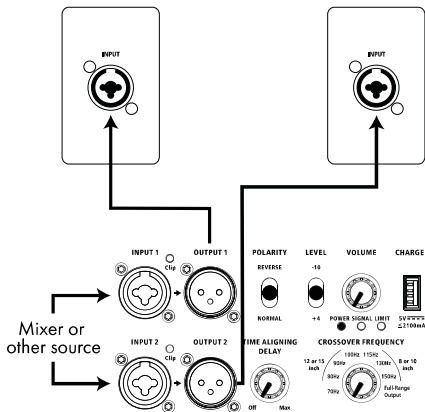

Feed-through from main speakers

Mixer or other source
If main speakers are VARIs, activate SUB CUT on them, and set VS12 crossover frequency to Full-Range Output

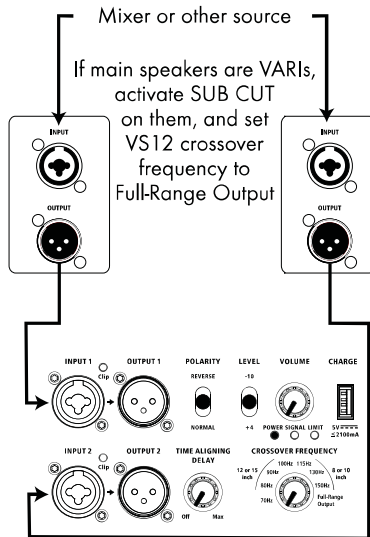

Feeding Harbinger Smart Stereo speakers such as V2408 or V2410

Set CROSSOVER FREQUENCY on VS12 to a frequency appropriate for your full-range speakers. You don't need to activate SUB CUT on your full-range speakers in this setup.

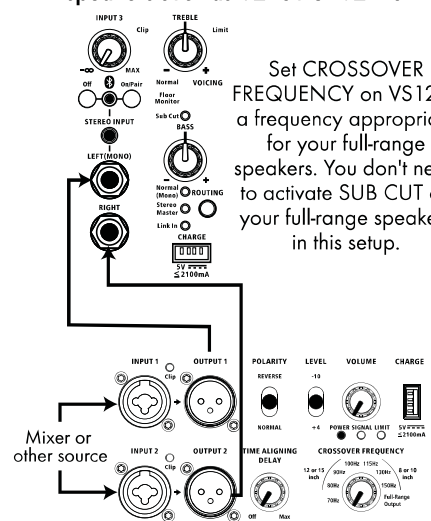

VS12 BACK PANEL

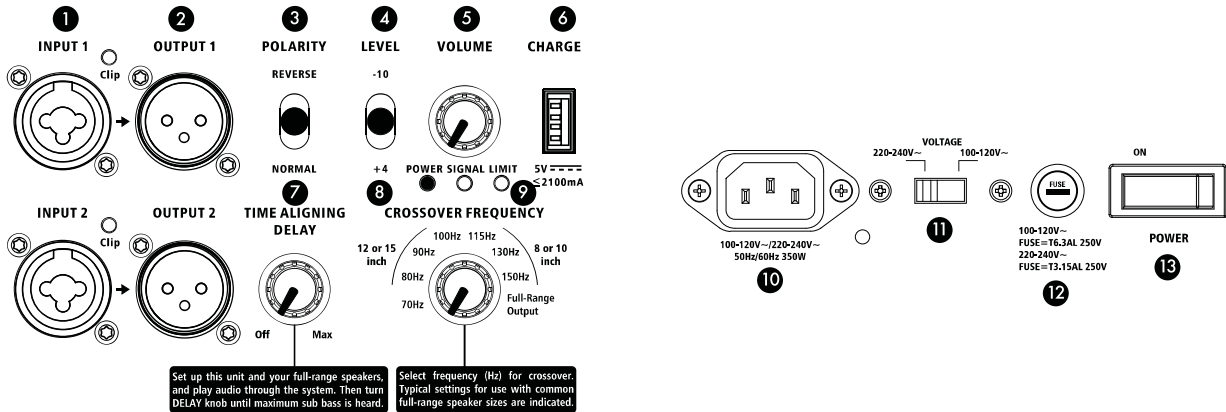

1 INPUTS 1 AND 2

These combo inputs are designed for either TRS or XLR balanced plugs at line level, either from a mixer or another speaker. The source can be either mono or stereo.

2 OUTPUTS 1 AND 2

These outputs feed through the signal(s) received from the input(s). If the crossover is not set to Full-Range Output, the output signal(s) will be altered by the crossover, which removes audio below the selected frequency, to allow your speakers that are fed by the sub to focus all their energy and fidelity on reproducing signals above the selected frequency.

3 POLARITY

This switch lets you reverse the polarity on the power amp when needed to match the polarity of speakers that may operate with opposite polarity to the VS12, or to account for a phase difference due to the physical distance between the sub and the full range speakers it is operating with. Once you get your VS12 operating as part of your full setup with your full-range speakers, try both settings of this switch, and leave the switch on the setting that provides the most low frequency impact.

4 LEVEL SWITCH

Set this switch to match the output level of your source:

- Use +4 when your source operates at +4dBu
- Use -10 when your source operates at -10dBV

If you notice that the rear panel LIMIT LED or front panel LED is easily or frequently lit red, even when you have the LEVEL knob turned to a low setting, set this switch to +4 rather than -10.

5 VOLUME KNOB

Sets volume of internal speaker.

6 CHARGE JACK

Provides power for mobile devices.

7 TIME ALIGNING DELAY

After you've set up your system including the VS12 subwoofer and your full-range speakers, and are playing audio through the system to evaluate the low frequency response, set the POLARITY switch for maximum low frequency impact, and then turn this knob until maximum sub bass is heard.

8 CROSSOVER

This knob controls the high precision DSP crossover. Select a value between 70 and 150Hz to have the audio below the selected frequency filtered out of the output signals. Select Full-Range Output to disable the crossover, and output the same full range audio received at the outputs. The audio sent to the internal power amp and speaker will also be filtered, so the subwoofer's speaker produces only audio below the crossover frequency. When Full-Range Output is chosen, the subwoofer's speaker limits its top frequency range to 150Hz.

9 LEDES

- POWER: this LED and front LED will light white when power is on.
- SIGNAL: this LED lights green when audio input is detected.
- LIMIT: this LED and front LED light red when limiter is activated due to very high level audio input, indicating the VOLUME knob should be turned down to avoid distorted sound. If the LIMIT LED comes on when the VOLUME knob is already at a low level, try setting the LEVEL switch to +4.

10 IEC POWER INPUT

Plug in the IEC AC power cable here.

11 VOLTAGE SELECTOR

Configures VS12 for your territory's voltage. 100-120V is the standard in the USA.

12 FUSE CARRIER

If the speaker will not power on and you suspect its fuse may have blown, turn off the power switch, and open the fuse compartment using a small flat blade screwdriver. If metal strip in fuse is broken, replace with T6.3 AL 250V fuse for 100-120 volt operation, or T3.15 AL 250V for 220-240 volt operation.

13 POWER SWITCH

Turns the VARI subwoofer on or off.



HARBINGER

V2408/V2410 SPECIFICATIONS

HARBINGER VARI Series		V2408
Electronics	Voicing	Selectable VOICING (Normal, Floor Monitor, Sub Cut) and Bass and Treble knobs all control the internal DSP to customize the sound
	Limiter	Transparent, dynamic DSP limiter for ideal sound quality and system protection at maximum volume
	Smart Stereo	A pair of speakers can be connected for unified volume and tone control from the first master speaker, with optimal distribution of mono and audio signals between both speakers
	Input 1	XLR and 1/4-inch TRS balanced/unbalanced compatible audio input with Mic/Guitar/Line Switch and Input Gain Control
	Input 2	XLR and 1/4-inch TRS balanced/unbalanced compatible audio input with Mic/Guitar/Line Switch and Input Gain Control
	Input 3	Stereo Line: Left/mono and right 1/4-inch TRS balanced/unbalanced compatible audio line inputs Aux: 1/8-inch mini TRS unbalanced input (-10dB) Bluetooth® Audio: with On/Pair and Off buttons plus LED
	Link In	XLR balanced +4dBv audio input
	Mix Out	XLR balanced +4dBv audio output
	Power Output	400 Watts Peak, 100 Watts RMS
	Bass EQ Knob	+/-12dB Shelf, 65Hz
	Treble EQ Knob	+/-12dB Shelf at 6.5kHz
	Volume	Volume control per channel
	Charging	USB standard 5V charging up to 2.1 Amps
	Power Input	110-120V, 220-240V, 50-60Hz, 100w power draw
Other Features	Removable AC Power Cord	
	Front LED indicates power (white) and limiter (red), rear LEDs indicate clipping (red) per input	
Cabinet/Drivers	Type	8" 2-way vented design
	Frequency Response	65-20KHz
	Max SPL@1M	118dB
	HF Driver	Compression Driver, 8 Ohm
	LF Driver	8" Driver, 4 Ohm
	Cabinet	Polypropolene, with rubber surfaced feet
	Grille	1.2mm steel
	Suspension Points	V2408 Is Not Designed For Suspension
	Pole Mount	35mm stand pole with M6 screw
Dimensions and Weights	Product Dimensions	D: 10.1" x W: 10.25" x H: 17.25"
	Packaging Size	D: 13.4" x W: 13.4" x H: 20.1"
	Net Weight	15.5 pounds
	Gross Weight	19 pounds



HARBINGER

VS12 SPECIFICATIONS

HARBINGER VARI Series	VS12		
Electronics	Inputs	2 XLR and 1/4-inch TRS balanced/unbalanced compatible line level audio inputs	
	Outputs	2 XLR line outputs	
	Power Output	400 watts RMS @ 8 Ohms / 1000 watts Peak	
	Volume	Main volume control	
	Charging	USB standard 5V charging up to 2.1 Amps	
	Power Input	110-120V, 220-240V, 50-60Hz, 350w power draw	
	Other Features		Class D+ switching power design
			Front LED indicates power (white) and limiter (red)
			Rear panel power (white), signal (green), and limiter (red) LEDs
			High precision digital crossover, adjustable from 70-150Hz, or full-range output
		Time Aligning Delay, to easily optimize bass response in any setup	
Cabinet/Driver		Polarity switch, to select Normal or Reverse	
		Transparent, dynamic DSP limiter	
	Type	Active vented subwoofer	
	Frequency Response	35-150Hz	
	Max Output SPL@1M	130dB	
	Impedance	8 Ohm	
	Driver	12" subwoofer	
	Cabinet	Plywood with black Polyurea painted finish	
	Grille	1.5mm steel	
Pole	35mm stand pole		
Dimensions and Weights	Features	Rubber feet	
	Unit Size	D: 18.1" x W: 14.6" x H: 17.2" (including feet)	
	Package Size	D: 21.7" x W: 18.1" x H: 20.1"	
	Unit Weight	46.2 pounds	
	Package Weight	52.8 pounds	



HARBINGER

IMPORTANT SAFETY INSTRUCTIONS

Please keep this instruction manual for future reference and for the duration of owning the Harbinger powered loudspeaker or subwoofer. Please carefully read and understand the instructions inside this owner's manual before attempting to operate your new powered loudspeaker or subwoofer so it is powered loudspeaker or subwoofer.

This instruction manual includes essential safety information regarding the use and maintenance of the amplifier. Take special care to heed all warning symbols and signs inside this manual and those printed on the amplifier on the back of the loudspeaker.

WARNING

TO PREVENT FIRE OR SHOCK HAZARD, DO NOT EXPOSE THE AMPLIFIER TO WATER/MOISTURE, NOR SHOULD YOU OPERATE THE AMPLIFIER NEAR ANY WATER SOURCE.

The exclamation point triangular symbol is intended to alert the user to the presence of important operating and maintenance(servicing) instructions in the user manual accompanying the Amplifier.

The lightning flash with an arrow triangular symbol is intended to alert the user to the presence of non-insulated "dangerous voltage" within the product's enclosure, and may be of sufficient magnitude to constitute a risk of electric shock.

WARNING

Handle the power supply cord with care.

Do not damage or deform it as it may cause electric shock or malfunction when used. Hold the plug attachment when removing from wall outlet. Do not pull on the power cord.

IMPORTANT SAFETY PRECAUTIONS

1. Read these instructions.
2. Keep these instructions.
3. Heed all warnings.
4. Follow all Instructions.
5. Do not use this apparatus near water.
6. Clean only with dry cloth.
7. Do not block any ventilation openings. Install in accordance with the manufacturer's instructions. DO NOT turn on the VARI amplifier module before connecting all other external devices.
8. Do not install near any heat sources such as radiators, heat registers, stoves, or other apparatus (including amplifiers) that produce heat.
9. Do not defeat the safety purpose of the polarized or grounding-type plug. A polarized plug has two blades with one wider than the other. A grounding type plug has two blades and a third grounding prong. The wide blade or the third prong is provided for your safety. If the provided plug does not fit into your outlet, consult an electrician for replacement of the obsolete outlet.
10. Protect the power cord from being walked on or pinched particularly at plugs, convenience receptacles, and the point where they exit from the apparatus.
11. Only use attachment/accessories specified by the manufacturer.
12. Use only the cart, stand, tripod, bracket or table specified by the manufacturer, or sold with the apparatus. When a cart is used, use caution when moving the cart/apparatus combination to avoid injury from tip-over. 
13. Unplug this apparatus during lightning storms or when unused for long periods of time.



14. Refer all servicing to qualified service personnel. Servicing is required when the apparatus has been damaged in any way, such as power-supply cord or plug is damaged, liquid has been spilled or objects have fallen into the apparatus, the apparatus has been exposed to rain or moisture, does not operate normally, or has been dropped.
15. POWER SOURCES - This product should be operated only from the type of power source indicated on the rating label. If you are not sure of the type of power supply to your home, consult your product dealer or local power company.
16. WALL OR CEILING MOUNTING - The product should never be mounted to a wall or ceiling.
17. Where the mains plug or an appliance coupler is used as the disconnect device, the disconnect device shall remain readily operable.
18. OBJECT AND LIQUID ENTRY - Care should be taken so that objects do not fall and liquids are not spilled into the enclosure through openings.
19. Water and Moisture: This product should be kept away from direct contact with liquids. The apparatus shall not be exposed to dripping or splashing and that no objects filled with liquids, such as vases, shall be placed on the apparatus.
20. Keep the speaker system out of extended or intense direct sun light.
21. No containers filled with any type of liquid should be placed on or near the speaker system.
22. SERVICING - The user should not attempt any service to the speaker and/or amplifier beyond that described in the operating instructions. All other servicing should be referred to qualified service personnel.
23. VENTILATION - Slots and openings in the amplifier are provided for ventilation and to ensure reliable operation of the product and to protect it from overheating. These openings must not be blocked or covered. The openings should never be blocked by placing the product on a bed, sofa, rug, or other similar surface. This product should not be placed in a built-in installation such as a bookcase or rack.
24. Protective earthing terminal: The apparatus should be connected to a main socket outlet with a protective earthing connection. 
25. ACCESSORIES - Do not place this product on an unstable cart, stand, tripod, bracket, or table. The product may fall, causing serious injury to a child or adult, and serious damage to the product. Use only with a cart, stand, tripod, bracket, or table recommended by the manufacturer, or sold with the product.
26. When moving or not using the appliance, secure the power cord (e.g., wrap it with a cable tie). Be careful not to damage the power cord. Before using it again, make sure the power cord has not been damaged. If the power cord has been damaged at all, bring the unit and cord to a qualified service technician for repair or replacement as specified by the manufacturer.
27. LIGHTNING - For added protection during a lightning storm, or when it is left unattended and unused for long periods of time, unplug it from the wall outlet. This will prevent damage to the product due to lightning and power-line surges.
28. REPLACEMENT PARTS - When replacement parts are required, be sure the service technician has used replacement parts specified by the manufacturer or have the same characteristics as the original part. Unauthorized substitutions may result in fire, electric shock, or other hazards.



HARBINGER

IMPORTANT SAFETY INSTRUCTIONS

To prevent electric shock, do not use a polarized plug with an extension cord, receptacle or other outlet unless the blades can be fully inserted to prevent blade exposure.

	CAUTION RISK OF ELECTRIC SHOCK DO NOT OPEN	AVIS RISQUE DE CHOC ELECTRIQUE NE PAS OUVRIR	
<p>CAUTION: To reduce the risk of electric shock, do not remove chassis. No user-serviceable parts inside. Refer servicing to qualified service personnel.</p> <p>AVERTISSEMENT: Pour réduire les risques d'incendie et d'électrocution, ne pas exposer ce matériel à la pluie ou à l'humidité.</p>			



THIS SYMBOL IS INTENDED TO ALERT THE USER TO THE PRESENCE OF IMPORTANT OPERATING AND MAINTENANCE (SERVICING) INSTRUCTIONS IN THE LITERATURE ACCOMPANYING THE UNIT.



APPARATUS SHALL NOT BE EXPOSED TO DRIPPING OR SPLASHING AND THAT NO OBJECTS FILLED WITH LIQUIDS, SUCH AS VASES, SHALL BE PLACED ON THE APPARATUS.

HEARING DAMAGE AND PROLONGED EXPOSURE TO EXCESSIVE SPLs

Harbinger powered loudspeakers and subwoofers are capable of producing extremely loud volume levels that can cause permanent hearing damage to performers, production crews or the audience. Hearing protection is recommended during long-term exposure to high SPLs (sound pressure levels).

Remember, if it hurts, it is definitely too loud! Long term exposure to high SPLs first causes temporary threshold shifts; limiting your ability to hear the actual loudness and exercise good judgment. Repeated long term exposure to high SPLs will cause permanent hearing loss.

Please note the recommended exposure limits in the accompanying table. More information about these limits is available on the US government Occupational Safety and Health (OSHA) website at: www.osha.gov.

Permissible Noise Exposures (1)

Duration per day, hours	Sound level dBA slow response
8	90
6	92
4	95
3	97
2	100
1.5	102
1	105
0.5	110
0.25 or less	115



HARBINGER

WARRANTY/CUSTOMER SUPPORT

2 YEAR HARBINGER LIMITED WARRANTY

Harbinger provides, to the original purchaser, a two (2) year limited warranty on materials and workmanship on all Harbinger cabinets, loudspeaker and amplifier components from the date of purchase.

For warranty support, please visit our website at www.HarbingerProAudio.com, or contact our Support Team at **888-286-1809** for assistance. Harbinger will repair or replace the unit at Harbinger's discretion.

This warranty does not cover service or parts to repair damage caused by neglect, abuse, normal wear and tear and cosmetic appearance to the cabinetry not directly attributed to defects in materials or workmanship. Also excluded from coverage are damages caused directly or indirectly due to any service, repair(s), or modifications of the cabinet, which has not been authorized or approved by Harbinger. This two (2) year warranty does not cover service or parts to repair damage caused by accident, disaster, misuse, abuse, burnt voice-coils, over-powering, negligence, inadequate packing or inadequate shipping procedures.

The sole and exclusive remedy of the foregoing limited warranty shall be limited to the repair or replacement of any defective or non-conforming component. All warranties including, but not limited to, the express warranty and the implied warranties of merchantability and fitness for a particular purpose are limited to the two (2) year warranty period. Some states do not allow limitation on how long an implied warranty lasts, so the above limitation may not apply to you. There are no express warranties beyond those stated here. In the event that applicable law does not allow the limitation of the duration of the implied warranties to the warranty period, then the duration of the implied warranties shall be limited to as long as is provided by applicable law. No warranties apply after that period.

Retailer and manufacturer shall not be liable for damages based upon inconvenience, loss of use of product, loss of time, interrupted operation or commercial loss or any other incidental or consequential damages including but not limited to lost profits, downtime, goodwill, damage to or replacement of equipment and property, and any costs of recovering, reprogramming, or reproducing any program or data stored in equipment that is used with Harbinger products. This guarantee gives you specific legal rights; you may have other legal rights, which vary from state to state.

Harbinger
P.O. Box 5111, Thousand Oaks, CA 91359-5111

All trademarks and registered trademarks mentioned herein are recognized as the property of their respective holders.

2111-20441853

HAVE QUESTIONS?

**MISSING
—OR—
DAMAGED
PARTS?**

**—HAVE—
ASSEMBLY
QUESTIONS?**

OR VISIT OUR WEBSITE AT: HARBINGERPROAUDIO.COM

FCC WARNING

This device complies with part 15 of the FCC Rules. Operation is subject to the following two conditions: (1) this device may not cause harmful interference, and (2) this device must accept any interference received, including interference that may cause undesired operation.

Any changes or modifications not expressly approved by the party responsible for compliance could void the user's authority to operate the equipment.

NOTE: This equipment has been tested and found to comply with the limits for a Class B digital device, pursuant to Part 15 of the FCC Rules. These limits are designed to provide reasonable protection against harmful interference in a residential installation. This equipment generates, uses and can radiate radio frequency energy and, if not installed and used in accordance with the instructions, may cause harmful interference to radio communications. However, there is no guarantee that interference will not occur in a particular installation. If this equipment does cause harmful interference to radio or television reception, which can be determined by turning the equipment off and on, the user is encouraged to try to correct the interference by one or more of the following measures:

- Reorient or relocate the receiving antenna.
- Increase the separation between the equipment and receiver.
- Connect the equipment into an outlet on a circuit different from that to which the receiver is connected.
- Consult the dealer or an experienced radio/TV technician for help.

To maintain compliance with FCC's RF Exposure guidelines, This equipment should be installed and operated with minimum distance between 20cm the radiator your body: Use only the supplied antenna.