

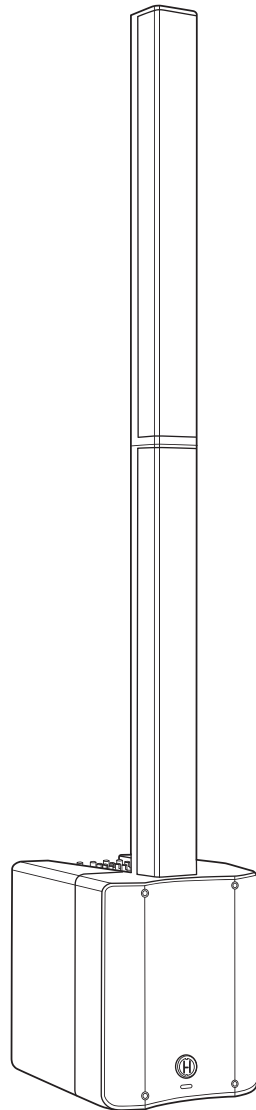

HARBINGER

MLS1000
OWNER'S MANUAL



MUV
SERIES



HARBINGER

TABLE OF CONTENTS

Quick Start Guide	4-5
Bluetooth Troubleshooting	5
Top Panel	6
Back Panel	7
Specifications	8
Safety	9-10
Warranty/Customer Support	11

WELCOME

The Harbinger MLS1000 Compact Portable Line Array combines FX, sound optimizing DSP, and versatile inputs, outputs and mixing capabilities in an easy-to-move and fast-to-setup package, making it simple to fill a room with premium sound.

MLS1000 Compact Portable Line Array with mixing and FX

- 6 x 2.75" column speakers and a single 10" subwoofer providing 150° wide and floor-to-ceiling sound dispersion
- Bluetooth® audio input, dual mic/guitar/line inputs, dedicated balanced stereo line input and aux input – all available simultaneously
- DSP providing selectable Voicings, easily adjustable Bass and Treble on each channel, Reverb and Chorus effects, as well as a transparent and dynamic limiter for extremely accurate, high fidelity sound
- Innovative Smart Stereo capability, with easy volume and tone control for a pair of MLS1000s from the master unit
- Fast and simple setup with 2 column segments that slide into place on top of the subwoofer/mixer base – less than 10 minutes from car to downbeat!
- A subwoofer slipcover and a shoulder bag for the columns are included, enabling easy, one-handed transport, and safe storage



HARBINGER

QUICK START GUIDE: SINGLE MLS1000

ASSEMBLY

- Slide columns on to base unit as shown below:
 - Slide bottom column onto base unit
 - Slide top column onto bottom column

DISASSEMBLY

- When disassembling, remove upper column first, then lower.
 - Slide top column off of bottom column
 - Slide bottom column off of base unit

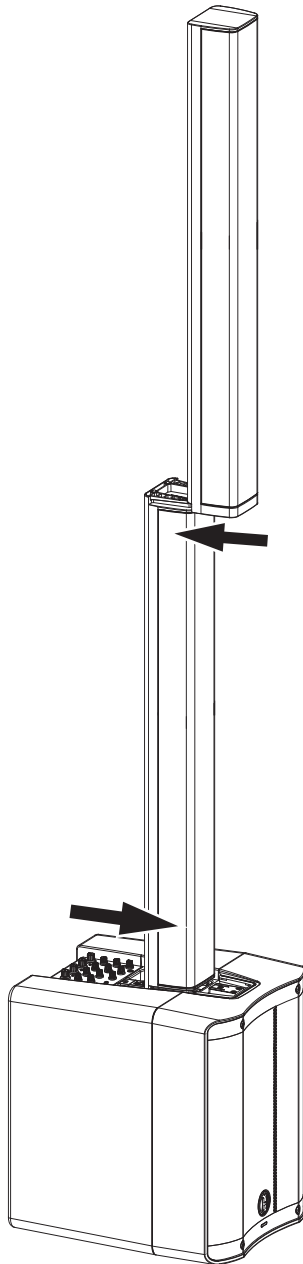

SET UP

- Position MLS1000 in the desired location, and ensure the unit is stable.
- Make sure the Power Switch is off.
- Turn INPUT 1, 2, 3 and 4 knobs to minimum.
- Turn BASS and TREBLE knobs to center/straight up.
- Turn REVERB and CHORUS knobs to minimum/off.

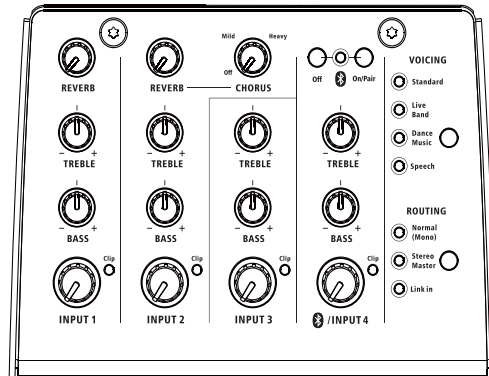

CONNECTIONS

- Connect sources to INPUT 1, 2, 3 and 4 jacks as desired. (All these input jacks can be used at once, along with Bluetooth® audio input.)

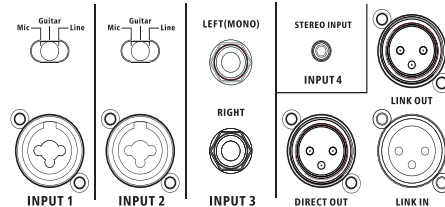

CHECK CONTROLS

- Check that Mono (Normal) LED of the ROUTING function is lit.
- Check that INPUT 1 and INPUT 2 switches match sources:
 - Mic for microphones, Guitar for acoustic guitar or pedalboard output, Line for mixers, keyboards and other electronics.

POWERING UP

- Power on any devices connected to input jacks.
- Turn up the output volume of all sources.
- Turn INPUT 1, 2, 3 and 4 knobs to desired levels.

BLUETOOTH® AUDIO INPUT

- From your Bluetooth audio source device, look for MLS1000 and select it.
- See next page for Bluetooth Troubleshooting in case of difficulty.

SET VOICING

- Press top panel VOICING button to choose the best DSP Voicing for your use.

APPLYING REVERB AND CHORUS FX

- Turn up the REVERB knob for INPUT 1 or 2, to add virtual room ambiance to that input source.
- Input 2 is the best input for acoustic guitars, thanks to a CHORUS effect in addition to REVERB. Simply turn up the chorus knob to apply increasing levels of a swirling chorus effect, with either a MILD or HEAVY character.



HARBINGER

SMART STEREO WITH MLS1000

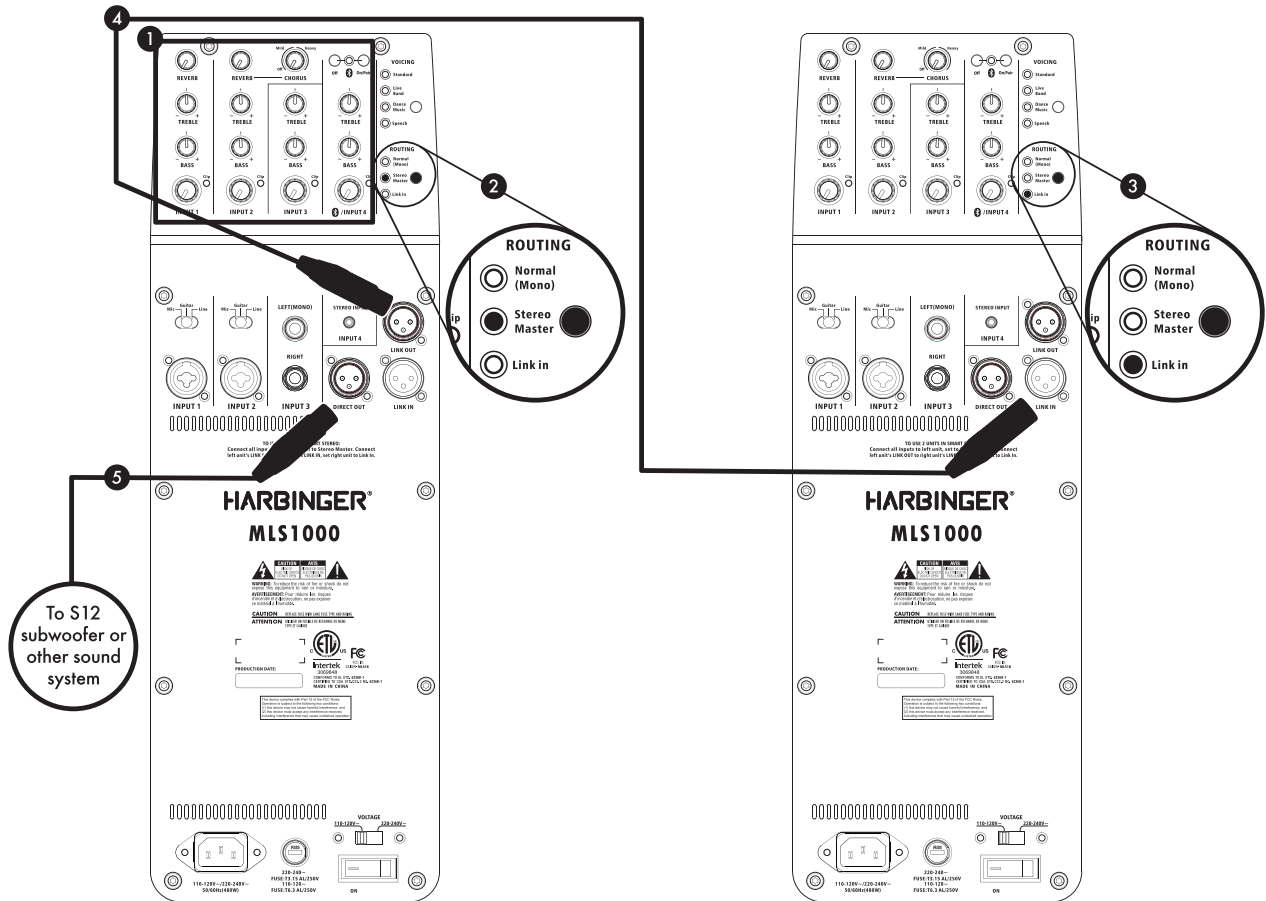

A pair of MLS1000 units can operate together as a Smart Stereo system, giving you control of the sound and volume of both units from the first master unit, and optimally distributing all audio inputs to both units for rich stereo sound.

INPUTS 1 and 2 are routed mono to both MLS1000 units, while INPUT 3 and INPUT 4 are routed in split stereo to the MLS1000's.

- 1 Connect all inputs and make all sound settings on the first (left) unit only. The second (right) unit's inputs and controls are all disabled when it is set to Link In.
- 2 Set the ROUTING function on first unit to Stereo Master.
- 3 Set the ROUTING function on second unit to Link In.
- 4 Connect an XLR (microphone) cable from the first unit's LINK OUT jack to the second unit's LINK IN jack.
- 5 OUTPUT jack of the first unit can optionally be connected to S12 or other subwoofer, or to send audio to another sound system.

BLUETOOTH® TROUBLESHOOTING

These steps should resolve any Bluetooth® trouble you may encounter:

- Power off the MLS1000 and leave it off

- On your Apple iOS device
 1. Open Settings app, select Bluetooth®
 2. If MLS1000 is listed under MY DEVICES, touch info button, tap to Forget This Device
 3. Turn off Bluetooth®, wait 10 seconds, turn on Bluetooth®
- On your Android device
 1. Open Settings, select Bluetooth®
 2. If MLS1000 is listed under Paired Devices, touch gear icon, and tap to Unpair
 3. Turn off Bluetooth®, wait 10 seconds, turn on Bluetooth®

- Then power on your MLS1000, and Bluetooth LED should flash
- You should now be able to connect to MLS1000 via Bluetooth®

MLS1000 OWNER'S MANUAL

TOP PANEL

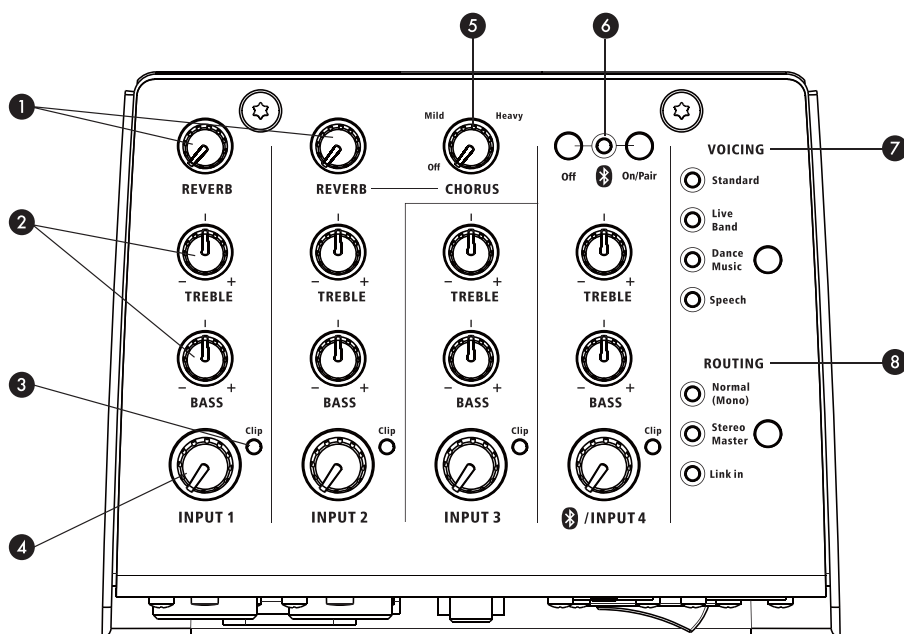

TOP PANEL

1 REVERB

Reverb is available on both INPUT 1 and INPUT 2. Once sound is running on either Input, turn up the Reverb knob for that Input Channel to apply more or less of the effect.

2 BASS AND TREBLE KNOBS

These knobs let you reduce or boost the low and high frequency range of any input.

3 CLIP LEDS

If a Clip LED lights, turn down that input knob, to avoid distorted sound.

4 INPUT VOLUME KNOBS

The knobs for each INPUT set the volume for the inputs below them. The INPUT 4 knob sets the volume for Bluetooth as well as the STEREO INPUT for INPUT 4.

5 CHORUS

Chorus is available for INPUT 2 only, and makes this the ideal input for an acoustic guitar. Turn the Chorus knob up to apply an increasing amount of CHORUS, with MILD or HEAVY character.

6 BLUETOOTH AND STEREO AUDIO INPUT

Press the On/Pair button to enable Bluetooth and initiate pairing mode

- To pair, look for MLS1000 from your Bluetooth audio source device.
- LED is lit solid when currently paired, blinking when available for pairing, and off if Bluetooth has been disabled by a press of the Bluetooth Off button.
- On/Pair button forces any currently connected Bluetooth audio source to disconnect, and makes the MLS1000 available for pairing.
- Off button disables Bluetooth. (Bluetooth will be re-enabled if you press the On/Pair button.)

7 VOICING

Pressing the button selects from the available voicings (DSP tunings) for different applications:

- Standard: for general use including music playback.
- Live Band: for live band main PA usage.
- Dance Music: for enhanced low and high end impact when playing bass-heavy or electronic music.
- Speech: for public speaking, may also be helpful for solo performers who are singing along with acoustic guitar.

8 ROUTING

- Normal (Mono): This unit will output mono audio
- Stereo Master: This unit will operate as the master (left) unit of a Smart Stereo pair. Use a mic cable to connect this unit's LINK OUT to the LINK IN jack of a second MLS1000. All inputs should be connected to the first master unit, which will also set the volume and tone of both units.
- Link In: Use this setting for the second unit of a Smart Stereo pair. The audio from LINK IN will be routed directly to the power amplifiers and speakers, with all other inputs and controls being ignored. This can also be used to accept mono audio from a previous unit, with that previous unit determining volume and tone.



HARBINGER

BACK PANEL

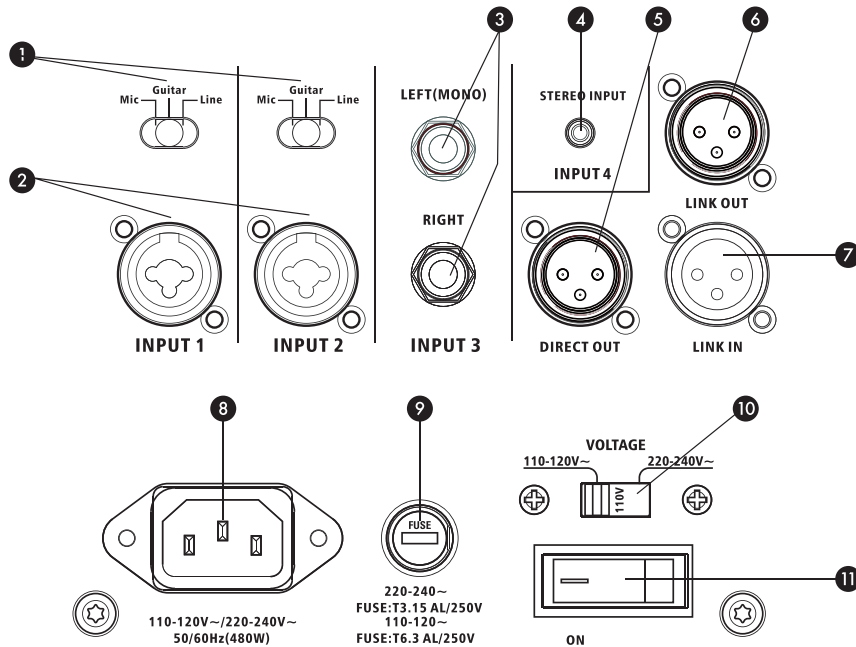

BACK PANEL

1 MIC/GUITAR/LINE SWITCHES

Set these to match the type of source connected to the input below them.

2 INPUT 1 AND INPUT 2 JACKS

Connect XLR or 1/4" cables.

3 BALANCED LINE INPUTS

Balanced or unbalanced line level sources can be connected here.

4 STEREO INPUT (INPUT 4)

This input accepts a stereo or mono unbalanced audio input.

5 DIRECT OUT

A mono output for passing the MLS1000 sound to other sound systems.

6 LINK OUT

- When ROUTING is set to Stereo Master, this jack outputs right only audio to feed a second (right) MLS1000.
- When ROUTING is set to Normal (Mono), this jack outputs mono audio to feed a second unit.

7 LINK IN

- Activated only when Routing is set to Link In
- Routes directly to the power amplifiers/speakers, bypassing all other inputs, controls, and settings.

8 POWER INLET

Connect power cable here.

9 FUSE

If the unit will not power on and you suspect its fuse may have blown, turn off the power switch, and open the fuse compartment using a small flat blade screwdriver. If metal strip in fuse is broken, replace with T3.15 AL/250V fuse (for 110-120 volt use), or T6.3 AL/250V fuse (for 220-240 volt use).

10 VOLTAGE SELECTOR

Configures unit for your territory's voltage. 110-120V is the standard in the USA

11 POWER SWITCH

Switches the power on and off.



HARBINGER

MLS1000 SPECIFICATIONS

HARBINGER		MLS1000
Amplifier	DSP	Selectable Voicing (Standard, Live Band, Dance Music and Speech), Bass and Treble knobs, Reverb knobs, and Chorus knob all control the internal DSP to customize the sound
	Limiter	Transparent, dynamic DSP limiter for ideal sound quality and system protection at maximum volume
	Smart Stereo	A pair of MLS1000's can be connected for unified volume and tone control from the first master unit, with optimal distribution of mono and stereo audio signals between both units
	Input 1	XLR and 1/4-inch TRS balanced/unbalanced compatible audio input with Mic/Guitar/Line Switch and Input Gain Control
	Input 2	XLR and 1/4-inch TRS balanced/unbalanced compatible audio input with Mic/Guitar/Line Switch and Input Gain Control
	Input 3	Left/mono and right 1/4-inch TRS balanced/unbalanced compatible audio line inputs
	Input 4	Bluetooth® Audio: with On/Pair and Off buttons plus LED Aux: 1/8-inch mini TRS unbalanced input (-10dB)
	Link In Jack	XLR balanced +4dBv audio input
	Link Out Jack	XLR balanced +4dBv audio output
	Direct Out Jack	XLR balanced +4dBv audio output
	Power Output	500 Watts RMS, 1000 Watts Peak
	Bass EQ Knob	+/- 12dB Shelf, @ 65Hz
	Treble EQ Knob	+/- 12dB Shelf @ 6.6kHz
	Volume	Volume control per channel
	Power Input	110-240V, 220-240V, 50/60 Hz, 480W
	Other Features	Removable AC Power Cord
Front LED indicates power (white) and limiter (red), rear LED's indicate clipping (red) per input		
Speaker	Type	Vertical Column Portable Powered Speaker Array with Sub
	Frequency Response	40-20K Hz
	Max SPL@1M	123dB
	HF Driver	6x 2.75" Drivers
	LF Driver	1x 10" Driver
	Cabinet	Polypropylene, with rubber surfaced handles and feet
	Grille	1.2mm steel
Dimensions and Weights	Product Dimensions	Dimensions (Sub + Columns Assembled): D: 16 x W: 13.4 x H: 79.5 Weight (Sub with Slip Cover): 30 pounds Weight (Columns in Carry Bag): 13 pounds
	Packaged Dimensions	Box A (Sub): 18.5" x 15.8" x 18.9" Box B (Column): 34.25" x 15" x 5.7"
	Gross Weight	Box A (Sub): 33 pounds Box B (Column): 15 pounds



HARBINGER

IMPORTANT SAFETY INSTRUCTIONS

Please keep this instruction manual for future reference and for the duration of owning this Harbinger unit. Please carefully read and understand the instructions inside this owner's manual before attempting to operate your new portable line array.

This instruction manual includes essential safety information regarding the use and maintenance of the amplifier. Take special care to heed all warning symbols and signs inside this manual and those printed on the amplifier on the back of the loudspeaker.

WARNING

TO PREVENT FIRE OR SHOCK HAZARD, DO NOT EXPOSE THE AMPLIFIER TO WATER/MOISTURE, NOR SHOULD YOU OPERATE THE AMPLIFIER NEAR ANY WATER SOURCE.

The exclamation point triangular symbol is intended to alert the user to the presence of important operating and maintenance(servicing) instructions in the user manual accompanying the Amplifier.

The lightning flash with an arrow triangular symbol is intended to alert the user to the presence of non-insulated "dangerous voltage" within the product's enclosure, and may be of sufficient magnitude to constitute a risk of electric shock.

WARNING

Handle the power supply cord with care.

Do not damage or deform it as it may cause electric shock or malfunction when used. Hold the plug attachment when removing from wall outlet. Do not pull on the power cord.

IMPORTANT SAFETY PRECAUTIONS

1. Read these instructions.
2. Keep these instructions.
3. Heed all warnings.
4. Follow all Instructions.
5. Do not use this apparatus near water.
6. Clean only with dry cloth.
7. Do not block any ventilation openings. Install in accordance with the manufacturer's instructions. DO NOT turn on the VARI amplifier module before connecting all other external devices.
8. Do not install near any heat sources such as radiators, heat registers, stoves, or other apparatus (including amplifiers) that produce heat.
9. Do not defeat the safety purpose of the polarized or grounding-type plug. A polarized plug has two blades with one wider than the other. A grounding type plug has two blades and a third grounding prong. The wide blade or the third prong is provided for your safety. If the provided plug does not fit into your outlet, consult an electrician for replacement of the obsolete outlet.
10. Protect the power cord from being walked on or pinched particularly at plugs, convenience receptacles, and the point where they exit from the apparatus.
11. Only use attachment/accessories specified by the manufacturer.
12. Use only the cart, stand, tripod, bracket or table specified by the manufacturer, or sold with the apparatus. When a cart is used, use caution when moving the cart/apparatus combination to avoid injury from tip-over. 
13. Unplug this apparatus during lightning storms or when unused for long periods of time.



14. Refer all servicing to qualified service personnel. Servicing is required when the apparatus has been damaged in any way, such as power-supply cord or plug is damaged, liquid has been spilled or objects have fallen into the apparatus, the apparatus has been exposed to rain or moisture, does not operate normally, or has been dropped.
15. POWER SOURCES - This product should be operated only from the type of power source indicated on the rating label. If you are not sure of the type of power supply to your home, consult your product dealer or local power company.
16. WALL OR CEILING MOUNTING - The product should never be mounted to a wall or ceiling.
17. Where the mains plug or an appliance coupler is used as the disconnect device, the disconnect device shall remain readily operable.
18. OBJECT AND LIQUID ENTRY - Care should be taken so that objects do not fall and liquids are not spilled into the enclosure through openings.
19. Water and Moisture: This product should be kept away from direct contact with liquids. The apparatus shall not be exposed to dripping or splashing and that no objects filled with liquids, such as vases, shall be placed on the apparatus.
20. Keep the speaker system out of extended or intense direct sun light.
21. No containers filled with any type of liquid should be placed on or near the speaker system.
22. SERVICING - The user should not attempt any service to the speaker and/or amplifier beyond that described in the operating instructions. All other servicing should be referred to qualified service personnel.
23. VENTILATION - Slots and openings in the amplifier are provided for ventilation and to ensure reliable operation of the product and to protect it from overheating. These openings must not be blocked or covered. The openings should never be blocked by placing the product on a bed, sofa, rug, or other similar surface. This product should not be placed in a built-in installation such as a bookcase or rack.
24. Protective earthing terminal: The apparatus should be connected to a main socket outlet with a protective earthing connection. 
25. ACCESSORIES - Do not place this product on an unstable cart, stand, tripod, bracket, or table. The product may fall, causing serious injury to a child or adult, and serious damage to the product. Use only with a cart, stand, tripod, bracket, or table recommended by the manufacturer, or sold with the product.
26. When moving or not using the appliance, secure the power cord (e.g., wrap it with a cable tie). Be careful not to damage the power cord. Before using it again, make sure the power cord has not been damaged. If the power cord has been damaged at all, bring the unit and cord to a qualified service technician for repair or replacement as specified by the manufacturer.
27. LIGHTNING - For added protection during a lightning storm, or when it is left unattended and unused for long periods of time, unplug it from the wall outlet. This will prevent damage to the product due to lightning and power-line surges.
28. REPLACEMENT PARTS - When replacement parts are required, be sure the service technician has used replacement parts specified by the manufacturer or have the same characteristics as the original part. Unauthorized substitutions may result in fire, electric shock, or other hazards.



HARBINGER

IMPORTANT SAFETY INSTRUCTIONS

To prevent electric shock, do not use a polarized plug with an extension cord, receptacle or other outlet unless the blades can be fully inserted to prevent blade exposure.

	CAUTION RISK OF ELECTRIC SHOCK DO NOT OPEN	AVIS RISQUE DE CHOC ELECTRIQUE NE PAS OUVRIR	
<p>CAUTION: To reduce the risk of electric shock, do not remove chassis. No user-serviceable parts inside. Refer servicing to qualified service personnel.</p> <p>AVERTISSEMENT: Pour réduire les risques d'incendie et d'électrocution, ne pas exposer ce matériel à la pluie ou à l'humidité.</p>			



THIS SYMBOL IS INTENDED TO ALERT THE USER TO THE PRESENCE OF IMPORTANT OPERATING AND MAINTENANCE (SERVICING) INSTRUCTIONS IN THE LITERATURE ACCOMPANYING THE UNIT.



APPARATUS SHALL NOT BE EXPOSED TO DRIPPING OR SPLASHING AND THAT NO OBJECTS FILLED WITH LIQUIDS, SUCH AS VASES, SHALL BE PLACED ON THE APPARATUS.

FCC Radiation Exposure Statement

The device has been evaluated to meet general RF exposure requirement. The device can be used in mobile(min20cm) exposure condition.

HEARING DAMAGE AND PROLONGED EXPOSURE TO EXCESSIVE SPLs

Harbinger sound systems are capable of producing extremely loud volume levels that can cause permanent hearing damage to performers, production crews or the audience. Hearing protection is recommended during long-term exposure to high SPLs (sound pressure levels).

Remember, if it hurts, it is definitely too loud! Long term exposure to high SPLs first causes temporary threshold shifts; limiting your ability to hear the actual loudness and exercise good judgment. Repeated long term exposure to high SPLs will cause permanent hearing loss.

Please note the recommended exposure limits in the accompanying table. More information about these limits is available on the US government Occupational Safety and Health (OSHA) website at: www.osha.gov.

Permissible Noise Exposures (1)

Duration per day, hours	Sound level dBA slow response
8	90
6	92
4	95
3	97
2	100
1.5	102
1	105
0.5	110
0.25 or less	115

FCC STATEMENTS

1. Caution: Changes or modifications to this unit not expressly approved by the party responsible for compliance could void the user's authority to operate the equipment.
2. Note: This equipment has been tested and found to comply with the limits for a Class B digital device, pursuant to Part 15 of the FCC Rules. These limits are designed to provide reasonable protection against harmful interference in a residential installation. This equipment generate, uses, and can radiate radio frequency energy and, in not installed and used in accordance with the instructions, may cause harmful interference to radio communications. However, there is no guarantee that interference will not occur in a particular installation. If this equipment does cause harmful

interference to radio or television reception, which can be determined by turning the equipment off and on, the user is encouraged to try to correct the interference by one or more of the following measures:

- Reorient or relocate the receiving antenna
- Increase the separation between the equipment and receiver
- Connect the equipment into an outlet on a circuit different from that to which the receiver is connected
- Consult the dealer or an experienced radio/TV technician for help

WARRANTY/CUSTOMER SUPPORT

2 YEAR HARBINGER LIMITED WARRANTY

Harbinger provides, to the original purchaser, a two (2) year limited warranty on materials and workmanship on all Harbinger cabinets, loudspeaker and amplifier components from the date of purchase.

For warranty support, please visit our website at www.HarbingerProAudio.com, or contact our Support Team at **888-286-1809** for assistance. Harbinger will repair or replace the unit at Harbinger's discretion.

This warranty does not cover service or parts to repair damage caused by neglect, abuse, normal wear and tear and cosmetic appearance to the cabinetry not directly attributed to defects in materials or workmanship. Also excluded from coverage are damages caused directly or indirectly due to any service, repair(s), or modifications of the cabinet, which has not been authorized or approved by Harbinger. This two (2) year warranty does not cover service or parts to repair damage caused by accident, disaster, misuse, abuse, burnt voice-coils, over-powering, negligence, inadequate packing or inadequate shipping procedures.

The sole and exclusive remedy of the foregoing limited warranty shall be limited to the repair or replacement of any defective or non-conforming component. All warranties including, but not limited to, the express warranty and the implied warranties of merchantability and fitness for a particular purpose are limited to the two (2) year warranty period. Some states do not allow limitation on how long an implied warranty lasts, so the above limitation may not apply to you. There are no express warranties beyond those stated here. In the event that applicable law does not allow the limitation of the duration of the implied warranties to the warranty period, then the duration of the implied warranties shall be limited to as long as is provided by applicable law. No warranties apply after that period.

Retailer and manufacturer shall not be liable for damages based upon inconvenience, loss of use of product, loss of time, interrupted operation or commercial loss or any other incidental or consequential damages including but not limited to lost profits, downtime, goodwill, damage to or replacement of equipment and property, and any costs of recovering, reprogramming, or reproducing any program or data stored in equipment that is used with Harbinger products. This guarantee gives you specific legal rights; you may have other legal rights, which vary from state to state.

Harbinger
P.O. Box 5111, Thousand Oaks, CA 91359-5111

All trademarks and registered trademarks mentioned herein are recognized as the property of their respective holders.

2101-20441853



HARBINGER

**MISSING
—OR—
DAMAGED
PARTS?**

HAVE QUESTIONS?

**CALL
888-286-1809
TOLL FREE**

**—HAVE—
ASSEMBLY
QUESTIONS?**

OR VISIT OUR WEBSITE AT: HARBINGERPROAUDIO.COM