

FCC ID: 2AIPR-PBX1012

Product Name: AMPLIFIER SPEAKER

Model No.: PBX-1012



Please read the manual carefully and keep it for future reference.



The lightning flash with arrowhead symbol, within an equilateral triangle, is intended to alert the user to the presence of not insulated dangerous voltages within the product's enclosure that may be of sufficient magnitude to constitute a risk of electric shock to persons.



The exclamation point within an equilateral triangle is intended to alert the user to the presence of important operating and maintenance (servicing) instructions in the literature accompanying the appliance.

CAUTION:

1. Do not place any recipients filled with liquids, such as glasses or vases, on top of or directly next to the appliance. They could fall over, causing water to enter the appliance. Never pour out liquids over the appliance. Do not place small objects, such as coins or paper clips, on the appliance since they could fall inside the appliance and cause fire or a shock hazard! If any liquid or objects enter the appliance, pull immediately the mains plug out of the socket and contact a specialist.
2. Only pull the mains plug out of the socket by the intended gripping surface. Do not pull it by the cable
3. Never plug the mains plug in or out with damp or wet hands
4. Electrical appliances must be kept out of the reach of children. Be particularly careful if children are present. Children are not aware of the hazards involved in handling electrical appliances improperly. Children could attempt to poke objects into the appliance. There is a life-threatening danger of electrocution.
5. Never place the appliance on an unstable or mobile surface. Persons could be injured or the appliance damaged by it falling down.
6. All persons involved in operating, installing and servicing the appliance and putting it into service must be trained and qualified accordingly and observe these operating instructions.
7. Defective mains cables may only be replaced by specialists. Danger of shock hazard!
8. If you are not sure about the correct connection or if questions arise which are not answered by the operating instructions, please do not hesitate to contact support or a specialist of your choice. Consult a specialist if you are in doubt about the operating principle or the safety of the product.
9. Please unplug the adaptor and switch the unit off if you don't use it for a long time, to avoid damage due to voltage surges.
10. No naked flame sources such as lighted candles should be placed on the apparatus.
11. A warning that batteries (battery pack or batteries installed) shall not be exposed to excessive heat such as sunshine, fire or the like.
12. Where the MAINS plug or an appliance coupler is used as the disconnect device, the disconnect device shall remain readily operable.

Introduction:

This speaker can be used with any audio output device such as personal computer, DVD\VCD\LD\TV\MMP3\FM radio, Bluetooth, etc.

The speaker has a built-in lead acid battery offering more stability and capacity. It can work 2-3.5 hours after

being fully charged.

The FM function requires an external FM antenna (if you want to receive FM channels, please switch to FM mode and connect the supplied jack lead)

Remote Control

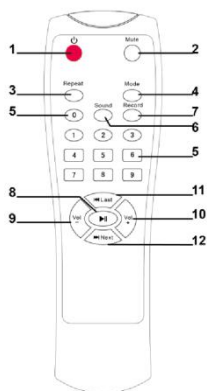

Use of the Remote Control

1. Power On/Standby
2. Mute
3. Repeat Key (Single Repeat/Repeat All)
4. Mode Key (Select between AUX/USB/SD/BLUETOOTH/FM modes)
5. 0-9 Keys
6. Sound Mode Key(Select between ROCK,POP or JAZZ)
7. Record key (Press to start recording. Press again to stop recording)
8. Play/Pause (The sound will be muted when paused)
9. Volume -
10. Volume +
11. Previous song
12. Next song

Please operate the remote control within a distance of 6m and 30° between the remote and the appliance.

Aim the remote at the sensor.Remove all obstacles between the remote and the sensor.

The remote control might not work properly if the sensor is exposed to strong sunshine.

If the remote control doesn't work properly,please check the batteries.

Top Panel Description

- 1.AUX INPUT(connect the supplied lead for FM reception)
- 2.Main Volume control
- 3.TREBLE
- 4.BASS
- 5.ECHO
- 6.MIC.VOL
- 7.MIC.EQ
- 8.MIC INPUT(TO INSERT WIRED MIC)
- 9.USB/SD CARD INPUT
- 10.STANDBY
- 11.MODE(SWITCH TO USB/SD/BLUETOOTH/AUX-IN)
- 12.PLAY(PLAY/PAUSE MUSIC)
- 13.NEXT(NEXT SONG)
- 14.PREV(PREVOUS SONG)
- 15.LED ON/OFF(TURN ON/OFF LED)
- 16.POWER SWITCH(POWER ON/OFF)
- 17.FM ANTENNA
- 18.CHARGING INPUT JACK(AC INPUT):
Charging led is on during charging process

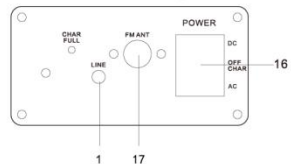
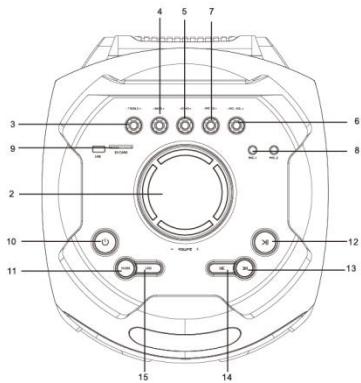

Wireless Microphone

1. Open battery cover and insert a battery according to the + and - markings inside the compartment.
2. Turn on the microphone. If the power indicator doesn't flash nor lights up steadily check if the battery is charged and if it has been inserted with the correct polarity.
3. Adjust the volume of the wireless microphone when you sing.
4. If the power indicator flashes when you switch on the wireless microphone, the battery is low and needs to be replaced as soon as possible.

Notes:

- 1.The effective range of the wireless microphone is 15m.Do not use over that range.
- 2.Do not use two microphones working on the same frequency or crosstalk and interference will occur.
- 3.If you use more wireless microphones at the same time,they must be set to different frequencies and should be kept away at least at 50m.
- 4.Don't put the device too close to a DVD/CD/VCD player as they have strong frequencies and might affect the microphone.

Built-in recording function

- 1.You can record both the microphone sound and B channel sound and DJ sound simultaneously.USB A must be plugged in to enter the USB flash drive, because all the audio files will be saved to USB A USB flash drive
- 2.Plug in a USB A and press the record key to go to record function.The screen shows 00:01 to indicate that recording has started.If you enter a recording during USB A playback,the playing music will be recorded file automatically in this folder.
- 3.The USB,Bluetooth,FM and AUX functions of channel A and channel B operate in the same way,and the sound of A and B can be output at the same time.





USB Operation

Keep the speaker away from high temperatures,strong magnetic fields and equipment that could generate interference.If the speaker stops working,switch it off and on again,or unplug USB/SD/MMC card and re-plug it.The speaker should be back to normal status.



Supported music formats:MP3,WMA

- 1.USB port:plug and play
- 2.Mode key:press to cycle through external AUX sound source/USB/FM/BLUETOOTH
- 3.Play/pause:Press to play,press to pause,press again to resume play.
- 4.Previous/Next:During play press once to go back to the beginning of the track or to the next track.
- 5.Repeat:During play press once to repeat the current song,press twice to repeat all songs.

BLUETOOTH OPERATION

- 1.Turn on the unit and press the MODE button on unit or on the remote control to select the Bluetooth function.The display shows "BT"
- 2.In Bluetooth mode,the "BT"  on display will start flashing,the system automatically enters search mode.
- 3.Activate the Bluetooth feature on the external device to be paired.
- 4.Initiate a search for devices.The device shows up as"QFX PBX-1012".
- 5.Press the PLAY button on the unit or the  key on remote control,to start playing and the buttons
- 6.NEXT and PREV,or the keys  and  for the selection of songs.

FM RADIO FUNCTION

- 1.Turn on the unit and press repeatedly the MODE key on unit, or the MODE on remote control and select FM function (the display will show the frequency).
2. Press the PLAY button on the unit or the key  on remote control to activate the auto memory (the radio starts an automatic search for available radio stations and saves them automatically).
The station's number stored depends on the radio signal in your area. During the search,press PLAY button on the remote control to stop searching.
3. Use the NEXT and PREV, or the keys  and  on the remote control to listen to the various radio stations saved in memory.
- 4.To change to a preset station, use the number keys on the remote control.For example, to call up the station number 12,first press 1 and then 2.

Charging Procedure

It takes 6-8 hours to fully charge the battery, Unplug the adaptor after charging is completed. Don't overcharge the battery! During the charge, the charge indicator will flash. Once the battery has been fully charged, the indicator stops flashing.

Note: Please charge as soon as the battery runs low. If you don't use the unit for a longer period of time, recharge the battery regularly in order to avoid damage to the battery.

Trouble shooting

If a problem occurs, follow the steps in the table below. If problem still can't be solved, please contact your retailer.

Problem	Possible cause	Solution
No sound when power is turned on	<ol style="list-style-type: none"> 1. The power cord is not connected 2. Faulty mains outlet 3. No input source 4. Volume set to minimum 	<ol style="list-style-type: none"> 1. Connect the power cord 2. Use an outlet that receives power 3. Connect an input source 4. Set the volume to an appropriate level
Distorted sound	<ol style="list-style-type: none"> 1. Master volume is set too high 2. Damaged speaker 	<ol style="list-style-type: none"> 1. Reduce the volume 2. Check if the speaker is damaged
No sound from Karaoke	<ol style="list-style-type: none"> 1. Microphone plug is not firmly inserted 2. The microphone is not switched on 3. Microphone volume set to the minimum 4. Battery in wireless mic is exhausted 	<ol style="list-style-type: none"> 1. Insert the mic firmly into the socket 2. Switch the microphone on 3. Increase the microphone volume 4. Replace the batteries
No sound from MP3 source	<ol style="list-style-type: none"> 1. Un supported file format 2. Illegal copy 3. USB source not properly inserted 	<ol style="list-style-type: none"> 1. Change into MP3 format 2. Insert the USB source properly

Specification

Output Power.....80W
 Frequency range.....60HZ-20KHZ
 S/N Ratio.....70DB
 Sensitivity.....500mV+-50mV
 Input Voltage.....AC110V-240V 50/60Hz+-10%

FCC STATEMENT :

This device complies with Part 15 of the FCC Rules. Operation is subject to the following two conditions:

- (1) This device may not cause harmful interference, and
- (2) This device must accept any interference received, including interference that may cause undesired operation.

Warning: Changes or modifications not expressly approved by the party responsible for compliance could void the user's authority to operate the equipment.

NOTE: This equipment has been tested and found to comply with the limits for a Class B digital device, pursuant to Part 15 of the FCC Rules. These limits are designed to provide reasonable protection against harmful interference in a residential installation. This equipment generates uses and can radiate radio frequency energy and, if not installed and used in accordance with the instructions, may cause harmful interference to radio communications. However, there is no guarantee that interference will not occur in a particular installation. If this equipment does cause harmful interference to radio or television reception, which can be determined by turning the equipment off and on, the user is encouraged to try to correct the interference by one or more of the following measures:

- Reorient or relocate the receiving antenna.

- Increase the separation between the equipment and receiver.

- Connect the equipment into an outlet on a circuit different from that to which the receiver is connected.

- Consult the dealer or an experienced radio/TV technician for help.

FCC Radiation Exposure Statement:

This equipment complies with FCC radiation exposure limits set forth for an uncontrolled environment. This equipment should be installed and operated with minimum distance 20cm between the radiator & your body.