

# FCC TEST REPORT

For

Guangzhou Diamond Electric Appliance Co., Ltd.

AMPLIFIER SPEAKER

Model No.: PBX-1011, QFX PBX-1011, GD-PS1002, GD-PS1001, GD-PS1002, GD-PS1003,  
GD-PS1006, GD-PS1007, GD-PS1008

Prepared For : Guangzhou Diamond Electric Appliance Co., Ltd.  
Address : No43, Oversea Chinese Science and Technology Industry Park, Huashan  
Town Huadu District, Guangzhou, China

Prepared By : Shenzhen Anbotek Compliance Laboratory Limited  
Address : 1/F, Building D, Sogood Science and Technology Park, Sanwei  
community, Hangcheng Street, Bao'an District, Shenzhen, Guangdong,  
China.518102  
Tel: (86) 755-26066440 Fax: (86) 755-26014772

Report Number : SZAWW180613001-01  
Date of Test : Jun. 13~22, 2018  
Date of Report : Jun. 22, 2018

# Contents

1. General Information.....	5
1.1. Client Information.....	5
1.2. Description of Device (EUT).....	5
1.3. Auxiliary Equipment Used During Test.....	5
1.4. Description of Test Modes.....	6
1.5. List of channels.....	7
1.6. Description Of Test Setup.....	8
1.7. Test Equipment List.....	9
1.8. Measurement Uncertainty.....	10
1.9. Description of Test Facility.....	10
2. Summary of Test Results.....	11
3. Conducted Emission Test.....	12
3.1. Test Standard and Limit.....	12
3.2. Test Setup.....	12
3.3. Test Procedure.....	12
3.4. Test Data.....	12
4. Radiation Spurious Emission and Band Edge.....	17
4.1. Test Standard and Limit.....	17
4.2. Test Setup.....	17
4.3. Test Procedure.....	18
4.4. Test Data.....	19
5. Maximum Peak Output Power Test.....	26
5.1. Test Standard and Limit.....	26
5.2. Test Setup.....	26
5.3. Test Procedure.....	26
5.4. Test Data.....	26
6. 20DB Occupy Bandwidth Test.....	30
6.1. Test Standard.....	30
6.2. Test Setup.....	30
6.3. Test Procedure.....	30
6.4. Test Data.....	30
7. Carrier Frequency Separation Test.....	34
7.1. Test Standard and Limit.....	34
7.2. Test Setup.....	34
7.3. Test Procedure.....	34
7.4. Test Data.....	34
8. Number of Hopping Channel Test.....	38
8.1. Test Standard and Limit.....	38
8.2. Test Setup.....	38
8.3. Test Procedure.....	38
8.4. Test Data.....	38
9. Dwell Time Test.....	40

---

9.1. Test Standard and Limit.....	40
9.2. Test Setup.....	40
9.3. Test Procedure.....	40
9.4. Test Data.....	40
10. 100kHz Bandwidth of Frequency Band Edge Requirement.....	44
10.1. Test Standard and Limit.....	44
10.2. Test Setup.....	44
10.3. Test Procedure.....	44
10.4. Test Data.....	44
11. Antenna Requirement.....	49
11.1. Test Standard and Requirement.....	49
11.2. Antenna Connected Construction.....	49
APPENDIX I -- TEST SETUP PHOTOGRAPH.....	50
APPENDIX II -- EXTERNAL PHOTOGRAPH.....	52
APPENDIX III -- INTERNAL PHOTOGRAPH.....	56



# TEST REPORT

Applicant : Guangzhou Diamond Electric Appliance Co., Ltd.  
Manufacturer : Guangzhou Diamond Electric Appliance Co., Ltd.  
Product Name : AMPLIFIER SPEAKER  
Model No. : PBX-1011, QFX PBX-1011, GD-PS1002, GD-PS1001, GD-PS1002, GD-PS1003, GD-PS1006, GD-PS1007, GD-PS1008  
Trade Mark : QFX  
Rating(s) : Input: AC 110~240V, 50/60Hz, 1.5A  
**Test Standard(s) : FCC Part15 Subpart C 2017, Section 15.247**  
**Test Method(s) : ANSI C63.10: 2013**

The device described above is tested by Shenzhen Anbotek Compliance Laboratory Limited to determine the maximum emission levels emanating from the device and the severe levels of the device can endure and its performance criterion. The measurement results are contained in this test report and Shenzhen Anbotek Compliance Laboratory Limited is assumed full of responsibility for the accuracy and completeness of these measurements. Also, this report shows that the EUT (Equipment Under Test) is technically compliant with the FCC Part 15 Subpart C requirements.

This report applies to above tested sample only and shall not be reproduced in part without written approval of Shenzhen Anbotek Compliance Laboratory Limited.

Date of Test Jun. 13~22, 2018

Prepared by



(Engineer / Oliay Yang)

Reviewer



(Supervisor / Calvin Liu)

Approved & Authorized Signer

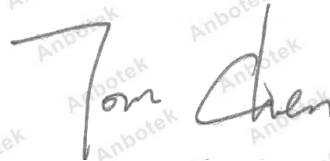

(Manager / Tom Chen)

## 1. General Information

### 1.1. Client Information

Applicant	:	Guangzhou Diamond Electric Appliance Co., Ltd.
Address	:	No43, Oversea Chinese Science and Technology Industry Park, Huashan Town Huadu District, Guangzhou, China
Manufacturer	:	Guangzhou Diamond Electric Appliance Co., Ltd.
Address	:	No43, Oversea Chinese Science and Technology Industry Park, Huashan Town Huadu District, Guangzhou, China

### 1.2. Description of Device (EUT)

Product Name	:	AMPLIFIER SPEAKER	
Model No.	:	PBX-1011, QFX PBX-1011, GD-PS1002, GD-PS1001, GD-PS1002, GD-PS1003, GD-PS1006, GD-PS1007, GD-PS1008 (Note: All samples are the same except the size and appearance, so we prepare "PBX-1011" for test only.)	
Trade Mark	:	QFX	
Test Power Supply	:	AC 240V, 60Hz/ AC 120V, 60Hz	
Product Description	:	Operation Frequency:	2402MHz~2480MHz
		Transfer Rate:	1/2/3 Mbits/s
		Number of Channel:	79 Channels
		Modulation Type:	GFSK, $\pi/4$ -DQPSK, 8-DPSK
		Antenna Type:	PCB Antenna
		Antenna Gain(Peak):	0 dBi
<b>Remark:</b> 1) For a more detailed features description, please refer to the manufacturer's specifications or the User's Manual.			

### 1.3. Auxiliary Equipment Used During Test

N/A	:	
-----	---	--

### 1.4. Description of Test Modes

To investigate the maximum EMI emission characteristics generated from EUT, the test system was pre-scanning tested based on the consideration of following EUT operation mode or test configuration mode which possibly have effect on EMI emission level. Each of these EUT operation mode(s) or test configuration mode(s) mentioned above was evaluated respectively.

Pretest Mode	Description
Mode 1	CH00
Mode 2	CH39
Mode 3	CH78
Mode 4	Keeping TX+ Charging Mode

For Conducted Emission	
Final Test Mode	Description
Mode 4	Keeping TX+ Charging Mode

For Radiated Emission	
Final Test Mode	Description
Mode 1	CH00
Mode 2	CH39
Mode 3	CH78
Mode 4	Keeping TX+ Charging Mode

Note:

- (1) The measurements are performed at the highest, middle, lowest available channels.
- (2) The data rate was set in 1Mbps for radiated emission due to the highest RF output power.



### 1.5. List of channels

Channel	Freq. (MHz)	Channel	Freq. (MHz)	Channel	Freq. (MHz)	Channel	Freq. (MHz)	Channel	Freq. (MHz)
00	2402	17	2419	34	2436	51	2453	68	2470
01	2403	18	2420	35	2437	52	2454	69	2471
02	2404	19	2421	36	2438	53	2455	70	2472
03	2405	20	2422	37	2439	54	2456	71	2473
04	2406	21	2423	38	2440	55	2457	72	2474
05	2407	22	2424	39	2441	56	2458	73	2475
05	2408	23	2425	40	2442	57	2459	74	2476
07	2409	24	2426	41	2443	58	2460	75	2477
08	2410	25	2427	42	2444	59	2461	76	2478
09	2411	26	2428	43	2445	60	2462	77	2479
10	2412	27	2429	44	2446	61	2463	78	2480
11	2413	28	2430	45	2447	62	2464		
12	2414	29	2431	46	2448	63	2465		
13	2415	30	2432	47	2449	64	2466		
14	2416	31	2433	48	2450	65	2467		
15	2417	32	2434	49	2451	66	2468		
16	2418	33	2435	50	2452	67	2469		

Note:

1. The engineering test program was provided and the EUT was programmed to be in continuously transmitting mode.
2. EUT built-in battery-powered, fully-charged battery use of the test battery.

### 1.6. Description Of Test Setup

CE

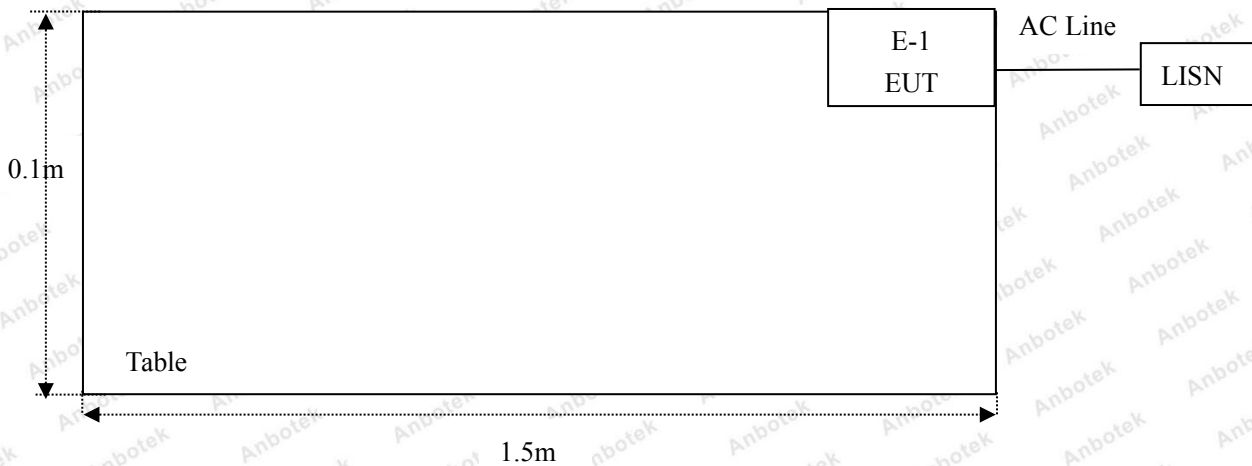

RE

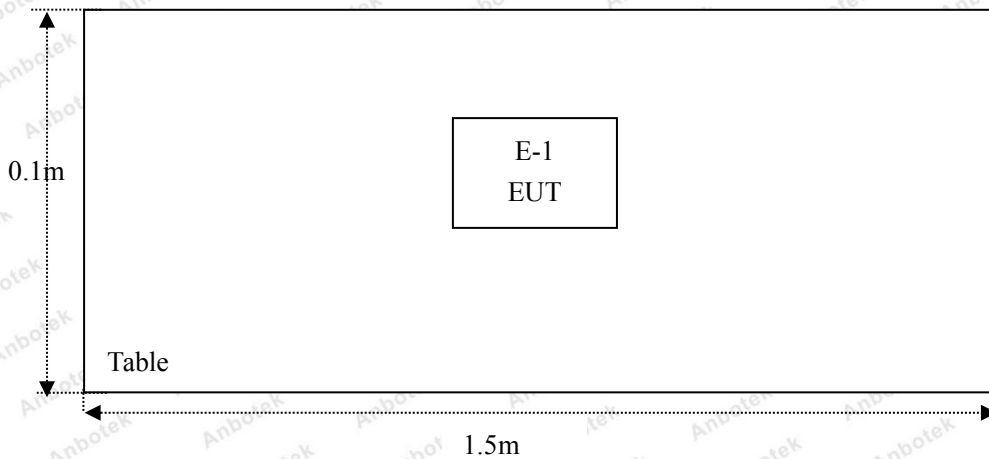



### 1.7. Test Equipment List

Item	Equipment	Manufacturer	Model No.	Serial No.	Last Cal.	Cal. Interval
1.	L.I.S.N. Artificial Mains Network	Rohde & Schwarz	ENV216	100055	Nov. 17, 2017	1 Year
2.	EMI Test Receiver	Rohde & Schwarz	ESCI	100627	Nov. 17, 2017	1 Year
3.	RF Switching Unit	Compliance Direction	RSU-M2	38303	Nov. 17, 2017	1 Year
4.	Spectrum Analysis	Agilent	E4407B	US39390582	Nov. 17, 2017	1 Year
5.	Spectrum Analysis	Agilent	N9038A	MY53227295	Nov. 17, 2017	1 Year
6.	Preamplifier	SKET Electronic	BK1G18G30D	KD17503	Nov. 17, 2017	1 Year
7.	EMI Test Receiver	Rohde & Schwarz	ESCI	100627	Nov. 17, 2017	1 Year
8.	Double Ridged Horn Antenna	Instruments corporation	GTH-0118	351600	Nov. 20, 2017	1 Year
9.	Bilog Broadband Antenna	Schwarzbeck	VULB9163	VULB 9163-289	Nov. 20, 2017	1 Year
10.	Loop Antenna	Schwarzbeck	HFH2-Z2	100047	Nov. 17, 2017	1 Year
11.	Horn Antenna	Schwarzbeck	BBHA9170	9170-375	Nov. 17, 2017	1 Year
12.	Pre-amplifier	SONOMA	310N	186860	Nov. 17, 2017	1 Year
13.	EMI Test Software EZ-EMC	SHURPLE	N/A	N/A	N/A	N/A
14.	RF Test Control System	YIHENG	YH3000	2017430	Nov. 18, 2017	1 Year
15.	Power Sensor	DAER	RPR3006W	15I00041SN045	Nov. 17, 2017	1 Year
16.	Power Sensor	DAER	RPR3006W	15I00041SN046	Nov. 17, 2017	1 Year
17.	MXA Spectrum Analysis	Agilent	N9020A	MY51170037	Nov. 18, 2017	1 Year
18.	MXG RF Vector Signal Generator	Agilent	N5182A	MY48180656	Nov. 18, 2017	1 Year
19.	Signal Generator	Agilent	E4421B	MY41000743	Nov. 18, 2017	1 Year
20.	DC Power Supply	LW	TPR-6410D	349315	Nov. 01, 2017	1 Year
21.	Constant Temperature Humidity Chamber	Sertep	ZJ-HWHS80B	ZJ-17042804	Nov. 01, 2017	1 Year

### 1.8. Measurement Uncertainty

Radiation Uncertainty	:	Ur = 3.9 dB (Horizontal)
		Ur = 3.8 dB (Vertical)
Conduction Uncertainty	:	Uc = 3.4 dB

### 1.9. Description of Test Facility

The test facility is recognized, certified, or accredited by the following organizations:

#### FCC-Registration No.: 184111

Shenzhen Anbotek Compliance Laboratory Limited, EMC Laboratory has been registered and fully described in a report filed with the (FCC) Federal Communications Commission. The acceptance letter from the FCC is maintained in our files. Registration No. 184111, July 31, 2017.

#### ISED-Registration No.: 8058A-1

Shenzhen Anbotek Compliance Laboratory Limited, EMC Laboratory has been registered and fully described in a report filed with the (ISED) Innovation, Science and Economic Development Canada. The acceptance letter from the ISED is maintained in our files. Registration 8058A-1, June 13, 2016.

#### Test Location

All Emissions tests were performed at Shenzhen Anbotek Compliance Laboratory Limited, at 1/F, Building D, Sogood Science and Technology Park, Sanwei community, Hangcheng Street, Bao'an District, Shenzhen, Guangdong, China.518102

## 2. Summary of Test Results

Standard Section	Test Item	Result
15.203/15.247(c)	Antenna Requirement	PASS
15.207	Conducted Emission	PASS
15.205/15.209	Spurious Emission	PASS
15.247(b)(1)	Conducted Peak Output Power	PASS
15.247(a)(1)	20dB Occupied Bandwidth	PASS
15.247(a)(1)	Carrier Frequencies Separation	PASS
15.247(a)(1)	Hopping Channel Number	PASS
15.247(a)(1)	Dwell Time	PASS
15.247(d)	Band Edge	PASS
<b>Remark:</b> "N/A" is an abbreviation for Not Applicable.		



### 3. Conducted Emission Test

#### 3.1. Test Standard and Limit

Test Standard	FCC Part15 Section 15.207		
Test Limit	Frequency	Maximum RF Line Voltage (dBuV)	
		Quasi-peak Level	Average Level
	150kHz~500kHz	66 ~ 56 *	56 ~ 46 *
	500kHz~5MHz	56	46
	5MHz~30MHz	60	50
<b>Remark:</b> (1) *Decreasing linearly with logarithm of the frequency. (2) The lower limit shall apply at the transition frequency.			

#### 3.2. Test Setup

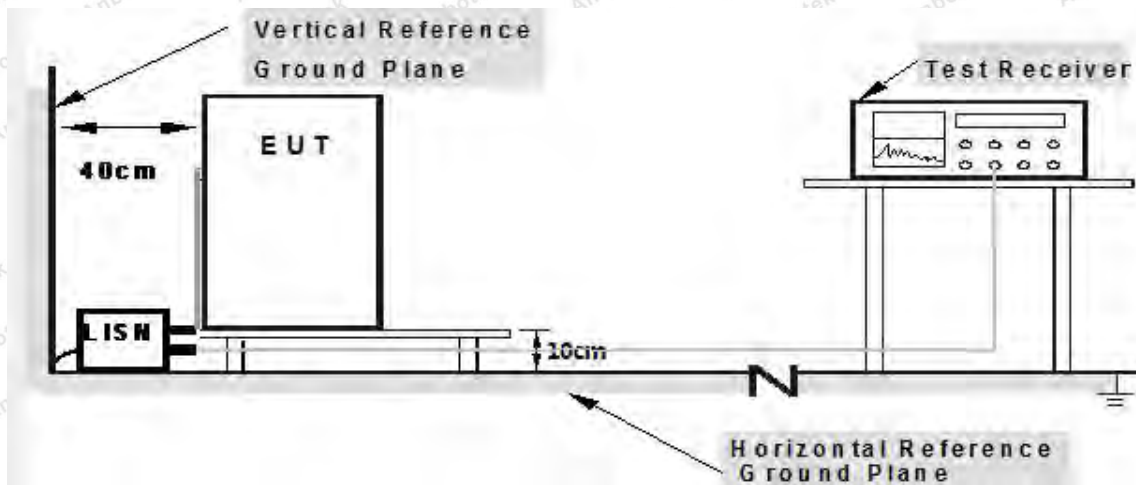

**Note: 1. Support units were connected to second LISN.**  
**2. Both of LISNs (AMN) are 80 cm from EUT and at least 80 from other units and other metal planes**

#### 3.3. Test Procedure

The EUT system is connected to the power mains through a line impedance stabilization network (L.I.S.N.). This provides a 50ohm coupling impedance for the EUT system. Please refer the block diagram of the test setup and photographs. Both sides of AC line are checked to find out the maximum conducted emission. In order to find the maximum emission levels, the relative positions of equipment and all of the interface cables shall be changed according to FCC ANSI C63.10-2013 on Conducted Emission Measurement.

The bandwidth of test receiver (ESCI) set at 9kHz.

The frequency range from 150kHz to 30MHz is checked.

#### 3.4. Test Data

Please to see the following pages.

**Conducted Emission Test Data**

Test Site: 1# Shielded Room  
 Operating Condition: Keeping TX+ Charging Mode  
 Test Specification: AC 240V, 60Hz  
 Comment: Live Line  
 Tem.: 22.3°C Hum.: 57%

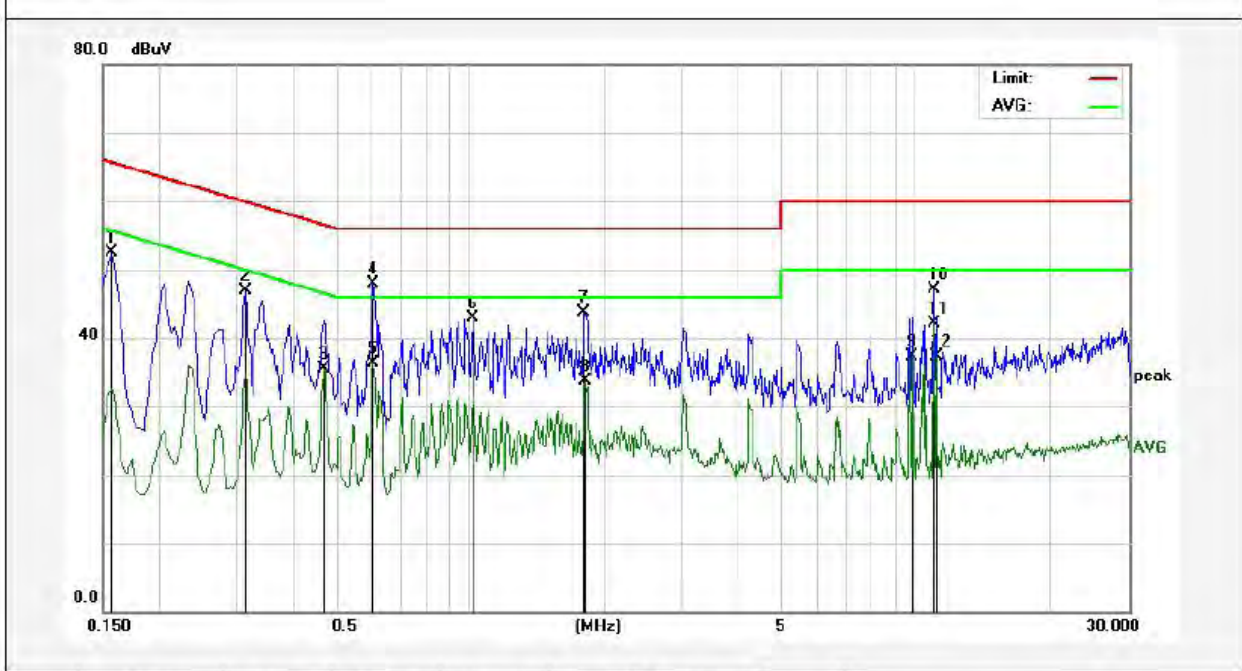

No.	Freq. (MHz)	Reading (dBuV)	Factor (dB)	Result (dBuV)	Limit dBuV	Over Limit (dB)	Detector	Remark
1	0.1580	32.59	19.90	52.49	65.56	-13.07	QP	
2	0.3140	26.93	19.90	46.83	59.86	-13.03	QP	
3	0.4700	15.60	19.97	35.57	46.51	-10.94	AVG	
4	0.6060	27.98	20.01	47.99	56.00	-8.01	QP	
5	0.6060	16.27	20.01	36.28	46.00	-9.72	AVG	
6	1.0140	22.86	20.12	42.98	56.00	-13.02	QP	
7	1.8060	23.61	20.14	43.75	56.00	-12.25	QP	
8	1.8100	13.57	20.14	33.71	46.00	-12.29	AVG	
9	9.8139	17.02	20.33	37.35	50.00	-12.65	AVG	
10	10.9780	26.73	20.32	47.05	60.00	-12.95	QP	
11	10.9780	21.82	20.32	42.14	50.00	-7.86	AVG	
12	11.0860	16.96	20.32	37.28	50.00	-12.72	AVG	



**Conducted Emission Test Data**

Test Site: 1# Shielded Room  
 Operating Condition: Keeping TX+ Charging Mode  
 Test Specification: AC 240V, 60Hz  
 Comment: Neutral Line  
 Tem.: 22.3°C Hum.: 57%

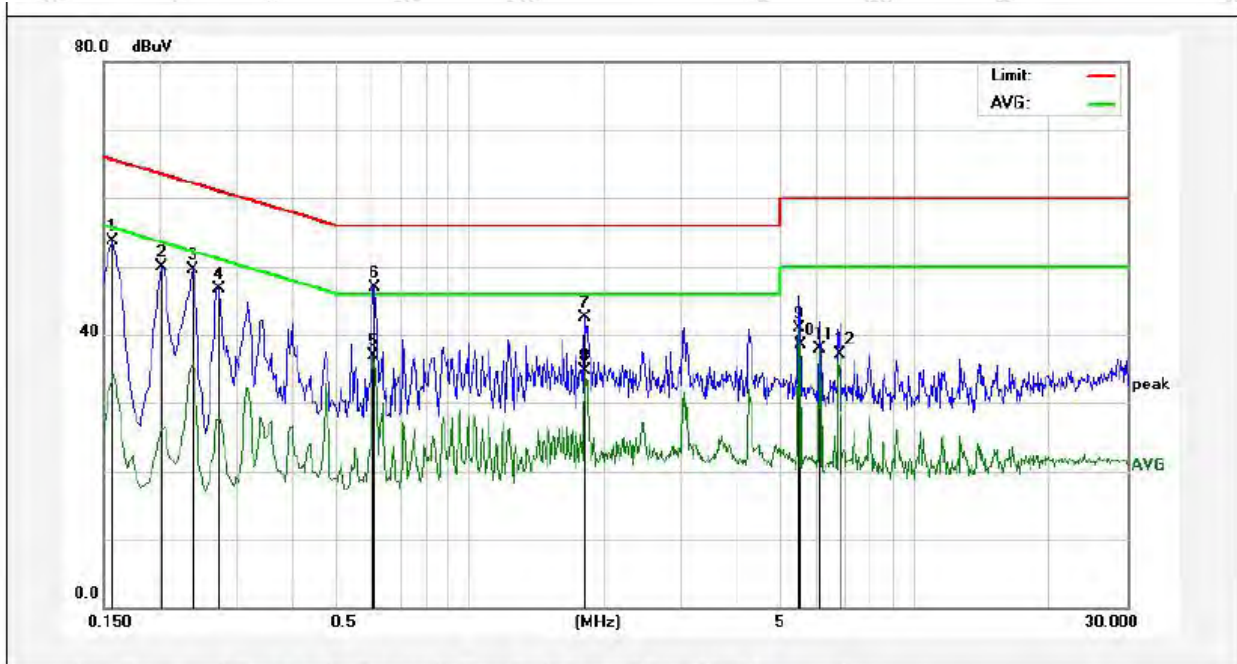

No.	Freq. (MHz)	Reading (dBuV)	Factor (dB)	Result (dBuV)	Limit dBuV	Over Limit (dB)	Detector	Remark
1	0.1580	33.86	19.90	53.76	65.56	-11.80	QP	
2	0.2020	29.93	19.90	49.83	63.52	-13.69	QP	
3	0.2380	29.59	19.89	49.48	62.16	-12.68	QP	
4	0.2740	26.88	19.89	46.77	60.99	-14.22	QP	
5	0.6060	16.96	20.01	36.97	46.00	-9.03	AVG	
6	0.6100	26.85	20.01	46.86	56.00	-9.14	QP	
7	1.8140	22.42	20.14	42.56	56.00	-13.44	QP	
8	1.8140	14.54	20.14	34.68	46.00	-11.32	AVG	
9	5.4820	20.59	20.22	40.81	50.00	-9.19	AVG	
10	5.5420	18.38	20.22	38.60	50.00	-11.40	AVG	
11	6.1100	17.58	20.24	37.82	50.00	-12.18	AVG	
12	6.7980	16.92	20.25	37.17	50.00	-12.83	AVG	



**Conducted Emission Test Data**

Test Site: 1# Shielded Room  
 Operating Condition: Keeping TX+ Charging Mode  
 Test Specification: AC 120V, 60Hz  
 Comment: Live Line  
 Tem.: 22.3°C Hum.: 57%

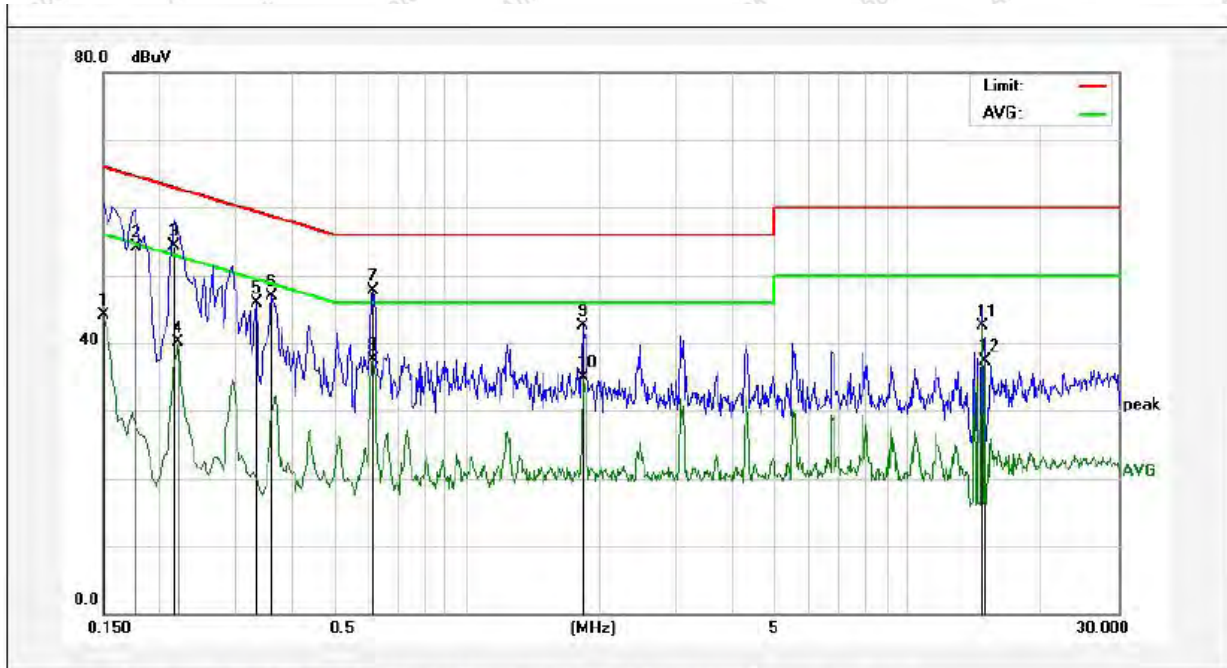

No.	Freq. (MHz)	Reading (dBuV)	Factor (dB)	Result (dBuV)	Limit dBuV	Over Limit (dB)	Detector	Remark
1	0.1500	24.17	19.90	44.07	55.99	-11.92	AVG	
2	0.1780	34.21	19.90	54.11	64.57	-10.46	QP	
3	0.2180	34.34	19.90	54.24	62.89	-8.65	QP	
4	0.2220	20.14	19.90	40.04	52.74	-12.70	AVG	
5	0.3339	26.06	19.91	45.97	59.35	-13.38	QP	
6	0.3620	27.06	19.92	46.98	58.68	-11.70	QP	
7	0.6140	27.79	20.01	47.80	56.00	-8.20	QP	
8	0.6140	17.56	20.01	37.57	46.00	-8.43	AVG	
9	1.8340	22.44	20.14	42.58	56.00	-13.42	QP	
10	1.8340	14.71	20.14	34.85	46.00	-11.15	AVG	
11	14.7940	22.23	20.26	42.49	50.00	-7.51	AVG	
12	14.9500	17.09	20.26	37.35	50.00	-12.65	AVG	

**Conducted Emission Test Data**

Test Site: 1# Shielded Room  
 Operating Condition: Keeping TX+ Charging Mode  
 Test Specification: AC 120V, 60Hz  
 Comment: Neutral Line  
 Tem.: 22.3°C Hum.: 57%

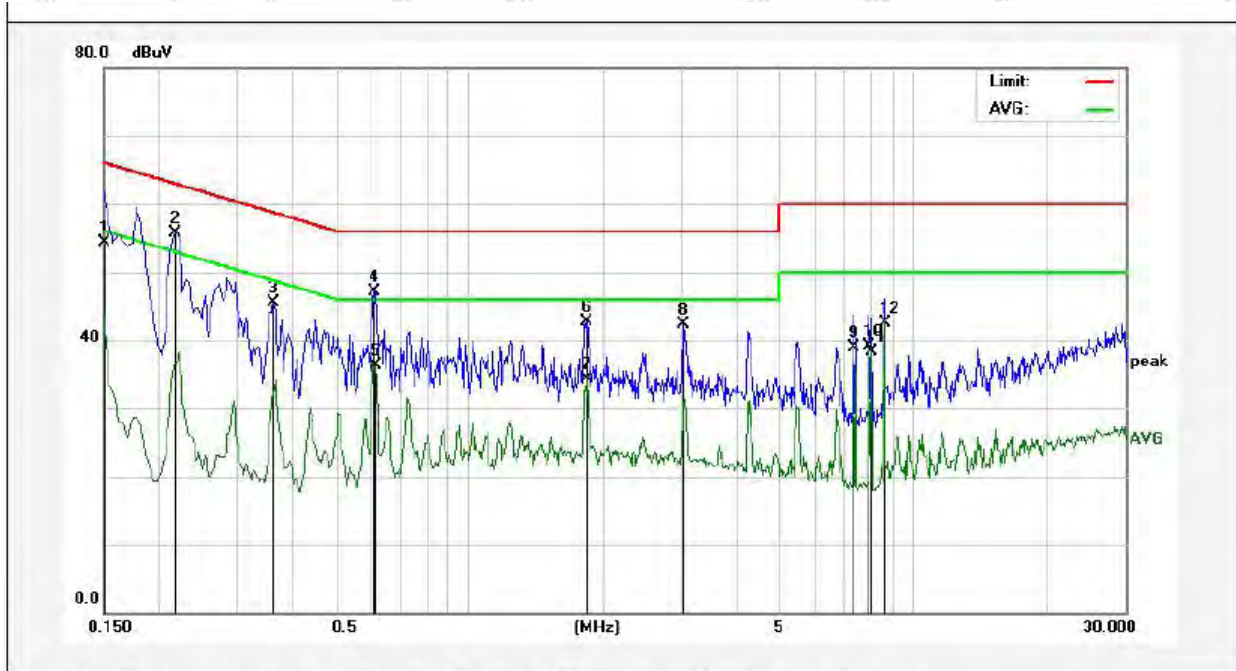

No.	Freq. (MHz)	Reading (dBuV)	Factor (dB)	Result (dBuV)	Limit dBuV	Over Limit (dB)	Detector	Remark
1	0.1500	34.45	19.90	54.35	65.99	-11.64	QP	
2	0.2180	35.89	19.90	55.79	62.89	-7.10	QP	
3	0.3620	25.66	19.92	45.58	58.68	-13.10	QP	
4	0.6100	27.18	20.01	47.19	56.00	-8.81	QP	
5	0.6140	16.25	20.01	36.26	46.00	-9.74	AVG	
6	1.8420	22.48	20.14	42.62	56.00	-13.38	QP	
7	1.8420	14.23	20.14	34.37	46.00	-11.63	AVG	
8	3.0340	22.12	20.16	42.28	56.00	-13.72	QP	
9	7.3380	18.73	20.27	39.00	50.00	-11.00	AVG	
10	7.9700	18.91	20.29	39.20	50.00	-10.80	AVG	
11	8.0540	17.92	20.29	38.21	50.00	-11.79	AVG	
12	8.5980	22.30	20.30	42.60	50.00	-7.40	AVG	



## 4. Radiation Spurious Emission and Band Edge

### 4.1. Test Standard and Limit

Test Standard	FCC Part15 C Section 15.209 and 15.205				
Test Limit	Frequency (MHz)	Field strength (microvolt/meter)	Limit (dBuV/m)	Remark	Measurement distance (m)
	0.009MHz~0.490MHz	2400/F(kHz)	-	-	300
	0.490MHz-1.705MHz	24000/F(kHz)	-	-	30
	1.705MHz-30MHz	30	-	-	30
	30MHz~88MHz	100	40.0	Quasi-peak	3
	88MHz~216MHz	150	43.5	Quasi-peak	3
	216MHz~960MHz	200	46.0	Quasi-peak	3
	960MHz~1000MHz	500	54.0	Quasi-peak	3
	Above 1000MHz	500	54.0	Average	3
		-	74.0	Peak	3

**Remark:**

(1)The lower limit shall apply at the transition frequency.

(2) 15.35(b), Unless otherwise specified, the limit on peak radio frequency emissions is 20dB above the maximum permitted average emission limit applicable to the equipment under test. This peak limit applies to the total peak emission level radiated by the device.

### 4.2. Test Setup

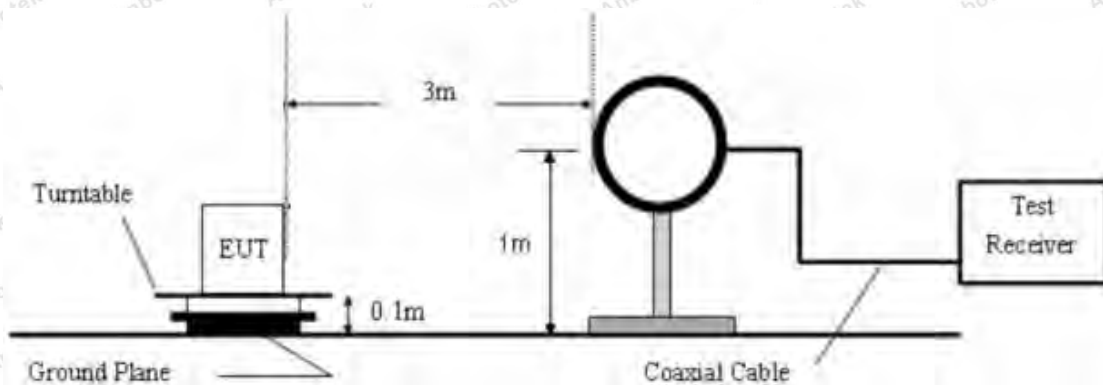

Figure 1. Below 30MHz



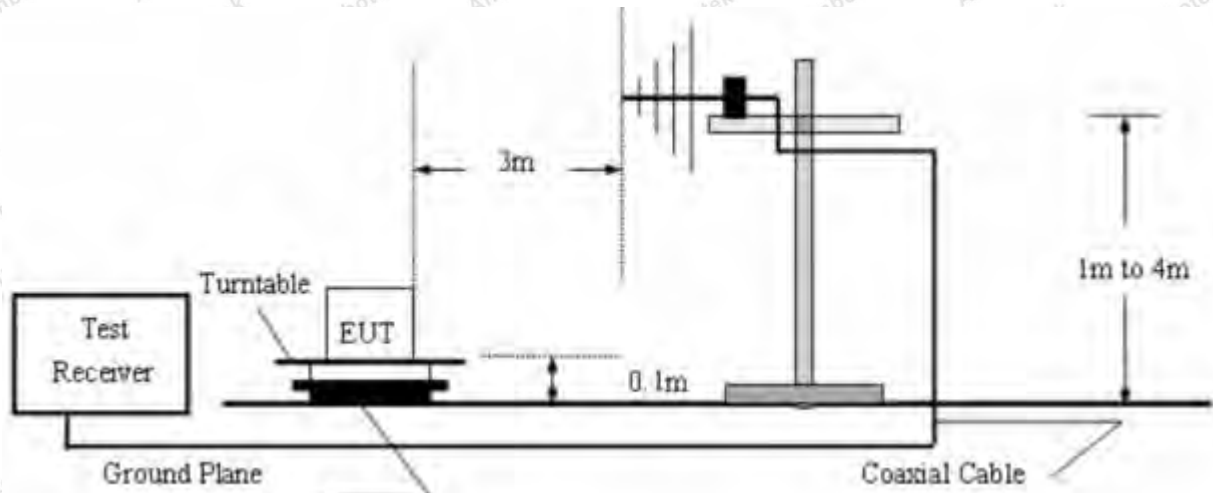

Figure 2. 30MHz to 1GHz

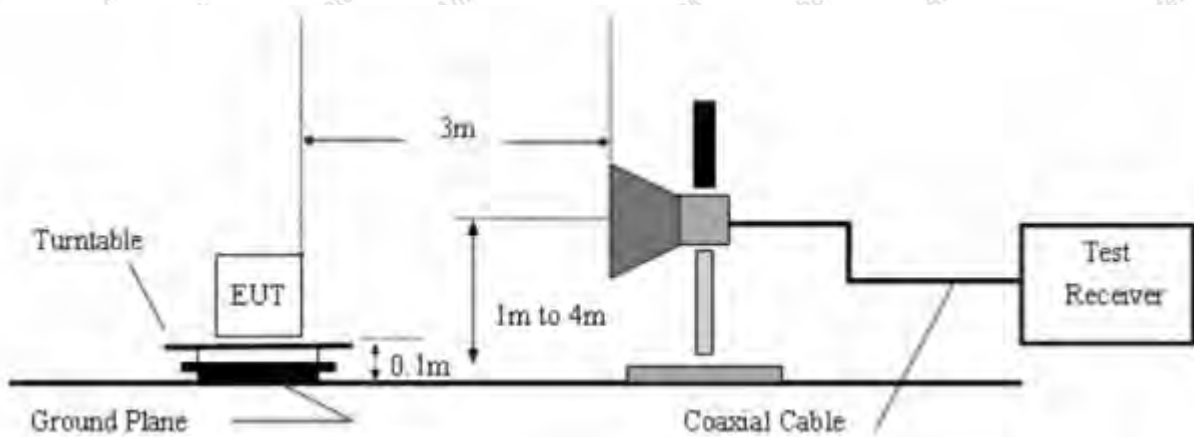

Figure 3. Above 1 GHz

### 4.3. Test Procedure

For below 1GHz: The EUT is placed on a turntable, which is 0.1m above the ground plane.

For above 1GHz: The EUT is placed on a turntable, which is 1.5m above the ground plane.

The turn table can rotate 360 degrees to determine the position of the maximum emission level. The EUT is set 3 meters away from the receiving antenna which is mounted on a antenna tower. The antenna can be moved up and down from 1 to 4 meters to find out the maximum emission level. Rotated the EUT through three orthogonal axes to determine the maximum emissions, both horizontal and vertical polarization of the antenna are set on test. The EUT is tested in 9\*6\*6 Chamber. The device is evaluated in xyz orientation.

For the radiated emission test above 1GHz:

Place the measurement antenna away from each area of the EUT determined to be a source of emissions at the specified measurement distance, while keeping the measurement antenna aimed at the source of emissions at each frequency of significant emissions, with polarization oriented for maximum response. The measurement antenna may have to be higher or lower than the EUT, depending on the radiation pattern of the emission and staying aimed at the emission source for receiving the maximum signal. The final measurement antenna elevation shall be that which maximizes the emissions. The measurement antenna elevation for maximum emissions shall be restricted to a range of heights of from 1 m to 4 m above the ground or reference ground plane.

For 9kHz to 150kHz, Set the spectrum analyzer as:

RBW = 200Hz, VBW =1kHz, Detector= Quasi-Peak, Trace mode= Max hold, Sweep- auto couple.

For 150kHz to 30MHz, Set the spectrum analyzer as:

RBW = 9kHz, VBW = 30kHz, Detector = Quasi-Peak, Trace mode = Max hold, Sweep = auto couple.

For 30MHz to 1000MHz, Set the spectrum analyzer as:

RBW = 100kHz, VBW = 300kHz, Detector = Quasi-Peak, Trace mode = Max hold, Sweep = auto couple.

For above 1GHz, Set the spectrum analyzer as:

RBW = 1MHz, VBW = 1MHz, Detector = Peak, Trace mode = Max hold, Sweep = auto couple.

RBW = 1MHz, VBW = 10Hz, Detector = Average, Trace mode = Max hold, Sweep = auto couple.

#### 4.4. Test Data

##### PASS

During the test, pre-scan the GFSK,  $\pi/4$ QPSK, 8DPSK modulation, and found the GFSK modulation Middle channel which is the worst case, only the worst case is recorded in the report

The test results of 9kHz-30MHz was attenuated more than 20dB below the permissible limits, so the results don't record in the report.

**Test Results (30~1000MHz)**

Job No.: SZAWW180613001-01 Temp.(°C)/Hum.(%RH): 23.2°C/53.4%RH  
 Standard: FCC PART 15C Power Source: AC 120V, 60Hz  
 Test Mode: Mode 2 Polarization: Horizontal



No.	Freq. (MHz)	Reading (dBuV/m)	Factor (dB/m)	Result (dBuV/m)	Limit (dBuV/)	Over Limit (dB)	Detector	Height (cm)	degree (deg)	Remark
1	32.1794	45.72	-11.91	33.81	40.00	-6.19	QP	300	0	
2	38.8878	39.28	-8.97	30.31	40.00	-9.69	QP	300	97	
3	104.1701	52.16	-14.70	37.46	43.50	-6.04	QP	300	125	
4	167.2366	51.19	-13.92	37.27	43.50	-6.23	QP	300	235	
5	225.3077	49.56	-12.83	36.73	46.00	-9.27	QP	300	302	
6	383.9318	43.85	-7.19	36.66	46.00	-9.34	QP	300	346	



**Test Results (30~1000MHz)**

Job No.: SZAWW180613001-01 Temp.(°C)/Hum.(%RH): 23.2°C/53.4%RH  
 Standard: FCC PART 15C Power Source: AC 120V, 60Hz  
 Test Mode: Mode 2 Polarization: Vertical

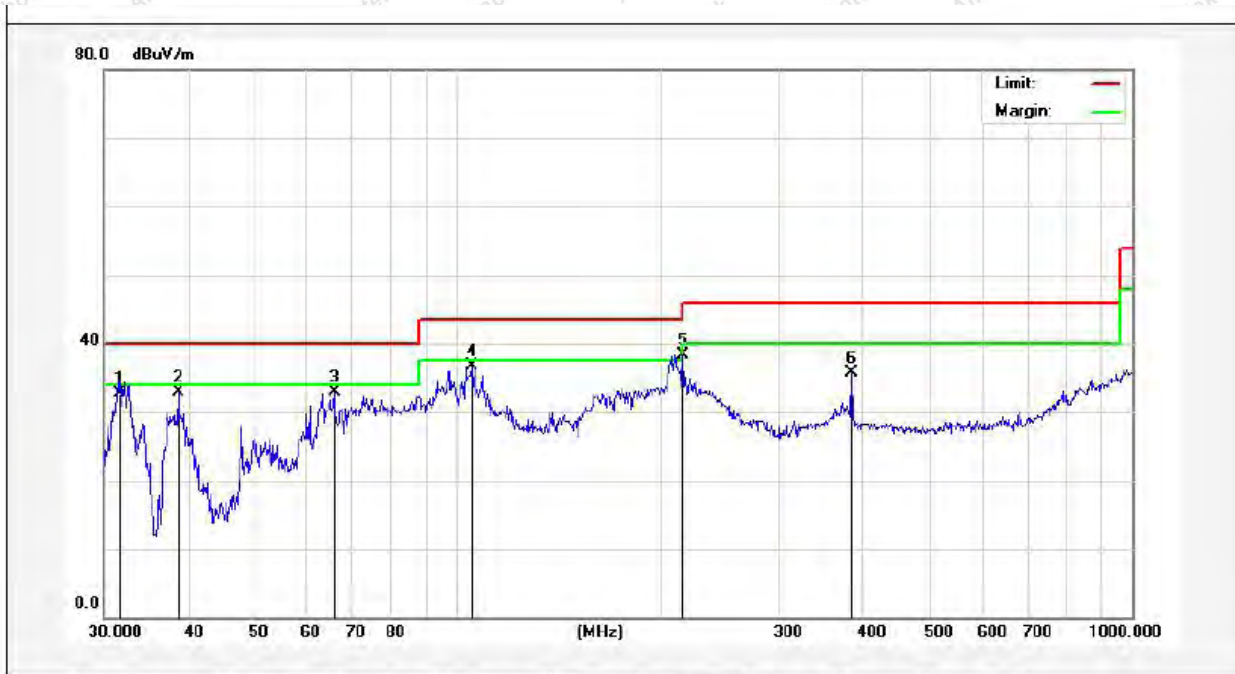

No.	Freq. (MHz)	Reading (dBuV/m)	Factor (dB/m)	Result (dBuV/m)	Limit (dBuV/)	Over Limit (dB)	Detector	Height (cm)	degree (deg)	Remark
1	31.6202	43.72	-11.08	32.64	40.00	-7.36	QP	300	0	
2	38.6160	41.04	-8.12	32.92	40.00	-7.08	QP	300	120	
3	65.8031	45.15	-12.18	32.97	40.00	-7.03	QP	300	235	
4	105.2716	45.48	-8.70	36.78	43.50	-6.72	QP	300	256	
5	216.0240	46.67	-8.43	38.24	46.00	-7.76	QP	300	302	
6	383.9318	41.97	-6.19	35.78	46.00	-10.22	QP	300	360	

**Test Results (1GHz-25GHz)**

Test Mode: CH00					Test channel: Lowest			
Peak Value								
Frequency (MHz)	Read Level (dBuV)	Antenna Factor (dB/m)	Cable Loss (dB)	Preamp Factor (dB)	Level (dBuV/m)	Limit (dBuV/m)	Over Limit (dB)	Pol.
4804.00	38.79	34.04	6.58	34.09	45.32	74.00	-28.68	V
7206.00	32.81	37.11	7.73	34.50	43.15	74.00	-30.85	V
9608.00	32.34	39.31	9.23	34.79	46.09	74.00	-27.91	V
12010.00	*					74.00		V
14412.00	*					74.00		V
4804.00	43.38	34.04	6.58	34.09	49.91	74.00	-24.09	H
7206.00	34.70	37.11	7.73	34.50	45.04	74.00	-28.96	H
9608.00	31.91	39.31	9.23	34.79	45.66	74.00	-28.34	H
12010.00	*					74.00		H
14412.00	*					74.00		H
Average Value								
Frequency (MHz)	Read Level (dBuV)	Antenna Factor (dB/m)	Cable Loss (dB)	Preamp Factor (dB)	Level (dBuV/m)	Limit (dBuV/m)	Over Limit (dB)	Pol.
4804.00	27.32	34.04	6.58	34.09	33.85	54.00	-20.15	V
7206.00	21.33	37.11	7.73	34.50	31.67	54.00	-22.33	V
9608.00	20.32	39.31	9.23	34.79	34.07	54.00	-19.93	V
12010.00	*					54.00		V
14412.00	*					54.00		V
4804.00	31.71	34.04	6.58	34.09	38.24	54.00	-15.76	H
7206.00	23.60	37.11	7.73	34.50	33.94	54.00	-20.06	H
9608.00	20.17	39.31	9.23	34.79	33.92	54.00	-20.08	H
12010.00	*					54.00		H
14412.00	*					54.00		H

**Test Results (1GHz-25GHz)**

Test Mode: CH39					Test channel: Middle			
Peak Value								
Frequency (MHz)	Read Level (dBuV)	Antenna Factor (dB/m)	Cable Loss (dB)	Preamp Factor (dB)	Level (dBuV/m)	Limit (dBuV/m)	Over Limit (dB)	Pol.
4882.00	37.11	34.38	6.69	34.09	44.09	74.00	-29.91	V
7323.00	31.70	37.22	7.78	34.53	42.17	74.00	-31.83	V
9764.00	31.35	39.46	9.35	34.80	45.36	74.00	-28.64	V
12205.00	*					74.00		V
14646.00	*					74.00		V
4882.00	41.35	34.38	6.69	34.09	48.33	74.00	-25.67	H
7323.00	33.44	37.22	7.78	34.53	43.91	74.00	-30.09	H
9764.00	30.75	39.46	9.35	34.80	44.76	74.00	-29.24	H
12205.00	*					74.00		H
14646.00	*					74.00		H
Average Value								
Frequency (MHz)	Read Level (dBuV)	Antenna Factor (dB/m)	Cable Loss (dB)	Preamp Factor (dB)	Level (dBuV/m)	Limit (dBuV/m)	Over Limit (dB)	Pol.
4882.00	25.97	34.38	6.69	34.09	32.95	54.00	-21.05	V
7323.00	20.42	37.22	7.78	34.53	30.89	54.00	-23.11	V
9764.00	19.50	39.46	9.35	34.80	33.51	54.00	-20.49	V
12205.00	*					54.00		V
14646.00	*					54.00		V
4882.00	30.18	34.38	6.69	34.09	37.16	54.00	-16.84	H
7323.00	22.58	37.22	7.78	34.53	33.05	54.00	-20.95	H
9764.00	19.22	39.46	9.35	34.80	33.23	54.00	-20.77	H
12205.00	*					54.00		H
14646.00	*					54.00		H



**Test Results (1GHz-25GHz)**

Test Mode: CH78					Test channel: Highest			
Peak Value								
Frequency (MHz)	Read Level (dBuV)	Antenna Factor (dB/m)	Cable Loss (dB)	Preamp Factor (dB)	Level (dBuV/m)	Limit (dBuV/m)	Over Limit (dB)	Pol.
4960.00	35.99	34.72	6.79	34.09	43.41	74.00	-30.59	V
7440.00	30.96	37.34	7.82	34.57	41.55	74.00	-32.45	V
9920.00	30.69	39.62	9.46	34.81	44.96	74.00	-29.04	V
12400.00	*					74.00		V
14880.00	*					74.00		V
4960.00	40.01	34.72	6.79	34.09	47.43	74.00	-26.57	H
7440.00	32.60	37.34	7.82	34.57	43.19	74.00	-30.81	H
9920.00	29.99	39.62	9.46	34.81	44.26	74.00	-29.74	H
12400.00	*					74.00		H
14880.00	*					74.00		H
Average Value								
Frequency (MHz)	Read Level (dBuV)	Antenna Factor (dB/m)	Cable Loss (dB)	Preamp Factor (dB)	Level (dBuV/m)	Limit (dBuV/m)	Over Limit (dB)	Pol.
4960.00	25.10	34.72	6.79	34.09	32.52	54.00	-21.48	V
7440.00	19.82	37.34	7.82	34.57	30.41	54.00	-23.59	V
9920.00	18.98	39.62	9.46	34.81	33.25	54.00	-20.75	V
12400.00	*					54.00		V
14880.00	*					54.00		V
4960.00	29.19	34.72	6.79	34.09	36.61	54.00	-17.39	H
7440.00	21.91	37.34	7.82	34.57	32.50	54.00	-21.50	H
9920.00	18.61	39.62	9.46	34.81	32.88	54.00	-21.12	H
12400.00	*					54.00		H
14880.00	*					54.00		H

Remark:

1. During the test, pre-scan the GFSK,  $\pi/4$ QPSK, 8DPSK modulation, and found the GFSK modulation is worse case, the report only record this mode.
2. Level =Receiver Read level + Antenna Factor + Cable Loss – Preamplifier Factor
3. “\*” means the test results were attenuated more than 20dB below the permissible limits, so the results don't record in the report.

**Radiated Band Edge:**

Test Mode: CH00					Test channel: Lowest				
Peak Value									
Frequency (MHz)	Read Level (dBuV)	Antenna Factor (dB/m)	Cable Loss (dB)	Preamp Factor (dB)	Level (dBuV/m)	Limit (dBuV/m)	Over Limit (dB)	Pol.	
2390.00	44.86	29.15	3.41	34.01	43.41	74.00	-30.59	H	
2400.00	61.94	29.16	3.43	34.01	60.52	74.00	-13.48	H	
2390.00	45.60	29.15	3.41	34.01	44.15	74.00	-29.85	V	
2400.00	64.19	29.16	3.43	34.01	62.77	74.00	-11.23	V	
Average Value									
Frequency (MHz)	Read Level (dBuV)	Antenna Factor (dB/m)	Cable Loss (dB)	Preamp Factor (dB)	Level (dBuV/m)	Limit (dBuV/m)	Over Limit (dB)	Pol.	
2390.00	34.97	29.15	3.41	34.01	33.52	54.00	-20.48	H	
2400.00	46.32	29.16	3.43	34.01	44.90	54.00	-9.10	H	
2390.00	35.05	29.15	3.41	34.01	33.60	54.00	-20.40	V	
2400.00	48.16	29.16	3.43	34.01	46.74	54.00	-7.26	V	

Test Mode: CH78					Test channel: Highest				
Peak Value									
Frequency (MHz)	Read Level (dBuV)	Antenna Factor (dB/m)	Cable Loss (dB)	Preamp Factor (dB)	Level (dBuV/m)	Limit (dBuV/m)	Over Limit (dB)	Pol.	
2483.50	47.20	29.28	3.53	34.03	45.98	74.00	-28.02	H	
2500.00	46.00	29.30	3.56	34.03	44.83	74.00	-29.17	H	
2483.50	48.38	29.28	3.53	34.03	47.16	74.00	-26.84	V	
2500.00	47.19	29.30	3.56	34.03	46.02	74.00	-27.98	V	
Average Value									
Frequency (MHz)	Read Level (dBuV)	Antenna Factor (dB/m)	Cable Loss (dB)	Preamp Factor (dB)	Level (dBuV/m)	Limit (dBuV/m)	Over Limit (dB)	Pol.	
2483.50	37.82	29.28	3.53	34.03	36.60	54.00	-17.40	H	
2500.00	35.53	29.30	3.56	34.03	34.36	54.00	-19.64	H	
2483.50	39.19	29.28	3.53	34.03	37.97	54.00	-16.03	V	
2500.00	35.62	29.30	3.56	34.03	34.45	54.00	-19.55	V	

Remark:

1. During the test, pre-scan the GFSK,  $\pi/4$ QPSK, 8DPSK modulation, and found the GFSK modulation is worse case, the report only record this mode.
2. Level = Receiver Read level + Antenna Factor + Cable Loss – Preamplifier Factor

## 5. Maximum Peak Output Power Test

### 5.1. Test Standard and Limit

Test Standard	FCC Part15 C Section 15.247 (b)(3)
Test Limit	125mW

### 5.2. Test Setup

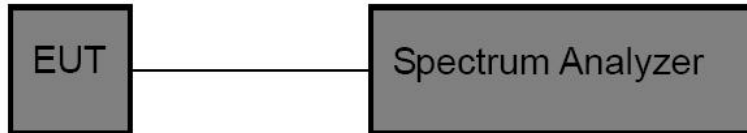

### 5.3. Test Procedure

- The EUT was directly connected to the spectrum analyzer and antenna output port as show in the block diagram above,
- Spectrum Setting:
  - RBW > the 20 dB bandwidth of the emission being measured
  - Span = approximately 5 times the 20 dB bandwidth, centered on a hopping channel
  - VBW ≥ RBW
  - Sweep = auto
  - Detector function = peak
  - Trace = max hold

### 5.4. Test Data

Test Item : Max. peak output power  
 Test Voltage : AC 120V, 60Hz  
 Test Result : PASS

Test Mode : CH Low ~ CH High  
 Temperature : 24°C  
 Humidity : 55%RH

Channel Frequency (MHz)	Peak Power output (dBm)	Limit (dBm)	Results	Modulation
2402	-0.377	20.96	PASS	BDR
2441	<b>-0.240</b>	20.96	PASS	BDR
2480	-0.486	20.96	PASS	BDR
2402	-0.635	20.96	PASS	EDR
2441	-0.320	20.96	PASS	EDR
2480	-0.548	20.96	PASS	EDR

Remark: The EDR was tested on ( $\pi$ /4DQPSK, 8DPSK) modes, only the worst data of (8DPSK) is attached in the following pages.



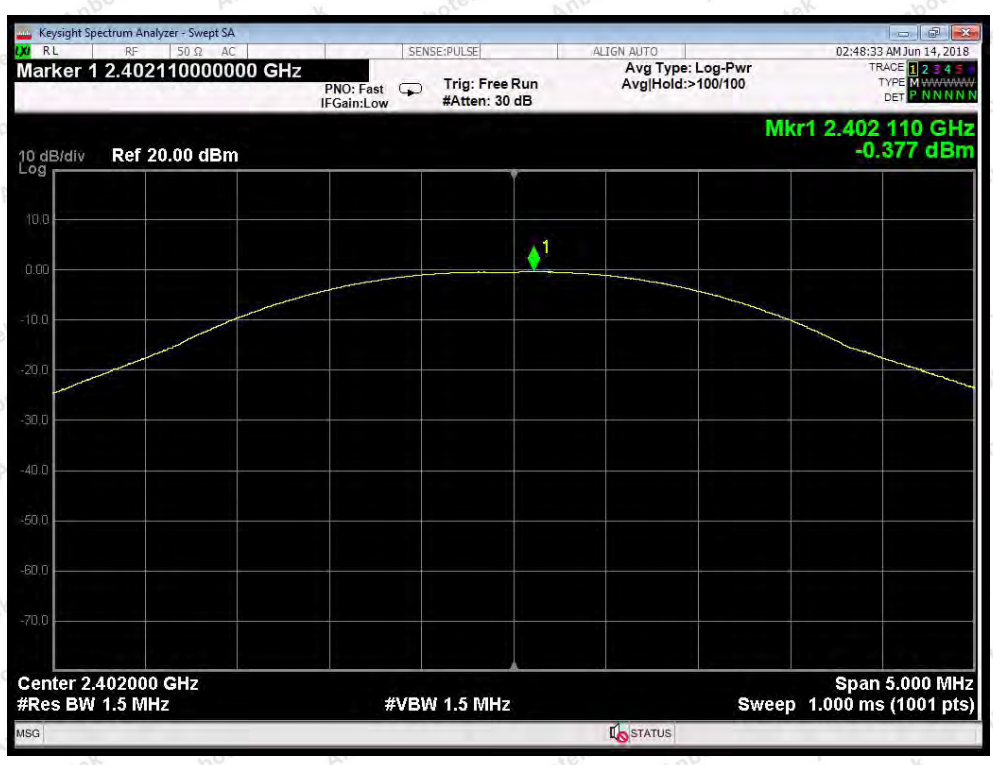

Test Mode: BDR---Low

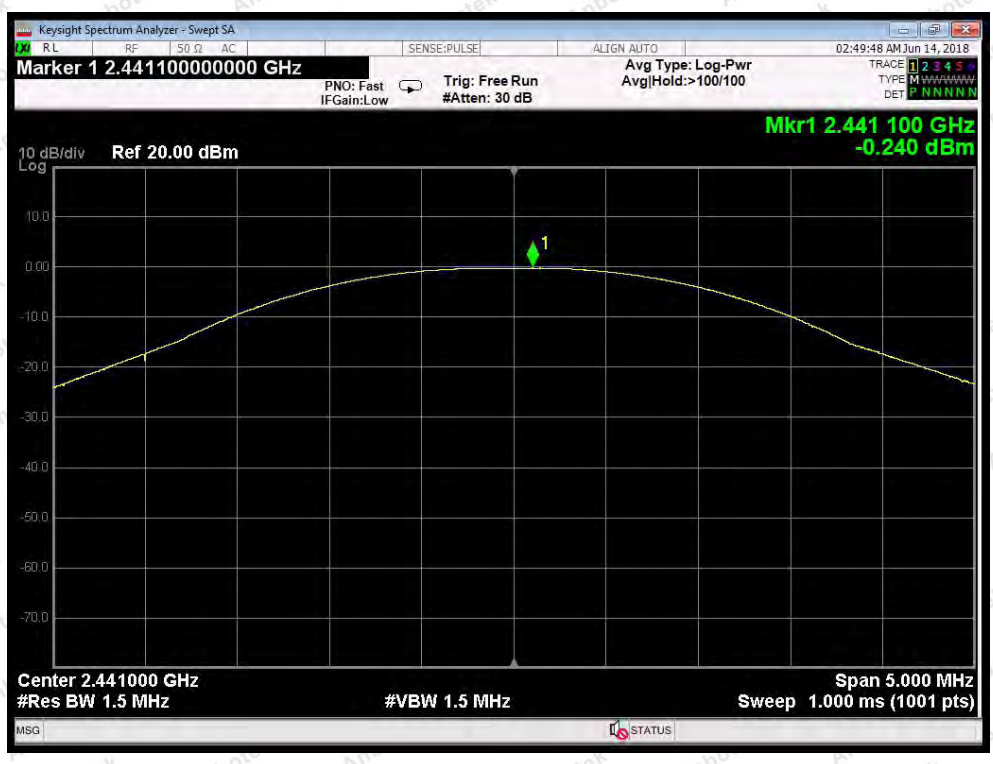

Test Mode: BDR---Middle

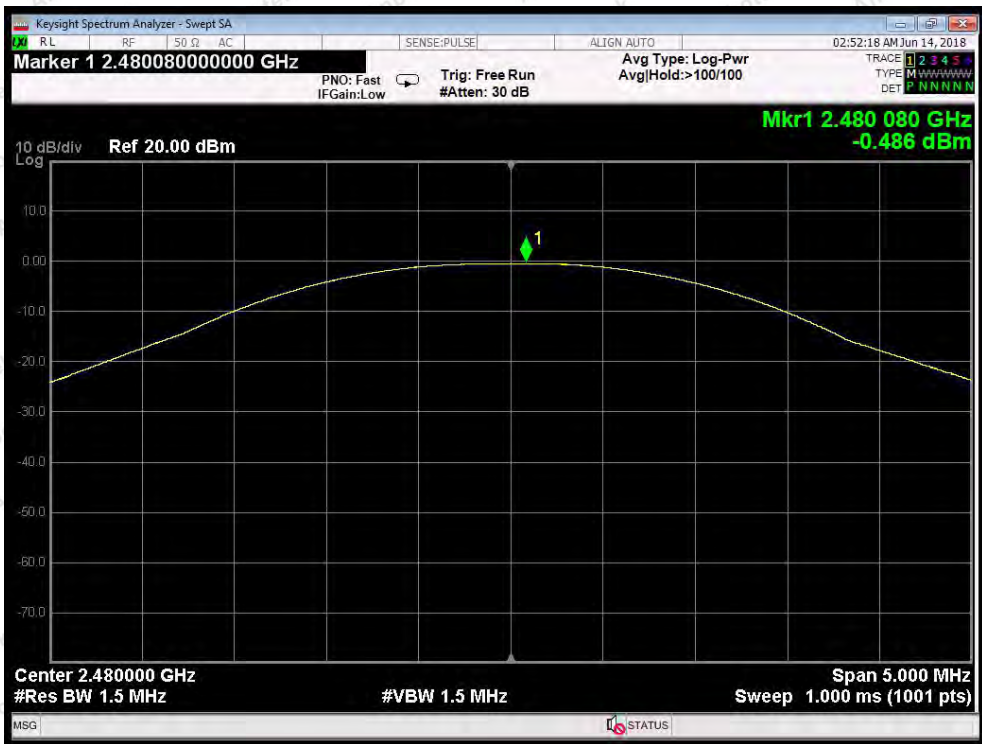

Test Mode: BDR---High

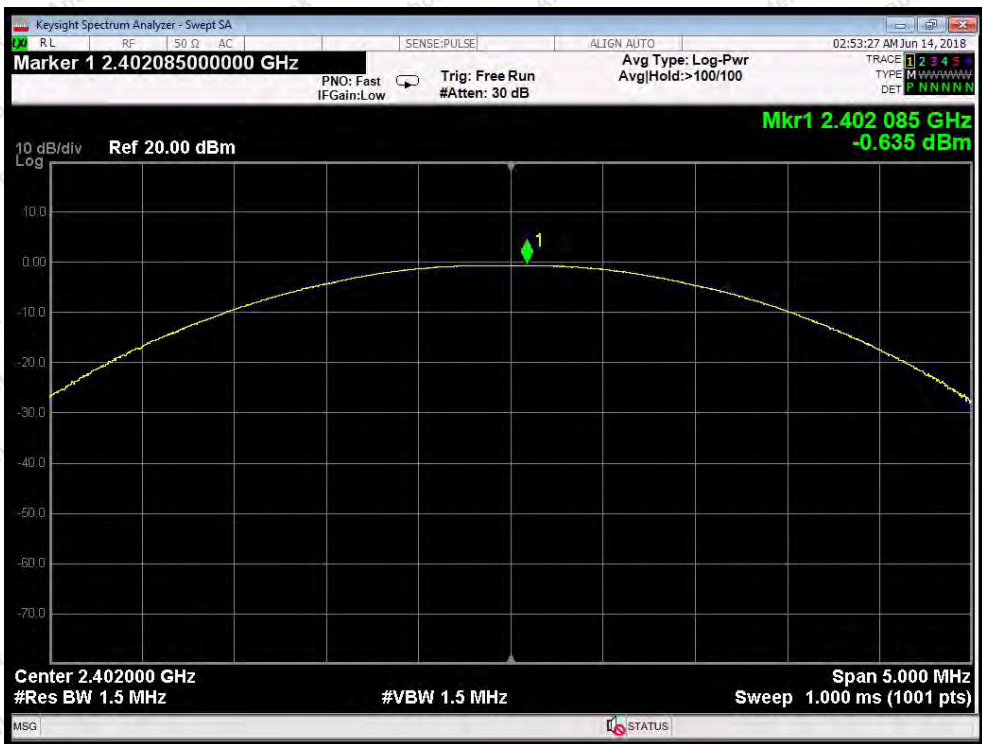

Test Mode: EDR---Low



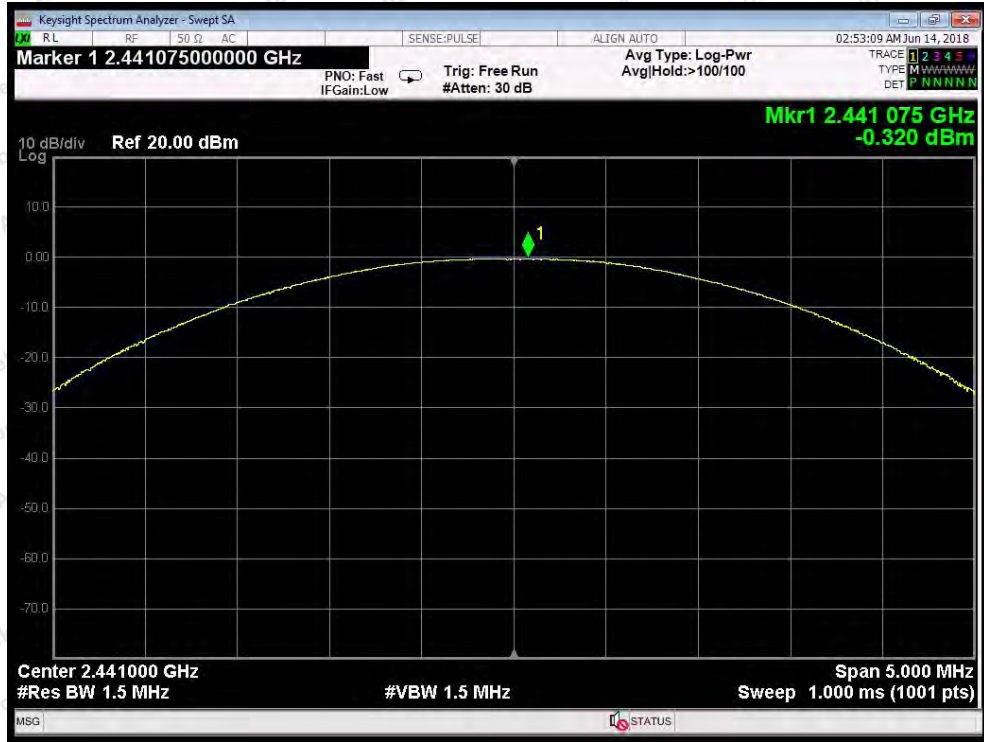

Test Mode: EDR---Middle

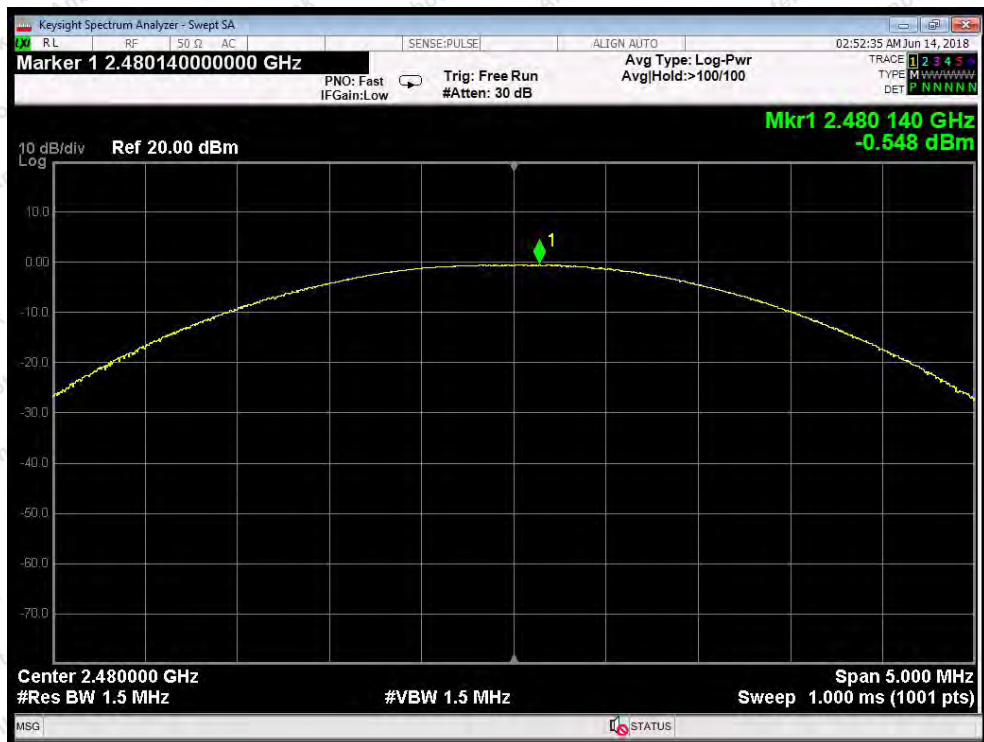

Test Mode: EDR---High



## 6. 20DB Occupy Bandwidth Test

### 6.1. Test Standard

Test Standard	FCC Part15 C Section 15.247 (a)(1)
---------------	------------------------------------

### 6.2. Test Setup

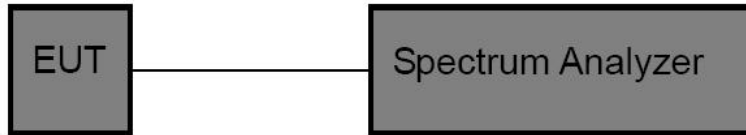

### 6.3. Test Procedure

Using the following spectrum analyzer settings:

1. Span= approximately 2 to 3 times the 20dB bandwidth, centered on a hopping channel.
2. Set the RBW = 30 kHz.
3. Set the VBW = 100 kHz.
4. Sweep time = auto couple.
5. Detector function = peak.
6. Trace mode = max hold.
7. Allow trace to fully stabilize.

### 6.4. Test Data

Test Item	: 20dB BW	Test Mode	: CH Low ~ CH High
Test Voltage	: AC 120V, 60Hz	Temperature	: 24°C
Test Result	: PASS	Humidity	: 55%RH

Channel	Frequency(MHz)	20dB Down BW(kHz)	Modulation Mode
Low	2402	875.9	BDR
Middle	2441	865.5	BDR
High	2480	864.8	BDR
Low	2402	1208.0	EDR
Middle	2441	1210.0	EDR
High	2480	1212.0	EDR

Remark: The EDR was tested on ( $\pi/4$ DQPSK, 8DPSK) modes, only the worst data of (8DPSK) is attached in the following pages.

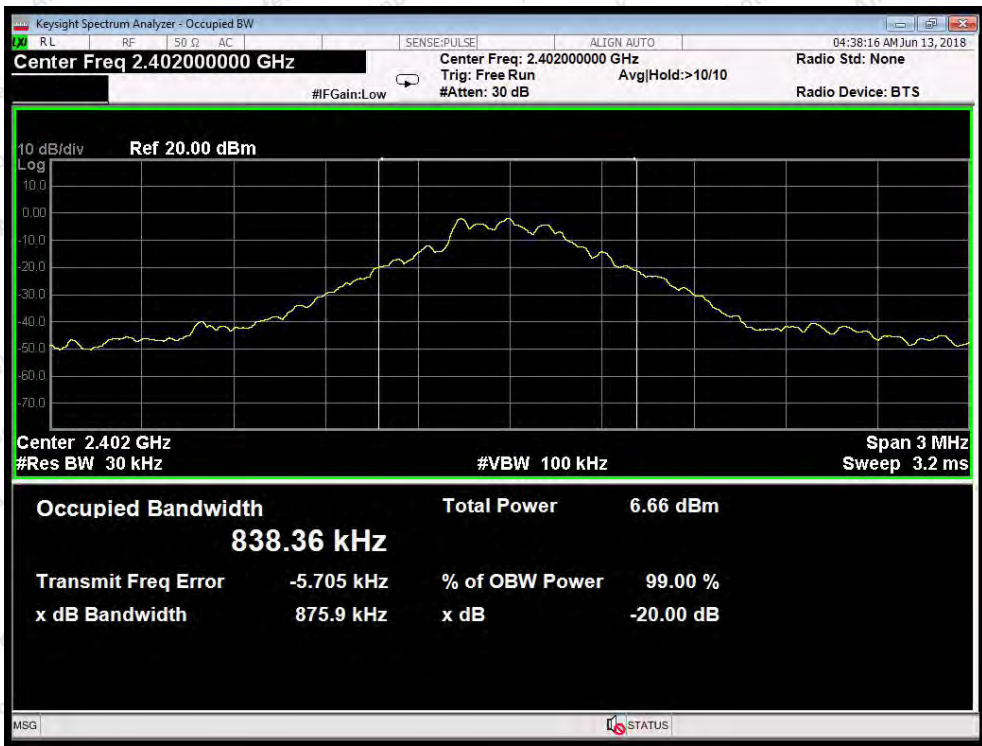

Test Mode: BDR---Low

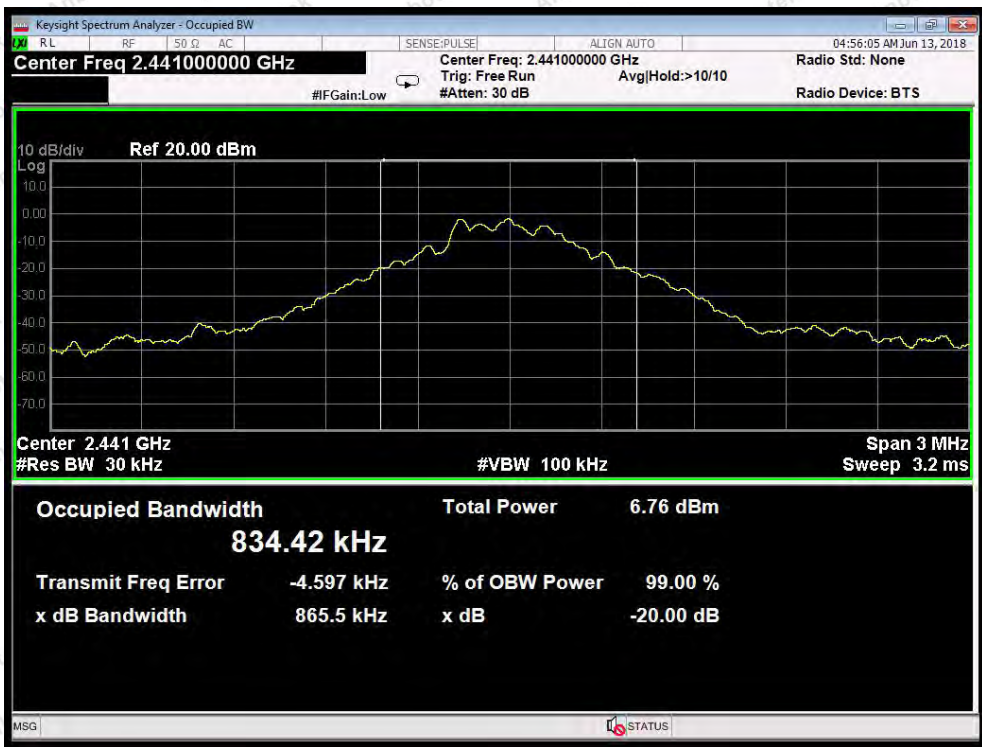

Test Mode: BDR---Middle



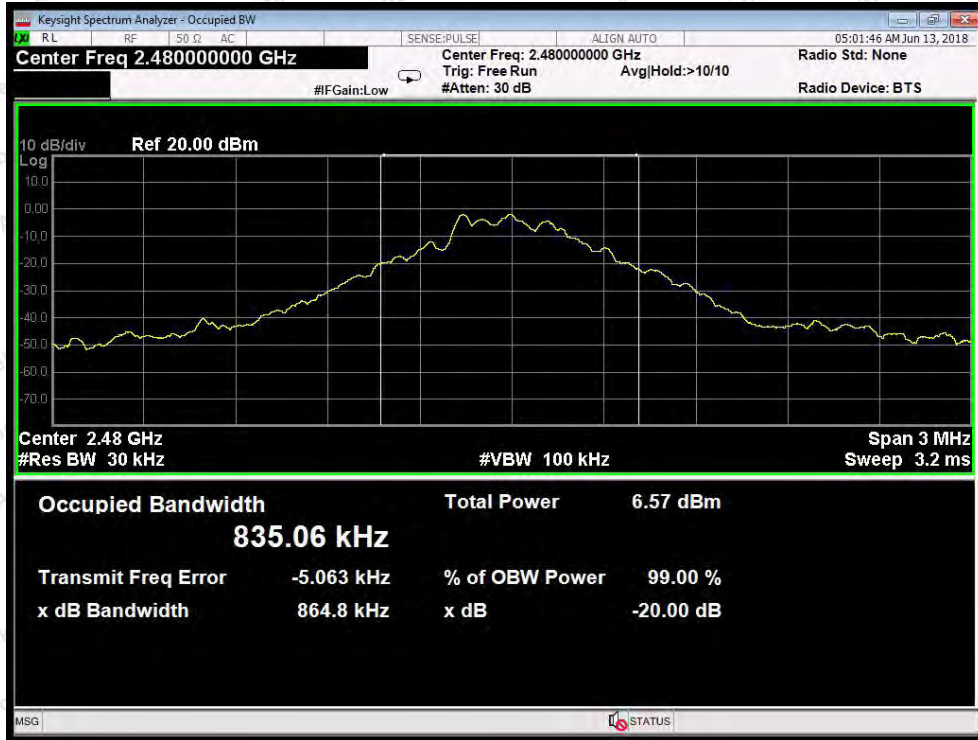

Test Mode: BDR---High

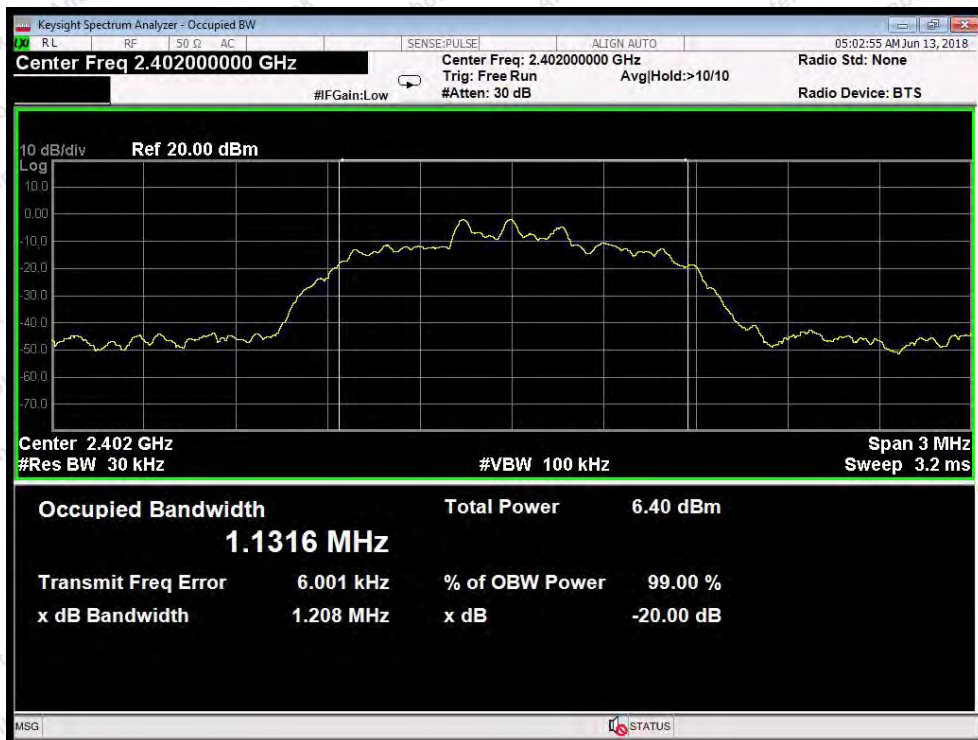

Test Mode: EDR---Low



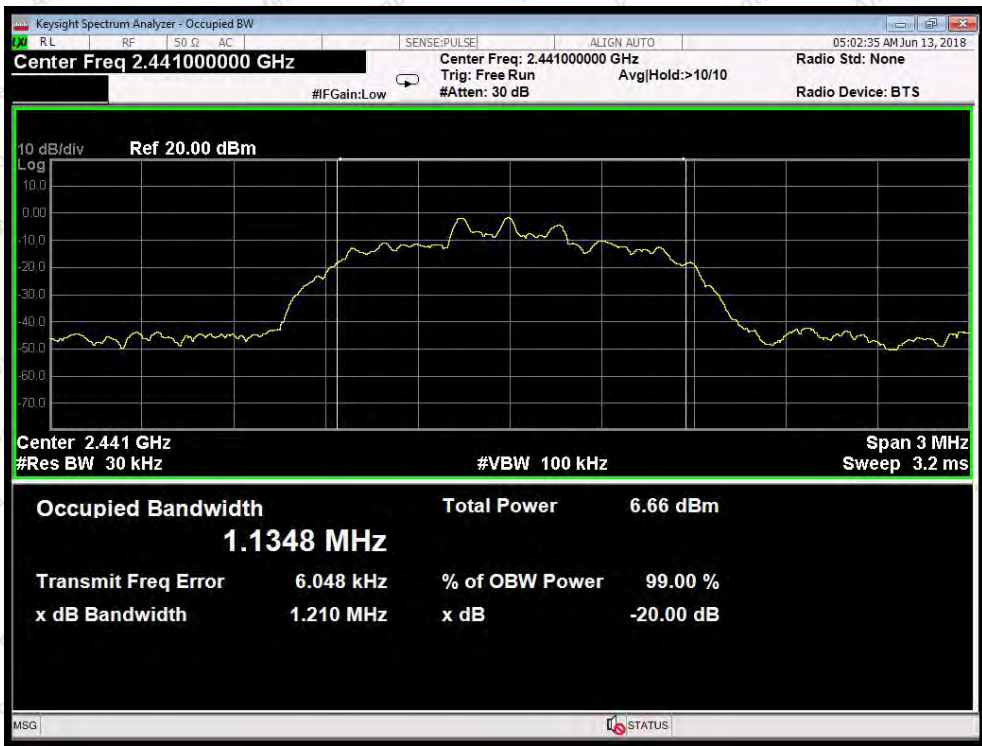

Test Mode: EDR---Middle

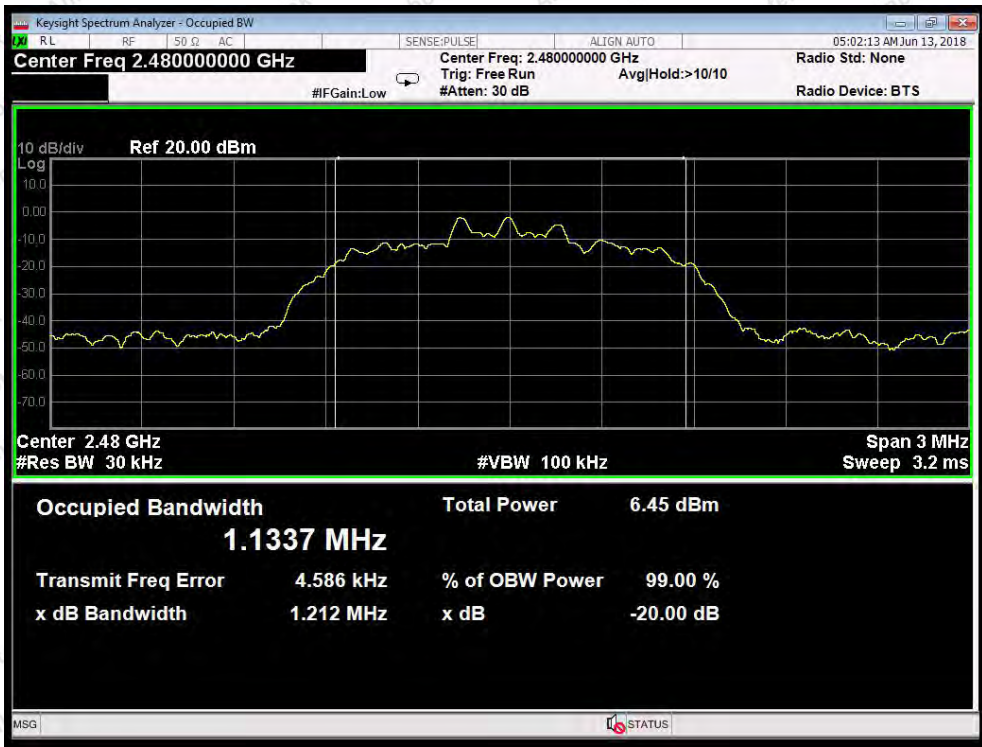

Test Mode: EDR---High

## 7. Carrier Frequency Separation Test

### 7.1. Test Standard and Limit

Test Standard	FCC Part15 C Section 15.247 (a)(1)
Test Limit	>25KHz or >two-thirds of the 20 dB bandwidth

### 7.2. Test Setup

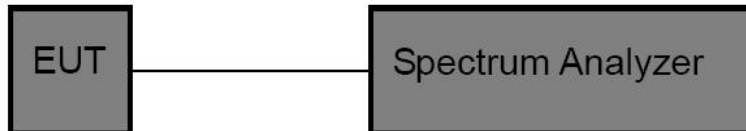

### 7.3. Test Procedure

The EUT must have its hopping function enabled. Using the following spectrum analyzer settings:

1. Span= Wide enough to capture the peaks of two adjacent channels
2. Set the RBW = 30 kHz.
3. Set the VBW = 100 kHz.
4. Sweep time = auto couple.
5. Detector function = peak.
6. Trace mode = max hold.
7. Allow trace to fully stabilize.

### 7.4. Test Data

Test Item : Frequency Separation  
 Test Voltage : AC 120V, 60Hz  
 Test Result : PASS

Test Mode : CH Low ~ CH High  
 Temperature : 24°C  
 Humidity : 55%RH

Channel	Frequency (MHz)	Separation Read Value (kHz)	Limit (kHz)	Modulation Mode
Low	2402	1000	875.9	BDR
Middle	2441	1000	865.5	BDR
High	2480	1000	864.8	BDR
Low	2402	1000	805.3	EDR
Middle	2441	1000	806.7	EDR
High	2480	1000	808.0	EDR

Remark:

1. The limit of mode (EDR) is 2/3 of 20dB BW;
2. The EDR was tested on ( $\pi/4$ DQPSK, 8DPSK) modes, only the worst data of (8DPSK) is attached in the following pages.





Test Mode: BDR---Low



Test Mode: BDR---Middle





Test Mode: BDR---High



Test Mode: EDR---Low



Test Mode: EDR---Middle



Test Mode: EDR---High

## 8. Number of Hopping Channel Test

### 8.1. Test Standard and Limit

Test Standard	FCC Part15 C Section 15.247 (a)(1)
Test Limit	>15 channels

### 8.2. Test Setup

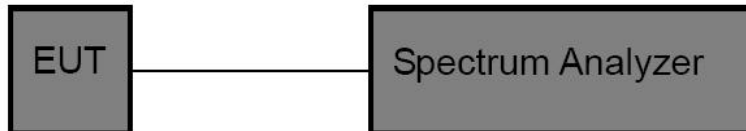

### 8.3. Test Procedure

The EUT must have its hopping function enabled. Using the following spectrum analyzer setting:

1. Span= the frequency band of operation
2. Set the RBW = 100kHz.
3. Set the VBW = 300kHz.
4. Sweep time = auto couple.
5. Detector function = peak.
6. Trace mode = max hold.
7. Allow trace to fully stabilize.

### 8.4. Test Data

Test Item	: Number of Hopping Frequency	Test Mode	: CH Low ~ CH High
Test Voltage	: AC 120V, 60Hz	Temperature	: 24°C
Test Result	: PASS	Humidity	: 55%RH

Hopping Channel Frequency Range	Quantity of Hopping Channel	Quantity of Hopping Channel
2402-2480MHz	79	> 15



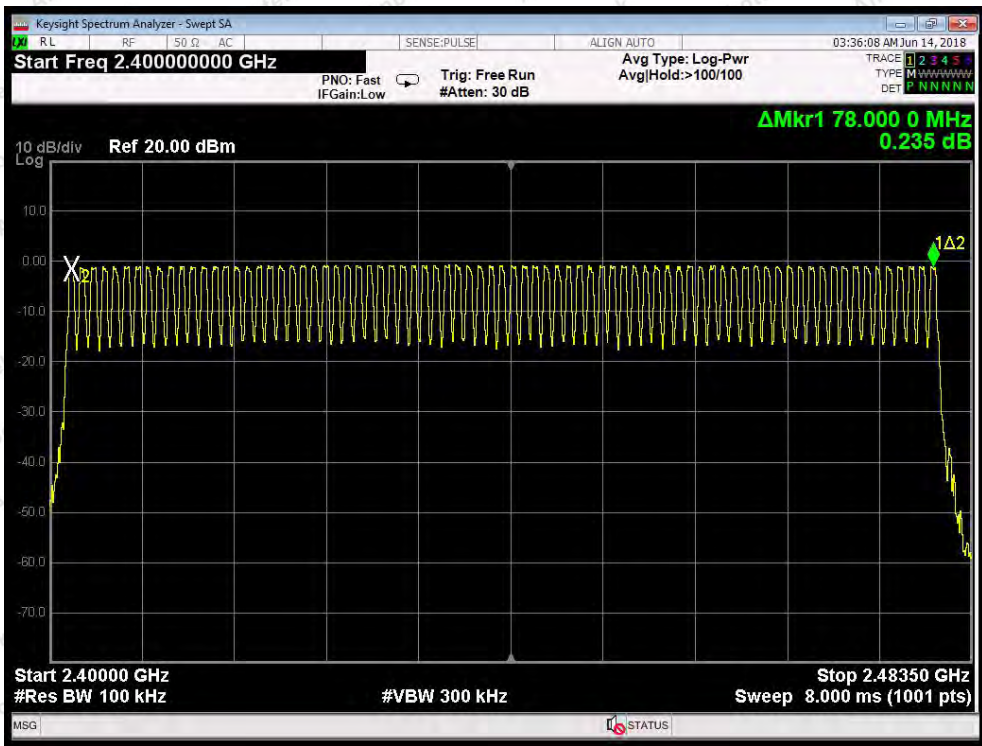

BDR Mode



EDR Mode

## 9. Dwell Time Test

### 9.1. Test Standard and Limit

Test Standard	FCC Part15 C Section 15.247 (a)(1)
Test Limit	0.4 sec

### 9.2. Test Setup

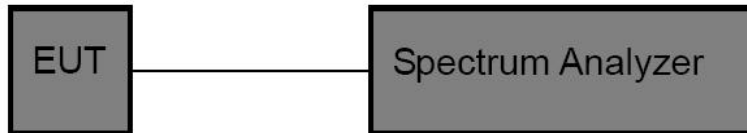

### 9.3. Test Procedure

The EUT must have its hopping function enabled. Use the following spectrum analyzer settings:

1. Span= zero span, centered on a hopping channel
2. Set the RBW = 1 MHz.
3. Set the VBW = 1 MHz.
4. Sweep time = as necessary to capture the entire dwell time per hopping channel.
5. Detector function = peak.
6. Trace mode = max hold.
7. Allow trace to fully stabilize.

### 9.4. Test Data

Test Item	: Time of Occupancy	Test Mode	: CH Low ~ CH High
Test Voltage	: AC 120V, 60Hz	Temperature	: 24°C
Test Result	: PASS	Humidity	: 55%RH

Package Type	Pulse width (ms)	Time slot length(ms)	Dwell time (ms)	Limit (s)	Modulation
DH1	0.396	time slot length *1600/2 /79 * 31.6	126.72	0.4	BDR
DH3	1.650	time slot length *1600/4 /79 * 31.6	264.00	0.4	BDR
DH5	2.896	time slot length *1600/6 /79 * 31.6	308.91	0.4	BDR
3DH1	0.408	time slot length *1600/2 /79 * 31.6	130.56	0.4	EDR
3DH3	1.660	time slot length *1600/4 /79 * 31.6	265.60	0.4	EDR
3DH5	2.912	time slot length *1600/6 /79 * 31.6	310.61	0.4	EDR

Remark: The EDR was tested on (  $\pi/4$ DQPSK, 8DPSK) modes, only the worst data of (8DPSK) is attached in the following pages.



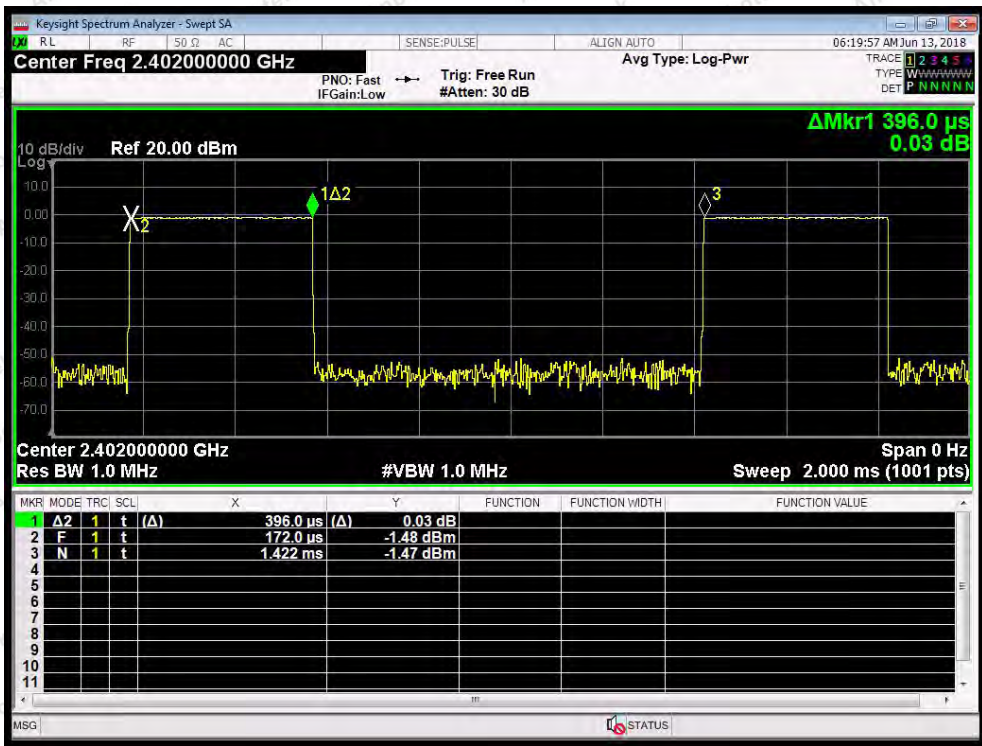

Test Mode: BDR---DH1

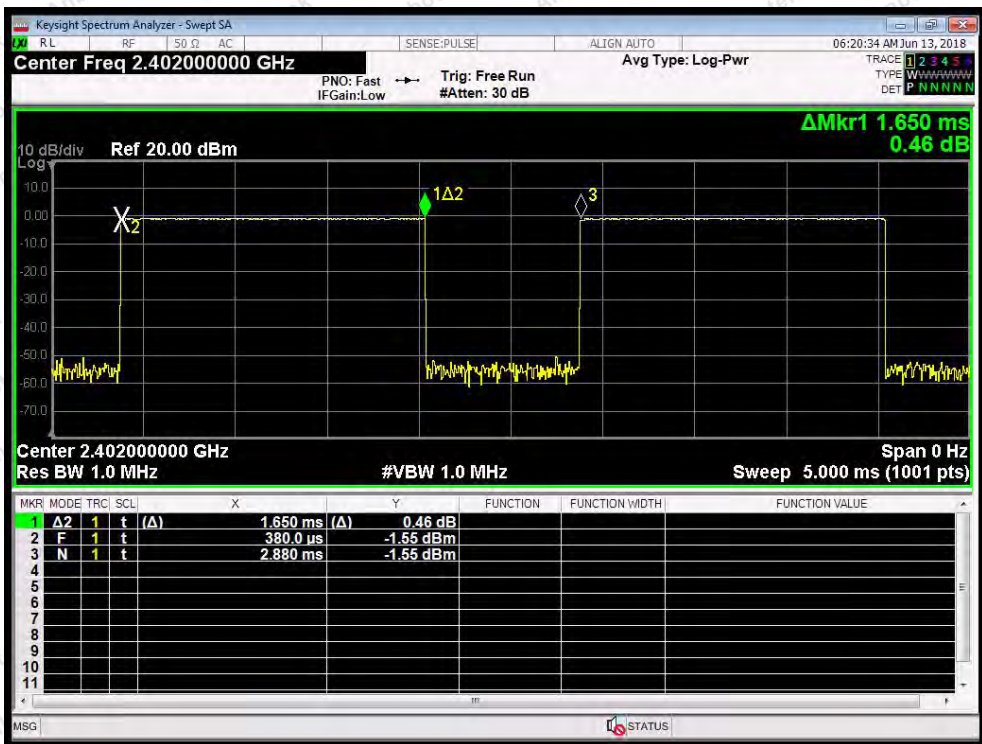

Test Mode: BDR---DH3



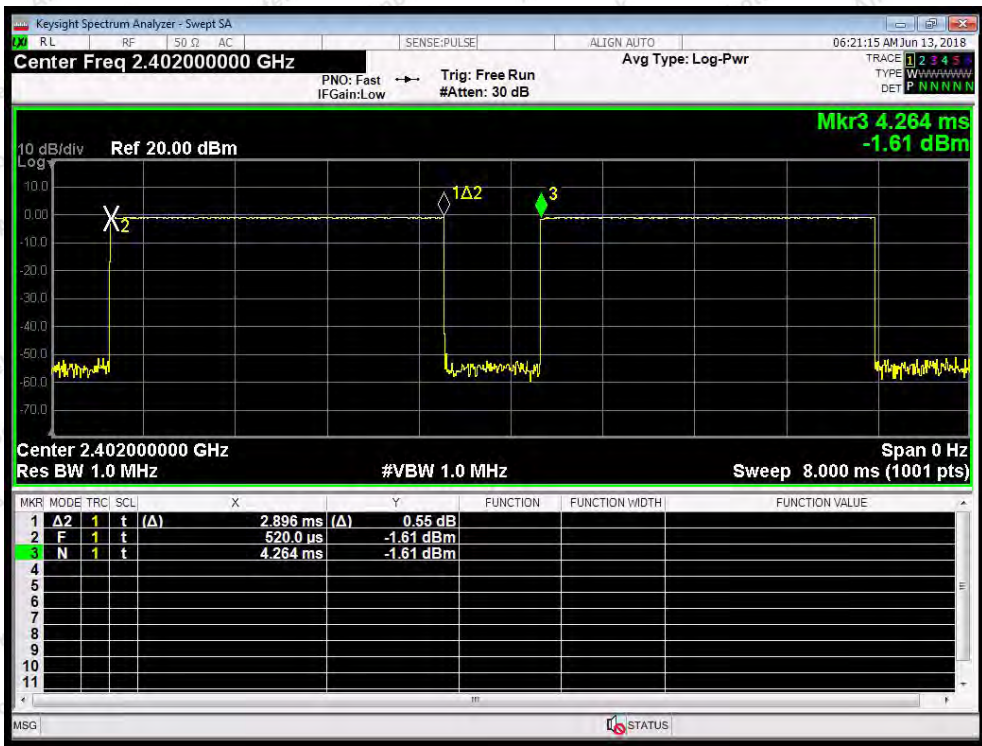

Test Mode: BDR—DH5

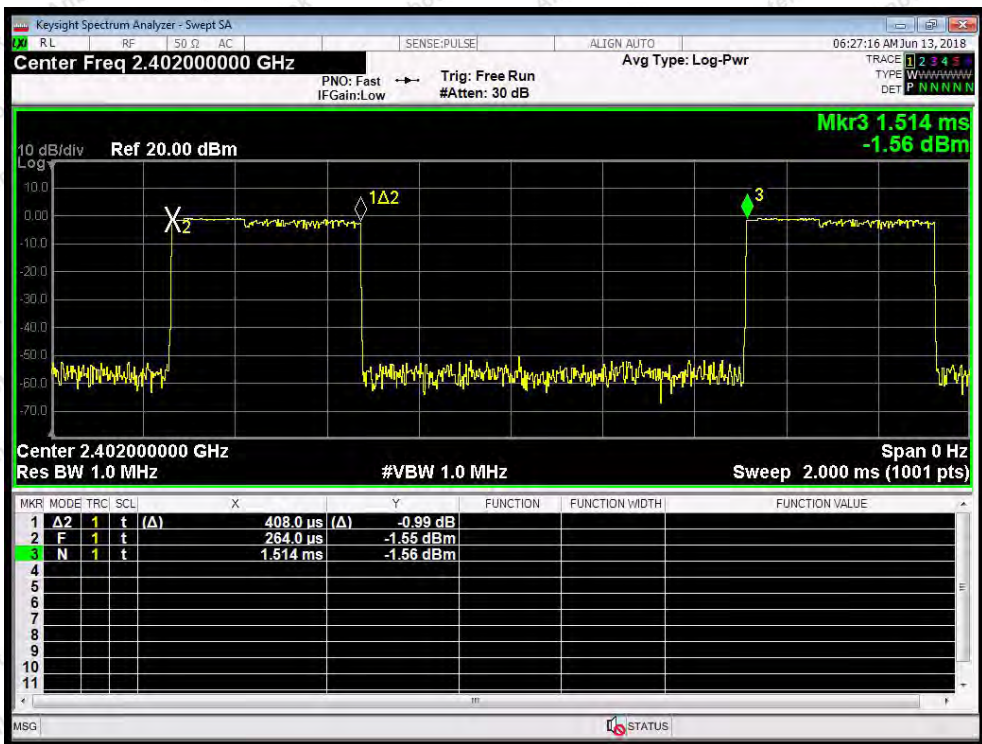

Test Mode: EDR---3DH1

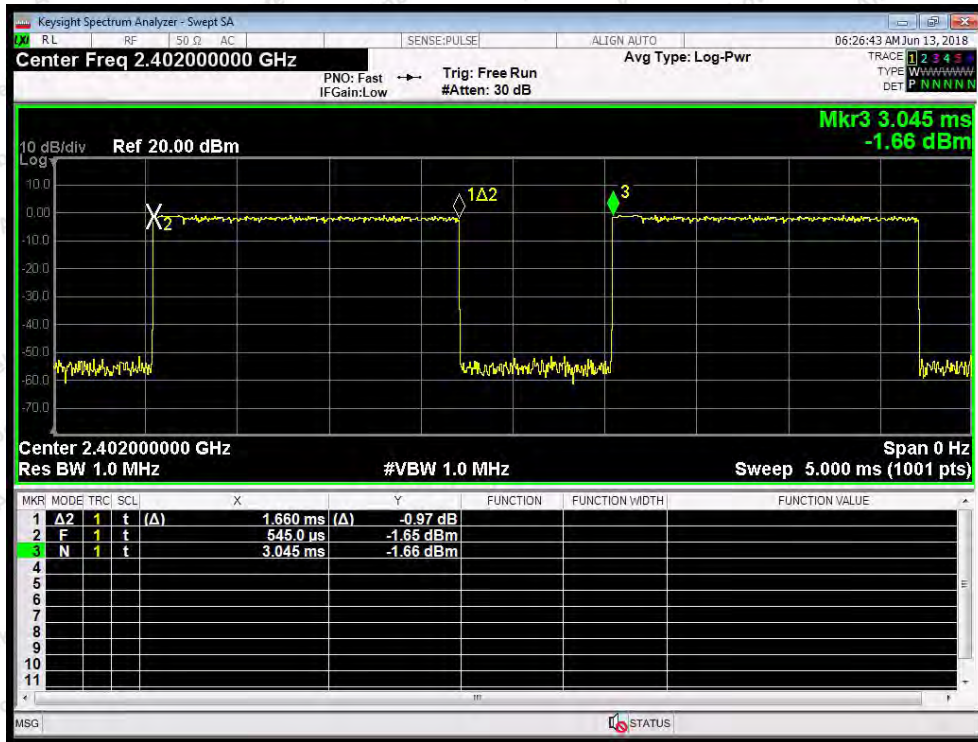

Test Mode: EDR---3DH3

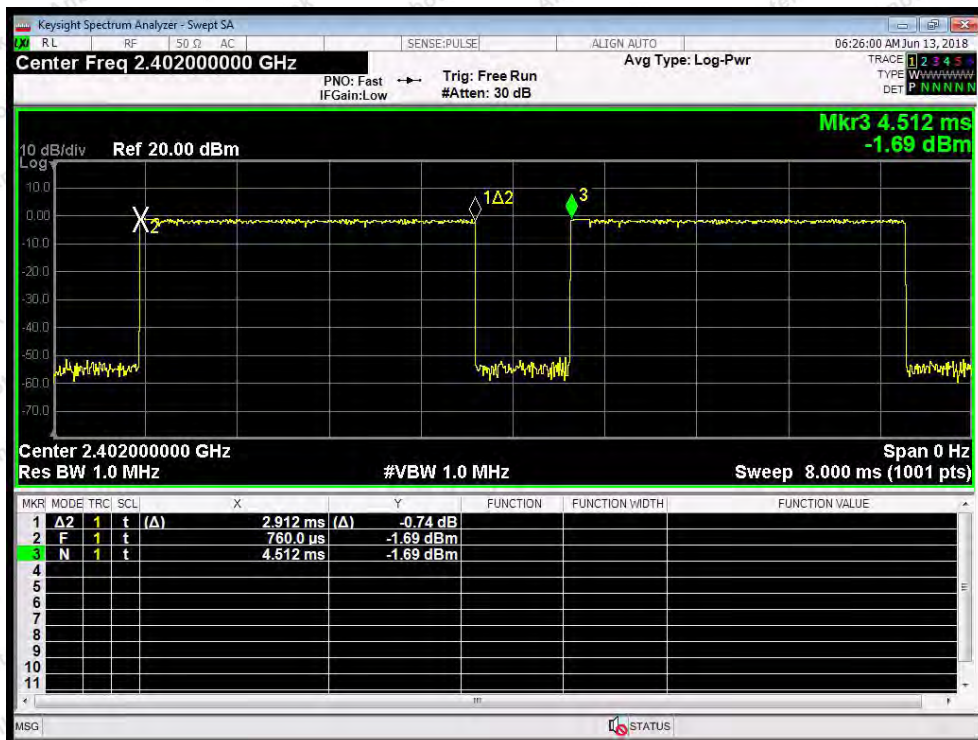

Test Mode: EDR—3DH5



## 10. 100kHz Bandwidth of Frequency Band Edge Requirement

### 10.1. Test Standard and Limit

Test Standard	FCC Part15 C Section 15.247 (d)
Test Limit	in any 100 kHz bandwidth outside the frequency bands in which the spread spectrum intentional radiator is operating, the radio frequency power that is produced by the intentional radiator shall be at least 20dB below that in the 100kHz bandwidth within the band that contains the highest level of the desired power, In addition, radiated emissions which fall in the restricted bands, as defined in §15.205(a), must also comply with the radiated emission limits specified in 15.209(a).

### 10.2. Test Setup

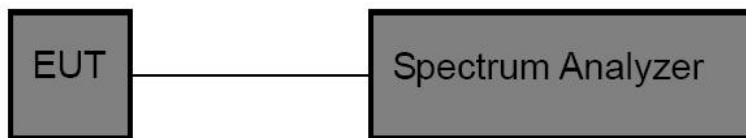

### 10.3. Test Procedure

The EUT must have its hopping/Non-hopping function enabled. Using the following spectrum analyzer setting:

1. Set the RBW = 100kHz.
2. Set the VBW = 300kHz.
3. Sweep time = auto couple.
4. Detector function = peak.
5. Trace mode = max hold.
6. Allow trace to fully stabilize.

### 10.4. Test Data

Test Item	: Band edge	Test Mode	: CH Low ~ CH High
Test Voltage	: AC 120V, 60Hz	Temperature	: 24°C
Test Result	: PASS	Humidity	: 55%RH

Remark: The EDR was tested on ( $\pi/4$ DQPSK, 8DPSK) modes, only the worst data of ( $\pi/4$ DQPSK) is attached in the following pages.



**For Hopping Mode**

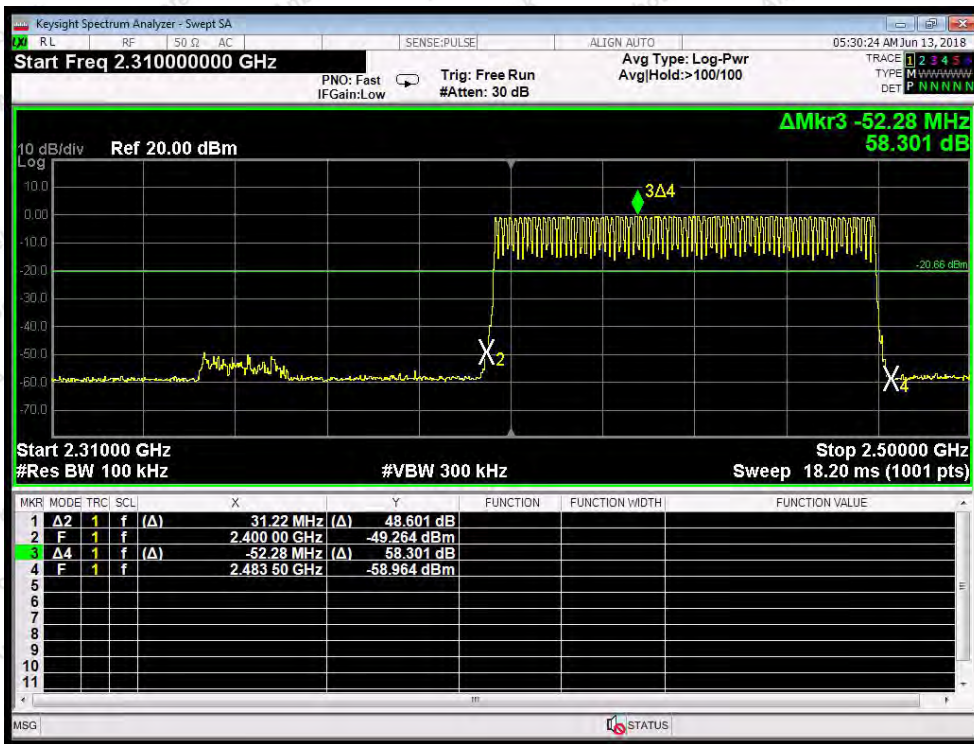

BDR mode

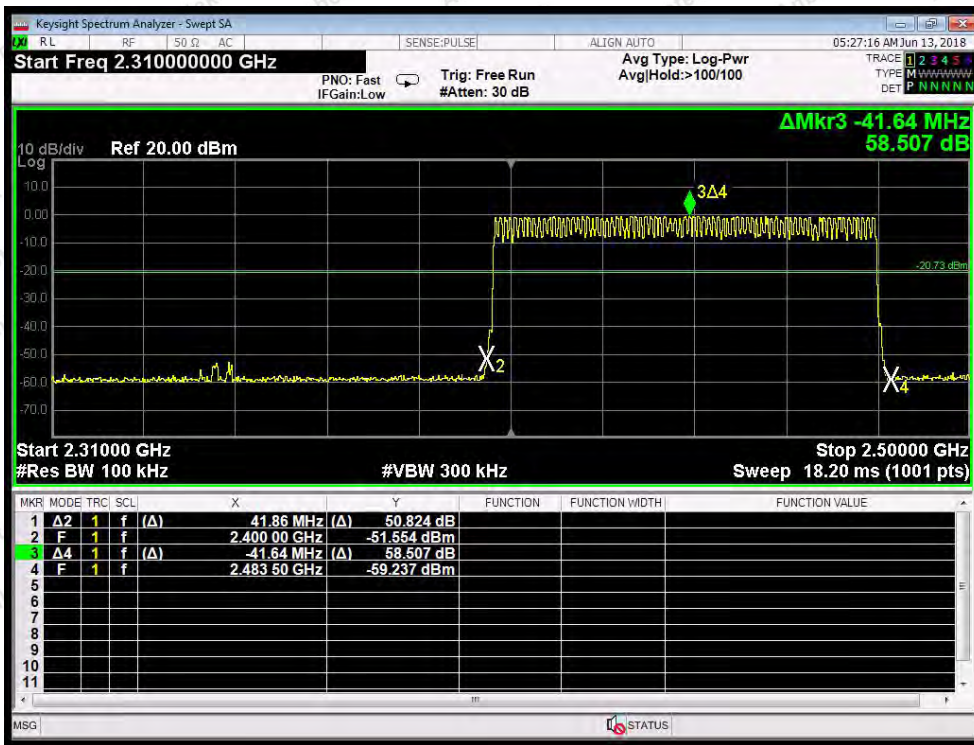

EDR mode

**For Non-Hopping Mode**

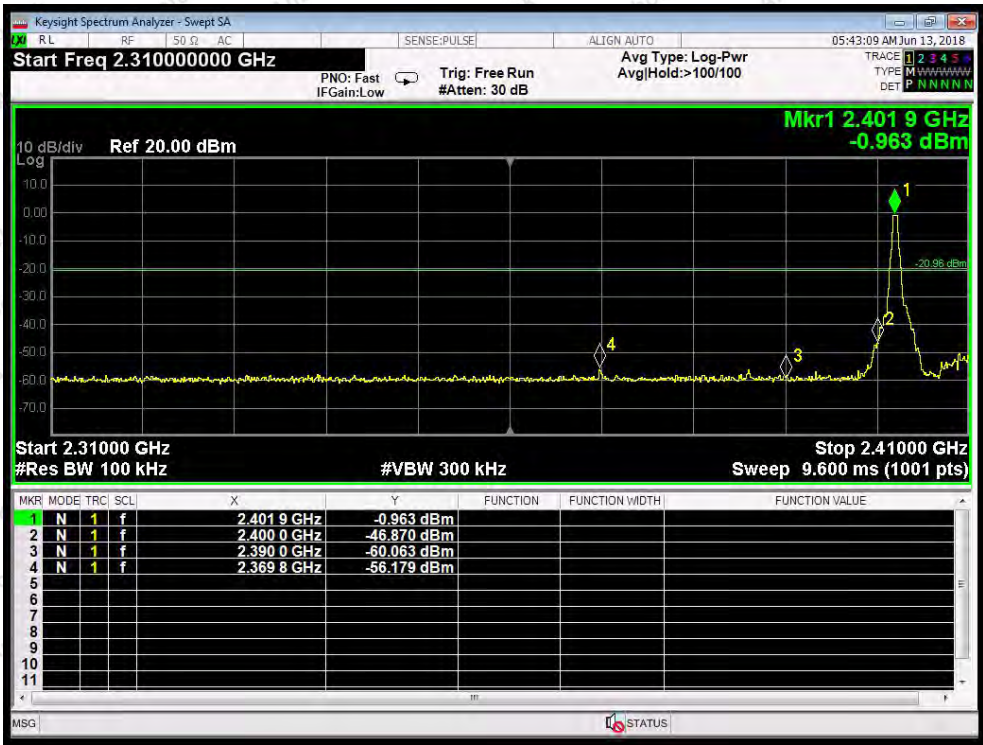

BDR mode -- Lowest

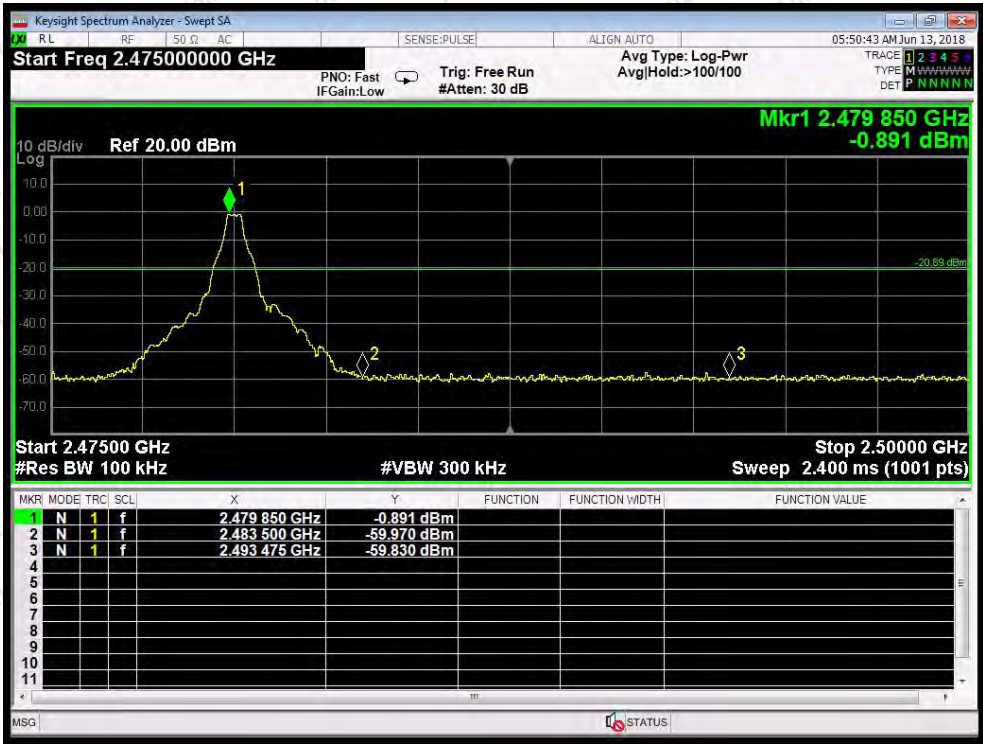

BDR mode -- Highest



**For Non-Hopping Mode**

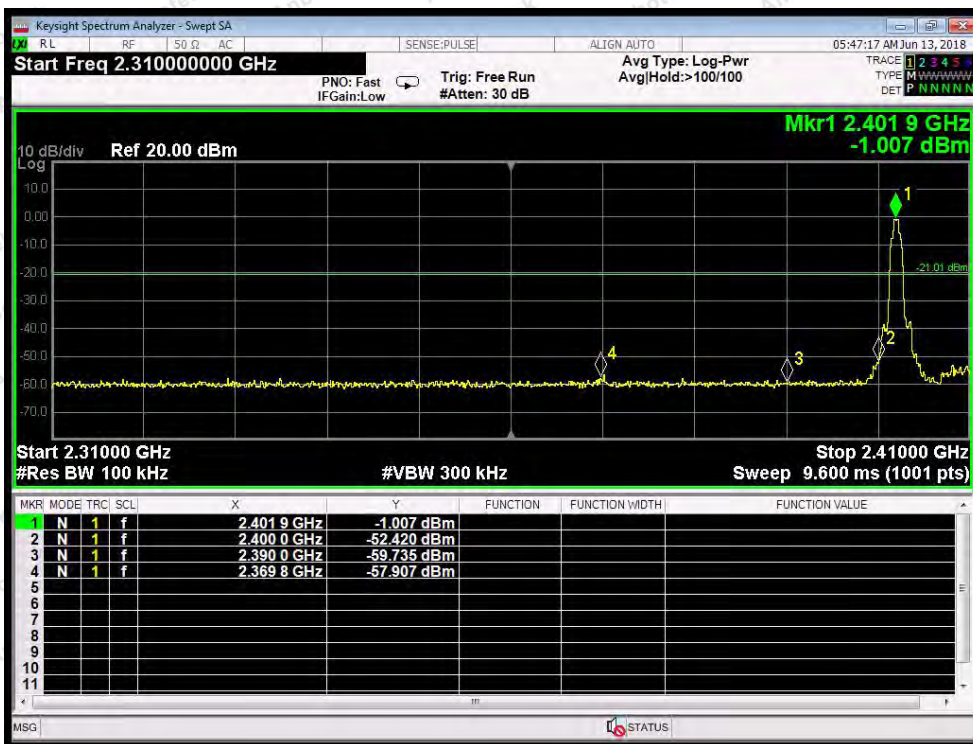

EDR mode -- Lowest

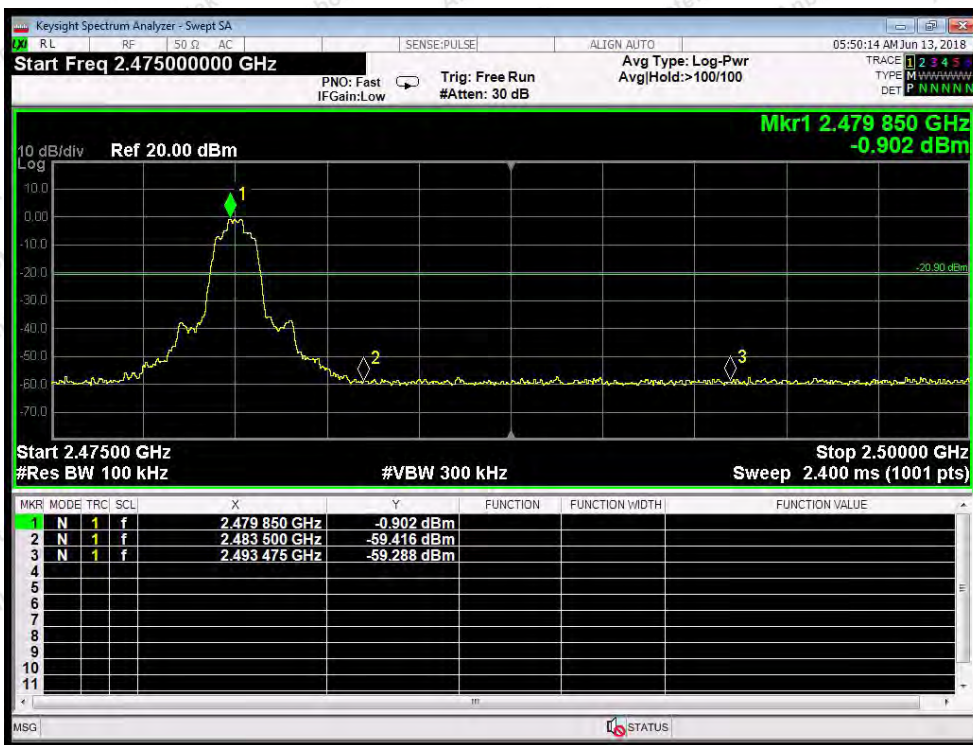

EDR mode -- Highest



Conducted Emission Method

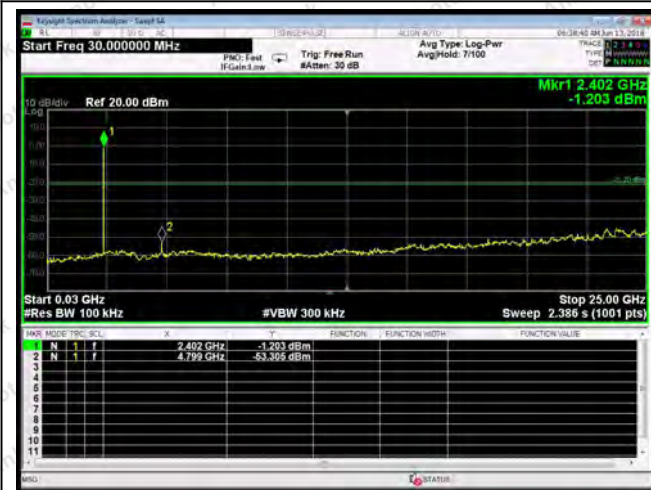

Test Mode: BDR---Low

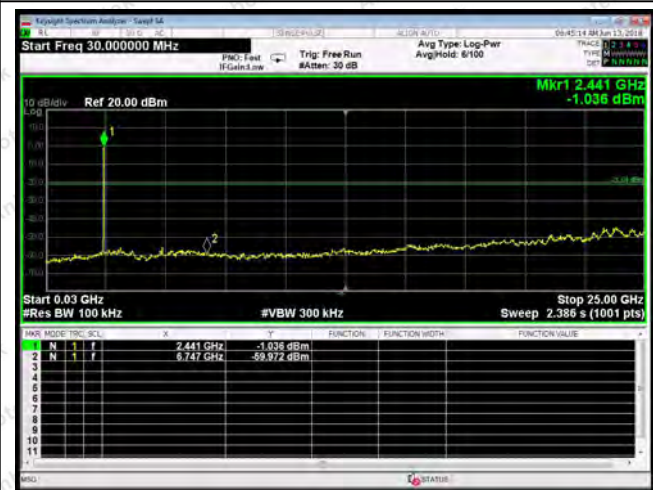

Test Mode: BDR---Mid

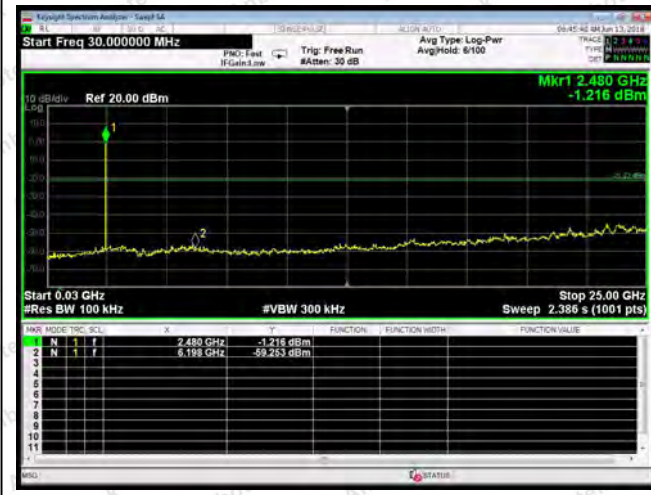

Test Mode: BDR---High

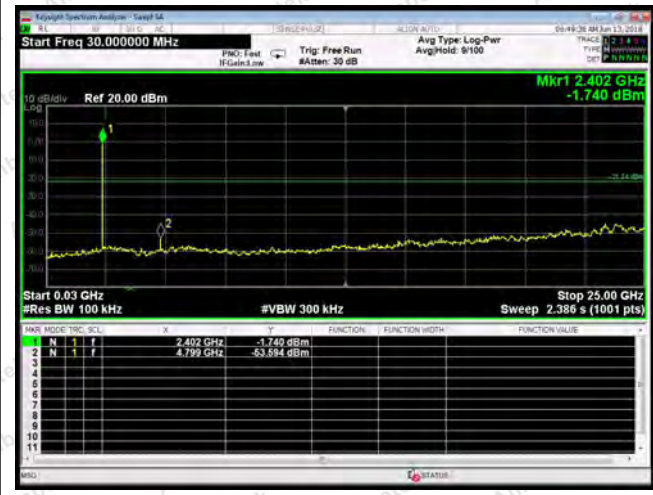

Test Mode: EDR---Low

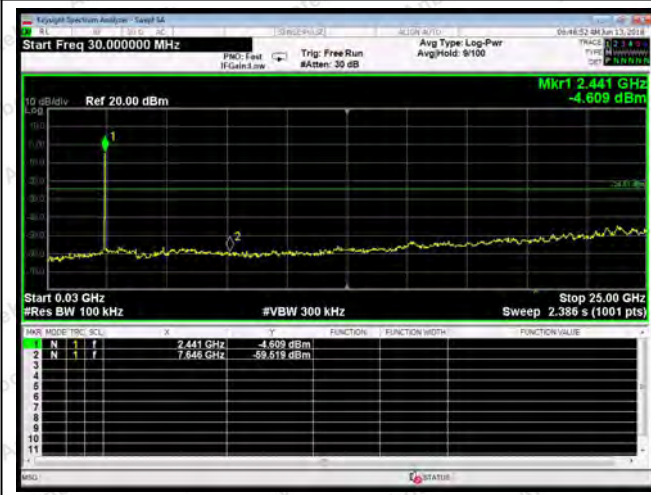

Test Mode: EDR---Mid

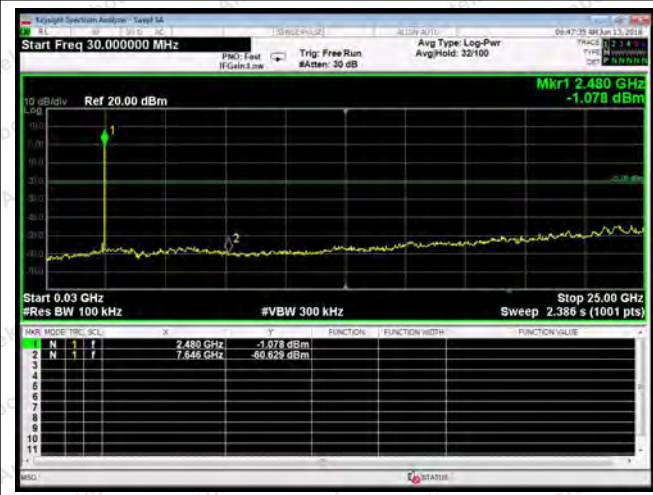

Test Mode: EDR---High

## 11. Antenna Requirement

### 11.1. Test Standard and Requirement

Test Standard	FCC Part15 Section 15.203 /247(c)
Requirement	<p>1) 15.203 requirement: An intentional radiator shall be designed to ensure that no antenna other than that furnished by the responsible party shall be used with the device. The use of a permanently attached antenna or of an antenna that uses a unique coupling to the intentional radiator, the manufacturer may design the unit so that a broken antenna can be replaced by the user, but the use of a standard antenna jack or electrical connector is prohibited.</p> <p>2) 15.247(c) (1)(i) requirement: Systems operating in the 2400-2483.5 MHz band that is used exclusively for fixed. Point-to-point operations may employ transmitting antennas with directional gain greater than 6dBi provided the maximum conducted output power of the intentional radiator is reduced by 1 dB for every 3 dB that the directional gain of the antenna exceeds 6 dBi.</p>

### 11.2. Antenna Connected Construction

The bluetooth antenna is PCB Antenna which permanently attached, and the best case gain of the antenna is 0 dBi. It complies with the standard requirement.

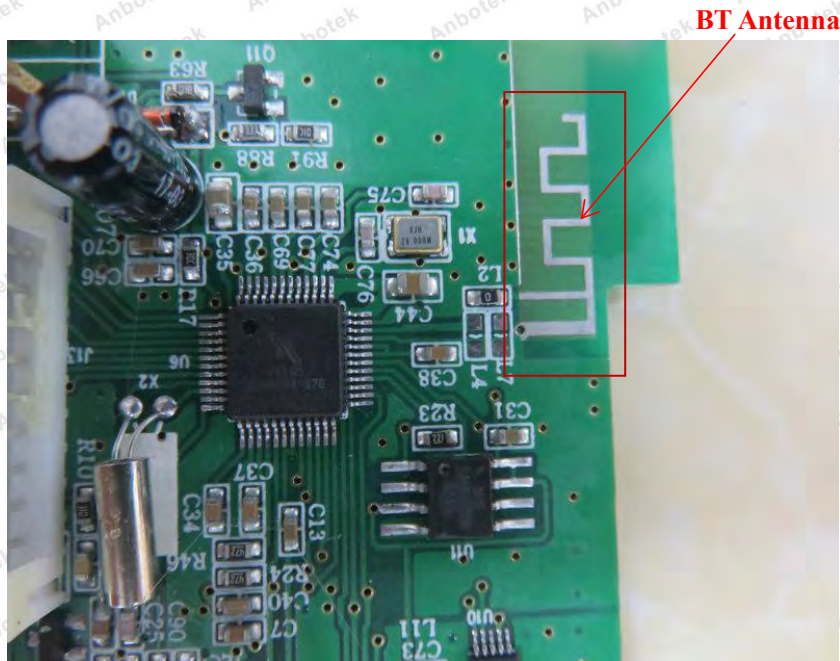



# APPENDIX I-- TEST SETUP PHOTOGRAPH

Photo of Conducted Emission Measurement



Photo of Radiation Emission Test

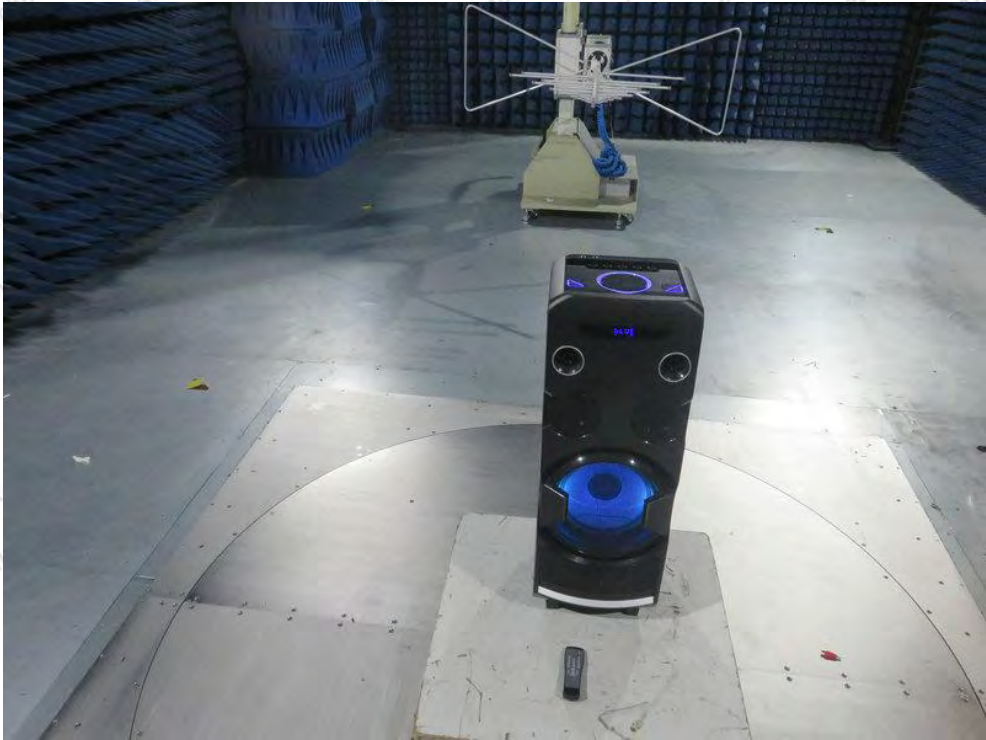



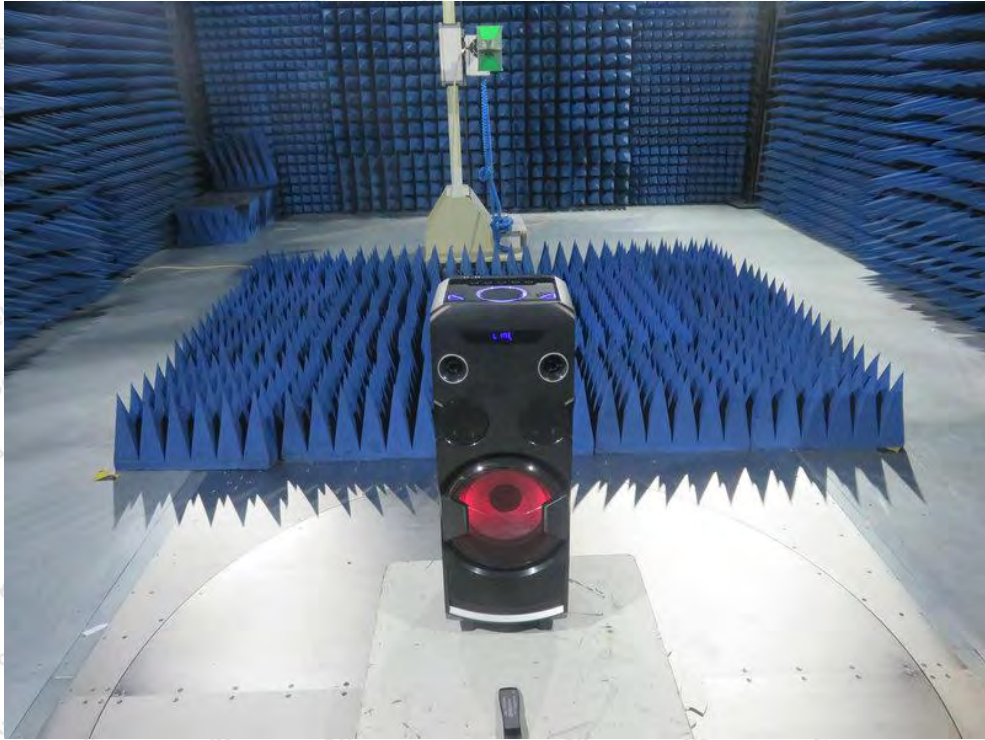

## APPENDIX II -- EXTERNAL PHOTOGRAPH













### APPENDIX III -- INTERNAL PHOTOGRAPH

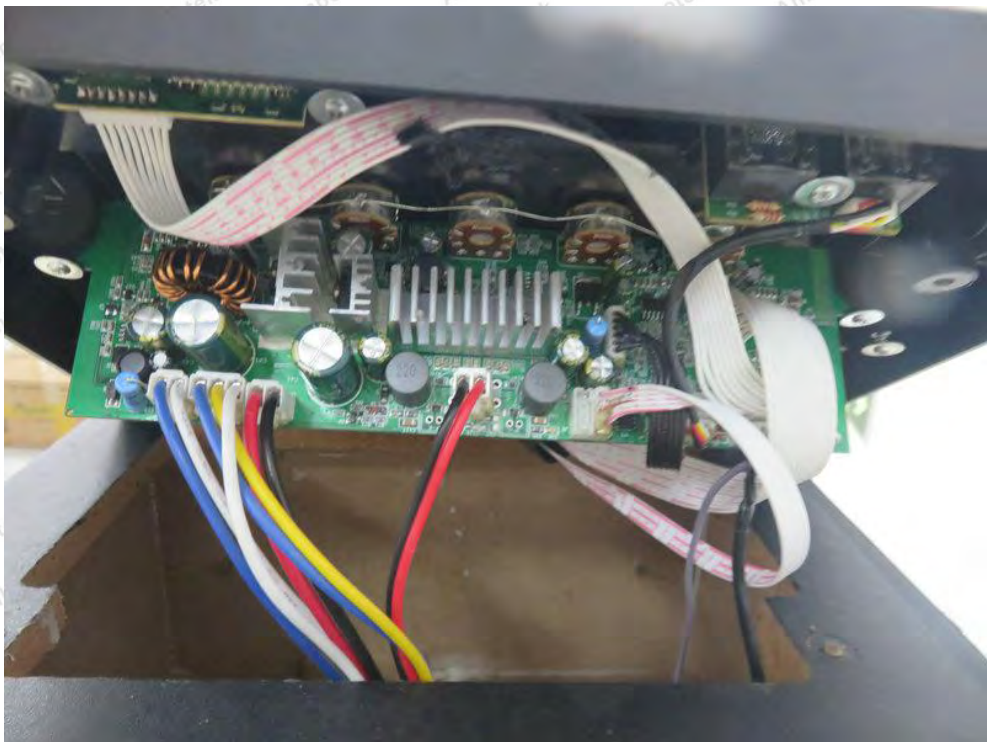







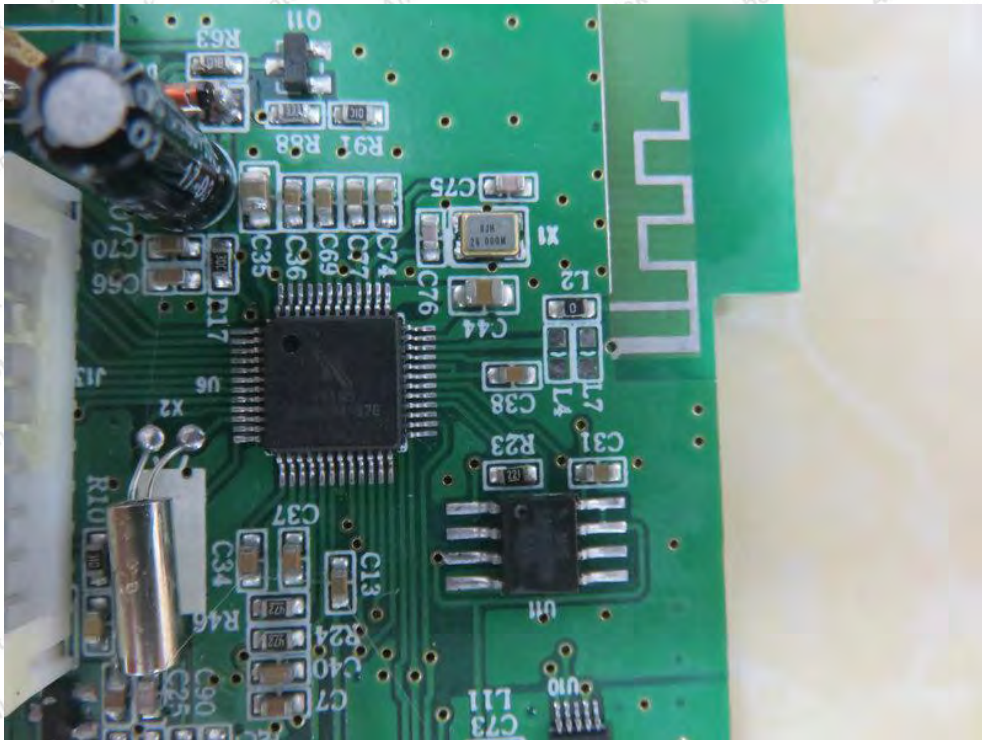



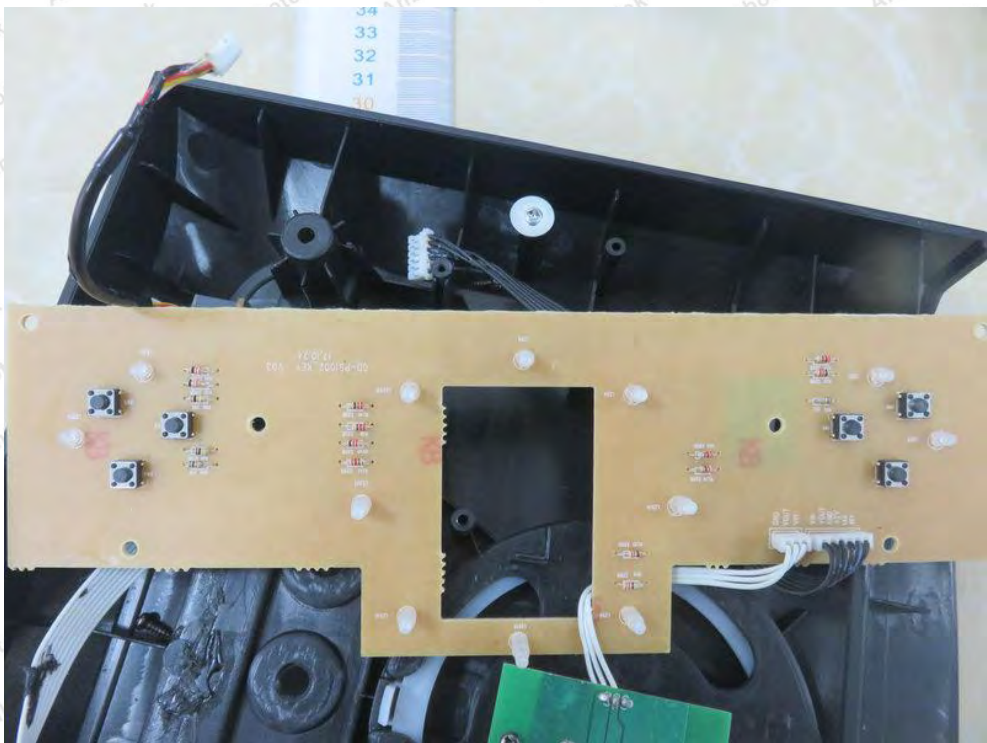
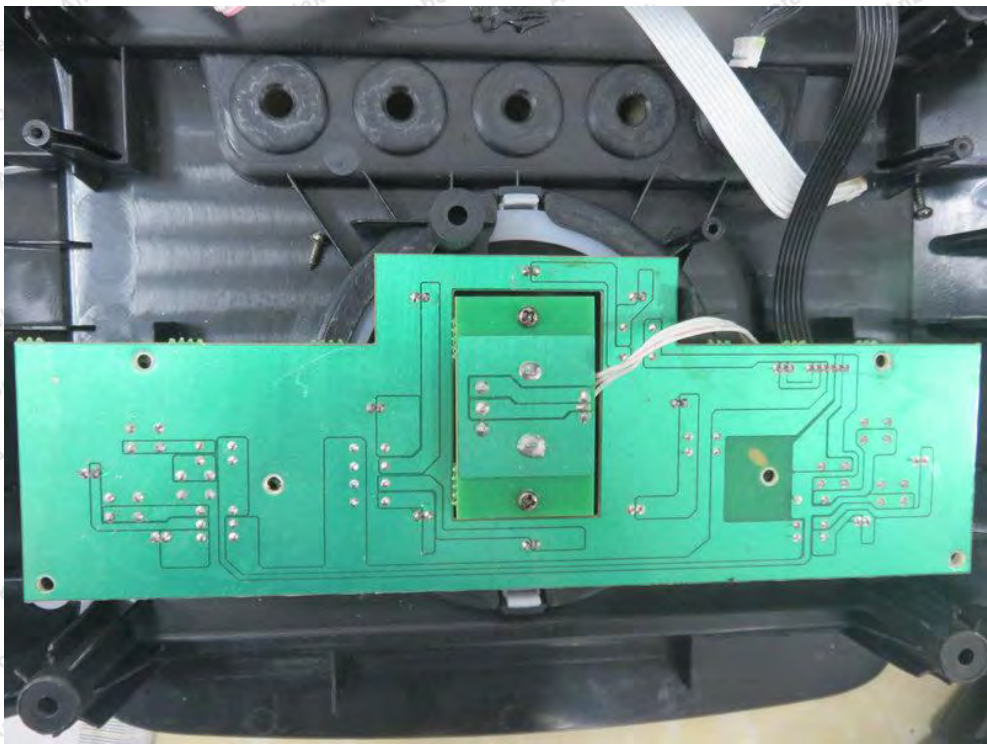

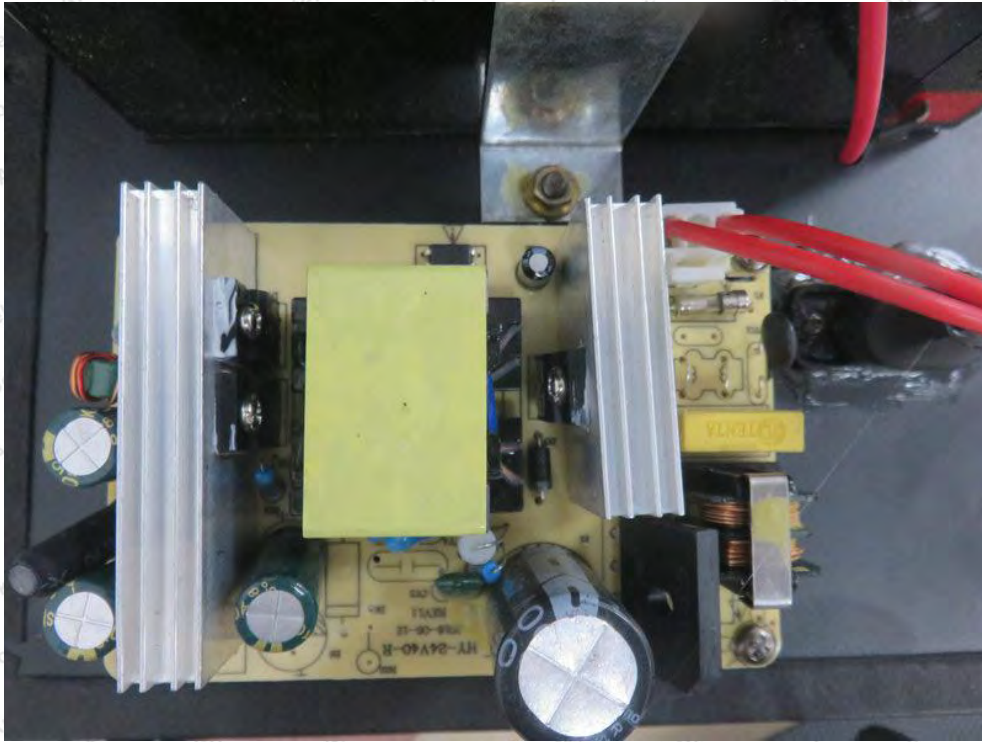



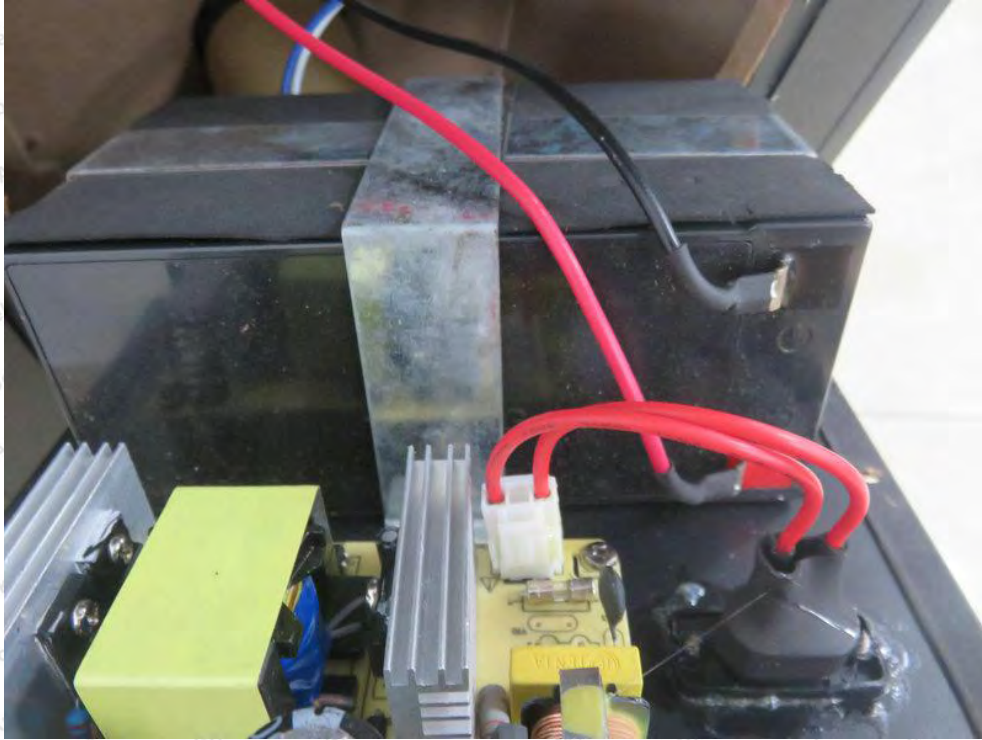

----- End of Report -----