

FCC TEST REPORT  
for  
Shenzhen Bominwell Robotics Co., Ltd.

Multi-Robot Control Panel  
Model No.: MCP

Prepared for : Shenzhen Bominwell Robotics Co., Ltd.  
Address : JK Units, 5F, Building 7, Baoneng Sci&Tech Park, Longhua  
Dist., Shenzhen, China

Prepared By : Shenzhen Anbotek Compliance Laboratory Limited  
Address : 1/F., Building 1, SEC Industrial Park, No.0409 Qianhai Road,  
Nanshan District, Shenzhen, Guangdong, China  
Tel: (86) 755-26066544  
Fax: (86) 755-26014772

Report Number : R011605878Y  
Date of Test : Jun. 02~ 21, 2016  
Date of Report : Jun. 22, 2016

**TABLE OF CONTENT**

Description

Page

Test Report

**1. GENERAL INFORMATION.....4**

    1.1. Description of Device (EUT).....4

    1.2. Auxiliary Equipment Used during Test.....5

    1.3. Description of Test Facility.....5

    1.4. Measurement Uncertainty.....5

**2. TEST METHODOLOGY.....6**

    2.1. Summary of Test Results.....6

    2.2. Description of Test Modes.....6

    2.3. List of channels:.....7

**3. CONDUCTED EMISSION TEST..... 8**

    3.1. Block Diagram of Test Setup.....8

    3.2. Power Line Conducted Emission Measurement Limits (15.207).....8

    3.3. Configuration of EUT on Measurement.....8

    3.4. Operating Condition of EUT.....8

    3.5. Test Procedure.....9

    3.6. Test equipment.....9

    3.7. Power Line Conducted Emission Measurement Results.....9

**4. FCC PART 15.247 REQUIREMENTS FOR DSSS & OFDM MODULATION..... 14**

    4.1 Test Setup.....14

    4.2 6dB Bandwidth.....14

    4.3. Maximum Output Power Test.....22

    4.4. Band Edges Measurement.....26

    4.5. Peak Power Spectral Density.....62

    4.6. Radiated Emissions.....66

**5. ANTENNA APPLICATION..... 77**

    5.1. Antenna requirement.....77

    5.2. Result.....77

**6. PHOTOGRAPH..... 78**

    6.1. Photo of Conducted Emission Measurement.....78

    6.2. Photo of Radiation Emission Test.....78

**APPENDIX I (EXTERNAL PHOTOS)..... 80**

**APPENDIX II (INTERNAL PHOTOS)..... 84**

## TEST REPORT

Applicant : Shenzhen Bominwell Robotics Co., Ltd.  
Manufacturer : Shenzhen Bominwell Robotics Co., Ltd.  
EUT : Multi-Robot Control Panel  
Model No. : MCP  
Serial No. : N.A.  
Trade Mark : Bominwell  
Rating : DC 12V, 2.5A Via Adapter  
(Input: AC 100-240V, 50-60Hz, 1.0A,  
Output: DC 13.0V, 3A)

Measurement Procedure Used:  
FCC Part15 Subpart C 2015, Paragraph 15.247

The device described above is tested by Shenzhen Anbotek Compliance Laboratory Limited to determine the maximum emission levels emanating from the device and the severe levels of the device can endure and its performance criterion. The measurement results are contained in this test report and Shenzhen Anbotek Compliance Laboratory Limited is assumed full of responsibility for the accuracy and completeness of these measurements. Also, this report shows that the EUT (Equipment Under Test) is technically compliant with the FCC Part 15 Subpart C requirements.

This report applies to above tested sample only and shall not be reproduced in part without written approval of Shenzhen Anbotek Compliance Laboratory Limited.

Date of Test : Jun. 02~ 21, 2016

Prepared by :

Kebo Zhang

(Tested Engineer / Kebo Zhang)

Reviewer :

Amy Ding

(Project Manager / Amy Ding)

Approved & Authorized Signer :

Tom Chen

(Manager / Tom Chen)

## 1. GENERAL INFORMATION

### 1.1. Description of Device (EUT)

EUT	: Multi-Robot Control Panel
Model Number	: MCP
Test Power Supply	: AC 120V, 60Hz for adapter/ AC 240V, 60Hz for adapter/ DC 12V Battery Inside
Adapter	: Model: EA10301 Input: 100-240V~, 50-60Hz, 1.0A Output: DC 12V, 2.5A
RF Transmission Frequency	: 2412MHz~2462MHz (802.11b/802.11g/802.11n(HT20)) 2422MHz~2452MHz ( 802.11n(HT40)) 433.92MHz
Channels	: 11 For (802.11b/802.11g/802.11n(HT20)) 7 For (802.11n(HT40)) 1 For (433.92MHz)
Modulation	WiFi: 802.11b CCK; 802.11g OFDM; 802.11n MCS 433.92MHz: ASK
Antenna Gain:	: 5 dBi for WiFi 1 dBi For (433.92MHz)
Applicant Address	: Shenzhen Bominwell Robotics Co., Ltd. JK Units, 5F, Building 7, Baoneng Sci&Tech Park, Longhua Dist., Shenzhen, China
Manufacturer Address	: Shenzhen Bominwell Robotics Co., Ltd. JK Units, 5F, Building 7, Baoneng Sci&Tech Park, Longhua Dist., Shenzhen, China
Factory Address	: Shenzhen Bominwell Robotics Co., Ltd. JK Units, 5F, Building 7, Baoneng Sci&Tech Park, Longhua Dist., Shenzhen, China
Date of receipt	: Jun. 02, 2016
Date of Test	: Jun. 02~ 21, 2016

## 1.2. Auxiliary Equipment Used during Test

N/A

## 1.3. Description of Test Facility

The test facility is recognized, certified, or accredited by the following organizations:

### **FCC-Registration No.: 752021**

Shenzhen Anbotek Compliance Laboratory Limited, EMC Laboratory has been registered and fully described in a report filed with the (FCC) Federal Communications Commission. The acceptance letter from the FCC is maintained in our files. Registration 752021, July 06, 2016.

### **IC-Registration No.: 8058A-1**

Shenzhen Anbotek Compliance Laboratory Limited., EMC Laboratory has been registered and fully described in a report filed with the (IC) Industry Canada. The acceptance letter from the IC is maintained in our files. Registration 8058A, Jun 13, 2016.

### **Test Location**

All Emissions tests were performed at Shenzhen Anbotek Compliance Laboratory Limited. at 1/F., Building 1, SEC Industrial Park, No.0409 Qianhai Road, Nanshan District, Shenzhen, Guangdong, China

## 1.4. Measurement Uncertainty

Radiation Uncertainty : Ur = 4.1 dB (Horizontal)  
Ur = 4.3 dB (Vertical)

Conduction Uncertainty : Uc = 3.4dB

## 2. TEST METHODOLOGY

The tests documented in this report were performed in accordance with ANSI C63.10: 2013 and FCC Part 15, Paragraph 15.247.

### 2.1. Summary of Test Results

The EUT has been tested according to the following specifications:

Standard	Test Type	Result	Notes
FCC Part 15, Paragraph 15.107, 15.207	Conducted Emission Test	PASS	Complies
FCC Part 15, Paragraph 15.247(b)(1)	Maximum Output Power	PASS	Complies
FCC Part 15, Paragraph 15.247(a)(2)	6dB Bandwidth	PASS	Complies
FCC Part 15, Paragraph 15.247(c)	100kHz Bandwidth of Frequency Band Edges	PASS	Complies
FCC Part 15, Paragraph 15.209(a)(f)	Spurious Emission	PASS	Complies
FCC Part 15, Paragraph 15.247(a)(1)	Frequency Separation	-	N/A
FCC Part 15, Paragraph 15.247(a)(1)(iii)	Number of Hopping Frequency	-	N/A
FCC Part 15, Paragraph 15.247(a)(1)(iii)	Time of Occupancy	-	N/A
FCC Part 15, Paragraph 15.247(c)	Peak Power Density	PASS	Complies

### 2.2. Description of Test Modes

The EUT has been tested under operating condition.

Software used to control the EUT for staying in continuous transmitting and receiving mode is programmed.

IEEE802.11b: Channel 1(2412MHz), Channel 6(2437MHz) and Channel 11(2462MHz) with 1 Mbps lowest data rate (worst case) are chosen for the final testing.

IEEE802.11g: Channel 1(2412MHz), Channel 6(2437MHz) and Channel 11(2462MHz) with 6 Mbps lowest data rate (the worst case) are chosen for the final testing.

IEEE802.11n (HT20): Channel 1(2412MHz), Channel 6(2437MHz) and Channel 11(2462MHz) with MCS 0 Mbps lowest data rate (the worst case) are chosen for the final testing.

IEEE802.11n (HT40): Channel 3(2422MHz), Channel 6(2437MHz) and Channel 9(2452MHz) with MCS 0 Mbps lowest data rate (the worst case) are chosen for the final testing.

## 2.3. List of channels:

√ - available

X - tested

Number	Frequency(MHz)		802.11 b/g/n (HT20)	802.11 b/g/n (HT40)
1	2412	√	X	
2	2417	√		
3	2422	√		X
4	2427	√		
5	2432	√		
6	2437	√	X	X
7	2442	√		
8	2447	√		
9	2452	√		X
10	2457	√		
11	2462	√	X	

### 3. Conducted Emission Test

#### 3.1. Block Diagram of Test Setup

##### 3.1.1. Block diagram of connection between the EUT and simulators

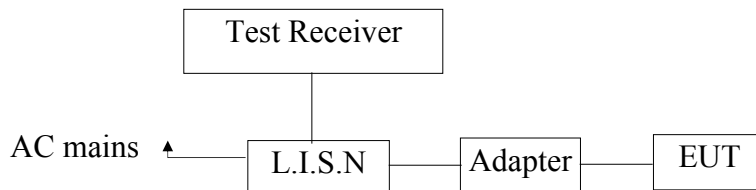

#### 3.2. Power Line Conducted Emission Measurement Limits (15.207)

Frequency MHz	Limits dB(μV)	
	Quasi-peak Level	Average Level
0.15 ~ 0.50	66 ~ 56*	56 ~ 46*
0.50 ~ 5.00	56	46
5.00 ~ 30.00	60	50

- Notes: 1. \*Decreasing linearly with logarithm of frequency.  
2. The lower limit shall apply at the transition frequencies.

#### 3.3. Configuration of EUT on Measurement

The following equipments are installed on Power Line Conducted Emission Measurement to meet the commission requirement and operating regulations in a manner which tends to maximize its emission characteristics in a normal application.

#### 3.4. Operating Condition of EUT

- 3.4.1. Setup the EUT and simulator as shown as Section 3.1.
- 3.4.2. Turn on the power of all equipment.
- 3.4.3. Let the EUT work in test mode (Charging) and measure it.

### 3.5. Test Procedure

The EUT system is connected to the power mains through a line impedance stabilization network (L.I.S.N.). This provides a 50ohm coupling impedance for the EUT system. Please refer the block diagram of the test setup and photographs. Both sides of AC line are checked to find out the maximum conducted emission. In order to find the maximum emission levels, the relative positions of equipment and all of the interface cables shall be changed according to FCC ANSI C63.10-2013 on Conducted Emission Measurement.

The bandwidth of test receiver (ESCI) set at 9KHz.

The frequency range from 150KHz to 30MHz is checked.

The test results are reported on Section 3.6.

### 3.6. Test equipment

Item	Equipment	Manufacturer	Model No.	Serial No.	Last Cal.	Cal. Interval
1.	Two-Line V-network	Rohde & Schwarz	ENV216	100055	Apr. 17, 2016	1 Year
2.	EMI Test Receiver	Rohde & Schwarz	ESCI	100627	Apr. 17, 2016	1 Year
3.	RF Switching Unit	Compliance Direction	RSU-M2	38303	Apr. 17, 2016	1 Year

### 3.7. Power Line Conducted Emission Measurement Results

**PASS.**

The frequency range from 150KHz to 30 MHz is investigated.

Please refer the following pages.

**CONDUCTED EMISSION TEST DATA**

Test Site: 1# Shielded Room  
 Operating Condition: Charging  
 Test Specification: AC 120V, 60Hz for adapter  
 Comment: Live Line  
 Tem.:24°C Hum.:49%

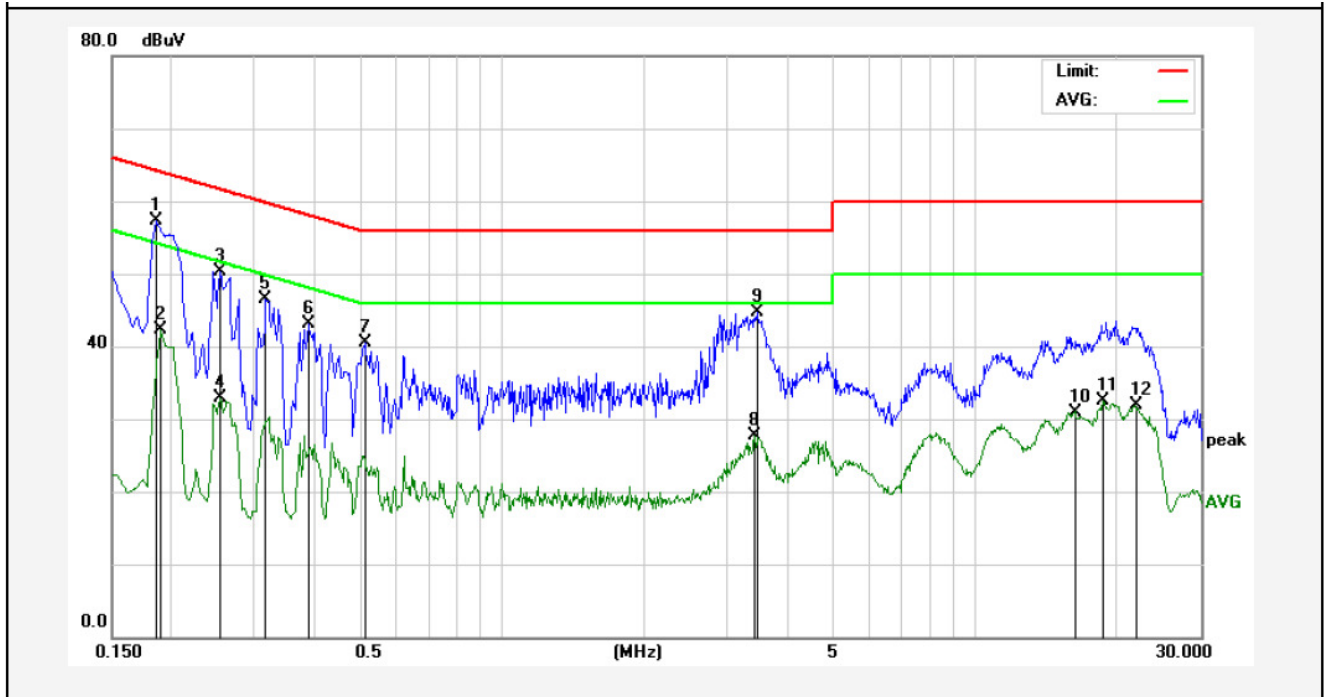

No.	Freq. (MHz)	Reading (dBuV)	Factor (dB)	Result (dBuV)	Limit dBuV	Over Limit (dB)	Detector	Remark
1	0.1860	37.36	20.00	57.36	64.21	-6.85	QP	
2	0.1900	22.25	20.00	42.25	54.03	-11.78	AVG	
3	0.2540	30.23	20.00	50.23	61.62	-11.39	QP	
4	0.2540	12.94	20.00	32.94	51.62	-18.68	AVG	
5	0.3180	26.51	20.00	46.51	59.76	-13.25	QP	
6	0.3899	23.09	20.00	43.09	58.06	-14.97	QP	
7	0.5140	20.55	20.00	40.55	56.00	-15.45	QP	
8	3.4300	7.76	20.00	27.76	46.00	-18.24	AVG	
9	3.4660	24.75	20.00	44.75	56.00	-11.25	QP	
10	16.2260	11.00	20.00	31.00	50.00	-19.00	AVG	
11	18.6620	12.58	20.00	32.58	50.00	-17.42	AVG	
12	21.7380	11.97	20.00	31.97	50.00	-18.03	AVG	

**CONDUCTED EMISSION TEST DATA**

Test Site: 1# Shielded Room  
 Operating Condition: Charging  
 Test Specification: AC 120V, 60Hz for adapter  
 Comment: Neutral Line  
 Tem.:24°C Hum.:49%

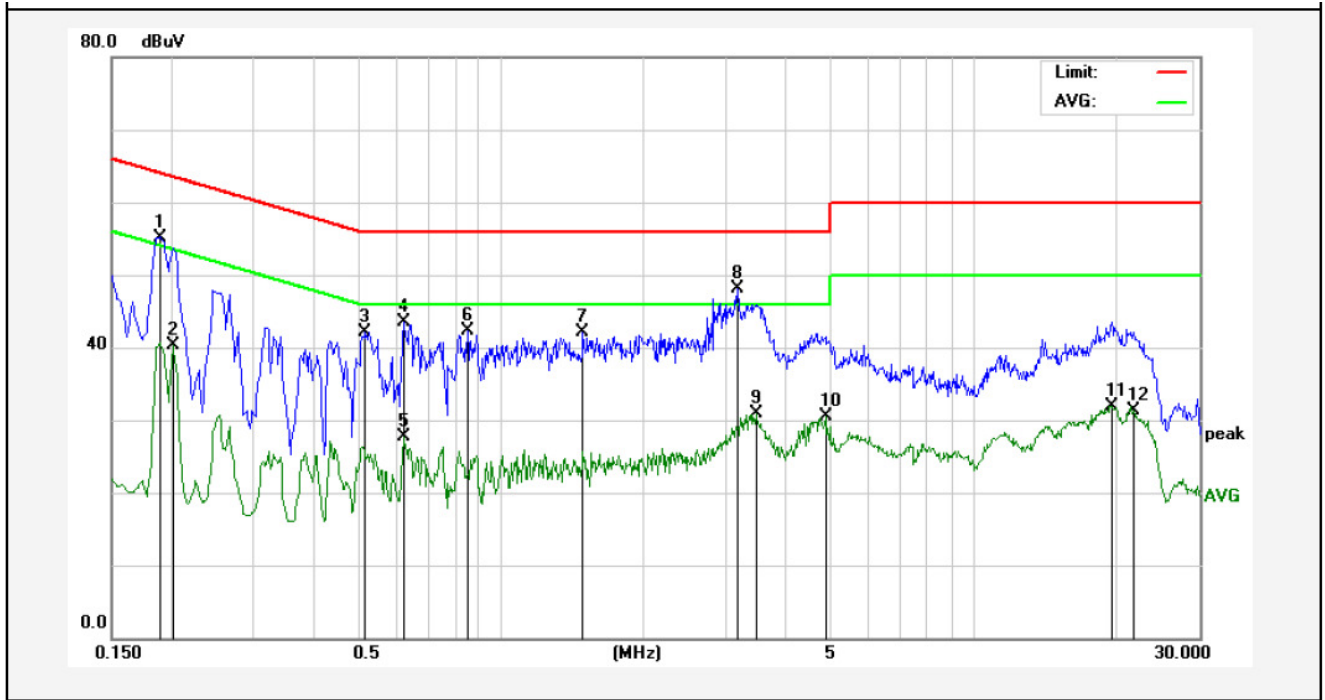

No.	Freq. (MHz)	Reading (dBuV)	Factor (dB)	Result (dBuV)	Limit dBuV	Over Limit (dB)	Detector	Remark
1	0.1900	35.20	20.00	55.20	64.03	-8.83	QP	
2	0.2020	20.38	20.00	40.38	53.52	-13.14	AVG	
3	0.5180	22.16	20.00	42.16	56.00	-13.84	QP	
4	0.6220	23.43	20.00	43.43	56.00	-12.57	QP	
5	0.6260	7.62	20.00	27.62	46.00	-18.38	AVG	
6	0.8500	22.27	20.00	42.27	56.00	-13.73	QP	
7	1.4900	22.11	20.00	42.11	56.00	-13.89	QP	
8	3.1619	28.02	20.00	48.02	56.00	-7.98	QP	
9	3.4660	10.86	20.00	30.86	46.00	-15.14	AVG	
10	4.8540	10.44	20.00	30.44	46.00	-15.56	AVG	
11	19.6020	11.98	20.00	31.98	50.00	-18.02	AVG	
12	21.7580	11.40	20.00	31.40	50.00	-18.60	AVG	

**CONDUCTED EMISSION TEST DATA**

Test Site: 1# Shielded Room  
 Operating Condition: Charging  
 Test Specification: AC 240V, 60Hz for adapter  
 Comment: Live Line  
 Tem.:24°C Hum.:49%

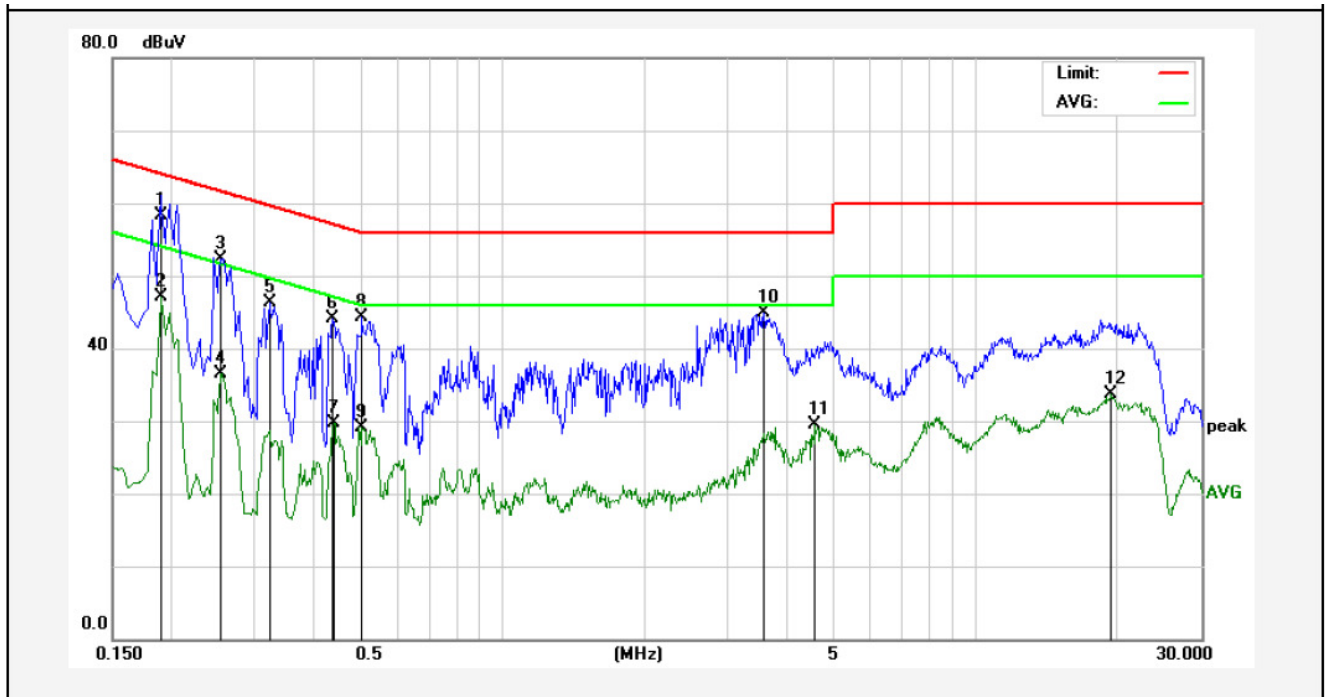

No.	Freq. (MHz)	Reading (dBuV)	Factor (dB)	Result (dBuV)	Limit dBuV	Over Limit (dB)	Detector	Remark
1	0.1900	38.37	20.00	58.37	64.03	-5.66	QP	
2	0.1900	27.19	20.00	47.19	54.03	-6.84	AVG	
3	0.2540	32.37	20.00	52.37	61.62	-9.25	QP	
4	0.2540	16.55	20.00	36.55	51.62	-15.07	AVG	
5	0.3220	26.32	20.00	46.32	59.65	-13.33	QP	
6	0.4380	24.13	20.00	44.13	57.10	-12.97	QP	
7	0.4420	9.74	20.00	29.74	47.02	-17.28	AVG	
8	0.5060	24.32	20.00	44.32	56.00	-11.68	QP	
9	0.5060	9.10	20.00	29.10	46.00	-16.90	AVG	
10	3.5660	24.95	20.00	44.95	56.00	-11.05	QP	
11	4.5739	9.43	20.00	29.43	46.00	-16.57	AVG	
12	19.4020	13.73	20.00	33.73	50.00	-16.27	AVG	

**CONDUCTED EMISSION TEST DATA**

Test Site: 1# Shielded Room  
 Operating Condition: Charging  
 Test Specification: AC 240V, 60Hz for adapter  
 Comment: Neutral Line  
 Tem.:24°C Hum.:49%

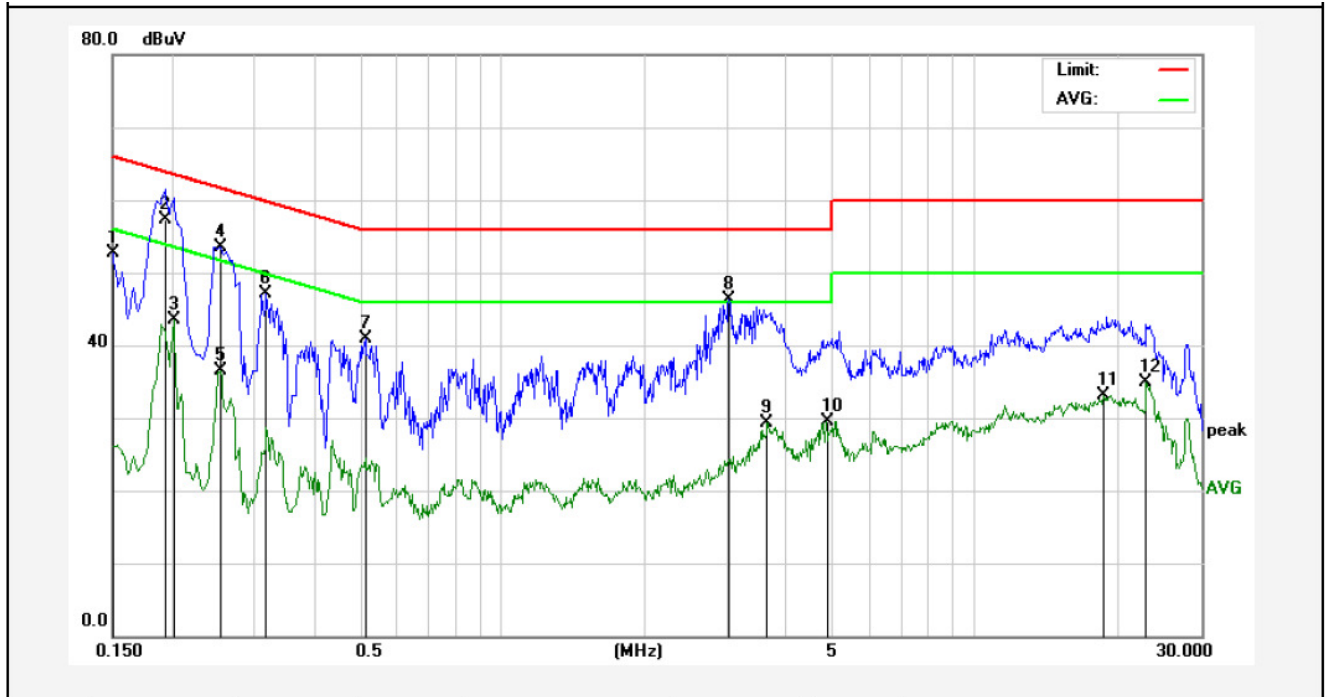

No.	Freq. (MHz)	Reading (dBuV)	Factor (dB)	Result (dBuV)	Limit dBuV	Over Limit (dB)	Detector	Remark
1	0.1500	32.74	20.00	52.74	65.99	-13.25	QP	
2	0.1940	37.24	20.00	57.24	63.86	-6.62	QP	
3	0.2020	23.52	20.00	43.52	53.52	-10.00	AVG	
4	0.2540	33.43	20.00	53.43	61.62	-8.19	QP	
5	0.2540	16.58	20.00	36.58	51.62	-15.04	AVG	
6	0.3180	27.08	20.00	47.08	59.76	-12.68	QP	
7	0.5140	20.87	20.00	40.87	56.00	-15.13	QP	
8	3.0220	26.28	20.00	46.28	56.00	-9.72	QP	
9	3.6380	9.28	20.00	29.28	46.00	-16.72	AVG	
10	4.8300	9.58	20.00	29.58	46.00	-16.42	AVG	
11	18.7180	13.07	20.00	33.07	50.00	-16.93	AVG	
12	22.9660	14.81	20.00	34.81	50.00	-15.19	AVG	

## 4. FCC Part 15.247 Requirements for DSSS & OFDM Modulation

### 4.1 Test Setup

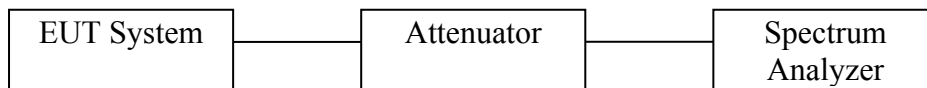

### 4.2 6dB Bandwidth

#### a. Limit

For the direct sequence systems, the minimum 6dB bandwidth shall be at least 500kHz.

#### b. Test Procedure

1. Place the EUT on the table and set it in the transmitting mode.
2. Remove the antenna from the EUT and then connect a low loss RF cable from the antenna port to the spectrum analyzer.
3. Set the spectrum analyzer as:  
RBW = 100kHz, VBW $\geq$ 3\*RBW =300kHz,  
Detector= Peak  
Trace mode= Max hold.  
Sweep- auto couple.
4. Mark the peak frequency and -6dB (upper and lower) frequency.
5. Repeat until all the rest channels are investigated.

#### 20dB Bandwidth:

##### C63.10

#### Occupied Bandwidth (OBW=20dB Bandwidth)

1. Set RBW=1%~5% OBW
2. Set the VBW $\geq$ 3\*RBW
3. Set the span range between 2 times and 5 times of the OBW
4. Sweep Time= Auto  
Detector= Peak  
Trace= Max hold
5. Once the reference level is established, the equipment is conditioned with typical modulating signals to produce the worst case (i.e. the widest) bandwidth. Unless otherwise specified for an unlicensed wireless device, measure the bandwidth at the -20dB levels with respect to the reference level.

**c. Test Setup See 4.1**

**d. Test Equipment**

Item	Equipment	Manufacturer	Model No.	Serial No.	Last Cal.	Cal. Interval
1.	Spectrum Analysis	Agilent	E4407B	US39390582	Apr. 17, 2016	1 Year
2.	Preamplifier	Instruments corporation	EMC011830	980100	Apr. 17, 2016	1 Year
3.	EMI Test Receiver	Rohde & Schwarz	ESPI	101604	Apr. 17, 2016	1 Year
4.	Double Ridged Horn Antenna	Instruments corporation	GTH-0118	351600	Apr. 20, 2016	1 Year
5.	Bilog Broadband Antenna	Schwarzbeck	VULB9163	VULB 9163-289	Apr. 20, 2016	1 Year
6.	Pre-amplifier	SONOMA	310N	186860	Apr. 17, 2016	1 Year
7.	EMI Test Software EZ-EMC	SHURPLE	N/A	N/A	N/A	N/A
8	Power Sensor	DAER	RPR3006W	15I00041SN046	Jun 30, 2015	1 Year
9	MXA Spectrum Analysis	Agilent	N9020A	MY51170037	Jun 30, 2015	1 Year
10	MXG RF Vector Signal Generator	Agilent	N5182A	MY48180656	Jun 30, 2015	1 Year
11	Signal Generator	Agilent	E4421B	MY41000743	Jun 30, 2015	1 Year
12	DC Power supply	IV	IV-8080	YQSB0096	Jun 30, 2015	1 Year
13	TEMP&HUMI PROGRAMMABLE CHAMBER	Bell Group	BE-THK-150M8	SE-0137	Mar 16, 2016	1 Year

**e. Test Results**

Pass.

**f. Test Data**

**6dB Bandwidth**

Test mode: IEEE 802.11b

Channel	Frequency (MHz)	Bandwidth (MHz)	Limit (kHz)	Results
Low	2412	10.02		Pass
Mid	2437	9.989	>500	Pass
High	2462	9.575		Pass

Test mode: IEEE 802.11g

Channel	Frequency (MHz)	Bandwidth (MHz)	Limit (kHz)	Results
Low	2412	15.46		Pass
Mid	2437	15.44	>500	Pass
High	2462	15.33		Pass

Test mode: IEEE 802.11n (HT20)

Channel	Frequency (MHz)	Bandwidth (MHz)	Limit (kHz)	Results
Low	2412	15.68		Pass
Mid	2437	16.90	>500	Pass
High	2462	15.12		Pass

Test mode: IEEE 802.11n (HT40)

Channel	Frequency (MHz)	Bandwidth (MHz)	Limit (kHz)	Results
Low	2422	35.17		Pass
Mid	2437	35.18	>500	Pass
High	2452	35.35		Pass

Test Plots See the following page.

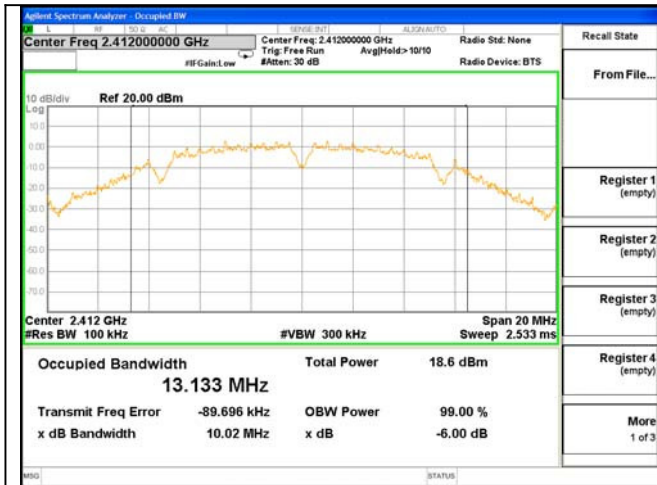

Test Mode: 802.11b---Low

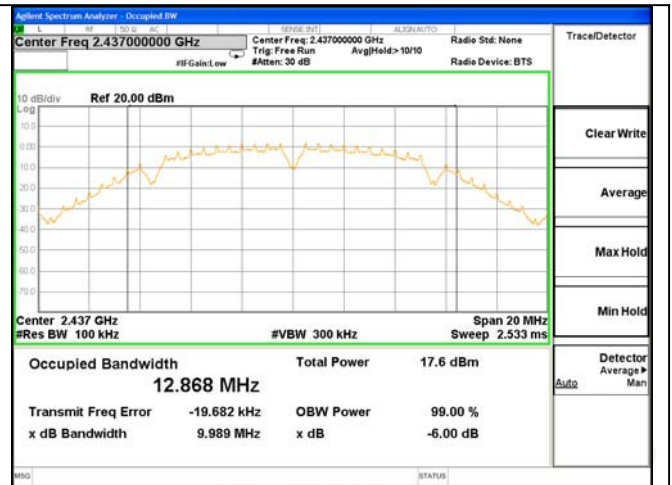

Test Mode: 802.11b---Mid

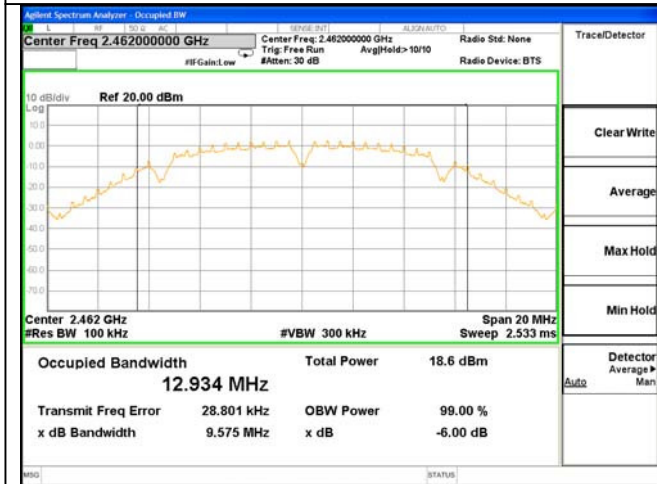

Test Mode: 802.11b---High

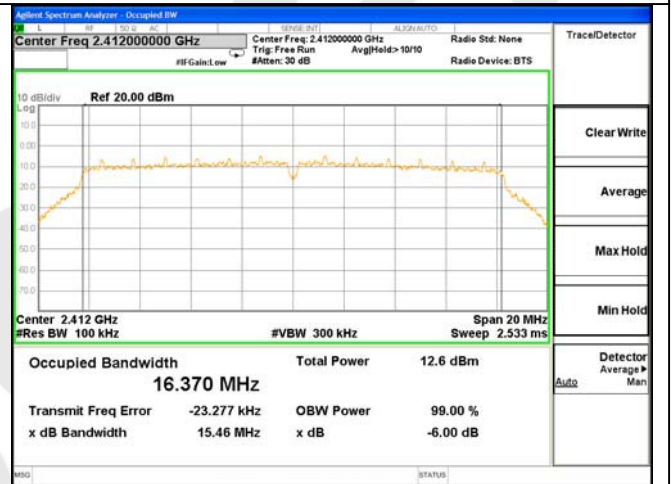

Test Mode: 802.11g---Low

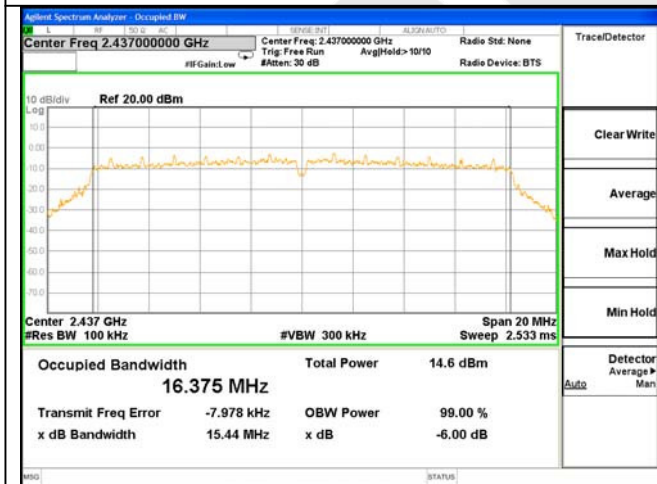

Test Mode: 802.11g---Mid

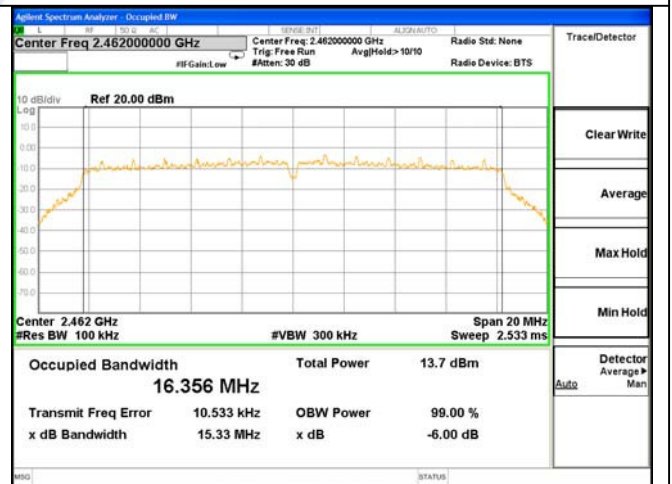

Test Mode: 802.11g---High

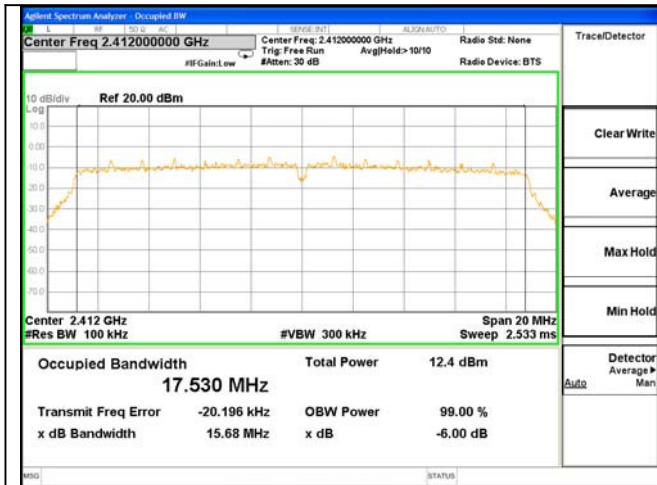

Test Mode: 802.11n20---Low

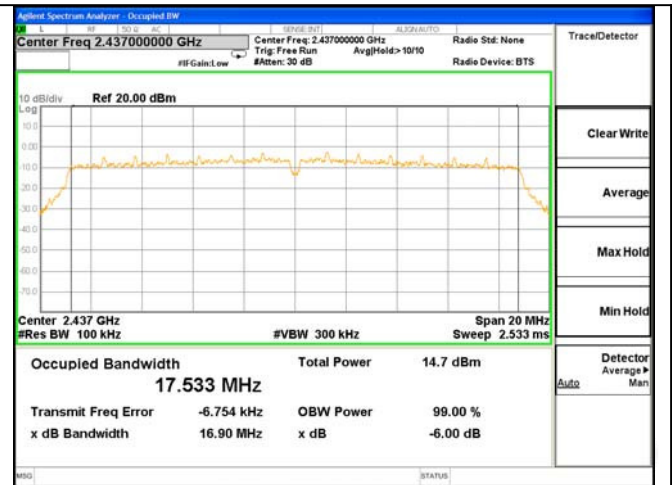

Test Mode: 802.11n20---Mid

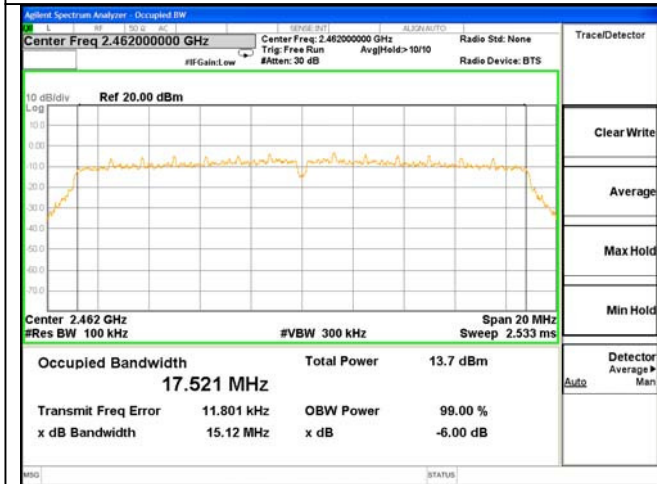

Test Mode: 802.11n20---High

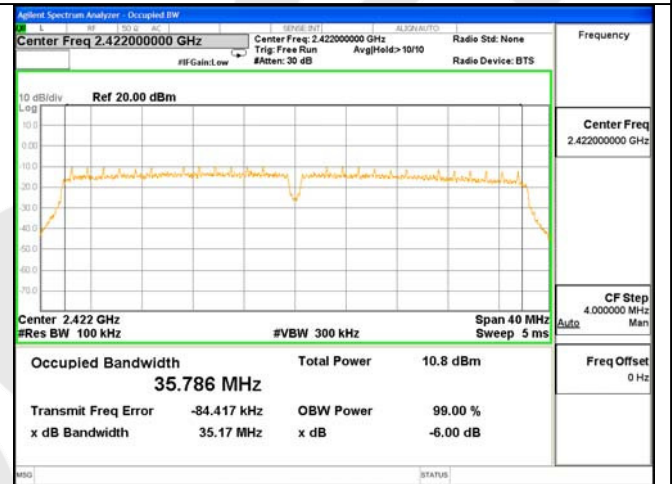

Test Mode: 802.11n40---Low

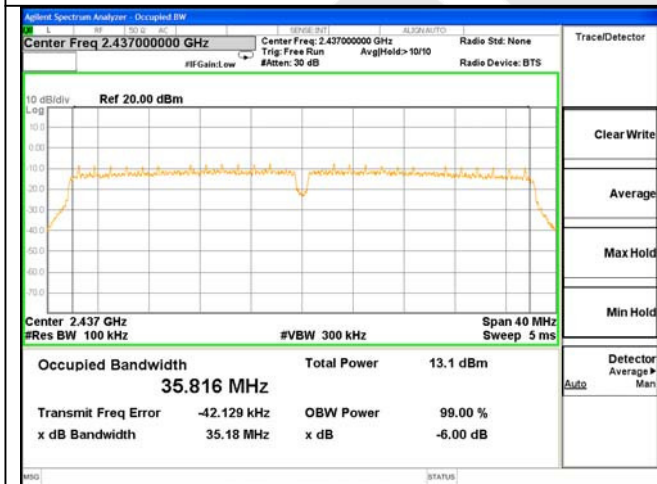

Test Mode: 802.11n40---Mid

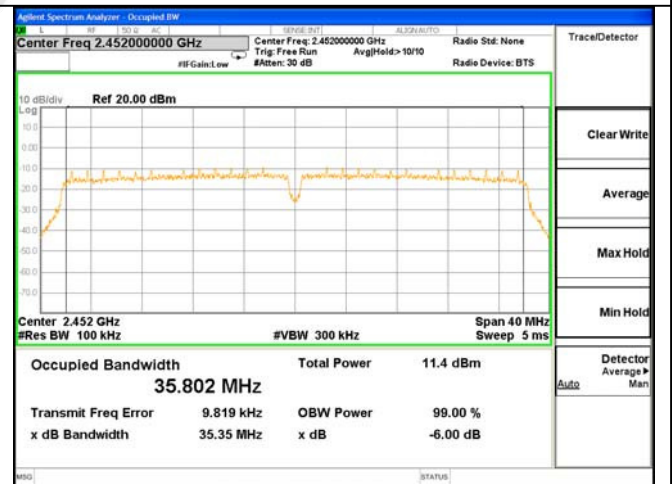

Test Mode: 802.11n40---High

**20dB Bandwidth**

Test mode: IEEE 802.11b

Channel	Frequency (MHz)	Bandwidth (MHz)	Results
Low	2412	14.71	Pass
Mid	2437	15.12	Pass
High	2462	15.18	Pass

Test mode: IEEE 802.11g

Channel	Frequency (MHz)	Bandwidth (MHz)	Results
Low	2412	18.83	Pass
Mid	2437	18.71	Pass
High	2462	18.50	Pass

Test mode: IEEE 802.11n (HT20)

Channel	Frequency (MHz)	Bandwidth (MHz)	Results
Low	2412	19.14	Pass
Mid	2437	19.19	Pass
High	2462	19.28	Pass

Test mode: IEEE 802.11n (HT40)

Channel	Frequency (MHz)	Bandwidth (MHz)	Results
Low	2422	39.23	Pass
Mid	2437	39.12	Pass
High	2452	39.15	Pass

Test Plots See the following page.

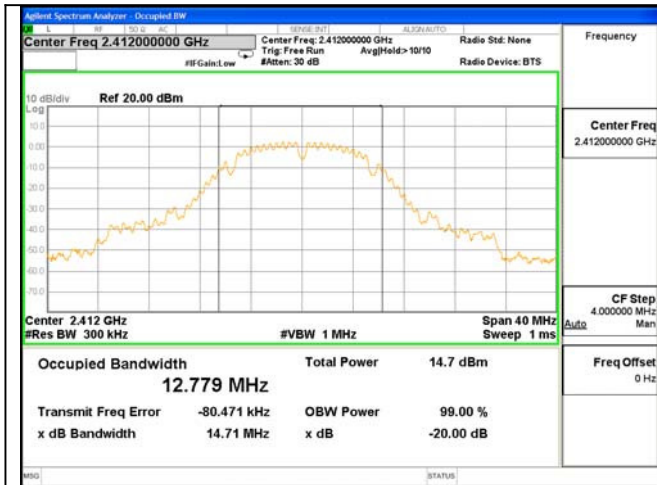

Test Mode: 802.11b---Low

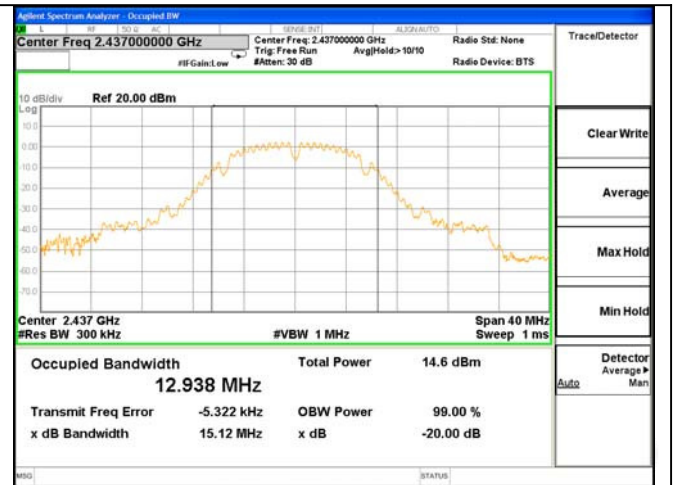

Test Mode: 802.11b---Mid



Test Mode: 802.11b---High

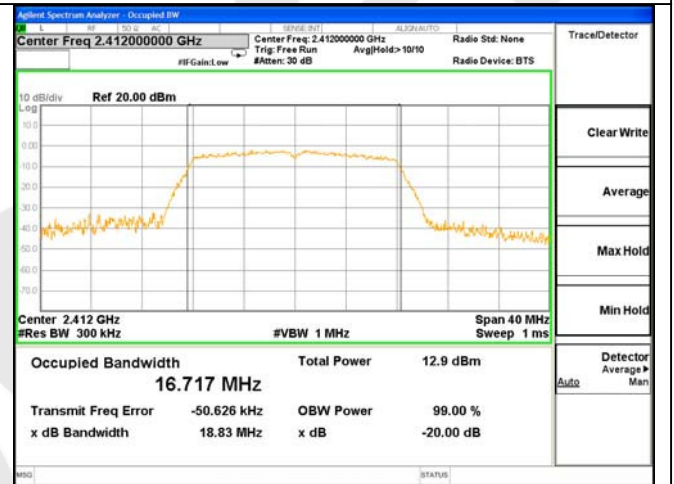

Test Mode: 802.11g---Low

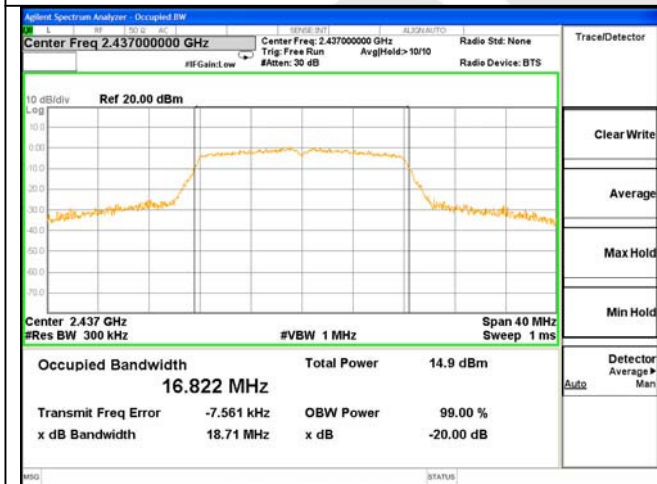

Test Mode: 802.11g---Mid

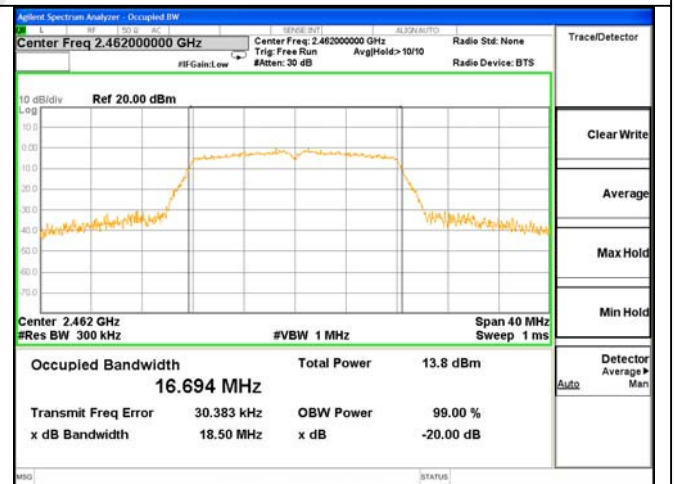

Test Mode: 802.11g---High

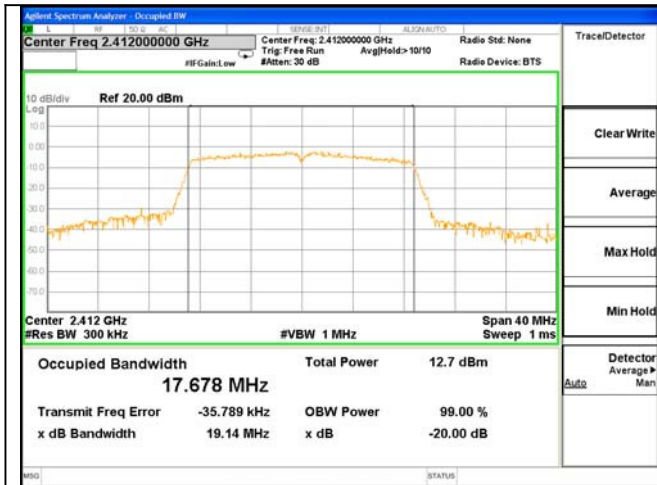

Test Mode: 802.11n20---Low

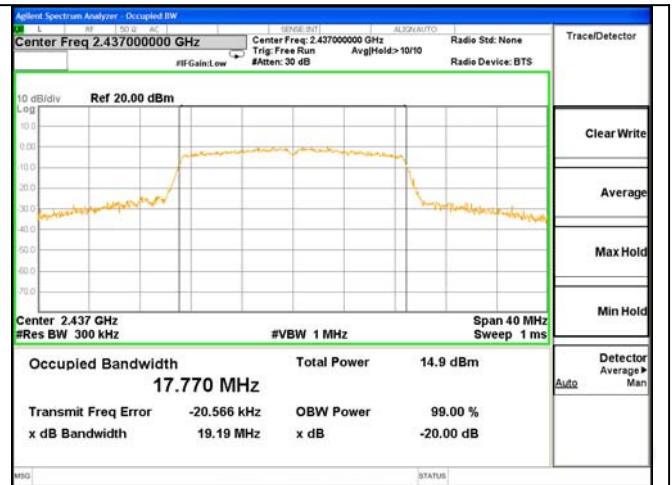

Test Mode: 802.11n20---Mid

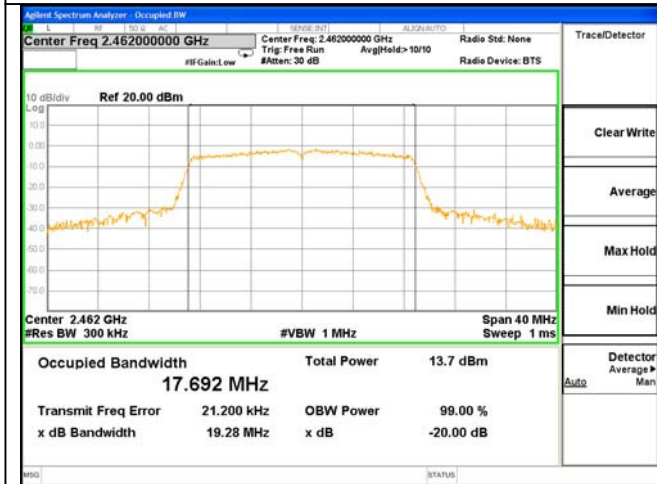

Test Mode: 802.11n20---High

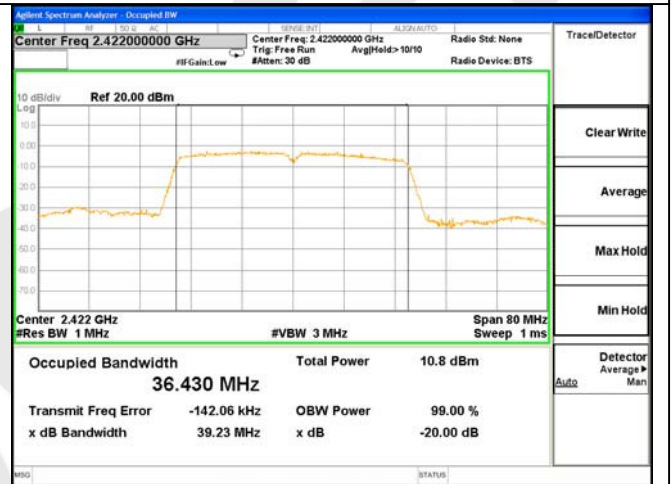

Test Mode: 802.11n40---Low

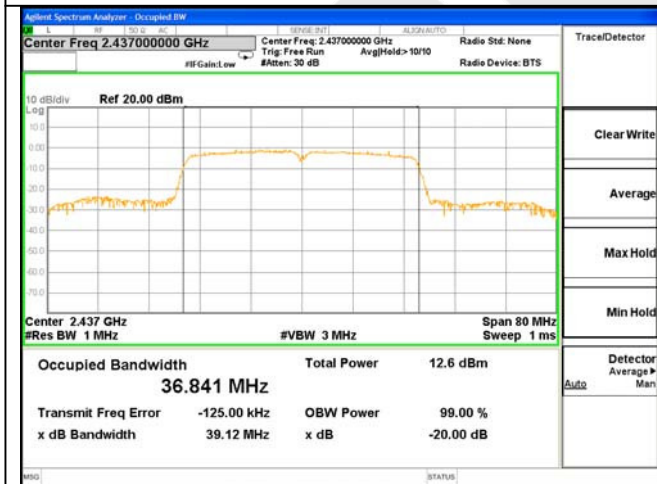

Test Mode: 802.11n40---Mid

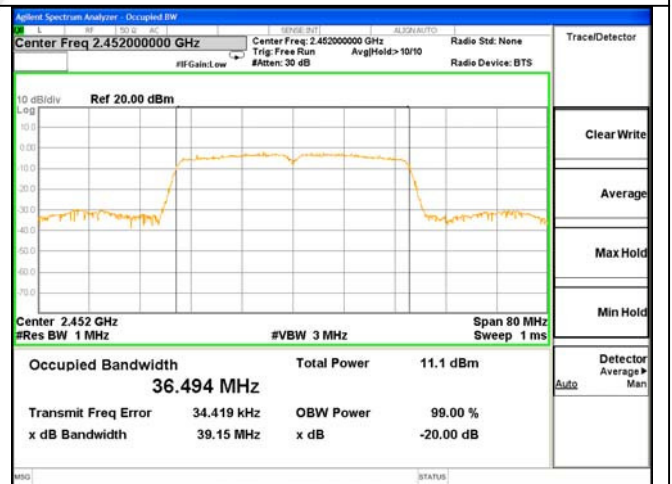

Test Mode: 802.11n40---High

### 4.3. Maximum Output Power Test

#### a. Limit

The maximum output power of the intentional radiator shall not exceed the following:

1. For systems using digital modulation in the bands of 902-928 MHz, 2400-2483.5 MHz, and 5725-5850 MHz: 1 watt (30dBm).
2. Except as shown in paragraphs (b)(3) (i), (ii) and (iii) of this section, if transmitting antenna of directional gain greater than 6 dBi are used the peak output power from the intentional radiator shall be reduced below the stated values in paragraphs (b)(1) or (b)(2) of this section, as appropriate, by the amount in dB that the directional gain of the antenna exceeds 6 dBi.

#### b. Configuration of Measurement

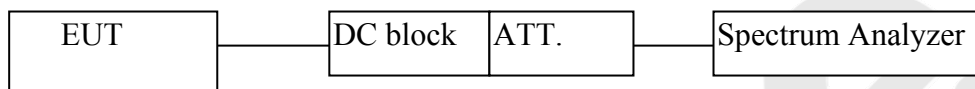

#### c. Data Rates

IEEE802.11b: Channel 1(2412MHz), Channel 6(2437MHz) and Channel 11(2462MHz) with 1 Mbps data rate (worst case) are chosen for the final testing.

IEEE802.11g: Channel 1(2412MHz), Channel 6(2437MHz) and Channel 11(2462MHz) with 6 Mbps data rate (the worst case) are chosen for the final testing.

IEEE802.11n (HT20: Channel 1(2412MHz), Channel 6(2437MHz) and Channel 11(2462MHz) with 6.5Mbps data rate (the worst case) are chosen for the final testing.

IEEE802.11n (HT40: Channel 3(2422MHz), Channel 6(2437MHz) and Channel 9(2452MHz) with 13.5Mbps data rate (the worst case) are chosen for the final testing.

#### d. Test Procedure

**This test was according the kDB 558074 D01 DTS Meas Guidance v03r05 9.1.1:**

1. Set span to at least 1.5 times the OBW.
2. Set the RBW =1~5% of the OBW, not to exceed 1MHz.
3. Set VBW $\geq$ 3\*RBW.
4. Detector = Average.
5. Sweep time = auto couple.
6. Trace mode = max hold.
7. Allow trace to fully stabilize.

#### e. Test Equipment

Same as the equipment listed in 4.2.

#### f. Test Results

Pass.

**g. Test Data**

Test mode: IEEE 802.11b

Channel	Frequency (MHz)	Maximum transmit power (dBm)	Limit		Result
			(dBm)	(watts)	
Low	2412	16.89	30	1	Pass
Mid	2437	16.56			Pass
High	2462	17.76			Pass

Test mode: IEEE 802.11g

Channel	Frequency (MHz)	Maximum transmit power (dBm)	Limit		Result
			(dBm)	(watts)	
Low	2412	12.84	30	1	Pass
Mid	2437	14.76			Pass
High	2462	13.80			Pass

Test mode: IEEE 802.11n (HT20)

Channel	Frequency (MHz)	Maximum transmit power (dBm)	Limit		Result
			(dBm)	(watts)	
Low	2412	12.75	30	1	Pass
Mid	2437	14.71			Pass
High	2462	13.91			Pass

Test mode: IEEE 802.11n (HT40)

Channel	Frequency (MHz)	Maximum transmit power (dBm)	Limit		Result
			(dBm)	(watts)	
Low	2422	10.49	30	1	Pass
Mid	2437	12.77			Pass
High	2452	11.16			Pass



Test Mode: 802.11b---Low



Test Mode: 802.11b---Mid



Test Mode: 802.11b---High



Test Mode: 802.11g---Low



Test Mode: 802.11g---Mid

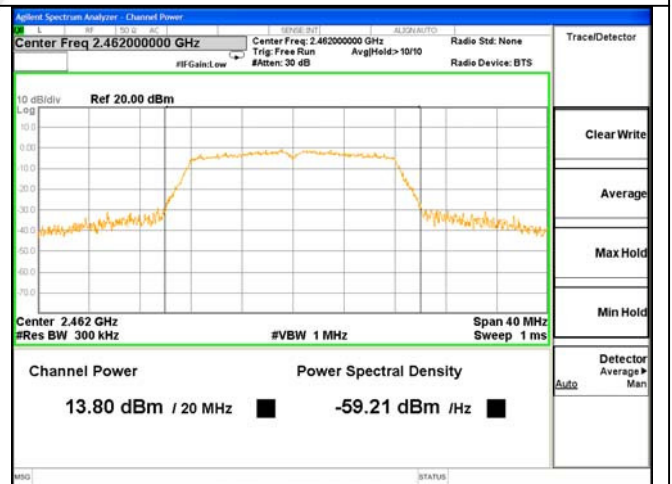

Test Mode: 802.11g---High



Test Mode: 802.11n20---Low



Test Mode: 802.11n20---Mid



Test Mode: 802.11n20---High



Test Mode: 802.11n40---Low



Test Mode: 802.11n40---Mid



Test Mode: 802.11n40---High

#### 4.4. Band Edges Measurement

##### a. Limit

According to §15.247(c), in any 100 kHz bandwidth outside the frequency bands in which the spread spectrum intentional radiator is operating, the radio frequency power that is produced by the intentional radiator shall be at least 20dB below that in the 100kHz bandwidth within the band that contains the highest level of the desired power, In addition, radiated emissions which fall in the restricted bands, as defined in §15.205(a), must also comply with the radiated emission limits specified in §15.209(a).

##### b. Test Procedure

###### 1. Conducted Method:

- 1) Set RBW=100KHz, VBW=300KHz
- 2) Detector=peak
- 3) Sweep time= auto
- 4) Trace mode=max hold.

###### 2. Radiated Method:

- 1) For below 1GHz: The EUT is placed on a turntable, which is 0.8m above the ground plane. The EUT is tested in 9\*6\*6 Chamber.  
For above 1GHz: The EUT is placed on a turntable, which is 1.5m above the ground plane. The EUT is tested in 9\*6\*6 Chamber.
- 2) The turntable shall be rotated for 360 degrees to determine the position of maximum emission level.
- 3) EUT is set 3m away from the receiving antenna, which is varied from 1m to 4m to find out the highest emission.
- 4) Peak detector: RBW=1MHz, VBW=3MHz, SWT=AUTO  
Average detector: RBW=1MHz, VBW=10Hz, SWT=AUTO  
The EUT is tested in 9\*6\*6 Chamber.
- 5) Repeat the procedures until all the PEAK and AVERAGE versus POLARIZATION are measured.

30M to 1G emissions:

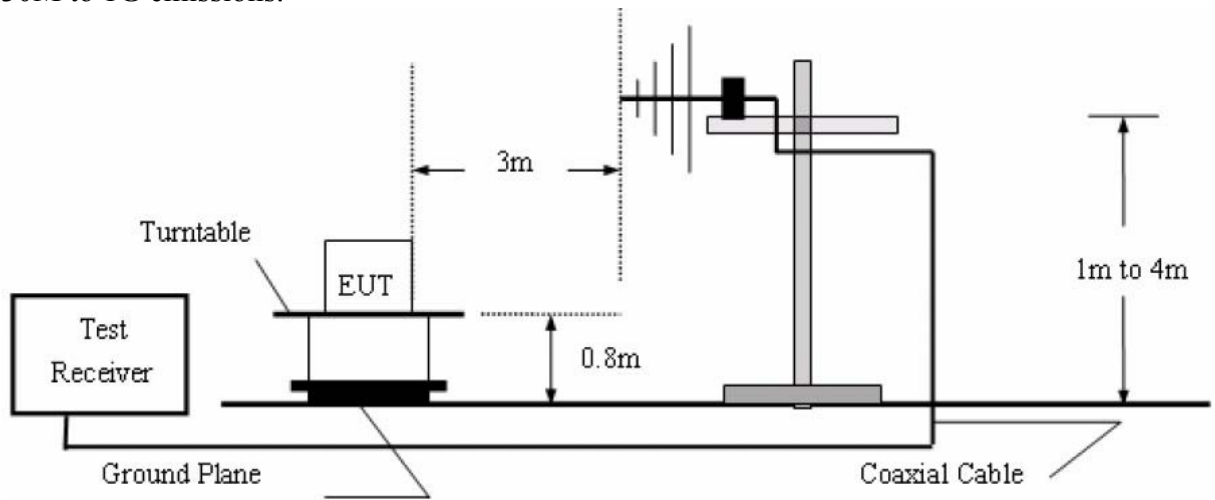

1G to 40G emissions:

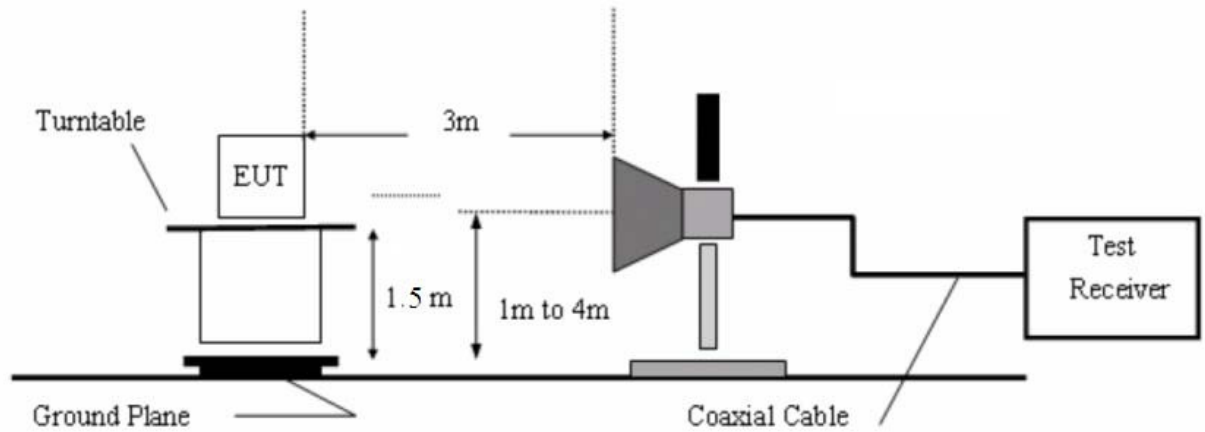

**c. Test Equipment**

Same as the equipment listed in 4.2.

**d. Test Results**

Pass.

**e. Test Plots**

See the following page.

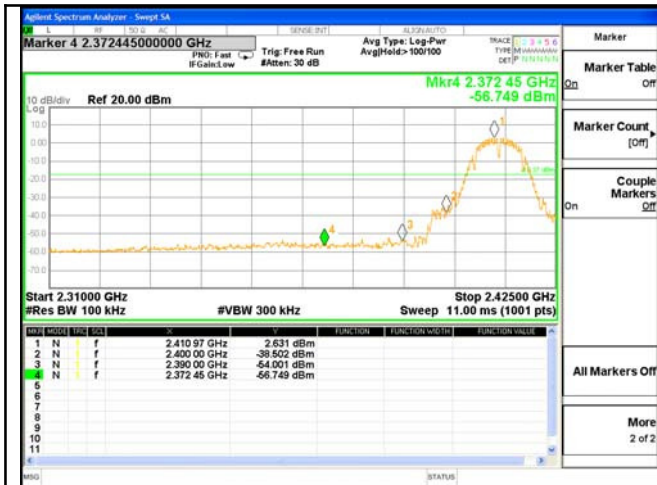

Test Mode: 802.11b---Low



Test Mode: 802.11b---High

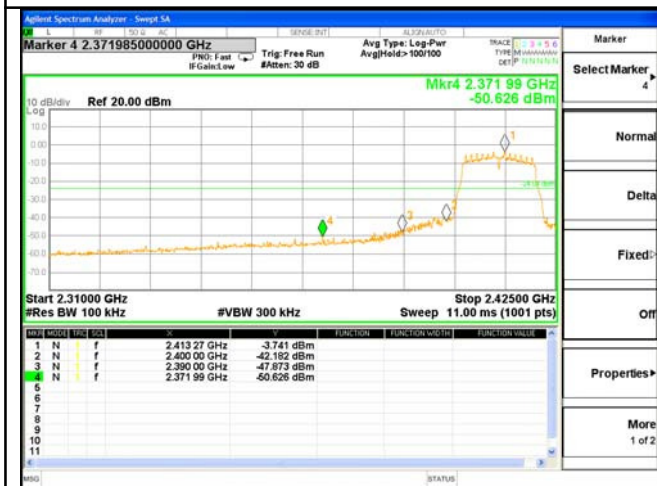

Test Mode: 802.11g---Low



Test Mode: 802.11g---High



Test Mode: 802.11n20---Low

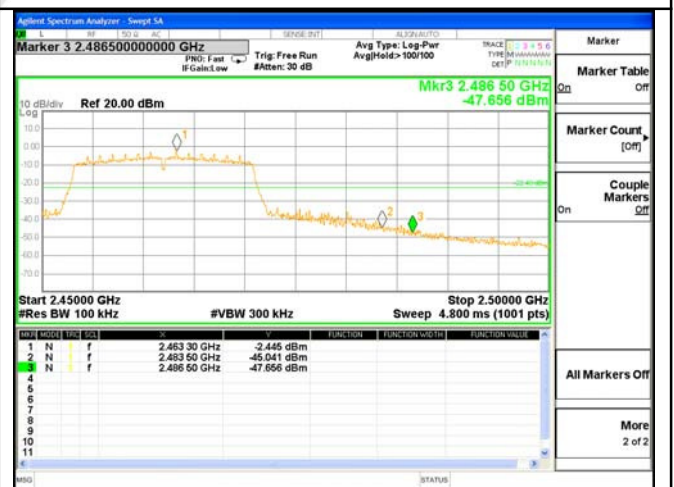

Test Mode: 802.11n20---High



Test Mode: 802.11n40---Low

Test Mode: 802.11n40---High



Test Mode: 802.11b  
2412MHz  
Horizontal-PEAK:

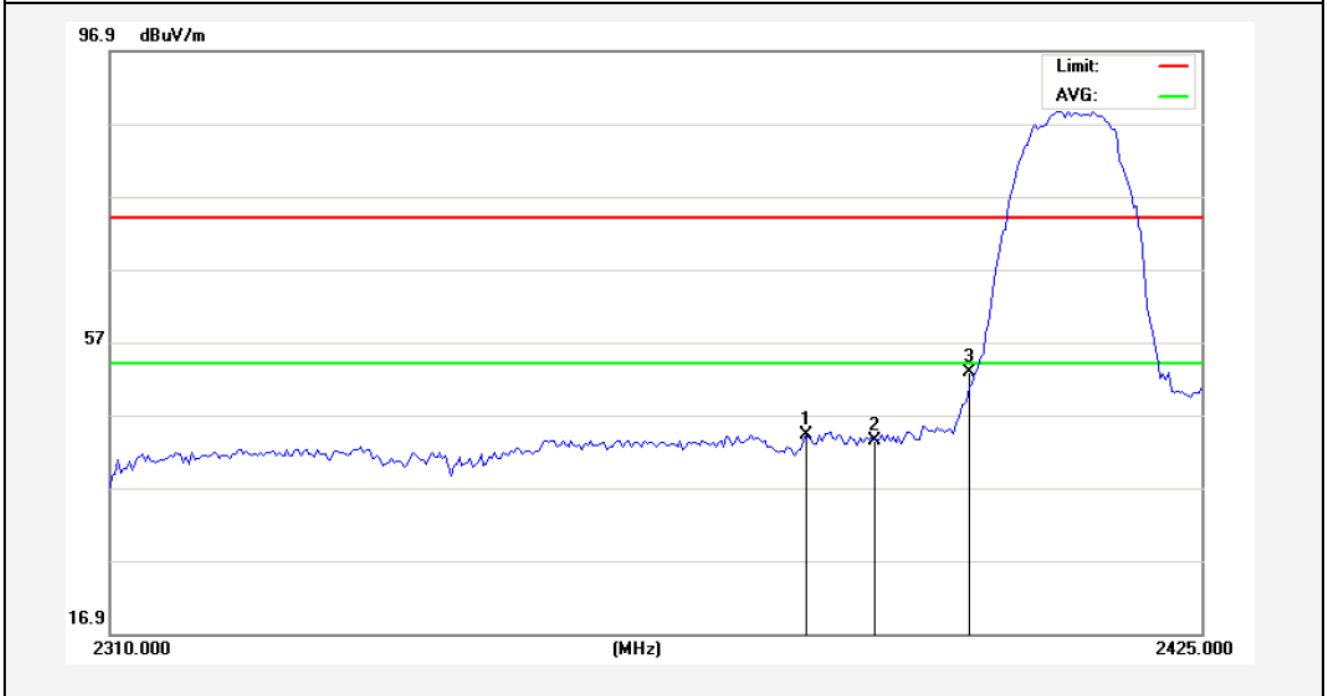

No.	Freq. (MHz)	Reading (dBuV/m)	Factor (dB/m)	Result (dBuV/m)	Limit (dBuV/)	Over Limit (dB)	Detector	Height (cm)	degree (deg)	Remark
1	2382.738	46.79	-2.53	44.26	74.00	-29.74	peak			
2	2390.000	45.88	-2.51	43.37	74.00	-30.63	peak			
3	2400.000	55.32	-2.49	52.83	74.00	-21.17	peak			

Anbotek

Horizontal-AV:

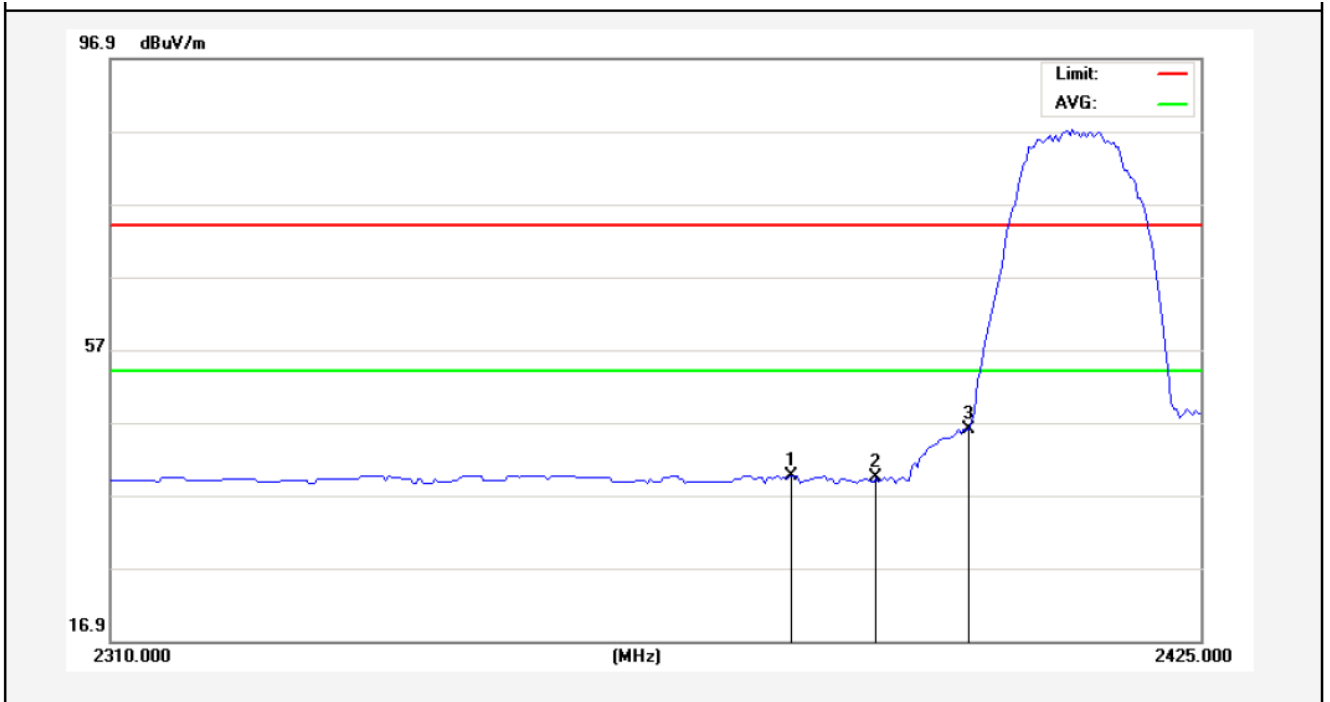

No.	Freq. (MHz)	Reading (dBuV/m)	Factor (dB/m)	Result (dBuV/m)	Limit (dBuV/)	Over Limit (dB)	Detector	Height (cm)	degree (deg)	Remark
1	2381.300	42.12	-2.53	39.59	54.00	-14.41	AVG			
2	2390.000	41.95	-2.51	39.44	54.00	-14.56	AVG			
3	2400.000	48.43	-2.49	45.94	54.00	-8.06	AVG			

Test Mode: 802.11b  
2412MHz  
Vertical-PEAK:

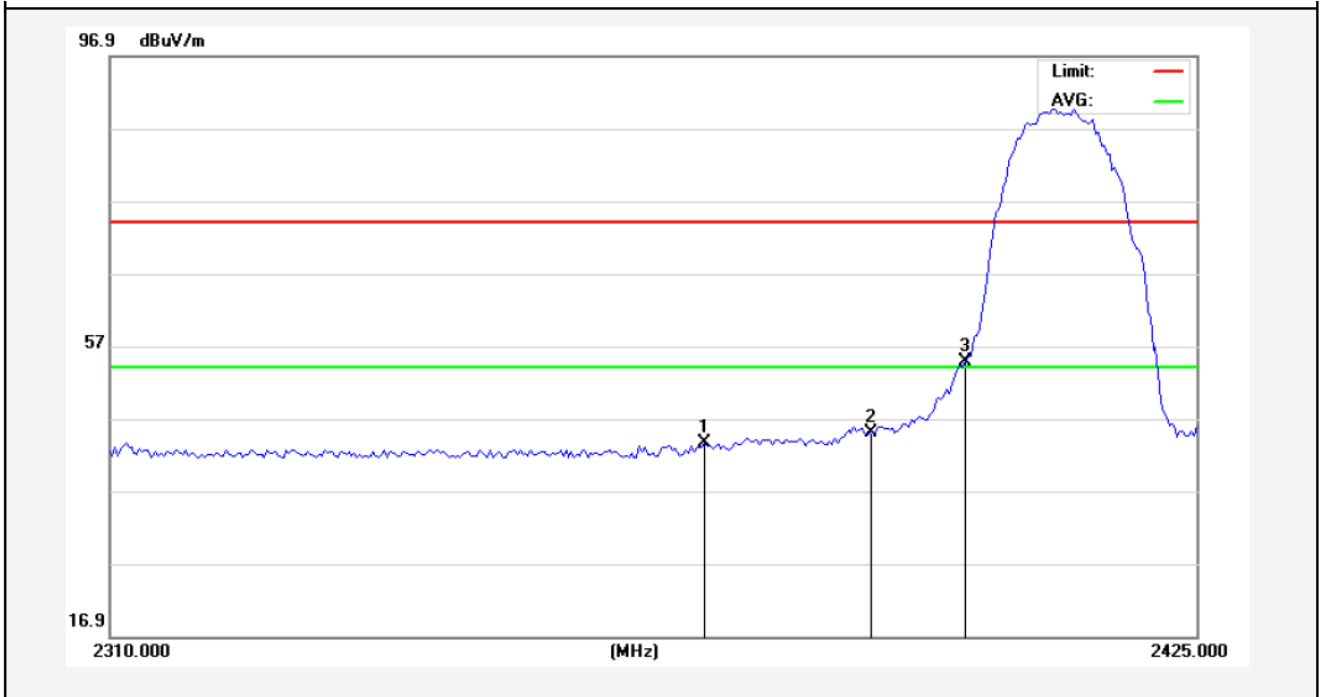

No.	Freq. (MHz)	Reading (dBuV/m)	Factor (dB/m)	Result (dBuV/m)	Limit (dBuV/)	Over Limit (dB)	Detector	Height (cm)	degree (deg)	Remark
1	2372.387	46.21	-2.55	43.66	74.00	-30.34	peak			
2	2390.000	47.61	-2.51	45.10	74.00	-28.90	peak			
3	2400.000	57.31	-2.49	54.82	74.00	-19.18	peak			

Anbotek

Vertical-AV:

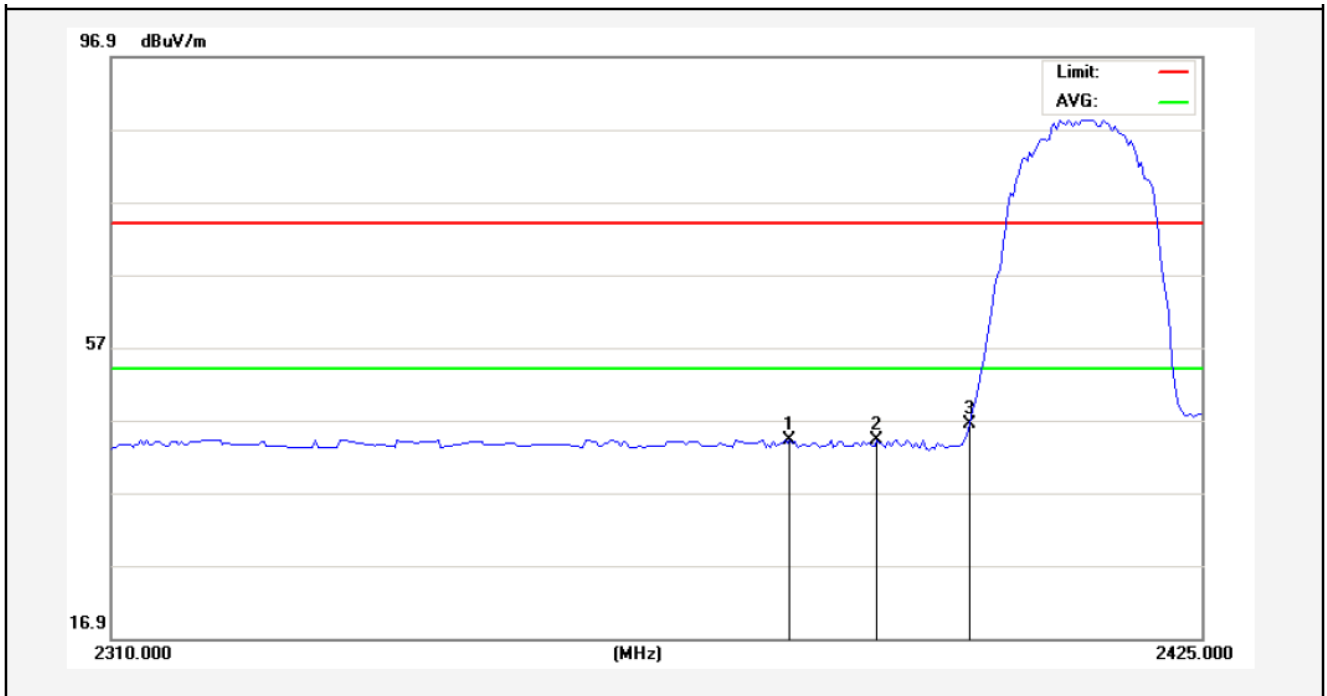

No.	Freq. (MHz)	Reading (dBuV/m)	Factor (dB/m)	Result (dBuV/m)	Limit (dBuV/)	Over Limit (dB)	Detector	Height (cm)	degree (deg)	Remark
1	2381.012	46.65	-2.53	44.12	54.00	-9.88	AVG			
2	2390.000	46.64	-2.51	44.13	54.00	-9.87	AVG			
3	2400.000	48.96	-2.49	46.47	54.00	-7.53	AVG			

Anbotek

Test Mode: 802.11b  
2462MHz  
Horizontal-PEAK:

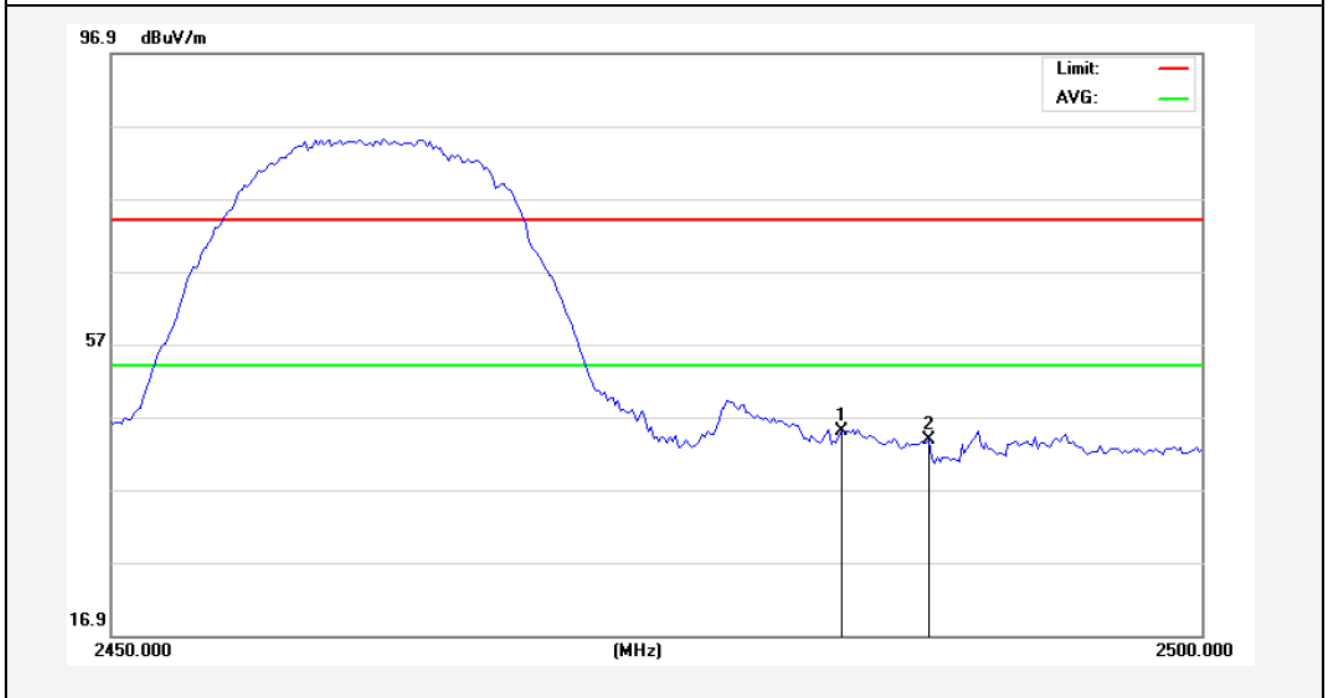

No.	Freq. (MHz)	Reading (dBuV/m)	Factor (dB/m)	Result (dBuV/m)	Limit (dBuV/)	Over Limit (dB)	Detector	Height (cm)	degree (deg)	Remark
1	2483.500	47.30	-2.31	44.99	74.00	-29.01	peak			
2	2487.500	46.03	-2.30	43.73	74.00	-30.27	peak			

Anbotek

Horizontal-AV:

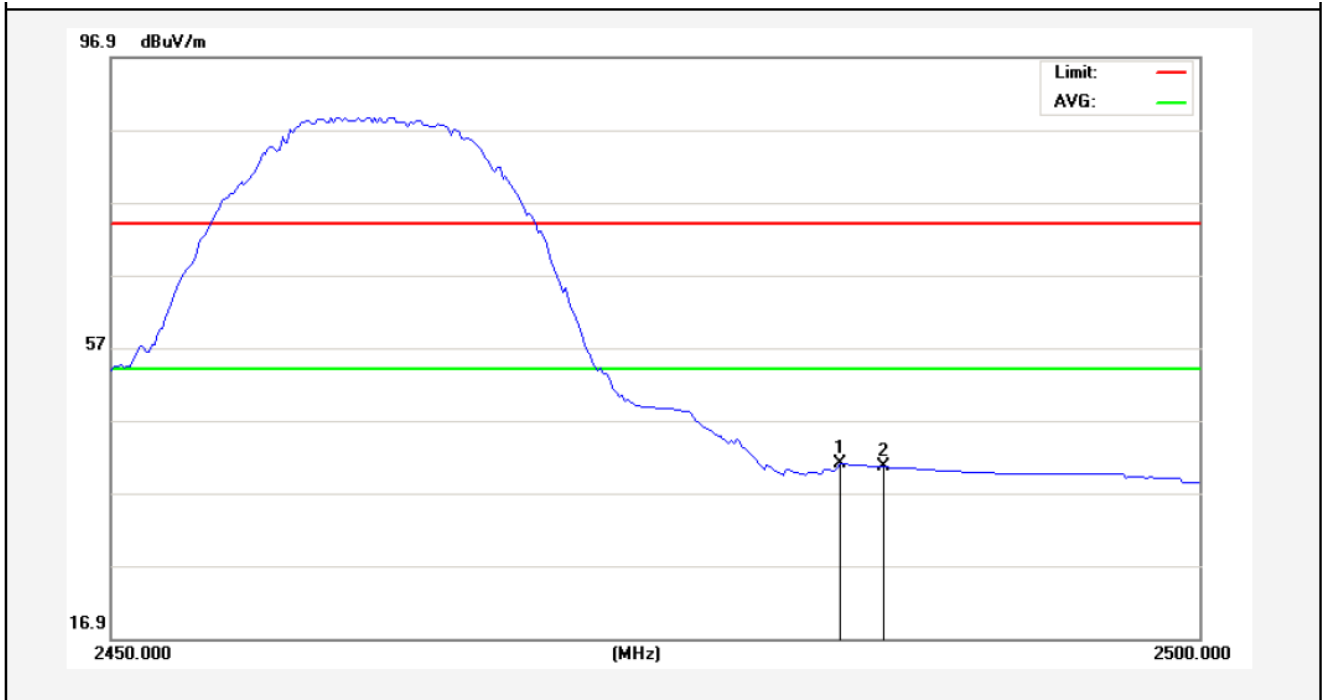

No.	Freq. (MHz)	Reading (dBuV/m)	Factor (dB/m)	Result (dBuV/m)	Limit (dBuV/)	Over Limit (dB)	Detector	Height (cm)	degree (deg)	Remark
1	2483.500	43.26	-2.31	40.95	54.00	-13.05	AVG			
2	2485.500	42.83	-2.30	40.53	54.00	-13.47	AVG			

Anbotek

Test Mode: 802.11b  
2462MHz  
Vertical-PEAK:

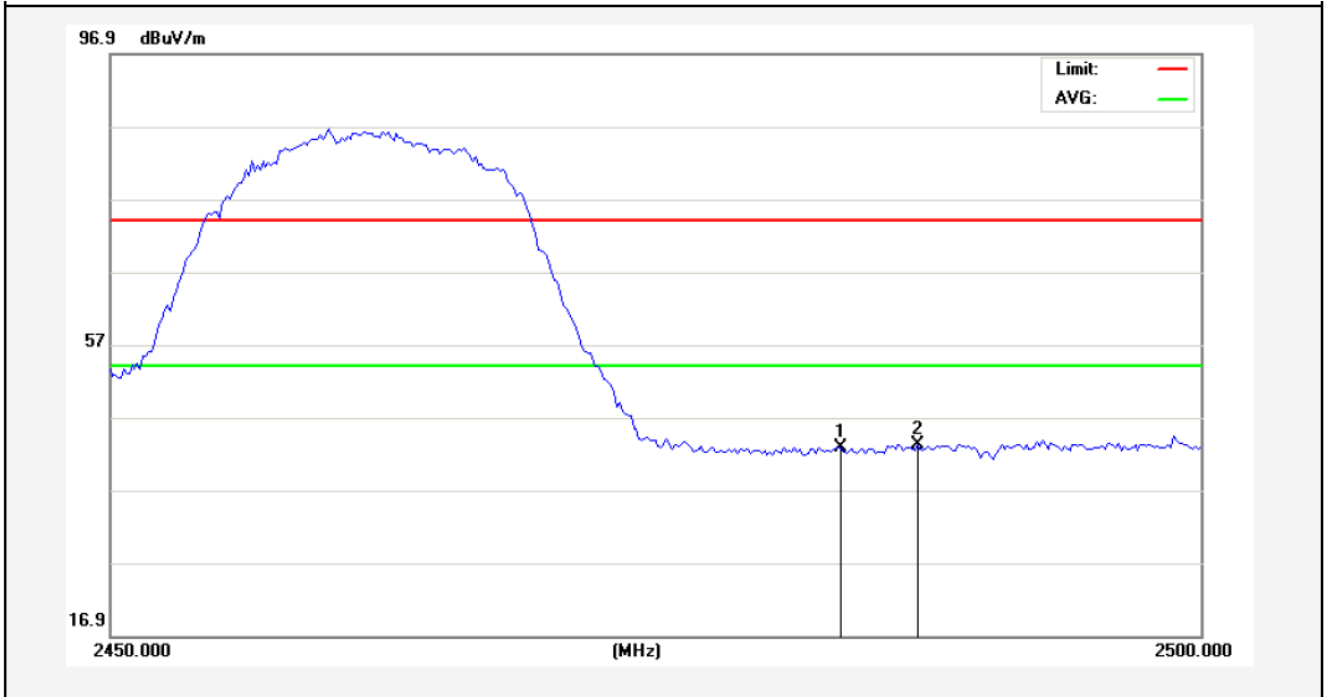

No.	Freq. (MHz)	Reading (dBuV/m)	Factor (dB/m)	Result (dBuV/m)	Limit (dBuV/)	Over Limit (dB)	Detector	Height (cm)	degree (deg)	Remark
1	2483.500	45.03	-2.31	42.72	74.00	-31.28	peak			
2	2487.000	45.54	-2.30	43.24	74.00	-30.76	peak			

Anbotek

Vertical-AV:

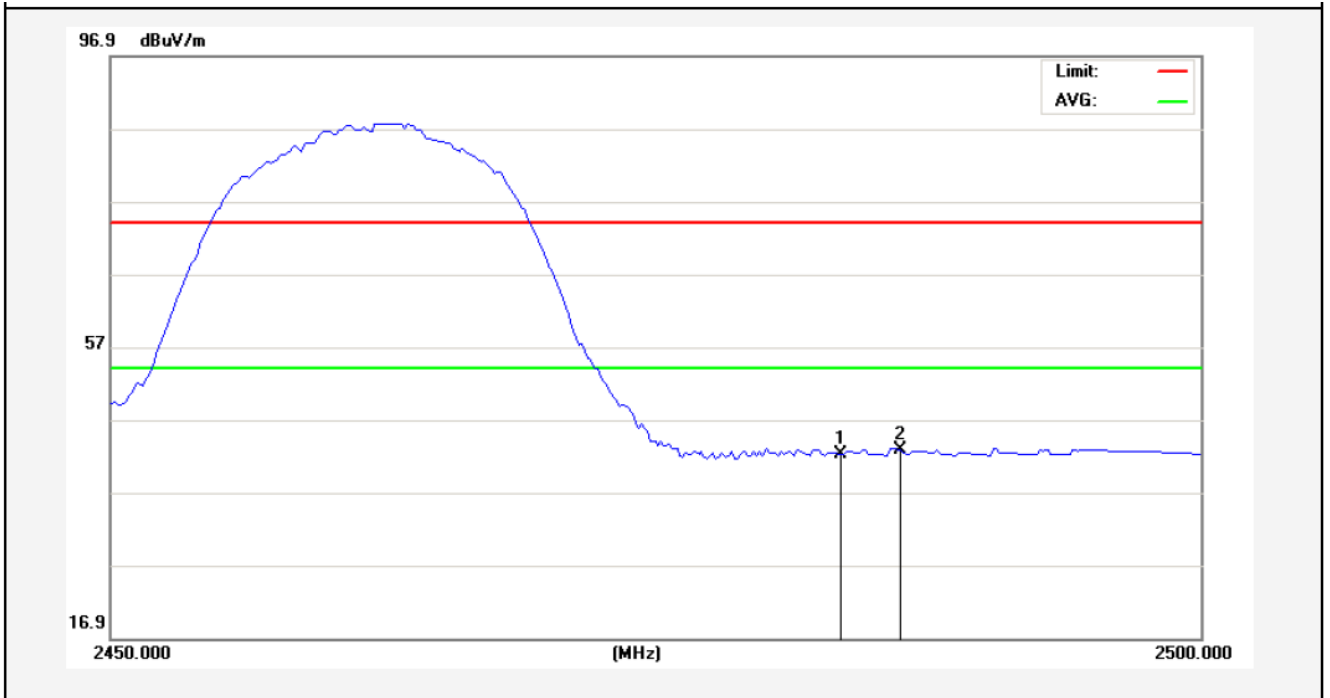

No.	Freq. (MHz)	Reading (dBuV/m)	Factor (dB/m)	Result (dBuV/m)	Limit (dBuV/)	Over Limit (dB)	Detector	Height (cm)	degree (deg)	Remark
1	2483.500	44.58	-2.31	42.27	54.00	-11.73	AVG			
2	2486.250	45.15	-2.30	42.85	54.00	-11.15	AVG			

Anbotek

Test Mode: 802.11g  
2412MHz  
Horizontal-PEAK:

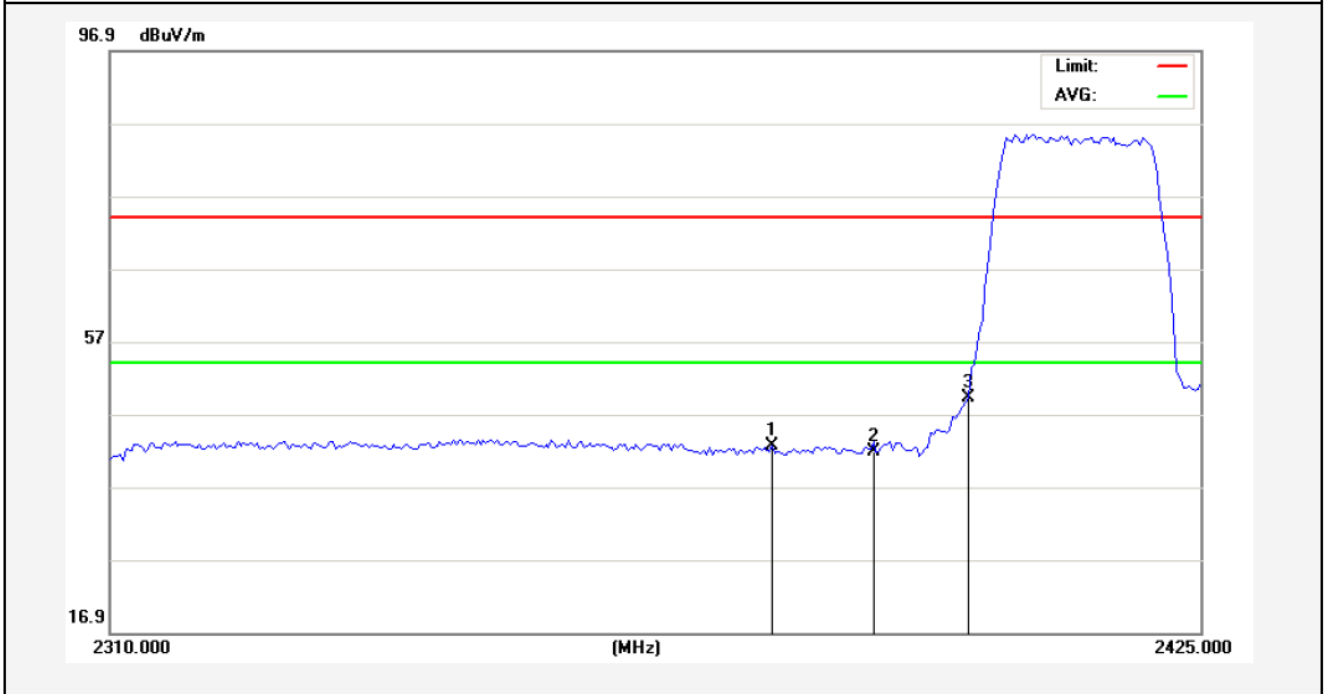

No.	Freq. (MHz)	Reading (dBuV/m)	Factor (dB/m)	Result (dBuV/m)	Limit (dBuV/)	Over Limit (dB)	Detector	Height (cm)	degree (deg)	Remark
1	2379.287	45.12	-2.54	42.58	74.00	-31.42	peak			
2	2390.000	44.36	-2.51	41.85	74.00	-32.15	peak			
3	2400.000	51.66	-2.49	49.17	74.00	-24.83	peak			

AMB

Horizontal-AV:

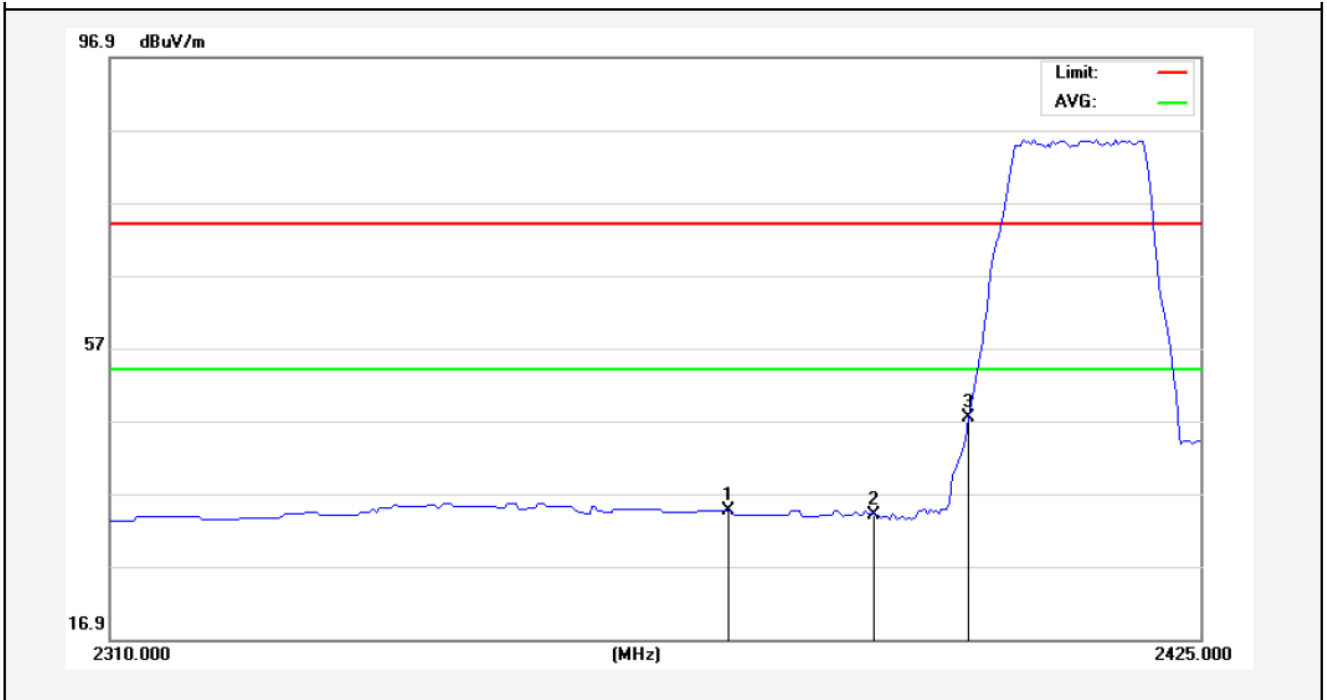

No.	Freq. (MHz)	Reading (dBuV/m)	Factor (dB/m)	Result (dBuV/m)	Limit (dBuV/)	Over Limit (dB)	Detector	Height (cm)	degree (deg)	Remark
1	2374.688	37.10	-2.55	34.55	54.00	-19.45	AVG			
2	2390.000	36.43	-2.51	33.92	54.00	-20.08	AVG			
3	2400.000	49.91	-2.49	47.42	54.00	-6.58	AVG			

Anbotek

Test Mode: 802.11g  
2412MHz  
Vertical-PEAK:

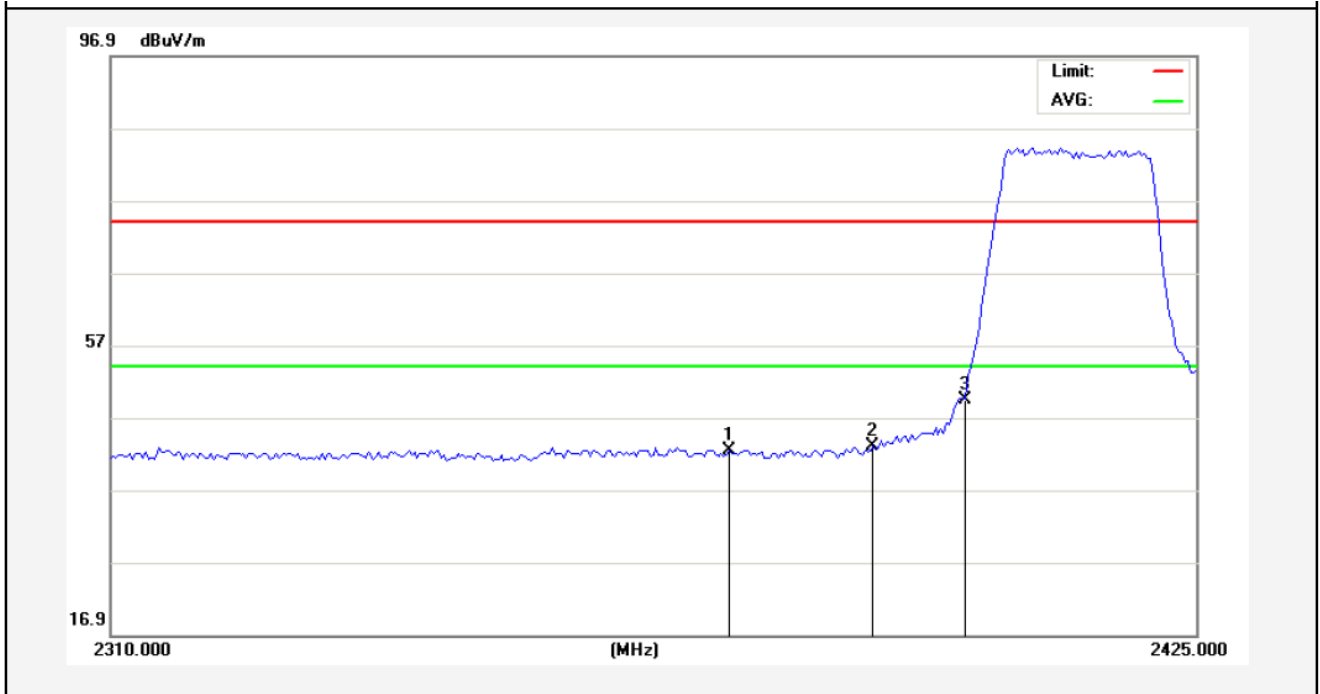

No.	Freq. (MHz)	Reading (dBuV/m)	Factor (dB/m)	Result (dBuV/m)	Limit (dBuV/)	Over Limit (dB)	Detector	Height (cm)	degree (deg)	Remark
1	2374.975	45.05	-2.55	42.50	74.00	-31.50	peak			
2	2390.000	45.55	-2.51	43.04	74.00	-30.96	peak			
3	2400.000	51.99	-2.49	49.50	74.00	-24.50	peak			

Anbotek

Vertical-AV:

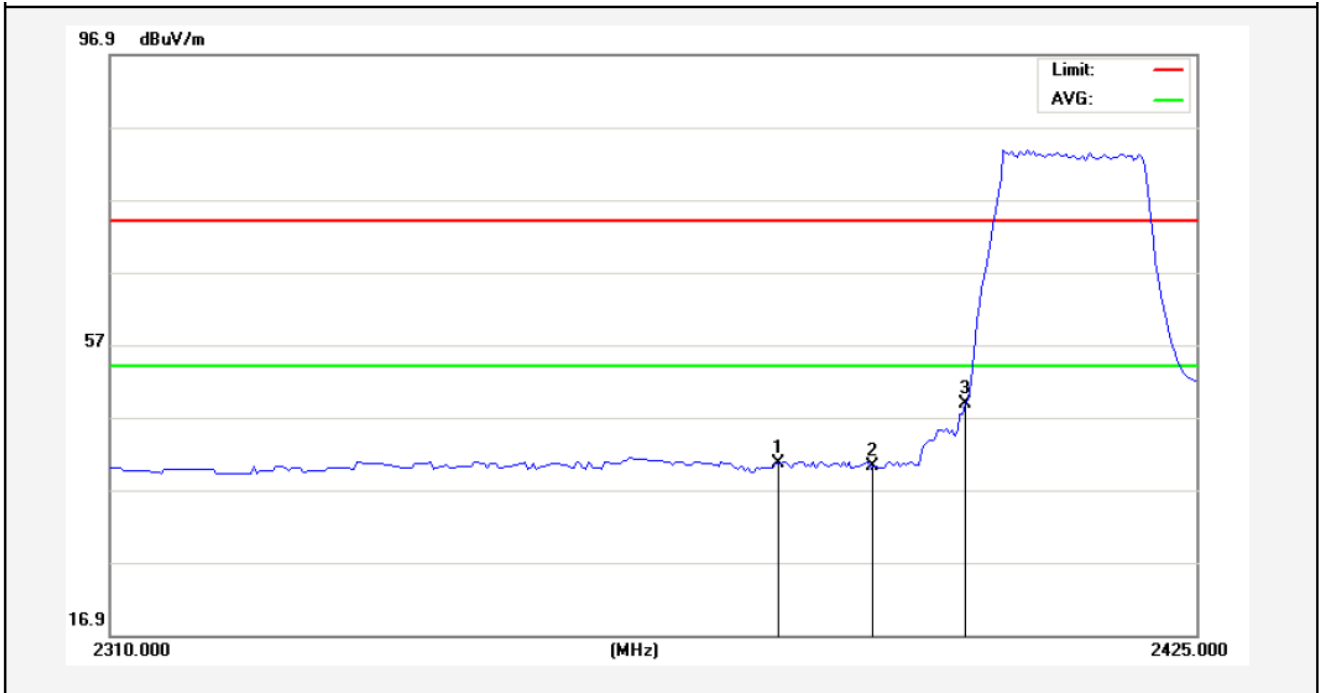

No.	Freq. (MHz)	Reading (dBuV/m)	Factor (dB/m)	Result (dBuV/m)	Limit (dBuV/)	Over Limit (dB)	Detector	Height (cm)	degree (deg)	Remark
1	2380.150	43.14	-2.54	40.60	54.00	-13.40	AVG			
2	2390.000	42.68	-2.51	40.17	54.00	-13.83	AVG			
3	2400.000	51.29	-2.49	48.80	54.00	-5.20	AVG			

Anbotek

Test Mode: 802.11g  
2462MHz  
Horizontal-PEAK:

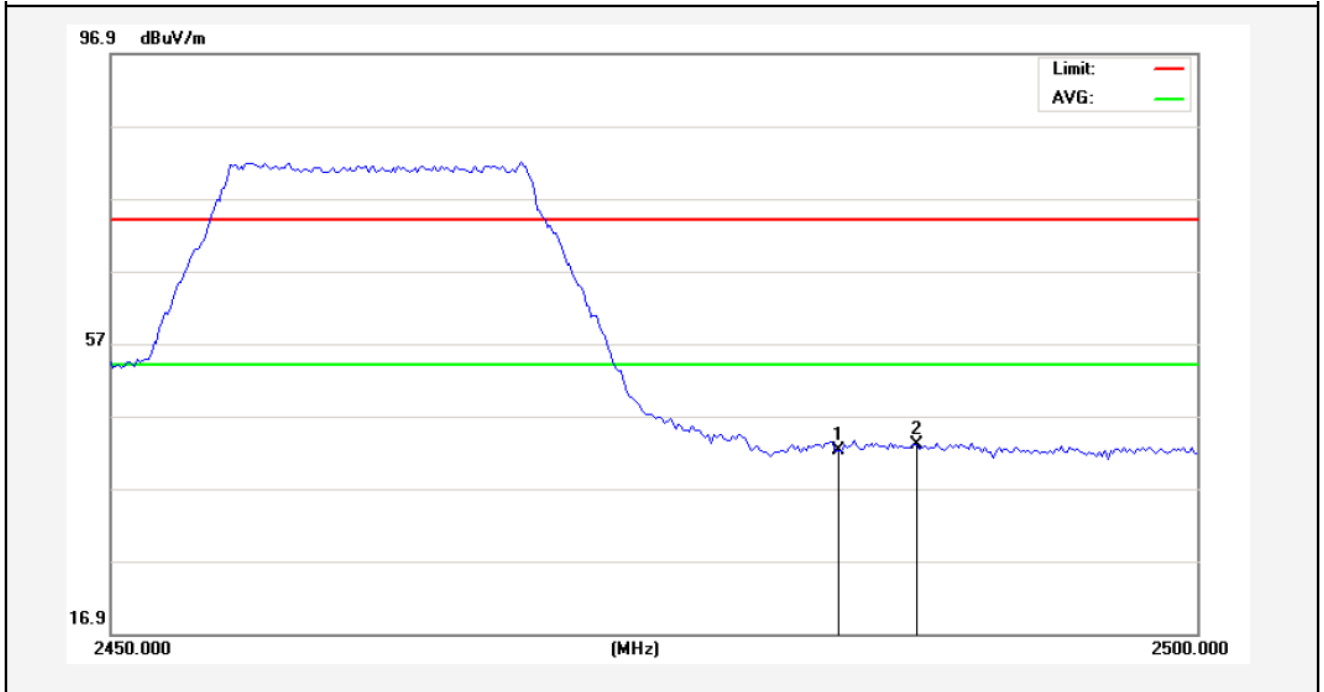

No.	Freq. (MHz)	Reading (dBuV/m)	Factor (dB/m)	Result (dBuV/m)	Limit (dBuV/)	Over Limit (dB)	Detector	Height (cm)	degree (deg)	Remark
1	2483.500	44.44	-2.31	42.13	74.00	-31.87	peak			
2	2487.125	45.32	-2.30	43.02	74.00	-30.98	peak			

Anbotek

Horizontal-AV:

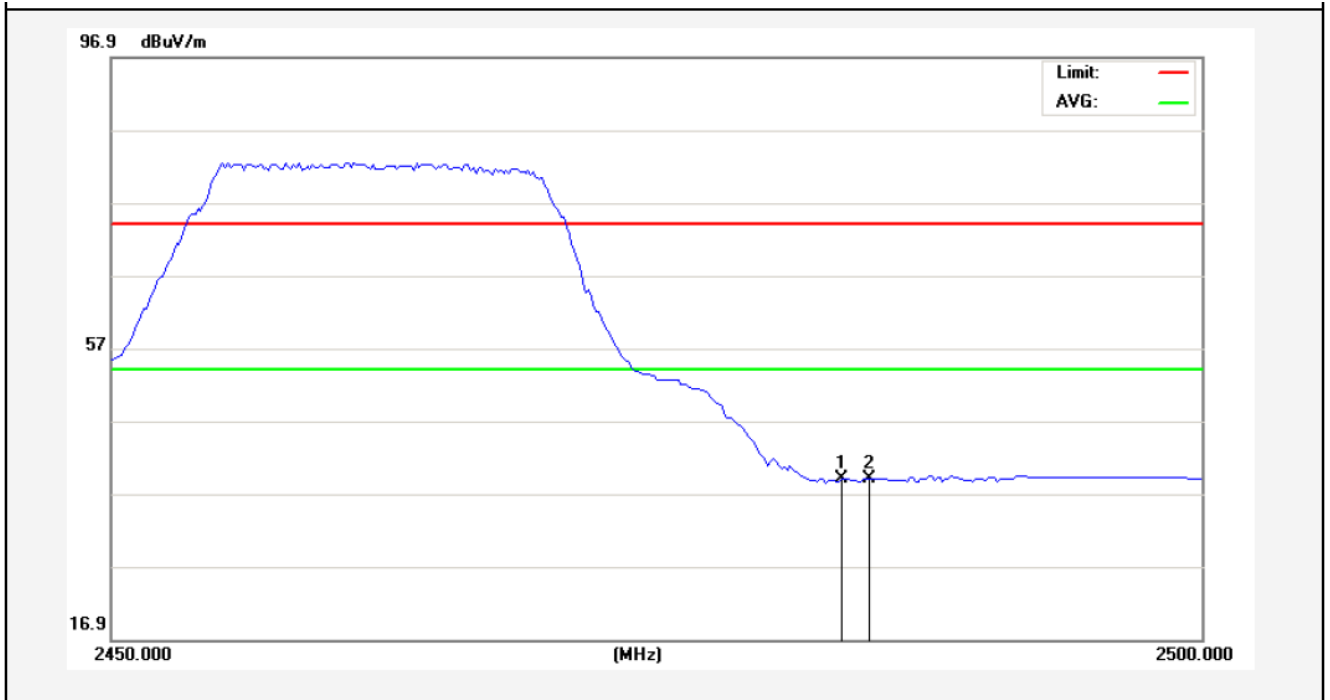

No.	Freq. (MHz)	Reading (dBuV/m)	Factor (dB/m)	Result (dBuV/m)	Limit (dBuV/)	Over Limit (dB)	Detector	Height (cm)	degree (deg)	Remark
1	2483.500	41.38	-2.31	39.07	54.00	-14.93	AVG			
2	2484.750	41.31	-2.30	39.01	54.00	-14.99	AVG			

Anbotek

Test Mode: 802.11g  
2462MHz  
Vertical-PEAK:

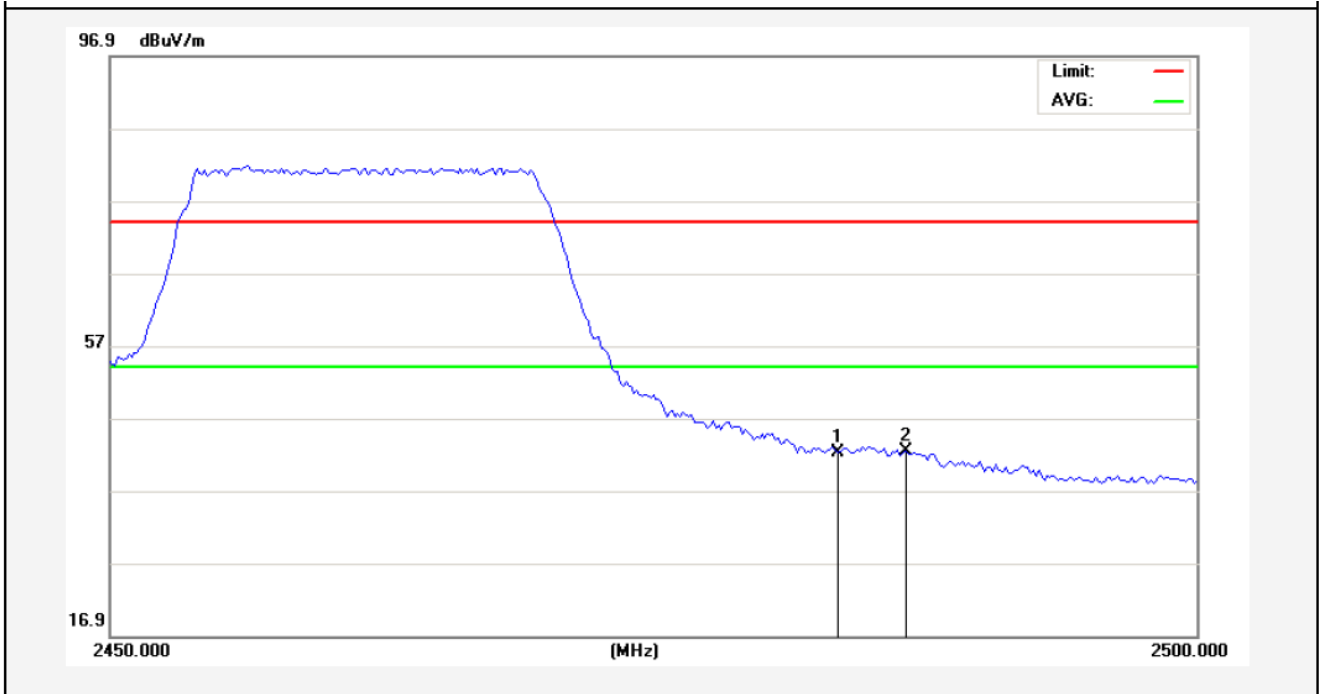

No.	Freq. (MHz)	Reading (dBuV/m)	Factor (dB/m)	Result (dBuV/m)	Limit (dBuV/)	Over Limit (dB)	Detector	Height (cm)	degree (deg)	Remark
1	2483.500	44.57	-2.31	42.26	74.00	-31.74	peak			
2	2486.625	44.76	-2.30	42.46	74.00	-31.54	peak			

Anbotek

Vertical-AV:

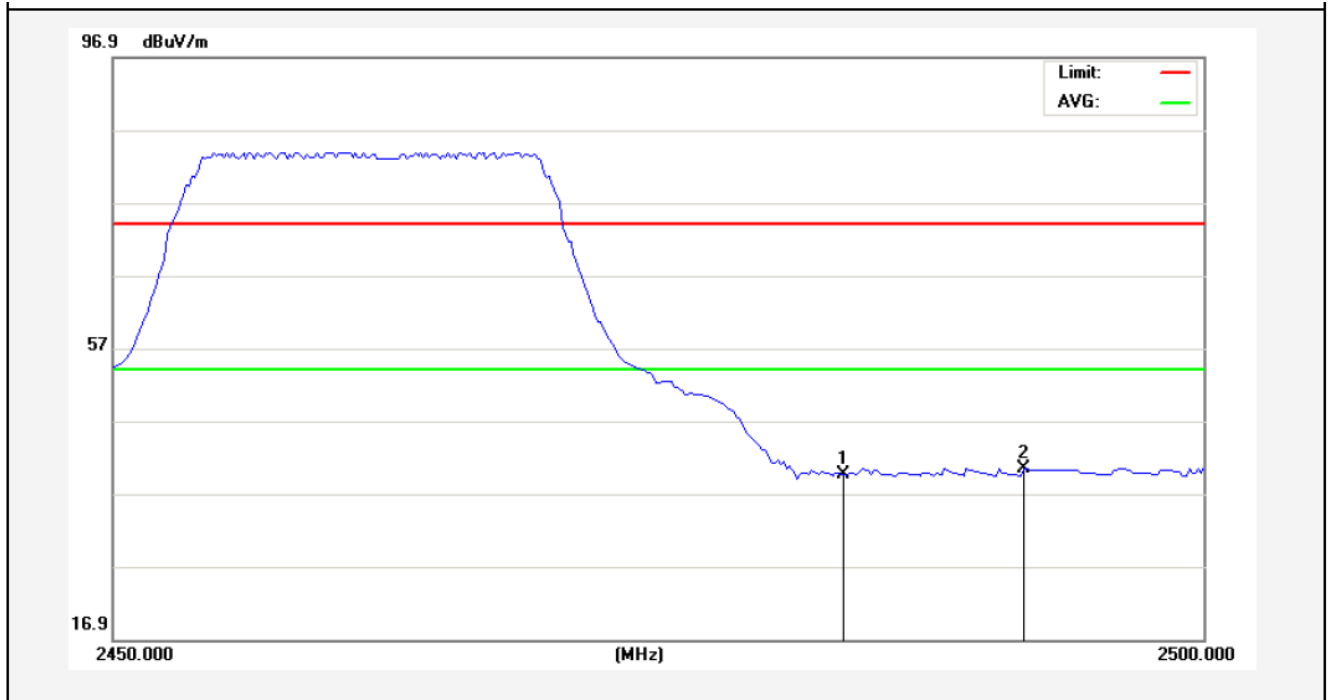

No.	Freq. (MHz)	Reading (dBuV/m)	Factor (dB/m)	Result (dBuV/m)	Limit (dBuV/)	Over Limit (dB)	Detector	Height (cm)	degree (deg)	Remark
1	2483.500	41.88	-2.31	39.57	54.00	-14.43	AVG			
2	2491.750	42.66	-2.29	40.37	54.00	-13.63	AVG			

Anbotek

Test Mode: 802.11n (HT20)

2412MHz

Horizontal-PEAK:

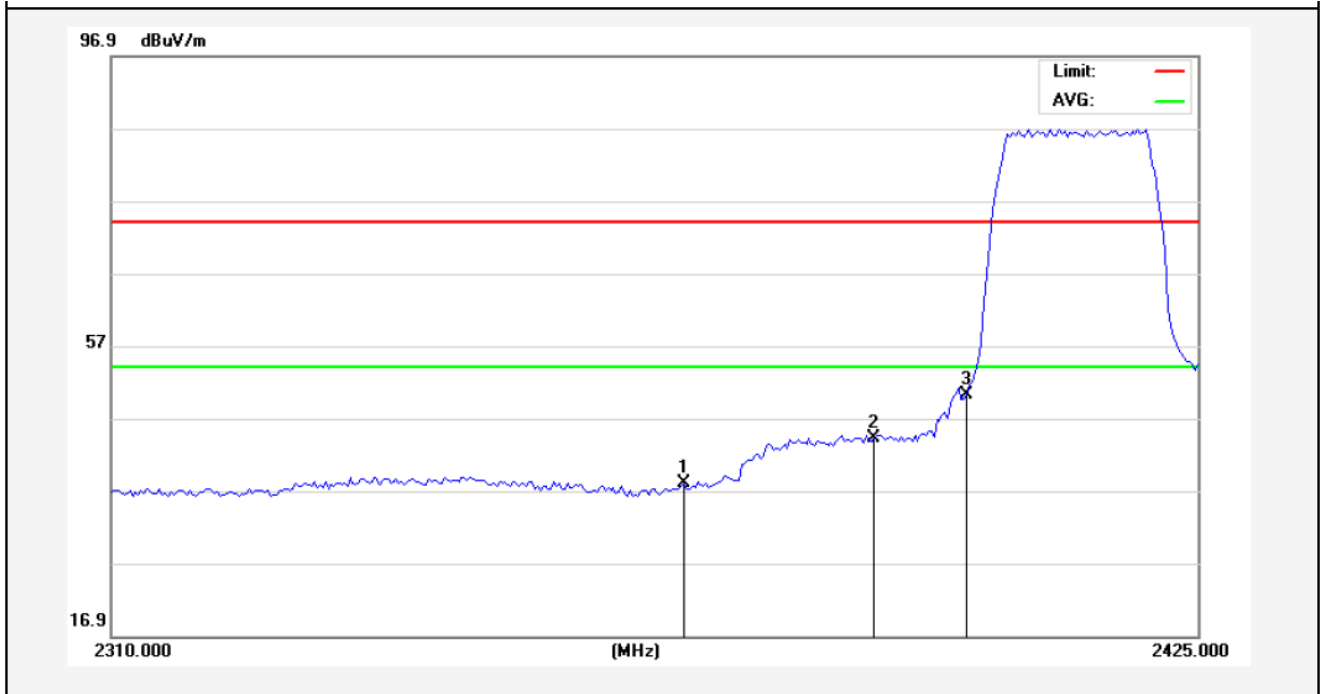

No.	Freq. (MHz)	Reading (dBuV/m)	Factor (dB/m)	Result (dBuV/m)	Limit (dBuV/)	Over Limit (dB)	Detector	Height (cm)	degree (deg)	Remark
1	2370.088	40.63	-2.56	38.07	74.00	-35.93	peak			
2	2390.000	46.63	-2.51	44.12	74.00	-29.88	peak			
3	2400.000	52.75	-2.49	50.26	74.00	-23.74	peak			

AMB

Horizontal-AV:

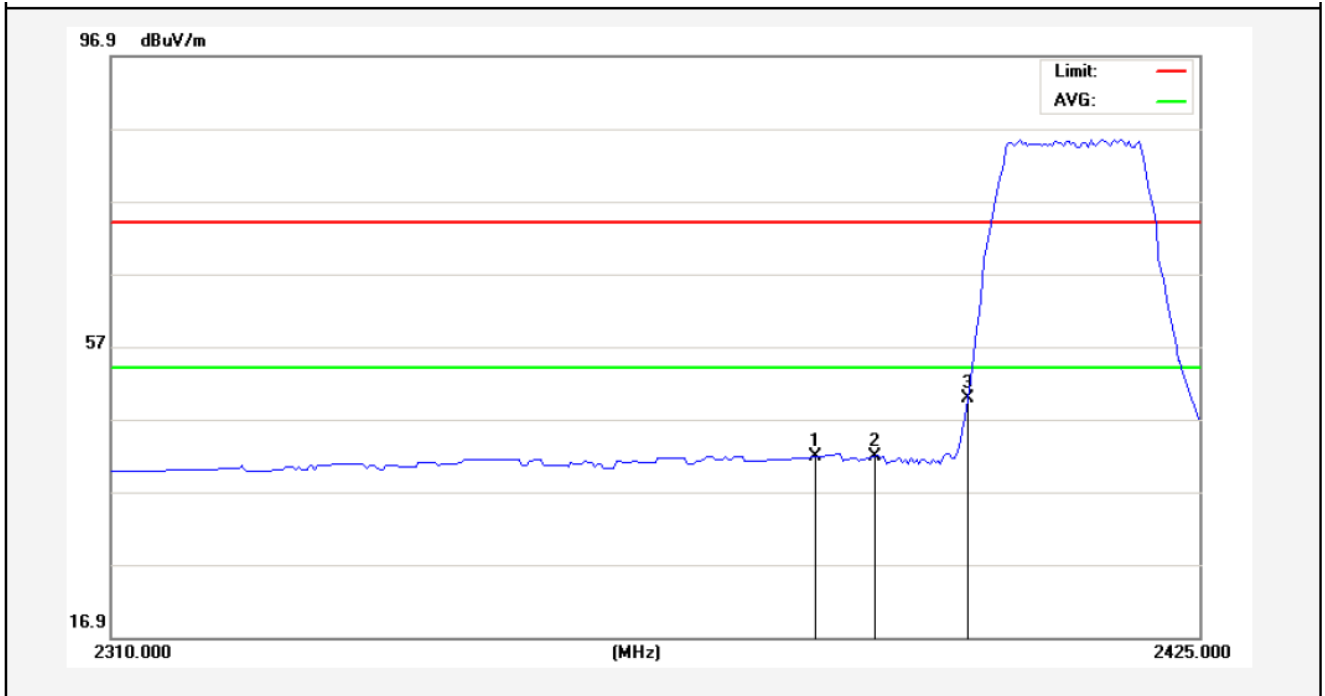

No.	Freq. (MHz)	Reading (dBuV/m)	Factor (dB/m)	Result (dBuV/m)	Limit (dBuV/)	Over Limit (dB)	Detector	Height (cm)	degree (deg)	Remark
1	2383.600	44.25	-2.53	41.72	54.00	-12.28	AVG			
2	2390.000	44.33	-2.51	41.82	54.00	-12.18	AVG			
3	2400.000	52.39	-2.49	49.90	54.00	-4.10	AVG			

Anbotek

Test Mode: 802.11n (HT20)

2412MHz

Vertical-PEAK:

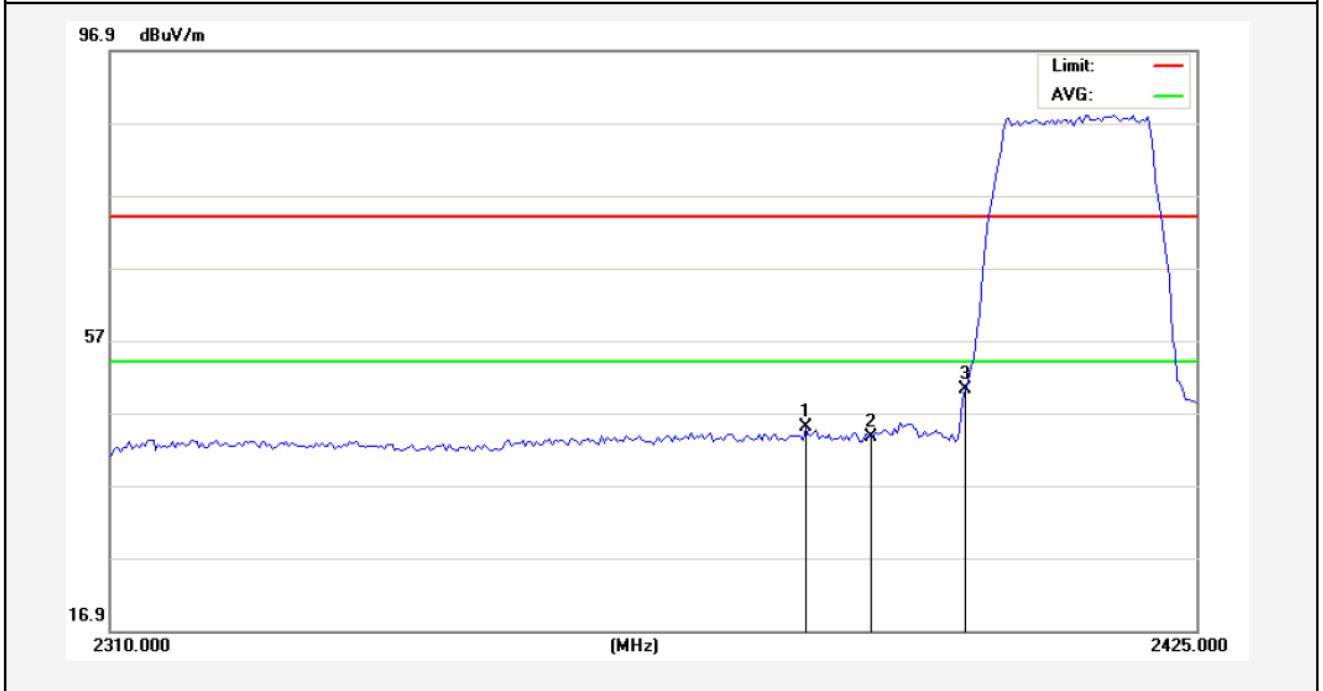

No.	Freq. (MHz)	Reading (dBuV/m)	Factor (dB/m)	Result (dBuV/m)	Limit (dBuV/)	Over Limit (dB)	Detector	Height (cm)	degree (deg)	Remark
1	2383.025	47.50	-2.53	44.97	74.00	-29.03	peak			
2	2390.000	46.13	-2.51	43.62	74.00	-30.38	peak			
3	2400.000	52.73	-2.49	50.24	74.00	-23.76	peak			

Anbotek

Vertical-AV:

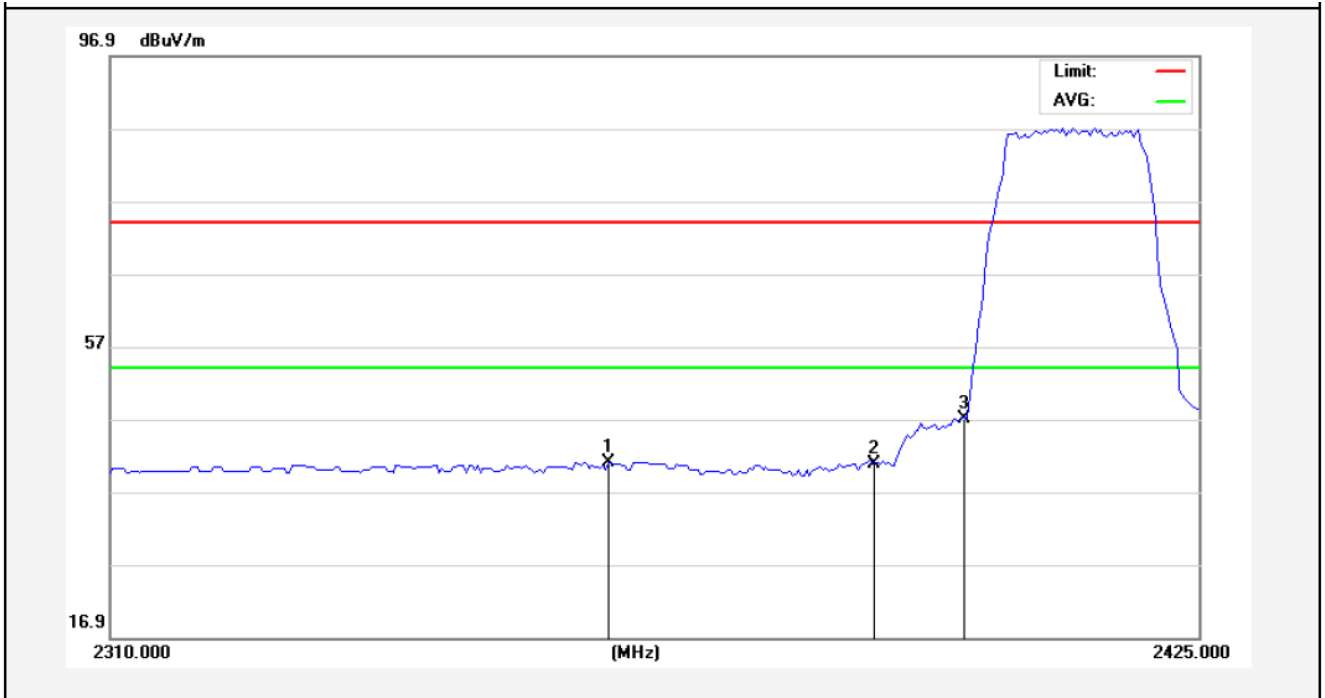

No.	Freq. (MHz)	Reading (dBuV/m)	Factor (dB/m)	Result (dBuV/m)	Limit (dBuV/)	Over Limit (dB)	Detector	Height (cm)	degree (deg)	Remark
1	2362.037	43.58	-2.58	41.00	54.00	-13.00	AVG			
2	2390.000	43.30	-2.51	40.79	54.00	-13.21	AVG			
3	2400.000	49.50	-2.49	47.01	54.00	-6.99	AVG			

Anbotek

Test Mode: 802.11n (HT20)

2462MHz

Horizontal-PEAK:

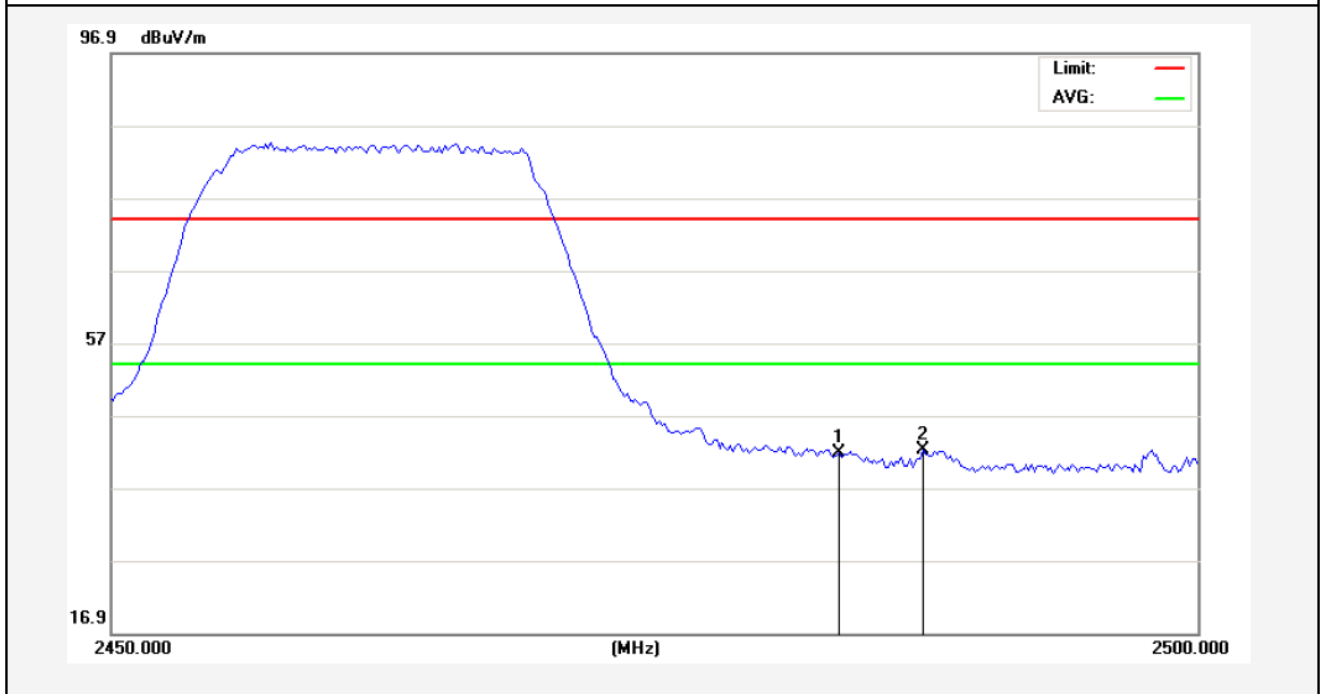

No.	Freq. (MHz)	Reading (dBuV/m)	Factor (dB/m)	Result (dBuV/m)	Limit (dBuV/)	Over Limit (dB)	Detector	Height (cm)	degree (deg)	Remark
1	2483.500	44.09	-2.31	41.78	74.00	-32.22	peak			
2	2487.375	44.56	-2.30	42.26	74.00	-31.74	peak			

Anbotek

Horizontal-AV:

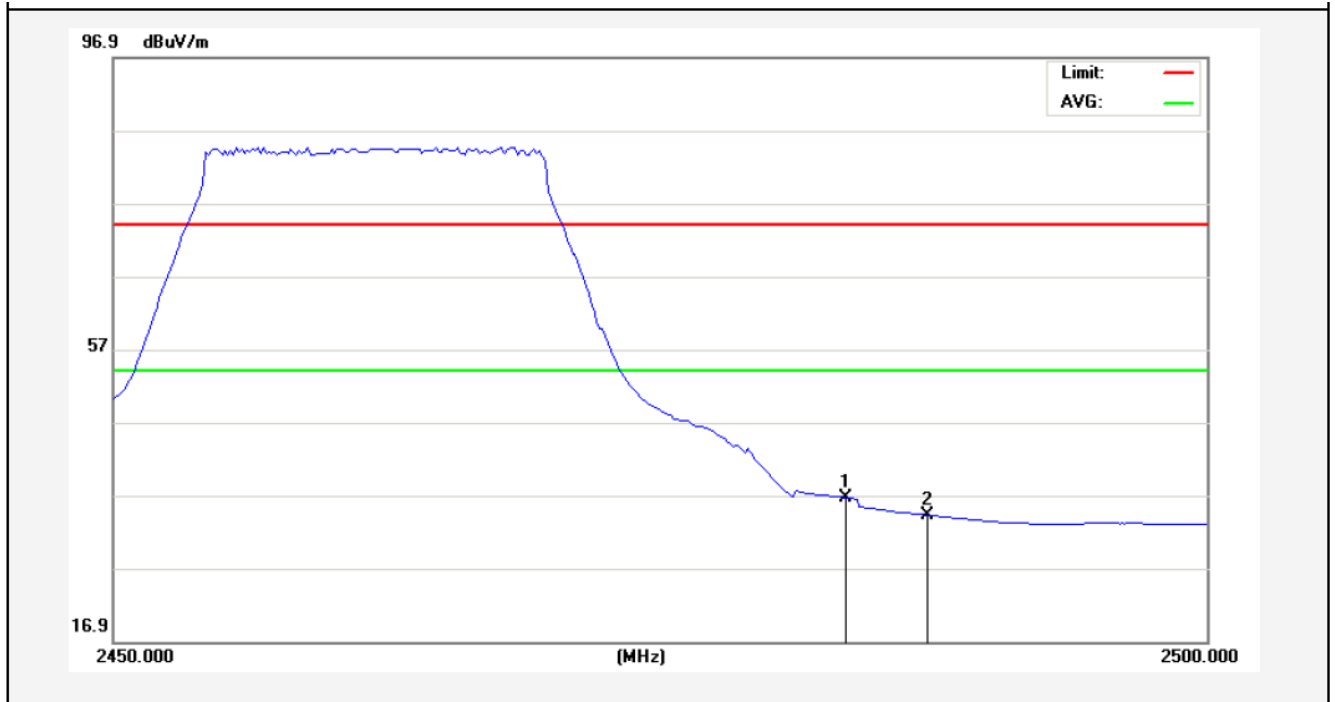

No.	Freq. (MHz)	Reading (dBuV/m)	Factor (dB/m)	Result (dBuV/m)	Limit (dBuV/)	Over Limit (dB)	Detector	Height (cm)	degree (deg)	Remark
1	2483.500	38.97	-2.31	36.66	54.00	-17.34	AVG			
2	2487.250	36.55	-2.30	34.25	54.00	-19.75	AVG			

Anbotek

Test Mode: 802.11n (HT20)

2462MHz

Vertical-PEAK:

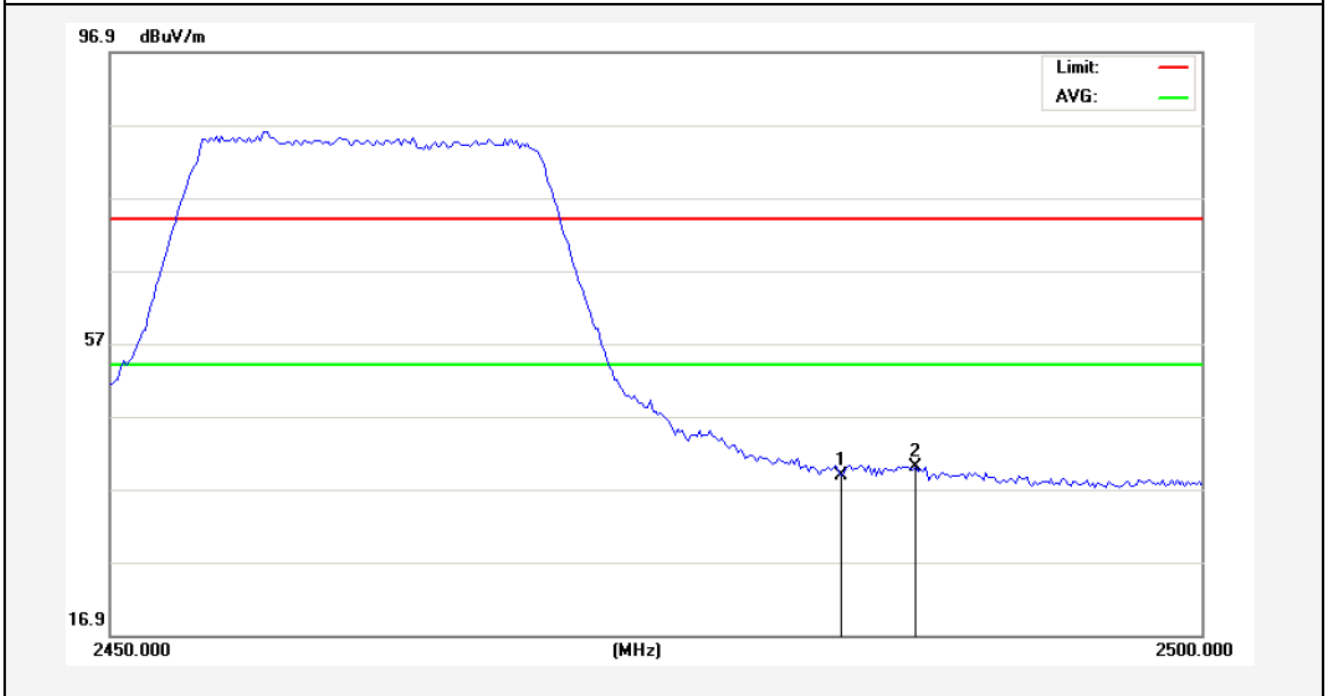

No.	Freq. (MHz)	Reading (dBuV/m)	Factor (dB/m)	Result (dBuV/m)	Limit (dBuV/)	Over Limit (dB)	Detector	Height (cm)	degree (deg)	Remark
1	2483.500	41.12	-2.31	38.81	74.00	-35.19	peak			
2	2486.875	42.33	-2.30	40.03	74.00	-33.97	peak			

Anbotek

Vertical-AV:

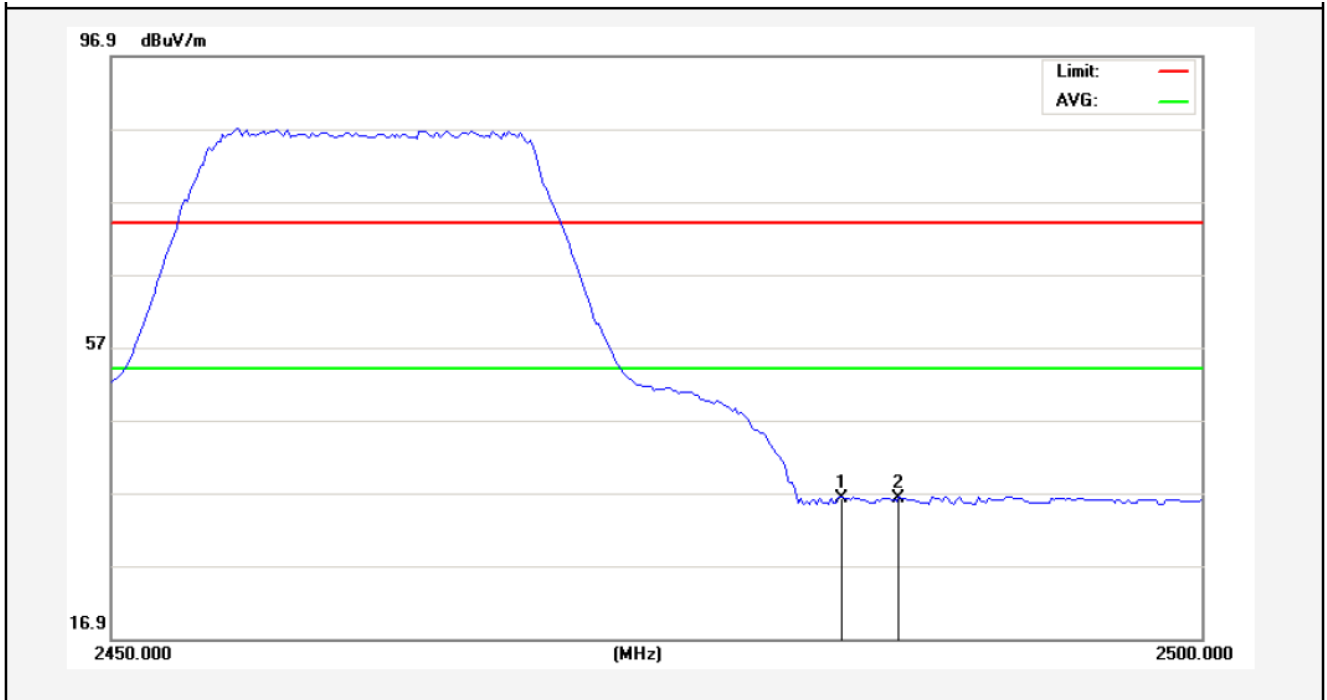

No.	Freq. (MHz)	Reading (dBuV/m)	Factor (dB/m)	Result (dBuV/m)	Limit (dBuV/)	Over Limit (dB)	Detector	Height (cm)	degree (deg)	Remark
1	2483.500	38.61	-2.31	36.30	54.00	-17.70	AVG			
2	2486.125	38.60	-2.30	36.30	54.00	-17.70	AVG			

Anbotek

Test Mode: 802.11n (HT40)

2422MHz

Horizontal-PEAK:

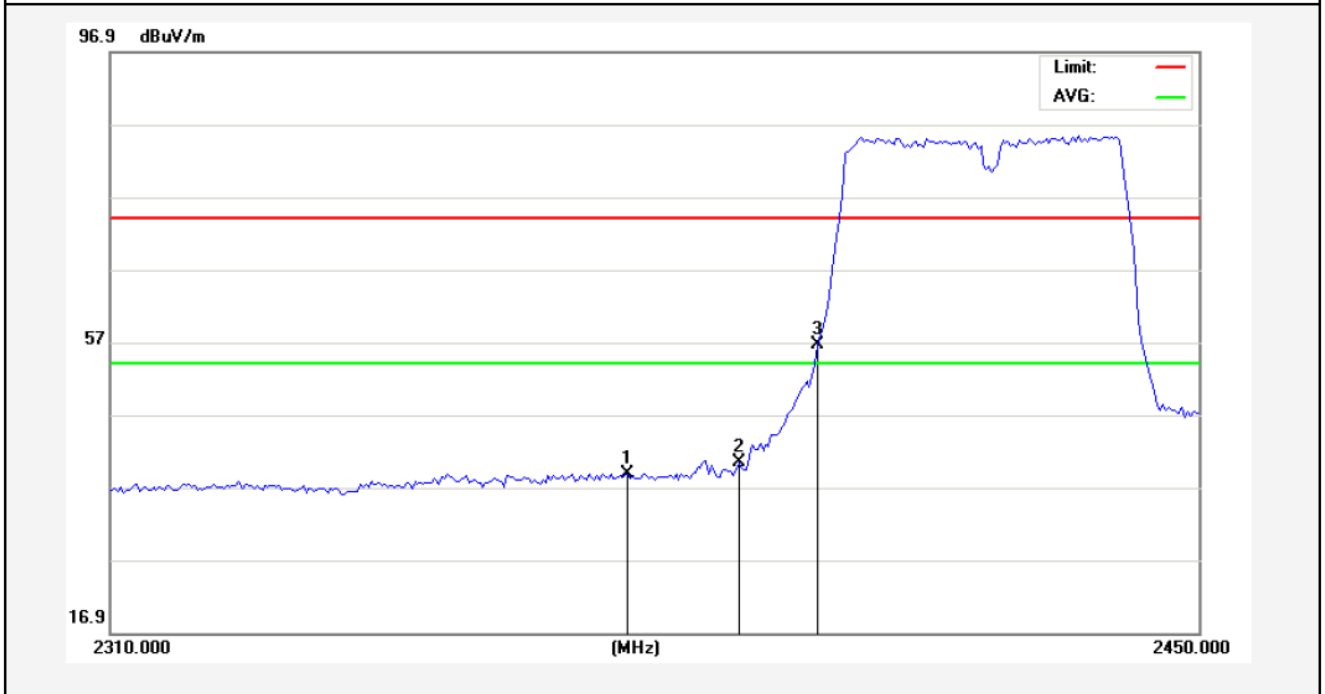

No.	Freq. (MHz)	Reading (dBuV/m)	Factor (dB/m)	Result (dBuV/m)	Limit (dBuV/)	Over Limit (dB)	Detector	Height (cm)	degree (deg)	Remark
1	2375.800	41.31	-2.55	38.76	74.00	-35.24	peak			
2	2390.000	43.01	-2.51	40.50	74.00	-33.50	peak			
3	2400.000	59.01	-2.49	56.52	74.00	-17.48	peak			

Anbotek

Horizontal-AV:

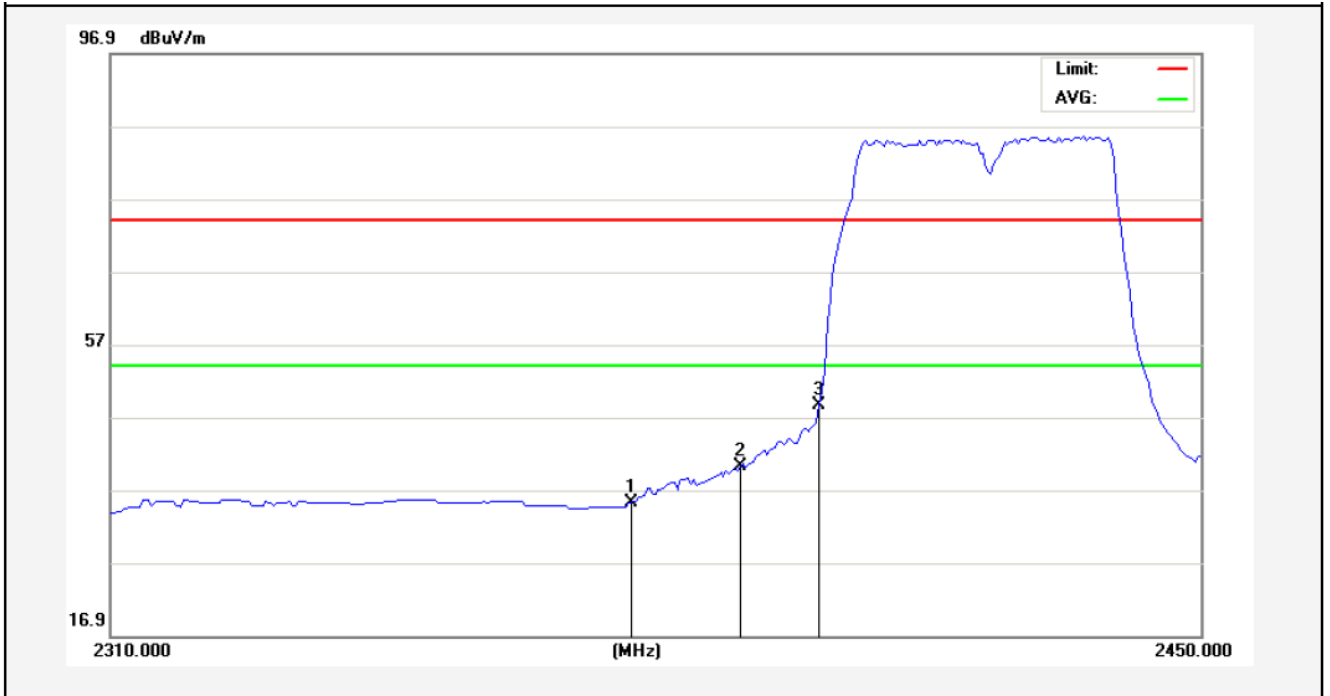

No.	Freq. (MHz)	Reading (dBuV/m)	Factor (dB/m)	Result (dBuV/m)	Limit (dBuV/)	Over Limit (dB)	Detector	Height (cm)	degree (deg)	Remark
1	2376.150	37.82	-2.54	35.28	54.00	-18.72	AVG			
2	2390.000	42.65	-2.51	40.14	54.00	-13.86	AVG			
3	2400.000	51.14	-2.49	48.65	54.00	-5.35	AVG			

Anbotek

Test Mode: 802.11n (HT40)

2422MHz

Vertical-PEAK:

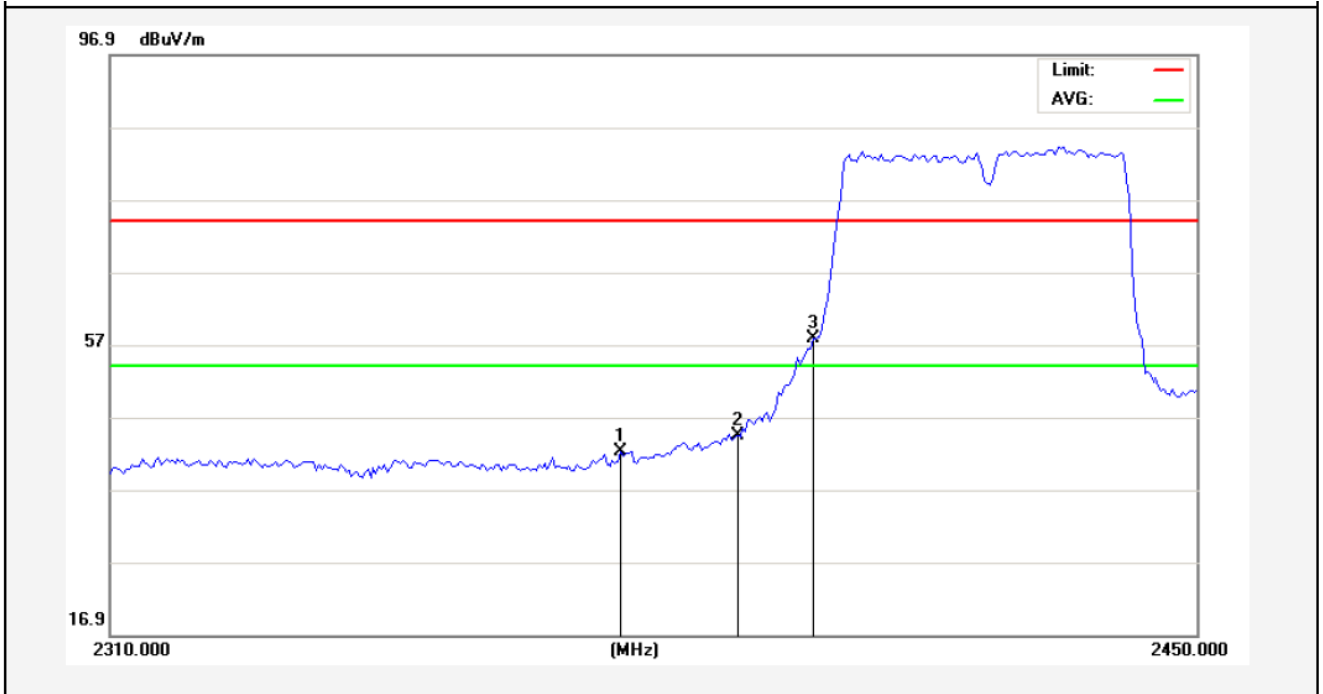

No.	Freq. (MHz)	Reading (dBuV/m)	Factor (dB/m)	Result (dBuV/m)	Limit (dBuV/)	Over Limit (dB)	Detector	Height (cm)	degree (deg)	Remark
1	2375.100	44.75	-2.55	42.20	74.00	-31.80	peak			
2	2390.000	46.96	-2.51	44.45	74.00	-29.55	peak			
3	2400.000	60.22	-2.49	57.73	74.00	-16.27	peak			

Anbotek

Vertical-AV:

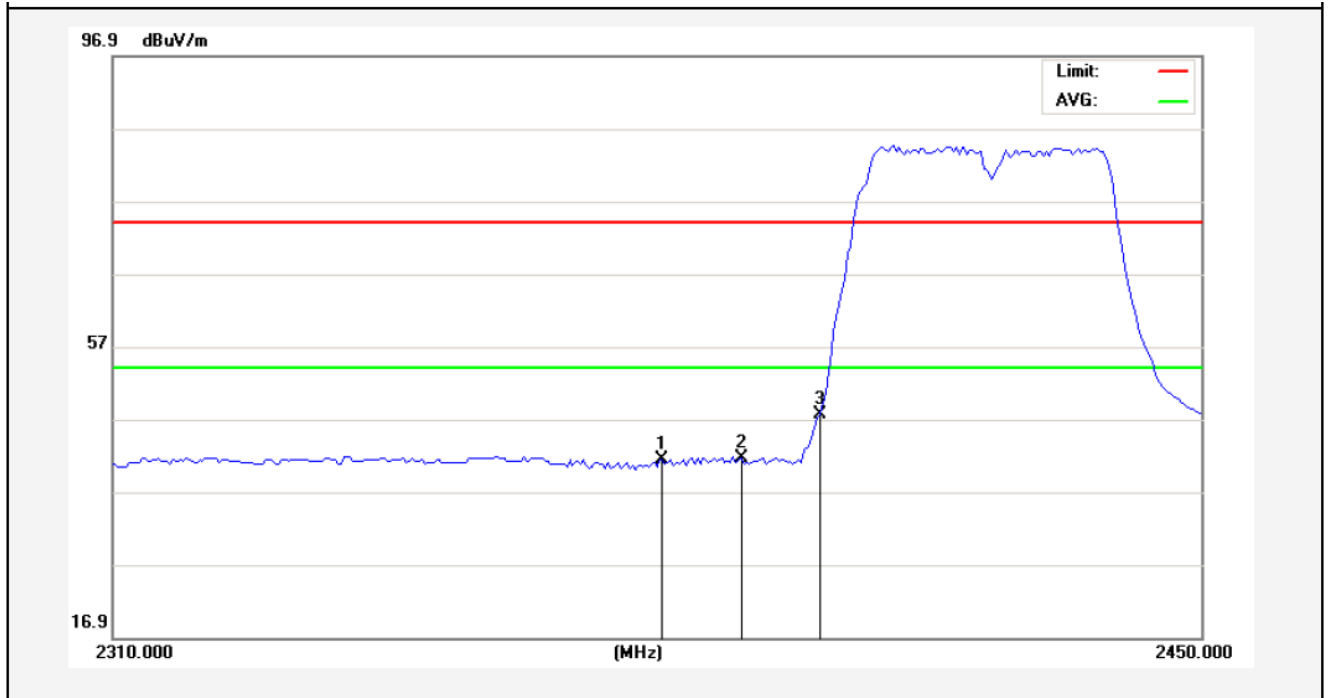

No.	Freq. (MHz)	Reading (dBuV/m)	Factor (dB/m)	Result (dBuV/m)	Limit (dBuV/)	Over Limit (dB)	Detector	Height (cm)	degree (deg)	Remark
1	2380.000	43.97	-2.54	41.43	54.00	-12.57	AVG			
2	2390.000	44.14	-2.51	41.63	54.00	-12.37	AVG			
3	2400.000	50.16	-2.49	47.67	54.00	-6.33	AVG			

Anbotek

Test Mode: 802.11n (HT40)

2452MHz

Horizontal-PEAK:

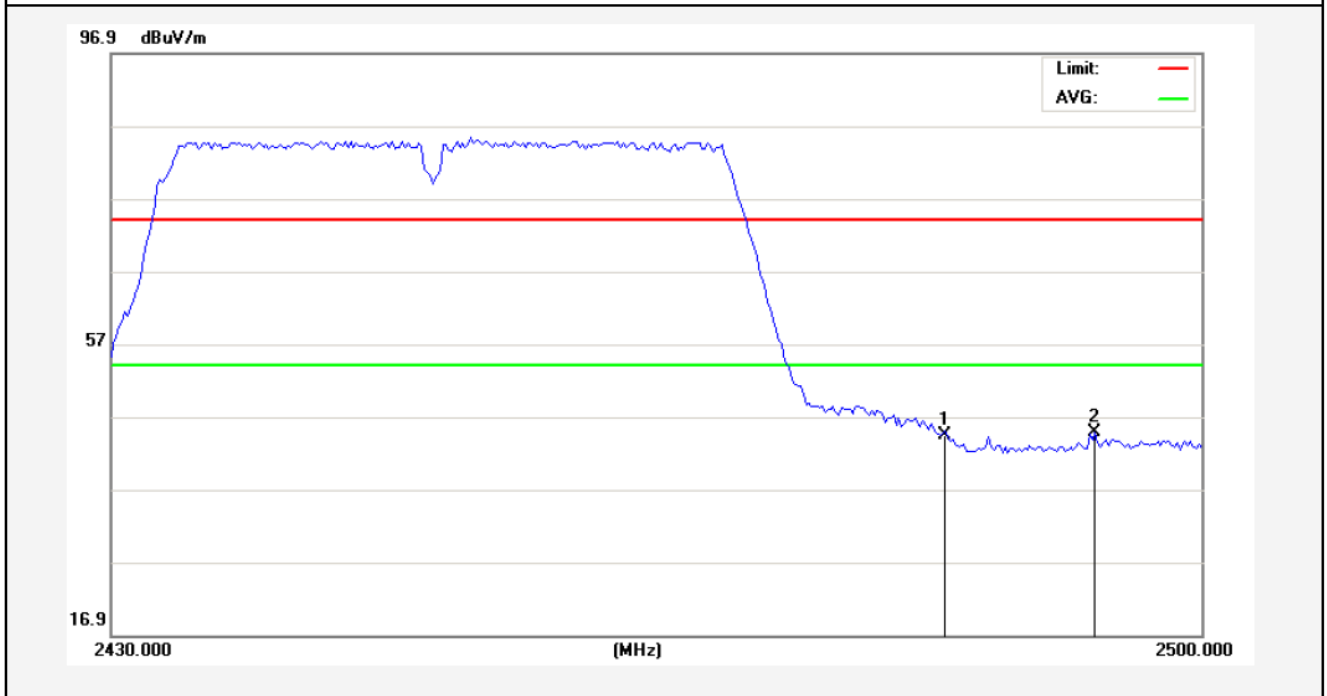

No.	Freq. (MHz)	Reading (dBuV/m)	Factor (dB/m)	Result (dBuV/m)	Limit (dBuV/)	Over Limit (dB)	Detector	Height (cm)	degree (deg)	Remark
1	2483.500	46.73	-2.31	44.42	74.00	-29.58	peak			
2	2493.175	47.18	-2.29	44.89	74.00	-29.11	peak			

Anbotek

Horizontal-AV:

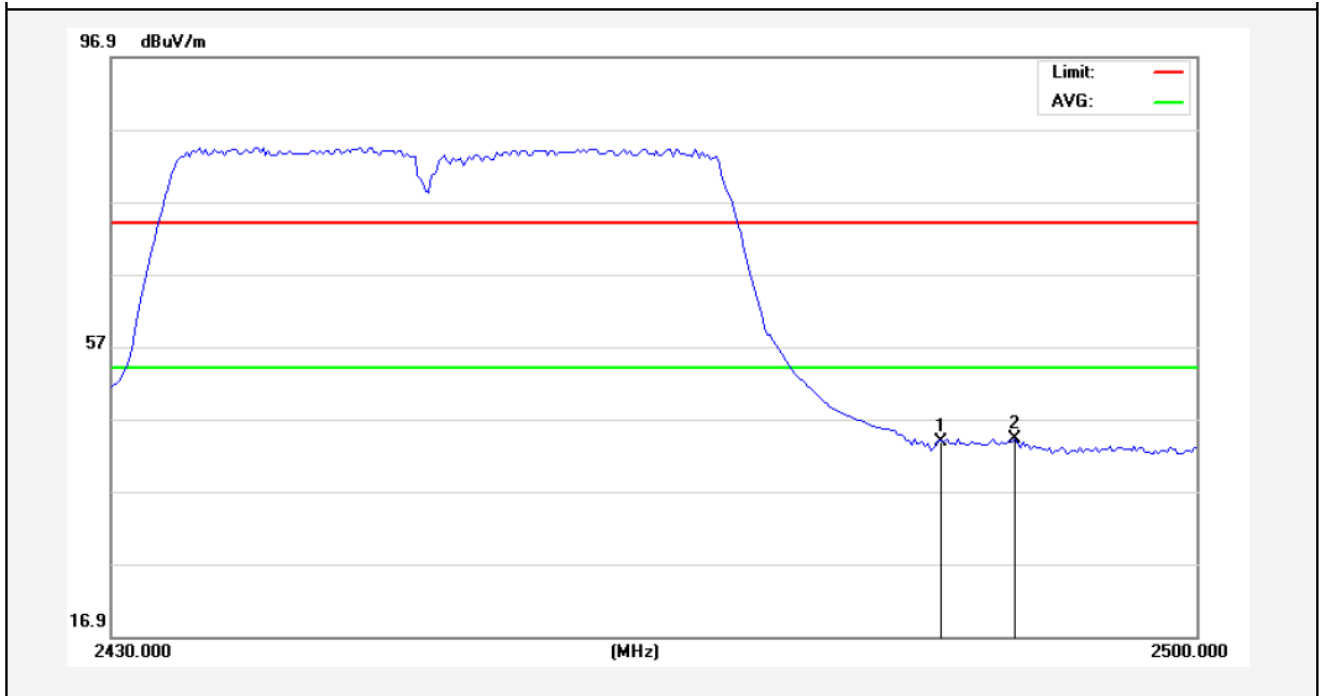

No.	Freq. (MHz)	Reading (dBuV/m)	Factor (dB/m)	Result (dBuV/m)	Limit (dBuV/)	Over Limit (dB)	Detector	Height (cm)	degree (deg)	Remark
1	2483.500	46.20	-2.31	43.89	54.00	-10.11	AVG			
2	2488.275	46.50	-2.30	44.20	54.00	-9.80	AVG			

Anbotek

Test Mode: 802.11n (HT40)  
2452MHz  
Vertical-PEAK:

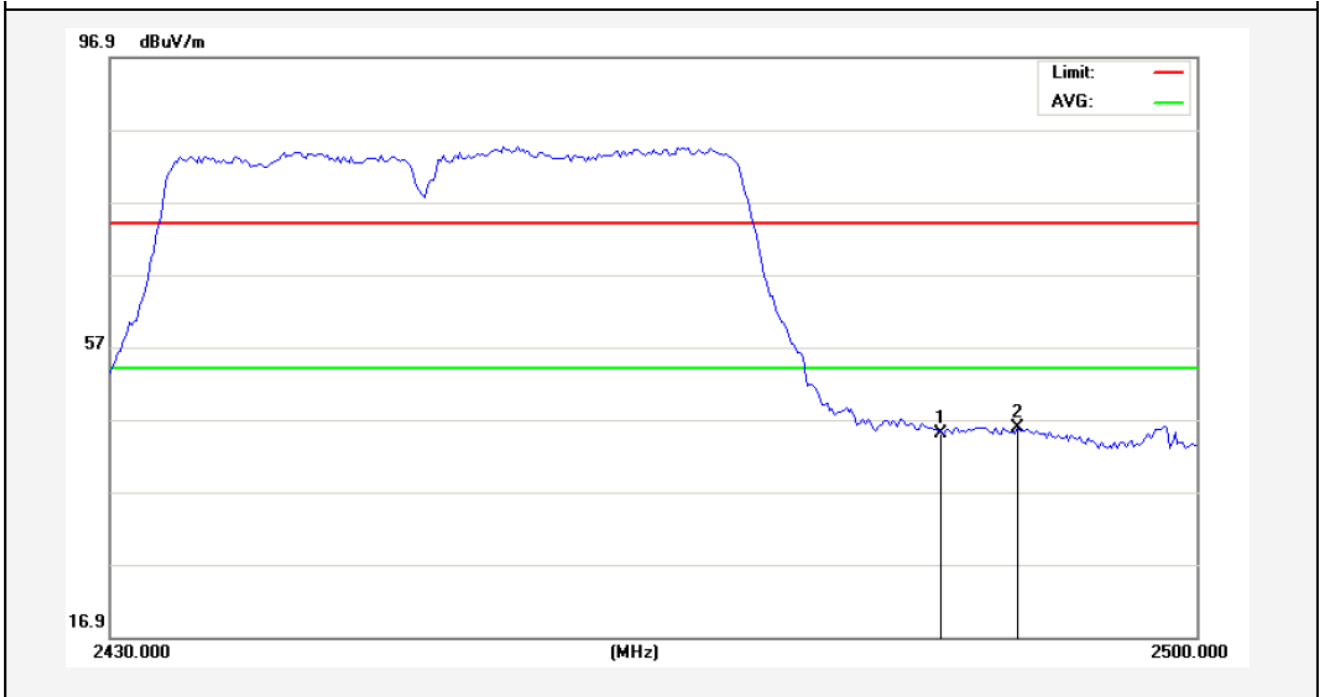

No.	Freq. (MHz)	Reading (dBuV/m)	Factor (dB/m)	Result (dBuV/m)	Limit (dBuV/)	Over Limit (dB)	Detector	Height (cm)	degree (deg)	Remark
1	2483.500	47.31	-2.31	45.00	74.00	-29.00	peak			
2	2488.450	48.17	-2.30	45.87	74.00	-28.13	peak			

Anbotek

Vertical-AV:

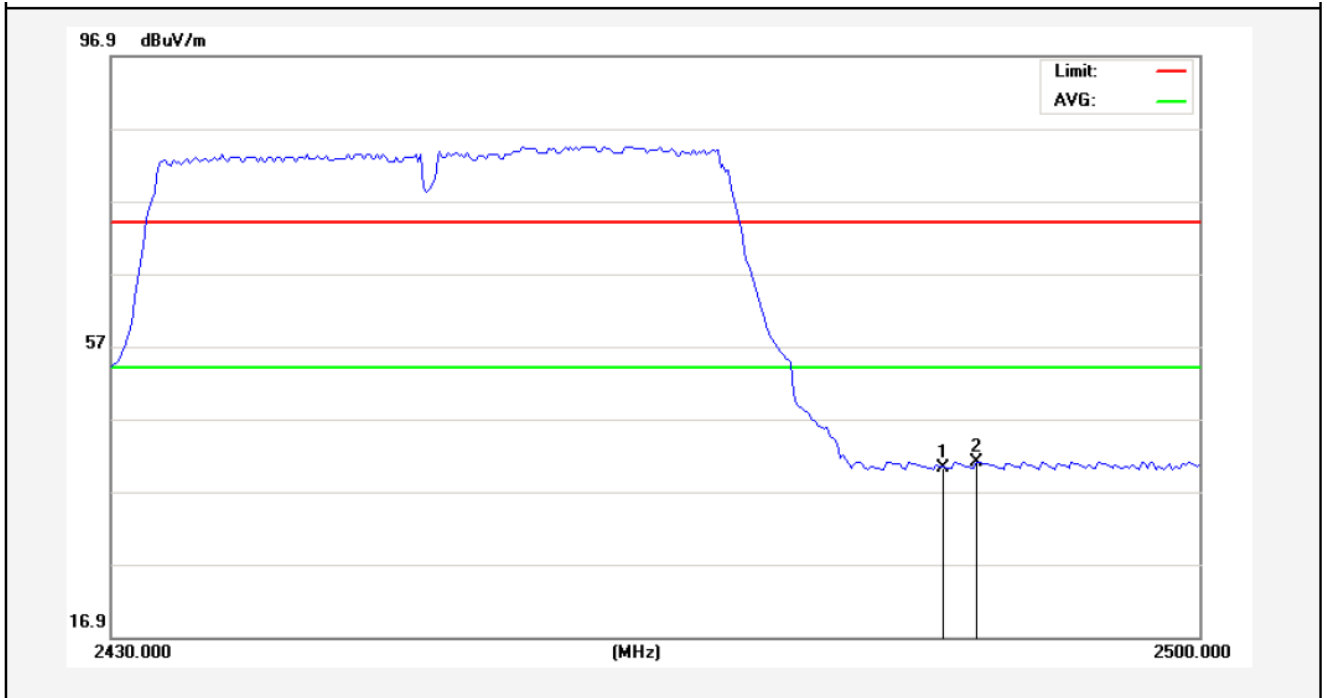

No.	Freq. (MHz)	Reading (dBuV/m)	Factor (dB/m)	Result (dBuV/m)	Limit (dBuV/)	Over Limit (dB)	Detector	Height (cm)	degree (deg)	Remark
1	2483.500	42.60	-2.31	40.29	54.00	-13.71	AVG			
2	2485.650	43.30	-2.30	41.00	54.00	-13.00	AVG			

Anbotek

#### 4.5. Peak Power Spectral Density

##### **a. Limit**

1. For direct sequence systems, the peak power spectral density conducted from the intentional radiator to the antenna shall not be greater than 8dBm in any 3kHz band during any time interval of continuous transmission.
2. The direct sequence operating of the hybrid system, with the frequency hopping operation turned off, shall comply with the power density requirements of paragraph (d) of this section.

##### **b. Test Procedure**

1. Place the EUT on the table and set it in transmitting mode. Remove the antenna from the EUT and then connect a low loss RF cable from the antenna port to the spectrum analyzer.
2. Set the spectrum analyzer as RBW = 10kHz, VBW = 30kHz, Span = 1.5xDTS BW
3. Record the max. reading.
4. Repeat the above procedure until the measurements for all frequencies are completed.

##### **c. Test Equipment**

Same as the equipment listed in 4.2.

##### **d. Test Setup**

See 4.1

##### **e. Test Results**

Pass

##### **f. Test Data**

Please refer to the following data.

##### **g. Test Plot** See the following pages

Test mode: IEEE 802.11b

Channel	Frequency (MHz)	PPSD (dBm/3KHz)	∑PPSD (dBm/3KHz)	Limit (dBm)	Result
Low	2412	-7.781	-	8.00	Pass
Mid	2437	-4.900	-		Pass
High	2462	-6.315	-		Pass

Test mode: IEEE 802.11g

Channel	Frequency (MHz)	PPSD (dBm)	∑PPSD (dBm)	Limit (dBm)	Result
Low	2412	-14.089	-	8.00	Pass
Mid	2437	-11.265	-		Pass
High	2462	-12.728	-		Pass

Test mode: IEEE 802.11n (HT20)

Channel	Frequency (MHz)	PPSD (dBm/3KHz)	∑PPSD (dBm/3KHz)	Limit (dBm)	Result
Low	2412	-12.243	-	8.00	Pass
Mid	2437	-11.568	-		Pass
High	2462	-12.175	-		Pass

Test mode: IEEE 802.11n (HT40)

Channel	Frequency (MHz)	PPSD (dBm/3KHz)	∑PPSD (dBm/3KHz)	Limit (dBm)	Result
Low	2422	-18.560	-	8.00	Pass
Mid	2437	-14.695	-		Pass
High	2452	-17.294	-		Pass



Test Mode: 802.11b---Low



Test Mode: 802.11b---Mid



Test Mode: 802.11b---High

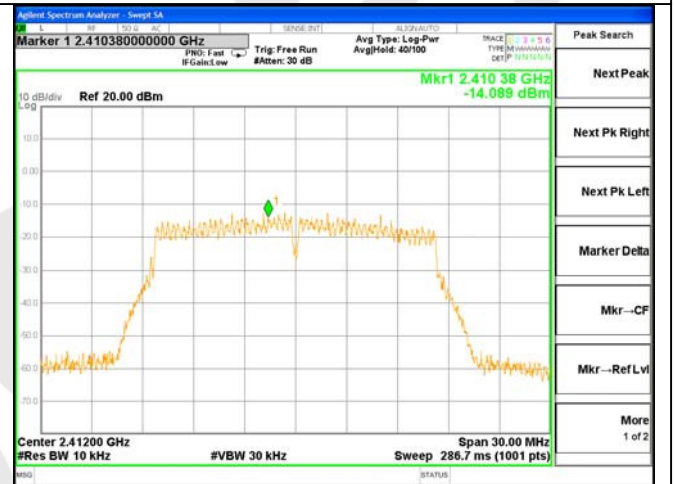

Test Mode: 802.11g---Low

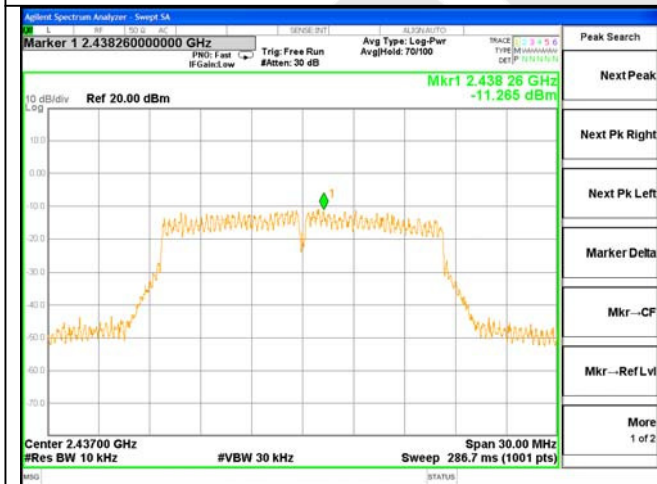

Test Mode: 802.11g---Mid

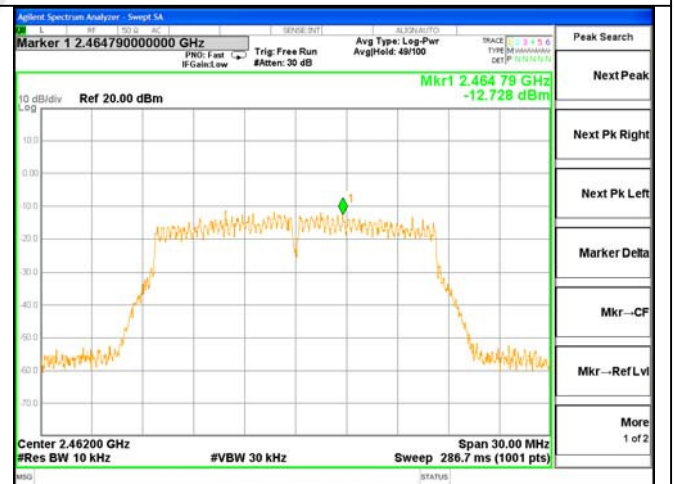

Test Mode: 802.11g---High

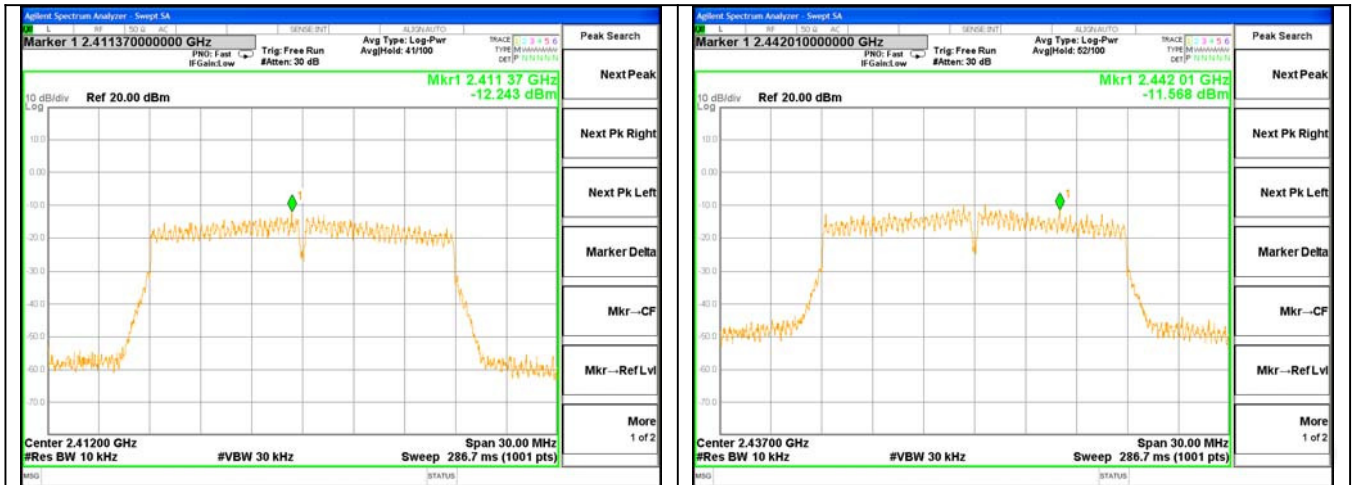

Test Mode: 802.11n20---Low

Test Mode: 802.11n20---Mid

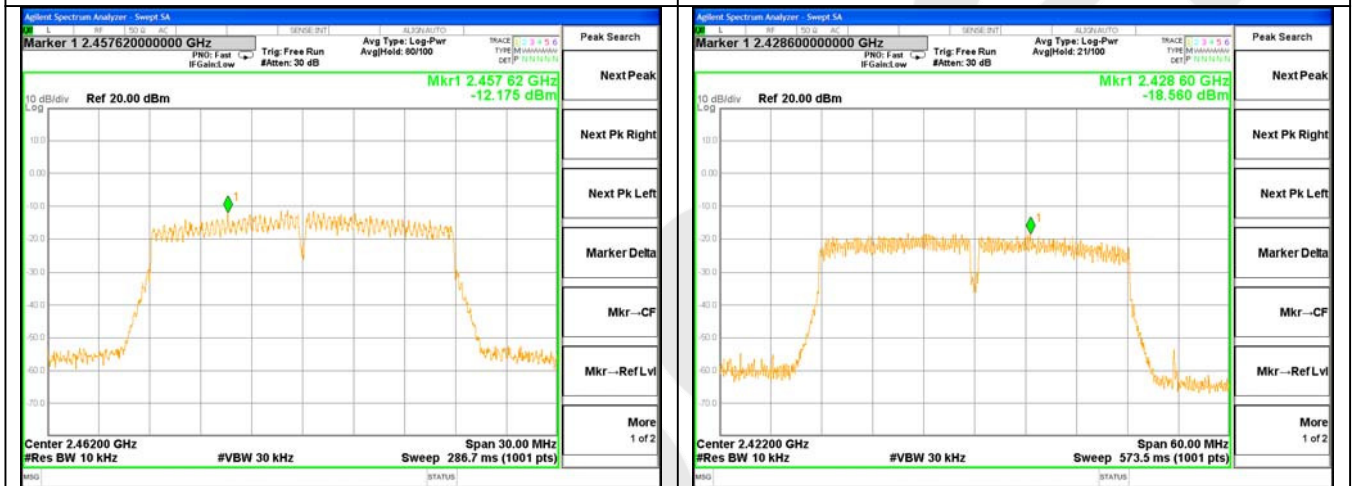

Test Mode: 802.11n20---High

Test Mode: 802.11n40---Low

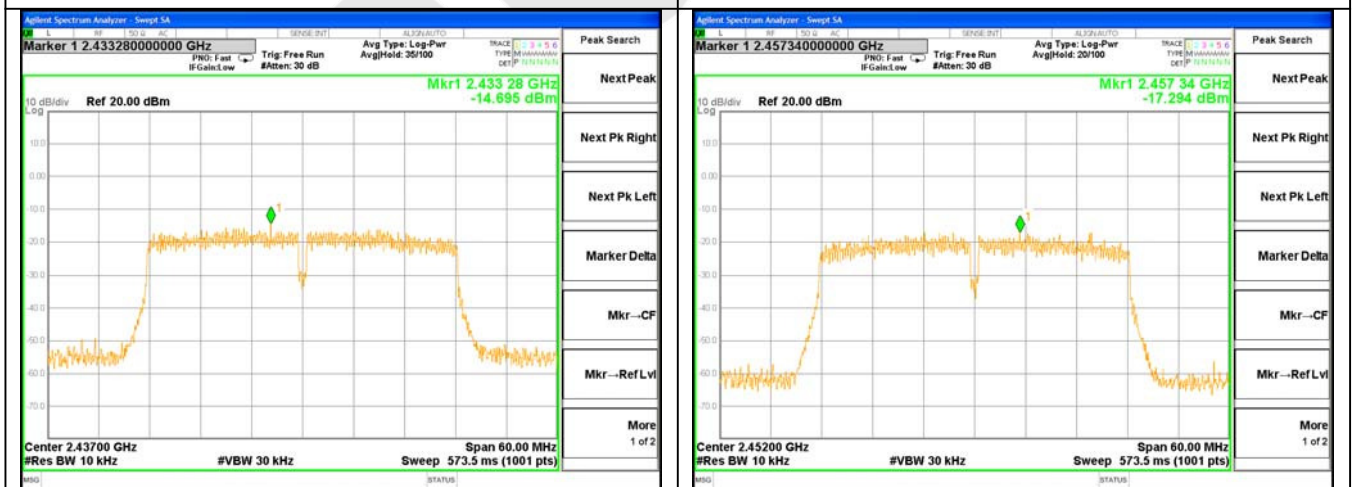

Test Mode: 802.11n40---Mid

Test Mode: 802.11n40---High