

Can't connect? Need help?



DO NOT RETURN THIS
PRODUCT TO THE STORE

Call 1-800-757-1440
Mon-Fri 9:00-5:00 EST (US)
or email support@atomiusa.com

Wi-Fi

atomi™

Date Code: 05/19

Smart Aroma Diffuser

User Manual

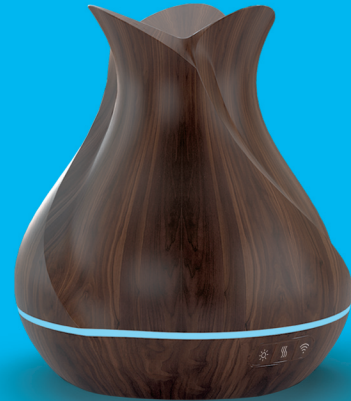

atomi™
smart

Download Free APP

Watch Video

Open your smartphone camera
and point it at the QR Code

IMPORTANT SAFEGUARDS

TO AVOID RISK OF ELECTRICAL SHOCK, always make sure the Smart Aroma Diffuser is unplugged from the electrical outlet before relocating, servicing, or cleaning it.

When using electrical appliances, basic safety precautions should always be followed to reduce the risk of fire, electric shock, and / or injury to persons, including the following:

1. READ ALL INSTRUCTIONS BEFORE USING.
1. DO NOT move once the diffuser has been filled with water.
2. DO NOT operate outdoors. This diffuser is intended for indoor use only.
3. Disconnect the diffuser from power before cleaning.
4. DO NOT operate without water. Always have water in the base when operating.
5. Use only clean, cool water to fill the base. Do not use hot water.
6. DO NOT pour water into any openings other than the base.
7. DO NOT cover any openings on the unit or insert objects into any openings.
8. DO NOT aim mist directly at children, pets, walls, furniture or electrical appliances.
9. Use only with the provided electrical cord.
10. ALWAYS plug and unplug diffuser with dry hands to avoid electric shock.
11. Never operate the diffuser with a damaged cord or plug.
12. Always place the unit on a smooth, flat, lint-free, non-metallic, waterproof and level surface.
13. Position the diffuser away from direct sunlight.
14. Keep the cord away from heated surfaces and areas where it could be walked on or tripped over.
15. Unplug the diffuser when not in use and whenever you clean or move the unit.

16. The diffuser should not be left unattended in a closed room.
17. The diffuser requires daily and weekly cleaning to operate appropriately. Refer to cleaning instructions.
18. NEVER use detergents, solvents or abrasive agents to clean the diffuser.
19. Do not tilt, tip or attempt to empty or fill the diffuser while it is in operation.

Safety Warning

Although your diffuser is easy to operate, for your safety, the below warnings must be followed:

1. Do not place the diffuser near a heat source.
2. Never leave the diffuser unattended while connected to the electrical outlet.
3. To avoid any accidents, never cover the lid when the diffuser is in operation.
4. Use the diffuser on a smooth, flat, lint-free, non-metallic, waterproof, and level surface away from water.
5. Do not unplug from the wall socket by pulling on the supply cord.
6. The diffuser must be unplugged:
 - A. Before either filling or emptying the base.
 - B. Before any cleaning or maintenance is performed.
 - C. After each use.
 - D. If it appears to be faulty.

NOTE: This product is intended for HOUSEHOLD USE ONLY.

SAVE THESE INSTRUCTIONS

Thank you for purchasing the atomi Smart Aroma Diffuser

Designed to fill the air with fragrance and moisture, the atomi Smart Aroma Diffuser is a perfect tool for aromatic relaxation. Just add a few drops of your favorite essential oil with water in the tank and unwind. Control the Smart Aroma Diffuser from anywhere at anytime using your smartphone.

Inside the box you'll find:

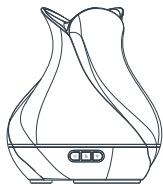

Smart Aroma Diffuser

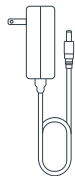

Power Supply



User Manual

Specifications

Power Supply

Input: 100-240V~50/60Hz 0.4A

Max Output: 24V --- 500mA

Smart Aroma Diffuser

Input: 24V --- 500mA

Working Frequency: 2.4MHz

Tank Capacity: 400ML Watts : 12W

Getting to know the Smart Aroma Diffuser

The Smart Aroma Diffuser uses ultrasonic waves to instantly vaporize water and essential oil in the tank, to produce a cool, dry fragrant mist.

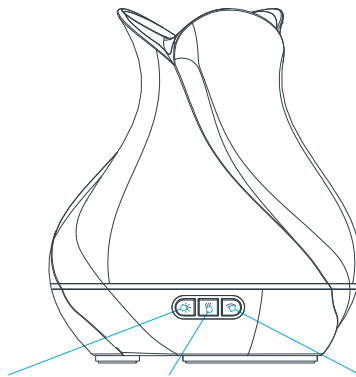

LED Light
Changes color
mode. Hold to
turn OFF light.

Mist LOW/HIGH
Toggles between
LOW/HIGH/OFF
mist modes.

ON/OFF/Wi-Fi
Powers ON/OFF
Connects to
Wi-Fi setup.

Before you begin

1. Know your Wi-Fi network and password.
2. Make sure your mobile device is running iOS® 8 or higher or Android™ 4.1× or higher.
3. Make sure you're connected to a 2.4GHz Wi-Fi network (atomi smart can't connect to 5GHz networks).

Step 1: Plug in

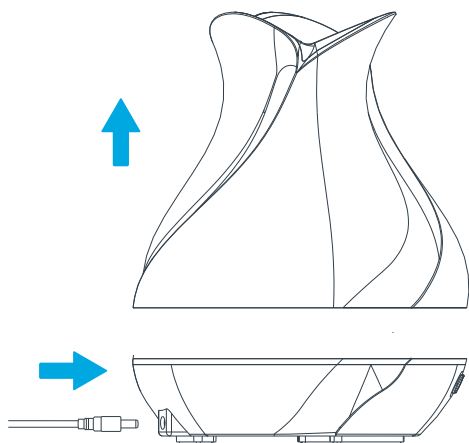

Remove the outer cover and the water tank cover. Plug the Smart Aroma Diffuser into Power Outlet.

Step 2: Add

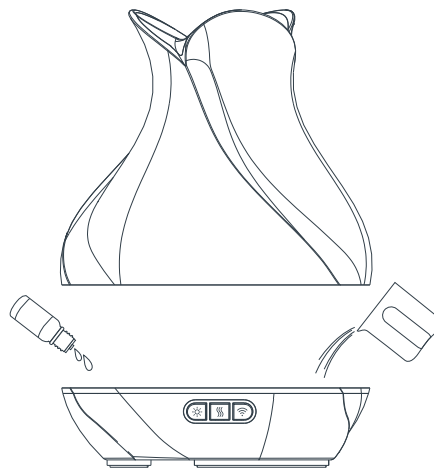

Using the measuring cup, carefully add cool water to the reservoir. Add desired essential oils to the water tank.

NOTE: Do not exceed the maximum level. Do not add water while the diffuser is on.

Step 3: Download App

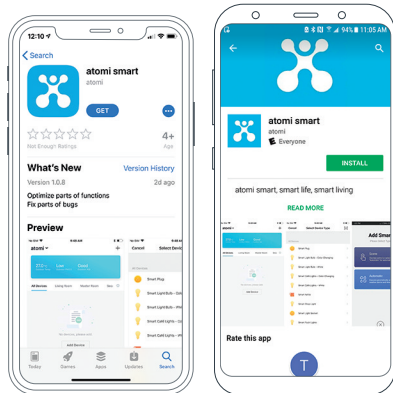

Download the atomi smart app from the App Store or Google Play.

Step 4: Register

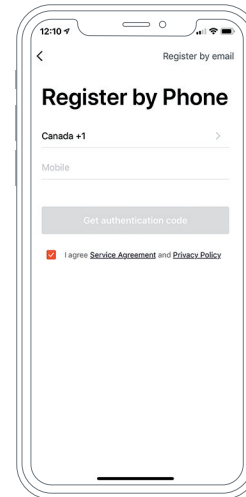

Enter your mobile phone number or email address.

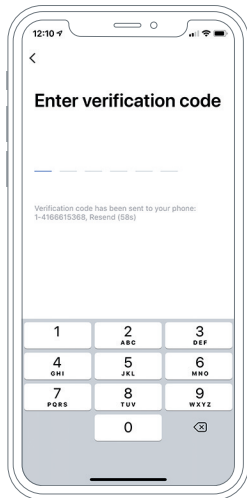

Enter the verification code and create a password.

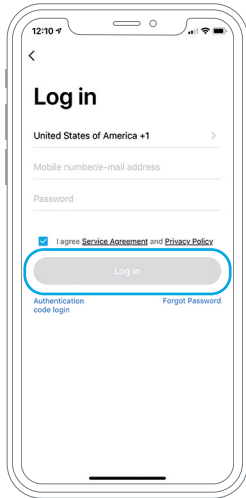

Log into the app.

Step 5: Add Device

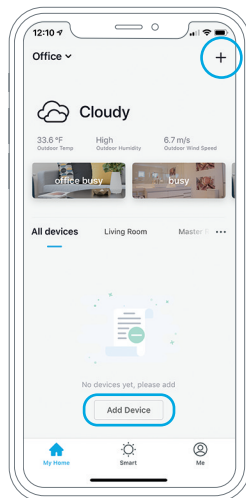

Select "Add Device" or click (+) at the top right corner of the devices screen.

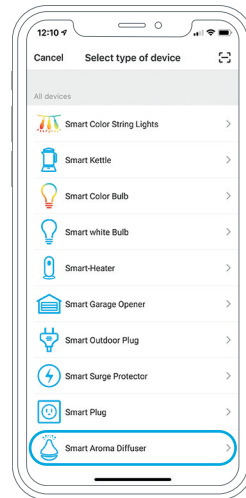

Choose "Smart Aroma Diffuser" from the device list.

Step 6: Wi-Fi Setup

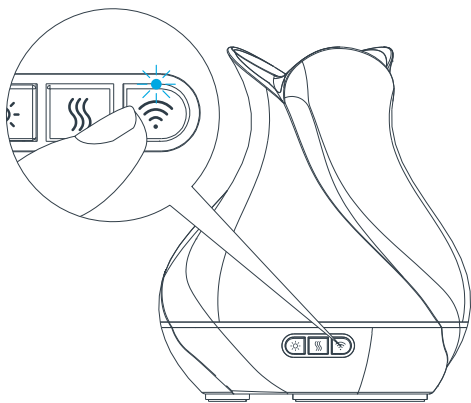

Hold the Wi-Fi button
for 5 seconds until the indicator light
rapidly blinks, then press “Continue” on
the atomi smart app.



Enter your Wi-Fi
network and
password.

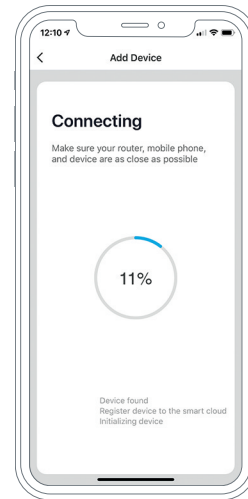

The atomi smart
app will connect
your device.

Spray

Countdown



Press to
change mist
spray intensity.

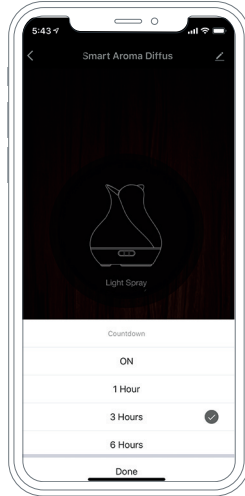

Sets a
countdown
to shut off spray.

Gradient

Fixed



Press to activate
auto gradient
light preset.



Select to
change and
adjust LED color.

Nightlight



Press to activate
Nightlight
LED preset.

Schedule

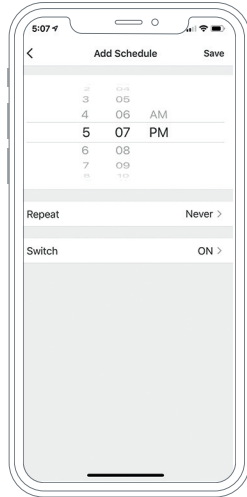

Sets weekly
schedules to
fit your lifestyle.

Cleaning and Maintaining your Smart Aroma Diffuser

CAUTION: Always be sure the Smart Aroma Diffuser is switched OFF, unplugged before cleaning or attempting to store the item.

Care and Cleaning

After using 5-6 times, or 3-5 days, please clean the product as follow:

1. Unplug the unit from power supply and remove cover.
2. Pour out any remaining water from the tank.
3. Add a small amount of warm dish detergent, and wipe it gently, then use a cleaning cloth to dry it gently.
4. Pour water away from the air outlet.
5. Do not use other acids or enzyme detergents, as this may give off hazardous gas or cause malfunction.
6. If diffuser is not used for an extended period, drain water from the reservoir and allow to dry. Before using, clean the reservoir with a mild detergent.

NOTE: Be sure to use a mild detergent.

Storing

Allow the Smart Aroma Diffuser to dry off completely before storing. Store in a dry location. Do not place heavy items on top of the Smart Aroma Diffuser during storage as this may result in possible damage.

Troubleshooting

Cannot connect to your Wi-Fi network.

Make sure you entered the correct Wi-Fi password during the Wi-Fi setup. Check whether there are problems with your internet connection. If the Wi-Fi signal is too weak, reset your Wi-Fi router and try again.

Setup is not working properly.

1. Close all apps that are running in the background then re-open the atomi smart app.
2. Uninstall and reinstall the atomi smart app then repeat the setup process.

Smart Aroma Diffuser will not turn ON/OFF

Check to see if there's enough water in the tank. If not use the measuring cup to fill tank with appropriate amount of water. Check that the plug is fully inserted into the bottom of the base.

There is no mist being emitted.

1. Check the water level. The unit shuts off automatically when the water level is too low as a safety feature.
2. Make sure nothing is blocking the Mist Output.
3. Check the fan vent on the bottom of the base is not blocked.
4. Empty and rinse the water reservoir with cool tap water.

FCC Notice:

This device complies with Part 15 of the FCC Rules. Operation is subject to the two following conditions:

1. This device may not cause harmful interference.
2. This device must accept any interference received, including interference that may cause undesired operation.

NOTE: This equipment has been tested and found to comply with the limits for a Class B digital device, pursuant to Part 15 of the FCC Rules. These limits are designed to provide reasonable protection against harmful interference in a residential installation.

CAUTION: Suitable for indoor use only.

Made in China

For questions or concerns, email us at info@atomiusa.com

Manufactured and marketed by Atomi, Inc.

10 West 33rd St. Suite 520, New York, NY 10001 atomi™ is a trademark of Atomi, Inc.

Designed by atomi in New York. Made in China

One-year limited warranty from date of purchase against defects in materials and workmanship. Google is a trademark of Google LLC. Amazon, Alexa and all related logos are trademarks of Amazon.com, Inc. or its affiliates.

FCC Warning

This device complies with part 15 of the FCC rules. Operation is subject to the following two conditions: (1) this device may not cause harmful interference, and (2) this device must accept any interference received, including interference that may cause undesired operation.

Changes or modifications not expressly approved by the party responsible for compliance could void the user's authority to operate the equipment.

NOTE: This equipment has been tested and found to comply with the limits for a Class B digital device, pursuant to part 15 of the FCC Rules. These limits are designed to provide reasonable protection against harmful interference in a residential installation. This equipment generates uses and can radiate radio frequency energy and, if not installed and used in accordance with the instructions, may cause harmful interference to radio communications. However, there is no guarantee that interference will not occur in a particular installation. If this equipment does cause harmful interference to radio or television reception, which can be determined by turning the equipment off and on, the user is encouraged to try to correct the interference by one or more of the following measures:

- Reorient or relocate the receiving antenna.
- Increase the separation between the equipment and receiver.
- Connect the equipment into an outlet on a circuit different from that to which the receiver is connected.
- Consult the dealer or an experienced radio/TV technician for help.

Radiation Exposure Statement

This equipment complies with FCC radiation exposure limits set forth for an uncontrolled environment. This equipment should be installed and operated with minimum distance 20cm between the radiator and your body.