

TECHNICAL REPORT



Report No: FCC 1607058
File reference No: 2016-08-10

Applicant: Samzuk Technology & Development Co., Ltd

Product: 16 Channel Walkie Talkie

Model No: FPBN10A, FPBAN20A, FPBAN30A, FPBAN40A
FPBAN50A, FPBAN60A, FPBAN70A, FPBAN80A

Trademark: **SAMCOM**

Test Standards: FCC Part 90

Test result: It is herewith confirmed and found to comply with the requirements set up by ANSI C63.10 and FCC Part 90, regulations for the evaluation of electromagnetic compatibility

Approved By

Jack Chung

Jack Chung

Manager

Dated: August 10, 2016

Results appearing herein relate only to the sample tested

The technical reports is issued errors and omissions exempt and is subject to withdrawal at

SHENZHEN TIMEWAY TESTING LABORATORIES

Room 512-519, 5/F., East Tower, Building 4, Anhua Industrial Zone, Futian District, Shenzhen, Guangdong, China

Tel (755) 83448688, Fax (755) 83442996, E-Mail:info@timeway-lab.com



Special Statement:

The testing quality ability of our laboratory meet with "Quality Law of People's Republic of China" Clause 19.

The testing quality system of our laboratory meet with ISO/IEC-17025 requirements, which is approved by CNAL. This approval result is accepted by MRA of APLAC.

Our test facility is recognized, certified, or accredited by the following organizations:

CNAL-LAB Code: L2292

The EMC Laboratory has been assessed and in compliance with CNAL/AC01:2002 accreditation criteria for testing Laboratories (identical to ISO/IEC 17025:1999 General Requirements) for the Competence of testing Laboratories.

FCC-Registration No.: 899988

The EMC Laboratory has been registered and fully described in a report filed with the (FCC) Federal Communications commission. The acceptance letter from the FCC is maintained in our files. Registration No.: 899988.

IC- Registration No.: IC5205A-02

The EMC Laboratory has been registered and fully described in a report filed with the (IC) Industry Canada. The acceptance letter from the IC is maintained in our files. Registration IC No.: 5205A-02.

The report refers only to the sample tested and does not apply to the bulk.

This report is issued in confidence to the client and it will be strictly treated as such by the SHENZHEN TIMEWAY TESTING LABORATORIES. It may not be reproduced rather in its entirety or in part and it may not be used for adverting. The client to whom the report is issued may, however, show or send it . or a certified copy there of prepared by the SHENZHEN TIMEWAY TESTING LABORATORIES. to his customer. Supplier or others persons directly concerned. SHENZHEN TIMEWAY TESTING LABORATORIES. will not, without the consent of the client enter into any discussion of correspondence with any third party concerning the contents of the report.

In the event of the improper use of the report. The SHENZHEN TIMEWAY TESTING LABORATORIES. reserves the rights to withdraw it and to adopt any other remedies which may be appropriate.



Test Report Conclusion
Content

1.0	General Details	4
1.1	Test Lab Details.....	4
1.2	Applicant Details.....	4
1.3	Description of EUT	4
1.4	Submitted Sample.....	4
1.5	Test Duration.....	5
1.6	Test Uncertainty.....	5
1.7	Test By.....	5
2.0	List of Measurement Equipment	6
3.0	Technical Details	7
3.1	Summary of Test Results.....	7
3.2	Test Standards.....	7
4.0	EUT Modification	7
5.0	Power Line Conducted Emission Test	8
6.0	Frequency Tolerance	12
7.0	Emission Bandwidth and Mask	18
8.0	Unwanted Radiation	26
9.0	Modulation Characteristics	42
10.0	Maximum transmitter Power (Conducted Output Power)	48
11.0	Transmitter Frequency Behaviour	50
12.0	Adjacent channel power	56
13.0	Radiated Emission on Receiving Mode	60
14.0	FCC ID Label	63
15.0	Photo of Test	64

The report refers only to the sample tested and does not apply to the bulk.

This report is issued in confidence to the client and it will be strictly treated as such by the SHENZHEN TIMEWAY TESTING LABORATORIES. It may not be reproduced rather in its entirety or in part and it may not be used for advertising. The client to whom the report is issued may, however, show or send it, or a certified copy thereof prepared by the SHENZHEN TIMEWAY TESTING LABORATORIES, to his customer. Supplier or others persons directly concerned. SHENZHEN TIMEWAY TESTING LABORATORIES, will not, without the consent of the client enter into any discussion of correspondence with any third party concerning the contents of the report.

In the event of the improper use of the report. The SHENZHEN TIMEWAY TESTING LABORATORIES, reserves the rights to withdraw it and to adopt any other remedies which may be appropriate.



1.0 General Details

1.1 Test Lab Details

Name : SHENZHEN TIMEWAY TESTING LABORATORIES.
Address: Room 512-519,5/F., East Tower,Building 4, Anhua Industrial Zone, Futian District,Shenzhen, Guangdong China
Telephone: (755) 83448688
Fax: (755) 83442996
Site on File with the Federal Communications Commission – United States
Registration Number: 899988
For 3m & 10 m OATS
Site Listed with Industry Canada of Ottawa, Canada
Registration Number: IC: 5205A-02
For 3m & 10 m OATS

1.2 Applicant Details

Applicant: Samzuk Technology & Development Co., Ltd
Address: High-Tech Zone Xingong Avenue East Heyuan City (2/F of Minghuang Electrical Engineering Company Building)
Telephone: --
Fax: --

1.3 Description of EUT

Product: 16 Channel Walkie Talkie
Manufacturer: Guangdong Samzuk Technology Development Co., Ltd
Brand Name: **SAMCOM**
Model Number: FPBN10A, FPBAN20A, FPBAN30A, FPBAN40A
FPBAN50A, FPBAN60A, FPBAN70A, FPBAN80A
Power Source Adapter Model: NLA050090W1C1 Input: 100-240V~0.2A max 60/50Hz
Output: 9V, 500mA
Type of Modulation FM
Frequency range UHF:406.1MHz-470MHz
Channel Bandwidth 12.5 kHz and 6.25kHz
Frequency Selection By operation
Antenna: Whip antenna with gain 1.0dBi
Emission Designer 5K41F3E for 12.5kHz channel Bandwidth;
2K51F3E for 6.25 kHz channels Bandwidth

1.4 Submitted Sample: 3Sample

The report refers only to the sample tested and does not apply to the bulk.

This report is issued in confidence to the client and it will be strictly treated as such by the SHENZHEN TIMEWAY TESTING LABORATORIES. It may not be reproduced rather in its entirety or in part and it may not be used for advertising. The client to whom the report is issued may, however, show or send it . or a certified copy there of prepared by the SHENZHEN TIMEWAY TESTING LABORATORIES. to his customer. Supplier or others persons directly concerned. SHENZHEN TIMEWAY TESTING LABORATORIES. will not, without the consent of the client enter into any discussion of correspondence with any third party concerning the contents of the report.

In the event of the improper use of the report. The SHENZHEN TIMEWAY TESTING LABORATORIES. reserves the rights to withdraw it and to adopt any other remedies which may be appropriate.



1.5 Test Duration

2016-07-06-2016-08-08

1.6 Test Uncertainty

Conducted Emissions Uncertainty =3.6dB

Radiated Emissions Uncertainty =4.7dB

1.7 Test Engineer

Terry Tang

The sample tested by _____

Print Name: Terry Tang

The report refers only to the sample tested and does not apply to the bulk.

This report is issued in confidence to the client and it will be strictly treated as such by the SHENZHEN TIMEWAY TESTING LABORATORIES. It may not be reproduced rather in its entirety or in part and it may not be used for adverting. The client to whom the report is issued may, however, show or send it . or a certified copy there of prepared by the SHENZHEN TIMEWAY TESTING LABORATORIES. to his customer. Supplier or others persons directly concerned. SHENZHEN TIMEWAY TESTING LABORATORIES. will not, without the consent of the client enter into any discussion of correspondence with any third party concerning the contents of the report.

In the event of the improper use of the report. The SHENZHEN TIMEWAY TESTING LABORATORIES. reserves the rights to withdraw it and to adopt any other remedies which may be appropriate.



2.0 Test Equipments					
Instrument Type	Manufacturer	Model	Serial No.	Date of Cal.	Due Date
ESPI Test Receiver	R&S	ESPI 3	100379	2015-08-22	2016-08-21
TWO Line-V-NETW	R&S	EZH3-Z5	100294	2015-08-22	2016-08-21
TWO Line-V-NETW	R&S	EZH3-Z5	100253	2015-08-22	2016-08-21
Ultra Broadband ANT	R&S	HL562	100157	2015-08-23	2016-08-22
ESDV Test Receiver	R&S	ESDV	100008	2015-08-22	2016-08-21
Impuls-Begrenzer	R&S	ESH3-Z2	100281	2015-08-22	2016-08-21
System Controller	CT	SC100	-	--	--
Printer	EPSON	PHOTO EX3	CFNH234850	--	--
Computer	IBM	8434	1S8434KCE99BLXLO*	-	-
Loop Antenna	EMCO	6502	00042960	2015-08-23	2016-08-22
ESPI Test Receiver	R&S	ESI26	838786/013	2015-08-22	2016-08-21
3m OATS	--	--	N/A	2015-08-24	2016-08-23
Horn Antenna	R&S	BBHA 9170	BBHA9170265	2015-08-24	2016-08-23
Horn Antenna	R&S	BBHA 9120D	9120D-631	2015-08-24	2016-08-23
Power meter	Anritsu	ML2487A	6K00003613	2015-08-22	2016-08-21
Power sensor	Anritsu	MA2491A	32263	2015-08-22	2016-08-21
Bilog Antenna	Schwarebeck	VULB9163	9163/340	2015-08-23	2016-08-21
LISN	AFJ	LS16C	10010947251	2015-08-22	2016-08-21
LISN (Three Phase)	Schwarebeck	NSLK 8126	8126453	2015-08-23	2016-08-22
9*6*6 Anechoic	--	--	N/A	2015-08-24	2016-08-23
EMI Test Receiver	RS	ESCS30	100139	2015-08-22	2016-08-21
Modulation Analyzer	HP	8901B	3104A03367	2016-06-11	2017-06-10

The report refers only to the sample tested and does not apply to the bulk.

This report is issued in confidence to the client and it will be strictly treated as such by the SHENZHEN TIMEWAY TESTING LABORATORIES. It may not be reproduced rather in its entirety or in part and it may not be used for advertising. The client to whom the report is issued may, however, show or send it . or a certified copy there of prepared by the SHENZHEN TIMEWAY TESTING LABORATORIES. to his customer. Supplier or others persons directly concerned. SHENZHEN TIMEWAY TESTING LABORATORIES. will not, without the consent of the client enter into any discussion of correspondence with any third party concerning the contents of the report.

In the event of the improper use of the report. The SHENZHEN TIMEWAY TESTING LABORATORIES. reserves the rights to withdraw it and to adopt any other remedies which may be appropriate.



3.0 Technical Details

3.1 Summary of test results

The EUT has been tested according to the following specifications:			
	Standard	Test Type	Result
	FCC Part 15.207	Conducted Emission	Compliant
	FCC Part 90.205	Maximum Transmitter Power	Compliant
	FCC Part 90.207	Modulation Characteristic	Compliant
	FCC Part 90.209	Occupied Bandwidth	Compliant
	FCC Part 90.210	Emission Mask	Compliant
	FCC Part 90.213	Frequency Tolerance	Compliant
	FCC Part 90.214	Transient Frequency Behaviour	Compliant
	FCC Part 90.221	Adjacent channel power	Compliant

3.2 The tests were performed according to following standards:

FCC Part 90
TIA-603-D-2010
ANSI C63.10-2013

4.0 EUT Modification

No modification by SHENZHEN TIMEWAY TESTING LABORATORIES.

The report refers only to the sample tested and does not apply to the bulk.

This report is issued in confidence to the client and it will be strictly treated as such by the SHENZHEN TIMEWAY TESTING LABORATORIES. It may not be reproduced rather in its entirety or in part and it may not be used for advertising. The client to whom the report is issued may, however, show or send it . or a certified copy there of prepared by the SHENZHEN TIMEWAY TESTING LABORATORIES. to his customer. Supplier or others persons directly concerned. SHENZHEN TIMEWAY TESTING LABORATORIES. will not, without the consent of the client enter into any discussion of correspondence with any third party concerning the contents of the report.

In the event of the improper use of the report. The SHENZHEN TIMEWAY TESTING LABORATORIES. reserves the rights to withdraw it and to adopt any other remedies which may be appropriate.



5. Power Line Conducted Emission Test

5.1 Schematics of the test

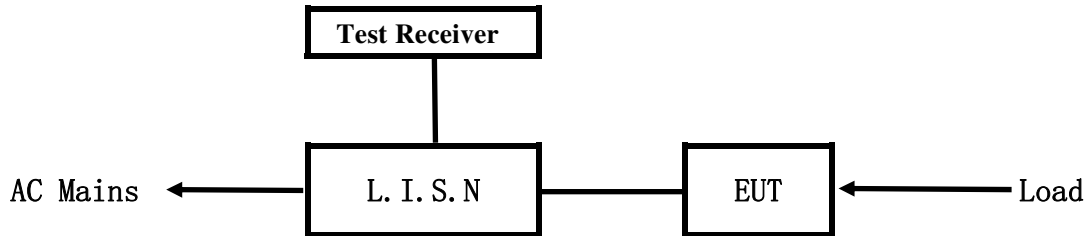

EUT: Equipment Under Test

5.2 Test Method and test Procedure

The EUT was tested according to ANSI C63.4-2014. The Frequency spectrum From 0.15MHz to 30MHz was investigated. The LISN used was 50ohm/50uH as specified by section 5.1 of ANSI C63.4-2014.

Test Voltage: 120V~, 60Hz

Block diagram of Test setup

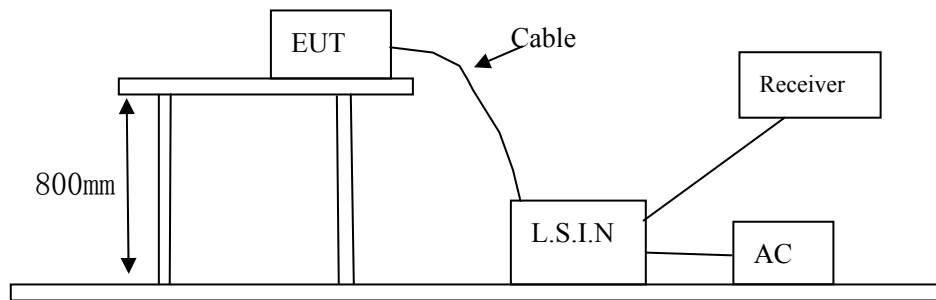

5.3 Configuration of The EUT

The EUT was configured according to ANSI C63.4-2014. All interface ports were connected to the appropriate peripherals. All peripherals and cables are listed below.

A. EUT

Device	Manufacturer	Model	FCC ID
16 Channel Walkie Talkie	Guangdong Samzuk Technology Development Co., Ltd	FPBN10A, FPBAN20A FPBAN30A FPBAN40A FPBAN50A FPBAN60A FPBAN70A FPBAN80A	2AIOQ-FPBN10A

The report refers only to the sample tested and does not apply to the bulk.

This report is issued in confidence to the client and it will be strictly treated as such by the SHENZHEN TIMEWAY TESTING LABORATORIES. It may not be reproduced rather in its entirety or in part and it may not be used for adverting. The client to whom the report is issued may, however, show or send it . or a certified copy there of prepared by the SHENZHEN TIMEWAY TESTING LABORATORIES. to his customer. Supplier or others persons directly concerned. SHENZHEN TIMEWAY TESTING LABORATORIES. will not, without the consent of the client enter into any discussion of correspondence with any third party concerning the contents of the report.

In the event of the improper use of the report. The SHENZHEN TIMEWAY TESTING LABORATORIES. reserves the rights to withdraw it and to adopt any other remedies which may be appropriate.



B. Internal Device

Device	Manufacturer	Model	FCC ID/DOC
N/A			

C. Peripherals

Device	Manufacturer	Model	FCC ID/DOC	Cable
N/A				

5.4 EUT Operating Condition

Operating condition is according to ANSI C63.4-2014

A Setup the EUT and simulators as shown on follow

B Enable AF signal and confirm EUT active to normal condition

5.5 Power line conducted Emission Limit according to Paragraph 15.107

Frequency(MHz)	Class A Limits (dB μ V)		Class B Limits (dB μ V)	
	Quasi-peak Level	Average Level	Quasi-peak Level	Average Level
0.15 ~ 0.50	79.0	66.0	66.0~56.0*	56.0~46.0*
0.50 ~ 5.00	73.0	60.0	56.0	46.0
5.00 ~ 30.00	73.0	60.0	60.0	50.0

- Notes: 1. *Decreasing linearly with logarithm of frequency.
 2. The tighter limit shall apply at the transition frequencies

5.6 Test Results

The frequency spectrum from 0.15MHz to 30MHz was investigated. All reading are quasi-peak values with a resolution bandwidth of 9kHz.

Remark: 1. scanning with PK detector and final measurement with QP and AV detector.

2. * means the worse case



A Conducted Emission on Line Terminal of the power line (150kHz to 30MHz)

EUT set Condition: Charging Mode

Results: Pass

Please refer to following diagram for individual

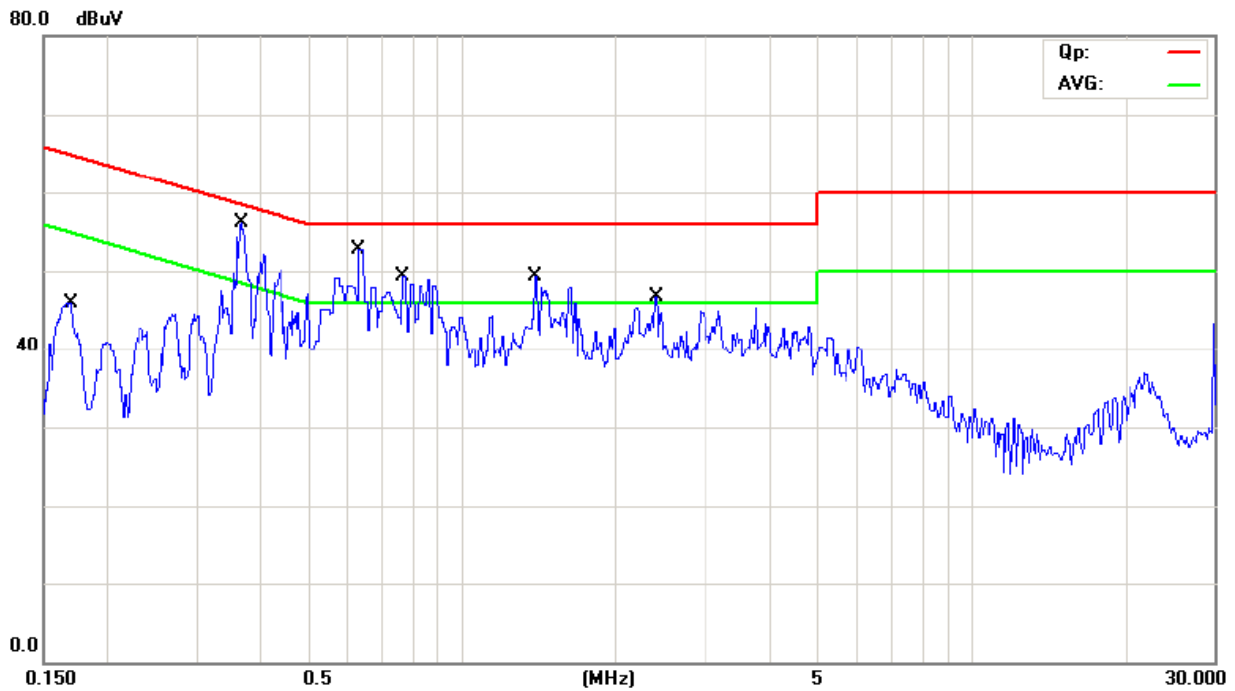

No.	Mk.	Freq. MHz	Reading Level dBuV	Correct Factor dB	Measure- ment dBuV	Limit dBuV	Over dB	Detector	Comment
1		0.1693	29.90	11.02	40.92	64.99	-24.07	QP	
2		0.1693	22.70	11.02	33.72	54.99	-21.27	AVG	
3		0.3647	39.30	11.23	50.53	58.62	-8.09	QP	
4	*	0.3647	29.60	11.23	40.83	48.62	-7.79	AVG	
5		0.6320	35.10	11.51	46.61	56.00	-9.39	QP	
6		0.6320	23.80	11.51	35.31	46.00	-10.69	AVG	
7		0.7677	31.50	11.65	43.15	56.00	-12.85	QP	
8		0.7677	19.00	11.65	30.65	46.00	-15.35	AVG	
9		1.3870	30.10	12.05	42.15	56.00	-13.85	QP	
10		1.3870	16.00	12.05	28.05	46.00	-17.95	AVG	
11		2.3817	26.20	12.45	38.65	56.00	-17.35	QP	
12		2.3817	13.80	12.45	26.25	46.00	-19.75	AVG	

The report refers only to the sample tested and does not apply to the bulk.

This report is issued in confidence to the client and it will be strictly treated as such by the SHENZHEN TIMEWAY TESTING LABORATORIES. It may not be reproduced rather in its entirety or in part and it may not be used for advertising. The client to whom the report is issued may, however, show or send it, or a certified copy thereof prepared by the SHENZHEN TIMEWAY TESTING LABORATORIES, to his customer. Supplier or others persons directly concerned. SHENZHEN TIMEWAY TESTING LABORATORIES, will not, without the consent of the client enter into any discussion of correspondence with any third party concerning the contents of the report.

In the event of the improper use of the report. The SHENZHEN TIMEWAY TESTING LABORATORIES, reserves the rights to withdraw it and to adopt any other remedies which may be appropriate.



B Conducted Emission on Neutral Terminal of the power line (150kHz to 30MHz)

EUT set Condition: Charging Mode

Results: Pass

Please refer to following diagram for individual

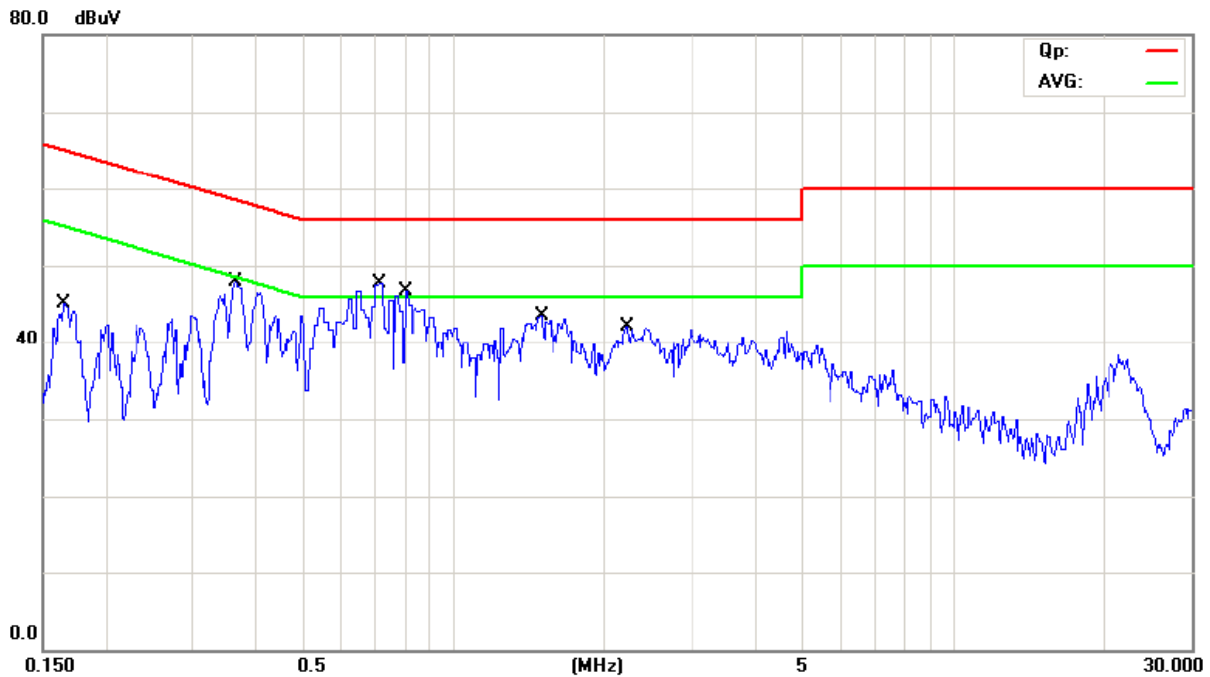

No.	Mk.	Freq. MHz	Reading Level dBuV	Correct Factor dB	Measure- ment dBuV	Limit dBuV	Over dB	Detector	Comment
1		0.1651	30.30	11.02	41.32	65.20	-23.88	QP	
2		0.1651	19.00	11.02	30.02	55.20	-25.18	AVG	
3	*	0.3615	34.60	11.22	45.82	58.69	-12.87	QP	
4		0.3615	17.80	11.22	29.02	48.69	-19.67	AVG	
5		0.7108	27.50	11.59	39.09	56.00	-16.91	QP	
6		0.7108	7.80	11.59	19.39	46.00	-26.61	AVG	
7		0.7987	30.60	11.69	42.29	56.00	-13.71	QP	
8		0.7987	16.60	11.69	28.29	46.00	-17.71	AVG	
9		1.4847	25.70	12.09	37.79	56.00	-18.21	QP	
10		1.4847	12.90	12.09	24.99	46.00	-21.01	AVG	
11		2.2100	25.50	12.38	37.88	56.00	-18.12	QP	
12		2.2100	13.20	12.38	25.58	46.00	-20.42	AVG	

The report refers only to the sample tested and does not apply to the bulk.
 This report is issued in confidence to the client and it will be strictly treated as such by the SHENZHEN TIMEWAY TESTING LABORATORIES. It may not be reproduced rather in its entirety or in part and it may not be used for advertising. The client to whom the report is issued may, however, show or send it, or a certified copy thereof prepared by the SHENZHEN TIMEWAY TESTING LABORATORIES, to his customer. Supplier or others persons directly concerned. SHENZHEN TIMEWAY TESTING LABORATORIES, will not, without the consent of the client enter into any discussion of correspondence with any third party concerning the contents of the report.
 In the event of the improper use of the report. The SHENZHEN TIMEWAY TESTING LABORATORIES, reserves the rights to withdraw it and to adopt any other remedies which may be appropriate.



6. Frequency Tolerance

6.1 Applicable standard

According to FCC Part 90 Section 90.213,

In the 150-174 MHz band, mobile stations designed to operate with a 12.5 kHz channel bandwidth or designed to operate on a frequency specifically designated for itinerant use or designed for low-power operation of two watts or less, must have a frequency stability of 5.0 ppm. Mobile stations designed to operate with a 6.25 kHz channel bandwidth must have a frequency stability of 2.0 ppm.

In the 421-512 MHz band, mobile stations designed to operate with a 12.5 kHz channel bandwidth must have a frequency stability of 2.5 ppm. Mobile stations designed to operate with a 6.25 kHz channel bandwidth must have a frequency stability of 1.0 ppm.

6.2 Measurement Procedure

6.2.1 Frequency stability versus environmental temperature

1. Setup the configuration per figure 1 for frequencies measurement inside an environment chamber, Install new battery in the EUT.
2. Turn on EUT and set SA center frequency to the EUT radiated frequency. Set SA Resolution Bandwidth to 1kHz and Video Resolution Bandwidth to 1kHz and Frequency Span to 50kHz. Record this frequency as reference frequency.
3. Set the temperature of chamber to 50°C. Allow sufficient time (approximately 30 min) for the temperature of the chamber to stabilize. While maintaining a constant temperature inside the chamber, turn the EUT on and measure the EUT operating frequency.
4. Repeat step 2 with a 10°C decreased per stage until the lowest temperature -30°C is measured, record all measured frequencies on each temperature step.

6.2.2 Frequency stability versus input voltage

1. Setup the configuration per figure 1 for frequencies measured at temperature if it is within 15°C to 25°C. Otherwise, an environment chamber set for a temperature of 20°C shall be used. The EUT shall be powered by DC 7.4-8.4 V
2. Set SA center frequency to the EUT radiated frequency. Set SA Resolution Bandwidth to 1 KHz and Video Resolution Bandwidth to 1KHz. Record this frequency as reference frequency.
3. Supply the EUT primary voltage at the operating end point which is specified by manufacturer and record the frequency.

The report refers only to the sample tested and does not apply to the bulk.

This report is issued in confidence to the client and it will be strictly treated as such by the SHENZHEN TIMEWAY TESTING LABORATORIES. It may not be reproduced rather in its entirety or in part and it may not be used for advertising. The client to whom the report is issued may, however, show or send it, or a certified copy thereof prepared by the SHENZHEN TIMEWAY TESTING LABORATORIES, to his customer. Supplier or others persons directly concerned. SHENZHEN TIMEWAY TESTING LABORATORIES, will not, without the consent of the client enter into any discussion of correspondence with any third party concerning the contents of the report.

In the event of the improper use of the report. The SHENZHEN TIMEWAY TESTING LABORATORIES, reserves the rights to withdraw it and to adopt any other remedies which may be appropriate.



6.3 TEST SETUP BLOCK DIAGRAM

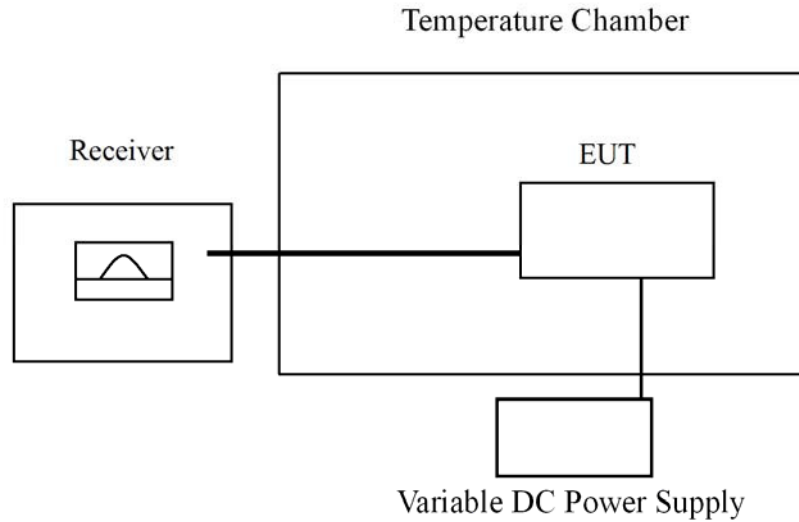

Figure 1

6.5 TEST RESULT

(1) Frequency stability versus input voltage (battery operation end point voltage is 6.3V)

UHF Band: (12.5 kHz Channel Bandwidth)

Channel	Power Supplied (Vdc)	Frequency Measured (MHz)	Frequency Deviation (ppm)	Nominal Frequency	Limit(ppm)
Top channel	6.3V	469.97546	0.98	469.975MHz	2.5
Middle channel	6.3V	439.97535	0.80	439.975MHz	2.5
Bottom channel	6.3V	406.12552	1.11	406.125MHz	2.5

The report refers only to the sample tested and does not apply to the bulk.

This report is issued in confidence to the client and it will be strictly treated as such by the SHENZHEN TIMEWAY TESTING LABORATORIES. It may not be reproduced rather in its entirety or in part and it may not be used for advertising. The client to whom the report is issued may, however, show or send it . or a certified copy there of prepared by the SHENZHEN TIMEWAY TESTING LABORATORIES. to his customer. Supplier or others persons directly concerned. SHENZHEN TIMEWAY TESTING LABORATORIES. will not, without the consent of the client enter into any discussion of correspondence with any third party concerning the contents of the report.

In the event of the improper use of the report. The SHENZHEN TIMEWAY TESTING LABORATORIES. reserves the rights to withdraw it and to adopt any other remedies which may be appropriate.



(2)Frequency stability versus ambient temperature

Test Results

UHF Band: (12.5 kHz Channel Bandwidth)

Top channel

Environment Temperature(°C)	Power Supplied (Vdc)	Frequency Measured (MHz)	Frequency Deviation (ppm)	Nominal Frequency	Limit(ppm)
50	7.4	469.97565	1.35	469.975MHz	2.5
40	7.4	469.97531	0.66	469.975MHz	2.5
30	7.4	469.97549	1.04	469.975MHz	2.5
20	7.4	469.97533	0.70	469.975MHz	2.5
10	7.4	469.97557	1.21	469.975MHz	2.5
0	7.4	469.97552	1.11	469.975MHz	2.5
-10	7.4	469.97560	1.28	469.975MHz	2.5
-20	7.4	469.97532	0.68	469.975MHz	2.5
-30	7.4	469.97535	0.74	469.975MHz	2.5

Middle channel

Environment Temperature(°C)	Power Supplied (Vdc)	Frequency Measured (MHz)	Frequency Error (ppm)	Nominal Frequency	Limit(ppm)
50	7.4	439.97555	1.25	439.975MHz	2.5
40	7.4	439.97534	0.77	439.975MHz	2.5
30	7.4	439.97535	0.80	439.975MHz	2.5
20	7.4	439.97557	1.30	439.975MHz	2.5
10	7.4	439.97566	1.50	439.975MHz	2.5
0	7.4	439.97529	0.66	439.975MHz	2.5
-10	7.4	439.97531	0.70	439.975MHz	2.5
-20	7.4	439.97533	0.75	439.975MHz	2.5
-30	7.4	439.97543	0.98	439.975MHz	2.5

The report refers only to the sample tested and does not apply to the bulk.

This report is issued in confidence to the client and it will be strictly treated as such by the SHENZHEN TIMEWAY TESTING LABORATORIES. It may not be reproduced rather in its entirety or in part and it may not be used for advertising. The client to whom the report is issued may, however, show or send it . or a certified copy there of prepared by the SHENZHEN TIMEWAY TESTING LABORATORIES. to his customer. Supplier or others persons directly concerned. SHENZHEN TIMEWAY TESTING LABORATORIES. will not, without the consent of the client enter into any discussion of correspondence with any third party concerning the contents of the report.

In the event of the improper use of the report. The SHENZHEN TIMEWAY TESTING LABORATORIES. reserves the rights to withdraw it and to adopt any other remedies which may be appropriate.



Bottom channel

Environment Temperature(°C)	Power Supplied (Vdc)	Frequency Measured (MHz)	Frequency Error (ppm)	Nominal Frequency	Limit(ppm)
50	7.4	406.12539	0.96	406.125MHz	2.5
40	7.4	406.12532	0.79	406.125MHz	2.5
30	7.4	406.12544	1.08	406.125MHz	2.5
20	7.4	406.12551	1.26	406.125MHz	2.5
10	7.4	406.12537	0.91	406.125MHz	2.5
0	7.4	406.12546	1.13	406.125MHz	2.5
-10	7.4	406.12540	0.98	406.125MHz	2.5
-20	7.4	406.12553	1.31	406.125MHz	2.5
-30	7.4	406.12538	0.94	406.125MHz	2.5

(1) Frequency stability versus input voltage (battery operation end point voltage is 6.3V)

UHF Band: (6.25 kHz Channel Bandwidth)

Channel	Power Supplied (Vdc)	Frequency Measured (MHz)	Frequency Deviation (ppm)	Nominal Frequency	Limit(ppm)
Top channel	6.3V	469.97531	0.66	469.975MHz	1.0
Middle channel	6.3V	439.97527	0.61	439.975MHz	1.0
Bottom channel	6.3V	406.12528	0.69	406.125MHz	1.0

The report refers only to the sample tested and does not apply to the bulk.

This report is issued in confidence to the client and it will be strictly treated as such by the SHENZHEN TIMEWAY TESTING LABORATORIES. It may not be reproduced rather in its entirety or in part and it may not be used for advertising. The client to whom the report is issued may, however, show or send it or a certified copy thereof prepared by the SHENZHEN TIMEWAY TESTING LABORATORIES to his customer. Supplier or others persons directly concerned. SHENZHEN TIMEWAY TESTING LABORATORIES will not, without the consent of the client enter into any discussion of correspondence with any third party concerning the contents of the report.

In the event of the improper use of the report. The SHENZHEN TIMEWAY TESTING LABORATORIES reserves the rights to withdraw it and to adopt any other remedies which may be appropriate.



(2)Frequency stability versus ambient temperature

Test Results

UHF Band: (6.25 kHz Channel Bandwidth)

Top channel

Environment Temperature(°C)	Power Supplied (Vdc)	Frequency Measured (MHz)	Frequency Deviation (ppm)	Nominal Frequency	Limit(ppm)
50	7.4	469.97525	0.53	469.975MHz	1.0
40	7.4	469.97534	0.72	469.975MHz	1.0
30	7.4	469.97527	0.57	469.975MHz	1.0
20	7.4	469.97529	0.62	469.975MHz	1.0
10	7.4	469.97523	0.49	469.975MHz	1.0
0	7.4	469.97534	0.72	469.975MHz	1.0
-10	7.4	469.97531	0.66	469.975MHz	1.0
-20	7.4	469.97535	0.74	469.975MHz	1.0
-30	7.4	469.97528	0.60	469.975MHz	1.0

Middle channel

Environment Temperature(°C)	Power Supplied (Vdc)	Frequency Measured (MHz)	Frequency Error (ppm)	Nominal Frequency	Limit(ppm)
50	7.4	439.97526	0.59	439.975MHz	1.0
40	7.4	439.97529	0.66	439.975MHz	1.0
30	7.4	439.97525	0.57	439.975MHz	1.0
20	7.4	439.97533	0.75	439.975MHz	1.0
10	7.4	439.97534	0.77	439.975MHz	1.0
0	7.4	439.97526	0.59	439.975MHz	1.0
-10	7.4	439.97527	0.61	439.975MHz	1.0
-20	7.4	439.97525	0.57	439.975MHz	1.0
-30	7.4	439.97530	0.68	439.975MHz	1.0

The report refers only to the sample tested and does not apply to the bulk.

This report is issued in confidence to the client and it will be strictly treated as such by the SHENZHEN TIMEWAY TESTING LABORATORIES. It may not be reproduced rather in its entirety or in part and it may not be used for advertising. The client to whom the report is issued may, however, show or send it . or a certified copy there of prepared by the SHENZHEN TIMEWAY TESTING LABORATORIES. to his customer. Supplier or others persons directly concerned. SHENZHEN TIMEWAY TESTING LABORATORIES. will not, without the consent of the client enter into any discussion of correspondence with any third party concerning the contents of the report.

In the event of the improper use of the report. The SHENZHEN TIMEWAY TESTING LABORATORIES. reserves the rights to withdraw it and to adopt any other remedies which may be appropriate.



Bottom channel

Environment Temperature(°C)	Power Supplied (Vdc)	Frequency Measured (MHz)	Frequency Error (ppm)	Nominal Frequency	Limit(ppm)
50	7.4	406.12523	0.57	406.125MHz	1.0
40	7.4	406.12526	0.64	406.125MHz	1.0
30	7.4	406.12528	0.69	406.125MHz	1.0
20	7.4	406.12525	0.62	406.125MHz	1.0
10	7.4	406.12519	0.47	406.125MHz	1.0
0	7.4	406.12524	0.59	406.125MHz	1.0
-10	7.4	406.12528	0.69	406.125MHz	1.0
-20	7.4	406.12529	0.71	406.125MHz	1.0
-30	7.4	406.12522	0.54	406.125MHz	1.0

The report refers only to the sample tested and does not apply to the bulk.

This report is issued in confidence to the client and it will be strictly treated as such by the SHENZHEN TIMEWAY TESTING LABORATORIES. It may not be reproduced rather in its entirety or in part and it may not be used for advertising. The client to whom the report is issued may, however, show or send it or a certified copy thereof prepared by the SHENZHEN TIMEWAY TESTING LABORATORIES to his customer. Supplier or others persons directly concerned. SHENZHEN TIMEWAY TESTING LABORATORIES will not, without the consent of the client enter into any discussion of correspondence with any third party concerning the contents of the report.

In the event of the improper use of the report. The SHENZHEN TIMEWAY TESTING LABORATORIES reserves the rights to withdraw it and to adopt any other remedies which may be appropriate.



7. EMISSION BANDWIDTH and Mask

7.1 PROVISIONS APPLICABLE

Emission Mask D—12.5 kHz channel bandwidth equipment. For transmitters designed to operate with a 12.5 kHz channel bandwidth, any emission must be attenuated below the power (P) of the highest emission contained within the authorized bandwidth as follows:

- (1) On any frequency from the center of the authorized bandwidth f_0 to 5.625 kHz removed from f_0 : Zero dB.
- (2) On any frequency removed from the center of the authorized bandwidth by a displacement frequency (f_d in kHz) of more than 5.625 kHz but no more than 12.5 kHz: At least $7.27(f_d - 2.88 \text{ kHz})$ dB.
- (3) On any frequency removed from the center of the authorized bandwidth by a displacement frequency (f_d in kHz) of more than 12.5 kHz: At least $50 + 10 \log(P)$ dB or 70 dB, whichever is the lesser attenuation.
- (4) The reference level for showing compliance with the emission mask shall be established using a resolution bandwidth sufficiently wide (usually two to three times the channel bandwidth) to capture the true peak emission of the equipment under test. In order to show compliance with the emissions mask up to and including 50 kHz removed from the edge of the authorized bandwidth, adjust the resolution bandwidth to 100 Hz with the measuring instrument in a peak hold mode. A sufficient number of sweeps must be measured to insure that the emission profile is developed. If video filtering is used, its bandwidth must not be less than the instrument resolution bandwidth. For emissions beyond 50 kHz from the edge of the authorized bandwidth, see paragraph (m) of this section. If it can be shown that use of the above instrumentation settings do not accurately represent the true interference potential of the equipment under test, then an alternate procedure may be used provided prior Commission approval is obtained.

Emission Mask-E:

6.25 kHz or less channel bandwidth equipment. For transmitters designed to operate with a 6.25 kHz or less bandwidth, any emission must be attenuated below the power (P) of the highest emission contained within the authorized bandwidth as follows:

- (1) On any frequency from the center of the authorized bandwidth f_0 to 3.0 kHz removed from f_0 : Zero dB.
- (2) On any frequency removed from the center of the authorized bandwidth by a displacement frequency (f_d in kHz) of more than 3.0 kHz but no more than 4.6 kHz: At least $30 + 16.67(f_d - 3 \text{ kHz})$ or $55 + 10 \log(P)$ or 65 dB, whichever is the lesser attenuation.
- (3) On any frequency removed from the center of the authorized bandwidth by more than 4.6 kHz: At least $55 + 10 \log(P)$ or 65 dB, whichever is the lesser attenuation.
- (4) The reference level for showing compliance with the emission mask shall be established using a resolution bandwidth sufficiently wide (usually two or three times the channel bandwidth) to capture the true peak emission of the equipment under test. In order to show compliance with the emission mask up to and including 50 kHz removed from the edge of the authorized bandwidth, adjust the resolution bandwidth to 100 Hz with the measuring instrument in a peak hold mode. A sufficient number of sweeps must be measured to insure that the emission profile is developed. If video filtering is used, its bandwidth must not be less than the instrument

The report refers only to the sample tested and does not apply to the bulk.

This report is issued in confidence to the client and it will be strictly treated as such by the SHENZHEN TIMEWAY TESTING LABORATORIES. It may not be reproduced rather in its entirety or in part and it may not be used for advertising. The client to whom the report is issued may, however, show or send it, or a certified copy thereof prepared by the SHENZHEN TIMEWAY TESTING LABORATORIES, to his customer. Supplier or others persons directly concerned. SHENZHEN TIMEWAY TESTING LABORATORIES, will not, without the consent of the client enter into any discussion of correspondence with any third party concerning the contents of the report.

In the event of the improper use of the report. The SHENZHEN TIMEWAY TESTING LABORATORIES, reserves the rights to withdraw it and to adopt any other remedies which may be appropriate.



resolution bandwidth. For emissions beyond 50 kHz from the edge of the authorized bandwidth, see paragraph (o) of this section. If it can be shown that use of the above instrumentation settings do not accurately represent the true interference potential of the equipment under test, an alternate procedure may be used provided prior Commission approval is obtained.

7.2 MEASUREMENT PROCEDURE

- 1). The EUT was modulated by 2.5 kHz Sine wave audio signal, The level of the audio signal employed is 16 dB greater than that necessary to produce 50% of rated system deviation. Rated system deviation is 2.5 kHz
- 2). Set SPA Center Frequency = fundamental frequency, RBW=100Hz, VBW= 300 Hz, Span =50 kHz
- 3). Set SPA Max hold. Mark peak, -26 dB.

7.3 Test Setup Block Diagram

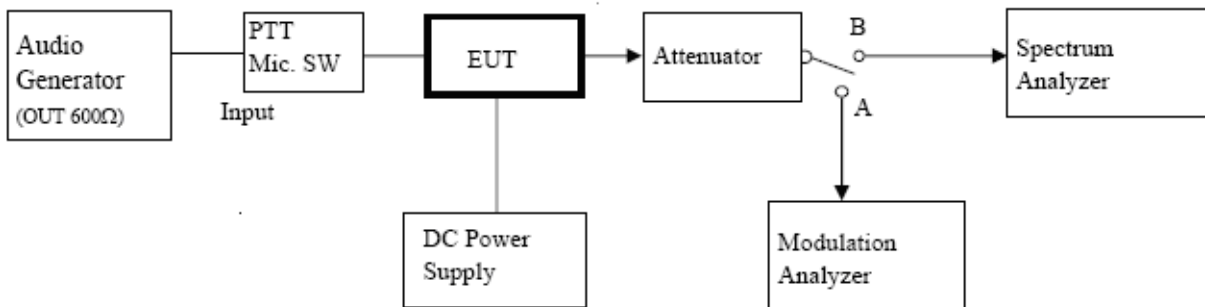

7.4 Measurement Result:

For 12.5 kHz Channel Bandwidth

Bandwidth				
Operating Frequency	26dB Bandwidth	99% Bandwidth	Limits	Result
439.975MHz (Middle)	5.81kHz	5.41kHz	11.25 kHz	Pass

The report refers only to the sample tested and does not apply to the bulk.
 This report is issued in confidence to the client and it will be strictly treated as such by the SHENZHEN TIMEWAY TESTING LABORATORIES. It may not be reproduced rather in its entirety or in part and it may not be used for adverting. The client to whom the report is issued may, however, show or send it . or a certified copy there of prepared by the SHENZHEN TIMEWAY TESTING LABORATORIES. to his customer. Supplier or others persons directly concerned. SHENZHEN TIMEWAY TESTING LABORATORIES. will not, without the consent of the client enter into any discussion of correspondence with any third party concerning the contents of the report.
 In the event of the improper use of the report. The SHENZHEN TIMEWAY TESTING LABORATORIES. reserves the rights to withdraw it and to adopt any other remedies which may be appropriate.



7.5 Test Plots:

UHF Band-Middle Channel

26dB Bandwidth

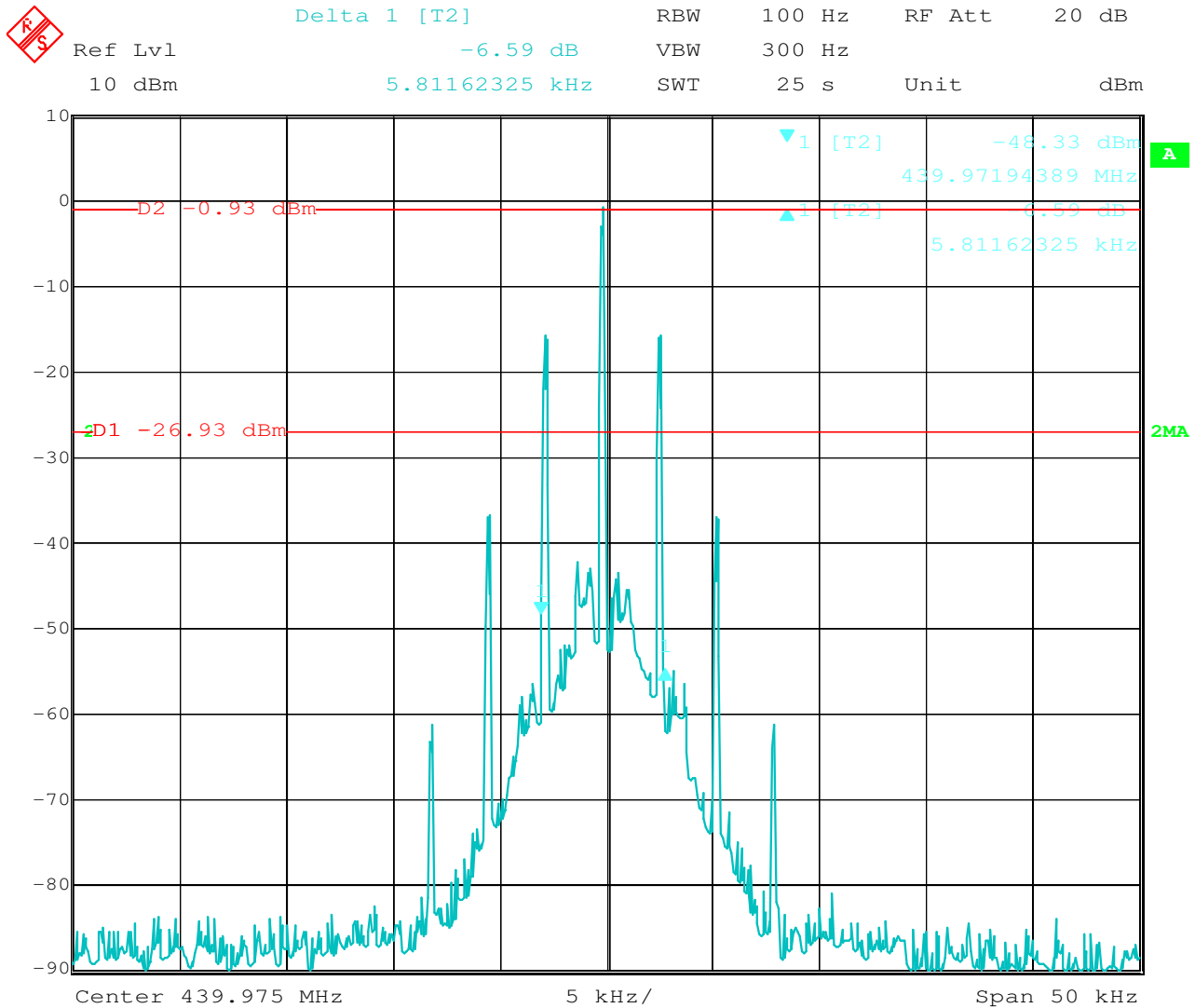

The report refers only to the sample tested and does not apply to the bulk.

This report is issued in confidence to the client and it will be strictly treated as such by the SHENZHEN TIMEWAY TESTING LABORATORIES. It may not be reproduced rather in its entirety or in part and it may not be used for advertising. The client to whom the report is issued may, however, show or send it, or a certified copy thereof prepared by the SHENZHEN TIMEWAY TESTING LABORATORIES, to his customer. Supplier or others persons directly concerned. SHENZHEN TIMEWAY TESTING LABORATORIES, will not, without the consent of the client enter into any discussion of correspondence with any third party concerning the contents of the report.

In the event of the improper use of the report. The SHENZHEN TIMEWAY TESTING LABORATORIES, reserves the rights to withdraw it and to adopt any other remedies which may be appropriate.



UHF Band-Middle Channel

99% Bandwidth



Ref Lvl	Marker 1 [T2]	RBW	100 Hz	RF Att	20 dB
10 dBm	-0.93 dBm	VBW	300 Hz		
	439.97484970 MHz	SWT	25 s	Unit	dBm

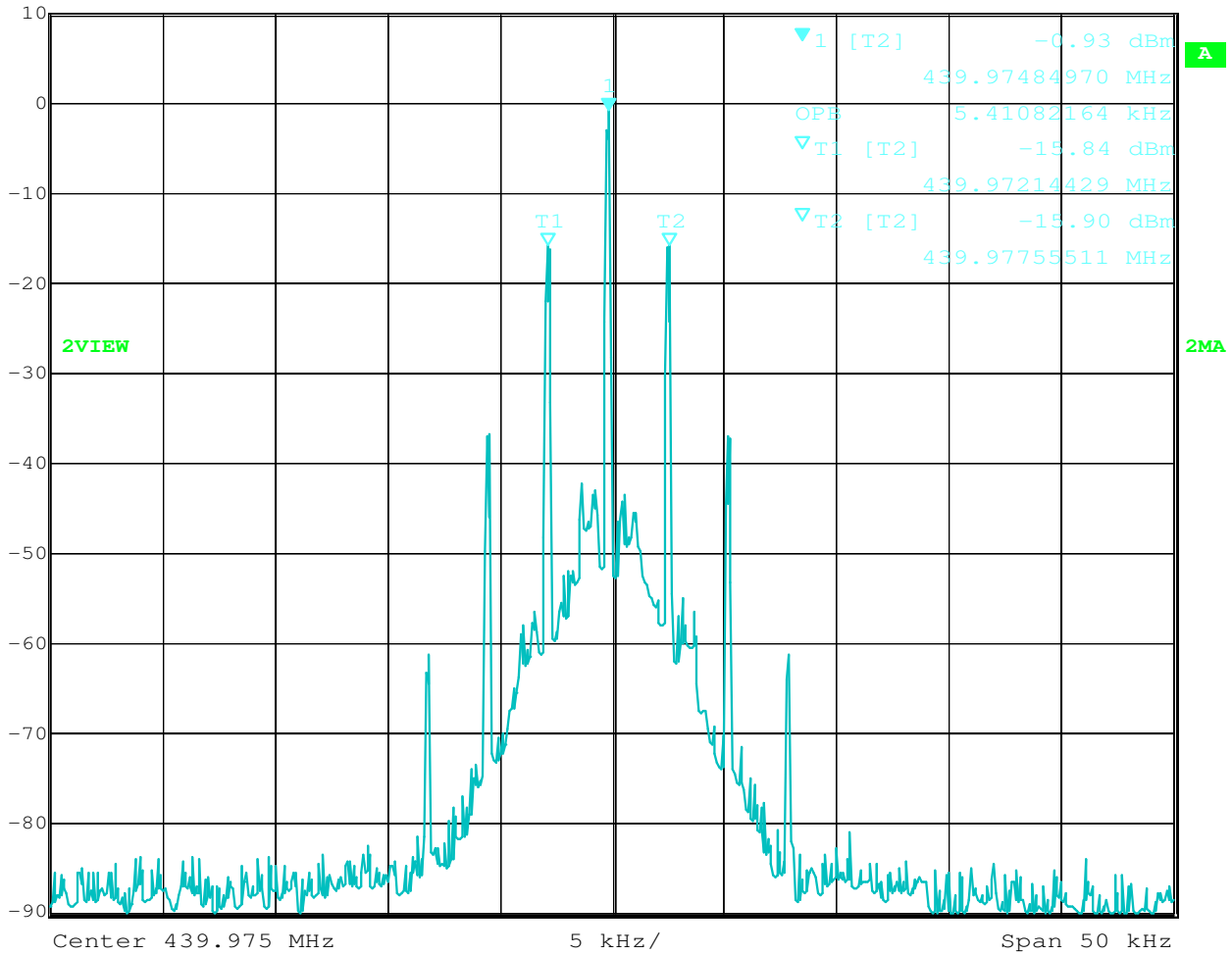

The report refers only to the sample tested and does not apply to the bulk.
 This report is issued in confidence to the client and it will be strictly treated as such by the SHENZHEN TIMEWAY TESTING LABORATORIES. It may not be reproduced in its entirety or in part and it may not be used for advertising. The client to whom the report is issued may, however, show or send it, or a certified copy thereof prepared by the SHENZHEN TIMEWAY TESTING LABORATORIES, to his customer. Supplier or others persons directly concerned. SHENZHEN TIMEWAY TESTING LABORATORIES, will not, without the consent of the client enter into any discussion of correspondence with any third party concerning the contents of the report.
 In the event of the improper use of the report. The SHENZHEN TIMEWAY TESTING LABORATORIES, reserves the rights to withdraw it and to adopt any other remedies which may be appropriate.



UHF Band-Middle Channel

Emission Mask D



Ref Lvl	Marker 1 [T1]	RBW	100 Hz	RF Att	20 dB
10 dBm	-0.81 dBm	VBW	300 Hz		
	439.97484970 MHz	SWT	25 s	Unit	dBm

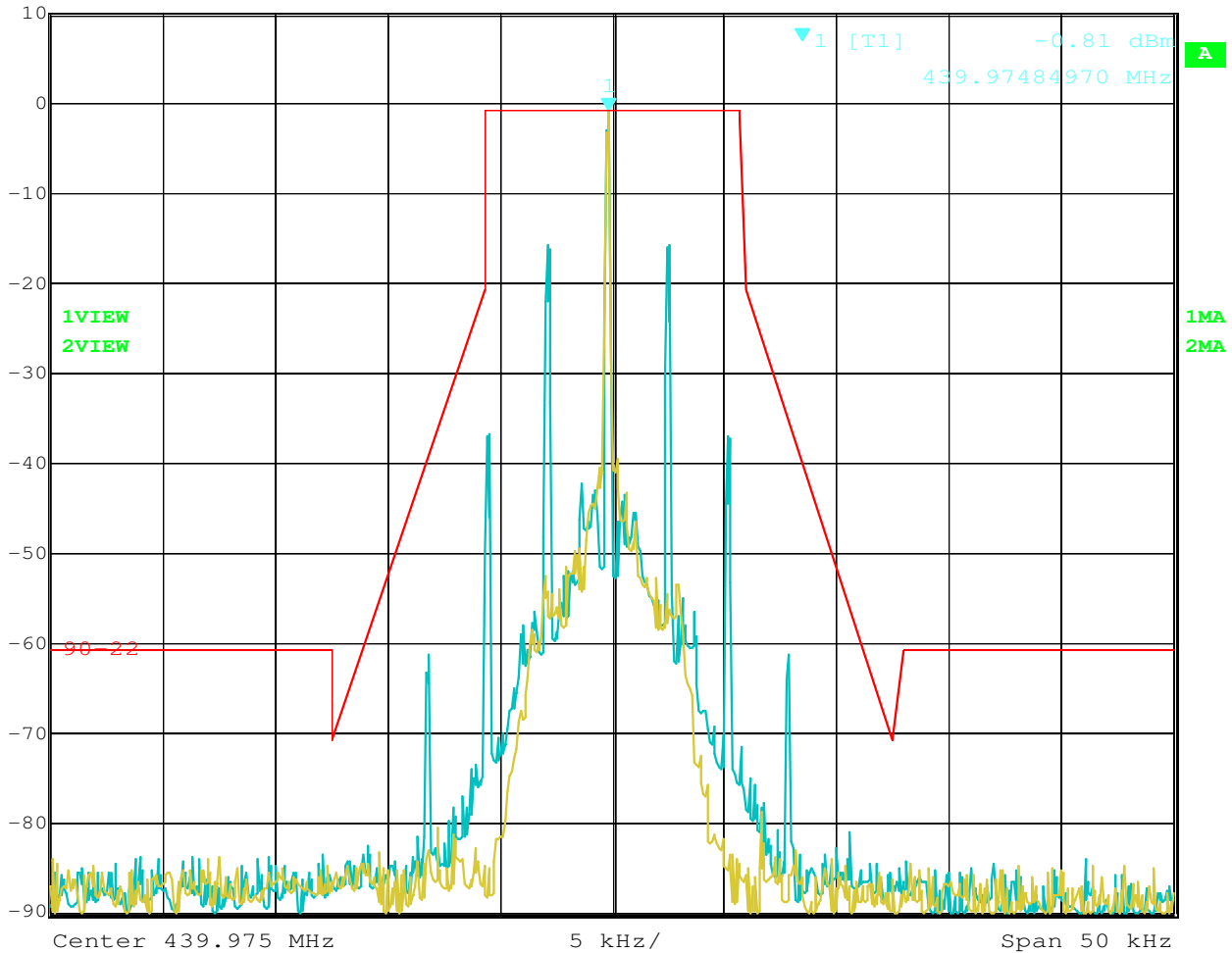

The report refers only to the sample tested and does not apply to the bulk.
 This report is issued in confidence to the client and it will be strictly treated as such by the SHENZHEN TIMEWAY TESTING LABORATORIES. It may not be reproduced rather in its entirety or in part and it may not be used for adverting. The client to whom the report is issued may, however, show or send it . or a certified copy there of prepared by the SHENZHEN TIMEWAY TESTING LABORATORIES. to his customer. Supplier or others persons directly concerned. SHENZHEN TIMEWAY TESTING LABORATORIES. will not, without the consent of the client enter into any discussion of correspondence with any third party concerning the contents of the report.
 In the event of the improper use of the report. The SHENZHEN TIMEWAY TESTING LABORATORIES. reserves the rights to withdraw it and to adopt any other remedies which may be appropriate.



For 6.25 kHz Channel Bandwidth

Bandwidth				
Operating Frequency	26dB Bandwidth	99% Bandwidth	Limits	Result
439.975MHz (Middle)	2.91kHz	2.51kHz	6 kHz	Pass

UHF Band-Middle Channel

26dB Bandwidth

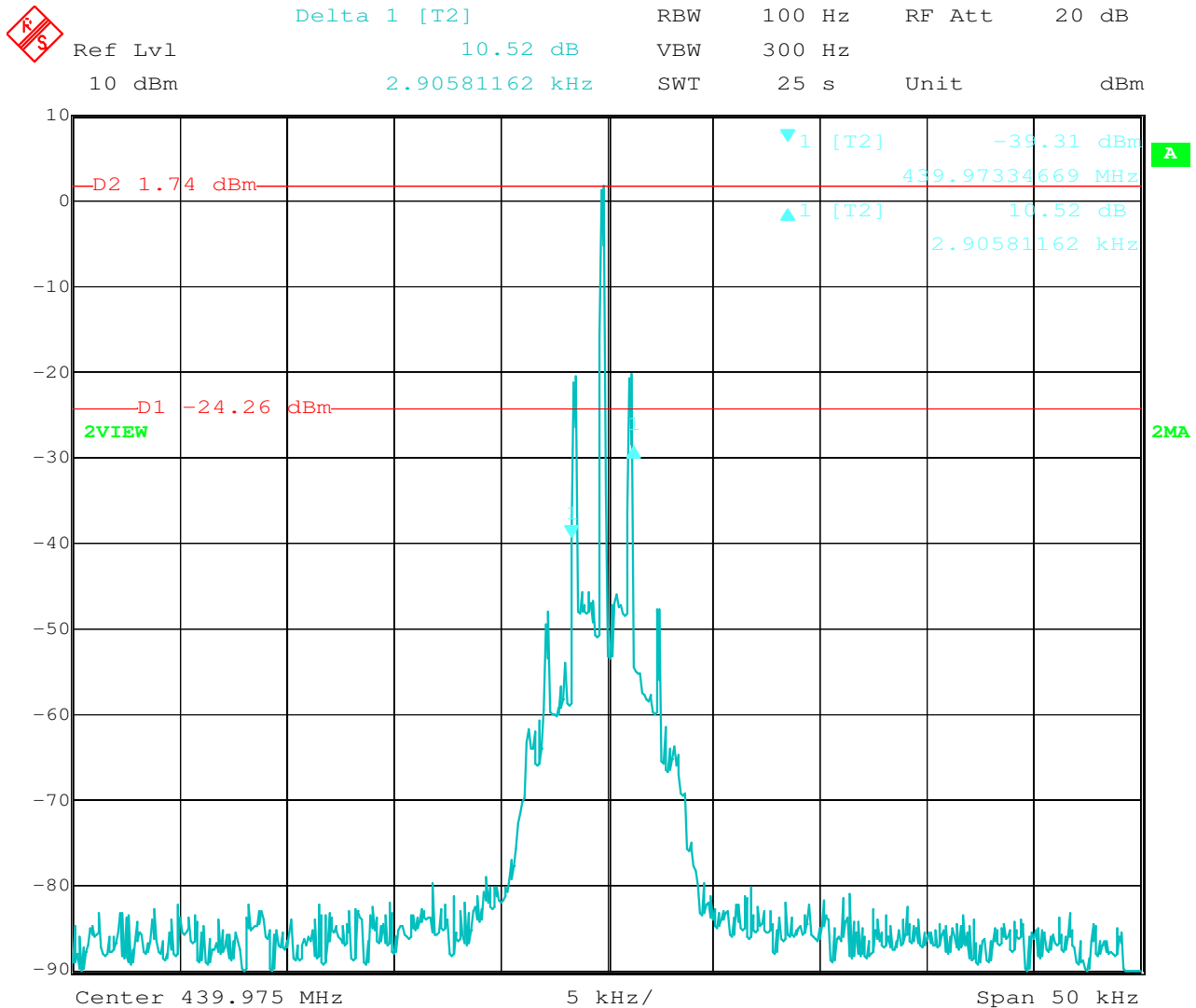

The report refers only to the sample tested and does not apply to the bulk.
 This report is issued in confidence to the client and it will be strictly treated as such by the SHENZHEN TIMEWAY TESTING LABORATORIES. It may not be reproduced rather in its entirety or in part and it may not be used for advertising. The client to whom the report is issued may, however, show or send it, or a certified copy thereof prepared by the SHENZHEN TIMEWAY TESTING LABORATORIES, to his customer, Supplier or others persons directly concerned. SHENZHEN TIMEWAY TESTING LABORATORIES, will not, without the consent of the client enter into any discussion of correspondence with any third party concerning the contents of the report.
 In the event of the improper use of the report. The SHENZHEN TIMEWAY TESTING LABORATORIES, reserves the rights to withdraw it and to adopt any other remedies which may be appropriate.



UHF Band-Middle Channel

99% Bandwidth



Ref Lvl	10 dBm	Marker 1 [T2]	1.74 dBm	RBW	100 Hz	RF Att	20 dB
			439.97484970 MHz	VBW	300 Hz		
				SWT	25 s	Unit	dBm

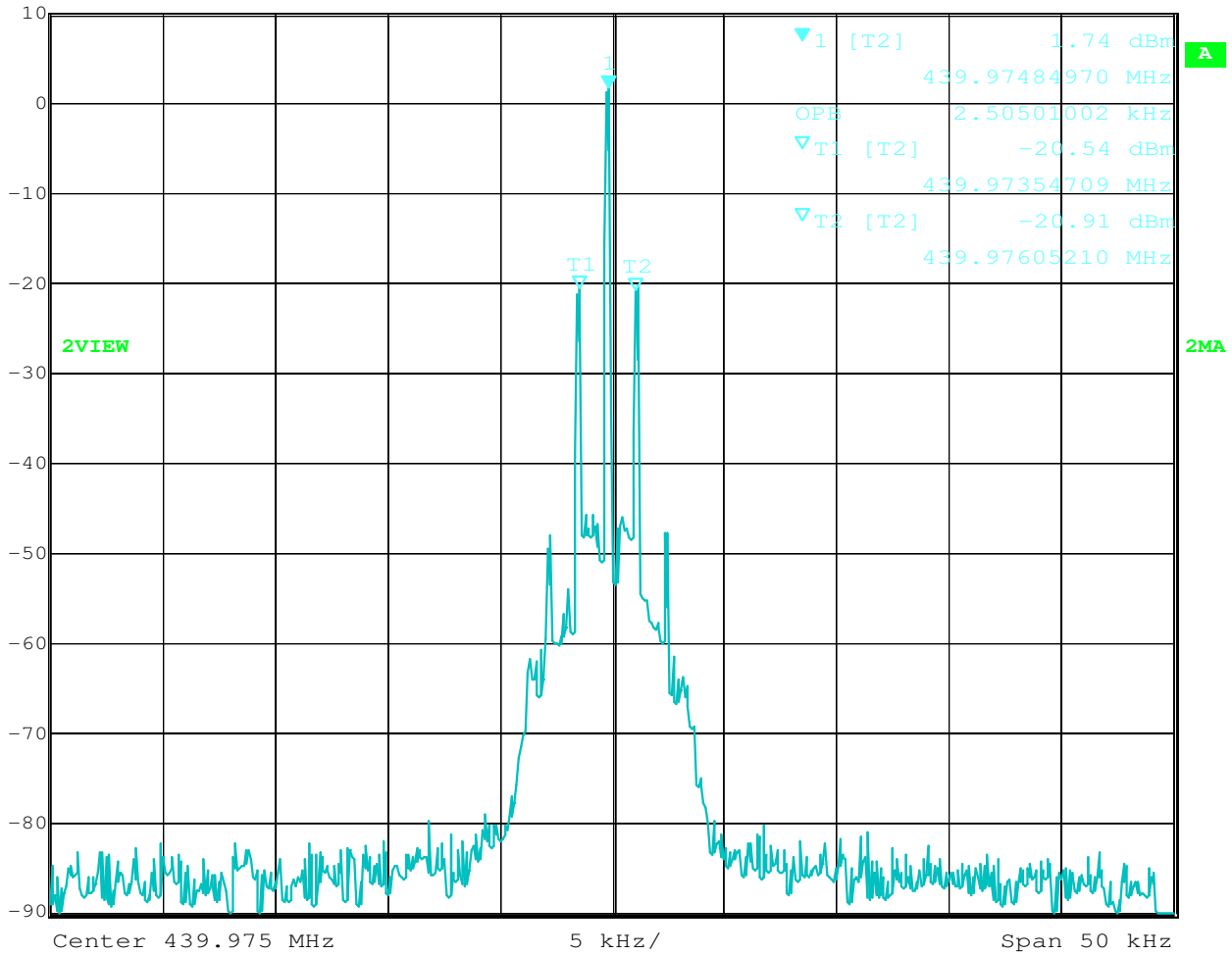

The report refers only to the sample tested and does not apply to the bulk.
 This report is issued in confidence to the client and it will be strictly treated as such by the SHENZHEN TIMEWAY TESTING LABORATORIES. It may not be reproduced rather in its entirety or in part and it may not be used for adverting. The client to whom the report is issued may, however, show or send it . or a certified copy there of prepared by the SHENZHEN TIMEWAY TESTING LABORATORIES. to his customer. Supplier or others persons directly concerned. SHENZHEN TIMEWAY TESTING LABORATORIES. will not, without the consent of the client enter into any discussion of correspondence with any third party concerning the contents of the report.
 In the event of the improper use of the report. The SHENZHEN TIMEWAY TESTING LABORATORIES. reserves the rights to withdraw it and to adopt any other remedies which may be appropriate.



UHF Band-Middle Channel

Emission Mask E



Ref Lvl	Marker 1 [T1]	RBW	100 Hz	RF Att	20 dB
10 dBm	1.79 dBm	VBW	300 Hz		
	439.97484970 MHz	SWT	25 s	Unit	dBm

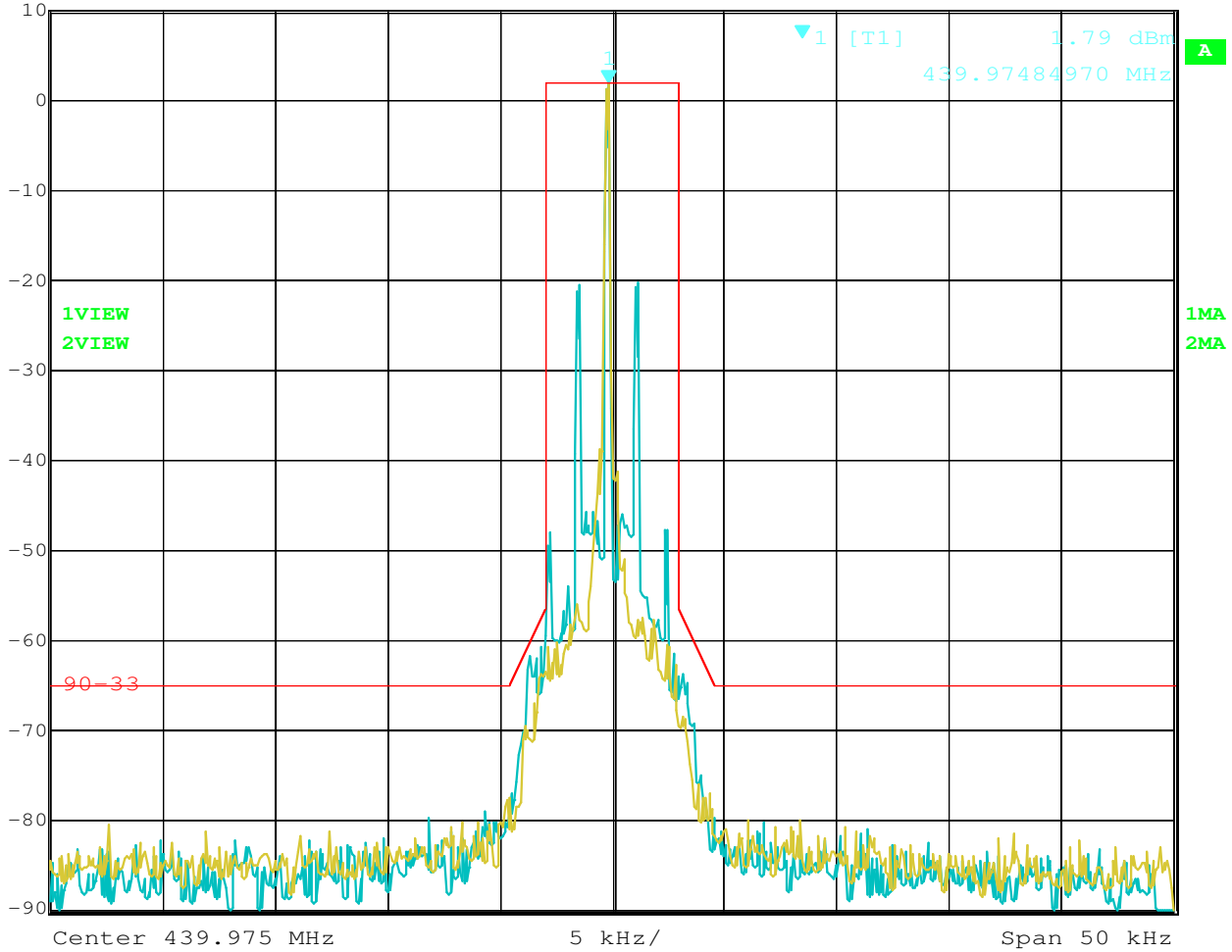

The report refers only to the sample tested and does not apply to the bulk.
 This report is issued in confidence to the client and it will be strictly treated as such by the SHENZHEN TIMEWAY TESTING LABORATORIES. It may not be reproduced rather in its entirety or in part and it may not be used for adverting. The client to whom the report is issued may, however, show or send it . or a certified copy there of prepared by the SHENZHEN TIMEWAY TESTING LABORATORIES. to his customer. Supplier or others persons directly concerned. SHENZHEN TIMEWAY TESTING LABORATORIES. will not, without the consent of the client enter into any discussion of correspondence with any third party concerning the contents of the report.
 In the event of the improper use of the report. The SHENZHEN TIMEWAY TESTING LABORATORIES. reserves the rights to withdraw it and to adopt any other remedies which may be appropriate.



8. UNWANTED RADIATION

8.1 PROVISIONS APPLICABLE

8.1.1 **Emission Mask D-**According to Section 90.210, the power of each unwanted emission shall be less than Transmitted Power as specified below for transmitters designed to operate with 12.5 KHz channel bandwidth:

- (1) On any frequency from the centre of the authorized bandwidth f_0 to 5.625 KHz removed from f_0 :
Zero dB
- (2) On any frequency removed from the center of the authorized bandwidth by a displacement frequency (f_d in kHz) of more than 5.625 KHz but no more than 12.5 KHz: At least $7.27(f_d - 2.88 \text{ KHz})$ dB
- (3) On any frequency removed from the center of the authorized bandwidth by a displacement frequency (f_d in kHz) of more than 12.5 kHz: At least $50 + 10 \log(P)$ dB or 70 dB, whichever is the lesser attenuation.

Emission Mask-E:

6.25 kHz or less channel bandwidth equipment. For transmitters designed to operate with a 6.25 kHz or less bandwidth, any emission must be attenuated below the power (P) of the highest emission contained within the authorized bandwidth as follows:

- (1) On any frequency from the center of the authorized bandwidth f_0 to 3.0 kHz removed from f_0 : Zero dB.
- (2) On any frequency removed from the center of the authorized bandwidth by a displacement frequency (f_d in kHz) of more than 3.0 kHz but no more than 4.6 kHz: At least $30 + 16.67(f_d - 3 \text{ kHz})$ or $55 + 10 \log(P)$ or 65 dB, whichever is the lesser attenuation.
- (3) On any frequency removed from the center of the authorized bandwidth by more than 4.6 kHz: At least $55 + 10 \log(P)$ or 65 dB, whichever is the lesser attenuation.
- (4) The reference level for showing compliance with the emission mask shall be established using a resolution bandwidth sufficiently wide (usually two or three times the channel bandwidth) to capture the true peak emission of the equipment under test. In order to show compliance with the emission mask up to and including 50 kHz removed from the edge of the authorized bandwidth, adjust the resolution bandwidth to 100 Hz with the measuring instrument in a peak hold mode. A sufficient number of sweeps must be measured to insure that the emission profile is developed. If video filtering is used, its bandwidth must not be less than the instrument resolution bandwidth. For emissions beyond 50 kHz from the edge of the authorized bandwidth, see paragraph (o) of this section. If it can be shown that use of the above instrumentation settings do not accurately represent the true interference potential of the equipment under test, an alternate procedure may be used provided prior Commission approval is obtained.

8.2 MEASUREMENT PROCEDURE (Radiated Emissions)

- (1). On a test site, the EUT shall be placed on a turntable, and in the position closest to the normal use as declared by the user.
- (2). The test antenna shall be oriented initially for vertical polarization located 3m from the EUT to correspond to the transmitter.
- (3). The output of the antenna shall be connected to the measuring receiver and either a peak or quasi-peak

The report refers only to the sample tested and does not apply to the bulk.

This report is issued in confidence to the client and it will be strictly treated as such by the SHENZHEN TIMEWAY TESTING LABORATORIES. It may not be reproduced rather in its entirety or in part and it may not be used for advertising. The client to whom the report is issued may, however, show or send it, or a certified copy thereof prepared by the SHENZHEN TIMEWAY TESTING LABORATORIES, to his customer. Supplier or others persons directly concerned. SHENZHEN TIMEWAY TESTING LABORATORIES, will not, without the consent of the client enter into any discussion of correspondence with any third party concerning the contents of the report.

In the event of the improper use of the report. The SHENZHEN TIMEWAY TESTING LABORATORIES, reserves the rights to withdraw it and to adopt any other remedies which may be appropriate.



detector was used for the measurement as indicated on the report. The detector selection is based on how close the emission level was approaching the limit.

- (4). The transmitter shall be switched on; if possible, without the modulation and the measurement receiver shall be tuned to the frequency of the transmitter under test.
- (5). The test antenna shall be raised and lowered through the specified range of height until the measuring receiver detects a maximum signal level.
- (6). The transmitter shall then be rotated through 360° in the horizontal plane, until the maximum signal level is detected by the measuring receiver.
- (7). The test antenna shall be raised and lowered again through the specified range of height until the measuring receiver detects a maximum signal level.
- (8). The maximum signal level detected by the measuring receiver shall be noted.
- (9). The measurement shall be repeated with the test antenna set to horizontal polarization.
- (10). Replace the antenna with a proper Antenna (substitution antenna).
- (11). The substitution antenna shall be oriented for vertical polarization and, if necessary, the length of the substitution antenna shall be adjusted to correspond to the frequency of transmitting.
- (12). The substitution antenna shall be connected to a calibrated signal generator.
- (13). If necessary, the input attenuator setting of the measuring receiver shall be adjusted in order to increase the sensitivity of the measuring receiver.
- (14). The test antenna shall be raised and lowered through the specified range of the height to ensure that the maximum signal is received.
- (15). The input signal to substitution antenna shall be adjusted to the level that produces a level detected by the measuring receiver, that is equal to the level noted while the transmitter radiated power was measured, corrected for the change of input attenuation setting of the measuring receiver and Gain of Substitution antenna.
- (16). The input level to the substitution antenna shall be recorded as power level in dBm, corrected for any change of input attenuator setting of the measuring receiver and Gain of Substitution antenna. So the EIRP is obtained.
- (17). The measurement shall be repeated with the test antenna and the substitution antenna oriented for horizontal polarization.

8.3 Test setup Block Diagram

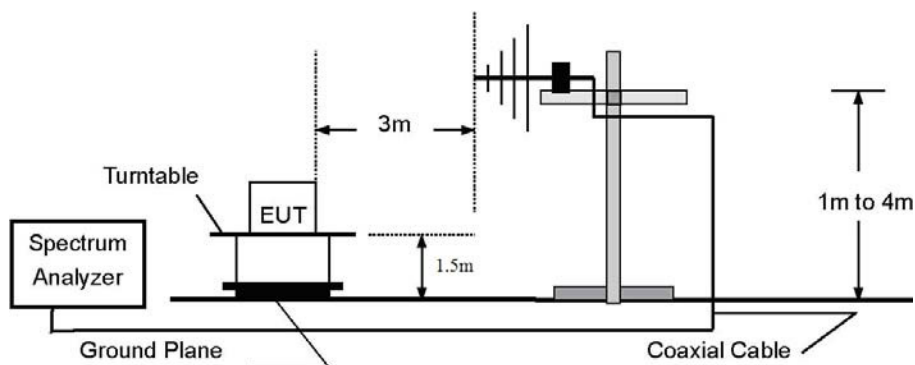

The report refers only to the sample tested and does not apply to the bulk.

This report is issued in confidence to the client and it will be strictly treated as such by the SHENZHEN TIMEWAY TESTING LABORATORIES. It may not be reproduced rather in its entirety or in part and it may not be used for advertising. The client to whom the report is issued may, however, show or send it, or a certified copy thereof prepared by the SHENZHEN TIMEWAY TESTING LABORATORIES, to his customer. Supplier or others persons directly concerned. SHENZHEN TIMEWAY TESTING LABORATORIES, will not, without the consent of the client enter into any discussion of correspondence with any third party concerning the contents of the report.

In the event of the improper use of the report. The SHENZHEN TIMEWAY TESTING LABORATORIES, reserves the rights to withdraw it and to adopt any other remedies which may be appropriate.



8.4 Substitution Method: (Radiated Emissions)

Radiated Below 1GHz

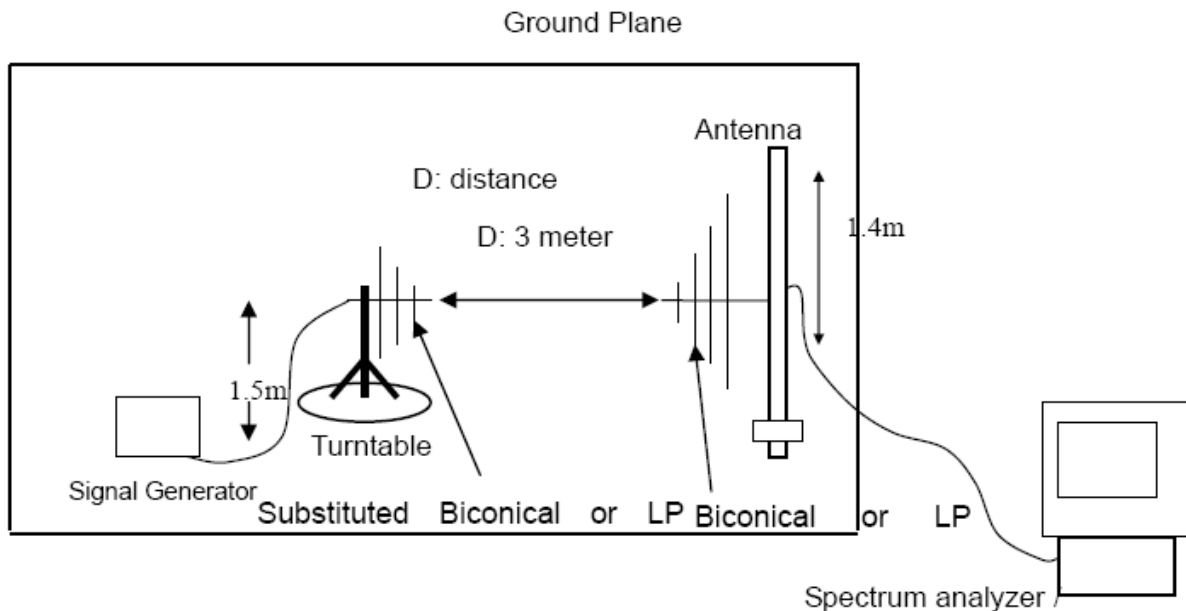

Radiated Above 1 GHz

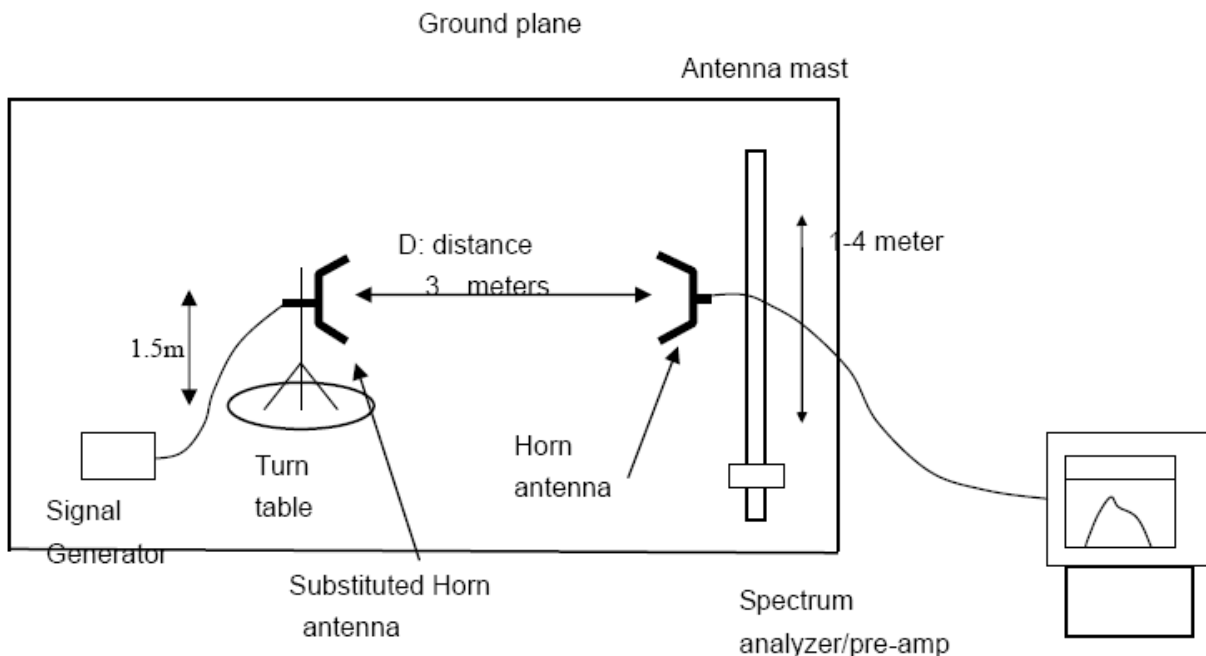

The report refers only to the sample tested and does not apply to the bulk.
 This report is issued in confidence to the client and it will be strictly treated as such by the SHENZHEN TIMEWAY TESTING LABORATORIES. It may not be reproduced rather in its entirety or in part and it may not be used for advertising. The client to whom the report is issued may, however, show or send it or a certified copy thereof prepared by the SHENZHEN TIMEWAY TESTING LABORATORIES to his customer. Supplier or others persons directly concerned. SHENZHEN TIMEWAY TESTING LABORATORIES will not, without the consent of the client enter into any discussion of correspondence with any third party concerning the contents of the report.
 In the event of the improper use of the report. The SHENZHEN TIMEWAY TESTING LABORATORIES reserves the rights to withdraw it and to adopt any other remedies which may be appropriate.



8.5 MEASUREMENT RESULTS:

Limit: $43 + 10 \log (P)$ dB, (-13 dBm)

Note: The results were peak values and worse case was recorded

UHF Band

Bottom channel

Frequency (MHz)	Substituted Level (dBm)	Cable Loss (dBm)	Antennal Polarity	Antenna Gain (dB)	Emission (dBm)	Limit (dBm)
812.25	-36.2	2.1	Vertical	6.2	-32.1	-13
1218.38	-41.1	3.3	Vertical	7.3	-37.1	-13
1624.5	-35.4	3.9	Vertical	8.7	-40.2	-13
2030.63	-49.3	4.5	Vertical	10.2	-43.6	-13
812.25	-40.2	2.1	Horizontal	6.2	-36.1	-13
1218.38	-47.6	3.3	Horizontal	7.3	-43.6	-13
1624.5	-52.7	3.9	Horizontal	8.7	-47.9	-13

The report refers only to the sample tested and does not apply to the bulk.

This report is issued in confidence to the client and it will be strictly treated as such by the SHENZHEN TIMEWAY TESTING LABORATORIES. It may not be reproduced rather in its entirety or in part and it may not be used for adverting. The client to whom the report is issued may, however, show or send it . or a certified copy there of prepared by the SHENZHEN TIMEWAY TESTING LABORATORIES. to his customer. Supplier or others persons directly concerned. SHENZHEN TIMEWAY TESTING LABORATORIES. will not, without the consent of the client enter into any discussion of correspondence with any third party concerning the contents of the report.

In the event of the improper use of the report. The SHENZHEN TIMEWAY TESTING LABORATORIES. reserves the rights to withdraw it and to adopt any other remedies which may be appropriate.



Horizontal-Bottom Channel

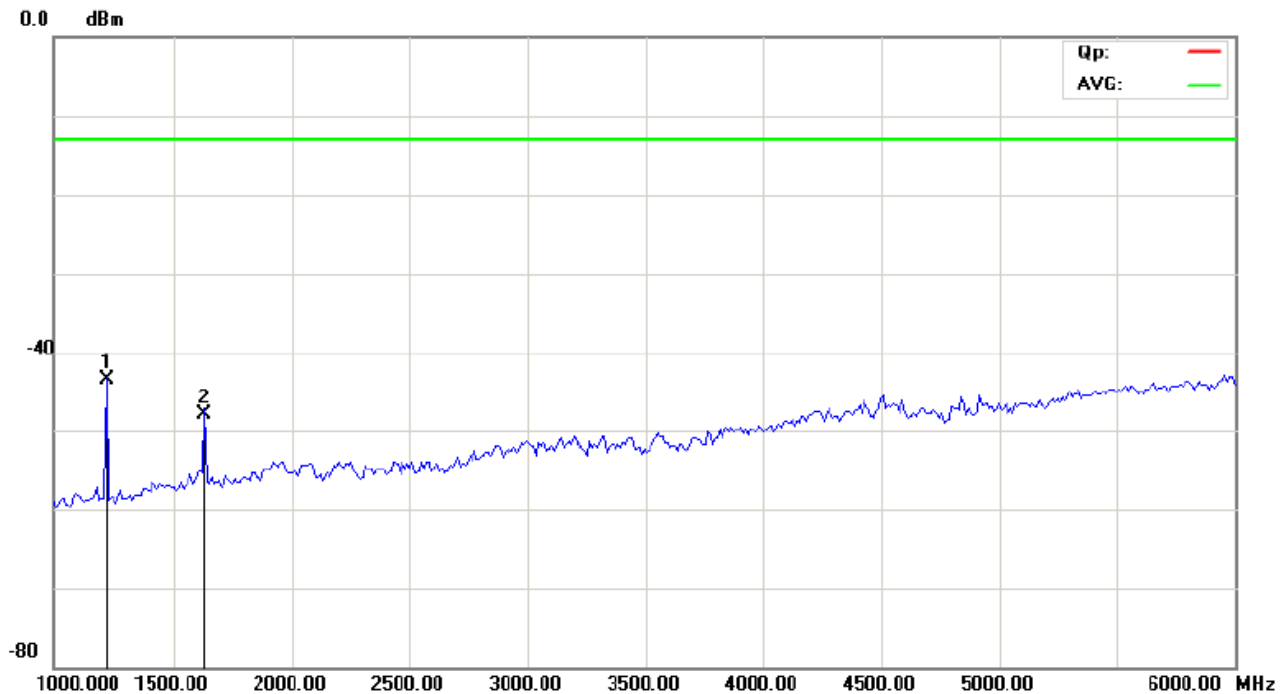
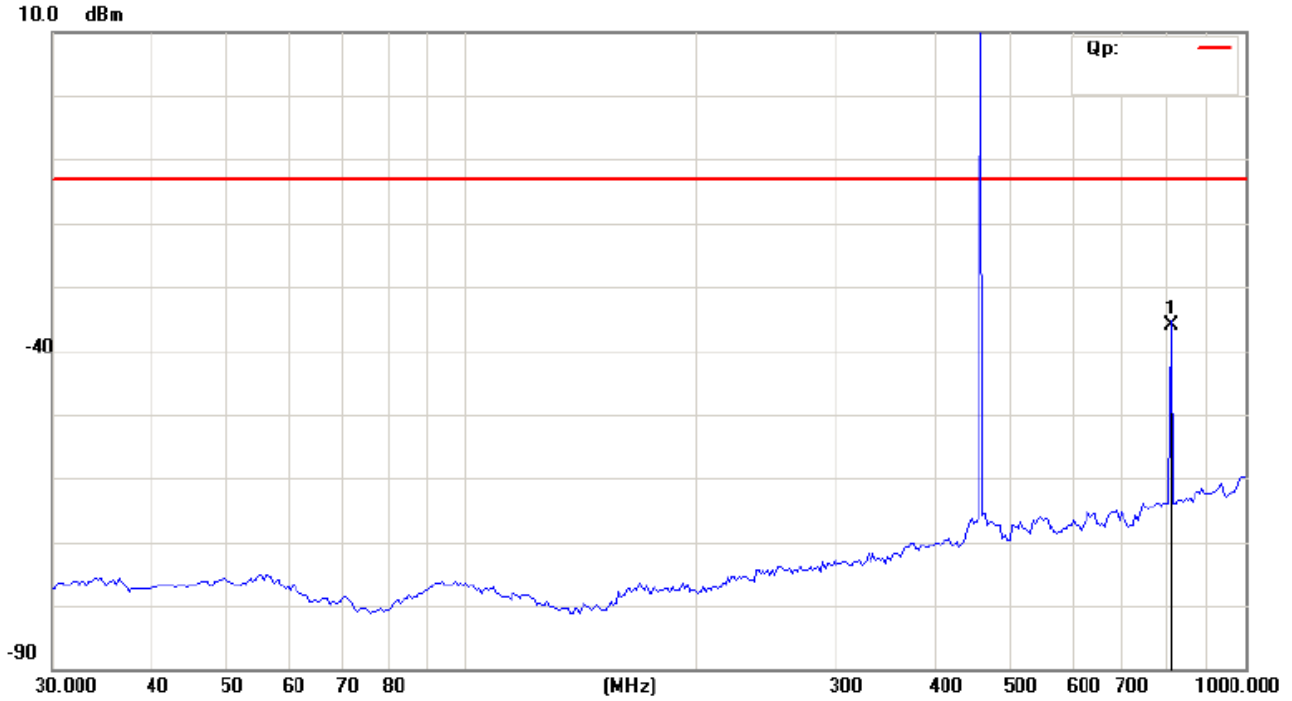

The report refers only to the sample tested and does not apply to the bulk.

This report is issued in confidence to the client and it will be strictly treated as such by the SHENZHEN TIMEWAY TESTING LABORATORIES. It may not be reproduced rather in its entirety or in part and it may not be used for advertising. The client to whom the report is issued may, however, show or send it or a certified copy thereof prepared by the SHENZHEN TIMEWAY TESTING LABORATORIES to his customer. Supplier or others persons directly concerned. SHENZHEN TIMEWAY TESTING LABORATORIES will not, without the consent of the client enter into any discussion of correspondence with any third party concerning the contents of the report.

In the event of the improper use of the report. The SHENZHEN TIMEWAY TESTING LABORATORIES reserves the rights to withdraw it and to adopt any other remedies which may be appropriate.



Vertical-Bottom Channel

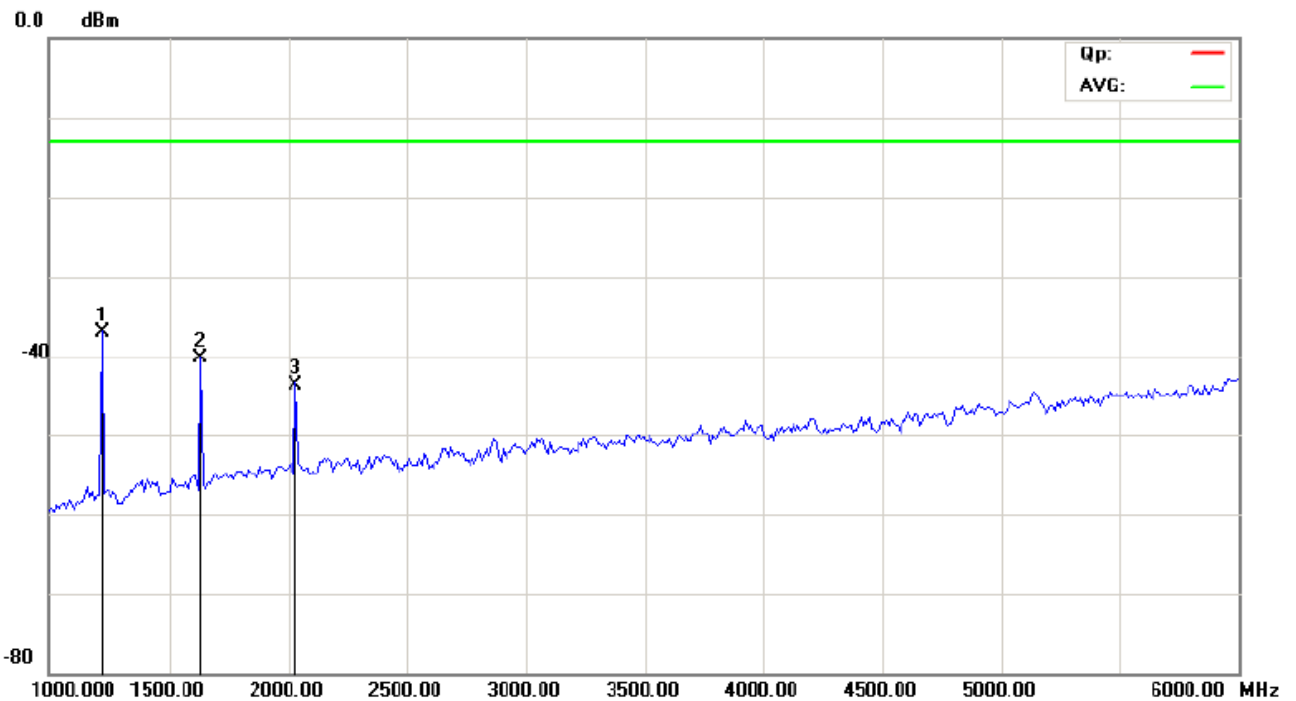
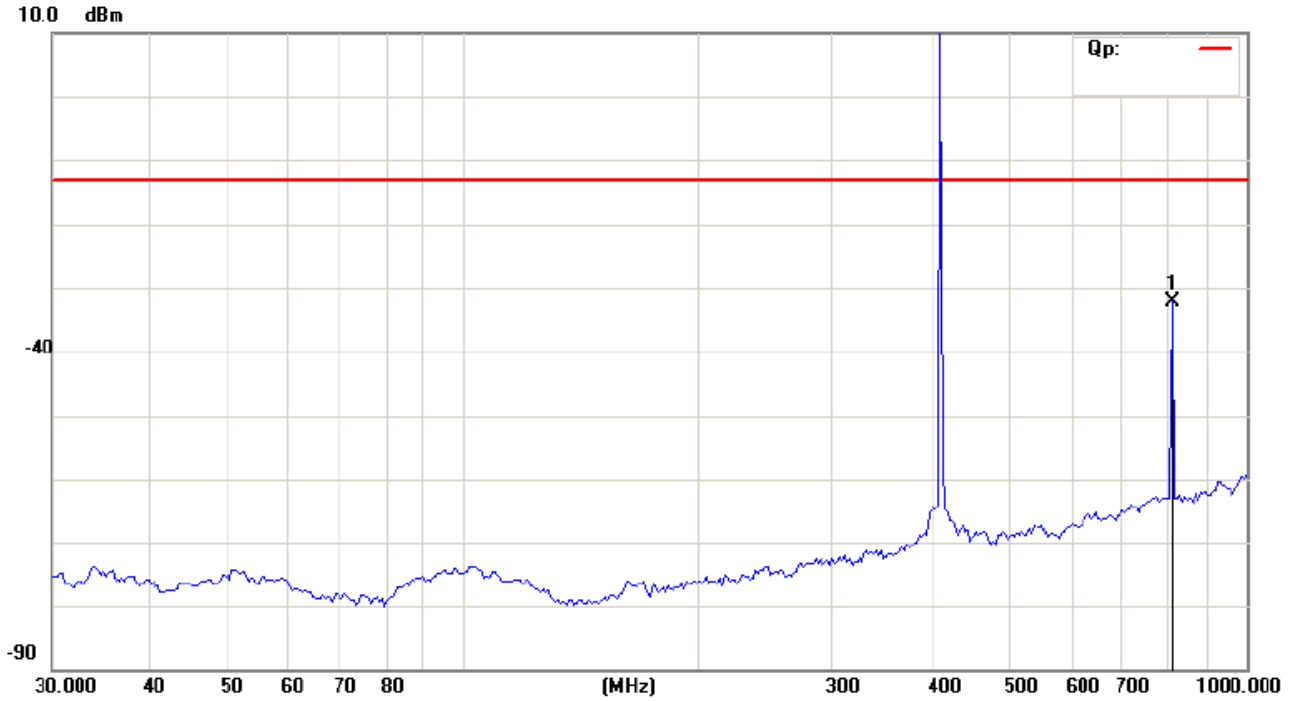

The report refers only to the sample tested and does not apply to the bulk.
This report is issued in confidence to the client and it will be strictly treated as such by the SHENZHEN TIMEWAY TESTING LABORATORIES. It may not be reproduced rather in its entirety or in part and it may not be used for advertising. The client to whom the report is issued may, however, show or send it, or a certified copy thereof prepared by the SHENZHEN TIMEWAY TESTING LABORATORIES, to his customer. Supplier or others persons directly concerned. SHENZHEN TIMEWAY TESTING LABORATORIES, will not, without the consent of the client enter into any discussion of correspondence with any third party concerning the contents of the report.
In the event of the improper use of the report. The SHENZHEN TIMEWAY TESTING LABORATORIES, reserves the rights to withdraw it and to adopt any other remedies which may be appropriate.



Middle channel

Frequency (MHz)	Substituted Level (dBm)	Cable Loss (dBm)	Antennal Polarity	Antenna Gain (dB)	Emission (dBm)	Limit (dBm)
879.95	-34.1	2.3	Vertical	6.3	-30.1	-13
1319.93	-40.9	3.6	Vertical	7.3	-37.2	-13
1759.90	-46.6	4.4	Vertical	8.9	-42.1	-13
2199.88	-52.7	5.1	Vertical	10.4	-46.4	-13
879.95	-39.6	2.3	Horizontal	6.3	-35.6	-13
1319.93	-46.9	3.6	Horizontal	7.3	-43.2	-13
1759.90	-51.4	4.4	Vertical	8.9	-46.9	-13

The report refers only to the sample tested and does not apply to the bulk.

This report is issued in confidence to the client and it will be strictly treated as such by the SHENZHEN TIMEWAY TESTING LABORATORIES. It may not be reproduced rather in its entirety or in part and it may not be used for advertizing. The client to whom the report is issued may, however, show or send it . or a certified copy there of prepared by the SHENZHEN TIMEWAY TESTING LABORATORIES. to his customer. Supplier or others persons directly concerned. SHENZHEN TIMEWAY TESTING LABORATORIES. will not, without the consent of the client enter into any discussion of correspondence with any third party concerning the contents of the report.

In the event of the improper use of the report. The SHENZHEN TIMEWAY TESTING LABORATORIES. reserves the rights to withdraw it and to adopt any other remedies which may be appropriate.



Horizontal-Bottom Channel

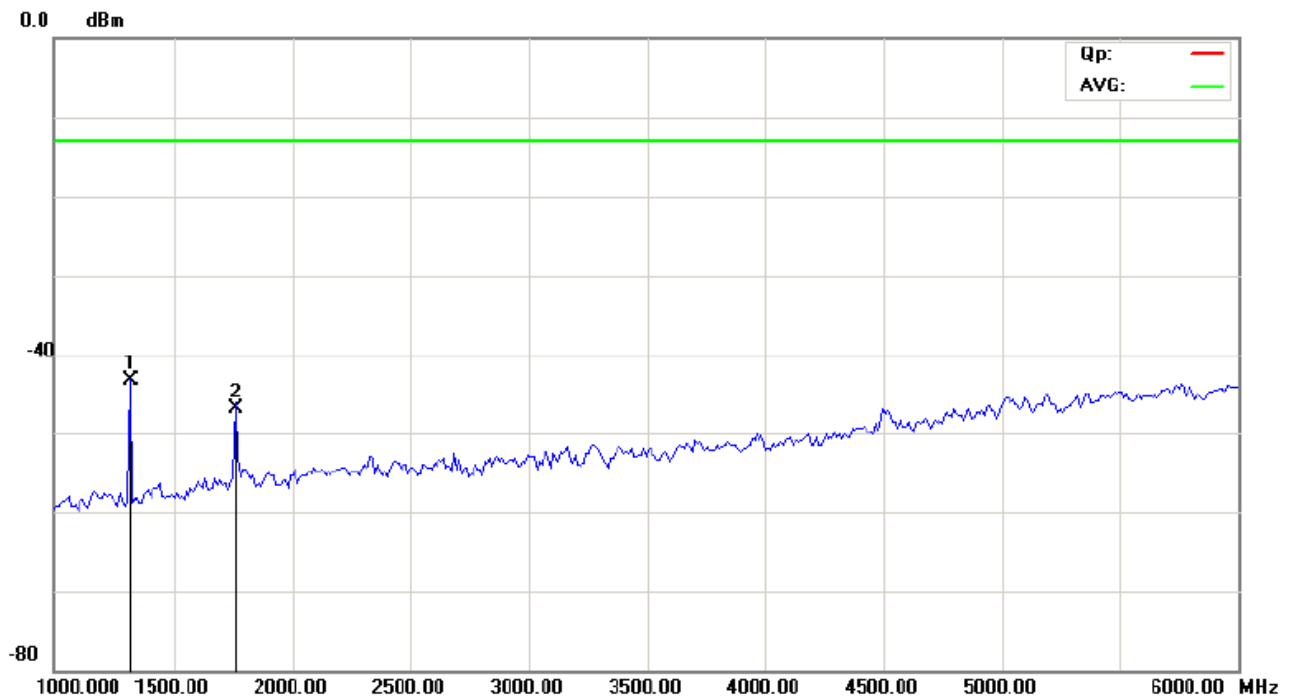
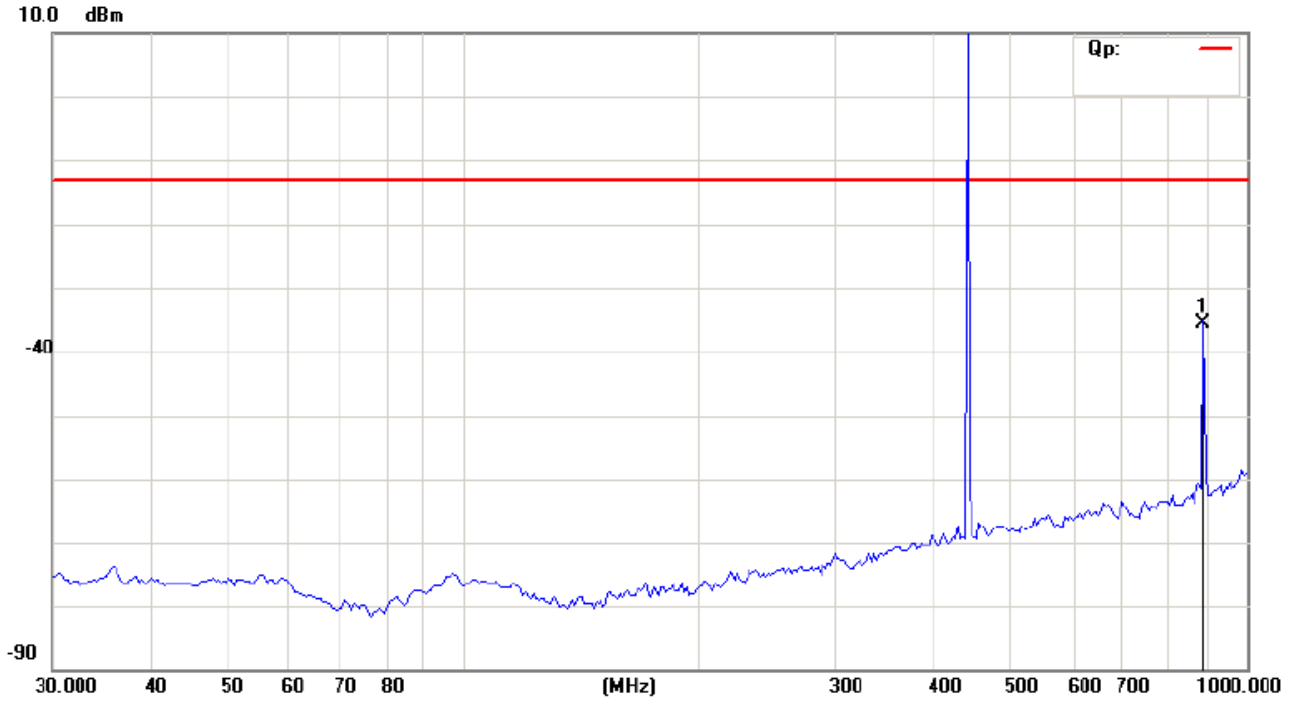

The report refers only to the sample tested and does not apply to the bulk.
This report is issued in confidence to the client and it will be strictly treated as such by the SHENZHEN TIMEWAY TESTING LABORATORIES. It may not be reproduced rather in its entirety or in part and it may not be used for adverting. The client to whom the report is issued may, however, show or send it . or a certified copy there of prepared by the SHENZHEN TIMEWAY TESTING LABORATORIES. to his customer. Supplier or others persons directly concerned. SHENZHEN TIMEWAY TESTING LABORATORIES. will not, without the consent of the client enter into any discussion of correspondence with any third party concerning the contents of the report.
In the event of the improper use of the report. The SHENZHEN TIMEWAY TESTING LABORATORIES. reserves the rights to withdraw it and to adopt any other remedies which may be appropriate.



Vertical-Bottom Channel

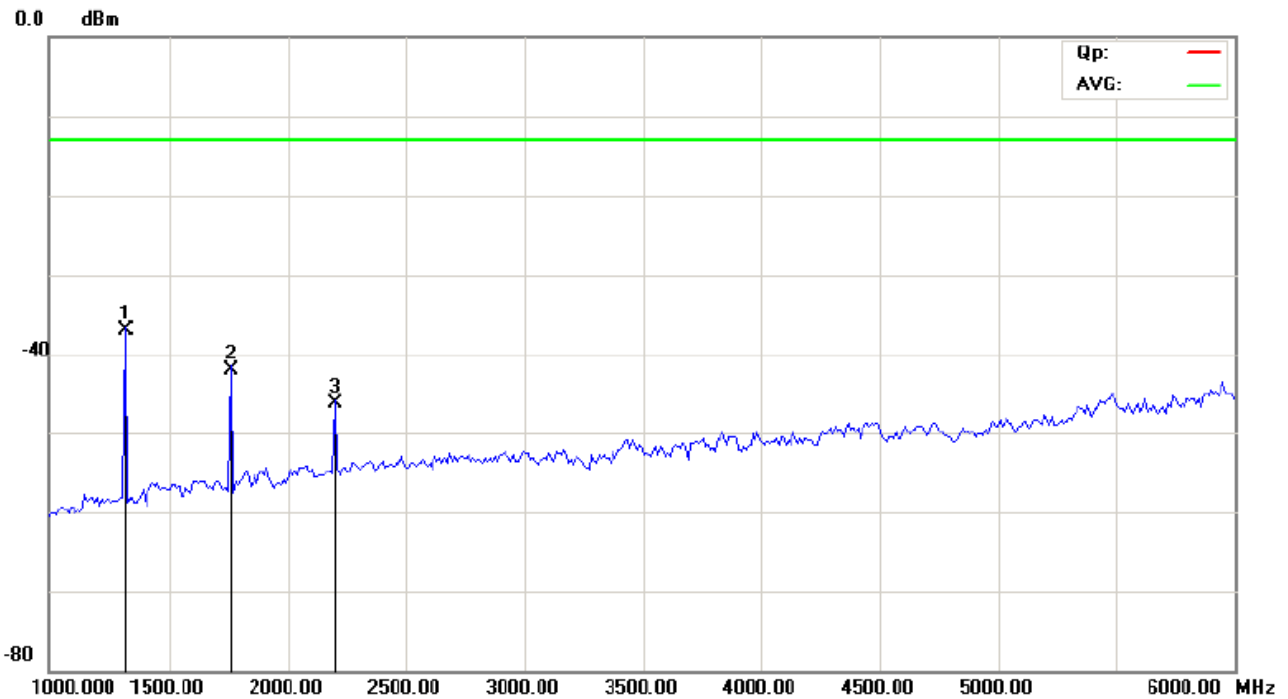
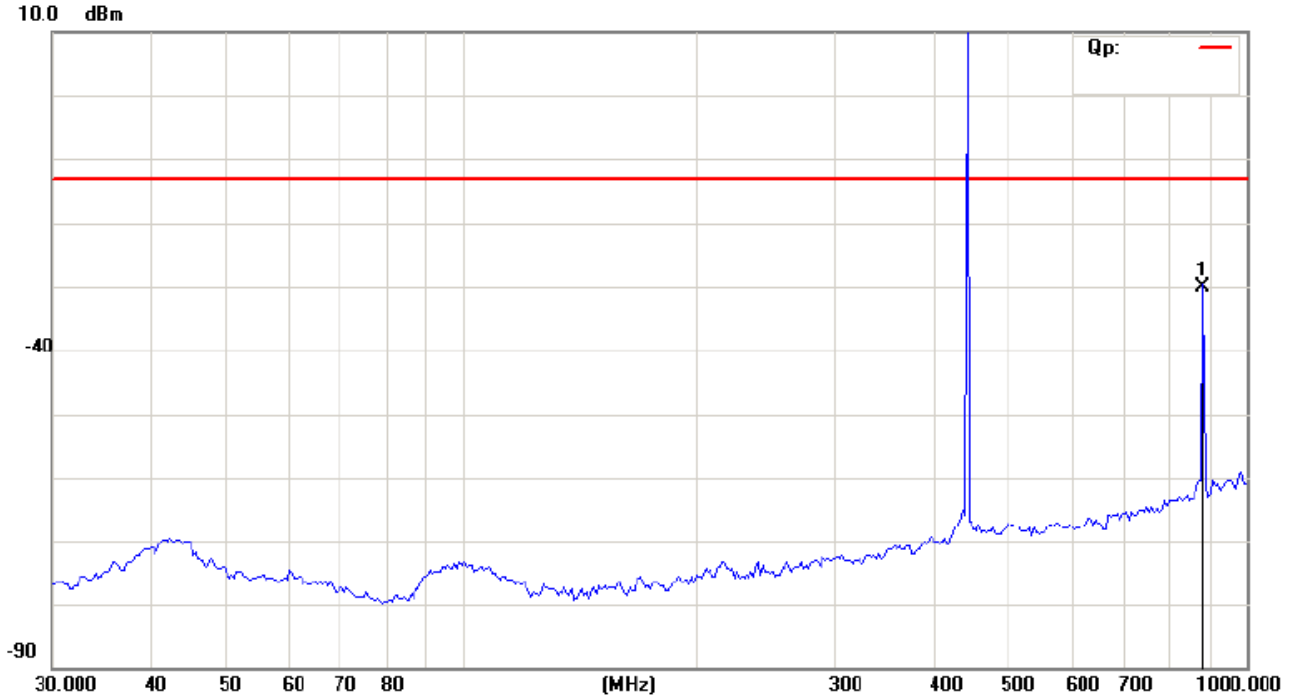

The report refers only to the sample tested and does not apply to the bulk.
This report is issued in confidence to the client and it will be strictly treated as such by the SHENZHEN TIMEWAY TESTING LABORATORIES. It may not be reproduced rather in its entirety or in part and it may not be used for advertising. The client to whom the report is issued may, however, show or send it, or a certified copy thereof prepared by the SHENZHEN TIMEWAY TESTING LABORATORIES, to his customer. Supplier or others persons directly concerned. SHENZHEN TIMEWAY TESTING LABORATORIES, will not, without the consent of the client enter into any discussion of correspondence with any third party concerning the contents of the report.
In the event of the improper use of the report. The SHENZHEN TIMEWAY TESTING LABORATORIES, reserves the rights to withdraw it and to adopt any other remedies which may be appropriate.



Top channel

Frequency (MHz)	Substituted Level (dBm)	Cable Loss (dBm)	Antennal Polarity	Antenna Gain (dB)	Emission (dBm)	Limit (dBm)
939.95	-37.2	2.7	Vertical	6.6	-33.3	-13
1409.93	-44.6	3.8	Vertical	7.8	-40.6	-13
1979.90	-48.6	4.9	Vertical	9.1	-44.4	-13
939.95	-42.2	2.7	Horizontal	6.6	-38.3	-13
1409.93	-47.7	3.8	Horizontal	7.8	-43.7	-13

The report refers only to the sample tested and does not apply to the bulk.

This report is issued in confidence to the client and it will be strictly treated as such by the SHENZHEN TIMEWAY TESTING LABORATORIES. It may not be reproduced rather in its entirety or in part and it may not be used for advertizing. The client to whom the report is issued may, however, show or send it . or a certified copy there of prepared by the SHENZHEN TIMEWAY TESTING LABORATORIES. to his customer. Supplier or others persons directly concerned. SHENZHEN TIMEWAY TESTING LABORATORIES. will not, without the consent of the client enter into any discussion of correspondence with any third party concerning the contents of the report.

In the event of the improper use of the report. The SHENZHEN TIMEWAY TESTING LABORATORIES. reserves the rights to withdraw it and to adopt any other remedies which may be appropriate.



Horizontal-Bottom Channel

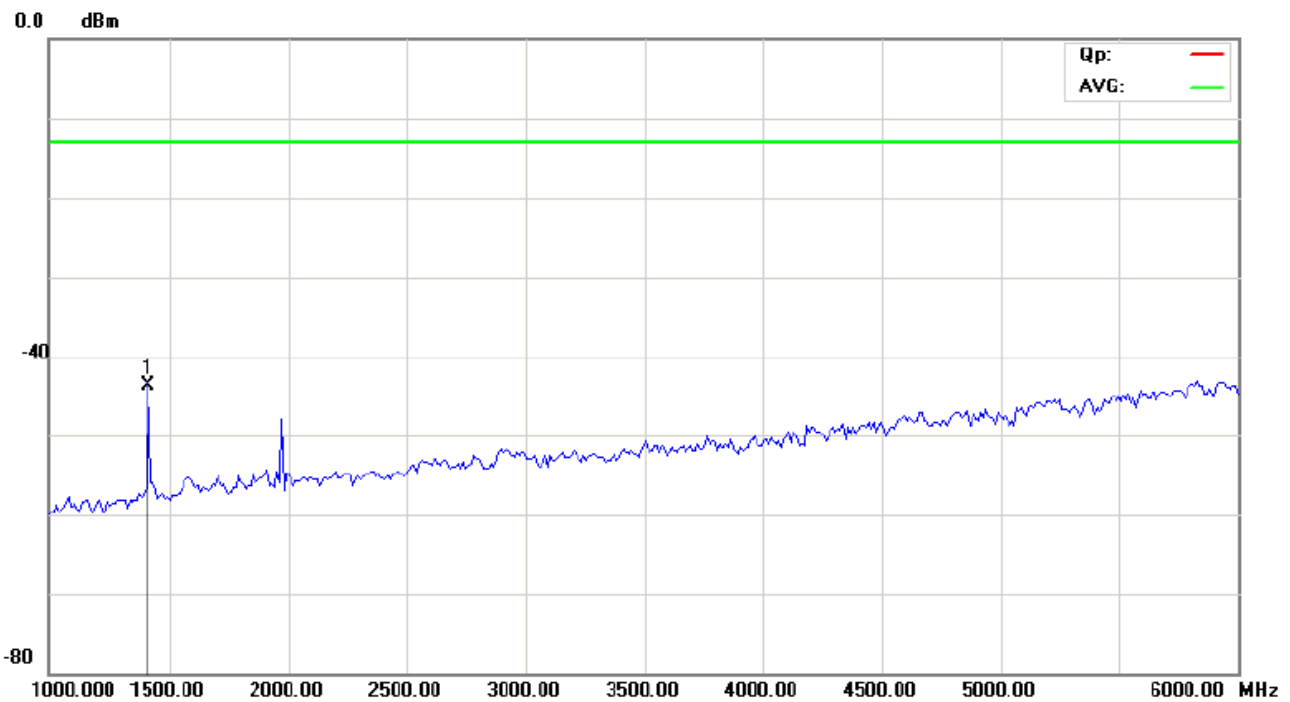
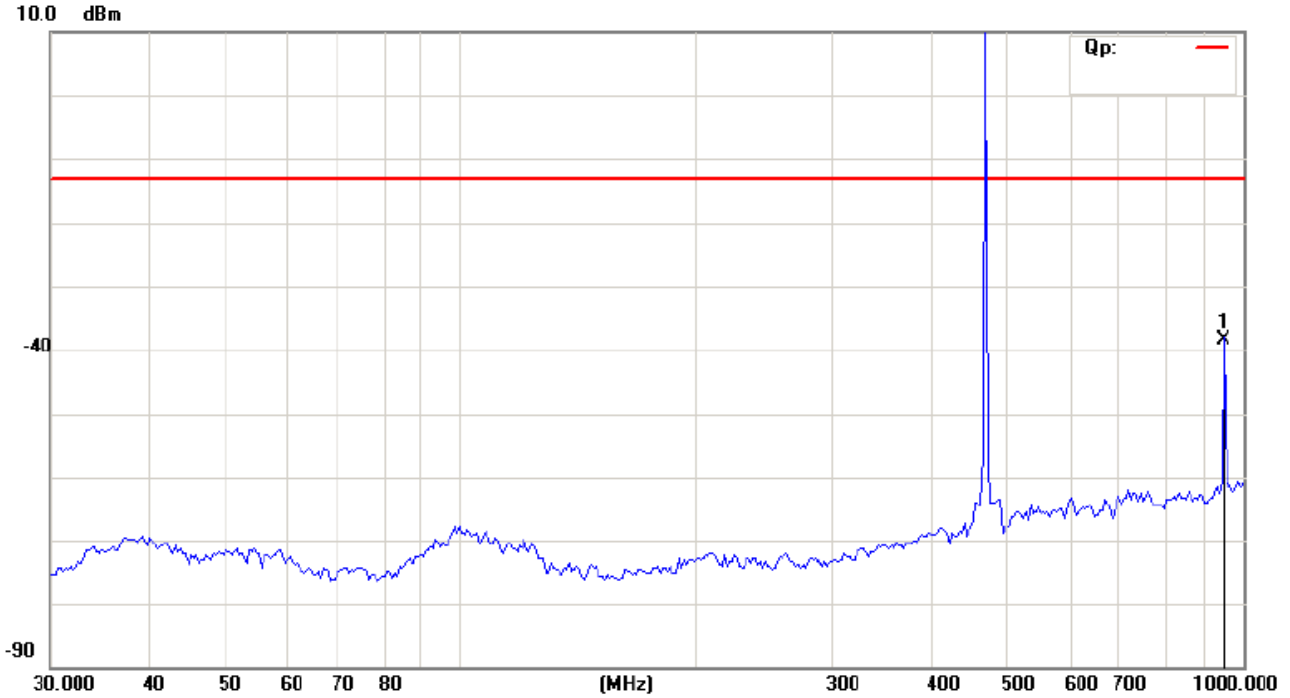

The report refers only to the sample tested and does not apply to the bulk.
This report is issued in confidence to the client and it will be strictly treated as such by the SHENZHEN TIMEWAY TESTING LABORATORIES. It may not be reproduced rather in its entirety or in part and it may not be used for adverting. The client to whom the report is issued may, however, show or send it . or a certified copy there of prepared by the SHENZHEN TIMEWAY TESTING LABORATORIES. to his customer. Supplier or others persons directly concerned. SHENZHEN TIMEWAY TESTING LABORATORIES. will not, without the consent of the client enter into any discussion of correspondence with any third party concerning the contents of the report.
In the event of the improper use of the report. The SHENZHEN TIMEWAY TESTING LABORATORIES. reserves the rights to withdraw it and to adopt any other remedies which may be appropriate.



Vertical-Bottom Channel

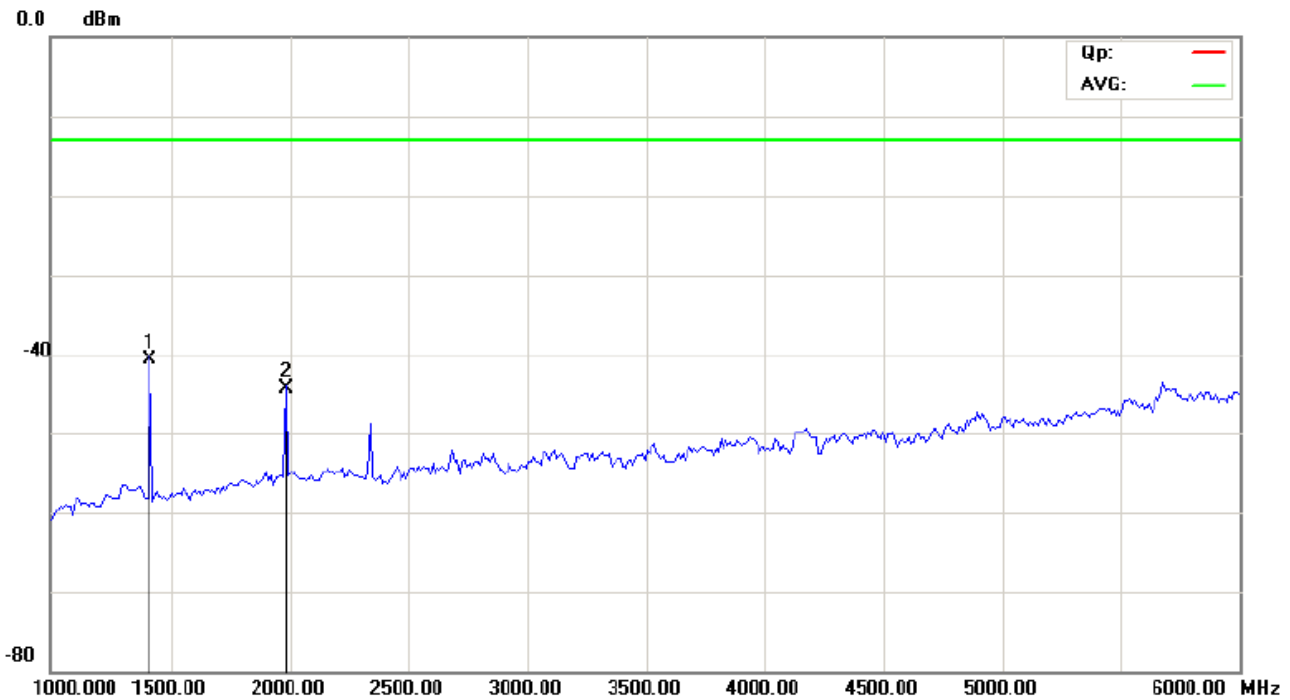
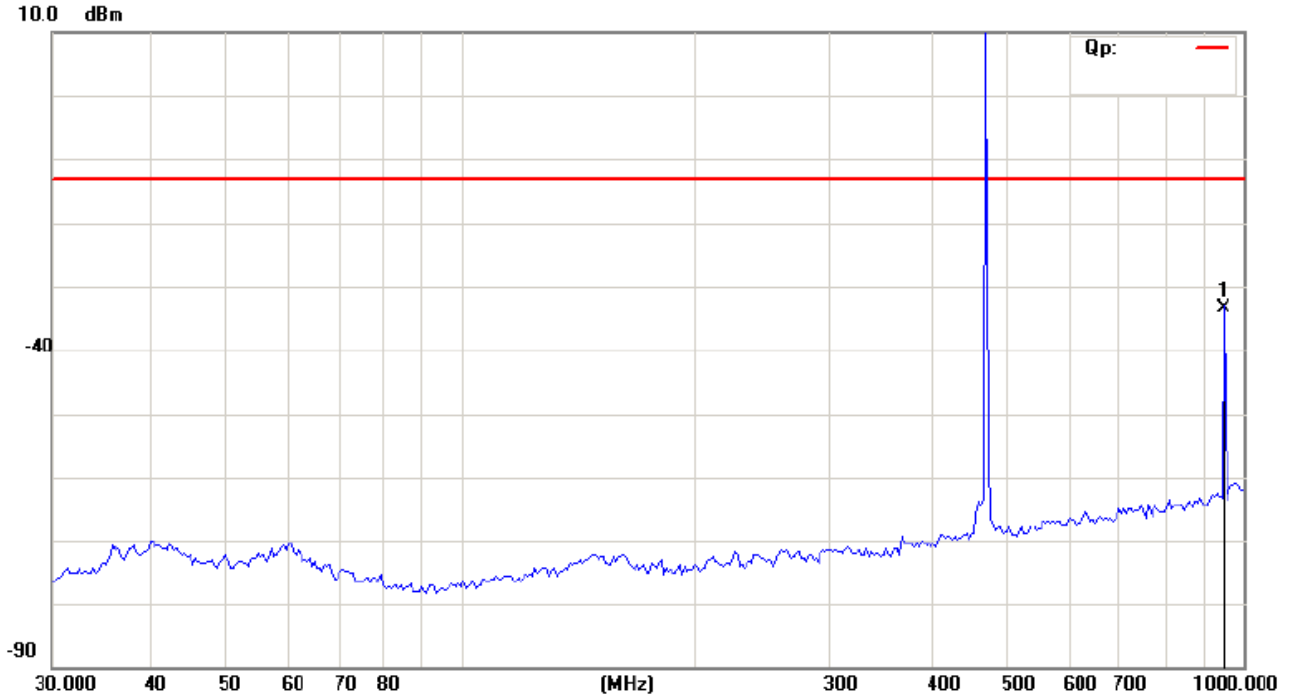

The report refers only to the sample tested and does not apply to the bulk.
This report is issued in confidence to the client and it will be strictly treated as such by the SHENZHEN TIMEWAY TESTING LABORATORIES. It may not be reproduced rather in its entirety or in part and it may not be used for advertizing. The client to whom the report is issued may, however, show or send it . or a certified copy there of prepared by the SHENZHEN TIMEWAY TESTING LABORATORIES. to his customer. Supplier or others persons directly concerned. SHENZHEN TIMEWAY TESTING LABORATORIES. will not, without the consent of the client enter into any discussion of correspondence with any third party concerning the contents of the report.
In the event of the improper use of the report. The SHENZHEN TIMEWAY TESTING LABORATORIES. reserves the rights to withdraw it and to adopt any other remedies which may be appropriate.



8.6 Conducted Emissions

8.6.1. Measurement Procedure

- 1). The eut antenna port connect to the spectrum analyzer through a attenuator.
- 2). Let the eut working in transmitter and used the spectrum to measure the conducted emission.
- 3). The output of the antenna shall be connected to the spectrum.

The setup of test receiver: Detector: Peak RBW: 120 kHz for 30-1000MHz, 1MHz for above1GHz
VBW: 300 kHz for 30-1000MHz 3MHz for above1GHz

8.6.2. Test Setup Block Diagram (block diagram of configuration)



8.6.3 Test Result

The report refers only to the sample tested and does not apply to the bulk.

This report is issued in confidence to the client and it will be strictly treated as such by the SHENZHEN TIMEWAY TESTING LABORATORIES. It may not be reproduced rather in its entirety or in part and it may not be used for adverting. The client to whom the report is issued may, however, show or send it . or a certified copy there of prepared by the SHENZHEN TIMEWAY TESTING LABORATORIES. to his customer. Supplier or others persons directly concerned. SHENZHEN TIMEWAY TESTING LABORATORIES. will not, without the consent of the client enter into any discussion of correspondence with any third party concerning the contents of the report.

In the event of the improper use of the report. The SHENZHEN TIMEWAY TESTING LABORATORIES. reserves the rights to withdraw it and to adopt any other remedies which may be appropriate.



Bottom Channel

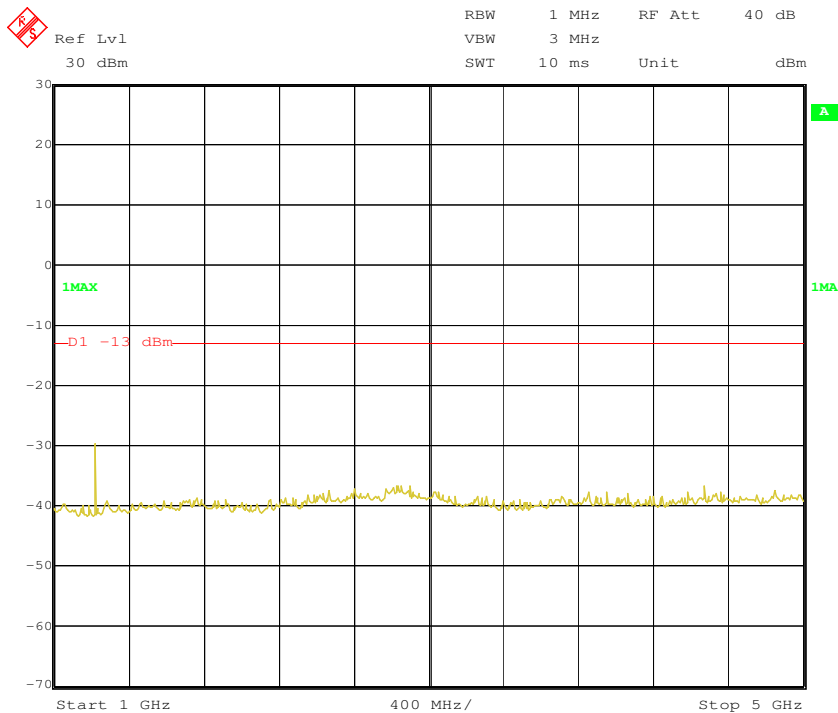
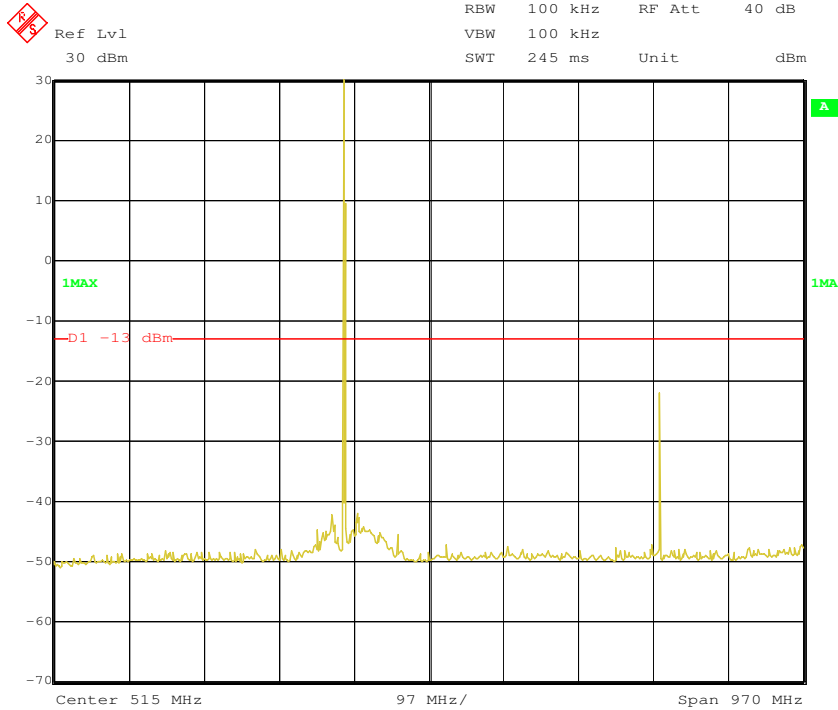

The report refers only to the sample tested and does not apply to the bulk.

This report is issued in confidence to the client and it will be strictly treated as such by the SHENZHEN TIMEWAY TESTING LABORATORIES. It may not be reproduced rather in its entirety or in part and it may not be used for adverting. The client to whom the report is issued may, however, show or send it . or a certified copy there of prepared by the SHENZHEN TIMEWAY TESTING LABORATORIES. to his customer. Supplier or others persons directly concerned. SHENZHEN TIMEWAY TESTING LABORATORIES. will not, without the consent of the client enter into any discussion of correspondence with any third party concerning the contents of the report.

In the event of the improper use of the report. The SHENZHEN TIMEWAY TESTING LABORATORIES. reserves the rights to withdraw it and to adopt any other remedies which may be appropriate.



9. Modulation Characteristics

9.1 PROVISIONS APPLICABLE

According to CFR 47 section 2.1047(a), for Voice Modulation Communication Equipment, the frequency response of the audio modulation circuit over a range of 100 to 5000Hz shall be measured.

9.2 MEASUREMENT METHOD

9.2.1 Modulation Limit

- (1). Configure the EUT as shown in figure 1, adjust the audio input for 60% of rated system deviation at 1kHz using this level as a reference (0dB) and vary the input level from -20 to +20dB. Record the frequency deviation obtained as a function of the input level.
- (2). Repeat step 1 with input frequency changing to 300, 1000, 1500 and 3000Hz in sequence.

9.2.2 Audio Frequency Response

- (1). The EUT and test equipment were set up as shown in figure 2.
- (2). Adjust the Modulation Analyzer for the following setting:
 - a) High-pass filter : off
 - b) Low-pass filter : 15 kHz
 - c) Detector : positive peak
 - d) Function : FM
- (3). The audio signal input was adjusted to obtain 20 % modulation at 1 kHz, and this point was taken as the 0 dB reference level.
- (4). With input levels held constant and below limiting at all frequencies, the audio signal generator was varied from 300 Hz to 5 kHz.
- (5). The response in dB relative to 1 kHz was then measured, using the Modulation Analyzer.

The report refers only to the sample tested and does not apply to the bulk.

This report is issued in confidence to the client and it will be strictly treated as such by the SHENZHEN TIMEWAY TESTING LABORATORIES. It may not be reproduced rather in its entirety or in part and it may not be used for advertising. The client to whom the report is issued may, however, show or send it, or a certified copy thereof prepared by the SHENZHEN TIMEWAY TESTING LABORATORIES, to his customer. Supplier or others persons directly concerned. SHENZHEN TIMEWAY TESTING LABORATORIES, will not, without the consent of the client enter into any discussion of correspondence with any third party concerning the contents of the report.

In the event of the improper use of the report. The SHENZHEN TIMEWAY TESTING LABORATORIES, reserves the rights to withdraw it and to adopt any other remedies which may be appropriate.

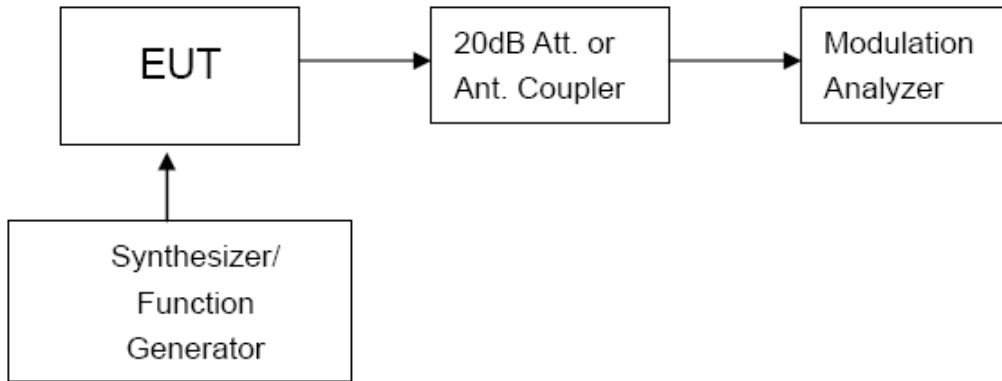

Figure 1: Modulation characteristic measurement configuration

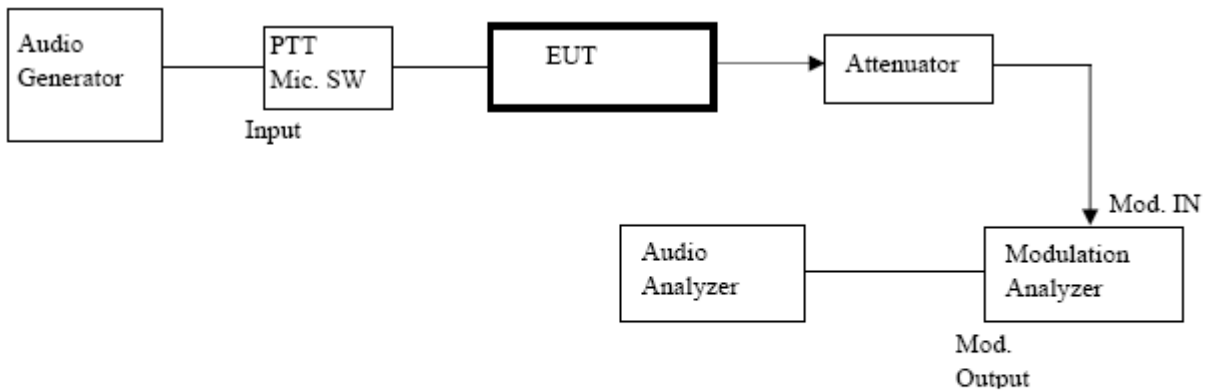

Figure 2: Audio Frequency Response Measurement Configure

The report refers only to the sample tested and does not apply to the bulk.

This report is issued in confidence to the client and it will be strictly treated as such by the SHENZHEN TIMEWAY TESTING LABORATORIES. It may not be reproduced rather in its entirety or in part and it may not be used for advertising. The client to whom the report is issued may, however, show or send it or a certified copy thereof prepared by the SHENZHEN TIMEWAY TESTING LABORATORIES to his customer. Supplier or others persons directly concerned. SHENZHEN TIMEWAY TESTING LABORATORIES will not, without the consent of the client enter into any discussion of correspondence with any third party concerning the contents of the report.

In the event of the improper use of the report. The SHENZHEN TIMEWAY TESTING LABORATORIES reserves the rights to withdraw it and to adopt any other remedies which may be appropriate.



9.4 MEASUREMENT RESULT

(a). Modulation Limit:

Middle channel (For UHF Band, 12.5 kHz Channel Bandwidth)

Modulation Level (dB)	Peak Freq. Deviation At 300 Hz	Peak Freq. Deviation At 1000 Hz	Peak Freq. Deviation At 1500 Hz	Peak Freq. Deviation At 3000 Hz
-20	0.08	0.25	0.3	0.37
-15	0.12	0.65	0.52	0.7
-10	0.16	0.82	0.67	0.95
-5	0.25	1.13	0.87	1.22
0	0.37	1.5	1.19	1.67
5	0.49	1.69	1.41	1.85
10	0.53	1.76	1.52	1.96
15	0.62	1.83	1.68	2.12
20	0.7	1.96	1.85	2.15

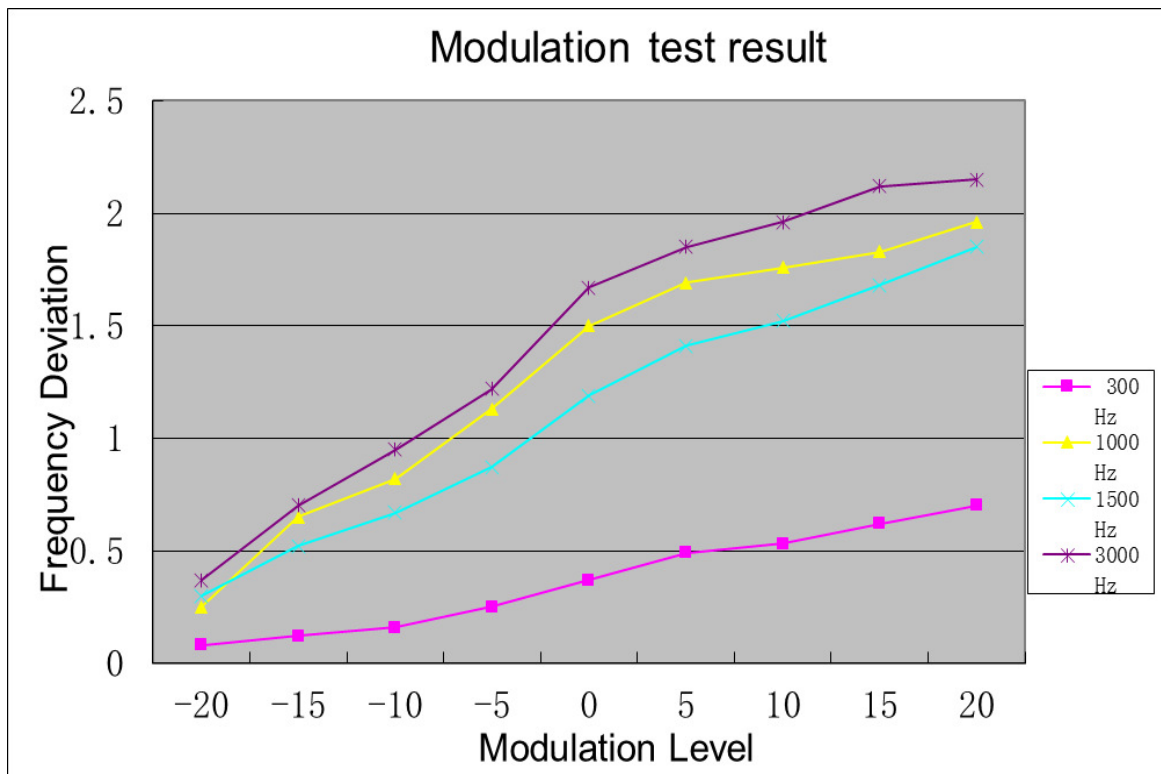

The report refers only to the sample tested and does not apply to the bulk.
 This report is issued in confidence to the client and it will be strictly treated as such by the SHENZHEN TIMEWAY TESTING LABORATORIES. It may not be reproduced rather in its entirety or in part and it may not be used for advertising. The client to whom the report is issued may, however, show or send it . or a certified copy there of prepared by the SHENZHEN TIMEWAY TESTING LABORATORIES. to his customer. Supplier or others persons directly concerned. SHENZHEN TIMEWAY TESTING LABORATORIES. will not, without the consent of the client enter into any discussion of correspondence with any third party concerning the contents of the report.
 In the event of the improper use of the report. The SHENZHEN TIMEWAY TESTING LABORATORIES. reserves the rights to withdraw it and to adopt any other remedies which may be appropriate.



(b). Audio Frequency Response:

For UHF Band, 12.5 kHz Channel Bandwidth

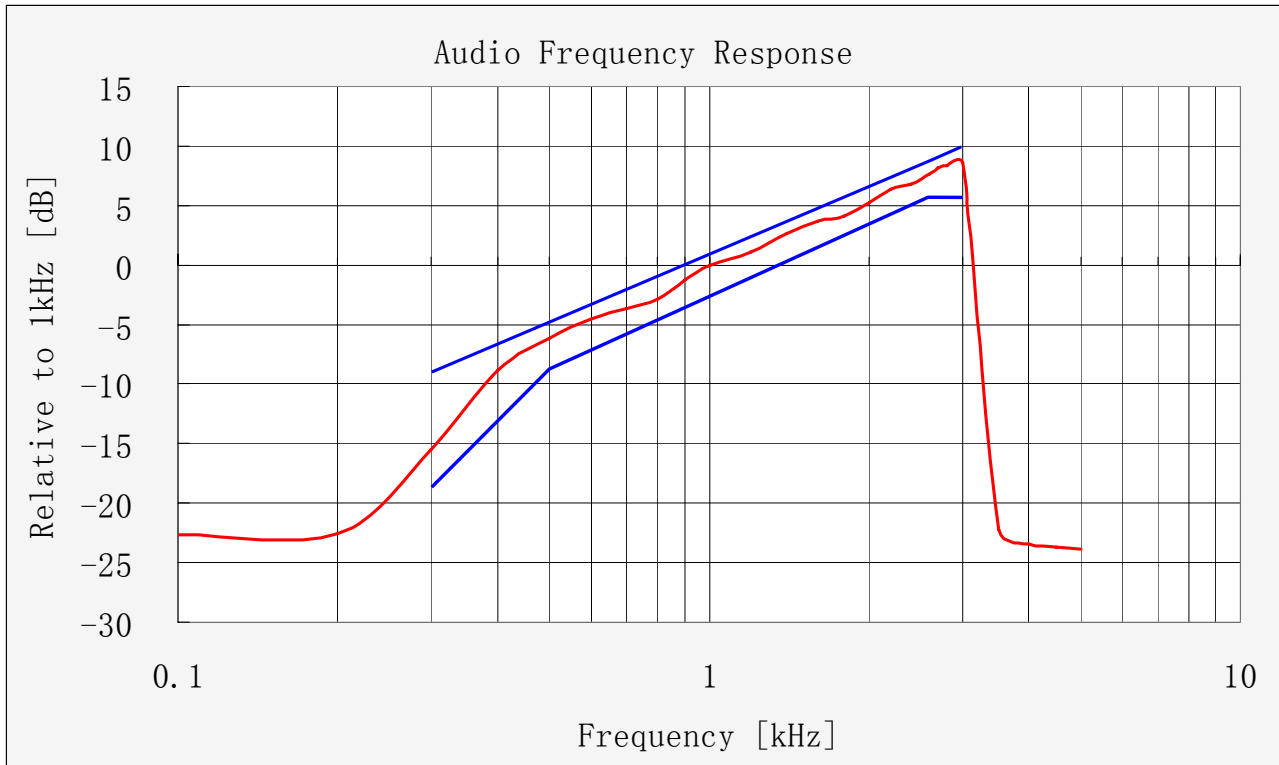

The report refers only to the sample tested and does not apply to the bulk.
This report is issued in confidence to the client and it will be strictly treated as such by the SHENZHEN TIMEWAY TESTING LABORATORIES. It may not be reproduced rather in its entirety or in part and it may not be used for advertising. The client to whom the report is issued may, however, show or send it or a certified copy thereof prepared by the SHENZHEN TIMEWAY TESTING LABORATORIES to his customer. Supplier or others persons directly concerned. SHENZHEN TIMEWAY TESTING LABORATORIES will not, without the consent of the client enter into any discussion of correspondence with any third party concerning the contents of the report.
In the event of the improper use of the report. The SHENZHEN TIMEWAY TESTING LABORATORIES reserves the rights to withdraw it and to adopt any other remedies which may be appropriate.



(a). Modulation Limit:

Middle channel (For UHF Band, 6.25 kHz Channel Bandwidth)

Modulation Level (dB)	Peak Freq. Deviation At 300 Hz	Peak Freq. Deviation At 1000 Hz	Peak Freq. Deviation At 1500 Hz	Peak Freq. Deviation At 3000 Hz
-20	0.05	0.12	0.16	0.23
-15	0.16	0.2	0.25	0.32
-10	0.23	0.27	0.33	0.46
-5	0.36	0.49	0.46	0.66
0	0.4	0.75	0.67	0.83
5	0.52	0.85	0.73	0.96
10	0.59	0.88	0.85	1.05
15	0.62	0.9	0.92	1.09
20	0.65	0.91	0.95	1.12

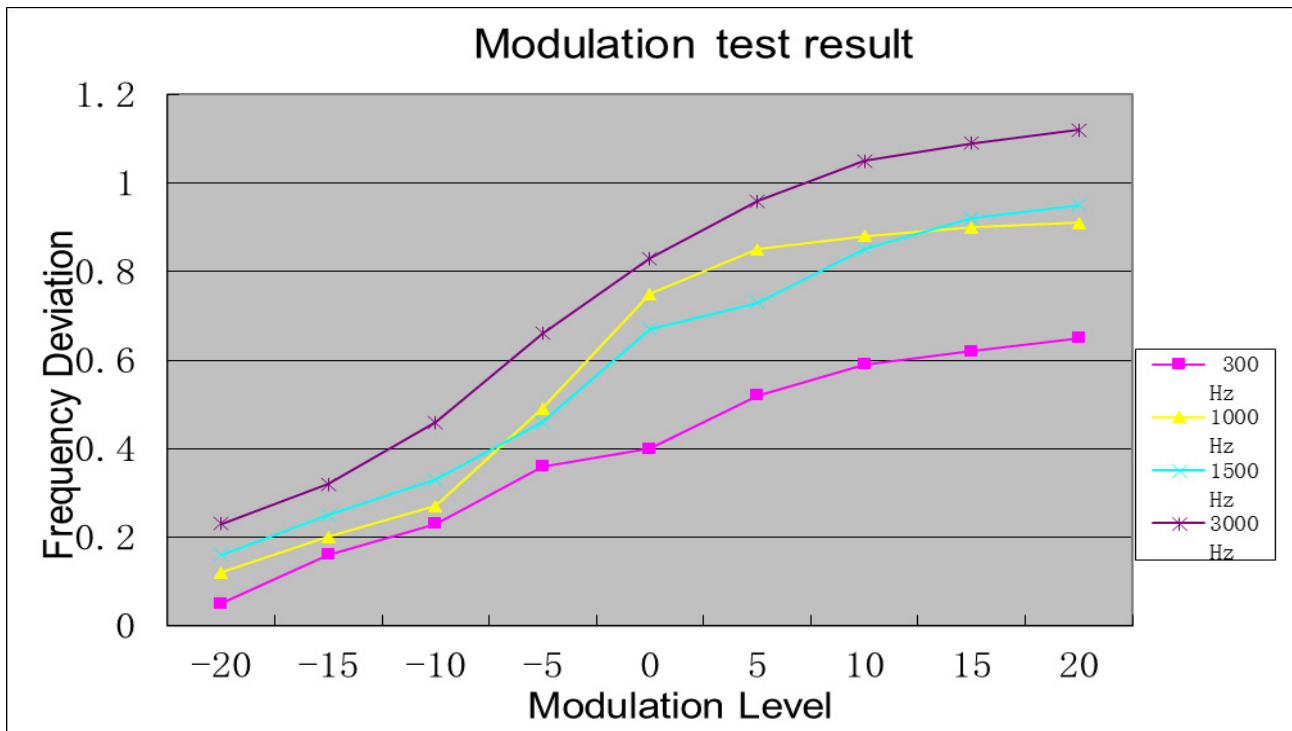

The report refers only to the sample tested and does not apply to the bulk.

This report is issued in confidence to the client and it will be strictly treated as such by the SHENZHEN TIMEWAY TESTING LABORATORIES. It may not be reproduced rather in its entirety or in part and it may not be used for advertising. The client to whom the report is issued may, however, show or send it or a certified copy thereof prepared by the SHENZHEN TIMEWAY TESTING LABORATORIES to his customer. Supplier or others persons directly concerned. SHENZHEN TIMEWAY TESTING LABORATORIES will not, without the consent of the client enter into any discussion of correspondence with any third party concerning the contents of the report.

In the event of the improper use of the report. The SHENZHEN TIMEWAY TESTING LABORATORIES reserves the rights to withdraw it and to adopt any other remedies which may be appropriate.



(b). Audio Frequency Response:

For UHF Band, 6.25 kHz Channel Bandwidth

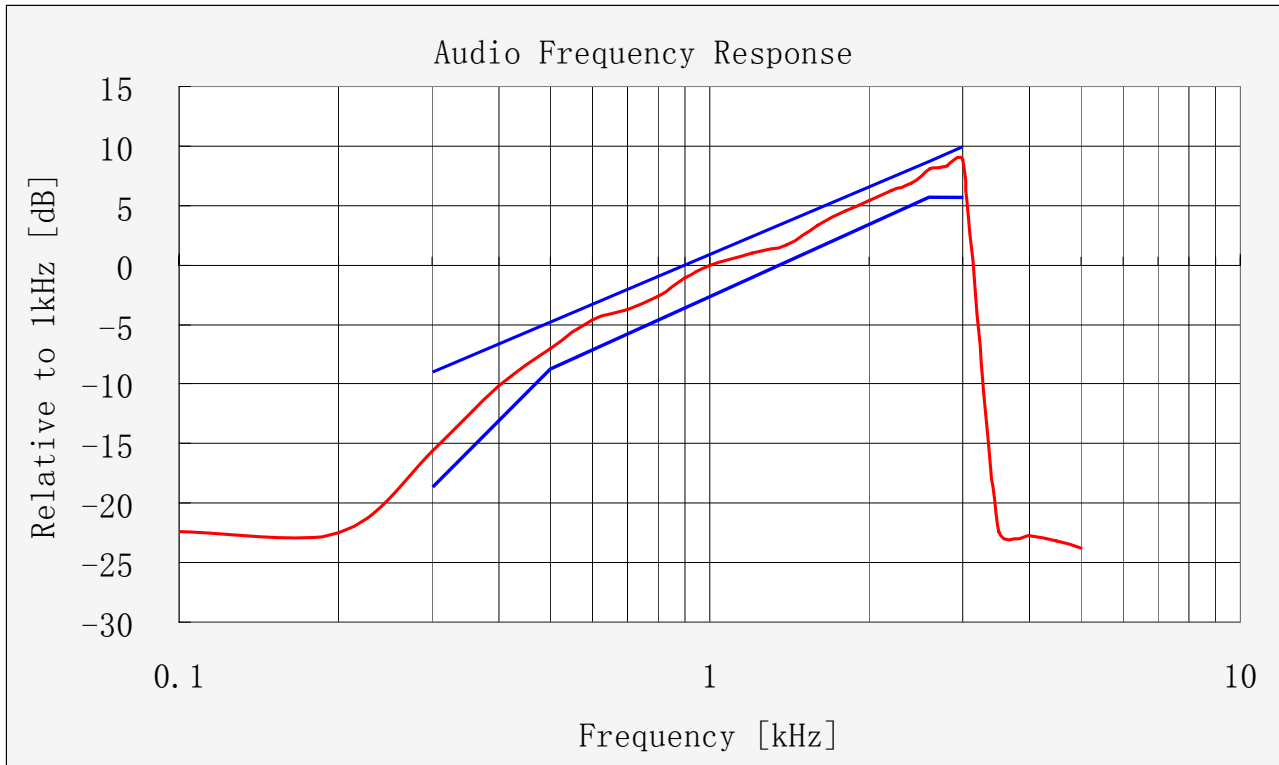

The report refers only to the sample tested and does not apply to the bulk.
This report is issued in confidence to the client and it will be strictly treated as such by the SHENZHEN TIMEWAY TESTING LABORATORIES. It may not be reproduced rather in its entirety or in part and it may not be used for advertising. The client to whom the report is issued may, however, show or send it or a certified copy thereof prepared by the SHENZHEN TIMEWAY TESTING LABORATORIES to his customer. Supplier or others persons directly concerned. SHENZHEN TIMEWAY TESTING LABORATORIES will not, without the consent of the client enter into any discussion of correspondence with any third party concerning the contents of the report.
In the event of the improper use of the report. The SHENZHEN TIMEWAY TESTING LABORATORIES reserves the rights to withdraw it and to adopt any other remedies which may be appropriate.



10. MAXIMUM TRANSMITTER POWER (CONDUCTED OUTPUT POWER)

10.1 PROVISIONS APPLICABLE

Per FCC §2.1046 and §90.205: Maximum ERP is dependent upon the station's antenna HAAT and required service area.

10.2 TEST PROCEDURE

The RF output of Two-way Radio was conducted to a spectrum analyzer through an appropriate attenuator.

Spectrum analyzer setting: RBW=10 kHz, VBW=30 kHz, PK detector

10.3 TEST RESULT

Calculation Formula: $CP = R + A + L$

* Note:

CP: The final Conducted Power

R : The reading value from spectrum analyzer

A : The attenuation value of the used attenuator

L : The loss of all connection cables

For 12.5 kHz Channel Bandwidth

Conducted Power Measurement Results		
Channel Separation	Channel	Measurement Result (dBm)
UHF Band	Bottom channel	35.87
	Middle Channel	36.08
	Top channel	35.50

Maximum ERP=34.82dBm

The report refers only to the sample tested and does not apply to the bulk.

This report is issued in confidence to the client and it will be strictly treated as such by the SHENZHEN TIMEWAY TESTING LABORATORIES. It may not be reproduced rather in its entirety or in part and it may not be used for advertising. The client to whom the report is issued may, however, show or send it or a certified copy thereof prepared by the SHENZHEN TIMEWAY TESTING LABORATORIES to his customer. Supplier or others persons directly concerned. SHENZHEN TIMEWAY TESTING LABORATORIES will not, without the consent of the client enter into any discussion of correspondence with any third party concerning the contents of the report.

In the event of the improper use of the report. The SHENZHEN TIMEWAY TESTING LABORATORIES reserves the rights to withdraw it and to adopt any other remedies which may be appropriate.



For 6.25 kHz Channel Spacing

Conducted Power Measurement Results		
Channel Separation	Channel	Measurement Result (dBm)
UHF Band	Bottom channel	35.73
	Middle Channel	35.99
	Top channel	35.41

Maximum ERP=34.70dBm

The report refers only to the sample tested and does not apply to the bulk.
This report is issued in confidence to the client and it will be strictly treated as such by the SHENZHEN TIMEWAY TESTING LABORATORIES. It may not be reproduced rather in its entirety or in part and it may not be used for advertizing. The client to whom the report is issued may, however, show or send it . or a certified copy there of prepared by the SHENZHEN TIMEWAY TESTING LABORATORIES. to his customer. Supplier or others persons directly concerned. SHENZHEN TIMEWAY TESTING LABORATORIES. will not, without the consent of the client enter into any discussion of correspondence with any third party concerning the contents of the report.
In the event of the improper use of the report. The SHENZHEN TIMEWAY TESTING LABORATORIES. reserves the rights to withdraw it and to adopt any other remedies which may be appropriate.



11. TRANSMITTER FREQUENCY BEHAVIOR

11.1 PROVISIONS APPLICABLE

Transmitters designed to operate in the 150–174 MHz and 421–512 MHz frequency bands must maintain transient frequencies within the maximum frequency difference limits during the time intervals indicated:

t_3 is the time period from the instant when the transmitter is turned off until t_{off} .

t_{off} is the instant when the 1 kHz test signal starts to rise.

² During the time from the end of t_2 to the beginning of t_3 , the frequency difference must not exceed the limits specified in § 90.213.

Time intervals ^{1,2}	Maximum frequency difference ³	All equipment	
		150 to 174 MHz	421 to 512 MHz

Transient Frequency Behavior for Equipment Designed to Operate on 25 kHz Channels

t_1 ⁴	±25.0 kHz	5.0 ms	10.0 ms
t_2	±12.5 kHz	20.0 ms	25.0 ms
t_3 ⁴	±25.0 kHz	5.0 ms	10.0 ms

Transient Frequency Behavior for Equipment Designed to Operate on 12.5 kHz Channels

t_1 ⁴	±12.5 kHz	5.0 ms	10.0 ms
t_2	±6.25 kHz	20.0 ms	25.0 ms
t_3 ⁴	±12.5 kHz	5.0 ms	10.0 ms

Transient Frequency Behavior for Equipment Designed to Operate on 6.25 kHz Channels

t_1 ⁴	±6.25 kHz	5.0 ms	10.0 ms
t_2	±3.125 kHz	20.0 ms	25.0 ms
t_3 ⁴	±6.25 kHz	5.0 ms	10.0 ms

¹ t_{on} is the instant when a 1 kHz test signal is completely suppressed, including any capture time due to phasing.

t_1 is the time period immediately following t_{on} .

t_2 is the time period immediately following t_1 .

The report refers only to the sample tested and does not apply to the bulk.

This report is issued in confidence to the client and it will be strictly treated as such by the SHENZHEN TIMEWAY TESTING LABORATORIES. It may not be reproduced in its entirety or in part and it may not be used for advertising. The client to whom the report is issued may, however, show or send it, or a certified copy thereof prepared by the SHENZHEN TIMEWAY TESTING LABORATORIES, to his customer. Supplier or others persons directly concerned. SHENZHEN TIMEWAY TESTING LABORATORIES, will not, without the consent of the client enter into any discussion of correspondence with any third party concerning the contents of the report.

In the event of the improper use of the report, the SHENZHEN TIMEWAY TESTING LABORATORIES, reserves the rights to withdraw it and to adopt any other remedies which may be appropriate.



t_3 is the time period from the instant when the transmitter is turned off until t_{off} .

t_{off} is the instant when the 1 kHz test signal starts to rise.

² During the time from the end of t_2 to the beginning of t_3 , the frequency difference must not exceed the limits specified in § 90.213.

³ Difference between the actual transmitter frequency and the assigned transmitter frequency.

⁴ If the transmitter carrier output power rating is 6 watts or less, the frequency difference during this time period may exceed the maximum frequency difference for this time period.

11.2 Test Method

TIA-603-D-2010

11.3 Test setup Block Diagram

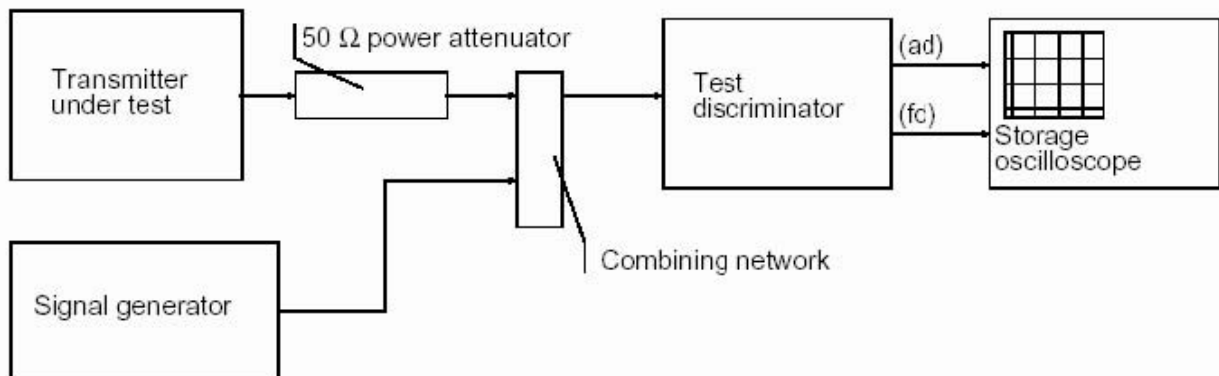

11.4 MEASURE RESULT

The report refers only to the sample tested and does not apply to the bulk.

This report is issued in confidence to the client and it will be strictly treated as such by the SHENZHEN TIMEWAY TESTING LABORATORIES. It may not be reproduced rather in its entirety or in part and it may not be used for advertising. The client to whom the report is issued may, however, show or send it or a certified copy thereof prepared by the SHENZHEN TIMEWAY TESTING LABORATORIES to his customer. Supplier or others persons directly concerned. SHENZHEN TIMEWAY TESTING LABORATORIES will not, without the consent of the client enter into any discussion of correspondence with any third party concerning the contents of the report.

In the event of the improper use of the report. The SHENZHEN TIMEWAY TESTING LABORATORIES reserves the rights to withdraw it and to adopt any other remedies which may be appropriate.



Transmitter Frequency Behaviour @ 12.5 kHz Channel Bandwidth--Off to On at UHF Band

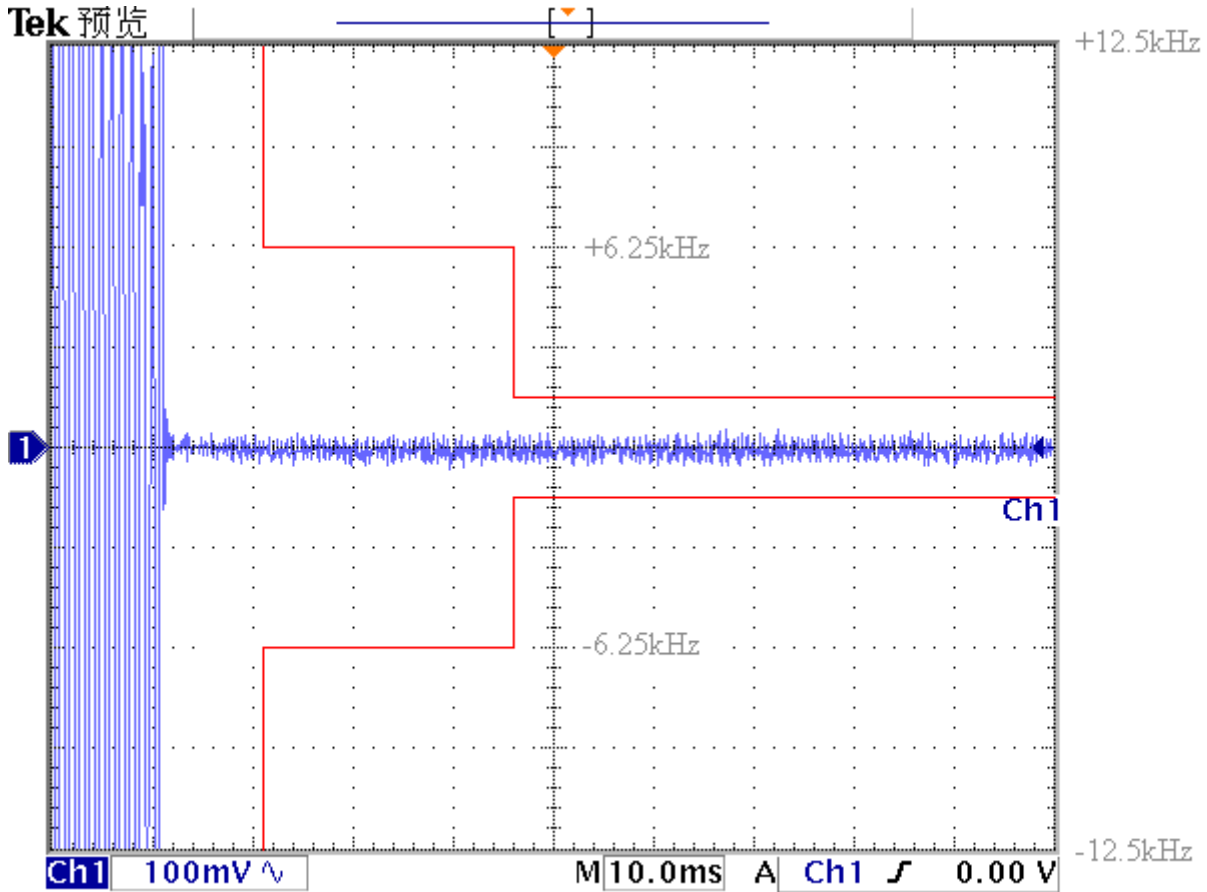

The report refers only to the sample tested and does not apply to the bulk.

This report is issued in confidence to the client and it will be strictly treated as such by the SHENZHEN TIMEWAY TESTING LABORATORIES. It may not be reproduced in its entirety or in part and it may not be used for advertising. The client to whom the report is issued may, however, show or send it, or a certified copy thereof prepared by the SHENZHEN TIMEWAY TESTING LABORATORIES, to his customer, supplier or other persons directly concerned. SHENZHEN TIMEWAY TESTING LABORATORIES will not, without the consent of the client enter into any discussion of correspondence with any third party concerning the contents of the report.

In the event of the improper use of the report, the SHENZHEN TIMEWAY TESTING LABORATORIES reserves the rights to withdraw it and to adopt any other remedies which may be appropriate.



Transmitter Frequency Behaviour @ 12.5 kHz Channel Bandwidth—On to Off at UHF Band

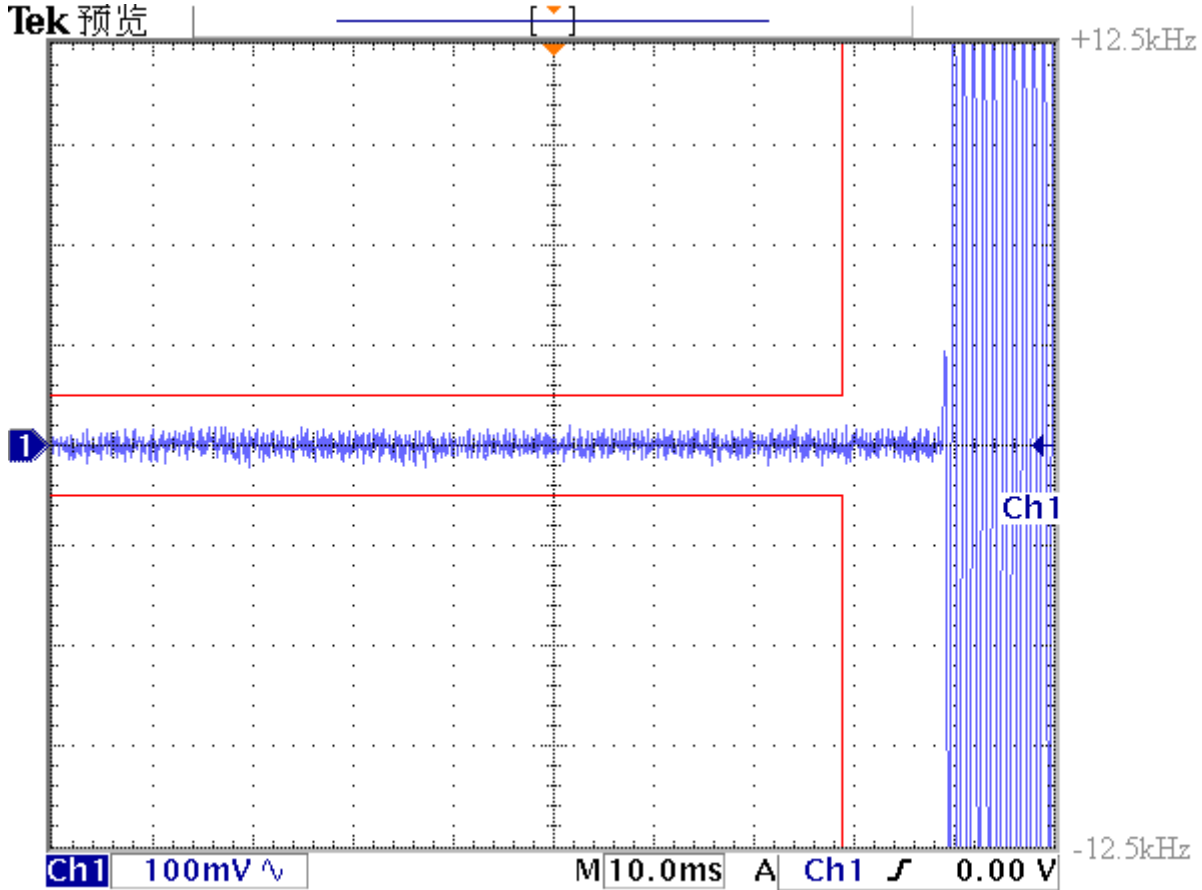

The report refers only to the sample tested and does not apply to the bulk.

This report is issued in confidence to the client and it will be strictly treated as such by the SHENZHEN TIMEWAY TESTING LABORATORIES. It may not be reproduced rather in its entirety or in part and it may not be used for advertising. The client to whom the report is issued may, however, show or send it . or a certified copy there of prepared by the SHENZHEN TIMEWAY TESTING LABORATORIES. to his customer. Supplier or others persons directly concerned. SHENZHEN TIMEWAY TESTING LABORATORIES. will not, without the consent of the client enter into any discussion of correspondence with any third party concerning the contents of the report.

In the event of the improper use of the report. The SHENZHEN TIMEWAY TESTING LABORATORIES. reserves the rights to withdraw it and to adopt any other remedies which may be appropriate.



Transmitter Frequency Behaviour @ 6.25 kHz Channel Bandwidth --Off to On at UHF Band

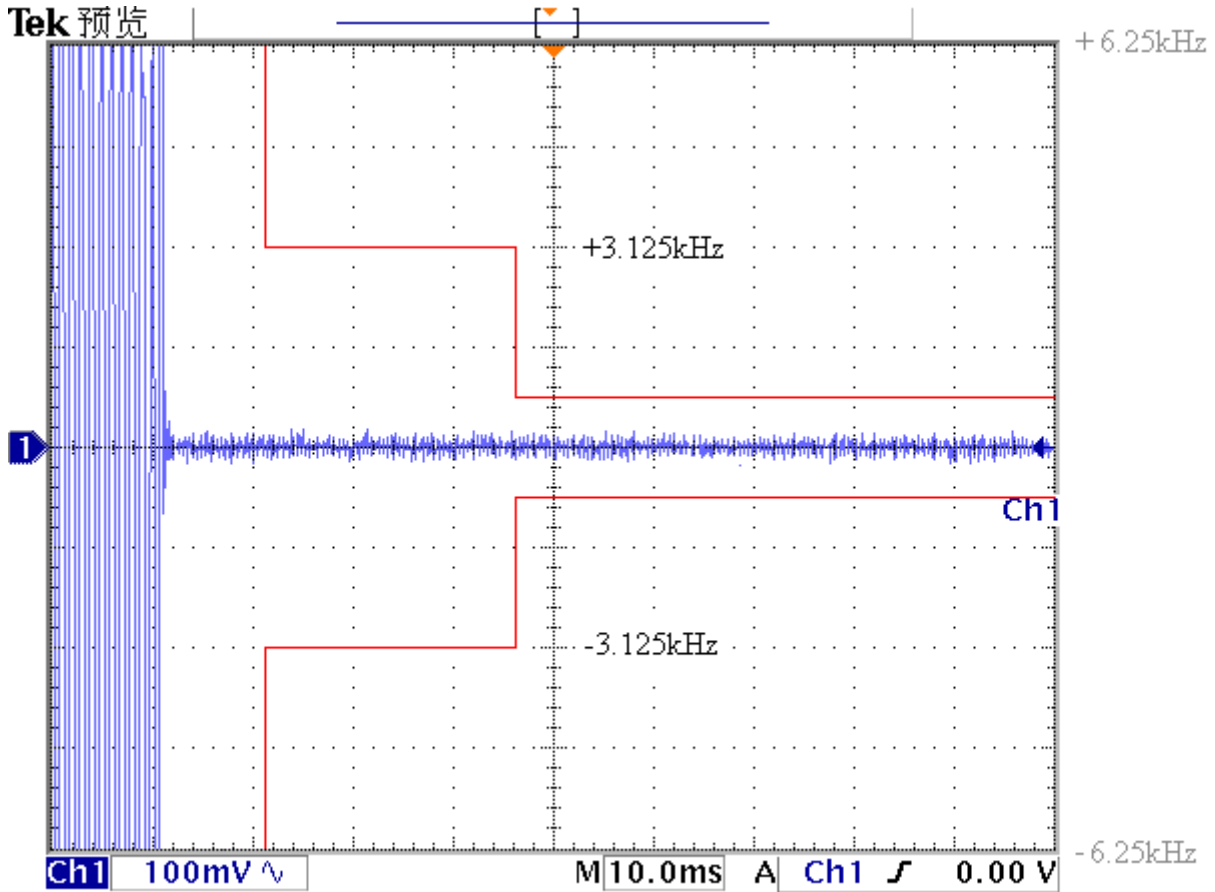

The report refers only to the sample tested and does not apply to the bulk.

This report is issued in confidence to the client and it will be strictly treated as such by the SHENZHEN TIMEWAY TESTING LABORATORIES. It may not be reproduced rather in its entirety or in part and it may not be used for advertising. The client to whom the report is issued may, however, show or send it, or a certified copy thereof prepared by the SHENZHEN TIMEWAY TESTING LABORATORIES, to his customer. Supplier or others persons directly concerned. SHENZHEN TIMEWAY TESTING LABORATORIES, will not, without the consent of the client enter into any discussion of correspondence with any third party concerning the contents of the report.

In the event of the improper use of the report. The SHENZHEN TIMEWAY TESTING LABORATORIES, reserves the rights to withdraw it and to adopt any other remedies which may be appropriate.



Transmitter Frequency Behaviour @ 6.25 kHz Channel Bandwidth—On to Off at UHF Band

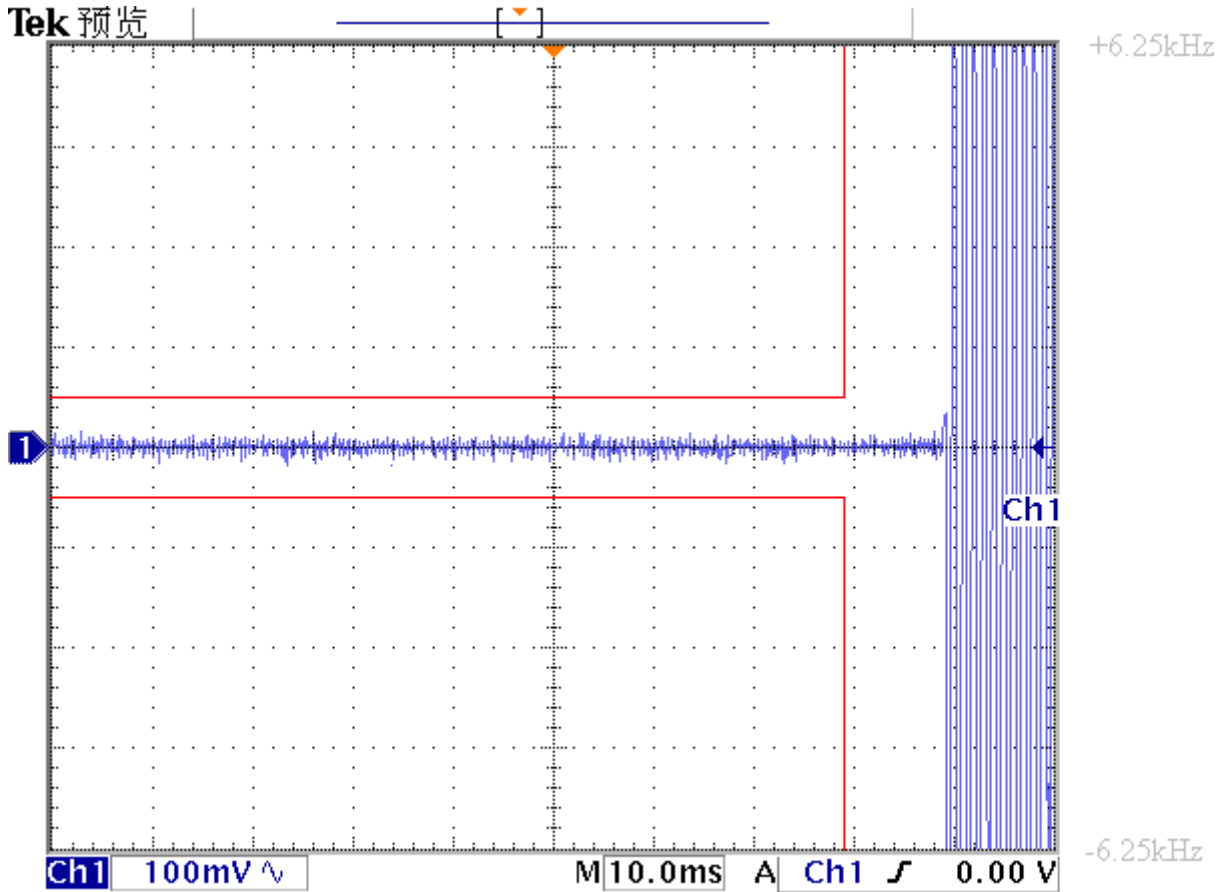

The report refers only to the sample tested and does not apply to the bulk.
This report is issued in confidence to the client and it will be strictly treated as such by the SHENZHEN TIMEWAY TESTING LABORATORIES. It may not be reproduced rather in its entirety or in part and it may not be used for advertising. The client to whom the report is issued may, however, show or send it . or a certified copy there of prepared by the SHENZHEN TIMEWAY TESTING LABORATORIES. to his customer. Supplier or others persons directly concerned. SHENZHEN TIMEWAY TESTING LABORATORIES. will not, without the consent of the client enter into any discussion of correspondence with any third party concerning the contents of the report.
In the event of the improper use of the report. The SHENZHEN TIMEWAY TESTING LABORATORIES. reserves the rights to withdraw it and to adopt any other remedies which may be appropriate.



12.0 Adjacent channel power

12.1 Provisions Applicable

(b)(1) Maximum adjacent power levels for frequencies in the 450-470 MHz band:

Frequency offset	Maximum ACP (dBc) for devices 1 watt and less	Maximum ACP (dBc) for devices above 1 watt
25 kHz	-55 dBc	-60 dBc
50 kHz	-70 dBc	-70 dBc
75 kHz	-70 dBc	-70 dBc

(2) In any case, no requirement in excess of -36 dBm shall apply.

(d) On any frequency removed from the assigned frequency by more than 75 kHz, the attenuation of any emission must be at least $43 + 10 \log (P_{\text{watts}})$ dB.

12.1 Test Result

For 12.5 kHz Channel Bandwidth

Test Condition		Measurement Offset	Adjacent Channel Power (dBc)
Temperature (°C)	Voltage(V)		
T Nor (25°C)	V Nor (7.4V)	+25kHz	-68.55
		-25kHz	-68.71
Applicable Limit		60dB down or -36dBm	
Result		Pass	

Test Condition		Measurement Offset	Adjacent Channel Power (dBc)
Temperature (°C)	Voltage(V)		
T Nor (25°C)	V Nor (7.4V)	+50kHz	-76.28
		-50kHz	-76.39
Applicable Limit		60dB down or -36dBm	
Result		Pass	

The report refers only to the sample tested and does not apply to the bulk.

This report is issued in confidence to the client and it will be strictly treated as such by the SHENZHEN TIMEWAY TESTING LABORATORIES. It may not be reproduced rather in its entirety or in part and it may not be used for advertising. The client to whom the report is issued may, however, show or send it or a certified copy thereof prepared by the SHENZHEN TIMEWAY TESTING LABORATORIES to his customer. Supplier or others persons directly concerned. SHENZHEN TIMEWAY TESTING LABORATORIES will not, without the consent of the client enter into any discussion of correspondence with any third party concerning the contents of the report. In the event of the improper use of the report. The SHENZHEN TIMEWAY TESTING LABORATORIES reserves the rights to withdraw it and to adopt any other remedies which may be appropriate.



Test Condition		Measurement Offset	Adjacent Channel Power (dBc)
Temperature (°C)	Voltage(V)		
T Nor (25°C)	V Nor (7.4V)	+50kHz	-77.22
		-50kHz	-77.35
Applicable Limit		60dB down or -36dBm	
Result		Pass	

For 6.25 kHz Channel Bandwidth

Test Condition		Measurement Offset	Adjacent Channel Power (dBc)
Temperature (°C)	Voltage(V)		
T Nor (25°C)	V Nor (7.4V)	+25kHz	-73.58
		-25kHz	-73.65
Applicable Limit		60dB down or -36dBm	
Result		Pass	

Test Condition		Measurement Offset	Adjacent Channel Power (dBc)
Temperature (°C)	Voltage(V)		
T Nor (25°C)	V Nor (7.4V)	+50kHz	-77.83
		-50kHz	-78.02
Applicable Limit		60dB down or -36dBm	
Result		Pass	

The report refers only to the sample tested and does not apply to the bulk.
 This report is issued in confidence to the client and it will be strictly treated as such by the SHENZHEN TIMEWAY TESTING LABORATORIES. It may not be reproduced rather in its entirety or in part and it may not be used for advertising. The client to whom the report is issued may, however, show or send it . or a certified copy there of prepared by the SHENZHEN TIMEWAY TESTING LABORATORIES. to his customer. Supplier or others persons directly concerned. SHENZHEN TIMEWAY TESTING LABORATORIES. will not, without the consent of the client enter into any discussion of correspondence with any third party concerning the contents of the report.
 In the event of the improper use of the report. The SHENZHEN TIMEWAY TESTING LABORATORIES. reserves the rights to withdraw it and to adopt any other remedies which may be appropriate.



Test Condition		Measurement Offset	Adjacent Channel Power (dBc)
Temperature (°C)	Voltage(V)		
T Nor (25°C)	V Nor (7.4V)	+50kHz	-78.35
		-50kHz	-78.39
Applicable Limit		60dB down or -36dBm	
Result		Pass	

For 12.5 kHz Channel Bandwidth

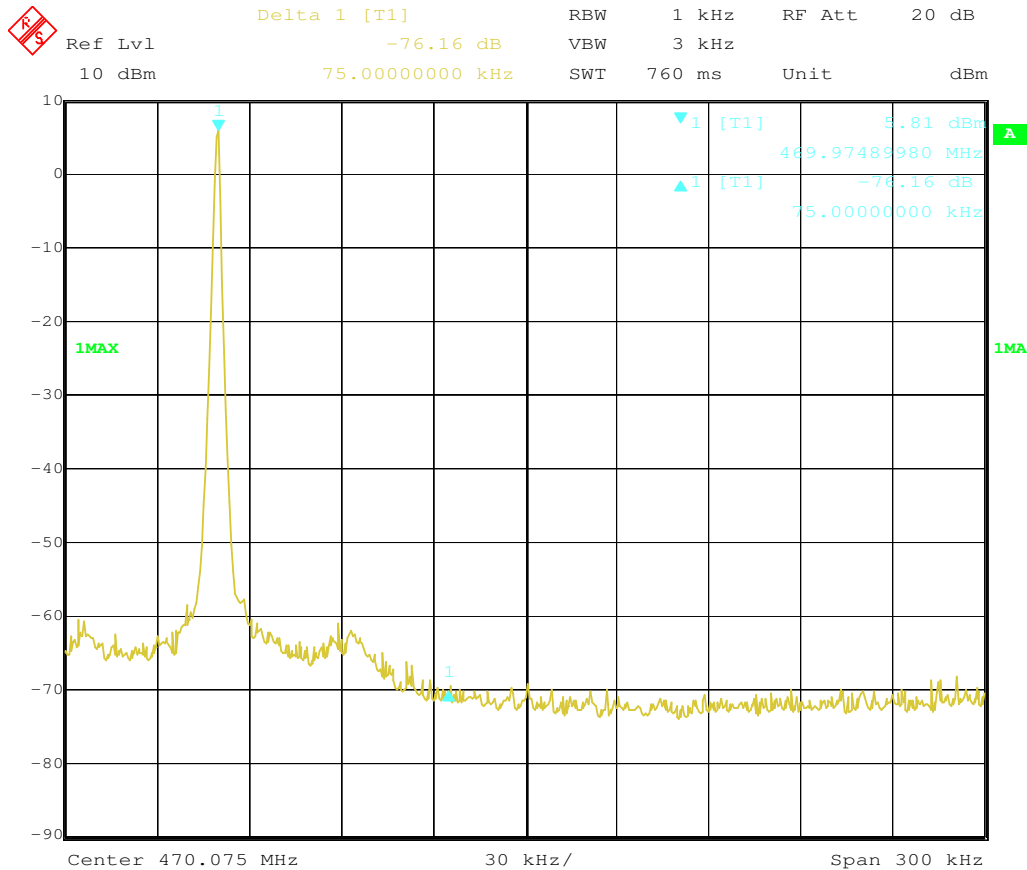

Note: From the above plot, the attenuation is at least $43 + 10 \log(\text{Pwatts})$ dB

The report refers only to the sample tested and does not apply to the bulk.
 This report is issued in confidence to the client and it will be strictly treated as such by the SHENZHEN TIMEWAY TESTING LABORATORIES. It may not be reproduced rather in its entirety or in part and it may not be used for adverting. The client to whom the report is issued may, however, show or send it . or a certified copy there of prepared by the SHENZHEN TIMEWAY TESTING LABORATORIES. to his customer. Supplier or others persons directly concerned. SHENZHEN TIMEWAY TESTING LABORATORIES. will not, without the consent of the client enter into any discussion of correspondence with any third party concerning the contents of the report.
 In the event of the improper use of the report. The SHENZHEN TIMEWAY TESTING LABORATORIES. reserves the rights to withdraw it and to adopt any other remedies which may be appropriate.



For 6.25 kHz Channel Bandwidth

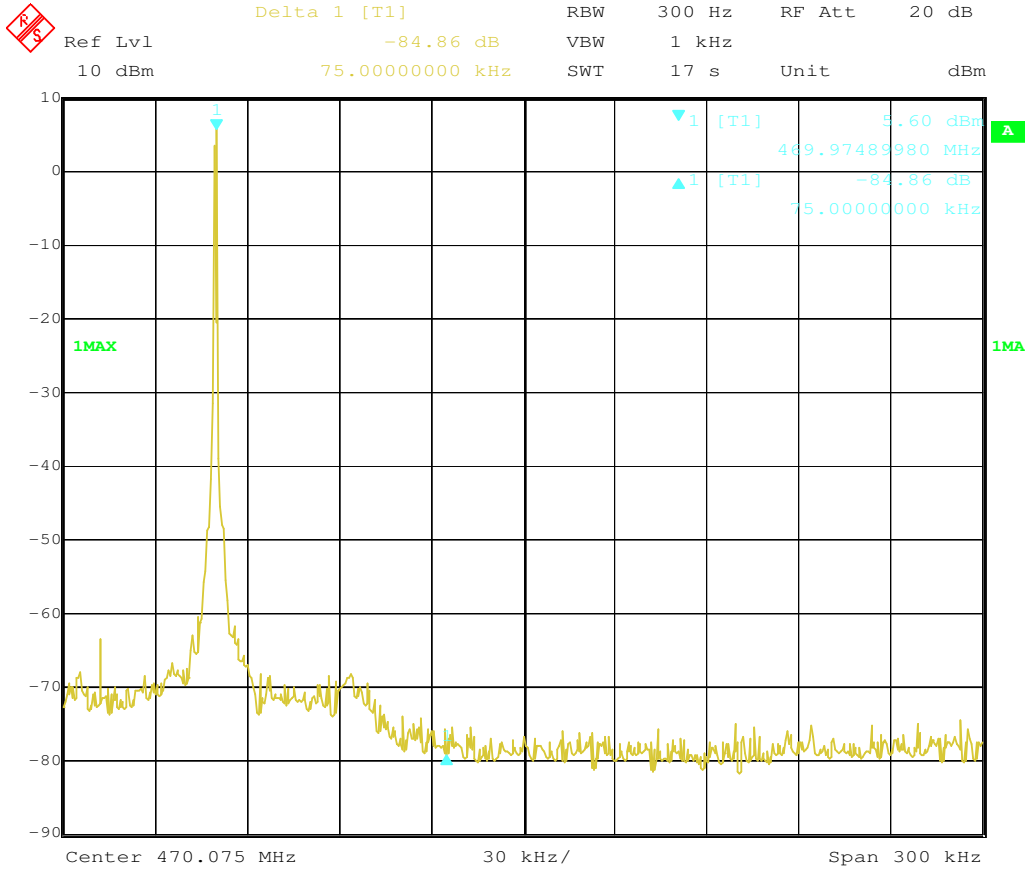

Note: From the above plot, the attenuation is at least $43 + 10 \log(\text{Pwatts})$ dB

The report refers only to the sample tested and does not apply to the bulk.
 This report is issued in confidence to the client and it will be strictly treated as such by the SHENZHEN TIMEWAY TESTING LABORATORIES. It may not be reproduced rather in its entirety or in part and it may not be used for adverting. The client to whom the report is issued may, however, show or send it . or a certified copy there of prepared by the SHENZHEN TIMEWAY TESTING LABORATORIES. to his customer. Supplier or others persons directly concerned. SHENZHEN TIMEWAY TESTING LABORATORIES. will not, without the consent of the client enter into any discussion of correspondence with any third party concerning the contents of the report.
 In the event of the improper use of the report. The SHENZHEN TIMEWAY TESTING LABORATORIES. reserves the rights to withdraw it and to adopt any other remedies which may be appropriate.



13. Radiated Emission on Receiving Mode

13.1 Provisions Applicable

FCC Part 15 Subpart B Section 15.109

13.2 TEST METHOD

ANSI C 63.4: 2014

13.4 MEASURE RESULT (MEASURED AT 3M USING FCC PART15 B LIMITS)

The report refers only to the sample tested and does not apply to the bulk.

This report is issued in confidence to the client and it will be strictly treated as such by the SHENZHEN TIMEWAY TESTING LABORATORIES. It may not be reproduced rather in its entirety or in part and it may not be used for advertising. The client to whom the report is issued may, however, show or send it or a certified copy thereof prepared by the SHENZHEN TIMEWAY TESTING LABORATORIES to his customer. Supplier or others persons directly concerned. SHENZHEN TIMEWAY TESTING LABORATORIES will not, without the consent of the client enter into any discussion of correspondence with any third party concerning the contents of the report.

In the event of the improper use of the report. The SHENZHEN TIMEWAY TESTING LABORATORIES reserves the rights to withdraw it and to adopt any other remedies which may be appropriate.



Radiated Emission In Horizontal (30MHz----1000MHz)

EUT set Condition: Charging and Receiving

Results: Pass

Please refer to following diagram for individual

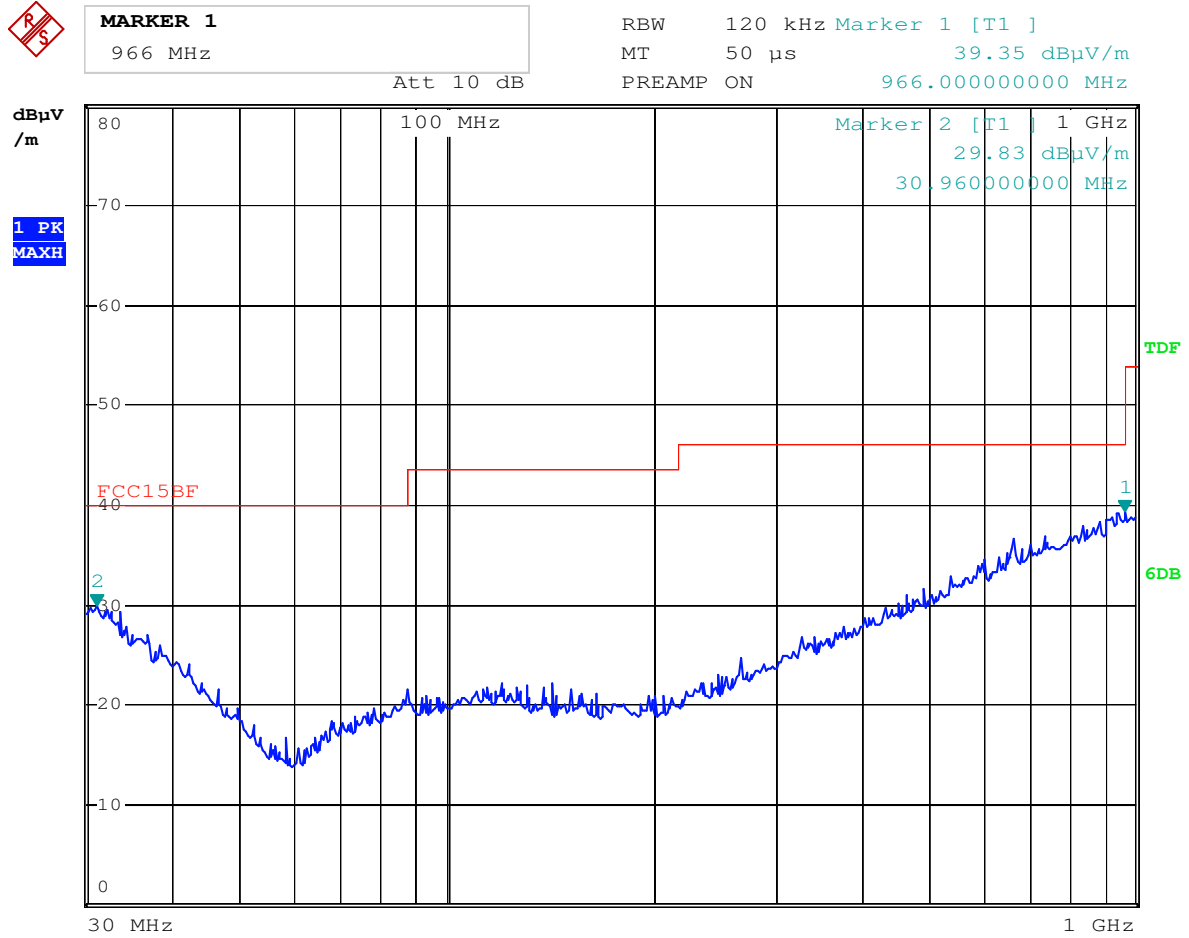

Frequency (MHz)	Level@3m (dB μ V/m)	Antenna Polarity	Limit@3m (dB μ V/m)
966.000	39.35	H	54.00
30.960	29.83	H	40.00

The report refers only to the sample tested and does not apply to the bulk.
 This report is issued in confidence to the client and it will be strictly treated as such by the SHENZHEN TIMEWAY TESTING LABORATORIES. It may not be reproduced rather in its entirety or in part and it may not be used for adverting. The client to whom the report is issued may, however, show or send it . or a certified copy there of prepared by the SHENZHEN TIMEWAY TESTING LABORATORIES. to his customer. Supplier or others persons directly concerned. SHENZHEN TIMEWAY TESTING LABORATORIES. will not, without the consent of the client enter into any discussion of correspondence with any third party concerning the contents of the report.
 In the event of the improper use of the report. The SHENZHEN TIMEWAY TESTING LABORATORIES. reserves the rights to withdraw it and to adopt any other remedies which may be appropriate.



Radiated Emission In Vertical (30MHz----1000MHz)

EUT set Condition: Charging and Receiving

Results: Pass

Please refer to following diagram for individual

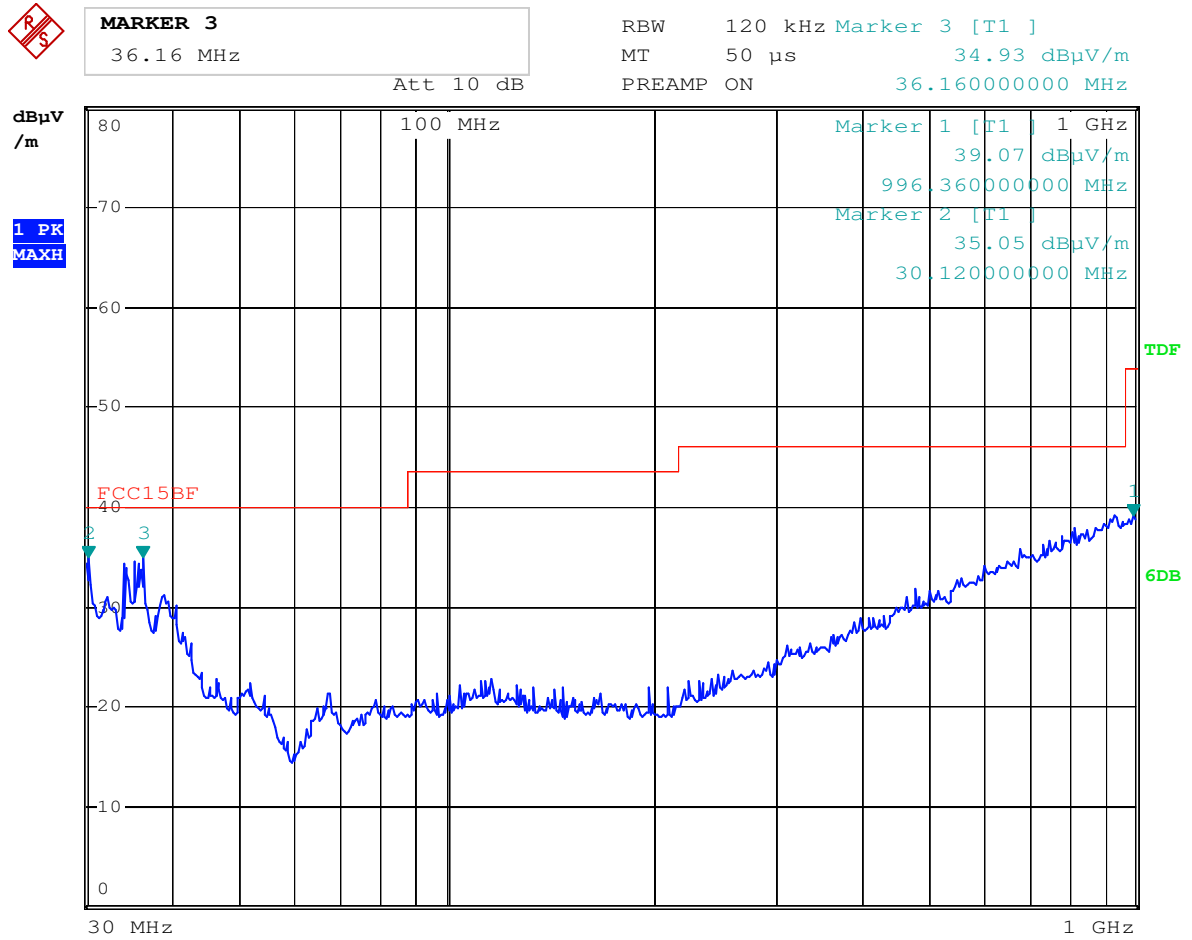

Frequency (MHz)	Level@3m (dB µ V/m)	Antenna Polarity	Limit@3m (dB µ V/m)
36.160	34.93	V	40.00
996.360	39.07	V	54.00
30.120	35.05	V	40.00

The report refers only to the sample tested and does not apply to the bulk.
 This report is issued in confidence to the client and it will be strictly treated as such by the SHENZHEN TIMEWAY TESTING LABORATORIES. It may not be reproduced rather in its entirety or in part and it may not be used for adverting. The client to whom the report is issued may, however, show or send it . or a certified copy there of prepared by the SHENZHEN TIMEWAY TESTING LABORATORIES. to his customer. Supplier or others persons directly concerned. SHENZHEN TIMEWAY TESTING LABORATORIES. will not, without the consent of the client enter into any discussion of correspondence with any third party concerning the contents of the report.
 In the event of the improper use of the report. The SHENZHEN TIMEWAY TESTING LABORATORIES. reserves the rights to withdraw it and to adopt any other remedies which may be appropriate.



14.0 FCC ID Label

FCC ID: 2AIOQ-FPBN10A

The label must not be a stick-on paper label. The label on these products must be permanently affixed to the product and readily visible at the time of purchase and must last the expected lifetime of the equipment not be readily detachable.

Mark Location:

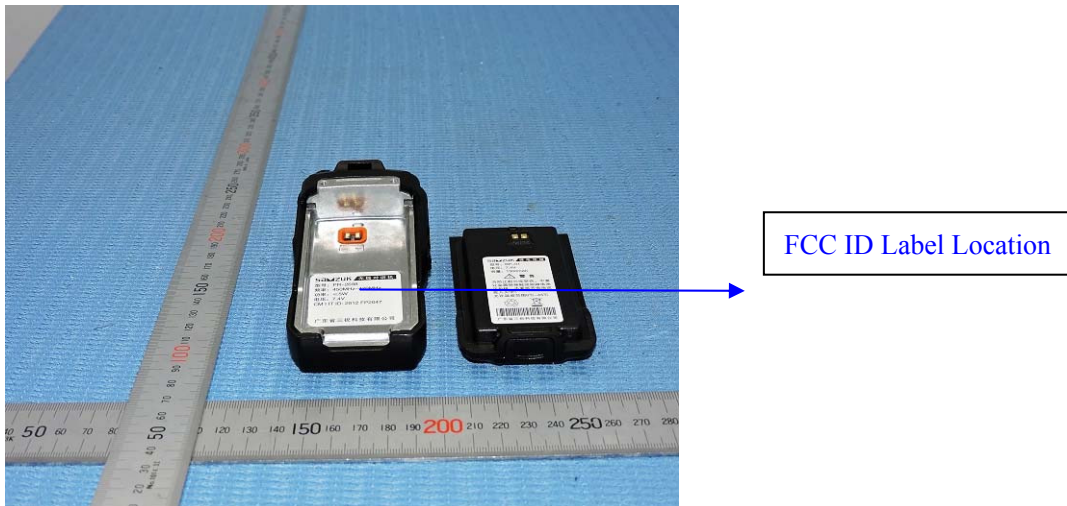

The report refers only to the sample tested and does not apply to the bulk.

This report is issued in confidence to the client and it will be strictly treated as such by the SHENZHEN TIMEWAY TESTING LABORATORIES. It may not be reproduced rather in its entirety or in part and it may not be used for advertising. The client to whom the report is issued may, however, show or send it . or a certified copy there of prepared by the SHENZHEN TIMEWAY TESTING LABORATORIES. to his customer. Supplier or others persons directly concerned. SHENZHEN TIMEWAY TESTING LABORATORIES. will not, without the consent of the client enter into any discussion of correspondence with any third party concerning the contents of the report. In the event of the improper use of the report. The SHENZHEN TIMEWAY TESTING LABORATORIES. reserves the rights to withdraw it and to adopt any other remedies which may be appropriate.



15.0 Photo of testing

15.1 Conducted test View--



The report refers only to the sample tested and does not apply to the bulk.

This report is issued in confidence to the client and it will be strictly treated as such by the SHENZHEN TIMEWAY TESTING LABORATORIES. It may not be reproduced rather in its entirety or in part and it may not be used for advertising. The client to whom the report is issued may, however, show or send it . or a certified copy there of prepared by the SHENZHEN TIMEWAY TESTING LABORATORIES. to his customer. Supplier or others persons directly concerned. SHENZHEN TIMEWAY TESTING LABORATORIES. will not, without the consent of the client enter into any discussion of correspondence with any third party concerning the contents of the report. In the event of the improper use of the report. The SHENZHEN TIMEWAY TESTING LABORATORIES. reserves the rights to withdraw it and to adopt any other remedies which may be appropriate.



15.2 Spurious Radiated emission test view

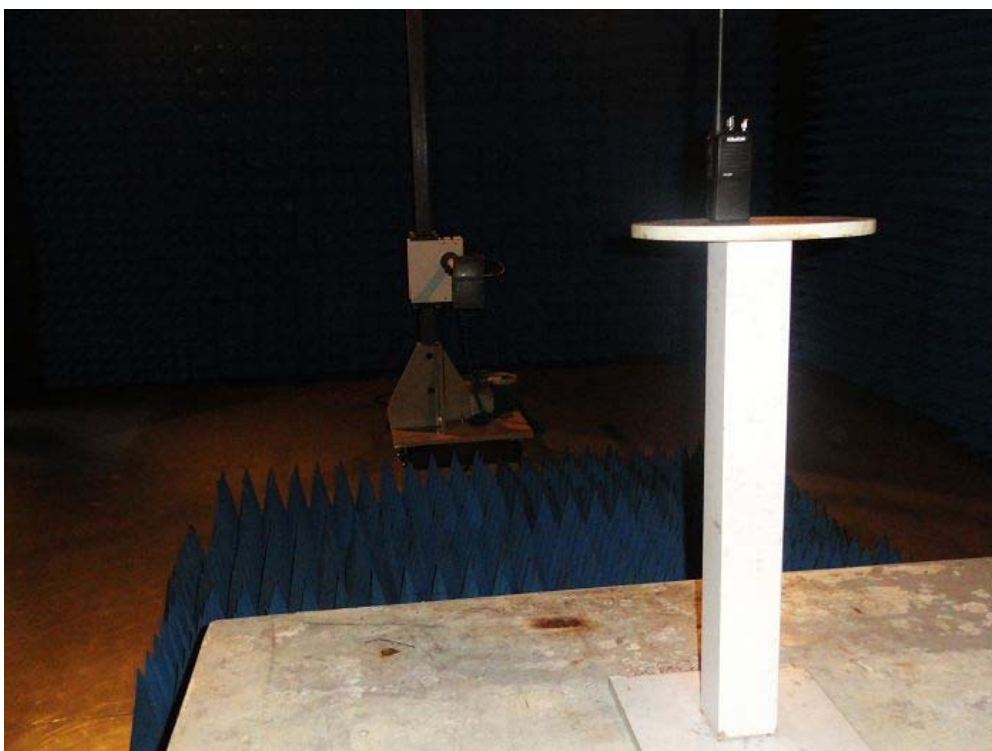

The report refers only to the sample tested and does not apply to the bulk.
This report is issued in confidence to the client and it will be strictly treated as such by the SHENZHEN TIMEWAY TESTING LABORATORIES. It may not be reproduced rather in its entirety or in part and it may not be used for adverting. The client to whom the report is issued may, however, show or send it . or a certified copy there of prepared by the SHENZHEN TIMEWAY TESTING LABORATORIES. to his customer. Supplier or others persons directly concerned. SHENZHEN TIMEWAY TESTING LABORATORIES. will not, without the consent of the client enter into any discussion of correspondence with any third party concerning the contents of the report.
In the event of the improper use of the report. The SHENZHEN TIMEWAY TESTING LABORATORIES. reserves the rights to withdraw it and to adopt any other remedies which may be appropriate.



15.2 Radiated emission test view

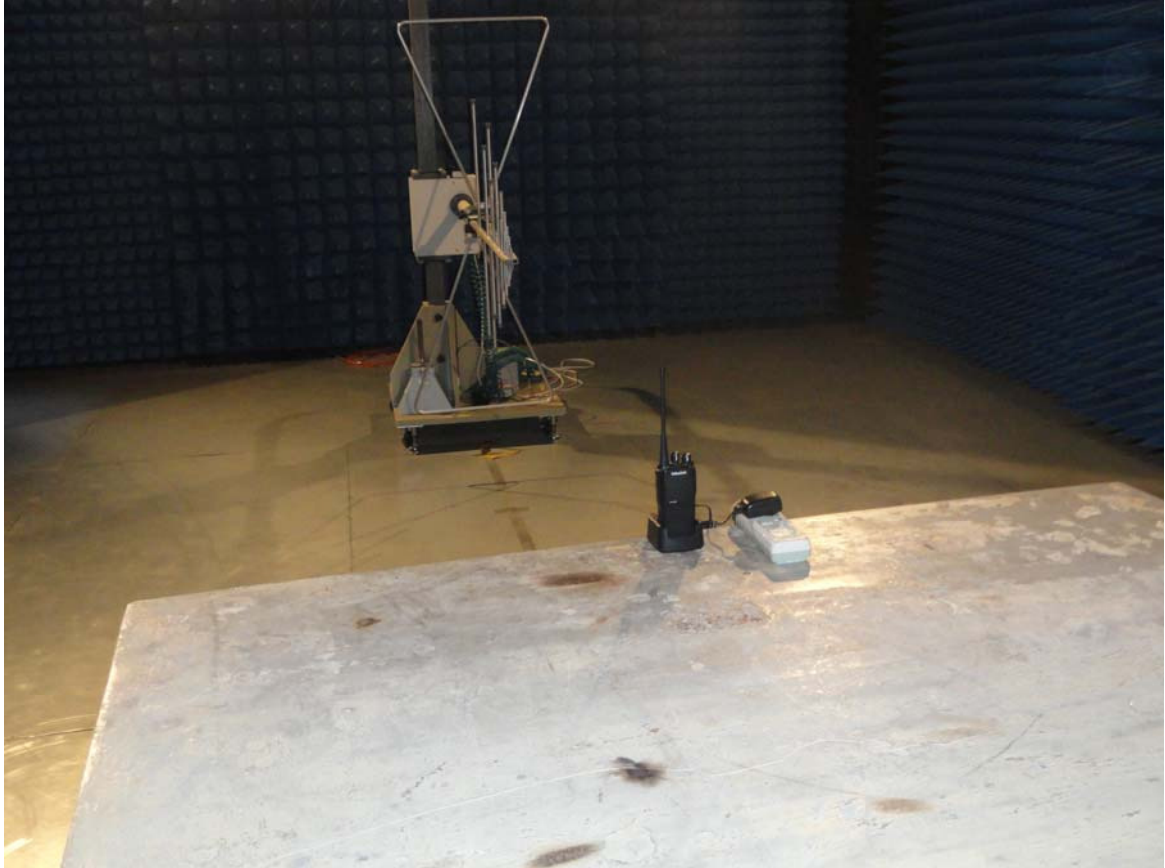

The report refers only to the sample tested and does not apply to the bulk.

This report is issued in confidence to the client and it will be strictly treated as such by the SHENZHEN TIMEWAY TESTING LABORATORIES. It may not be reproduced rather in its entirety or in part and it may not be used for advertising. The client to whom the report is issued may, however, show or send it . or a certified copy there of prepared by the SHENZHEN TIMEWAY TESTING LABORATORIES. to his customer. Supplier or others persons directly concerned. SHENZHEN TIMEWAY TESTING LABORATORIES. will not, without the consent of the client enter into any discussion of correspondence with any third party concerning the contents of the report. In the event of the improper use of the report. The SHENZHEN TIMEWAY TESTING LABORATORIES. reserves the rights to withdraw it and to adopt any other remedies which may be appropriate.



Outside View



The report refers only to the sample tested and does not apply to the bulk.
This report is issued in confidence to the client and it will be strictly treated as such by the SHENZHEN TIMEWAY TESTING LABORATORIES. It may not be reproduced rather in its entirety or in part and it may not be used for advertising. The client to whom the report is issued may, however, show or send it . or a certified copy there of prepared by the SHENZHEN TIMEWAY TESTING LABORATORIES. to his customer. Supplier or others persons directly concerned. SHENZHEN TIMEWAY TESTING LABORATORIES. will not, without the consent of the client enter into any discussion of correspondence with any third party concerning the contents of the report.
In the event of the improper use of the report. The SHENZHEN TIMEWAY TESTING LABORATORIES. reserves the rights to withdraw it and to adopt any other remedies which may be appropriate.



Outside View



The report refers only to the sample tested and does not apply to the bulk.
This report is issued in confidence to the client and it will be strictly treated as such by the SHENZHEN TIMEWAY TESTING LABORATORIES. It may not be reproduced rather in its entirety or in part and it may not be used for advertising. The client to whom the report is issued may, however, show or send it . or a certified copy there of prepared by the SHENZHEN TIMEWAY TESTING LABORATORIES. to his customer. Supplier or others persons directly concerned. SHENZHEN TIMEWAY TESTING LABORATORIES. will not, without the consent of the client enter into any discussion of correspondence with any third party concerning the contents of the report.
In the event of the improper use of the report. The SHENZHEN TIMEWAY TESTING LABORATORIES. reserves the rights to withdraw it and to adopt any other remedies which may be appropriate.



Outside View



The report refers only to the sample tested and does not apply to the bulk.

This report is issued in confidence to the client and it will be strictly treated as such by the SHENZHEN TIMEWAY TESTING LABORATORIES. It may not be reproduced rather in its entirety or in part and it may not be used for advertising. The client to whom the report is issued may, however, show or send it, or a certified copy thereof, to his customer. Supplier or others persons directly concerned. SHENZHEN TIMEWAY TESTING LABORATORIES. will not, without the consent of the client enter into any discussion of correspondence with any third party concerning the contents of the report. In the event of the improper use of the report. The SHENZHEN TIMEWAY TESTING LABORATORIES. reserves the rights to withdraw it and to adopt any other remedies which may be appropriate.



Outside View



The report refers only to the sample tested and does not apply to the bulk.

This report is issued in confidence to the client and it will be strictly treated as such by the SHENZHEN TIMEWAY TESTING LABORATORIES. It may not be reproduced rather in its entirety or in part and it may not be used for advertising. The client to whom the report is issued may, however, show or send it or a certified copy thereof prepared by the SHENZHEN TIMEWAY TESTING LABORATORIES to his customer. Supplier or others persons directly concerned. SHENZHEN TIMEWAY TESTING LABORATORIES will not, without the consent of the client enter into any discussion of correspondence with any third party concerning the contents of the report. In the event of the improper use of the report. The SHENZHEN TIMEWAY TESTING LABORATORIES reserves the rights to withdraw it and to adopt any other remedies which may be appropriate.



Power Supply



The report refers only to the sample tested and does not apply to the bulk.
This report is issued in confidence to the client and it will be strictly treated as such by the SHENZHEN TIMEWAY TESTING LABORATORIES. It may not be reproduced rather in its entirety or in part and it may not be used for advertizing. The client to whom the report is issued may, however, show or send it . or a certified copy there of prepared by the SHENZHEN TIMEWAY TESTING LABORATORIES. to his customer. Supplier or others persons directly concerned. SHENZHEN TIMEWAY TESTING LABORATORIES. will not, without the consent of the client enter into any discussion of correspondence with any third party concerning the contents of the report.
In the event of the improper use of the report. The SHENZHEN TIMEWAY TESTING LABORATORIES. reserves the rights to withdraw it and to adopt any other remedies which may be appropriate.



Power Supply



The report refers only to the sample tested and does not apply to the bulk.

This report is issued in confidence to the client and it will be strictly treated as such by the SHENZHEN TIMEWAY TESTING LABORATORIES. It may not be reproduced rather in its entirety or in part and it may not be used for advertising. The client to whom the report is issued may, however, show or send it or a certified copy thereof prepared by the SHENZHEN TIMEWAY TESTING LABORATORIES to his customer. Supplier or others persons directly concerned. SHENZHEN TIMEWAY TESTING LABORATORIES will not, without the consent of the client enter into any discussion of correspondence with any third party concerning the contents of the report. In the event of the improper use of the report. The SHENZHEN TIMEWAY TESTING LABORATORIES reserves the rights to withdraw it and to adopt any other remedies which may be appropriate.



Interior View



The report refers only to the sample tested and does not apply to the bulk.
This report is issued in confidence to the client and it will be strictly treated as such by the SHENZHEN TIMEWAY TESTING LABORATORIES. It may not be reproduced rather in its entirety or in part and it may not be used for advertising. The client to whom the report is issued may, however, show or send it, or a certified copy thereof, to his customer. Supplier or others persons directly concerned. SHENZHEN TIMEWAY TESTING LABORATORIES. will not, without the consent of the client enter into any discussion of correspondence with any third party concerning the contents of the report.
In the event of the improper use of the report. The SHENZHEN TIMEWAY TESTING LABORATORIES. reserves the rights to withdraw it and to adopt any other remedies which may be appropriate.

Interior View



The report refers only to the sample tested and does not apply to the bulk.

This report is issued in confidence to the client and it will be strictly treated as such by the SHENZHEN TIMEWAY TESTING LABORATORIES. It may not be reproduced rather in its entirety or in part and it may not be used for advertising. The client to whom the report is issued may, however, show or send it . or a certified copy there of prepared by the SHENZHEN TIMEWAY TESTING LABORATORIES. to his customer. Supplier or others persons directly concerned. SHENZHEN TIMEWAY TESTING LABORATORIES. will not, without the consent of the client enter into any discussion of correspondence with any third party concerning the contents of the report. In the event of the improper use of the report. The SHENZHEN TIMEWAY TESTING LABORATORIES. reserves the rights to withdraw it and to adopt any other remedies which may be appropriate.



Interior View



The report refers only to the sample tested and does not apply to the bulk.

This report is issued in confidence to the client and it will be strictly treated as such by the SHENZHEN TIMEWAY TESTING LABORATORIES. It may not be reproduced rather in its entirety or in part and it may not be used for advertising. The client to whom the report is issued may, however, show or send it, or a certified copy thereof prepared by the SHENZHEN TIMEWAY TESTING LABORATORIES, to his customer. Supplier or others persons directly concerned. SHENZHEN TIMEWAY TESTING LABORATORIES, will not, without the consent of the client enter into any discussion of correspondence with any third party concerning the contents of the report. In the event of the improper use of the report. The SHENZHEN TIMEWAY TESTING LABORATORIES, reserves the rights to withdraw it and to adopt any other remedies which may be appropriate.



Interior View



The report refers only to the sample tested and does not apply to the bulk.

This report is issued in confidence to the client and it will be strictly treated as such by the SHENZHEN TIMEWAY TESTING LABORATORIES. It may not be reproduced rather in its entirety or in part and it may not be used for advertising. The client to whom the report is issued may, however, show or send it . or a certified copy there of prepared by the SHENZHEN TIMEWAY TESTING LABORATORIES. to his customer. Supplier or others persons directly concerned. SHENZHEN TIMEWAY TESTING LABORATORIES. will not, without the consent of the client enter into any discussion of correspondence with any third party concerning the contents of the report. In the event of the improper use of the report. The SHENZHEN TIMEWAY TESTING LABORATORIES. reserves the rights to withdraw it and to adopt any other remedies which may be appropriate.



Interior View

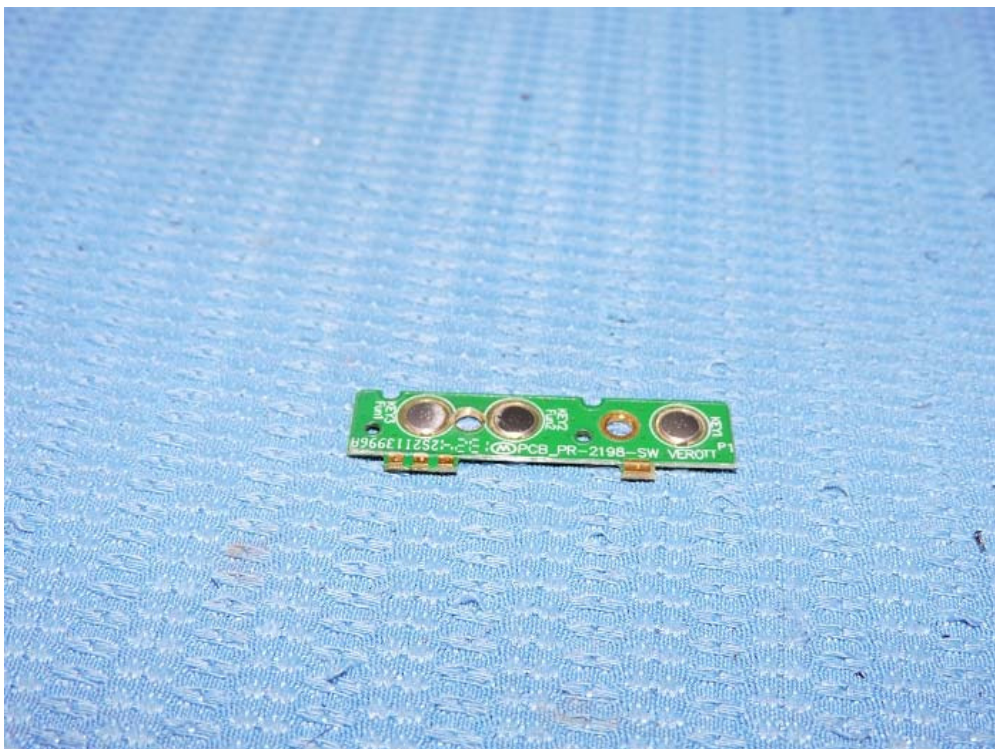
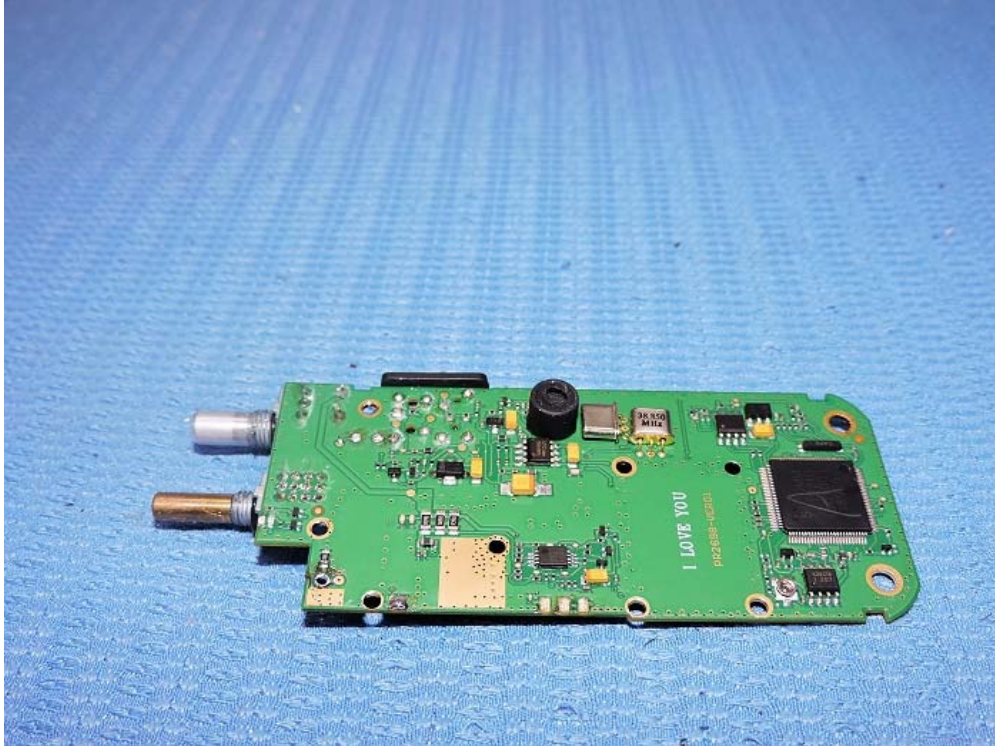

The report refers only to the sample tested and does not apply to the bulk.

This report is issued in confidence to the client and it will be strictly treated as such by the SHENZHEN TIMEWAY TESTING LABORATORIES. It may not be reproduced rather in its entirety or in part and it may not be used for advertising. The client to whom the report is issued may, however, show or send it . or a certified copy there of prepared by the SHENZHEN TIMEWAY TESTING LABORATORIES. to his customer. Supplier or others persons directly concerned. SHENZHEN TIMEWAY TESTING LABORATORIES. will not, without the consent of the client enter into any discussion of correspondence with any third party concerning the contents of the report. In the event of the improper use of the report. The SHENZHEN TIMEWAY TESTING LABORATORIES. reserves the rights to withdraw it and to adopt any other remedies which may be appropriate.



Interior View

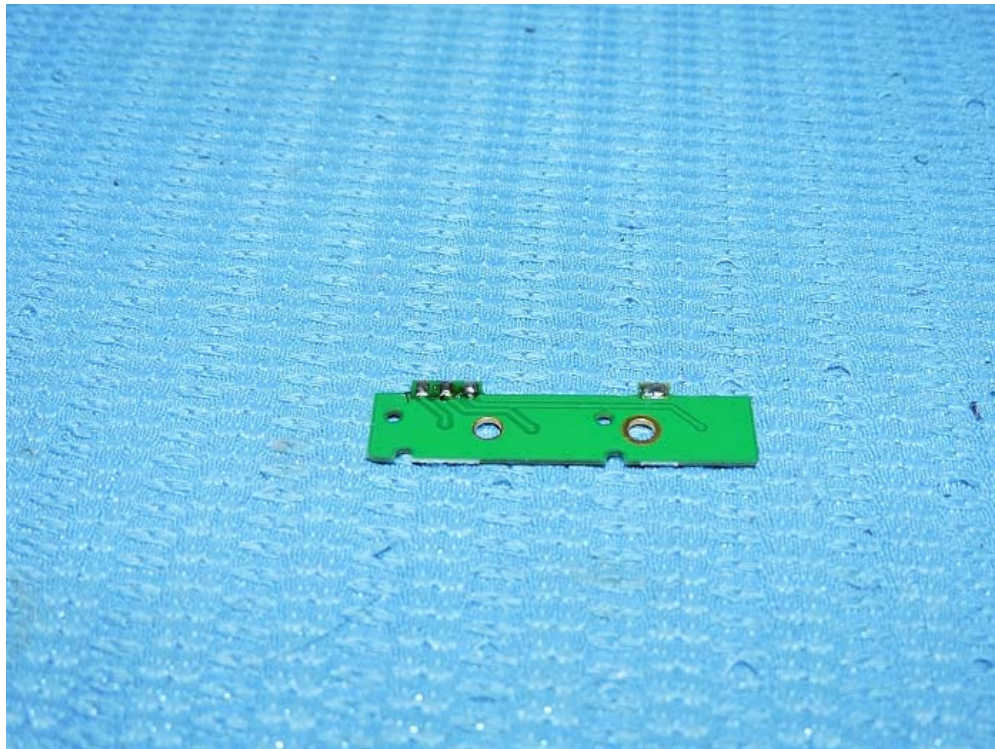

-End of the report-

The report refers only to the sample tested and does not apply to the bulk.

This report is issued in confidence to the client and it will be strictly treated as such by the SHENZHEN TIMEWAY TESTING LABORATORIES. It may not be reproduced rather in its entirety or in part and it may not be used for advertising. The client to whom the report is issued may, however, show or send it . or a certified copy there of prepared by the SHENZHEN TIMEWAY TESTING LABORATORIES. to his customer. Supplier or others persons directly concerned. SHENZHEN TIMEWAY TESTING LABORATORIES. will not, without the consent of the client enter into any discussion of correspondence with any third party concerning the contents of the report. In the event of the improper use of the report. The SHENZHEN TIMEWAY TESTING LABORATORIES. reserves the rights to withdraw it and to adopt any other remedies which may be appropriate.