

S

T

S

L

A

B



RADIO TEST REPORT

Report No: STS1705035W01

Issued for

Guangdong Samzuk Technology Development Co,Ltd

High-Tech Zone Xingong Avenue East Heyuan, China

Product Name:	Wireless Door Bell System -INDOOR
Brand Name:	SAMCOM
Model Name:	DBIM10A
Series Model:	DBIM20A,DBIM30A,DBIM40A,DBIM50A
FCC ID:	2AIOQ-DBIM10A
Test Standard:	FCC Part 15.231

Any reproduction of this document must be done in full. No single part of this document may be reproduced without permission from BZT, All Test Data Presented in this report is only applicable to presented Test sample.

BZT Testing Technology Co., Ltd

Add. : Buliding 17, Xinghua Road Xingwei industrial Park Fuyong,
Baoan District, Shenzhen, Guangdong, China

TEL: +86-755 3307 1680 FAX: +86-755 27341758 E-mail:bruce@bzt.Cn



**TEST REPORT CERTIFICATION**

Applicant's name : Guangdong Samzuk Technology Development Co,Ltd
Address : High-Tech Zone Xinggong Avenue East Heyuan, China
Manufacture's Name : Guangdong Samzuk Technology Development Co,Ltd
Address : High-Tech Zone Xinggong Avenue East Heyuan, China

Product description

Product name : Wireless Door Bell System -INDOOR
Brand name : **SAMCOM**
Model and/or type reference : DBIM10A

Standards : FCC Part 15.231

Test procedure : ANSI C63.10-2013

This device described above has been tested by BZT, the test results show that the equipment under test (EUT) is in compliance with the FCC requirements. And it is applicable only to the tested sample identified in the report.

This report shall not be reproduced except in full, without the written approval of BZT, this document may be altered or revised by BZT, personal only, and shall be noted in the revision of the document.

Date of Test :
Date of performance of tests : 23 May. 2017~01 June. 2017
Date of Issue : 02 June. 2017
Test Result : **Pass**

Testing Engineer :

(Chris chen)

Technical Manager :

(Tony liu)

Authorized Signatory :

(Vita Li)





TABLE OF CONTENTS	Page
1. SUMMARY OF TEST RESULTS	6
1.1 TEST FACTORY	6
1.2 MEASUREMENT UNCERTAINTY	6
2. GENERAL INFORMATION	7
2.1 GENERAL DESCRIPTION OF EUT	7
2.2 DESCRIPTION OF TEST MODES	8
2.3 BLOCK DIGRAM SHOWING THE CONFIGURATION OF SYSTEM TESTED	8
2.4 DESCRIPTION OF SUPPORT UNITS	9
2.5 EQUIPMENTS LIST FOR ALL TEST ITEMS	10
3. EMC EMISSION TEST	11
3.1 CONDUCTED EMISSION MEASUREMENT	11
3.2 TEST PROCEDURE	12
3.3 TEST SETUP	12
3.4 EUT OPERATING CONDITIONS	12
3.5 TEST RESULTS	13
4. RADIATED EMISSION MEASUREMENT	15
4.1 RADIATED EMISSION LIMITS	15
4.2 TEST PROCEDURE	16
4.3 DEVIATION FROM TEST STANDARD	17
5. BANDWIDTH TEST	25
5.1 APPLIED PROCEDURES / LIMIT	25
5.2 TEST REQUIREMENTS	25
5.3 TEST PROCEDURE	25
5.4 TEST SETUP	25
5.5 EUT OPERATION CONDITIONS	25
5.6 TEST RESULTS	26
6. TRANSMITTER TIMEOUT	28
6.1 LIMIT	28
6.2 TEST PROCEDURE	28
6.3 TEST SETUP	28
6.4 TEST RESULTS	29
7. ANTENNA REQUIREMENT	31
7.1 STANDARD REQUIREMENT	31



TABLE OF CONTENTS	Page
7.2 EUT ANTENNA	31
APPENDIX 1- PHOTOS OF TEST SETUP	32





Revision History

Rev.	Issue Date	Report NO.	Effect Page	Contents
00	02 June. 2017	STS1705035W01	ALL	Initial Issue





1. SUMMARY OF TEST RESULTS

Test procedures according to the technical standards:

FCC Part 15.231,Subpart C			
Standard Section	Test Item	Judgment	Remark
15.207	Conducted Emission	N/A	--
15.205(a)/15.209 / 15.231(e)	Radiated Spurious Emission	PASS	--
15.231	Transmission requirement	PASS	--
15.231(C)	20 dB Bandwidth	PASS	--
15.203	Antenna Requirement	PASS	--

NOTE: (1)"N/A" denotes test is not applicable in this Test Report

(2) All tests are according to ANSI C63.4-2014 and ANSI C63.10-2013

1.1 TEST FACTORY

BZT Testing Technology Co., Ltd.
 Add. : Buliding 17, Xinghua Road Xingwei industrial Park Fuyong,
 Baoan District, Shenzhen, Guangdong, China
 FCC Registration No.: 701733

1.2 MEASUREMENT UNCERTAINTY

The reported uncertainty of measurement $y \pm U$, where expended uncertainty U is based on a standard uncertainty multiplied by a coverage factor of $k=2$, providing a level of confidence of approximately 95 %.

No.	Item	Uncertainty
1	Conducted Emission (9KHz-150KHz)	$\pm 2.88\text{dB}$
2	Conducted Emission (150KHz-30MHz)	$\pm 2.67\text{dB}$
3	RF power,conducted	$\pm 0.70\text{dB}$
4	Spurious emissions,conducted	$\pm 1.19\text{dB}$
5	All emissions,radiated(<1G) 30MHz-200MHz	$\pm 2.83\text{dB}$
6	All emissions,radiated(<1G) 200MHz-1000MHz	$\pm 2.94\text{dB}$
8	Temperature	$\pm 0.5^{\circ}\text{C}$
9	Humidity	$\pm 2\%$



2. GENERAL INFORMATION

2.1 GENERAL DESCRIPTION OF EUT

Equipment	Wireless Door Bell System -INDOOR	
Trade Name	SAMCOM	
Model Name	DBIM10A	
Series Model	DBIM20A,DBIM30A, DBIM40A, DBIM50A	
Model Difference	Only different in model name and brand name	
Product Description	The EUT is a Wireless Door Bell System -INDOOR	
	Operation Frequency:	462.6375MHz;462.6875MHz; 462.7125MHz
	Modulation Type:	FM
	Number Of Channel	1CH.
	Antenna Designation:	Built-in antenna
	Antenna Gain(Peak)	0.5 dBi
	More details of EUT technical specification, please refer to the User's Manual.	
Hardware version number	N/A	
Software version number	N/A	
Connecting I/O Port(s)	Please refer to the User's Manual	

Note:

1. For a more detailed features description, please refer to the manufacturer's specifications or the User's Manual.

2. Table for filed Antenna

Ant.	Brand	Model Name	Antenna Type	Connector	Gain (dBi)	NOTE
1	SAMCOM	DBIM10A	Built-in antenna	N/A	0.5	Antenna

The EUT antenna is Built-in antenna. No antenna other than that furnished by the responsible party shall be used with the device.



2.2 DESCRIPTION OF TEST MODES

To investigate the maximum EMI emission characteristics generates from EUT, the test system was pre-scanning tested base on the consideration of following EUT operation mode or test configuration mode which possible have effect on EMI emission level. Each of these EUT operation mode(s) or test configuration mode(s) mentioned above was evaluated respectively.

Frequency range over which device operates	Number of frequencies	Location in the range of operation
1 MHz or less	1	Middle.

Note : 462.6875MHz frequency channel is tested

For Radiated Emission	
Final Test Mode	Description
Mode 1	Keeping TX

For AC Conducted Emission

Test Case	
AC Conducted Emission	Keeping TX

Note:

- (1) The measurements are performed at the highest, middle, lowest available channels.
- (2) The measurements are performed at all Bit Rate of Transmitter, the worst data was reported

2.3 BLOCK DIGRAM SHOWING THE CONFIGURATION OF SYSTEM TESTED

During testing channel & power controlling software provided by the customer was used to control the operating channel as well as the output power level. The RF output power selection is for the setting of RF output power expected by the customer and is going to be fixed on the firmware of the final end product power parameters

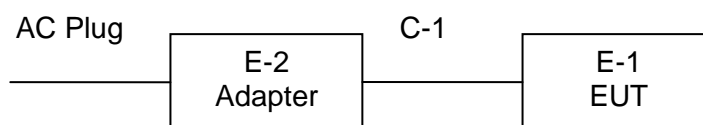



2.4 DESCRIPTION OF SUPPORT UNITS

The EUT has been tested as an independent unit together with other necessary accessories or support units. The following support units or accessories were used to form a representative test configuration during the tests.

Item	Equipment	Mfr/Brand	Model/Type No.	Series No.	Note
E-1	Wireless Door Bell System -INDOOR	SAMCOM	DBIM10A	N/A	EUT
E-2	Adapter	N/A	WLC0510UU	N/A	EUT

Item	Shielded Type	Ferrite Core	Length	Note
C-1	USB Cable shielded line (Charging)	NO	100cm	N/A

Note:

(1)The support equipment was authorized by Declaration of Confirmation.

(2)For detachable type I/O cable should be specified the length in cm in 『Length』 column.



2.5 EQUIPMENTS LIST FOR ALL TEST ITEMS

Radiation Test equipment

Kind of Equipment	Manufacturer	Type No.	Serial No.	Last calibration	Calibrated until
Spectrum Analyzer	Agilent	E4407B	MY50140340	2016.10.23	2017.10.22
Test Receiver	R&S	ESCI	101427	2016.10.23	2017.10.22
Bilog Antenna	TESEQ	CBL6111D	34678	2015.11.25	2017.11.24
Horn Antenna	Schwarzbeck	BBHA 9120D(1201) 1G-18G	9120D-1343	2016.03.06	2018.03.05
50Ω Coaxial Switch	Anritsu	MP59B	6200264416	2016.10.23	2017.10.22
PreAmplifier	Agilent	8449B	60538	2016.10.23	2017.10.22
Loop Antenna	EMCO	6502	9003-2485	2016.03.06	2019.03.03
USB RF power sensor	DARE	RPR3006W	15I00041SNO0 3	2016.10.23	2017.10.22
Spectrum Analyzer	Agilent	E4407B	MY50140340	2016.10.23	2017.10.22
Semi-anechoic chamber	Changling	966	N/A	2016.10.23	2017.10.22

Conduction Test equipment

Kind of Equipment	Manufacturer	Type No.	Serial No.	Last calibration	Calibrated until
EMI Test Receiver	R&S	ESPI	102086	2016.10.23	2017.10.22
LISN	R&S	ENV216	101242	2016.10.23	2017.10.22
LISN	EMCO	3810/2NM	000-23625	2016.10.23	2017.10.22
Shielding Room	Changling	854	N/A	2016.10.23	2017.10.22



3. EMC EMISSION TEST

3.1 CONDUCTED EMISSION MEASUREMENT

3.1.1 POWER LINE CONDUCTED EMISSION LIMITS

operating frequency band. In case the emission fall within the restricted band specified on Part 15. 207(a) limit in the table below has to be followed.

FREQUENCY (MHz)	Class B (dBuV)		Standard
	Quasi-peak	Average	
0.15 -0.5	66 - 56 *	56 - 46 *	CISPR
0.50 -5.0	56.00	46.00	CISPR
5.0 -30.0	60.00	50.00	CISPR

0.15 -0.5	66 - 56 *	56 - 46 *	FCC
0.50 -5.0	56.00	46.00	FCC
5.0 -30.0	60.00	50.00	FCC

Note:

- (1) The tighter limit applies at the band edges.
- (2) The limit of " * " marked band means the limitation decreases linearly with the logarithm of the frequency in the range.

The following table is the setting of the receiver

Receiver Parameters	Setting
Attenuation	10 dB
Start Frequency	0.15 MHz
Stop Frequency	30 MHz
IF Bandwidth	9 kHz

3.2 TEST PROCEDURE

- a. The EUT was placed 0.4 meters from the horizontal ground plane with EUT being connected to the power mains through a line impedance stabilization network (LISN). All other support equipments powered from additional LISN(s). The LISN provide 50 Ohm/ 50uH of coupling impedance for the measuring instrument.
- b. Interconnecting cables that hang closer than 40 cm to the ground plane shall be folded back and forth in the center forming a bundle 30 to 40 cm long.
- c. I/O cables that are not connected to a peripheral shall be bundled in the center. The end of the cable may be terminated, if required, using the correct terminating impedance. The overall length shall not exceed 1 m.
- d. LISN at least 80 cm from nearest part of EUT chassis.
- e. For the actual test configuration, please refer to the related Item –EUT Test Photos.

3.3 TEST SETUP

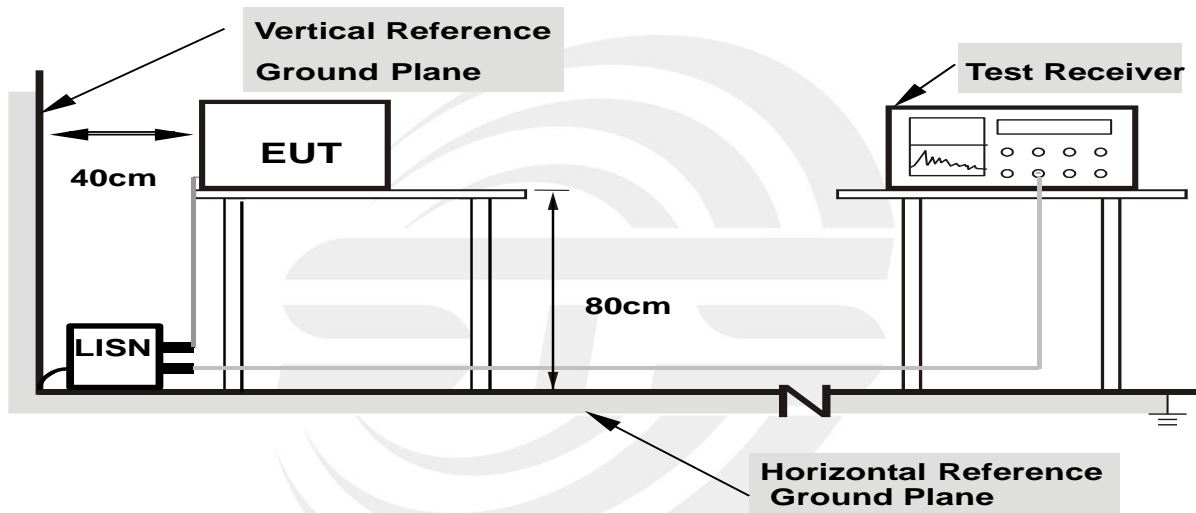

- Note: 1. Support units were connected to second LISN.**
2. Both of LISNs (AMN) are 80 cm from EUT and at least 80 from other units and other metal planes

3.4 EUT OPERATING CONDITIONS

The EUT was configured for testing in a typical fashion (as a customer would normally use it). The EUT has been programmed to continuously transmit during test. This operating condition was tested and used to collect the included data.



3.5 TEST RESULTS

Temperature:	23.1°C	Relative Humidity:	61%
Pressure:	1010hPa	Phase:	L
Test Mode:	120V 60Hz		

Frequency (MHz)	Reading (dBuV)	Correct Factor(dB)	Result (dBuV)	Limit (dBuV)	Margin (dB)	Remark
0.4020	35.01	9.43	44.44	57.81	-13.37	QP
0.4020	21.82	9.43	31.25	47.81	-16.56	AVG
0.4980	41.83	9.15	50.98	56.03	-5.05	QP
0.4980	29.32	9.15	38.47	46.03	-7.56	AVG
0.7660	36.46	9.22	45.68	56.00	-10.32	QP
0.7660	19.33	9.22	28.55	46.00	-17.45	AVG
1.0740	37.65	9.16	46.81	56.00	-9.19	QP
1.0740	19.14	9.16	28.30	46.00	-17.70	AVG
2.2420	39.36	9.26	48.62	56.00	-7.38	QP
2.2420	19.39	9.26	28.65	46.00	-17.35	AVG
3.3900	35.99	9.26	45.25	56.00	-10.75	QP
3.3900	14.56	9.26	23.82	46.00	-22.18	AVG

Remark:

1. All readings are Quasi-Peak and Average values.
2. Margin = Result (Result = Reading + Factor) – Limit

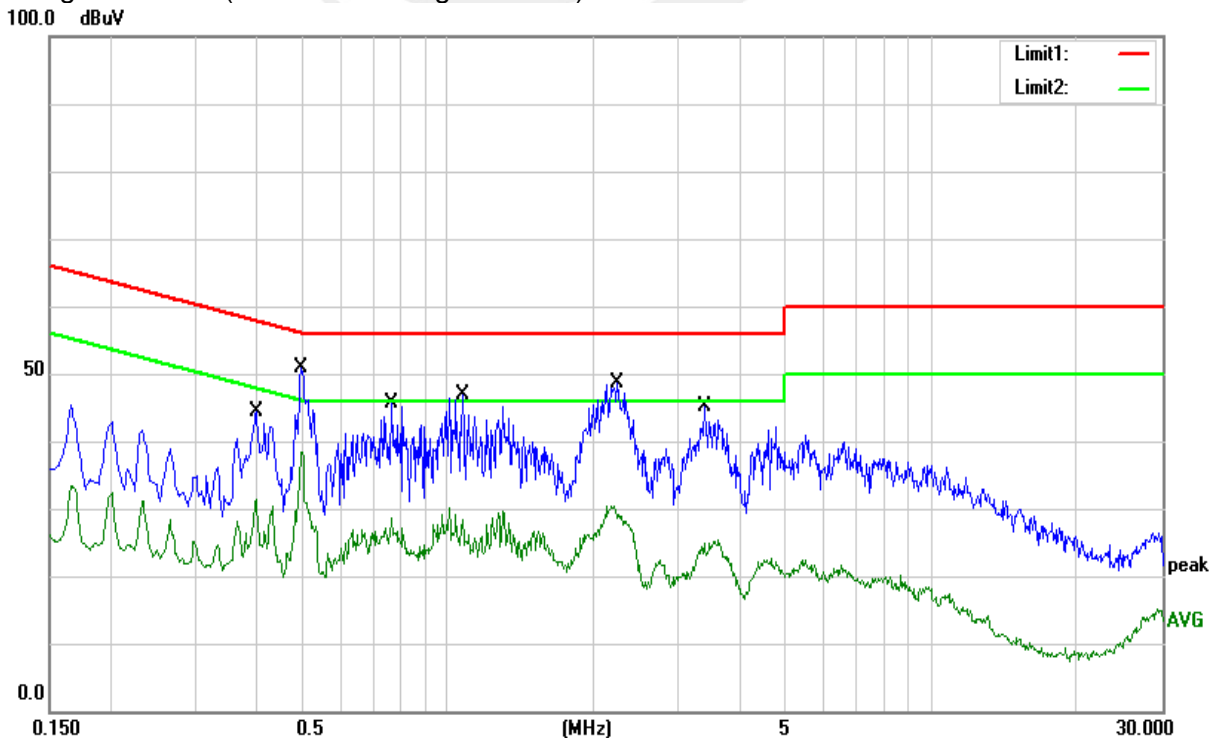



Temperature:	23.1℃	Relative Humidity:	61%
Pressure:	1010hPa	Phase:	N
Test Mode:	120V 60Hz		

Frequency (MHz)	Reading (dBuV)	Correct Factor(dB)	Result (dBuV)	Limit (dBuV)	Margin (dB)	Remark
0.4020	34.62	9.43	44.05	57.81	-13.76	QP
0.4020	28.62	9.43	38.05	47.81	-9.76	AVG
0.5020	42.24	9.14	51.38	56.00	-4.62	QP
0.5020	34.23	9.14	43.37	46.00	-2.63	AVG
0.9700	33.67	9.16	42.83	56.00	-13.17	QP
0.9700	25.22	9.16	34.38	46.00	-11.62	AVG
1.2820	33.23	9.18	42.41	56.00	-13.59	QP
1.2820	21.67	9.18	30.85	46.00	-15.15	AVG
2.1580	37.59	9.26	46.85	56.00	-9.15	QP
2.1580	27.80	9.26	37.06	46.00	-8.94	AVG
3.5180	33.52	9.26	42.78	56.00	-13.22	QP
3.5180	22.09	9.26	31.35	46.00	-14.65	AVG

Remark:

1. All readings are Quasi-Peak and Average values.
2. Margin = Result (Result =Reading + Factor)–Limit

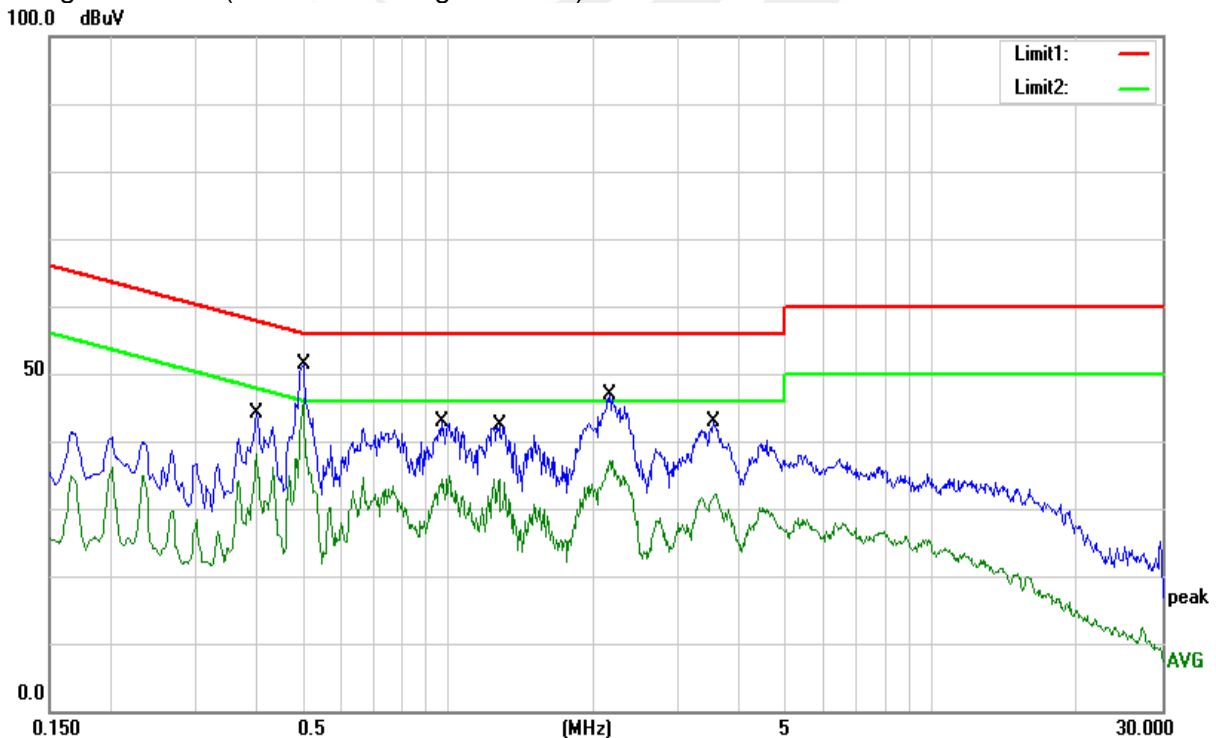



4. RADIATED EMISSION MEASUREMENT

4.1 RADIATED EMISSION LIMITS

In case the emission fall within the restricted band specified on Part 15.205(a), then the Part 15.209(a) and Part 15.231(e) limit in the table below has to be followed.

LIMITS OF RADIATED EMISSION MEASUREMENT (0.009MHz - 1000MHz)

Frequencies (MHz)	Field Strength (microvolts/meter)	Measurement Distance (meters)
0.009~0.490	2400/F(KHz)	300
0.490~1.705	24000/F(KHz)	30
1.705~30.0	30	30
30~40.66	100	3

LIMITS OF RADIATED EMISSION MEASUREMENT (FCC 15.231.e)

Fundamental Frequency (MHz)	Field Strength of fundamental (microvolts/meter)	Field Strength of Unwanted Emissions (microvolts/meter)
40.66 - 40.70	1,000	100
70 - 130	500	50
130 - 174	500 to 1,500 **	50 to 1,50 **
174 - 260	1,500	1,50
260 - 470	1,500 to 5,000 **	1,50 to 5,00 **
Above 470	5,000	5,00

LIMITS OF RADIATED EMISSION MEASUREMENT (Above 1000MHz)

FREQUENCY (MHz)	Class B (dBuV/m) (at 3M)	
	PEAK	AVERAGE
Above 1000	74	54

NOTE:** linear interpolations

[Where F is the frequency in MHz, the formulas for calculating the maximum permitted fundamental

field strengths are as follows: for the band 130-174 MHz, $\mu\text{V}/\text{m}$ at 3 meters = $22.72727(F) - 2454.545$;

for the band 260-470 MHz, $\mu\text{V}/\text{m}$ at 3 meters = $16.6667(F) - 2833.3333$. The maximum permitted unwanted emission level is 20 dB below the maximum permitted fundamental level.]

The limits on the field strength of the spurious emissions in the above table are based on the fundamental frequency of the intentional radiator. Spurious emissions shall be attenuated to the average (or, alternatively, CISPR quasi-peak) limits shown in this table or to the general limits shown in 93 Section 15.209, whichever limit permits a higher field strength.



Spectrum Parameter	Setting
Detector	Peak
Attenuation	Auto
Start Frequency	1000 MHz
Stop Frequency	10th carrier harmonic
RB / VB (emission in restricted band)	1 MHz / 3 MHz

Receiver Parameter	Setting
Attenuation	Auto
Start ~ Stop Frequency	9kHz~90kHz / RB 200Hz for PK & AV
Start ~ Stop Frequency	90kHz~110kHz / RB 200Hz for QP
Start ~ Stop Frequency	110kHz~490kHz / RB 200Hz for PK & AV
Start ~ Stop Frequency	490kHz~30MHz / RB 9kHz for QP
Start ~ Stop Frequency	30MHz~1000MHz / RB 120kHz for QP

4.2 TEST PROCEDURE

- a. The measuring distance of 3m shall be used for measurements. The EUT was placed on the top of a rotating table 0.8 meter above the ground at a 3 meter semi-anechoic chamber. The table was rotated 360 degrees to determine the position of the highest radiation (Below 1GHz)
- b. The measuring distance of 3m shall be used for measurements. The EUT was placed on the top of a rotating table 1.5 meter above the ground at a 3 meter semi-anechoic chamber. The table was rotated 360 degrees to determine the position of the highest radiation (Above 1GHz)
- c. The height of the test antenna shall vary between 1m to 4m. Both horizontal and vertical polarization of the antenna are set to make the measurement.
- d. The initial step in collecting radiated emission data is a receive peak detector mode. Pre-scanning the measurement frequency range. Significant peaks are then marked and then Quasi Peak detector mode re-measured.
- e. All readings are peak unless otherwise stated QP in column of Note. Peak denoted that the Peak reading compliance with the QP limits and then QP Mode measurement didn't perform (Below 1GHz)
- f. All readings are Peak mode value unless otherwise stated AVG in column of Note. If the Peak mode measured value compliance with the Peak limits and lower than AVG Limits, the EUT shall be deemed to meet Peak & AVG limits and then only Peak mode was measured, but AVG mode didn't perform. (Above 1GHz)
- g. For the actual test configuration, please refer to the related Item –EUT Test Photos.

Note: Both horizontal and vertical antenna polarities were tested

and performed pretest to three orthogonal axis. The worst case emissions were reported

4.3 DEVIATION FROM TEST STANDARD

No deviation

4.4 TEST SETUP

(A) Radiated Emission Test-Up Frequency Below 30MHz

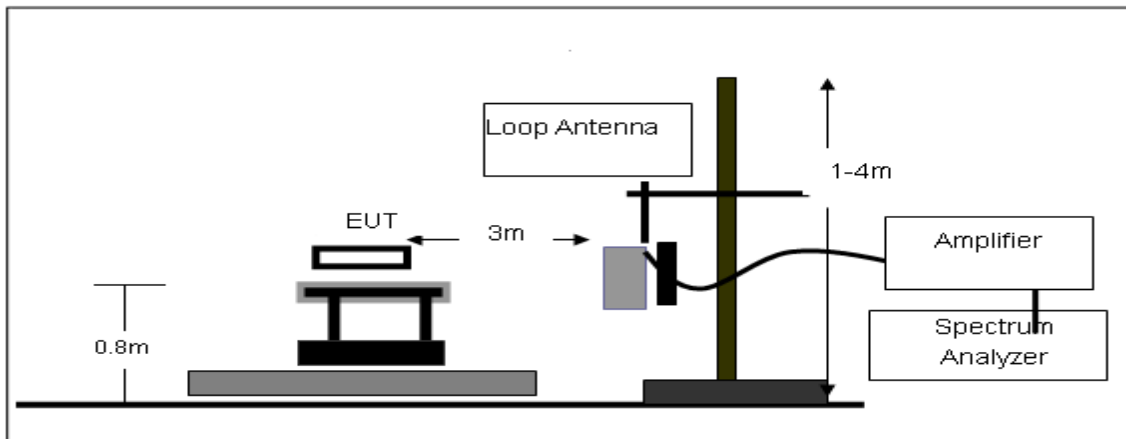

(B) Radiated Emission Test-Up Frequency 30MHz~1GHz

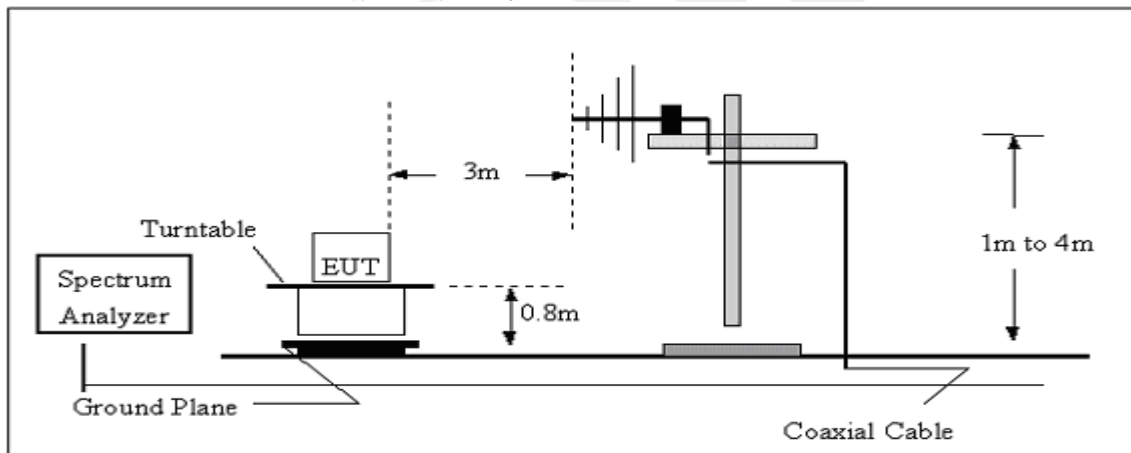

(C) Radiated Emission Test-Up Frequency Above 1GHz

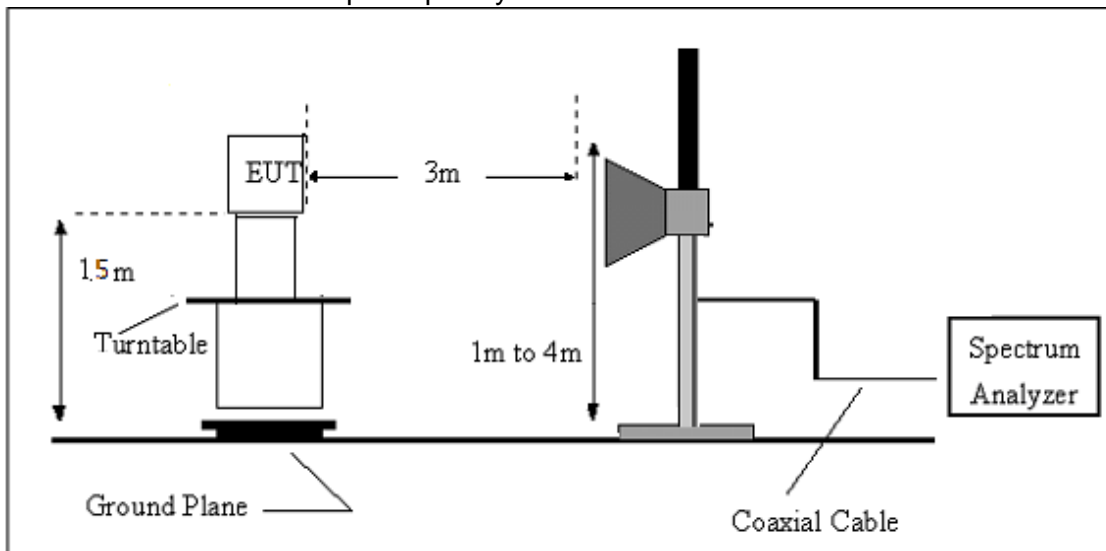

4.5 EUT OPERATING CONDITIONS

The EUT tested system was configured as the statements of 2.4 Unless otherwise a special operating condition is specified in the follows during the testing.

4.6 TEST RESULTS

INTRODUCTION TO PDCF

reference: (§15.35 Measurement detector functions and bandwidths.)

- a. Part 15 of the FCC Rules provides for the operation of low power communication devices without an individual license (e.g., intrusion detectors, pulsed water tank level gauges, etc.), subject to certain requirements. Some of these devices use extremely narrow pulses to generate wideband emissions, which are measured to determine compliance with the rules. These measurements are typically performed with a receiver or spectrum analyzer. Depending on a number of factors (e.g., resolution bandwidth, pulsewidth, etc.), the spectrum analyzer may not always display the true peak value of the measured emission. This effect, called “pulse desensitization,” relates to the capabilities of the measuring instrument. For the measurement and reporting of the true peak of pulsed emissions, it may be necessary to apply a “pulse desensitization correction factor” (PDCF) to the measured value, pursuant to 47 CFR 15.35(a).

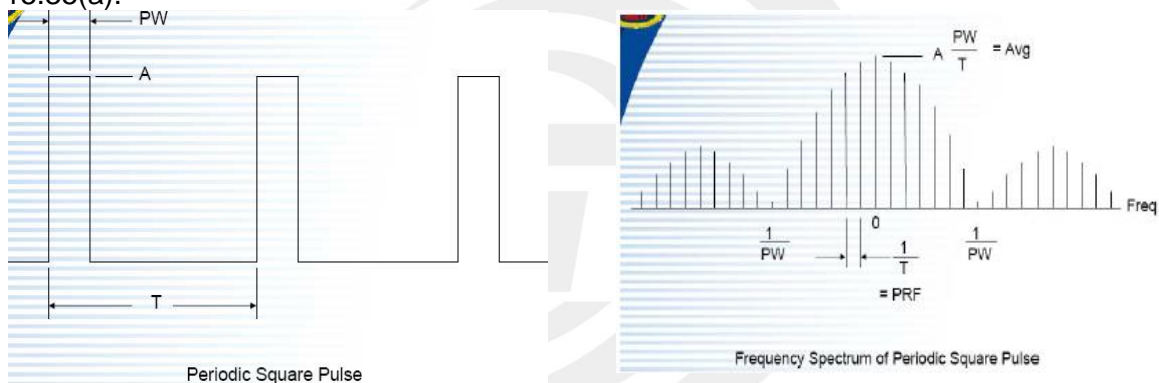

If using spectrum analyzer to measure pulse signal , it have to make sure the RBW use is at least $2/PW$.

•When RBW is less than $2/PW$, you are able to measure the true peak level of the pulse signal. If this is the case , PDCF is required to compensate to determine true peak value.

Pulse desensitization:

$PW = 74850\text{usec}$, $\text{Period} = 100000\text{usec}$, $\text{Level} = A$

$RBW > 2/PW = 0.027K$, $PRF = 1/T = 0.01K$,

NOTE: $2 / PW < RBW$, first don't need

- b. For the actual test, please refer to the ANSI C63.10, Annex C refer to section 5 for more detail



4.7 TEST RESULTS

(Radiated Emission<30MHz (9KHz-30MHz, H-field))

Temperature:	23.1 °C	Relative Humidity:	61%
Pressure:	1010 hPa	Polarization:	--
Test Mode:	Mode 1		

Not: Vertical level have a test this is the worst.

Freq. (MHz)	Reading (dBuV/m)	Limit (dBuV/m)	Margin (dB)	State P/F
--	--	--	--	PASS
--	--	--	--	PASS

Note: The amplitude of spurious emissions which are attenuated by more than 20dB below the permissible value has no need to be reported.

Distance extrapolation factor = $40 \log(\text{specific distance}/\text{test distance})$ (dB);

Limit line = specific limits(dBuv) + distance extrapolation factor.



Between 30MHz – 5000 MHz

Temperature:	26 °C	Relative Humidity:	60%
Pressure:	1010hPa	Phase:	Horizontal
Test Mode:	TX		

No.	Frequency (MHz)	Reading (dBuV)	Factor (dB)	Results (dBuV/m)	Limit (dBuV/m)	Margin (dB)	Detector
1	33.5623	45.87	-13.02	32.85	40.00	-7.15	QP
2	103.8054	46.26	-18.87	27.39	43.50	-16.11	QP
3	238.3102	51.68	-17.88	33.80	46.00	-12.20	QP
4	394.8543	53.56	-11.58	41.98	46.00	-4.02	QP
5	462.6875	81.64	-10.64	71.00	93.77	-22.77	PK
6	462.6875	80.10	-10.64	69.46	73.77	-2.77	AV
7	842.1295	41.71	-2.74	38.97	46.00	-7.03	QP

Remark:

1. All readings are Quasi-Peak and Average values.
2. Margin = Result (Result = Reading + Factor) – Limit
3. Scan with low, middle, high channel, only show the worst case in the report.

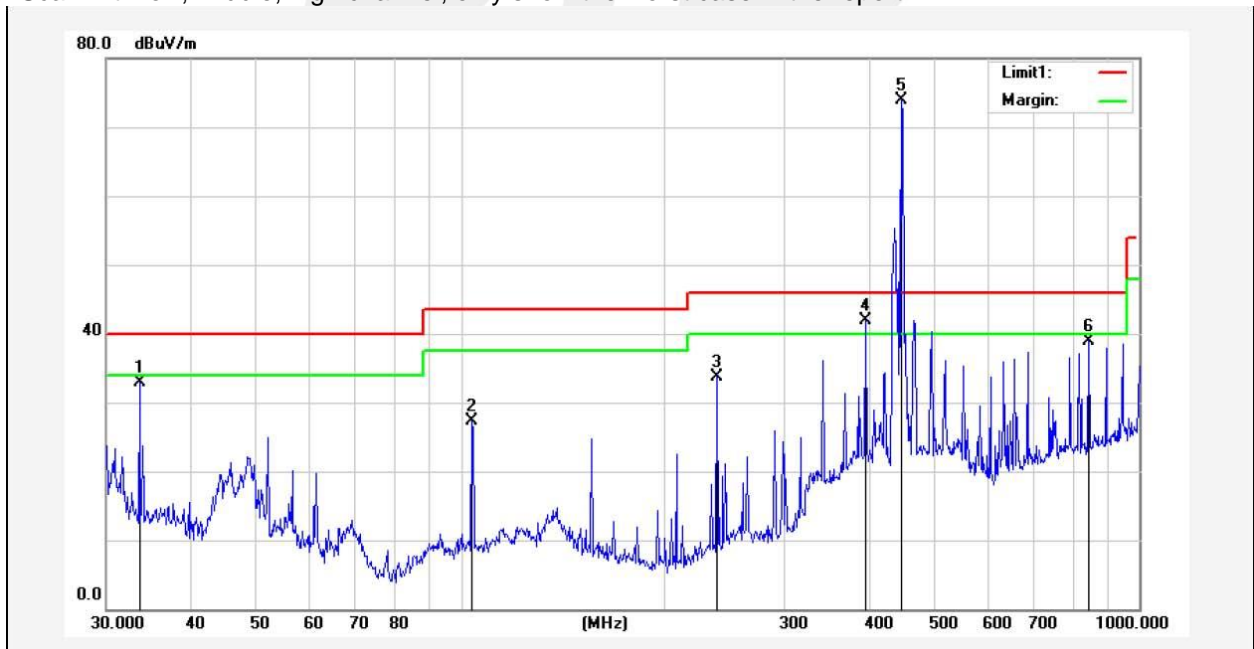



Temperature:	26 °C	Relative Humidity:	60%
Pressure:	1010hPa	Phase:	Vertical
Test Mode:	TX		

No.	Frequency (MHz)	Reading (dBuV)	Factor (dB)	Results (dBuV/m)	Limit (dBuV/m)	Margin (dB)	Detector
1	31.1798	37.54	-11.79	25.75	40.00	-14.25	QP
2	238.3102	42.44	-17.88	24.56	46.00	-21.44	QP
3	341.9786	49.57	-13.93	35.64	46.00	-10.36	QP
4	462.6875	80.63	-10.64	69.99	93.77	-23.78	PK
5	462.6875	79.21	-10.64	68.57	73.77	-3.78	AV
6	499.4245	42.77	-8.91	33.86	46.00	-12.14	QP
7	893.8567	34.80	-2.34	32.46	46.00	-13.54	QP

Remark:

1. All readings are Quasi-Peak and Average values.
2. Margin = Result (Result = Reading + Factor) - Limit
3. Scan with low, middle, high channel, only show the worst case in the report.

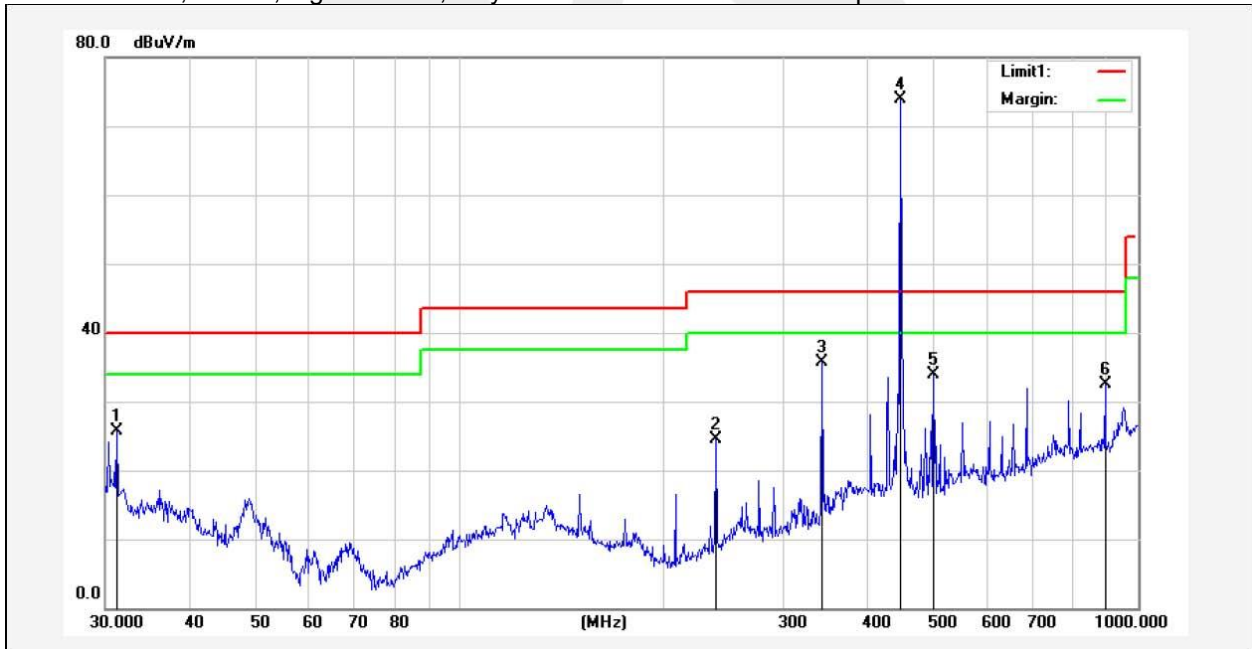

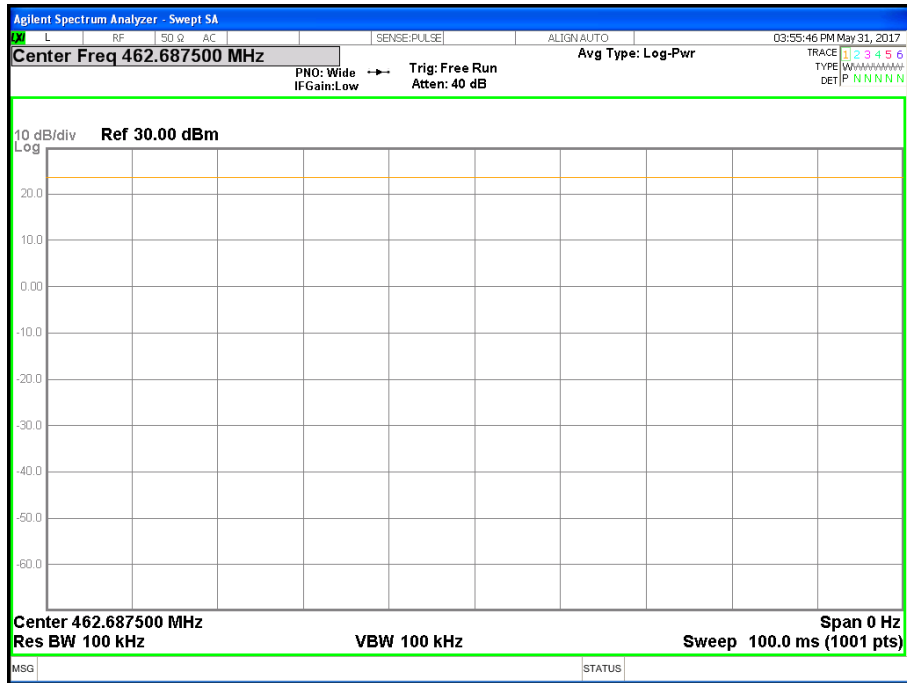

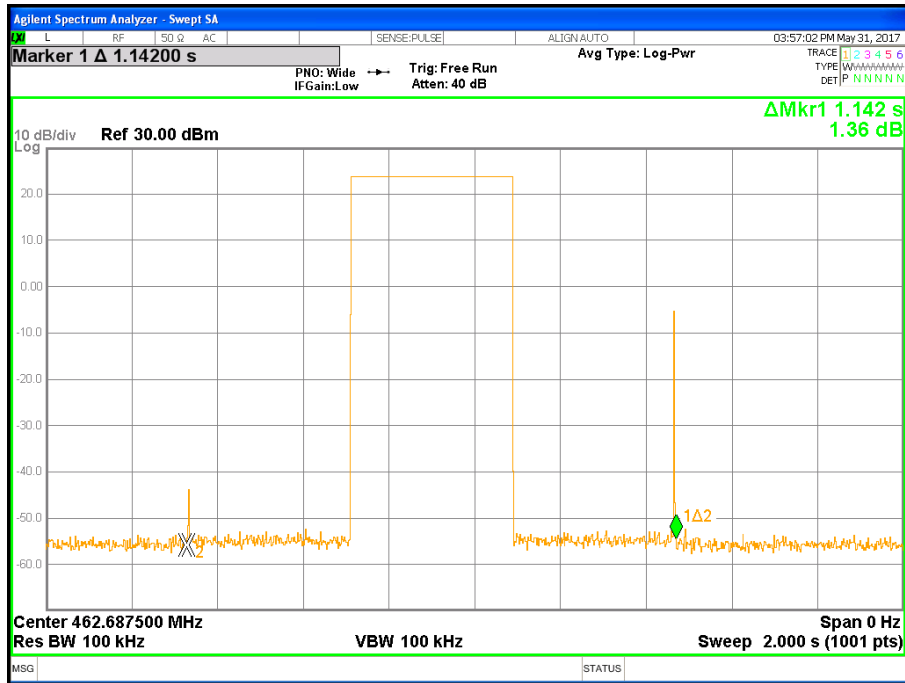

Note: Dutycycle=100%

**PEAK TEST RESULTS:**

Frequency: 462.6875MHz

Frequency	Reading	Detector	Amplifier	Loss	Antenna Factor	Corrected Factor	Corrected Amplitude	FCC Part 15.231/15.209/205		RX Antenna
								Limit	Margin	Polar
(MHz)	(dB μ V/m)	(PK/QP/AV)	(dB)	(dB)	(dB/m)	(dB)	(dB μ V/m)	(dB μ V/m)	(dB)	(H/V)
1388.0625	64.83	PK	45.1	4.0	25.1	-16.00	48.83	74	-25.17	H
1388.0625	62.39	AV	45.1	4.0	25.1	-16.00	46.39	54	-7.61	H
1388.0625	64.71	PK	45.1	4.0	25.1	-16.00	48.71	74	-25.29	V
1388.0625	62.36	AV	45.1	4.0	25.1	-16.00	46.36	54	-7.64	V
1850.75	62.38	PK	44.1	5.3	25	-13.80	48.58	74	-25.42	H
1850.75	60.61	AV	44.1	5.3	25	-13.80	46.81	54	-7.19	H
1850.75	62.26	PK	44.1	5.3	25	-13.80	48.46	74	-25.54	V
1850.75	60.57	AV	44.1	5.3	25	-13.80	46.77	54	-7.23	V
2313.4375	60.82	PK	43.8	5.4	25.9	-12.47	48.35	74	-25.65	H
2313.4375	58.75	AV	43.8	5.4	25.9	-12.47	46.28	54	-7.72	H
2313.4375	60.71	PK	43.8	5.4	25.9	-12.47	48.24	74	-25.76	V
2313.4375	58.68	AV	43.8	5.4	25.9	-12.47	46.21	54	-7.79	V
2776.125	56.88	PK	44.4	6.0	27.6	-10.77	46.11	74	-27.89	H
2776.125	55.16	AV	44.4	6.0	27.6	-10.77	44.39	54	-9.61	H
2776.125	56.75	PK	44.4	6.0	27.6	-10.77	45.98	74	-28.02	V
2776.125	55.09	AV	44.4	6.0	27.6	-10.77	44.32	54	-9.68	V

Note: Above 2.6 GHz The amplitude of spurious emissions which are attenuated by more than 20dB below the permissible value has no need to be reported.

5. BANDWIDTH TEST

5.1 APPLIED PROCEDURES / LIMIT

FCC Part 15.231, Subpart C				
Section	Test Item	Limit	Frequency Range (MHz)	Result
15.231(C)	20 Bandwidth	The 20dB bandwidth of the emissions shall not exceed 0.25% of the center frequency	462.6375MHz 462.6875MHz 462.7125MHz	PASS

Spectrum Parameter	Setting
Attenuation	Auto
Span Frequency	> Measurement Bandwidth
RB	10 kHz (20dB Bandwidth)
VB	30 kHz (20dB Bandwidth)
Detector	Peak
Trace	Max Hold
Sweep Time	Auto

5.2 TEST REQUIREMENTS

The bandwidth of the emission shall be no wider than 0.25% of the center frequency for devices operating above 70 MHz and below 900 MHz. For devices operating above 900 MHz, the emission shall be no wider than 0.5% of the center frequency. Bandwidth is determined at the points 20 dB down from the modulated carrier.

5.3 TEST PROCEDURE

- a. The EUT was directly connected to the spectrum analyzer and antenna output port as show in the block diagram below.
- b. Spectrum Setting : RBW= 10KHz, VBW=30KHz, Sweep time = Auto.

5.4 TEST SETUP



5.5 EUT OPERATION CONDITIONS

TX mode.



5.6 TEST RESULTS

Temperature:	25 °C	Relative Humidity:	60%
Pressure:	1012 hPa	Test Mode:	TX Mode

Centre Frequency	Measurement		
	20dB Bandwidth (KHz)	Limit(kHz)	Frequency Range (MHz)
462.6375MHz	120	1157	PASS
462.6875MHz	120.5	1157	PASS
462.7125MHz	120.5	1157	PASS

Low Channel

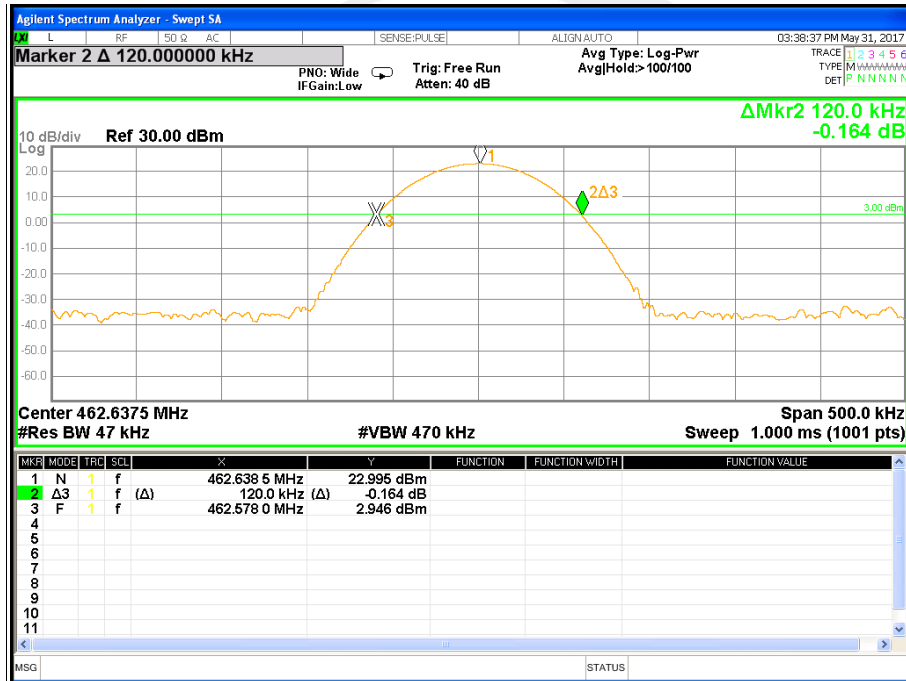



Middle Channel

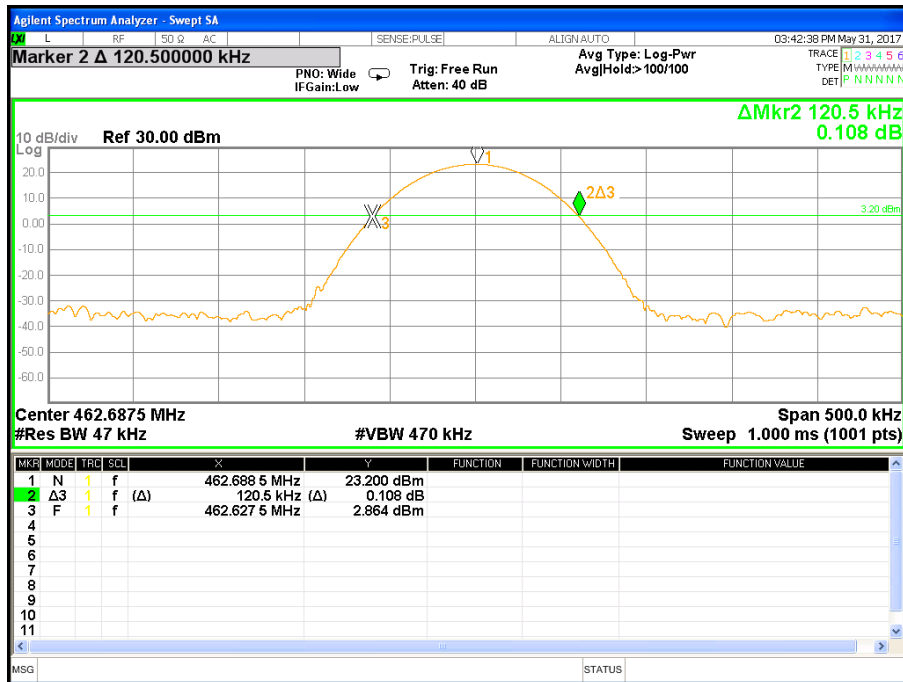

High Channel

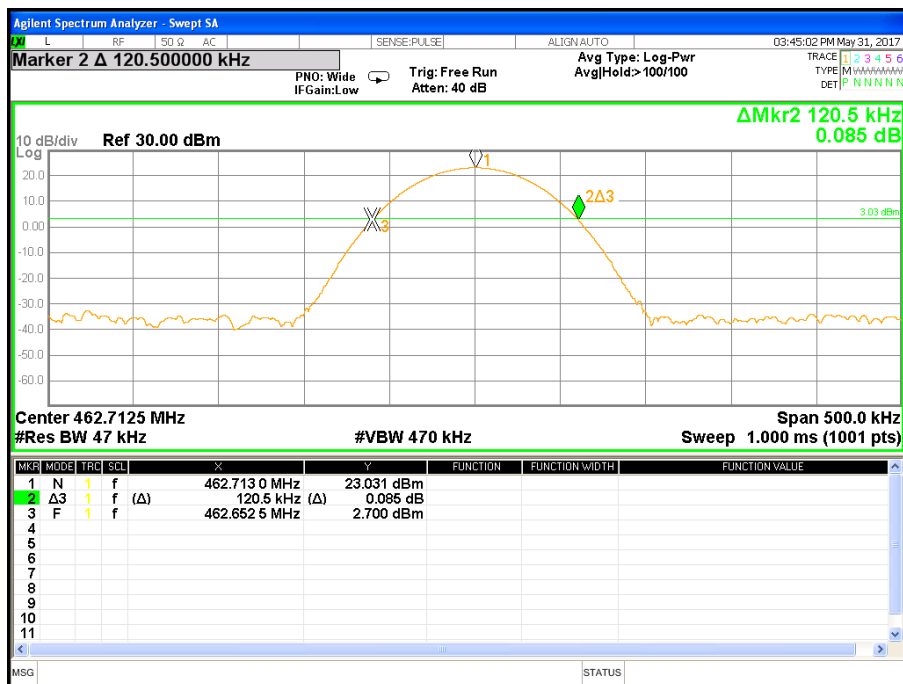

6. TRANSMITTER TIMEOUT

6.1 LIMIT

In addition, devices operated under the provisions of this paragraph shall be provided with a means for automatically limiting operation so that the duration of each transmission shall not be greater than one second and the silent period between transmissions shall be at least 30 times the duration of the but in no case less than 10 seconds.

6.2 TEST PROCEDURE

- (1) Put the EUT on the support in its standard position with associated equipment and switched on.
- (2) Set center frequency of spectrum analyzer = operating frequency.
- (3) Set the spectrum analyzer as RBW=100kHz, VBW=100kHz, Span=0Hz, Adjust Sweep=30s.
- (4) record the duration time

6.3 TEST SETUP





6.4 TEST RESULTS

Temperature:	26 °C	Relative Humidity:	53%
Pressure:	1020 hPa	Test Mode:	TX CH 1

Frequency(MHz)	Each transmission time(s)	silent period between transmissions(s)
462.6375	0.700	23.05
Limit	<1s	>10s and ≥30*(duration of transmission)
Result	Pass	





Frequency(MHz)	Each transmission time(s)	silent period between transmissions(s)
462.6875	0.700	23.25
Limit	<1s	>10s and ≥30*(duration of transmission)
Result	Pass	

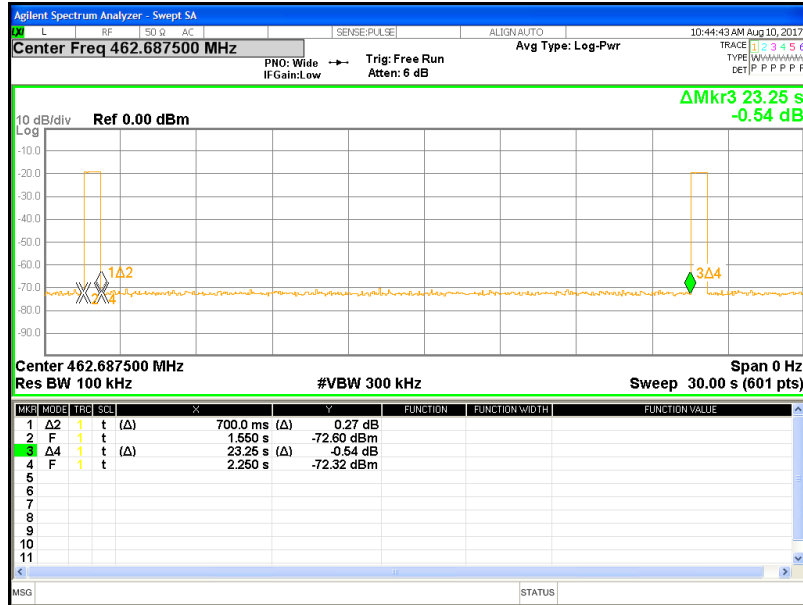

Frequency(MHz)	Each transmission time(s)	silent period between transmissions(s)
462.7125	0.700	23.25
Limit	<1s	>10s and ≥30*(duration of transmission)
Result	Pass	

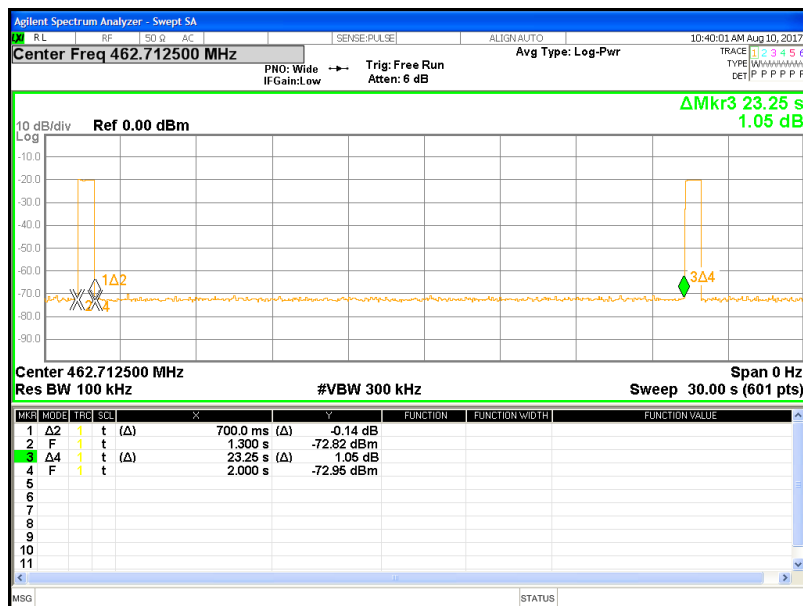



7. ANTENNA REQUIREMENT

7.1 STANDARD REQUIREMENT

According to the FCC Part 15 Paragraph 15.203, an intentional radiator shall be designed to ensure that no antenna other than that furnished by the responsible party shall be used with the device. The use of a permanently attached antenna to the intentional radiator shall be considered sufficient to comply with the provisions of this section. This product use a permanent ceramic printed antenna, fulfill the requirement of this section

7.2 EUT ANTENNA

The EUT antenna is Built-in antenna.It conforms to the standard requirements.



APPENDIX 1- PHOTOS OF TEST SETUP

Radiated Measurement Photos

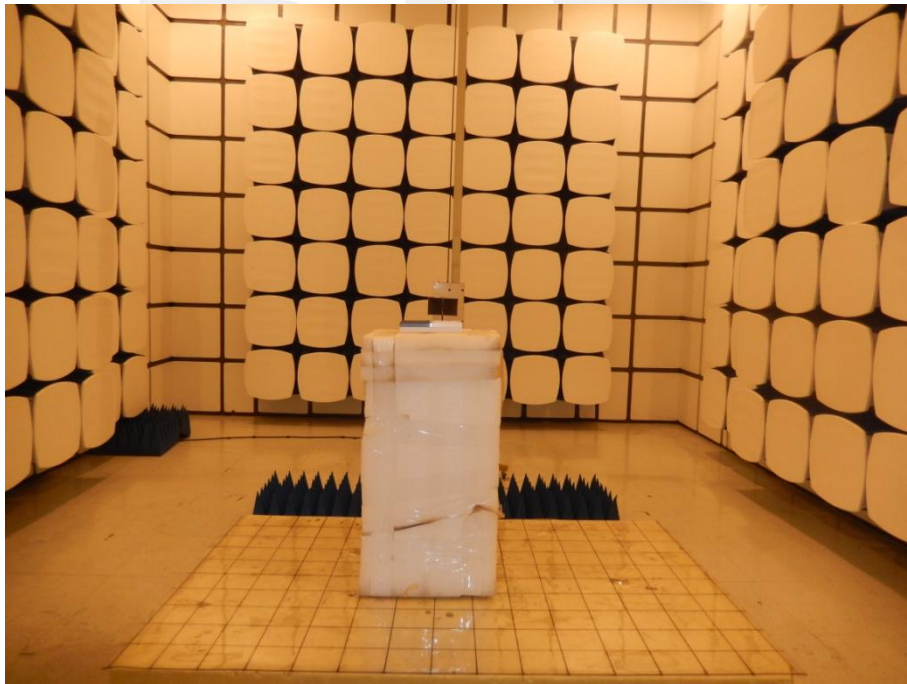
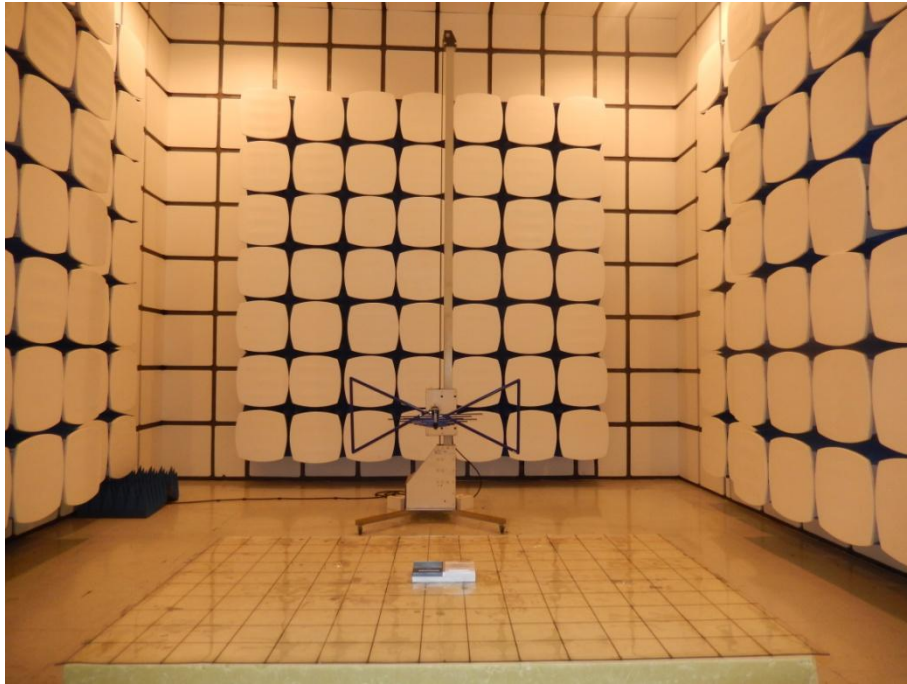

Conducted Measurement Photos



※※※※END OF THE REPORT※※※※