



CD MP3 Stereo Boombox with AM FM Radio

CD MP3 estéreo Boombox con radio AM FM

Boombox stéréo CD MP3 avec radio AM FM



USER'S GUIDE MANUAL DE USUARIO MODE D'EMPLOI

MODEL: CDB-237BT

TABLE OF CONTENTS

Safety Precautions	3
FCC Warnings	4
Introduction	5
Product Diagram	6
Additional Modes and Functions.....	8
Care and Maintenance	8
Troubleshooting.....	9
Technical Specifications	9
Technical Support	10
Limited Warranty	11
Español	12
Français	22

SAFETY PRECAUTIONS

READ THIS MANUAL CAREFULLY BEFORE OPERATING AND RESERVE IT FOR FUTURE REFERENCE. REFER TO IT WHEN ENCOUNTERING ANY OPERATING PROBLEM.

1. **WARNING:** To reduce the risk of electric shock or damage to the player's main speakers, do not disassemble the player. There are no user-serviceable parts inside. Contact technical support for further assistance.
2. **WARNING:** To prevent fire or electric shock hazard, do not expose the player to rain or moisture (including drips or splashes). Objects filled with liquids, such as vases and water bottles, should not be placed on or near the player. Do not touch the unit with wet hands.
3. **WARNING:** Do not expose the radio/cassette player or batteries to excessive heat, such as direct sunlight, fire, or other heat sources.
4. **WARNING:** Use only the attachments/accessories provided by the manufacturer, except for a standard 3.5 mm (1/8") auxiliary cable.
5. Do not place objects on top of the player.
6. Do not place the player on an unstable table, stand, tripod, bracket, or cart. The player may fall, resulting in possible damage or injury.
7. Unplug the power from the outlet during lightning storms or when the player is not in use.
8. Pay attention to the safety purpose of the polarized or grounding-type plug. A polarized plug has two blades with one wider than the other. A grounding type plug has two blades and a third grounding prong. The wide blade and/or the third prong is provided for your safety. If the provided plug does not fit into your outlet, consult an electrician to replace the obsolete outlet.
9. Protect the POWER cord from being walked on or pinched particularly at plugs, convenience receptacles, and the point where they exit from the player.
10. Dispose of this player properly, respecting your local laws for electronics and battery disposal.
11. DO NOT STARE INTO CD PLAYER LASER BEAM.

WARNING: THE POWER CORD ON THIS PRODUCT CONTAINS LEAD, A CHEMICAL KNOWN TO THE STATE OF CALIFORNIA TO CAUSE CANCER AND BIRTH DEFECTS OR OTHER REPRODUCTIVE HARM. WASH HANDS AFTER HANDLING.

FCC WARNINGS

This device complies with part 15 of the FCC Rules. Operation is subject to the following two conditions: (1) This device may not cause harmful interference, and (2) this device must accept any interference received, including interference that may cause undesired operation.

Any changes or modifications not expressly approved by the party responsible for compliance could void the user's authority to operate the equipment.



Note: This equipment has been tested and found to comply with the limits for a Class B digital device, pursuant to part 15 of the FCC Rules. These limits are designed to provide reasonable protection against harmful interference in a residential installation. This equipment generates uses and can radiate radio frequency energy and, if not installed and used in accordance with the instructions, may cause harmful interference to radio communications. However, there is no guarantee that interference will not occur in a particular installation. If this equipment does cause harmful interference to radio or television reception, which can be determined by turning the equipment off and on, the user is encouraged to try to correct the interference by one or more of the following measures:

- Reorient or relocate the receiving antenna.
- Increase the separation between the equipment and receiver.
- Connect the equipment into an outlet on a circuit different from that to which the receiver is connected.
- Consult the dealer or an experienced radio/TV technician for help.

Warning: Changes or modifications to this unit not expressly approved by the part responsible for compliance could void the user's authority to operate the equipment.

RF WARNING FOR PORTABLE DEVICE:

The device has been evaluated to meet general RF exposure requirement. The device can be used in portable exposure condition without restriction.

	<p style="text-align: center;">WARNING</p> <p style="text-align: center;">⚡ Risk of electric shock, do not open. !</p>	
<p>THE LIGHTNING FLASH WITH ARROWHEAD SYMBOL, WITHIN AN EQUILATERAL TRIANGLE, IS INTENDED TO ALERT THE USER TO THE PRESENCE OF NON-INSULATED "DANGEROUS VOLTAGE" WITHIN THE PRODUCT'S ENCLOSURE THAT MAY BE OF SUFFICIENT MAGNITUDE TO CONSTITUTE A RISK OF ELECTRIC SHOCK TO PERSONS.</p>	<p>TO REDUCE THE RISK OF ELECTRIC SHOCK, DO NOT REMOVE THE FRONT OR REAR COVER. NO USER SERVICEABLE PARTS ARE INSIDE. REFER SERVICING TO QUALIFIED SERVICE PERSONNEL.</p>	<p>THE EXCLAMATION POINT WITHIN AN EQUILATERAL TRIANGLE IS INTENDED TO ALERT THE USER TO THE PRESENCE OF IMPORTANT OPERATING AND MAINTENANCE (SERVICING) INSTRUCTIONS IN THE LITERATURE ACCOMPANYING THE APPLIANCE.</p>

INTRODUCTION

Congratulations on your purchase of this CD MP3 Stereo Boombox with AM FM Radio! For your safety, and to get the most enjoyment from your player, please completely read these instructions provided.

FEATURES

- CD MP3 Disc Playback (CD, CD-R/RW)
- AM/FM Radio
- Wireless Audio - Streaming from your Bluetooth® devices
- SD/USB/ Ports for MP3 Files Multimedia Player
- AUX in, 3.5 mm line in Jack - Connect your Devices
- 20 tracks Memory / Repeat options
- Headphone Jack
- Stereo Speakers
- LED color Flashing Lights with the Music Beat (on/off option)
- Folding Carry Handle
- Telescopic Antenna
- 4 Digit LED Display
- Runs an AC Power 120V or 6x C batteries
- Remote Control

WHATS IN THE BOX

- Your boombox
- This user manual
- A remote control
- A power cable

BATTERY INSTALLATION (BATTERIES NOT INCLUDED)

- The remote takes 2 AAA Batteries. When using the remote, be sure to point it at the front of the boombox.
- The boombox takes 6 C batteries but also plugs into the wall.

To install batteries into the remote or the boombox, open the battery cover on the back of the remote, or on the bottom of the boombox). Then, match the “+” and “-” signs with the batteries. Replace the battery cover. If the boombox unit is not used for an extended period of time, remove the batteries before storing it.

PRODUCT DIAGRAM

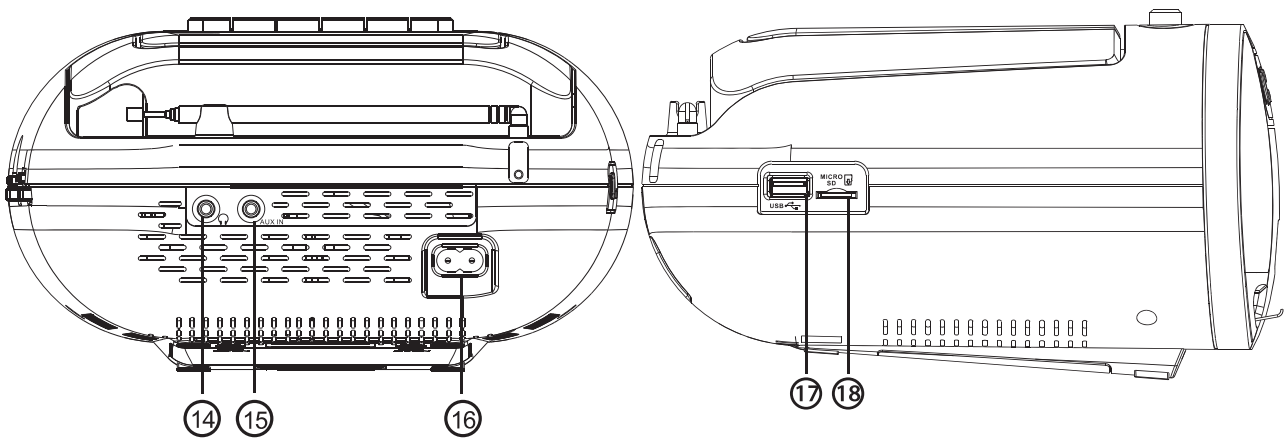
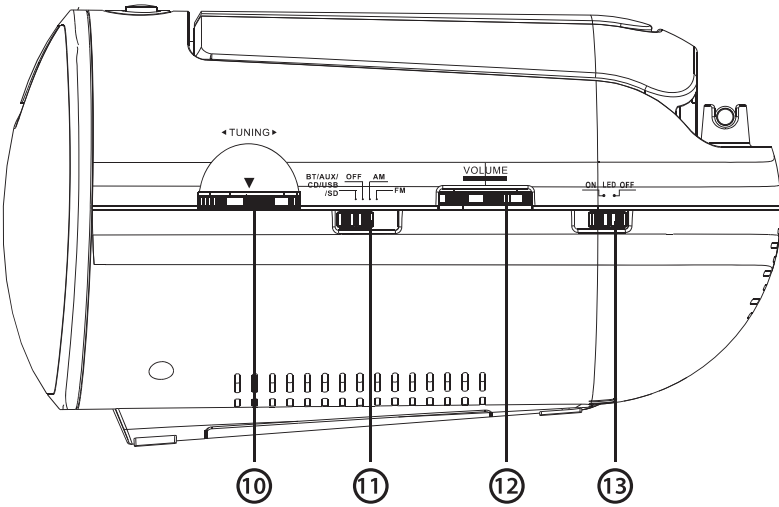
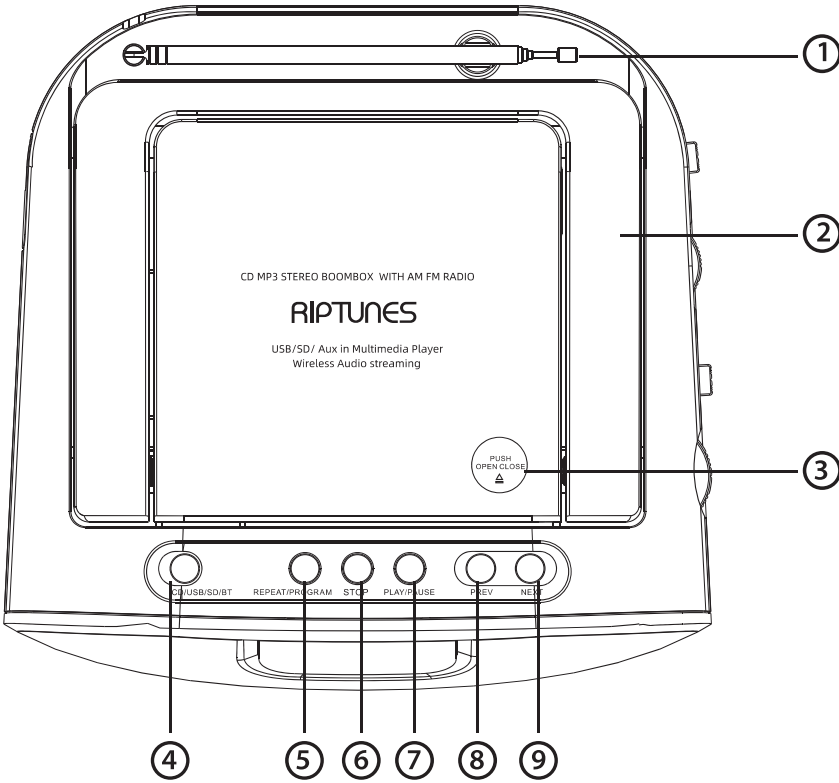

- 1. Telescopic antenna** (for FM radio only)
- 2. Handle** Collapsible carry handle.
- 3. CD Open** Press to open the lid and load a CD.
- 4. Mode** Cycles the mode when the function switch is set to “BT/AUX/CD/USB/TF”
 - **Bluetooth:** The “BT” Light will be on when this mode is selected. This mode plays back audio wirelessly from Bluetooth devices. For example, you can play a song from your phone over the speakers of the boombox.
 - **AUX:** This is for using the 3.5mm (1/8”) audio input on the side of the boombox.
 - **CD:** Play a standard audio CD or MP3 CD.
 - **USB:** Playback MP3 from a USB/Thumb drive.
 - **TF** (Also known as SD): Playback MP3s from a TF / SD Micro card.
- 5. Repeat/Program** Press once to repeat current song, twice to repeat all songs.
- 6. Stop:** Stop Playback
- 7. Play / Pause:** Play or Pause in CD/USB/BT/TF mode
- 8. Prev** BT/AUX/CD/USB/TF mode: Go to previous track; long press to fast reverse
- 9. Next** In BT/AUX/CD/USB/TF mode: Go to next track; long press for fast forward
- 10. Manual Tuning (For tuning FM/AM Radio Stations)**
- 11. Function switch:** This switch selects the operation mode between the main mode (Bluetooth/AUX/CD/USB/TF), OFF, FM or AM radio mode.
- 12. Volume control:** Roll this to adjust the volume
- 13. LED light Switch:** Switches the display’s backlight on/off.
- 14. Headphones** (🎧): You can connect headphones or earbuds here. The main speakers will be disabled while headphones are connected.
- 15. AUX IN:** You can connect an audio source that uses a 1/8” cable here, such as a mobile device or stand-alone MP3 player.
- 16. POWER:** Connect the power cable here.
- 17 / 18. USB / TF:** Connect a thumb drive (USB) or TF / SD card for MP3 playback, then enter USB or TF mode using the function switch (12) and mode button (4) to play back music.

ADDITIONAL MODES AND FUNCTIONS

PROGRAMMING A PLAYLIST

20 songs can be programmed for a standard audio CD, and 99 songs can be programmed for MP3 playback. To program music, press and hold the Program button while music is stopped. Then, use Prev/Next or enter the desired song number and press **PROG** to store it in the program playlist. Repeat as desired to add more songs. When done, press play to hear the playlist. Press **Stop** twice to reset/erase all programming.

REMOTE CONTROL

The buttons on the remote control work the same as they do on the boom box, but the remote has number keys which make it easier to program a list of songs for playback, including the **10+** and **10-** buttons. The display reading will only display song times, but you may use the **Dir+** and **Dir-** buttons to enter and exit a directory/folder on the MP3 disc, USB, or SD card.

RADIO MODE

Switch the mode switch on the side of the unit to AM or FM. Adjust the volume and tuning control as needed by ear and by using the frequency markings on the rolling dial. For FM, use the telescopic antenna to adjust signal reception. The antenna is not required for AM.

BLUETOOTH CONNECTION AND PLAYBACK

Slide the function switch to the first position, then press the mode button on the front panel to select Bluetooth (BT) mode. The BT button will light up on the front panel. Scan for Bluetooth devices on your phone. Connect to “**CDB237**”. After the connection is complete, play audio from your device. Also, the boombox has a mic, and you can press play twice to dial the last dialed number on your phone. Press play again to disconnect.

CARE AND MAINTENANCE

DISC HANDLING

- Do not expose discs to heat, direct sunlight, or high humidity environments. In warmer weather, do not leave discs inside a parked vehicle.
- Store discs in their cases when not in use.
- Stacking discs or standing them on end can cause them to warp.
- Do not touch the disc surface while handling the disc. Instead, hold the edges.
- Fingerprints, dust, dirt, and scratches can distort the picture or sound quality on your disc, or cause playback to skip. Beware of scratches on the disc inhibiting the laser beam system from reading and playing the disc correctly. Clean discs before use.
- Do not use paper, tape, or adhesive labels on discs. Only use permanent markers on the *top* side of the disc.
- Clean discs with a soft cloth, wiping from the center outwards. **DO NOT** wipe in a circular fashion



- Do not use solvents such as benzene, household cleaning products (except those designed for CD/DVD use), or anti-static spray for vinyl records, as this can damage your device and discs.
- Ensure the label always faces up when putting discs into the player.

CLEANING THE BOOMBOX

- **UNPLUG THE UNIT BEFORE CLEANING.** Use a soft, damp cloth to clean the outside. Do not wipe any internal parts or get them wet. Soapy water should be fine. Do not use any abrasive cleaning agents.

TROUBLESHOOTING

PROBLEM	SOLUTION
No power to unit	<ul style="list-style-type: none"> • Connect the power cord or install batteries.
No sound from speakers	<ul style="list-style-type: none"> • Make sure volume is up, and the unit has power. • Make sure headphones are not connected. • Make sure that the correct mode is selected for the music source you are using. Use the mode button and/or function selector (on the side and the unit).
Disc does not play properly	<ul style="list-style-type: none"> • Ensure that the disc is an Audio or MP3 CD. • Ensure the CD door is closed. • Ensure the disc is not scratched or dirty (dusty, soil, fingerprints, etc.) Try cleaning the disc.

TECHNICAL SPECIFICATIONS

Power: AC: 120V ~ 60Hz 11W
DC: 9V(UM2*6PCS)
Output: 1.0W+1.0W
CD Frequency response: 31.5Hz-16KHz+/-6dB

CD sample frequency: 44.1 kHz

Channel frequency response: 250Hz- 6.3KHz Frequency range:
FM: 88-108MHz AM: 520-1710kHz

TECHNICAL SUPPORT

For questions not answered in this manual, or for warranty service, please contact Riptunes Technical Support:

By phone: 1-888-217-7688 (9:00 AM to 6:00 PM ET)

By e-mail: service@rip-tunes.com

Online: www.rip-tunes.com

© 2020 Riptunes by Impecca, a division of LT Inc., Wilkes Barre, PA.

Bluetooth is a registered trademark of Bluetooth SIG, Inc.

LIMITED WARRANTY



ONE YEAR LIMITED WARRANTY / 90 Days

Riptunes™ warrants this product against defects in material and workmanship to the original purchaser as specified below provided product is registered online within fourteen (14) days of purchase.

PARTS - if the product is determined to have a manufacturing defect, within a period of one (1) year from the date of the original purchase, Riptunes™ will repair or replace the product parts at no charge (for parts) to you in the U.S.A. and Canada.

LABOR - if the product is determined to have a manufacturing defect, within a period of ninety (90) Days from the date of the original purchase, Riptunes™ will repair or replace the product at no charge to you in the U.S.A. and Canada, After ninety (90) days it will be the responsibility of the consumer.

Shipping costs to and from our warranty service center is the sole responsibility of the consumer.

To obtain warranty service by an authorized Riptunes™ service center, please email us at: support@riptunes.com to obtain a Repair and Maintenance Authorization (RMA) number and to locate the service center nearest you. Once authorized, you must mail the product, to the authorized Riptunes™ service center in its original product packaging materials or equivalent, to prevent damage while in transit.

Further, should Riptunes™ determine that the product is outside of the Warranty term, Riptunes™ will return the product to sender at sender's expense without being repaired or replaced, unless authorized by the consumer to service the out of warranty product at consumer's expense. All handling or restocking charges for returns and/or replacements shall be non-refundable.

Riptunes™ specifically excludes from this warranty any non-electric/mechanical attachments, accessories and disposable parts including but not limited to outside case, connecting cables, batteries and AC adaptors. Riptunes™ reserves the right to repair or replace defective products with the same, equivalent or newer models.

We reserve the right to either repair or replace product at our discretion. Replacement may be either new or refurbished and while every endeavor will be made to ensure it is the same model, if same model is not available it will be replaced with a model of equal or higher specification.

Normal "Wear and Tear" is not covered by this warranty. Further, Riptunes™ hereby reserves the right to determine "Wear and Tear" on any and all products. Tampering or opening the product casting or shell, will void this warranty in its entirety.

Also this warranty does not apply if the product has been damaged by accident, abuse, misuse, or misapplication; has been altered or modified without the written permission of Riptunes™; has been serviced by a non-authorized repair center of Riptunes™; has not been properly maintained or operated according to the operation manual; has been used for commercial, non-household purposes; cosmetically damaged; was not imported by Riptunes™; was not manufactured according to specification of the United States market; improper installation or neglect; damaged due to improper packaging in shipment; damaged due to natural disasters; if the serial number for the product has been removed or defaced; or for cosmetic damages.

ALL IMPLIED WARRANTIES, INCLUDING IMPLIED WARRANTIES OF MERCHANTABILITY AND FITNESS FOR A PARTICULAR PURPOSE ARE LIMITED IN DURATION TO ONE (1) YEAR PARTS AND NINETY (90) DAYS LABOR FROM THE DATE OF THE ORIGINAL RETAIL PURCHASE OF THIS PRODUCT.

THESE WARRANTIES AND REMEDIES ARE THE SOLE AND EXCLUSIVE WARRANTIES AND REMEDIES IN CONNECTION WITH THE SALE AND USE OF THE PRODUCT. NO OTHER WARRANTIES, ORAL OR WRITTEN, EXPRESSED OR IMPLIED, ARE GIVEN.

RIPTUNES™ IS NOT RESPONSIBLE OR LIABLE FOR ANY DAMAGE, WHETHER SPECIAL, INCIDENTAL, CONSEQUENTIAL, DIRECT OR OTHERWISE, OR WHETHER KNOWN OR SHOULD HAVE BEEN KNOWN TO RIPTUNES™, INCLUDING LOST PROFITS, GOODWILL, AND PROPERTY AND PERSONAL INJURY RESULTING FROM ANY BREACH OF WARRANTY, THE INABILITY TO USE THE PRODUCT OR UNDER ANY LEGAL THEORY IN CONTRACT OR TORT. RIPTUNES LIABILITY IS LIMITED TO THE ACTUAL PURCHASE PRICE PAID TO THE RETAIL SELLER OF THE DEFECTIVE PRODUCT.

No Riptunes™ dealer, agent or employee is authorized to make any modification, extension, change or amendment to this warranty without the written consent and authorization from Riptunes™.

Some states do not allow the exclusion or limitation of implied warranties or liability for incidental or consequential damages, or do not allow a limitation on how long an implied warranty lasts, so the above limitations or exclusions may not apply to you. This warranty gives you specific legal rights, and you have other rights, which vary from state to state.

Note: Our Warranty center ships only within Continental U.S., excluding Alaska and Hawaii.

Important: Be Sure to Register Your Product at WWW.RIP-TUNES.COM within 14 Days

Riptunes™ USA | PA 18711 | www.rip-tunes.com | support@rip-tunes.com

**Do not send any returns to this address, as it might get lost and this will delay your repair and service process.*

ENGLISH

ESPAÑOL

FRANÇAIS

TABLA DE CONTENIDO

Precauciones de Seguridad	13
Advertencias FCC.....	14
Introducción.....	15
Diagrama del Producto.....	16
Modos y Funciones Adicionales	16
Cuidado y Mantenimiento	18
Solución de Problemas.....	19
Especificaciones Técnicas.....	20
Soporte Técnico	20
Garantía	21
Français	22

PRECAUCIONES DE SEGURIDAD

LEA ESTE MANUAL CUIDADOSAMENTE ANTES DE OPERAR Y CONSÉRVELO PARA REFERENCIA A FUTURO. REFIÉRASE A ÉL CUANDO SE ENCUENTRE CUALQUIER PROBLEMA DE OPERACIÓN.

1. **ADVERTENCIA:** Para reducir el riesgo de descarga eléctrica o daño a los altavoces principales del reproductor, no desarme el reproductor. No hay partes internas a las que el usuario pueda darles servicio.
2. **ADVERTENCIA:** Para evitar fuego o descargas eléctricas, no exponga el reproductor a la lluvia o humedad (incluyendo gotas o salpicaduras). No deben colocarse sobre el reproductor o cerca de él, objetos llenos con líquidos, como floreros o botellas de agua.
3. **ADVERTENCIA:** No se exponga el reproductor de radio/casete o sus baterías al calor excesivo, como la luz directa del sol, fuego, u otras fuentes de calor.
4. **ADVERTENCIA:** Utilice solamente los accesorios provistos por el fabricante, a excepción del cable auxiliar estándar de 3.5mm.
5. No coloque objetos encima del reproductor.
6. No coloque el reproductor en una mesa inestable, trípode, soporte o carrito. El reproductor puede caer, resultando en posibles lesiones o daños.
7. Desconecte del tomacorrientes durante las tormentas eléctricas o cuando el reproductor no esté en uso.
8. Ponga atención a la medida de seguridad de la clavija polarizada o del tipo aterrizado. Una clavija polarizada tiene dos patas siendo una de ellas más ancha que la otra. Una clavija del tipo aterrizado tiene dos patas planas y una redonda, siendo que la redonda es la conexión a tierra. Esta tercera pata es proporcionada para su seguridad. Si la clavija proporcionada no puede enchufarse al tomacorrientes, consulte con un electricista para reemplazar el tomacorrientes obsoleto.
9. Proteja el cable de suministro eléctrico contra pisadas o pellizcos particularmente en los enchufes, receptáculos de conveniencia y el punto donde sale del reproductor.
10. Disponga de este reproductor adecuadamente, respetando sus leyes locales para el desecho de electrónicos y baterías.
11. **NO SE LE QUEDE VIENDO AL RAYO LÁSER DEL REPRODUCTOR CD.**

ADVERTENCIA: EL CABLE DE SUMINISTRO ELÉCTRICO DE ESTE PRODUCTO CONTIENE PLOMO, UN QUÍMICO CONOCIDO EN EL ESTADO DE CALIFORNIA POR CAUSAR CÁNCER Y DEFECTOS DE NACIMIENTO Y OTROS DAÑOS EN LA REPRODUCCIÓN. LÁVESE LAS MANOS DESPUÉS DE MANIPULARLO.

ADVERTENCIAS FCC

Este dispositivo cumple con la parte 15 de las Reglas de la FCC. El funcionamiento está sujeto a las dos condiciones siguientes: (1) Este dispositivo no puede causar interferencias perjudiciales, y (2) este dispositivo debe aceptar cualquier interferencia recibida, incluidas las interferencias que puedan causar un funcionamiento no deseado.

Cualquier cambio o modificación no aprobada expresamente por la parte responsable del cumplimiento puede anular la autoridad del usuario para operar el equipo.



Nota: Este equipo ha sido probado y cumple con los límites para un dispositivo digital de Clase B, de conformidad con la parte 15 de las Reglas de la FCC. Estos límites están diseñados para proporcionar una protección razonable contra interferencias dañinas en una instalación residencial. Este equipo genera y puede irradiar energía de radiofrecuencia y, si no se instala y utiliza de acuerdo con las instrucciones, puede causar interferencias perjudiciales a las comunicaciones de radio. Sin embargo, no hay garantía de que la interferencia no ocurra en una instalación en particular. Si este equipo causa interferencia dañina a la recepción de radio o televisión, lo que puede determinarse apagando y encendiendo el equipo, se recomienda al usuario que intente corregir la interferencia mediante una o más de las siguientes medidas:

- Reorientar o reubicar la antena receptora.
- Aumente la separación entre el equipo y el receptor.
- Conecte el equipo a una toma de corriente en un circuito diferente al que está conectado el receptor.
- Solicite ayuda al distribuidor o a un técnico experimentado de radio / TV.

Advertencia: Los cambios o modificaciones a esta unidad que no estén expresamente aprobados por la parte responsable del cumplimiento podrían anular la autoridad del usuario para operar el equipo.

ADVERTENCIA DE RF PARA DISPOSITIVOS PORTÁTILES:

El dispositivo ha sido evaluado para cumplir con los requisitos generales de exposición a RF. El dispositivo se puede usar en condiciones de exposición portátil sin restricciones.

		
<p>EL SÍMBOLO DE RAYO CON PUNTA DE FLECHA DENTRO DE UN TRIANGULO EQUILATERO TIENE EL PROPÓSITO DE ALERTAR AL USUARIO SOBRE LA PRESENCIA DE 'VOLTAJE PELIGROSO' NO-AISLADO DENTRO DE LA CARCASA DEL PRODUCTO QUE PUEDE SER DE LA MAGNITUD SUFICIENTE PARA CONSTITUIR RIESGO DE DESCARGA ELECTRICA PARA LAS PERSONAS.</p>	<p>PARA REDUCIR EL RIESGO DE DESCARGA ELÉCTRICA, NO RETIRE LA CUBIERTA DELANTERA O POSTERIOR. NO HAY PARTES ADENTRO A LAS QUE EL USUARIO PUEDA DARLES SERVICIO. SOLICITE SERVICIO A UNA PERSONA CALIFICADA.</p>	<p>EL SIGNO DE EXCLAMACIÓN DENTRO DE UN TRIANGULO EQUILÁTERO TIENE EL PROPÓSITO DE ALERTAR AL USUARIO SOBRE LA PRESENCIA DE INSTRUCCIONES IMPORTANTES DE OPERACIÓN Y MANTENIMIENTO (SERVICIO) EN LA LITERATURA QUE ACOMPAÑA A ESTE APARATO.</p>

INTRODUCCIÓN

¡Felicidades por su compra de este CD MP3 estéreo Boombox con radio AM FM! Por su seguridad y para que pueda disfrutar de la mejor forma su reproductor, por favor, le pedimos que lea completamente estas instrucciones.

CARACTERÍSTICAS

- Puede reproducir CD MP3 discos (CD, CD-R y CD-RW)
- Radio AM/FM, antena telescópica
- Audio inalámbrico: transmisión desde sus dispositivos Bluetooth®
- SD / USB / Puertos para archivos MP3 reproductor multimedia
- Entrada de cable Aux 3.5 mm - Conecte sus dispositivos
- 20 pistas Opciones de memoria / repetición
- Altavoces estéreo, toma de auriculares
- Luces intermitentes de color LED con Music Beat
- Asa de transporte plegable
- Pantalla LED de 4 dígitos
- Funciona con una alimentación de CA de 120 V o 6 baterías C)
- Control remoto

QUÉ HAY EN LA CAJA

- Su Boombox
- Este manual de usuario
- Un control remoto
- Un cable de suministro eléctrico

INSTALACIÓN DE BATERÍAS (LAS BATERÍAS NO SE INCLUYEN)

- El control remoto utiliza 2 baterías AAA. Cuando use el control remoto asegúrese de apuntar al frente del Boombox.
- El Boombox necesita 6 baterías C pero también puede conectarse a la corriente alterna (AC).

Para instalar las baterías en el control remoto o en el Boombox, abra la tapa de las baterías en la parte posterior del control remoto o en la parte inferior del Boombox. Luego haga coincidir los signos “+” y “-” con las baterías. Vuelva a colocar la tapa de las baterías. Si la unidad boombox no se usa por un periodo de tiempo prolongado, retire las baterías antes de almacenarlo.