

## FCC RADIO TEST REPORT

The device described below is tested by Dongguan Nore Testing Center Co., Ltd. to determine the maximum emission levels emanating from the device, the severe levels which the device can endure and E.U.T.'s performance criterion. The test results, data evaluation, test procedures, and equipment of configurations shown in this report were made in accordance with the procedures in ANSI C63.10(2013).

Applicant : Luzerne Trading Company, Inc.  
Address : 171-47th Street, Brooklyn New York United States  
Manufacturer /Factory : LEOTEC ELECTRONICS CO., LTD  
Address : 174 Wenzhou Road, Dongcheng Street, Dongguan City, Guangdong Province, China  
E.U.T. : CD MP3 Stereo Boombox with AM FM Radio  
Brand Name : RIPTUNES  
Model No. : CDB-237BT  
FCC ID : 2AIO5CDB237BT  
Measurement Standard : FCC PART 15.247  
Date of Receiver : July 28, 2020  
Date of Test : July 29, 2020 to August 18, 2020  
Date of Report : August 19, 2020

This Test Report is Issued Under the Authority of :

Prepared by



Alina Guo / Engineer

Approved & Authorized Signer



Iori Fan / Authorized Signatory

This test report is for the customer shown above and their specific product only. This report applies to above tested sample only and shall not be reproduced in part without written approval of Dongguan Nore Testing Center Co., Ltd.

---

## Table of Contents

<b>1. GENERAL INFORMATION</b>	<b>5</b>
1.1 PRODUCT DESCRIPTION FOR EQUIPMENT UNDER TEST	5
1.2 RELATED SUBMITTAL(S) / GRANT (S)	8
1.3 TEST METHODOLOGY	8
1.4 EQUIPMENT MODIFICATIONS	8
1.5 SUPPORT DEVICE	8
1.6 TEST FACILITY AND LOCATION	9
1.7 DEVIATIONS AND ABNORMALITIES FROM STANDARD CONDITIONS	9
1.8 SUMMARY OF TEST RESULTS	10
<b>2. SYSTEM TEST CONFIGURATION</b>	<b>11</b>
2.1 EUT CONFIGURATION	11
2.2 SPECIAL ACCESSORIES	11
2.3 DESCRIPTION OF TEST MODES	11
2.4 EUT EXERCISE	11
<b>3. CONDUCTED EMISSIONS TEST</b>	<b>12</b>
3.1 TEST SET-UP (BLOCK DIAGRAM OF CONFIGURATION)	12
3.2 TEST CONDITION	12
3.3 MEASUREMENT RESULTS	12
<b>4. RADIATED EMISSION TEST</b>	<b>15</b>
4.1 TEST SET-UP (BLOCK DIAGRAM OF CONFIGURATION)	15
4.2 MEASUREMENT PROCEDURE	16
4.3 LIMIT	17
4.4 MEASUREMENT RESULTS	17
<b>5. CHANNEL SEPARATION TEST</b>	<b>21</b>
5.1 MEASUREMENT PROCEDURE	21
5.2 TEST SET-UP (BLOCK DIAGRAM OF CONFIGURATION)	21
5.3 MEASUREMENT RESULTS	21
<b>6. 20DB BANDWIDTH</b>	<b>25</b>
6.1 MEASUREMENT PROCEDURE	25
6.2 TEST SET-UP (BLOCK DIAGRAM OF CONFIGURATION)	25
6.3 MEASUREMENT RESULTS	25
<b>7. HOPPING CHANNEL NUMBER</b>	<b>29</b>
7.1 MEASUREMENT PROCEDURE	29
7.2 TEST SET-UP (BLOCK DIAGRAM OF CONFIGURATION)	29
7.3 MEASUREMENT RESULTS	29



---

<b>8. TIME OF OCCUPANCY (DWELL TIME)</b> .....	<b>31</b>
8.1 MEASUREMENT PROCEDURE .....	31
8.2 MEASUREMENT RESULTS .....	31
<b>9. MAXIMUM PEAK OUTPUT POWER</b> .....	<b>35</b>
9.1 MEASUREMENT PROCEDURE .....	35
9.2 MEASUREMENT RESULTS .....	35
<b>10. BAND EDGE AND RESTRICTION BANDS</b> .....	<b>39</b>
10.1 MEASUREMENT PROCEDURE .....	39
10.2 LIMIT .....	39
10.3 MEASUREMENT RESULTS .....	39
<b>11. ANTENNA APPLICATION</b> .....	<b>44</b>
11.1 ANTENNA REQUIREMENT.....	44
11.2 MEASUREMENT RESULTS .....	44
<b>12. CONDUCTED SPURIOUS EMISSIONS</b> .....	<b>45</b>
12.1 MEASUREMENT PROCEDURE .....	45
12.2. MEASUREMENT RESULTS .....	45
<b>13. TEST EQUIPMENT LIST</b> .....	<b>49</b>



---

## 1. GENERAL INFORMATION

### 1.1 Product Description for Equipment under Test

Product Name	:	CD MP3 Stereo Boombox with AM FM Radio
Main Model Number	:	CDB-237BT
Additional Model Number	:	N/A
Description of Model Difference	:	N/A
Brand Name	:	RIPTUNES
Rating	:	AC 120V 60Hz 11W DC 9V from UM-2*6
Adapter	:	N/A
Test voltage	:	AC 120V 60Hz, DC 9V (Only the worst case was recorded in this report)
Cable	:	AC Line: 185cm unshielded
Hardware Version	:	V01
Software Version	:	V01
Serial number	:	CDE0820L10001R - CDE0820L13500R
Note	:	N/A
Remark	:	N/A

---

### Technical parameters

Bluetooth Version	: BT4.2+EDR
Frequency Range	: 2402-2480MHz
Modulation	: GFSK, $\pi/4$ -DQPSK
Number of Channel	: 79
Channel space	: 1MHz
Date Rate	: 1Mbps for GFSK 2Mbps for $\pi/4$ -DQPSK
Antenna Type	: PCB antenna
Antenna Gain	: -0.58 dBi (Declared by manufacturer)

**Channel List**

Channel	Frequency MHz	Channel	Frequency MHz	Channel	Frequency MHz	Channel	Frequency MHz
1	2402	21	2422	41	2442	61	2462
2	2403	22	2423	42	2443	62	2463
3	2404	23	2424	43	2444	63	2464
4	2405	24	2425	44	2445	64	2465
5	2406	25	2426	45	2446	65	2466
6	2407	26	2427	46	2447	66	2467
7	2408	27	2428	47	2448	67	2468
8	2409	28	2429	48	2449	68	2469
9	2410	29	2430	49	2450	69	2470
10	2411	30	2431	50	2451	70	2471
11	2412	31	2432	51	2452	71	2472
12	2413	32	2433	52	2453	72	2473
13	2414	33	2434	53	2454	73	2474
14	2415	34	2435	54	2455	74	2475
15	2416	35	2436	55	2456	75	2476
16	2417	36	2437	56	2457	76	2477
17	2418	37	2438	57	2458	77	2478
18	2419	38	2439	58	2459	78	2479
19	2420	39	2440	59	2460	79	2480
20	2421	40	2441	60	2461		

**Note:** According to section 15.31(m), regards to the operating frequency range over 10MHz, the Lowest, middle, and the Highest frequency of channel were selected to perform the test. The selected frequency and test software see below:

<b>Channel</b>	<b>Frequency MHz</b>
1	2402
40	2441
79	2480
Test SW version	FCCAssist 2.4

## 1.2 Related Submittal(s) / Grant (s)

This submittal(s) (test report) is intended for **FCC ID: 2AIO5CDB237BT** filing to comply with Section 15.247 of the FCC Part 15, Subpart C Rule.

## 1.3 Test Methodology

Both AC mains line-conducted and radiated emission measurements were performed according to the procedures in ANSI C63.10 (2013). Radiated emission measurement was performed in semi-anechoic chamber and conducted emission measurement was performed in shield room. For radiated emission measurement, preliminary scans were performed in the semi-anechoic chamber only to determine the worst case modes. All radiated tests were performed at an antenna to EUT distance of 3 meters.

## 1.4 Equipment Modifications

Not available for this EUT intended for grant.

## 1.5 Support Device

Notebook	:	Manufacturer: IBM Model: 1834 P/N: 13N5615
Adapter (For Notebook)	:	Manufacturer: Huntkey Model: HKA09019047-6D I/P: AC 100-240V 50-60Hz, 1.5A O/P: DC 19V 4.74A



## 1.6 Test Facility and Location

Site Description

EMC Lab : Listed by CNAS, August 13, 2018  
The certificate is valid until August 13, 2024  
The Laboratory has been assessed and proved to be in compliance with CNAS/CL01  
The Certificate Registration Number is L5795.

Listed by A2LA, November 01, 2017  
The certificate is valid until December 31, 2021  
The Laboratory has been assessed and proved to be in compliance with ISO17025  
The Certificate Registration Number is 4429.01

Listed by FCC, November 06, 2017  
The Designation Number is CN1214  
Test Firm Registration Number: 907417

Listed by Industry Canada, June 08, 2017  
The Certificate Registration Number. Is 46405-9743A

Name of Firm : Dongguan Nore Testing Center Co., Ltd.  
(Dongguan NTC Co., Ltd.)

Site Location : Building D, Gaosheng Science and Technology Park,  
Hongtu Road, Nancheng District, Dongguan City,  
Guangdong Province, China

## 1.7 Deviations and Abnormalities from Standard Conditions

No additions, deviations and exclusions from the standard.

### 1.8 Summary of Test Results

FCC Rules	Description Of Test	Uncertainty	Result
§15.247(a)(1)	Channel Separation test	$\pm 1.42 \times 10^{-4}\%$	Compliant
§15.247(a)(1)	20dB Bandwidth	$\pm 1.42 \times 10^{-4}\%$	Compliant
§15.247(a)(1)(iii)	Hopping Channel Number	$\pm 1.42 \times 10^{-4}\%$	Compliant
§15.247(a)(1)(iii)	Time of Occupancy (Dwell Time)	$\pm 5\%$	Compliant
§15.247(b)	Max Peak output Power test	$\pm 1.06\text{dB}$	Compliant
§15.247(d)	Band edge test	$\pm 1.70\text{dB}$	Compliant
§15.207 (a)	AC Power Conducted Emission	$\pm 1.06\text{dB}$	Compliant
§15.247(d), §15.209, §15.205	Radiated Emission	$\pm 4.60\text{dB}$	Compliant
§15.203	Antenna Requirement	N/A	Compliant
§15.247(d)	Conducted Spurious Emission	$\pm 1.70\text{dB}$	Compliant

---

## 2. System Test Configuration

### 2.1 EUT Configuration

The EUT configuration for testing is installed on RF field strength measurement to meet the Commissions requirement and operating in a manner which intends to maximize its emission characteristics in a continuous normal application.

### 2.2 Special Accessories

Not available for this EUT intended for grant.

### 2.3 Description of test modes

The EUT has been tested under operating condition. Test program used to control the EUT for staying in continuous transmitting and normal mode is programmed. The Lowest, middle and highest channel were chosen for testing, and all packets DH1, DH3 and DH5 mode in all modulation type GFSK,  $\pi/4$ -DQPSK were tested.

### 2.4 EUT Exercise

The EUT was operated in the engineering mode to fix the Tx frequency that was for the purpose of the measurements.

### 3. Conducted Emissions Test

#### 3.1 Test SET-UP (Block Diagram of Configuration)

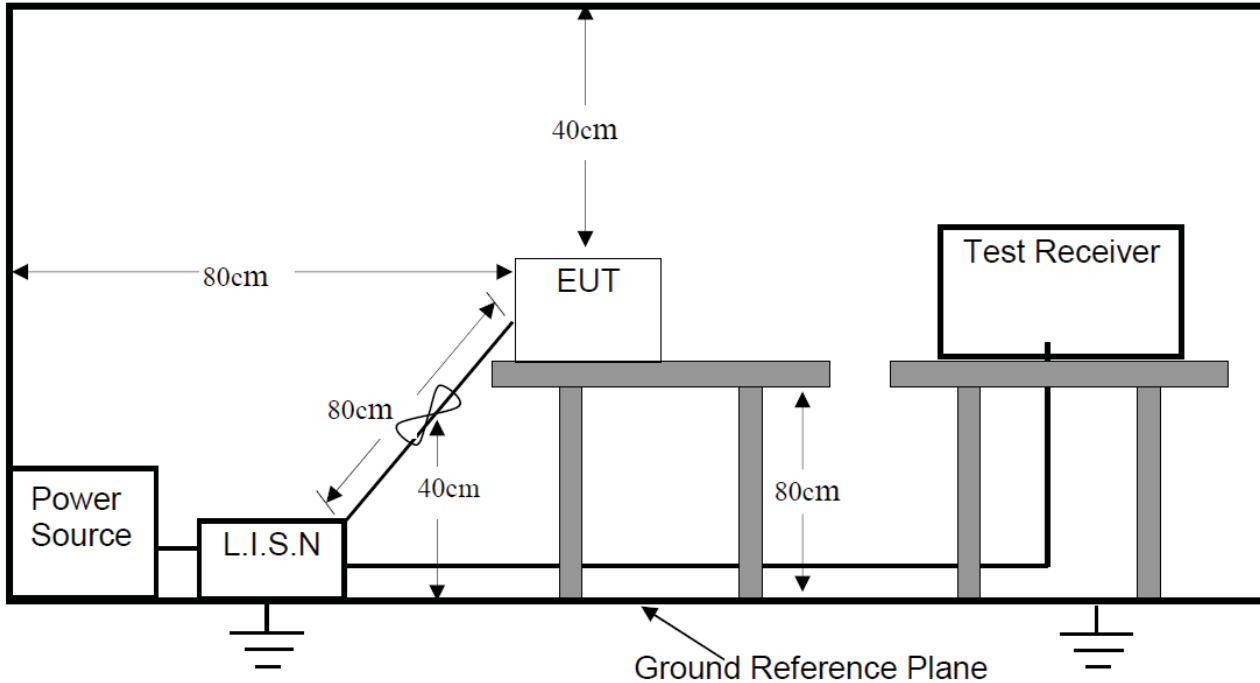

#### 3.2 Test Condition

Test Requirement: FCC Part 15.207

Frequency Range: 150KHz ~ 30MHz

Detector: RBW 9KHz, VBW 30KHz

Operation Mode: TX

#### 3.3 Measurement Results

**PASS**

Please refer to the following pages of the worst case:  $\pi/4$ -DQPSK (Low Channel).



Dongguan NTC Co., Ltd.  
 Tel: +86-769-22022444 Fax: +86-769-22022799  
 Web: [Http://www.ntc-c.com](http://www.ntc-c.com)

Conducted Emission Measurement

File : CDB-237BT Data :#15 Date: 2020/8/4 Time: 14:52:52

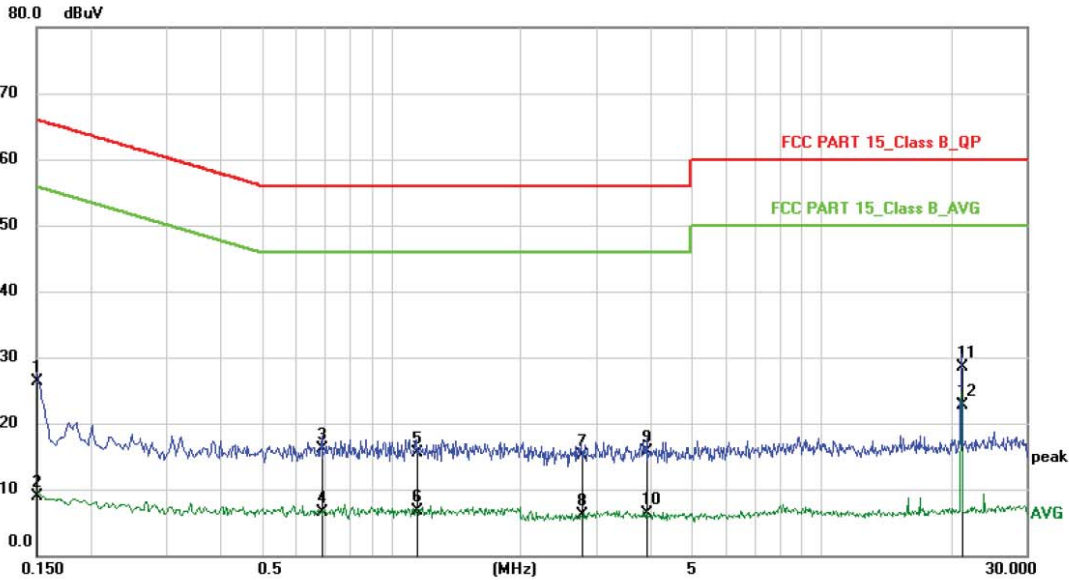

Site: Phase: **L1** Temperature: 26  
 Limit: FCC PART 15\_Class B\_QP Power: AC120V/60Hz Humidity: 50 %  
 EUT: CD MP3 Stereo Boombox with AM FM Radio  
 M/N: CDB-237BT  
 Mode: TX  
 Note:

No.	Mk.	Freq.	Reading Level	Correct Factor	Measurement	Limit	Over	Detector	Comment
		MHz	dBuV	dB	dBuV	dBuV	dB		
1		0.1500	15.70	10.60	26.30	66.00	-39.70	QP	
2		0.1500	-1.70	10.60	8.90	56.00	-47.10	AVG	
3		0.6900	5.44	10.66	16.10	56.00	-39.90	QP	
4		0.6900	-4.16	10.66	6.50	46.00	-39.50	AVG	
5		1.1460	4.90	10.70	15.60	56.00	-40.40	QP	
6		1.1460	-3.90	10.70	6.80	46.00	-39.20	AVG	
7		2.7780	4.49	10.71	15.20	56.00	-40.80	QP	
8		2.7780	-4.61	10.71	6.10	46.00	-39.90	AVG	
9		3.9340	5.09	10.71	15.80	56.00	-40.20	QP	
10		3.9340	-4.31	10.71	6.40	46.00	-39.60	AVG	
11		21.1740	17.73	10.77	28.50	60.00	-31.50	QP	
12	*	21.1740	12.03	10.77	22.80	50.00	-27.20	AVG	



Dongguan NTC Co., Ltd.  
 Tel: +86-769-22022444 Fax: +86-769-22022799  
 Web: [Http://www.ntc-c.com](http://www.ntc-c.com)

**Conducted Emission Measurement**

File : CDB-237BT Data :#16 Date: 2020/8/4 Time: 14:59:57

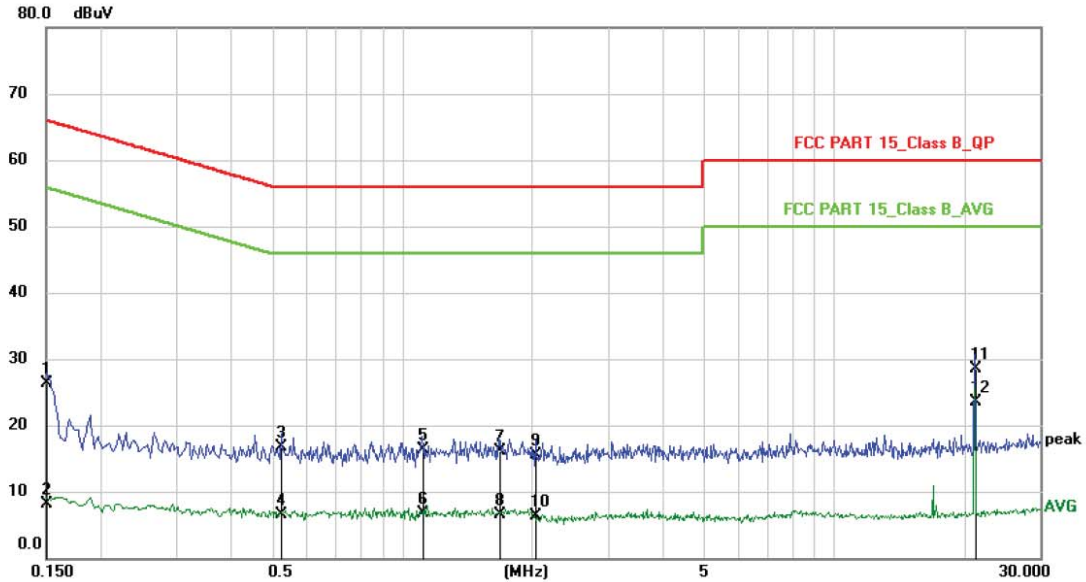

Site: Phase: **N** Temperature: 26  
 Limit: FCC PART 15\_Class B\_QP Power: AC120V/60Hz Humidity: 50 %  
 EUT: CD MP3 Stereo Boombox with AM FM Radio  
 M/N: CDB-237BT  
 Mode: TX  
 Note:

No.	Mk.	Freq. MHz	Reading Level dBuV	Correct Factor dB	Measure- ment dBuV	Limit dBuV	Over dB	Detector	Comment
1		0.1500	15.70	10.60	26.30	66.00	-39.70	QP	
2		0.1500	-2.40	10.60	8.20	56.00	-47.80	AVG	
3		0.5260	6.07	10.63	16.70	56.00	-39.30	QP	
4		0.5260	-4.13	10.63	6.50	46.00	-39.50	AVG	
5		1.1140	5.70	10.70	16.40	56.00	-39.60	QP	
6		1.1140	-3.90	10.70	6.80	46.00	-39.20	AVG	
7		1.6740	5.40	10.70	16.10	56.00	-39.90	QP	
8		1.6740	-4.20	10.70	6.50	46.00	-39.50	AVG	
9		2.0420	4.90	10.70	15.60	56.00	-40.40	QP	
10		2.0420	-4.40	10.70	6.30	46.00	-39.70	AVG	
11		21.1700	17.83	10.77	28.60	60.00	-31.40	QP	
12	*	21.1700	12.83	10.77	23.60	50.00	-26.40	AVG	

## 4. Radiated Emission Test

### 4.1 Test SET-UP (Block Diagram of Configuration)

#### 4.1.1 Radiated Emission Test Set-Up, Frequency Below 30MHz

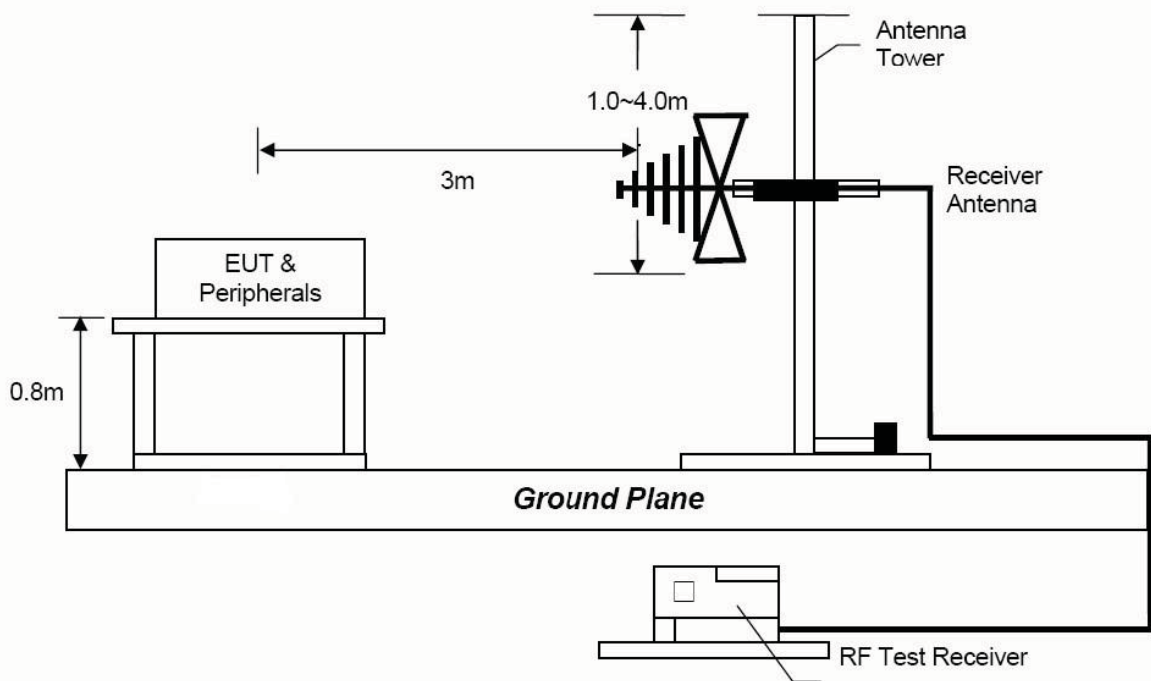
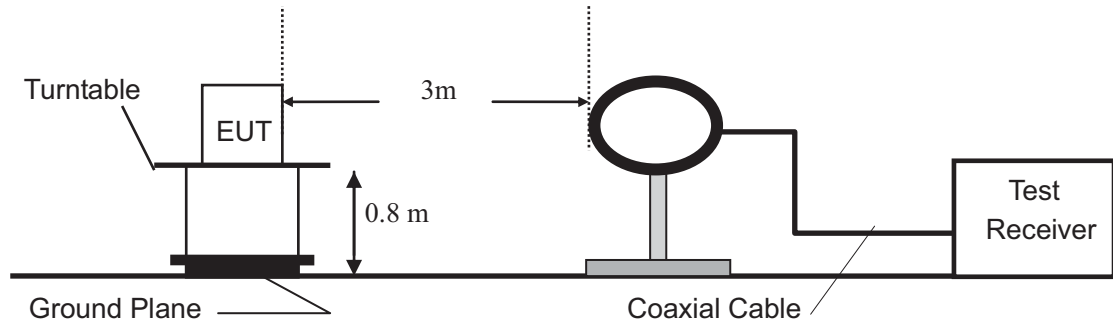

#### 4.1.2 Radiated Emission Test Set-Up, Frequency above 1GHz

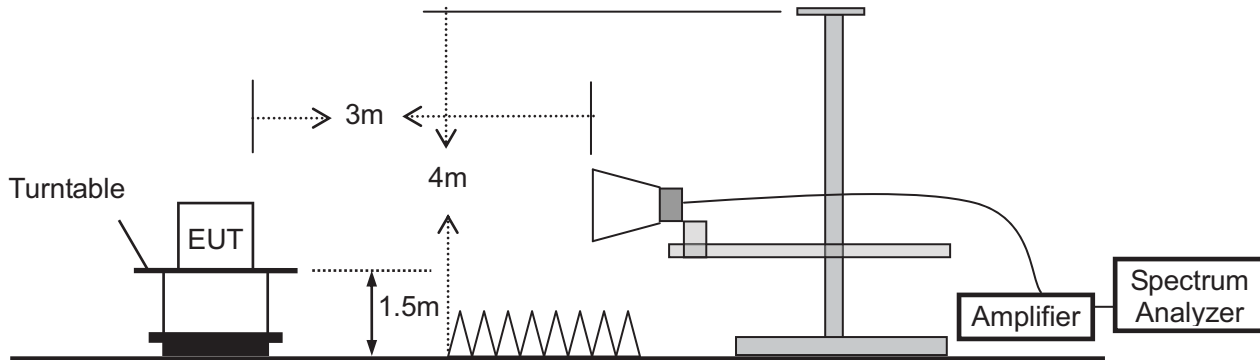

#### 4.2 Measurement Procedure

- a. Blow 1GHz, the EUT was placed on the top of a rotating table 0.8 meters above the ground at a 3 meter semi- anechoic chamber room.
- b. For the radiated emission test above 1GHz:  
The EUT was placed on the top of a rotating table 1.5 meters above the ground at a 3 meter full anechoic chamber room. The table was rotated 360 degrees to determine the position of the highest radiation. Place the measurement antenna away from each area of the EUT determined to be a source of emissions at the specified measurement distance, while keeping the measurement antenna aimed at the source of emissions at each frequency of significant emissions, with polarization oriented for maximum response. The measurement antenna may have to be higher or lower than the EUT, depending on the radiation pattern of the emission and staying aimed at the emission source for receiving the maximum signal. The final measurement antenna elevation shall be that which maximizes the emissions. The measurement antenna elevation for maximum emissions shall be restricted to a range of heights of from 1 m to 4 m above the ground or reference ground plane.
- c. The EUT was set 3 meters away from the interference-receiving antenna, which was mounted on the top of a variable-height antenna tower.
- d. The height of antenna is varied from one meter to four meters above the ground to determine the maximum value of the field strength. Both horizontal and vertical polarizations of the antenna are set to make the measurement.
- e. For each suspected emission, the EUT was arranged to its worst case and then the antenna was tuned to heights from 1 meter to 4 meters and the rotatable table was turned from 0 degrees to 360 degrees to find the maximum reading. The test-receiver system was set to peak detect function and specified bandwidth with maximum hold mode.
- f. A Quasi-peak measurement was then made for that frequency point for below 1GHz test. PK and AV for above 1GHz emission test.



During the radiated emission test, the spectrum analyzer was set with the following configurations:

Frequency Band (MHz)	Level	Resolution Bandwidth	Video Bandwidth
30 to 1000	QP	120 kHz	300 kHz
Above 1000	Peak	1 MHz	3 MHz
	Average	1 MHz	10 Hz

### 4.3 Limit

Frequency range MHz	Distance Meters	Field Strengths Limit (15.209)
		$\mu\text{V}/\text{m}$
0.009 ~ 0.490	300	$2400/F(\text{kHz})$
0.490 ~ 1.705	30	$24000/F(\text{kHz})$
1.705 ~ 30	30	30
30 ~ 88	3	100
88 ~ 216	3	150
216 ~ 960	3	200
Above 960	3	500

- Remark:
- (1) Emission level (dB) $\mu\text{V}$  = 20 log Emission level  $\mu\text{V}/\text{m}$
  - (2) The smaller limit shall apply at the cross point between two frequency bands.
  - (3) As shown in 15.35(b), for frequencies above 1000MHz, the field strength limits are based on average detector, however, the peak field strength of any emission shall not exceed the maximum permitted average limits, specified above by more than 20dB under any condition of modulation.
  - (4) The frequency range scanned is from the lowest radio frequency signal generated in the device which is greater than 9 kHz to the tenth harmonic of the highest fundamental frequency or 40 GHz, whichever is lower.

### 4.4 Measurement Results

**PASS**

Please refer to following plots of the worst case:  $\pi/4$ -DQPSK (Low Channel).



Dongguan NTC Co., Ltd.  
 Tel:+86-769-22022444 Fax:+86-769-22022799  
 Web: [Http://www.ntc-c.com](http://www.ntc-c.com)

**Radiated Emission Measurement**

File :CDB237 Data :#19 Date: 2020/8/6 Time: 18:00:56

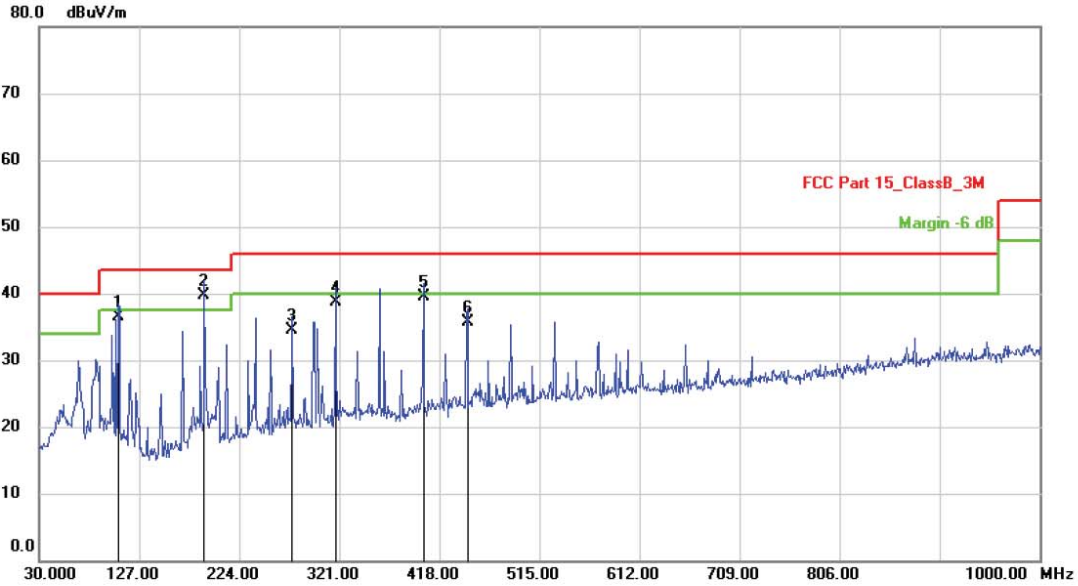

Site: 3m Chamber Polarization: *Horizontal* Temperature: 26  
 Limit: FCC Part 15\_ClassB\_3M Power: AC120V/60Hz Humidity: 47 %  
 EUT: CD MP3 Stereo Boombox with AM FM Radio Distance: 3m  
 M/N: CDB237  
 Mode: TX  
 Note:

No.	Mk.	Freq.	Reading Level	Correct Factor	Measurement	Limit	Over	Antenna Height	Table Degree	
		MHz	dBuV	dB/m	dBuV/m	dBuV/m	dB	cm	degree	Comment
1		106.6300	44.03	-7.53	36.50	43.50	-7.00	QP		
2	*	190.0500	48.07	-8.27	39.80	43.50	-3.70	QP		
3		275.4100	40.43	-5.93	34.50	46.00	-11.50	QP		
4		317.1200	43.86	-5.06	38.80	46.00	-7.20	QP		
5		402.4800	42.79	-3.29	39.50	46.00	-6.50	QP		
6		445.1600	38.43	-2.63	35.80	46.00	-10.20	QP		

**Note: Below 30MHz, the emissions are lower than 20dB below the allowable limit.**



Dongguan NTC Co., Ltd.  
 Tel:+86-769-22022444 Fax:+86-769-22022799  
 Web: [Http://www.ntc-c.com](http://www.ntc-c.com)

**Radiated Emission Measurement**

File :CDB237      Data :#20      Date: 2020/8/6      Time: 18:07:38

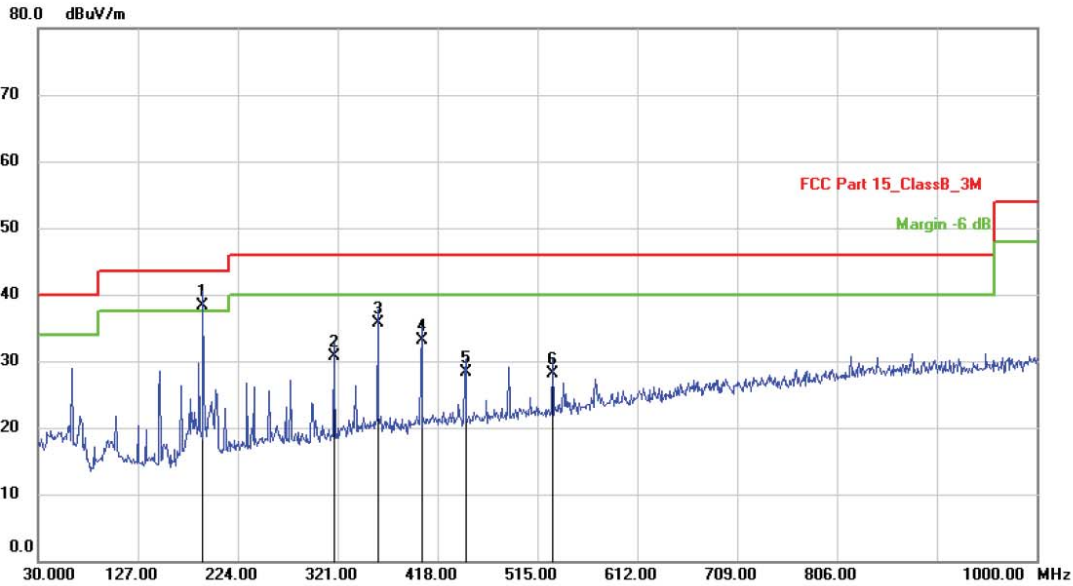

Site: 3m Chamber      Polarization: *Vertical*      Temperature: 26  
 Limit: FCC Part 15\_ClassB\_3M      Power: AC120V/60Hz      Humidity: 47 %  
 EUT: CD MP3 Stereo Boombox with AM FM Radio      Distance: 3m  
 M/N: CDB237  
 Mode: TX  
 Note:

No.	Mk.	Freq. MHz	Reading Level dBuV	Correct Factor dB/m	Measure- ment dBuV/m	Limit dBuV/m	Over dB	Detector	Antenna Height cm	Table Degree	Comment
1	*	190.0500	47.49	-9.09	38.40	43.50	-5.10	QP			
2		317.1200	36.76	-6.06	30.70	46.00	-15.30	QP			
3		359.8000	40.71	-5.01	35.70	46.00	-10.30	QP			
4		402.4800	37.49	-4.29	33.20	46.00	-12.80	QP			
5		445.1600	32.03	-3.63	28.40	46.00	-17.60	QP			
6		529.5500	30.47	-2.27	28.20	46.00	-17.80	QP			

**Note: Below 30MHz, the emissions are lower than 20dB below the allowable limit.**



Modulation:  $\pi/4$ -DQPSK (the worst case)  
 Frequency Range: 1-25GHz Test Date : August 04, 2020  
 Test Result: PASS Temperature : 26 °C  
 Measured Distance: 3m Humidity : 47 %  
 Test By: Sance

Freq. (MHz)	Ant.Pol. (H/V)	Reading Level(dBuV)		Factor (dB/m)	Emission Level (dBuV)		Limit 3m (dBuV/m)		Margin (dB)	
		PK	AV		PK	AV	PK	AV	PK	AV
<b>Operation Mode: TX Mode (Low)</b>										
4804	V	46.83	35.29	6.30	53.13	41.59	74.00	54.00	-20.87	-12.41
7206	V	46.11	30.78	10.44	56.55	41.22	74.00	54.00	-17.45	-12.78
---										
4804	H	47.89	34.08	6.30	54.19	40.38	74.00	54.00	-19.81	-13.62
7206	H	46.22	30.79	10.44	56.66	41.23	74.00	54.00	-17.34	-12.77
---										
<b>Operation Mode: TX Mode (Mid)</b>										
4882	V	46.96	35.45	6.60	53.56	42.05	74.00	54.00	-20.44	-11.95
7323	V	46.23	30.74	10.55	56.78	41.29	74.00	54.00	-17.22	-12.71
---										
4882	H	47.76	34.75	6.60	54.36	41.35	74.00	54.00	-19.64	-12.65
7323	H	46.18	30.80	10.55	56.73	41.35	74.00	54.00	-17.27	-12.65
---										
<b>Operation Mode: TX Mode (High)</b>										
4960	V	47.06	36.50	6.89	53.95	43.39	74.00	54.00	-20.05	-10.61
7440	V	46.48	30.93	10.60	57.08	41.53	74.00	54.00	-16.92	-12.47
---										
4960	H	47.50	36.80	6.89	54.39	43.69	74.00	54.00	-19.61	-10.31
7440	H	46.34	30.77	10.60	56.94	41.37	74.00	54.00	-17.06	-12.63
---										

- Note:**
- (1) All Readings are Peak Value and AV.
  - (2) Emission Level= Reading Level + Factor
  - (3) Factor= Antenna Gain + Cable Loss – Amplifier Gain
  - (4) Data of measurement within this frequency range shown “ ---” in the table above means the reading of emissions are attenuated more than 10dB below the permissible limits.
  - (5) Measurement uncertainty :  $\pm 3.7$ dB.
  - (6) Horn antenna used for the emission over 1000MHz.

## 5. Channel Separation test

### 5.1 Measurement Procedure

Minimum Hopping Channel Carrier Frequency Separation, FCC Rule 15.247(a)(1):

Connect EUT antenna terminal to the spectrum analyzer with a low loss cable, and using the MARKER and Max-Hold function to record the separation of two adjacent channels.

### 5.2 Test SET-UP (Block Diagram of Configuration)

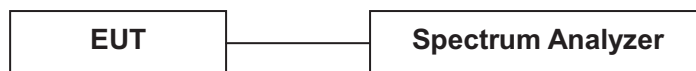

### 5.3 Measurement Results

Modulation:	GFSK, $\pi/4$ -DQPSK		
RBW:	100KHz	VBW:	300KHz
Packet:	DH5, 2-DH5	Spectrum Detector:	PK
Test By:	Lee	Test Date :	August 03, 2020
Temperature :	22 °C	Humidity :	53 %
Test Result:	PASS		

Channel number	Channel frequency (MHz)	Separation Read Value (KHz)	Separation Limit 2/3 20dB Bandwidth (KHz)
<b>GFSK</b>			
Lowest	2402	1002	>611.4
Middle	2441	1002	>570.4
Highest	2480	1002	>609.0
<b><math>\pi/4</math>-DQPSK</b>			
Lowest	2402	1002	>814.7
Middle	2441	1002	>816.7
Highest	2480	1002	>816.7

### GFSK Lowest Channel

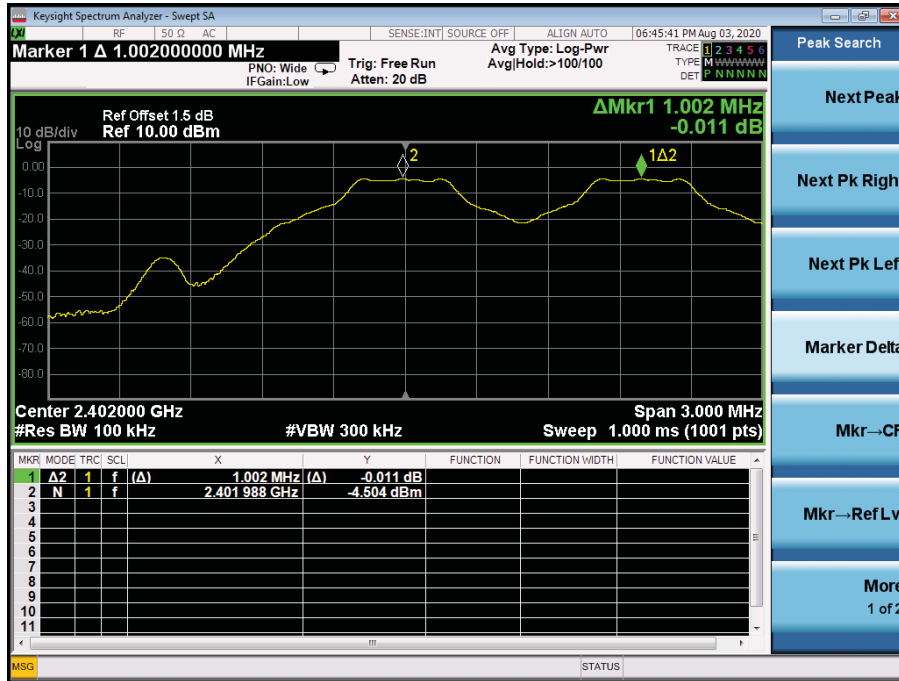

### GFSK Middle Channel

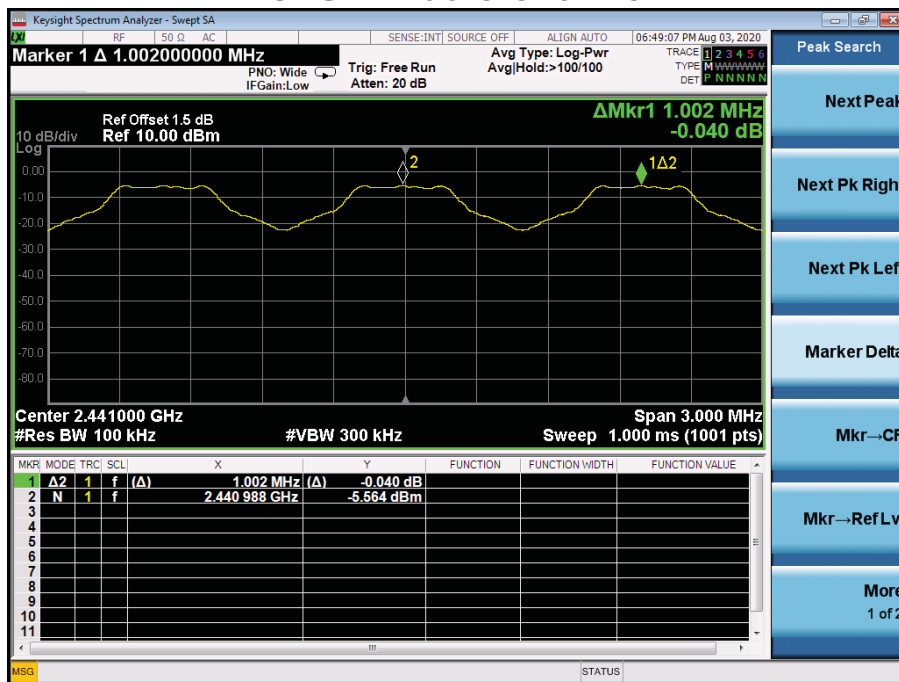

### GFSK Highest Channel

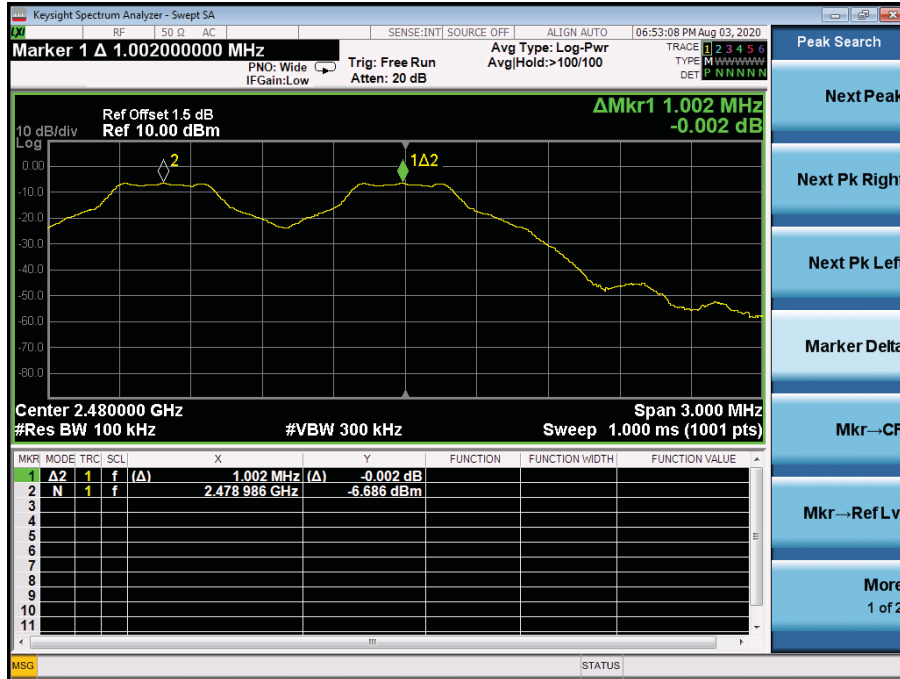

### $\pi/4$ -DQPSK Lowest Channel

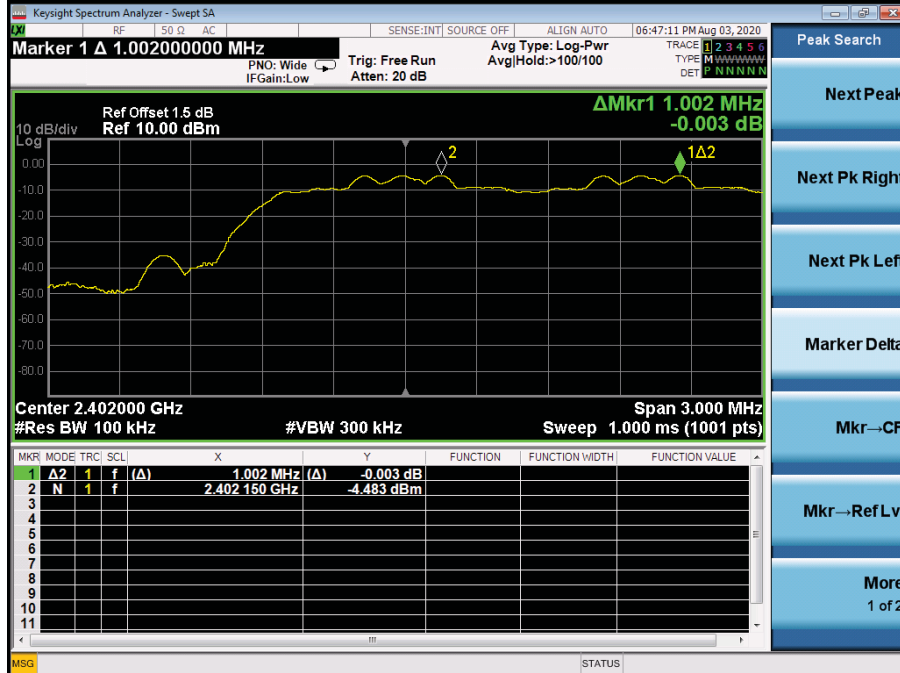

### $\pi/4$ -DQPSK Middle Channel

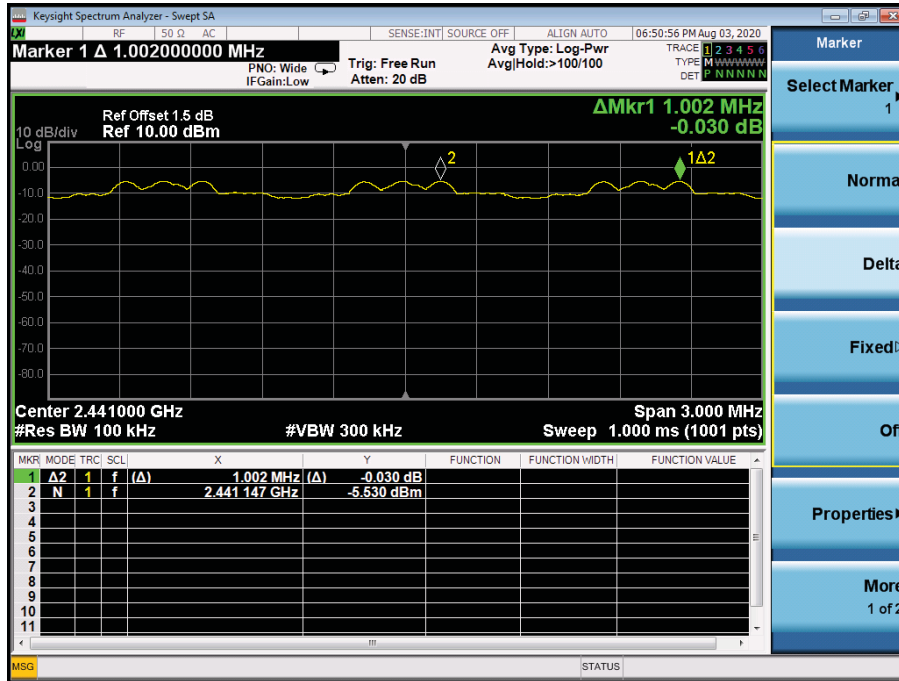

### $\pi/4$ -DQPSK Highest Channel

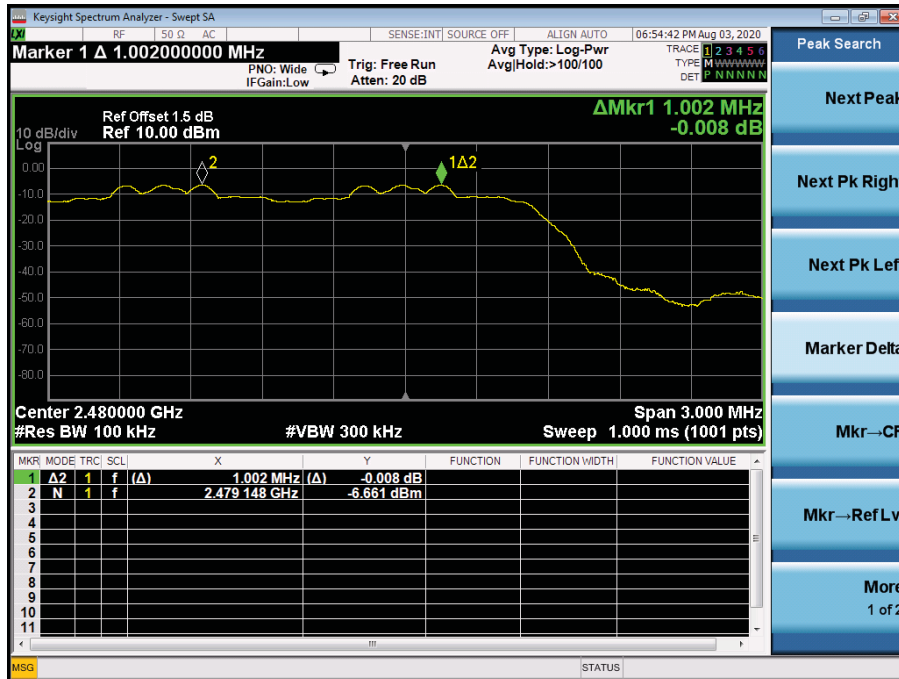



## 6. 20dB Bandwidth

### 6.1 Measurement Procedure

Maximum 20dB RF Bandwidth, FCC Rule 15.247(a)(1):

The antenna port of the EUT was connected to the input of a spectrum analyzer. Analyzer RBW was chosen so that the display was a result of the hopping channel modulation. For each RF output channel investigated, the spectrum analyzer center frequency was set to the channel carrier. Use the spectrum 20dB down delta function to measure the bandwidth.

### 6.2 Test SET-UP (Block Diagram of Configuration)



### 6.3 Measurement Results

Refer to attached data chart.

Modulation:	GFSK, $\pi/4$ -DQPSK	VBW:	100KHz
RBW:	30KHz	Spectrum Detector:	PK
Packet:	DH5, 2-DH5	Test Date :	August 14, 2020
Test By:	Lee	Humidity :	53 %
Temperature :	22 °C		
Test Result:	PASS		

Channel frequency (MHz)	20dB Down BW(kHz)
GFSK	
2402	917.1
2441	855.6
2480	913.5
$\pi/4$ -DQPSK	
2402	1222
2441	1225
2480	1225

### GFSK Lowest Channel



### GFSK Middle Channel

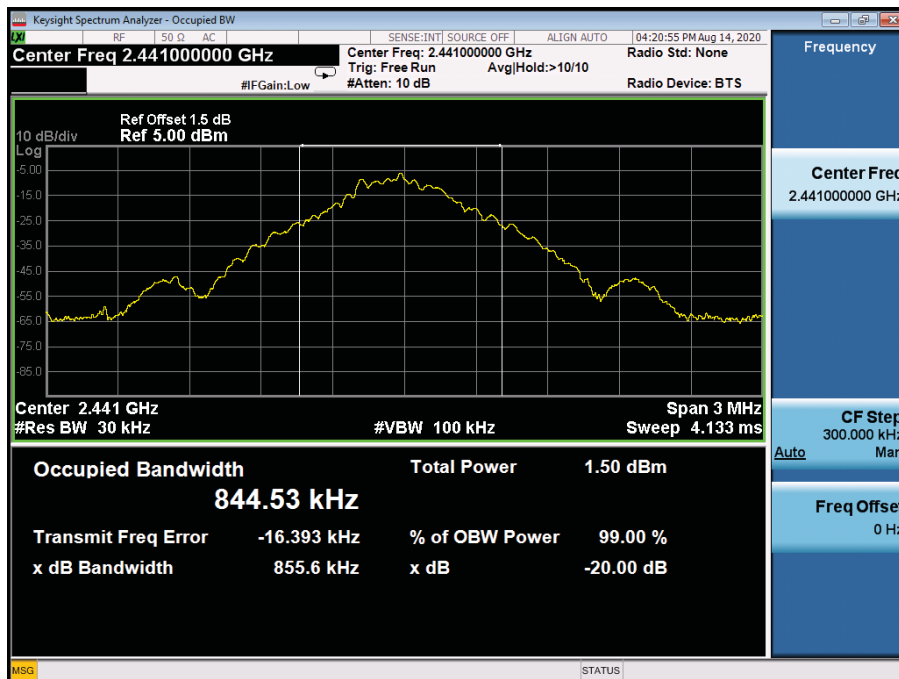

### GFSK Highest Channel

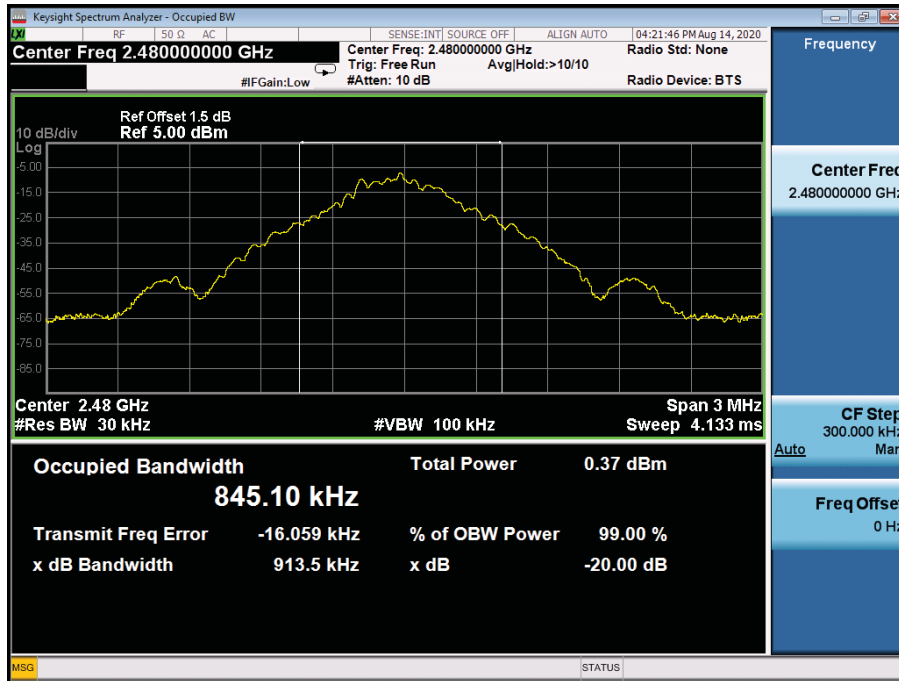

### $\pi/4$ -DQPSK Lowest Channel

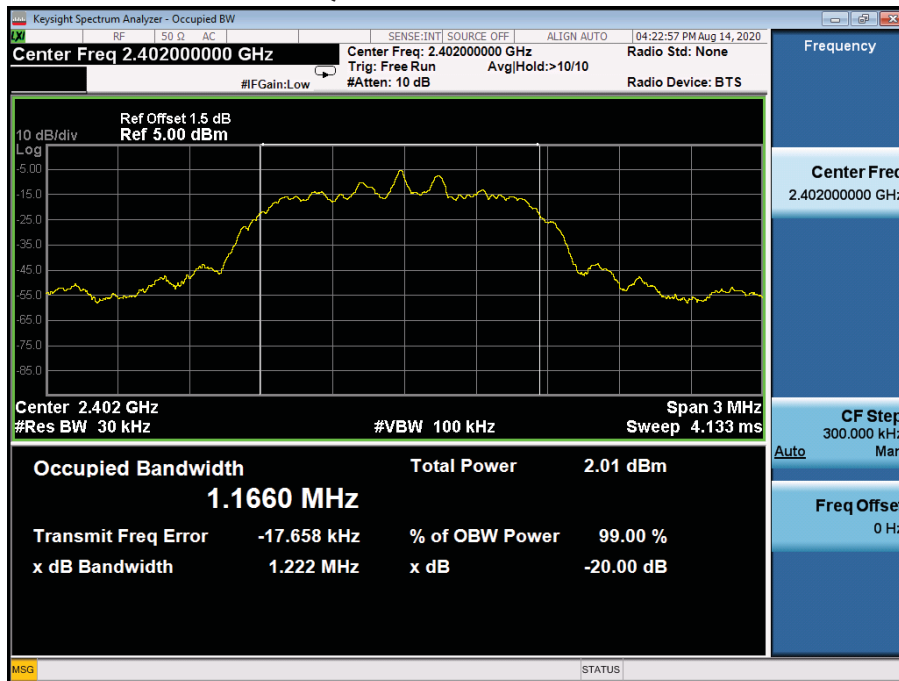

### $\pi/4$ -DQPSK Middle Channel

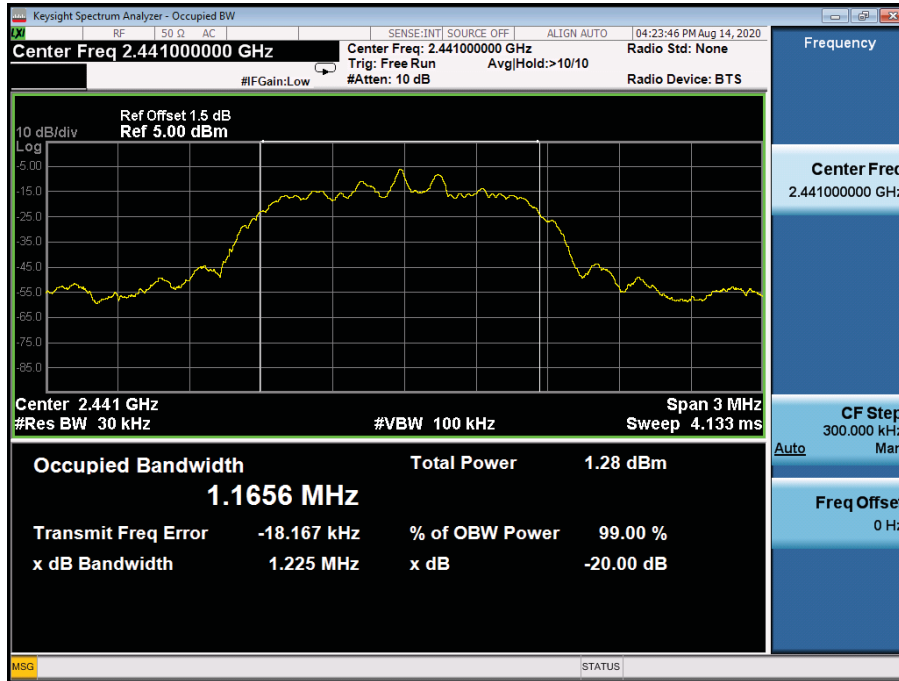

### $\pi/4$ -DQPSK Highest Channel

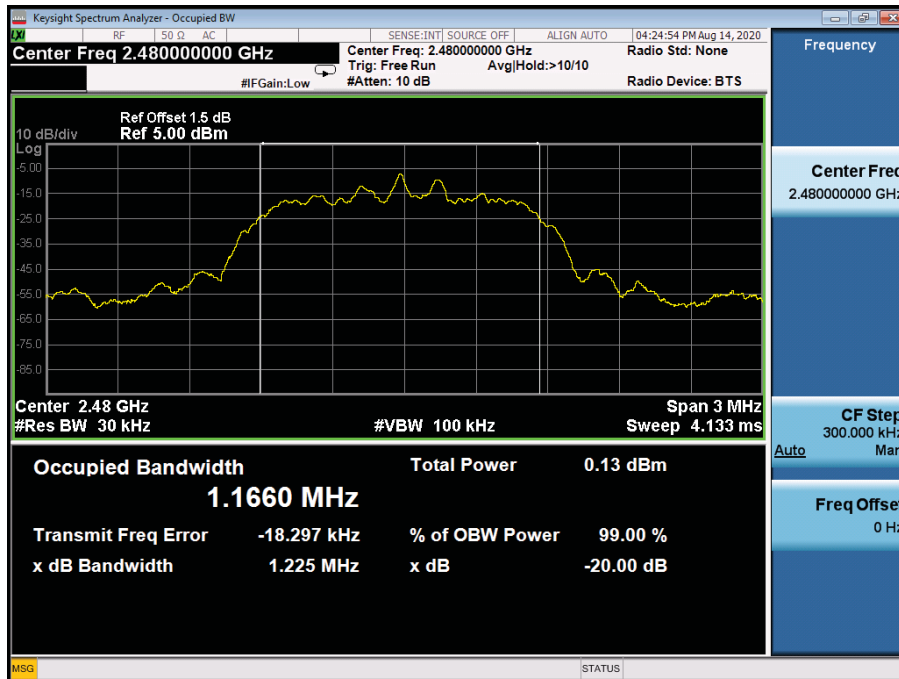

## 7. Hopping Channel Number

### 7.1 Measurement Procedure

Minimum Number of Hopping Frequencies, FCC Rule 15.247(a)(1)(iii):

Remove the antenna from the EUT and then connect a low RF cable from the antenna port to the spectrum, and the spectrum analyzer set to MAX HOLD readings were taken for 3-5 minutes. The channel peaks so recorded were added together, and the total number compared to the minimum number of channels required in the regulation.

### 7.2 Test SET-UP (Block Diagram of Configuration)



### 7.3 Measurement Results

Modulation	GFSK, $\pi/4$ -DQPSK		
RBW:	100KHz	VBW:	300KHz
Packet:	DH5, 2-DH5	Spectrum Detector:	PK
Test By:	Lee	Test Date :	August 03, 2020
Temperature :	22 °C	Humidity :	53 %
Test Result:	PASS		

Hopping Channel Frequency Range	Number of Hopping Channels	Limit
2402-2480	79	$\geq 15$

The worst case:  $\pi/4$ -DQPSK

$\pi/4$ -DQPSK

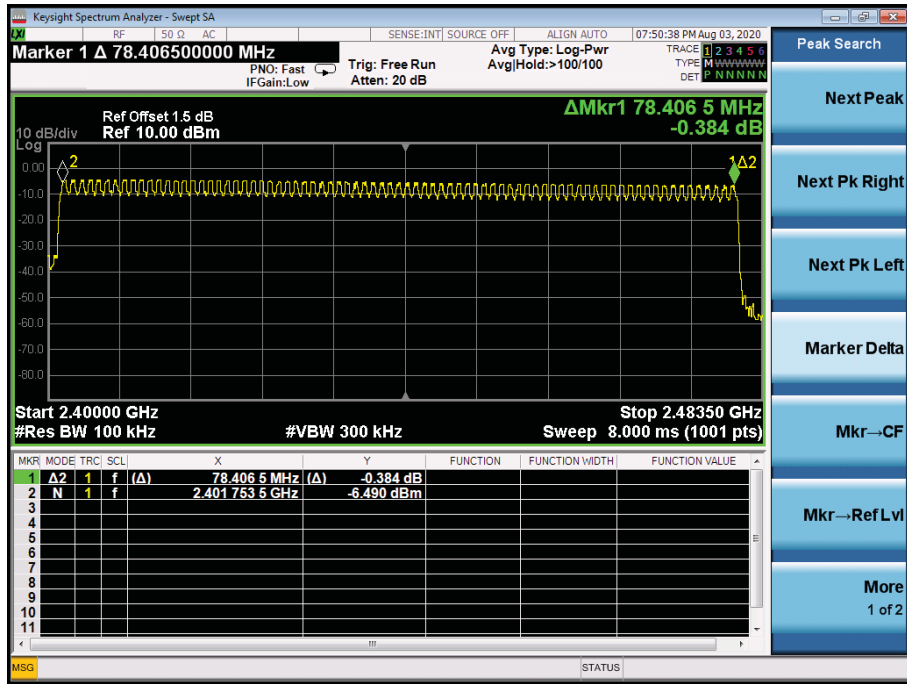

## 8. Time of Occupancy (Dwell Time)

### 8.1 Measurement Procedure

Average Channel Occupancy Time, FCC Ref:15.247(a)(1)(iii):

Connect EUT antenna terminal to the spectrum analyzer with a low loss cable. The spectrum analyzer center frequency was set to one of the known hopping channels. The Sweep was set to 10 ms, the SPAN was set to Zero SPAN. The time duration of the transmissions so captured was measured with the Marker Delta function.

### 8.2 Measurement Results

The maximum number of hopping channels in 31.6s (0.4s/Channel x 79 Channel)

Refer to attached data chart.

Modulation :	GFSK, $\pi/4$ -DQPSK	VBW :	1MHz
RBW :	1MHz	Test By:	Lee
Spectrum Detector:	PK	Temperature :	22°C
Test Date :	August 03, 2020	Humidity :	53 %
Test Result:	PASS		

Packet	Frequency (MHz)	Result (msec)		Limit (msec)
GFSK				
DH1	2441	0.408	$(ms) * (1600 / (2 * 79)) * 31.6 =$	130.56
DH3	2441	1.665	$(ms) * (1600 / (4 * 79)) * 31.6 =$	266.40
DH5	2441	2.912	$(ms) * (1600 / (6 * 79)) * 31.6 =$	310.61
$\pi/4$ -DQPSK				
2-DH1	2441	0.421	$(ms) * (1600 / (2 * 79)) * 31.6 =$	134.72
2-DH3	2441	1.670	$(ms) * (1600 / (4 * 79)) * 31.6 =$	267.20
2-DH5	2441	2.923	$(ms) * (1600 / (6 * 79)) * 31.6 =$	311.79

### GFSK DH1

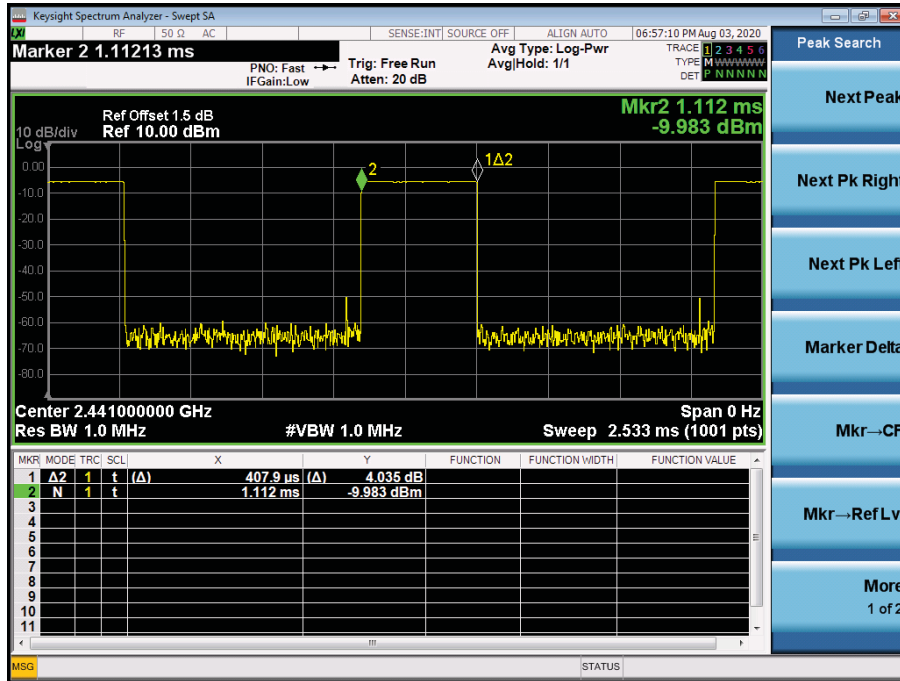

### GFSK DH3

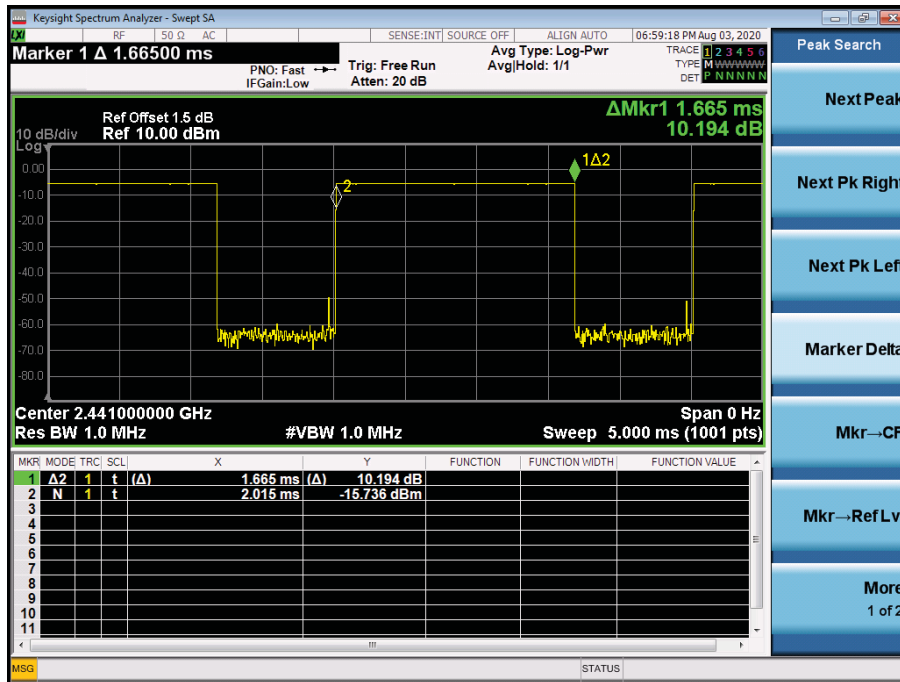



### GFSK DH5

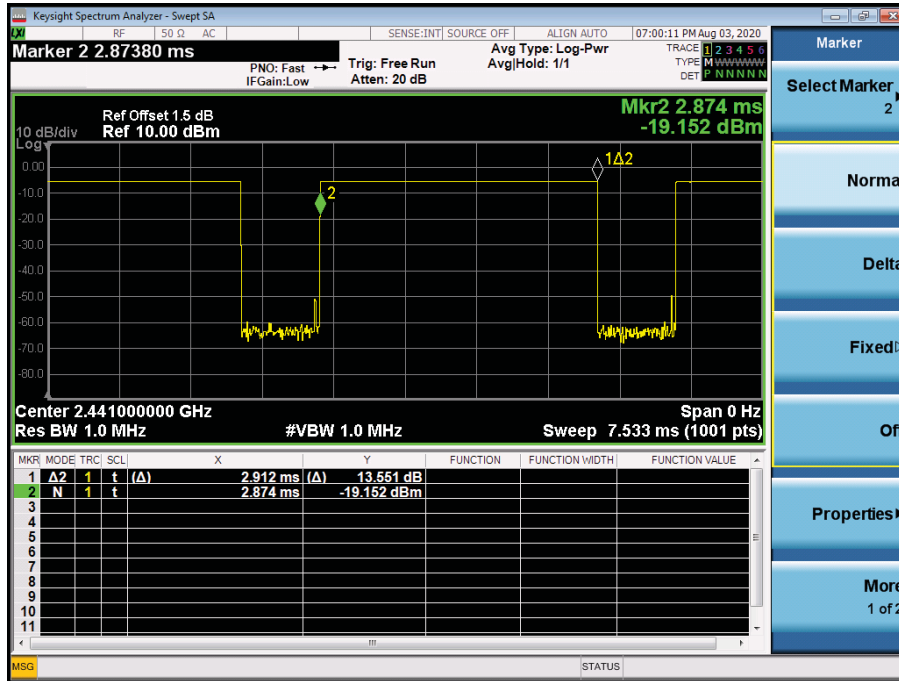

### $\pi/4$ -DQPSK 2-DH1

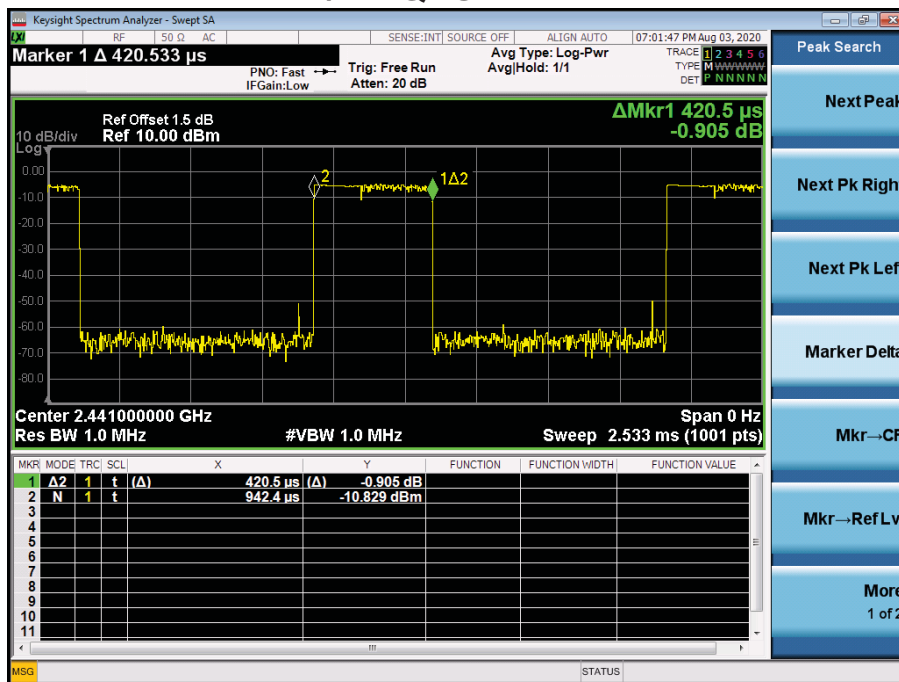

### $\pi/4$ -DQPSK 2-DH3

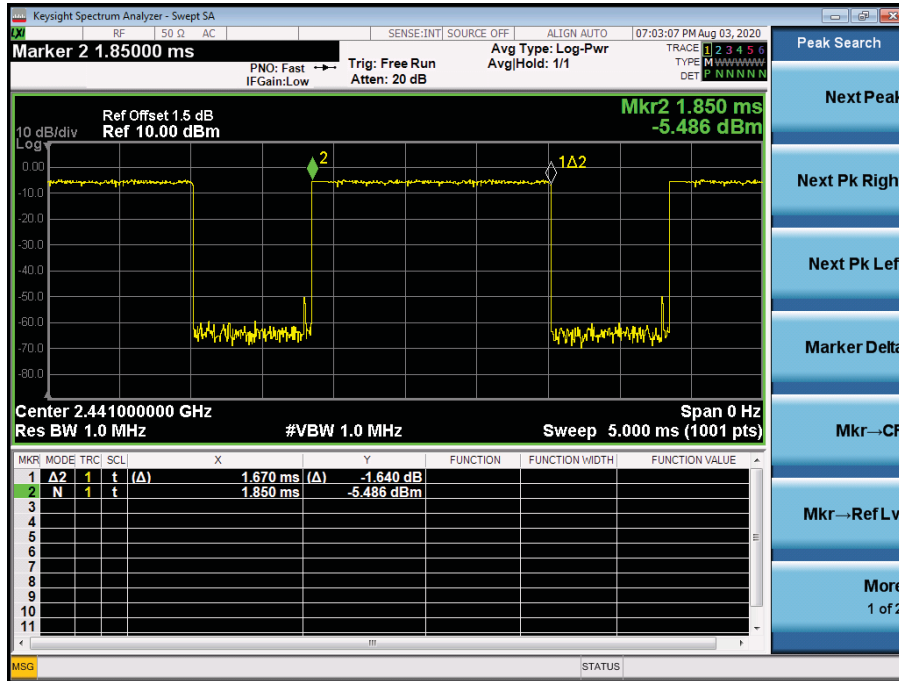

### $\pi/4$ -DQPSK 2-DH5

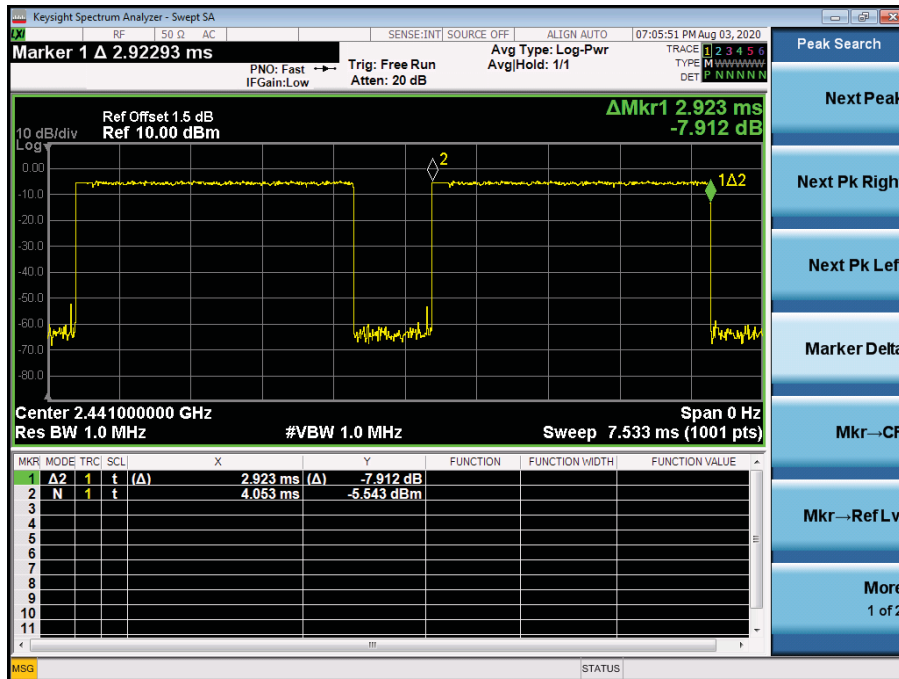

## 9. MAXIMUM PEAK OUTPUT POWER

### 9.1 Measurement Procedure

Maximum Conducted Output Power at Antenna Terminals, FCC Rules 15.247(b)(1):

Remove the antenna from the EUT and then connect a low RF cable from the antenna port to the spectrum. The analyzer was set for RBW > 20dB bandwidth and power was read directly in dBm. Cable loss was considered during this measurement.

### 9.2 Measurement Results

Refer to attached data chart.

Modulation :	GFSK, $\pi/4$ -DQPSK		
RBW :	3MHz	VBW :	3MHz
Spectrum Detector:	PK	Test Date :	August 03, 2020
Test By:	Lee	Temperature :	22 °C
Test Result:	PASS	Humidity :	53 %

Channel Frequency (MHz)	Cable Loss dB	Peak Power output(dBm)	Peak Power output(mW)	Peak Power Limit(dBm)	Pass/Fail
GFSK					
2402.00	1.5	-4.259	0.38	21	PASS
2441.00	1.5	-5.335	0.29	21	PASS
2480.00	1.5	-6.463	0.23	21	PASS
$\pi/4$ -DQPSK					
2402.00	1.5	-3.074	0.49	21	PASS
2441.00	1.5	-4.139	0.39	21	PASS
2480.00	1.5	-5.287	0.30	21	PASS

### GFSK Lowest Channel

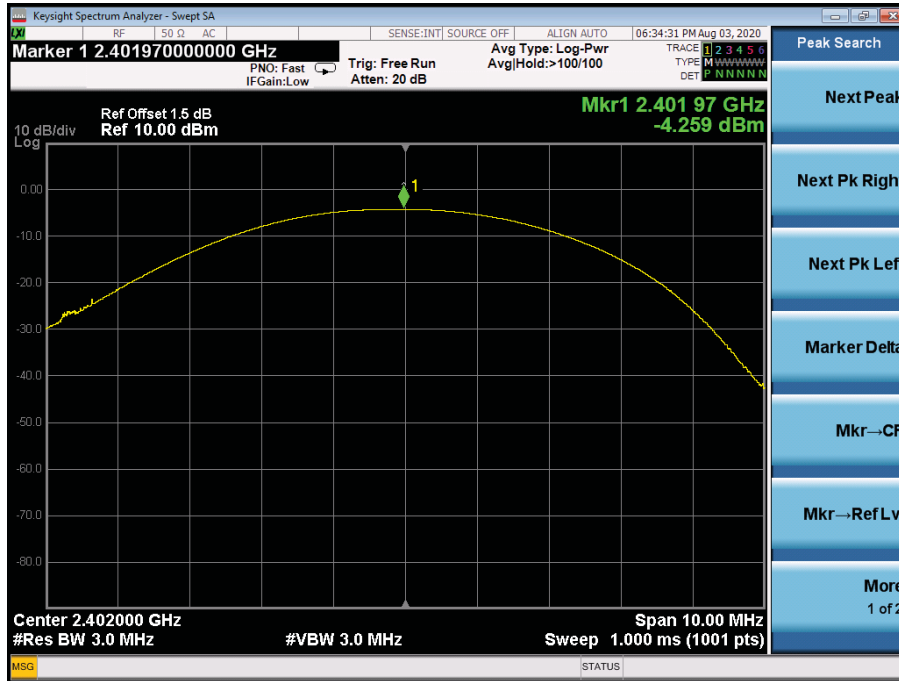

### GFSK Middle Channel

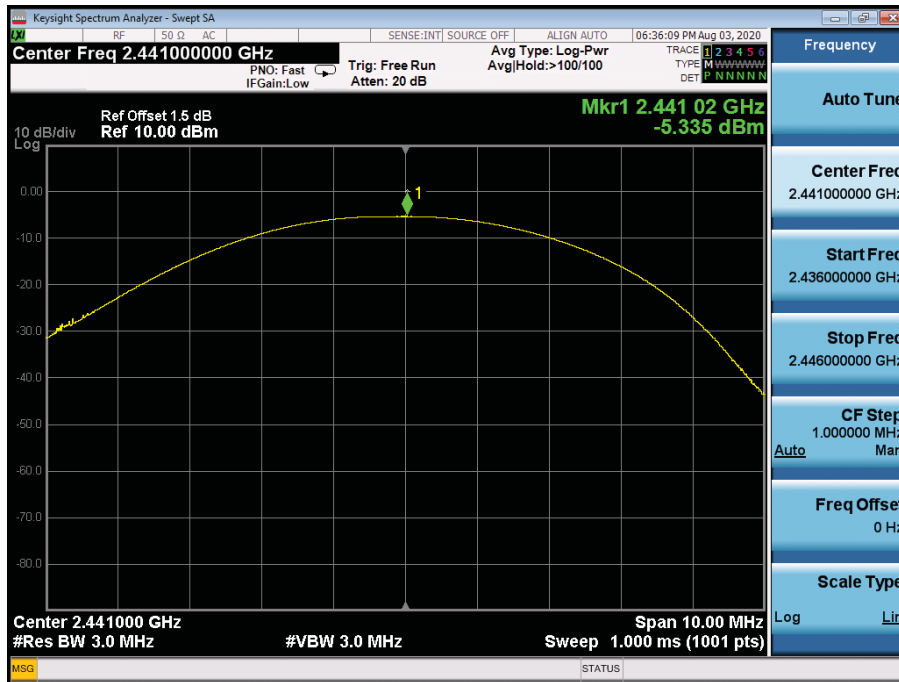

### GFSK Highest Channel

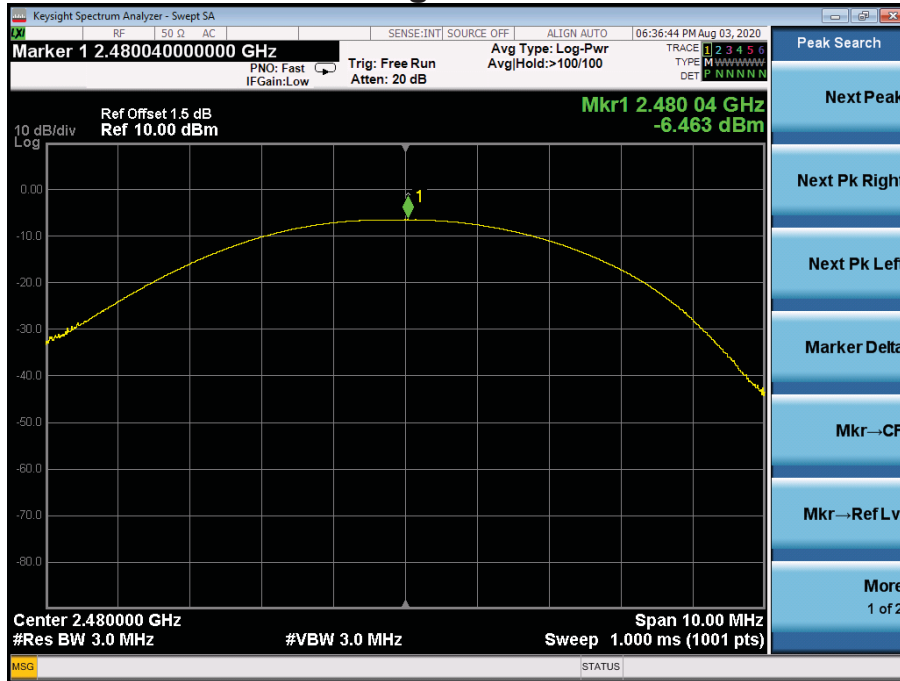

### $\pi/4$ -DQPSK Lowest Channel

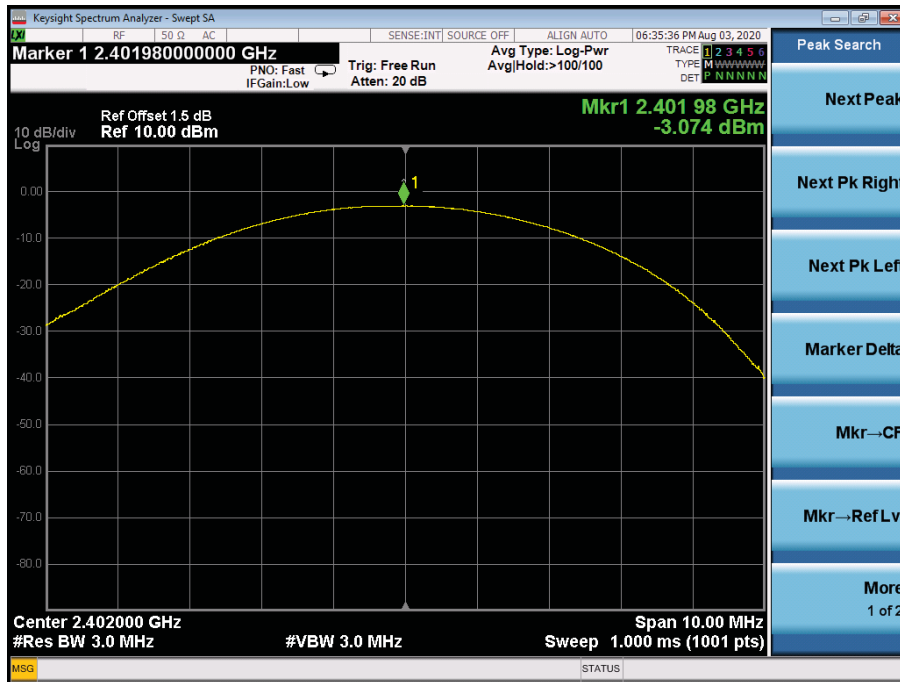

### $\pi/4$ -DQPSK Middle Channel

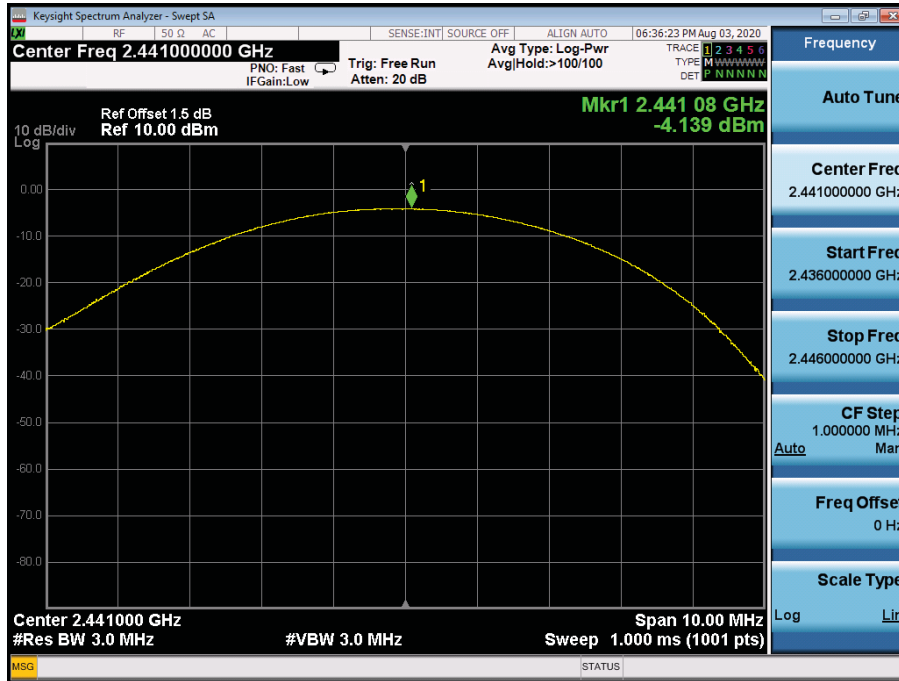

### $\pi/4$ -DQPSK Highest Channel

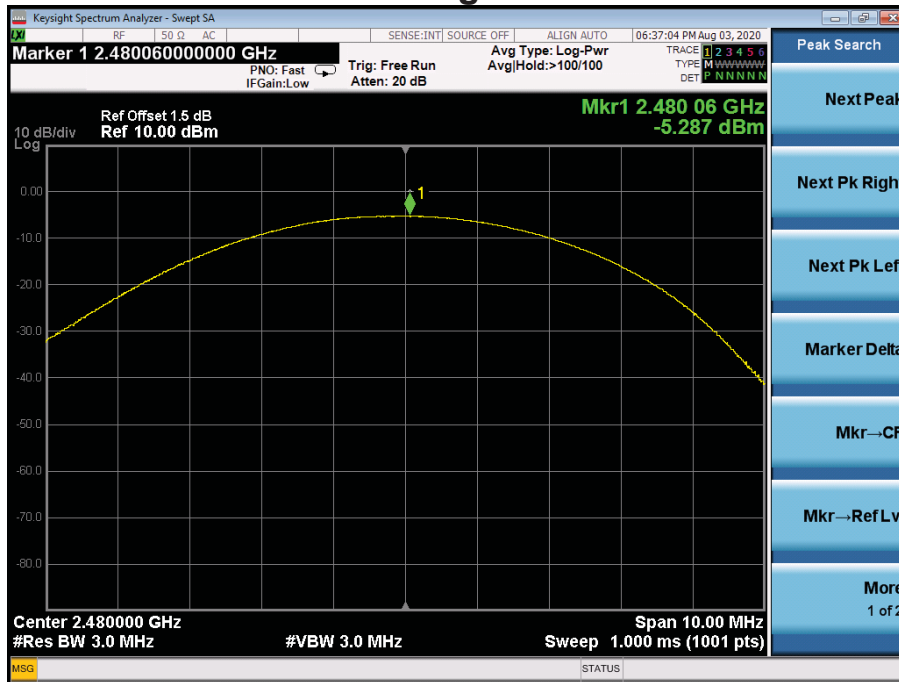

## 10. Band Edge and Restriction Bands

### 10.1 Measurement Procedure

Out of Band Conducted Emissions, FCC Rule 15.247(d):

The transmitter output is connected to spectrum analyzer. The resolution bandwidth is set to 100KHz, and the video bandwidth set to 300KHz.

For Restriction Bands please refer to clause 4 of this report for the measurement methods.

### 10.2 Limit

15.247(d) In any 100KHz bandwidth outside the frequency band in which the spread spectrum or digitally modulated intentional radiator is operating, the radio frequency power that is produced by the intentional radiator shall be at least 20dB below that in the 100KHz bandwidth within the band that contains the highest level of the desired power, based on either an RF conducted or a radiated measurement.

### 10.3 Measurement Results

Please see below test table and plots.

For Restriction bands

The worst case:  $\pi/4$ -DQPSK

Freq. (MHz)	Ant.Pol. (H/V)	Reading Level(dBuV)		Factor (dB/m)	Emission Level (dBuV)		Limit 3m (dBuV/m)		Margin (dB)	
		PK	AV		PK	AV	PK	AV	PK	AV
2390.000	H	46.42	31.79	0.09	46.51	31.88	74.00	54.00	-27.49	-22.12
2390.000	V	47.52	32.34	0.09	47.61	32.43	74.00	54.00	-26.39	-21.57
2483.500	H	46.64	32.19	0.34	46.98	32.53	74.00	54.00	-27.02	-21.47
2483.500	V	47.18	32.16	0.34	47.52	32.50	74.00	54.00	-26.48	-21.50

- Note:**
- (1) Emission Level= Reading Level + Factor
  - (2) Factor= Antenna Gain + Cable Loss – Amplifier Gain
  - (3) Horn antenna used for the emission over 1000MHz
  - (4) Other emission in restriction bands are lower than 10dB below the allowable limit.

For RF Conducted

### GFSK Lowest Channel

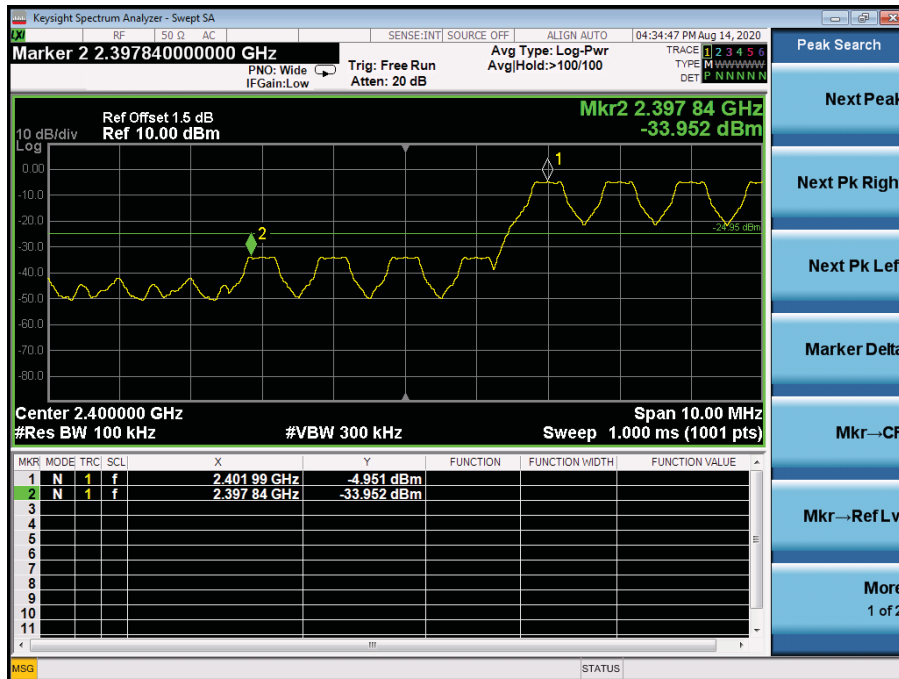
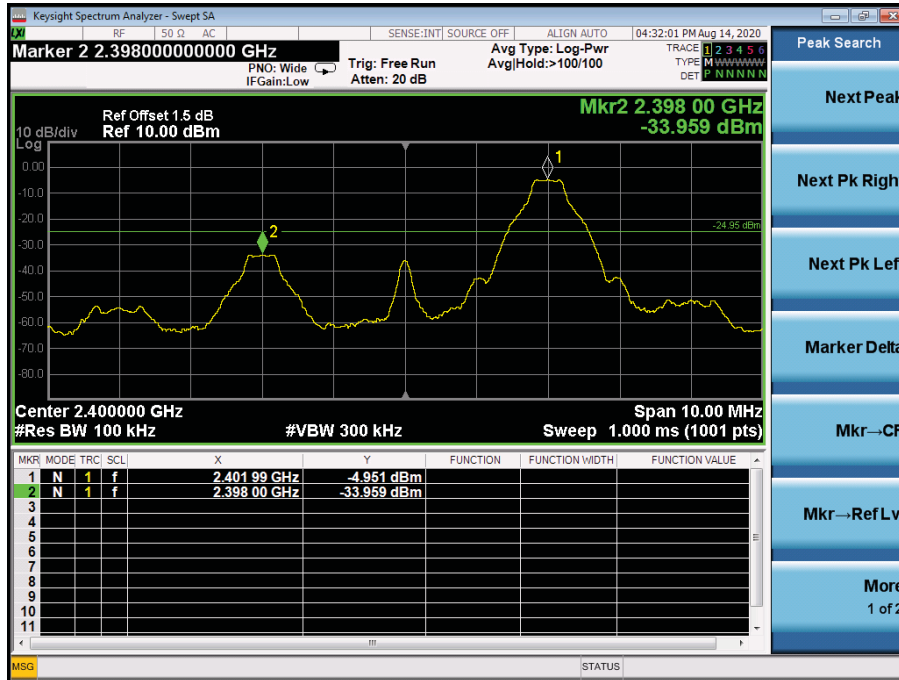



### GFSK Highest Channel

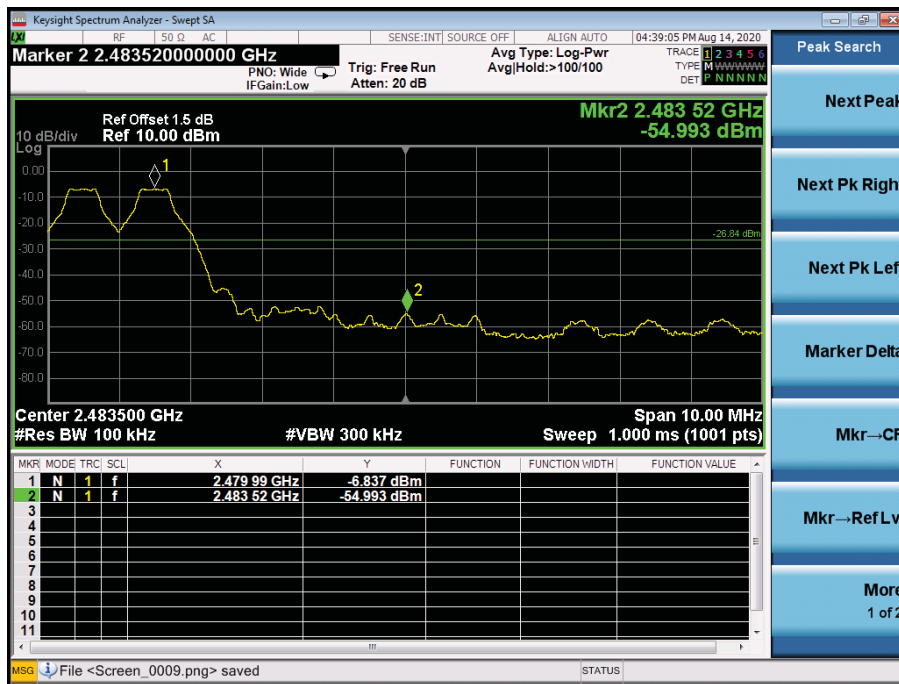
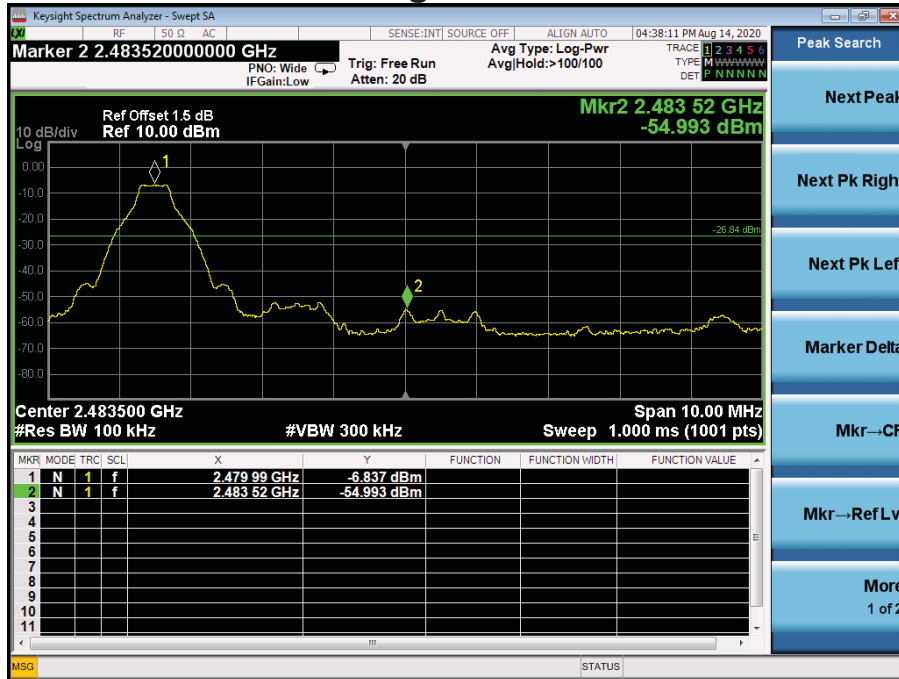

### $\pi/4$ -DQPSK Lowest Channel

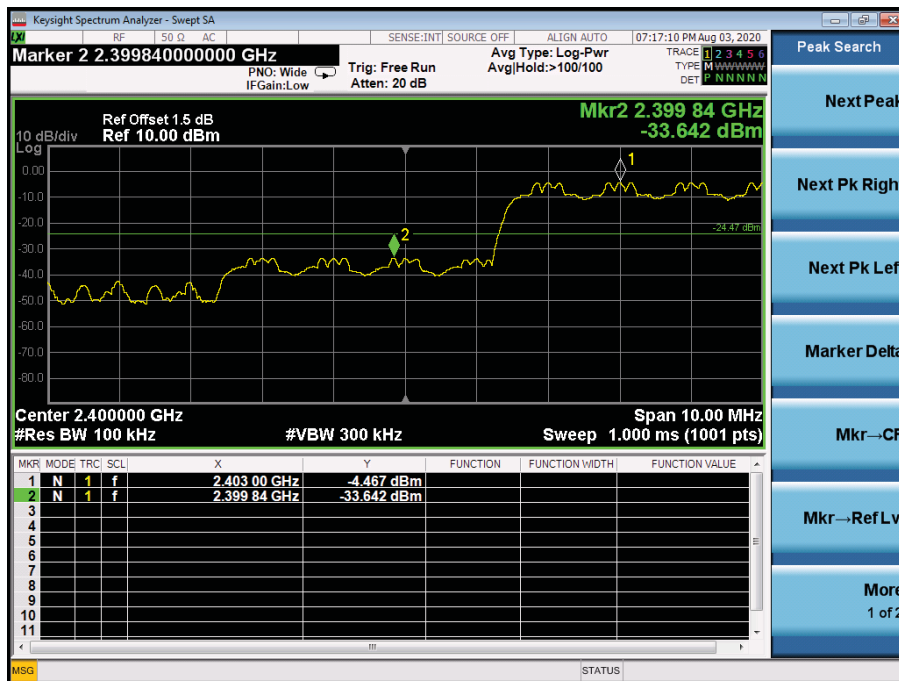
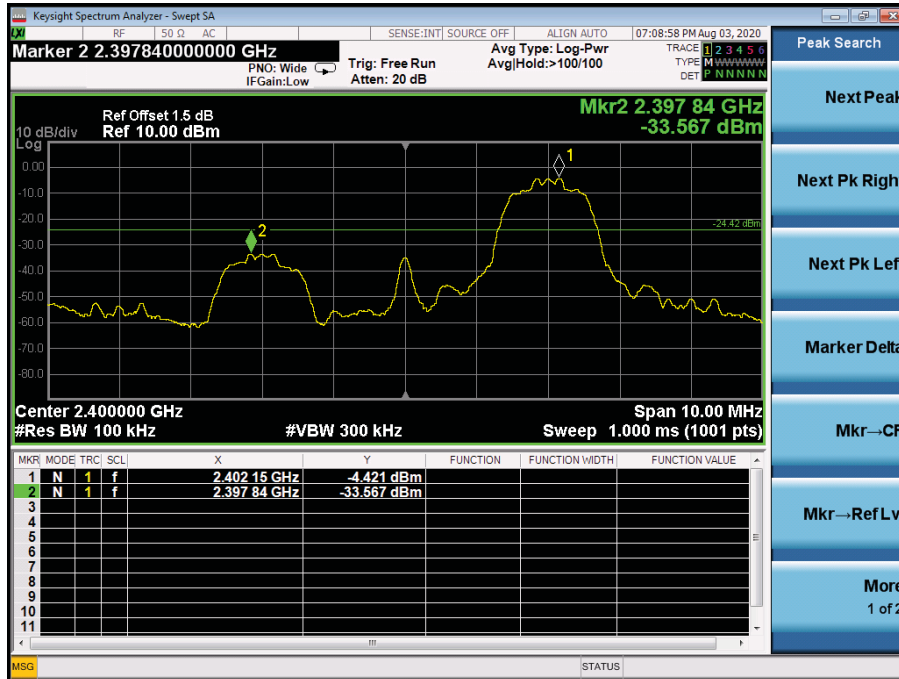

### $\pi/4$ -DQPSK Highest Channel

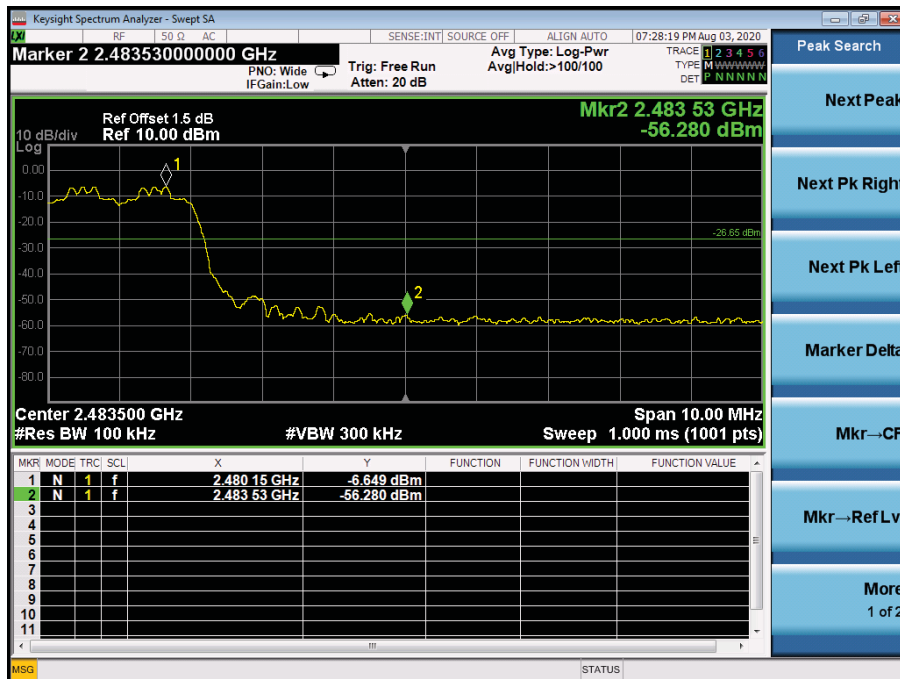
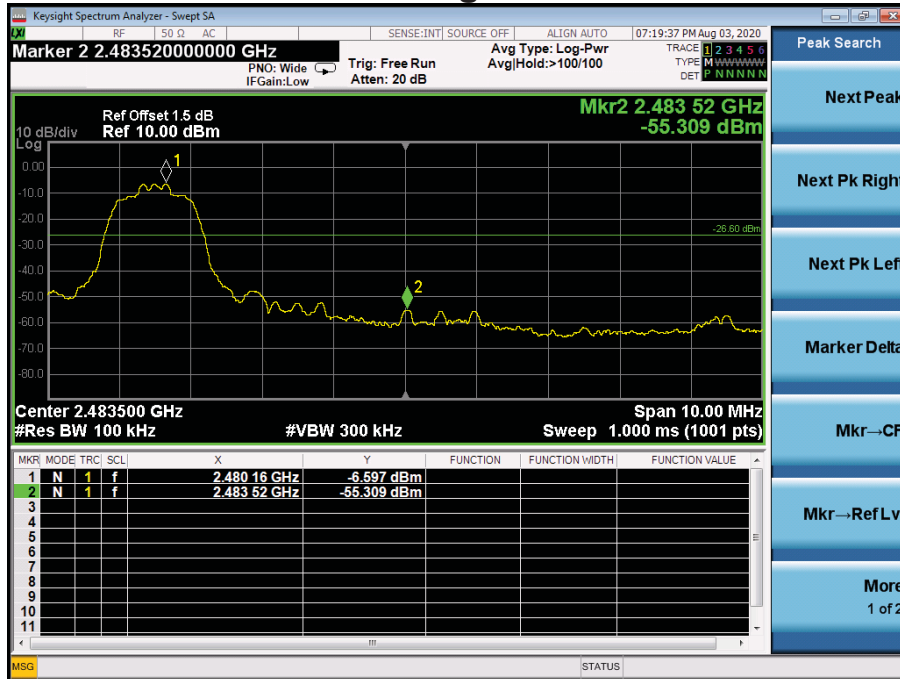

---

## 11. Antenna Application

### 11.1 Antenna requirement

According to of FCC part 15C section 15.203 and 15.240:

An intentional radiator shall be designed to ensure that no antenna other than that furnished by the responsible party shall be used with the device. The use of a permanently attached antenna or of an antenna that uses a unique coupling to the intentional radiator, the manufacturer may design the unit so that a broken antenna can be replaced by the user, but the use of a standard antenna jack or electrical connector is prohibited.

Systems operating in the 2400-2483.5MHz band that are used exclusively for fixed, point-to-point operations may employ transmitting antennas with directional gain greater than 6dBi provided the maximum peak output power of the intentional radiator is reduced by 1dB for every 3dB that the directional gain of the antenna exceeds 6dBi.

### 11.2 Measurement Results

The antenna is PCB antenna and no consideration of replacement, and the best case gain of the antenna is -0.58 dBi. Therefore, the antenna is consider meet the requirement.

---

## 12. Conducted Spurious Emissions

### 12.1 Measurement Procedure

Out of Band Conducted Spurious Emissions, FCC Rule 15.247(d):

The transmitter output is connected to spectrum analyzer. All spurious emission and up to the tenth harmonic was measured and they were found to be at least 20dB below the highest level of the desired power in the pass band.

### 12.2. Measurement Results

Please refer to following plots, the worst case ( $\pi/4$ -DQPSK) was shown.

### Lowest Channel

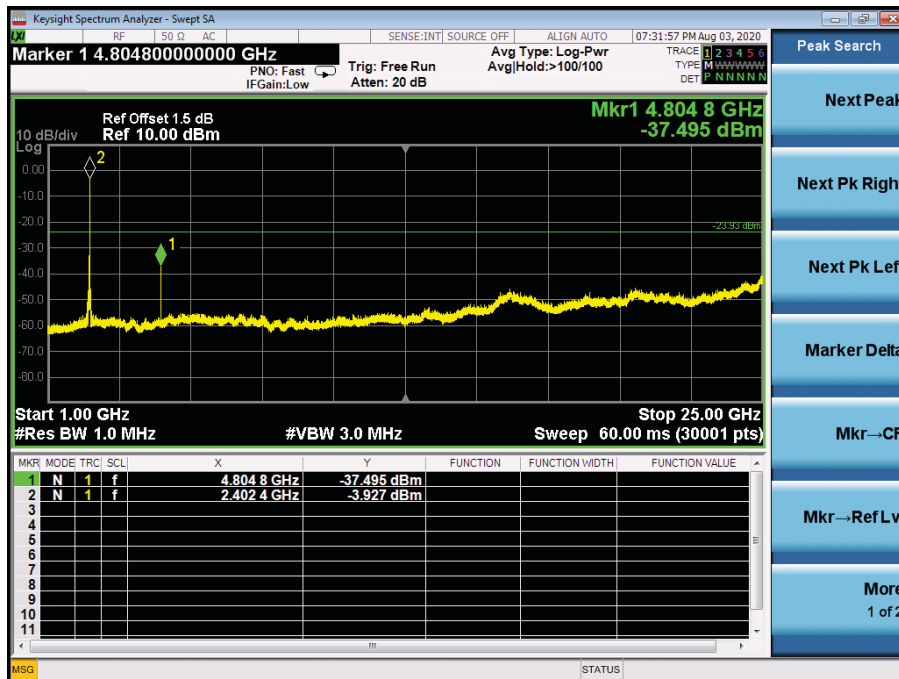
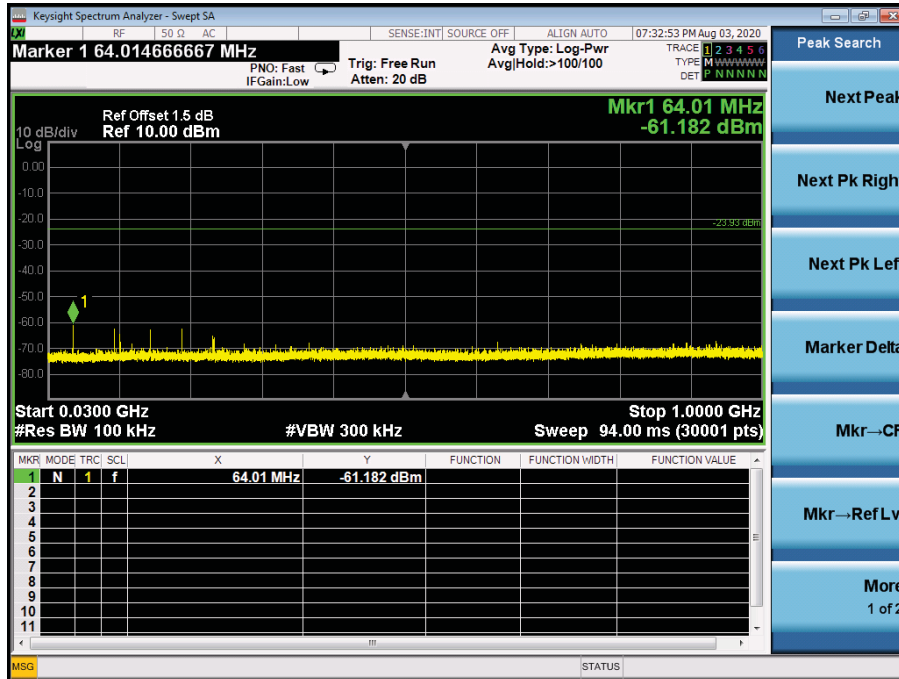

### Middle Channel

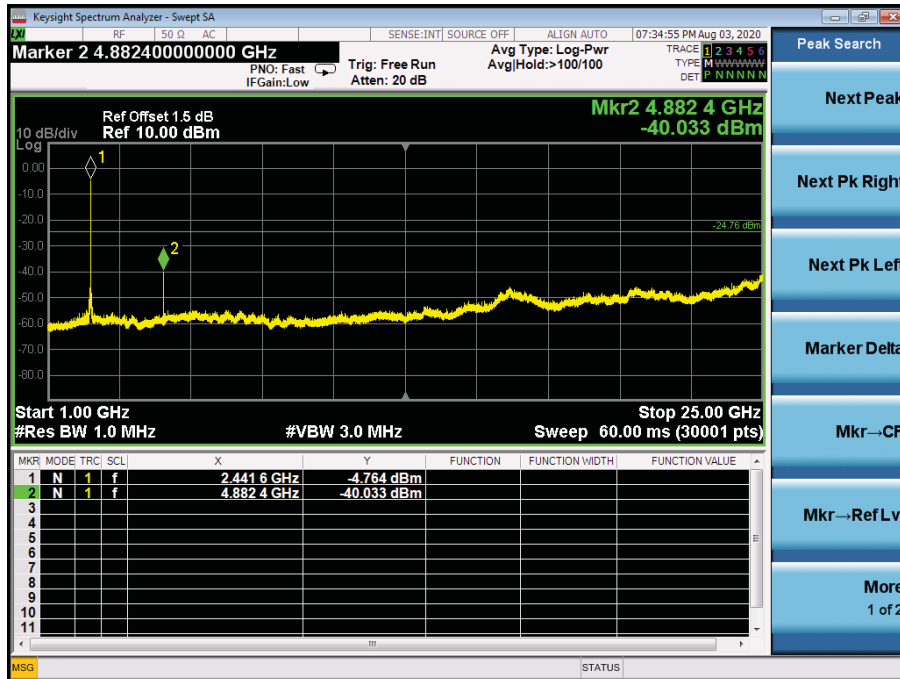
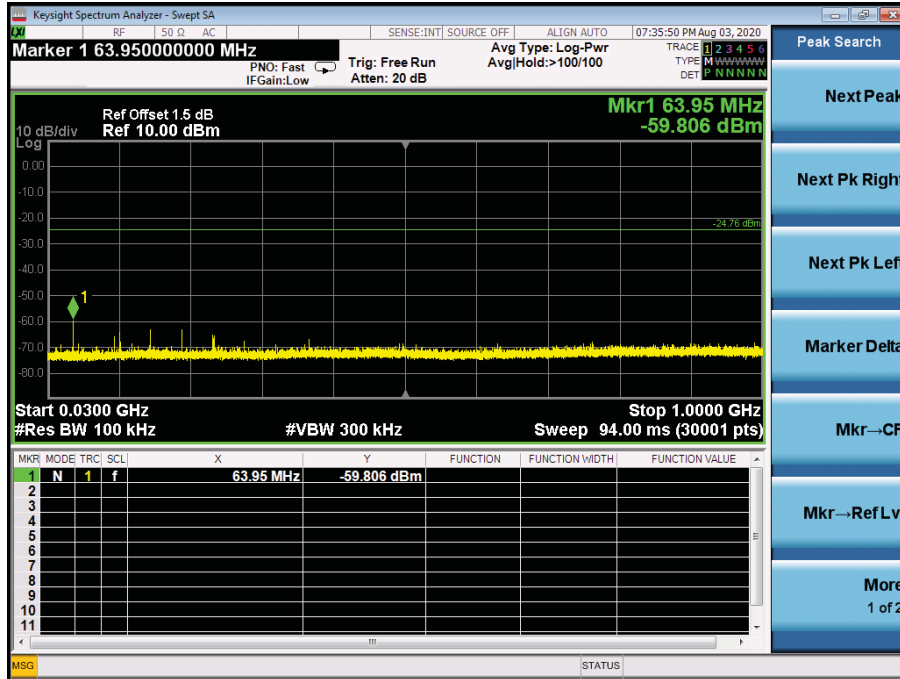

### Highest Channel

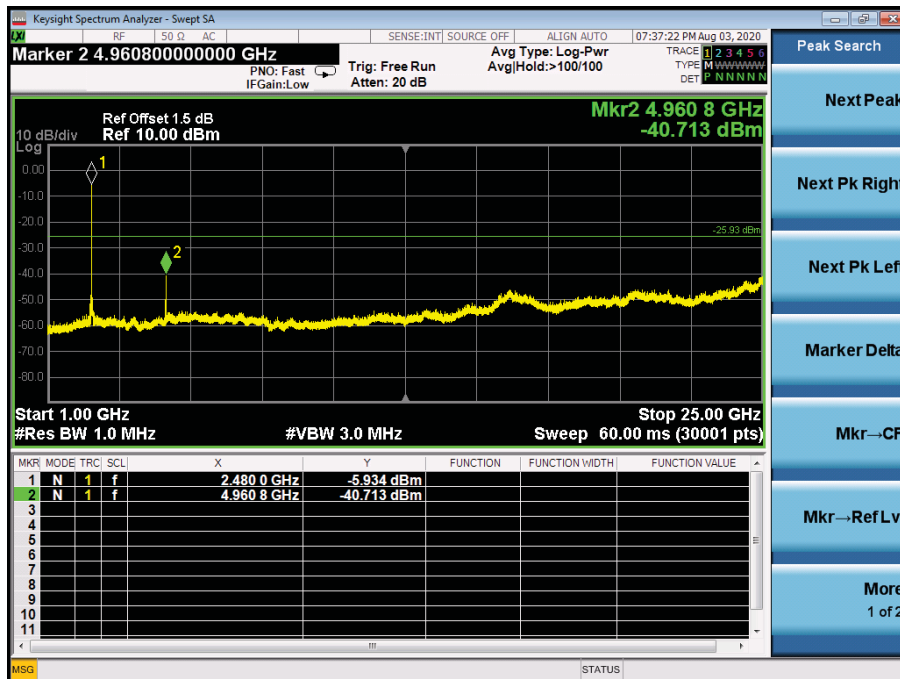
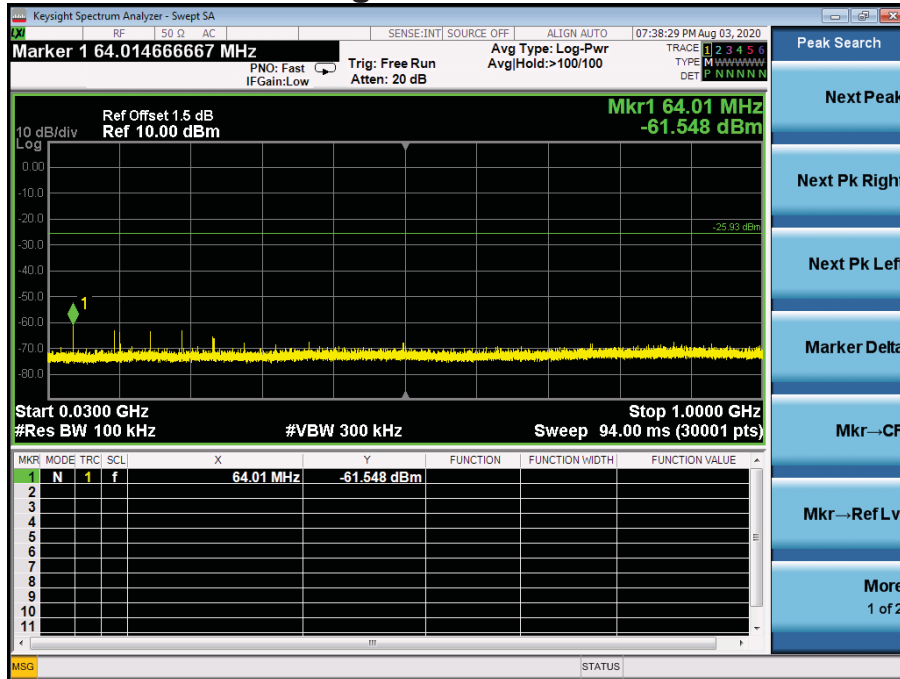

Note: Sweep points=30001pts



### 13. Test Equipment List

Item	Equipment	Manufacturer	Model No.	Serial No.	Last Cal.	Cal. Interval
1.	Test Receiver	Rohde & Schwarz	ESCI7	100837	Mar. 13, 2020	1 Year
2.	Antenna	Schwarzbeck	VULB9162	9162-010	Mar. 23, 2020	1 Year
3.	Spectrum Analyzer	Rohde & Schwarz	FSU26	200409/026	Mar. 13, 2020	1 Year
4.	Spectrum Analyzer	Keysight	N9020A	MY54200831	Mar. 13, 2020	1 Year
5.	Spectrum Analyzer	Rohde & Schwarz	FSV40	101094	Mar. 13, 2020	1 Year
6.	Horn Antenna	Schwarzbeck	BBHA9170	9170-172	Mar. 22, 2019	2 Year
7.	Power Sensor	DARE	RPR3006W	15100041SNO 64	Mar. 13, 2020	1 Year
9.	Communication Tester	Rohde & Schwarz	CMW500	149004	Mar. 13, 2020	1 Year
10.	Horn Antenna	COM-Power	AH-118	071078	Mar. 23, 2020	1 Year
11.	Pre-Amplifier	HP	HP 8449B	3008A00964	Mar. 13, 2020	1 Year
12.	Pre-Amplifier	HP	HP 8447D	1145A00203	Mar. 13, 2020	1 Year
13.	Loop Antenna	Schwarzbeck	FMZB 1513	1513-272	Mar. 23, 2020	1 Year
14.	Test Receiver	Rohde & Schwarz	ESCI	101152	Mar. 14, 2020	1 Year
15.	L.I.S.N	Rohde & Schwarz	ENV 216	101317	Mar. 13, 2020	1 Year
16.	L.I.S.N	Rohde & Schwarz	ESH2-Z5	893606/014	Mar. 13, 2020	1 Year
17.	RF Switching Unit	Compliance Direction Systems Inc.	RSU-M2	38311	Mar.13, 2020	1 Year
18.	Temperature & Humidity Chamber	REMAFEE	SYHR225L	N/A	Mar. 13, 2020	1 Year
19.	DC Source	Maynuo	MY8811	N/A	Mar. 13, 2020	1 Year
20.	Temporary antenna connector	TESCOM	SS402	N/A	N/A	N/A
21.	Chamber	SAEMC	9*7*7m	N/A	Jun. 20, 2019	2 Year
22.	Test Software	EZ	EZ_EMCC	N/A	N/A	N/A

Note: The temporary antenna connector is soldered on the PCB board in order to perform conducted tests and this temporary antenna connector is listed in the equipment list.

---End---