

MAGNAVOX

PORTABLE SPEAKER

with Bluetooth® Wireless Technology

OWNER'S MANUAL

PLEASE READ BEFORE OPERATING THIS EQUIPMENT.

MODEL: MMA3748

FCC NOTICE:

This equipment has been tested and found to comply with the limits for a Class B digital device, pursuant to Part 15 of the FCC Rules. These limits are designed to provide reasonable protection against harmful interference in a residential installation. This equipment generates; uses and can radiate radio frequency energy and, if not installed and used in accordance with the instructions, may cause harmful interference to radio communications. However, there is no guarantee that interference will not occur in a particular installation. If this equipment does cause harmful interference to radio or television reception, which can be determined by turning the equipment off and on, the user is encouraged to try to correct the interference by one or more of the following measures:

- Reorient or relocate the receiving antenna.
- Increase the separation between the equipment and receiver.
- Connect the equipment into an outlet on a circuit different from that to which the receiver is connected.
- Consult the dealer or an experienced radio/TV technician for help.

FCC STATEMENT

1. This device complies with Part 15 of the FCC Rules.



Operation is subject to the following two conditions:

- This device may not cause harmful interference, and
- This device must accept any interference received, including interference that may cause undesired operation.

2. Changes or modifications not expressly approved by the party responsible for compliance could void the user's authority to operate the equipment.

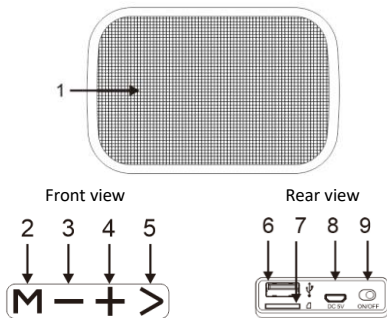
LOCATION OF CONTROL



1. Speaker
2. **M** Button
3. **-** Button
4. **+** Button
5. **>** Button
6.  USB Port
7.  TF (Micro USB) Card Slot
8. DC 5V (Micro USB) Port (For Charging Only)
9. Power ON/OFF Switch

POWER SOURCE

The unit has a built-in Li-ion rechargeable battery, charge it before first time use or when it is drained as follows:

1. Connect the small plug from the supplied USB Connection Cable to the DC 5V (Micro USB) Port on the rear of unit.
2. Connect the full size USB Plug from the supplied USB Connection Cable to the USB Port on the Personal Computer or USB Charger (Computer and USB Charger not included).
3. When charging, the Red Indicator on the front of unit will illuminate. When charging is complete, it will turn off.

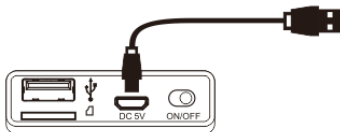

NOTES:

1. During charging, you can also play and listening music at the same time.
2. Your battery will last longer if you following these simple guidelines for caring and storing:
 - A. Before first time use, recharge the unit approximately 4 hours until the unit is fully charged.
 - B. Charge and store the unit within the temperature

- range of 5°C - 35°C (40°F - 95°F).
- C. Do not overcharge (longer than 24 hours). Excessive charging or running the unit until completely flat will damage battery. Battery life will be extended if you keep the battery fully charged.
 - D. Battery life naturally shortens slowly over time.
 - E. The rechargeable battery incorporated in this product is not user replaceable.

OPERATION:

General Operation:

1. Recharge the built-in Li-ion battery as previously instructed.
2. Slide the Power ON/OFF Switch on the rear of unit to ON position to power on the unit. The Blue Indicator on the front of unit will illuminate (and blink).
3. Presses the M (Mode) Button repeatedly to switch to desired playback mode. The unit will sound the prompt with you selection (see list below):

Playback Modes:	Voice Prompt:
BT (Bluetooth)	Bluetooth ready for connection
USB	USB
TF (Micro SD) Card	Memory Card

Note:

If the TF (Micro SD) Card and/or USB Device had NOT inserted into the unit, the correspondence selection will not available.

4. During playback:

- Press the > Button on the top of unit to pause; press again to resume to normal playback.
- Press and release the “-” or “+” buttons repeatedly to adjust volume level as desired.

5. Press and hold the “-” or “+” buttons repeatedly to skip tracks.

6. When finished listening, slide the Power ON/OFF Switch to OFF position to shut off the unit.

BT:**BT (Bluetooth) pairing:**

First time use or re-pairing the unit to a new BT Device, pair as follows:

1. Power on the unit and enter to BT mode as previously instructed. You will hear an audible prompt say “Bluetooth ready for connection” and the Blue Indicator on the front of unit will illuminate and blink.
2. Power on the external BT Device and enter to BT searching mode. Start pairing following the on screen instructions from the external BT Device. When paired, the unit will sound a prompt “Bluetooth connected” and the Blue Indicator will stop blinking.

3. If pairing is complete you may now play music and answer the phone with your external BT Device.
4. During playback:
 - Press the > Button to pause; press again to resume to normal playback.
 - Press and release the “-” or “+” buttons repeatedly to adjust volume level as desired.
 - Press and hold the “-” or “+” buttons repeatedly to skip tracks.
5. If the unit is paired to a Cell Phone:
 - If a call is incoming during an active music session:
 - Press the > Button then speak to the Microphone to answer the call. When your call is complete, press the > Button to disconnect or end the call and resume to music playback.
 - Or, press and holding the > Button approximately 1 second to decline the incoming phone then resume to music playback.
 - Quick press the > Button twice to redialing the last telephone number.
6. When finished listening, slide the Power ON/OFF Switch to OFF position to shut off the unit.

Notes:

- When the external BT Device searched the unit, our model number “MMA3748” will appear on the display of external BT Device.
- If while pairing you are asked for a code please try "0000" or "1234".

Normal operation after pairing:

1. Power on the external BT Device and enter to BT playback mode.
2. Power on the unit and enter to BT mode as previously instructed. You will hear an audible prompt say “Bluetooth ready for connection” and the Blue Indicator on the front of unit will illuminate and blink.
3. Wait a few seconds until the unit is automatically paired to the external BT Device. The unit will sound a prompt “Bluetooth connected” and the Blue Indicator will stop blinking.
4. After pairing is complete you may now play music and answer calls with your external BT Device.

TF (Micro SD Card):

To play the music in TF (Micro SD) Card:

1. In power off mode, insert the TF (Micro SD) Card (not included) into the TF (Micro SD) Card Slot on the rear of unit with contacts facing up as illustrated below:

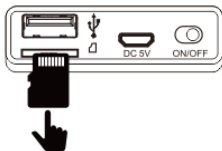

2. Power on the unit and enter to TF (Micro SD) Card playback mode as previously instructed:
 - You will hear an audible prompt say “Memory Card”.
 - Music in the card will be playback automatically.
3. During playback:
 - Press the > Button to pause; press again to resume to normal playback.
 - Press and release the “-” or “+” buttons repeatedly to adjust volume level as desired.
 - Press and hold the “-” or “+” buttons repeatedly to skip tracks.
4. When finished listening, slide the Power ON/OFF Switch to OFF position to shut off the unit.

USB:

To play the music in external USB Device:

1. In power off mode, connect the USB Device (not included) into the USB Port on the front of unit as illustrated below:

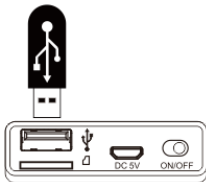

2. Power on the unit and enter to USB mode as previously instructed:
 - You will hear an audible prompt say “USB”.
 - Music in the USB Device will be playback automatically.
3. During playback:
 - Press the > Button to pause; press again to resume to normal playback.
 - Press and release the “-” or “+” buttons repeatedly to adjust volume level as desired.
 - Press and hold the “-” or “+” buttons repeatedly to skip tracks.
4. When finished listening, slide the Power ON/OFF Switch to OFF position to shut off the unit.

Notes:



- Up to 16 GB TF (Micro SD) Card /USB Device the unit supports to play.
- When inserting the TF (Micro SD) Card /USB Device, make sure the direction you selected is correct. Never insert violently to avoid damaging the TF (Micro SD) Card /USB Device or the unit. If it doesn't work, please check if the direction is correct.
- Before replacing TF (Micro SD)/USB Device, make sure the unit has been powered off.
- You also need to download the desired music in MP3 format into the TF (Micro SD) Card /USB Device before insert into the unit.

TROUBLE SHOOTING GUIDE

Check the following before requesting service:

SYMPTOM	POSSIBLE CAUSE	POSSIBLE SOLUTION
Can't power on	Built-in battery drained	Recharge the battery as page 4-5
	The unit in power off mode	Slide the Power ON/OFF Switch on the rear of unit to ON position to power on the unit
No sound or sound weak	Volume of the unit was set to minimum position	Increase the volume level by press and release the “+” Button repeatedly
	Volume level of paired device is in low level	Rise the volume level of the paired device
Sound distortion	Volume level too high	Reduce the volume level by press and release the “-” Button repeatedly
	Volume level of the paired device too high	Reduce the volume level of the paired device
BT not functioning	The external BT device had NOT paired to the unit	Pair the external BT device to the unit as page 6-7
	The external BT device too far from the unit	Place the external BT device close to the unit

GENERAL SPECIFICATIONS:

Power Source:	Built-in DC  3.7V, 400mAh (1.48WH) rechargeable Li-ion Battery; recharge by DC  5V through the DC 5V (Micro USB) Port
Impedance of Speakers:	3W; 4Ω
Audio Power:	1.5W (RMS)
BT Version:	4.2
BT Operation Distance:	Up to 32 Feet in open area

PACKAGE INCLUDES:

1 x Owner's Manual

1 x USB Connection Cable (For Charging Only)

SPECIFICATIONS AND ACCESSORIES ARE SUBJECT TO CHANGE WITHOUT NOTICE

LIMITED WARRANTY

Craig Electronics Inc. warrants this product to be free from manufacturing defects in material and workmanship under normal use for a period of 180 days from date of purchase. If service is required, please return the product to the store where it was purchased for exchange; or, pack the unit in the original packing material with all accessories if applicable, a copy of your sales receipt and a Cashier's check or Money Order for \$3 (to cover shipping and handling costs) payable to Craig Electronics Inc. For consumers in Canada, please make sure that the cashier check or money order is redeemable through a U.S. bank. Ship your product freight pre-paid. Your unit will be repaired, replaced or if the unit can not be repaired or replaced, a refund will be forwarded to you within four weeks of receipt of your unit. Please ship your unit to:

Craig Electronics Inc.
1160 NW 163 Drive
Miami, FL 33169

This warranty is void if the product has been: a) Used in a commercial application or rental. b) Damaged through misuse, negligence, or abuse. c) Modified or repaired by anyone other than an authorized Craig Electronics Inc. service center. d) Damaged because it is improperly connected to any other equipment.

Note: This warranty does not cover: a) Ordinary adjustments as outlined in the Owner's Manual which can be performed by the customer. b) Damage to equipment not properly connected to the product. c) Any cost incurred in shipping the product for repair. d) Damage to the product not used in the USA.

This warranty is not transferable and only applies to the original purchase. Any implied warranties, including the warranty of merchantability, are limited in duration to the period of this expressed warranty and no warranty whether expressed or implied shall apply to the product thereafter.

Under no circumstance shall Craig Electronics Inc. be liable for any loss or consequential damage arising out of the use of this product. This warranty gives specific legal rights. However, you may have other rights which may vary from state to state. Some states do not allow limitations on implied warranties or exclusion of consequential damage. Therefore, these restrictions may not apply to you.

This product has been manufactured by and is sold under the responsibility of Craig Electronics Inc., and Craig Electronics Inc. is the warrantor in relation to this product. MAGNAVOX and SMART. VERY SMART are registered trademarks of Koninklijke Philips N.V. and are used under license from Koninklijke Philips N.V.

To Obtain Service on your Product
email: magnavox@craigelectronics.com