

FCC - TEST REPORT

Report Number : **68.950.20.0053.01** Date of Issue: **May 08, 2020**

Model : MDZ-24-AA

Product Type : Mi TV Stick

Applicant : Beijing Xiaomi Electronics Co., Ltd.

Address : Room 707,7F, Building 5, No 58, JinghaiWulu Road, Beijing
economic and Technological Development Zone, Beijing 100176 Beijing
City PEOPLE'S REPUBLIC OF CHINA

Manufacturer : Beijing Xiaomi Electronics Co., Ltd.

Address : Room 707,7F, Building 5, No 58, JinghaiWulu Road, Beijing
economic and Technological Development Zone, Beijing 100176 Beijing
City PEOPLE'S REPUBLIC OF CHINA

Factory : Shenzhen Twowing Technologies Co., Ltd.

Address : Floor 1-12, Nangang Industrial Building, Tangtou Industrial
Park, Shiyan, Baoan, Shenzhen, Guangdong, China

Test Result : Positive Negative

Total pages including
Appendices : **62**

TÜV SÜD Certification and Testing (China) Co., Ltd. Shenzhen Branch is a subcontractor to TÜV SÜD Product Service GmbH according to the principles outlined in ISO 17025.

TÜV SÜD Certification and Testing (China) Co., Ltd. Shenzhen Branch reports apply only to the specific samples tested under stated test conditions. Construction of the actual test samples has been documented. It is the manufacturer's responsibility to assure that additional production units of this model are manufactured with identical electrical and mechanical components. The manufacturer/importer is responsible to the Competent Authorities in Europe for any modifications made to the production units which result in non-compliance to the relevant regulations. TÜV SÜD Certification and Testing (China) Co., Ltd. Shenzhen Branch shall have no liability for any deductions, inferences or generalizations drawn by the client or others from TÜV SÜD Certification and Testing (China) Co., Ltd. Shenzhen Branch issued reports.

This report is the confidential property of the client. As a mutual protection to our clients, the public and ourselves, extracts from the test report shall not be reproduced except in full without our written approval

1 Table of Contents

1	Table of Contents	2
2	Details about the Test Laboratory.....	3
3	Description of the Equipment Under Test.....	4
4	Summary of Test Standards	5
5	Summary of Test Results	6
6	General Remarks	7
7	Test Setups.....	8
8	Systems test configuration	9
9	Technical Requirement.....	10
9.1	Conducted Emission Test	10
9.2	Conducted peak output power.....	13
9.3	6dB bandwidth and 99% Occupied Bandwidth.....	15
9.4	Power spectral density.....	20
9.5	Spurious RF conducted emissions.....	25
9.6	Band edge testing	40
9.7	Spurious radiated emissions for transmitter	44
10	Test Equipment List.....	61
11	System Measurement Uncertainty.....	62

2 Details about the Test Laboratory

Details about the Test Laboratory

Test Site 1

Company name: TÜV SÜD Certification and Testing (China) Co., Ltd. Shenzhen Branch
Building 12&13, Zhiheng Wisdomland Business Park,
Nantou Checkpoint Road 2, Nanshan District,
Shenzhen City, 518052,
P. R. China

FCC Registration No.: 514049

IC Registration No: 10320A

Telephone: 86 755 8828 6998

Fax: 86 755 8828 5299

3 Description of the Equipment Under Test

Product:	Mi TV Stick
Model no.:	MDZ-24-AA
Brand Name	MI
FCC ID:	2AIMRMITVMDZ24AA
Options and accessories:	Adapter, USB Cable and Wireless Remote Control
Input Rating: Adapter:	5Vdc/1000mA (Supplied By AC/DC Adapter) Input:100-240V~50/60Hz 0.2A Output: 5V/1000mA
RF Transmission Frequency:	2412-2462MHz
No. of Operated Channel:	11
Modulation:	DSSS, OFDM
Antenna Type:	Internal Antenna
Antenna Gain:	3dBi
Description of the EUT:	The Equipment Under Test (EUT) is a TV Stick which support 2.4G Wi-Fi, 5G Wi-Fi, BR/EDR and BLE function. The 2.4G Wi-Fi, BR/EDR and BLE operated at 2400MHz to 2483.5MHz, The 5G Wi-Fi operation 5150MHz to 5250MHz, and 5725MHz to 5825MHz.

4 Summary of Test Standards

Test Standards	
FCC Part 15 Subpart C 10-1-2019 Edition	PART 15 - RADIO FREQUENCY DEVICES Subpart C - Intentional Radiators

All the test methods were according to KDB 558074 D01 v05r02 DTS Measurement Guidance and ANSI C63.10 (2013).

5 Summary of Test Results

Technical Requirements					
FCC Part 15 Subpart C					
Test Condition	Test Site	Test Result			
		Pass	Fail	N/A	
§15.207	Conducted emission AC power port	Site 1	<input checked="" type="checkbox"/>	<input type="checkbox"/>	<input type="checkbox"/>
§15.247 (b) (1)	Conducted peak output power	Site 1	<input checked="" type="checkbox"/>	<input type="checkbox"/>	<input type="checkbox"/>
§15.247(a)(1)	20dB bandwidth	---	<input type="checkbox"/>	<input type="checkbox"/>	<input checked="" type="checkbox"/>
§15.247(a)(1)	Carrier frequency separation	---	<input type="checkbox"/>	<input type="checkbox"/>	<input checked="" type="checkbox"/>
§15.247(a)(1)(iii)	Number of hopping frequencies	---	<input type="checkbox"/>	<input type="checkbox"/>	<input checked="" type="checkbox"/>
§15.247(a)(1)(iii)	Dwell Time	---	<input type="checkbox"/>	<input type="checkbox"/>	<input checked="" type="checkbox"/>
§15.247(a)(2)	6dB bandwidth and 99% Occupied Bandwidth	Site 1	<input checked="" type="checkbox"/>	<input type="checkbox"/>	<input type="checkbox"/>
§15.247(e)	Power spectral density	Site 1	<input checked="" type="checkbox"/>	<input type="checkbox"/>	<input type="checkbox"/>
§15.247(d)	Spurious RF conducted emissions	Site 1	<input checked="" type="checkbox"/>	<input type="checkbox"/>	<input type="checkbox"/>
§15.247(d)	Band edge	Site 1	<input checked="" type="checkbox"/>	<input type="checkbox"/>	<input type="checkbox"/>
§15.247(d) & §15.209	Spurious radiated emissions for transmitter	Site 1	<input checked="" type="checkbox"/>	<input type="checkbox"/>	<input type="checkbox"/>
§15.203	Antenna requirement	See note 2	<input checked="" type="checkbox"/>	<input type="checkbox"/>	<input type="checkbox"/>

Note 1: N/A=Not Applicable.

Note 2: The EUT uses an internal antenna, which gain is 3dBi. In accordance to §15.203, It is considered sufficiently to comply with the provisions of this section.

6 General Remarks

Remarks

This submittal(s) (test report) is intended for FCC ID:2AIMRMITVMDZ24AA, complies with Section 15.209, 15.247 of the FCC Part 15, Subpart C rules.

The Equipment Under Test (EUT) is a TV Stick which support 2.4G Wi-Fi, 5G Wi-Fi, BR/EDR and BLE function. The 2.4G Wi-Fi, BR/EDR and BLE operated at 2400MHz to 2483.5MHz, The 5G Wi-Fi operation 5150MHz to 5250MHz, and 5725MHz to 5825MHz.

This report for 2.4GHz Wi-Fi only.

SUMMARY:

All tests according to the regulations cited on page 5 were

■ - Performed

□ - **Not** Performed

The Equipment Under Test

■ - **Fulfills** the general approval requirements.

□ - **Does not** fulfill the general approval requirements.

Sample Received Date: February 20, 2020

Testing Start Date: February 21, 2020

Testing End Date: April 27, 2020

TÜV SÜD Certification and Testing (China) Co., Ltd. Shenzhen Branch

Reviewed by:

Prepared by:

Tested by:

John Zhi
Section Manager



Warlen Song
Project Engineer

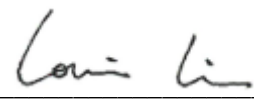

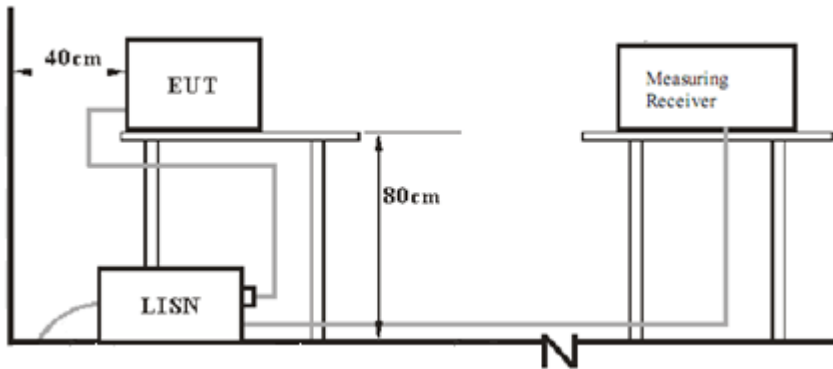

Louise Liu
Test Engineer

7 Test Setups

7.1 AC Power Line Conducted Emission test setups

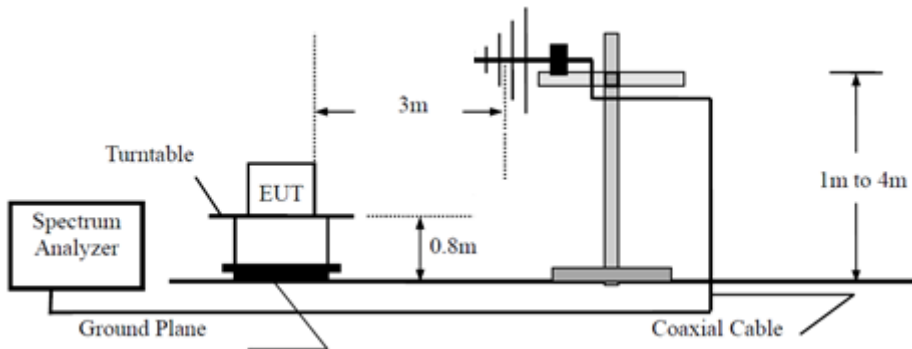

7.2 Radiated test setups Below 1GHz



Above 1GHz

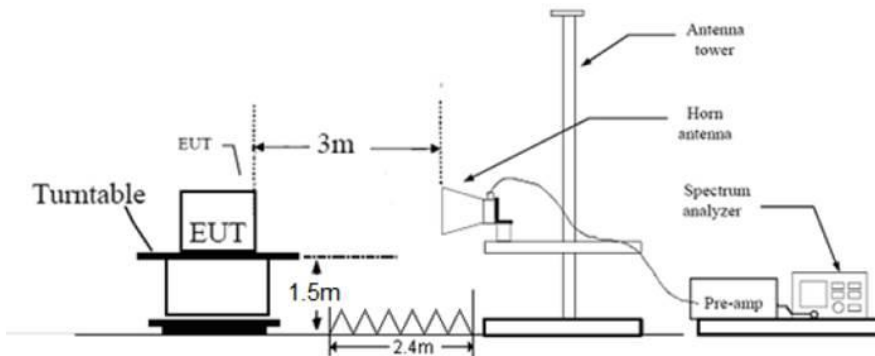

7.3 Conducted RF test setups

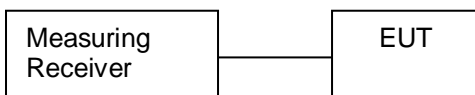

8 Systems test configuration

Auxiliary Equipment Used during Test:

DESCRIPTION	MANUFACTURER	MODEL NO.(SHIELD)	S/N(LENGTH)
Phone	ZTE	--	--
Notebook	Lenovo	X220	

Test software: RF test tool

Test Channel:	L	M	H
11B	2412	2437	2462
11G	2412	2437	2462
11N_20	2412	2437	2462
11N_40	2422	2437	2452

Power Setting:

	Setting
11B	44
11G	48
11N_20	46
11N_40	46

9 Technical Requirement

9.1 Conducted Emission Test

Test Method

1. The EUT was placed on a table, which is 0.8m above ground plane
2. The power line of the EUT is connected to the AC mains through a Artificial Mains Network (A.M.N.).
3. Maximum procedure was performed to ensure EUT compliance
4. A EMI test receiver is used to test the emissions from both sides of AC line

Limit

According to §15.207, conducted emissions limit as below:

Frequency MHz	QP Limit dB μ V	AV Limit dB μ V
0.150-0.500	66-56*	56-46*
0.500-5	56	46
5-30	60	50

*Decreasing linearly with logarithm of the frequency

Conducted Emission

Product Type : Mi TV Stick
 M/N : MDZ-24-AA
 Operating Condition : Wi-Fi connection+BT control
 Test Specification : Line
 Comment : AC 120V/60Hz

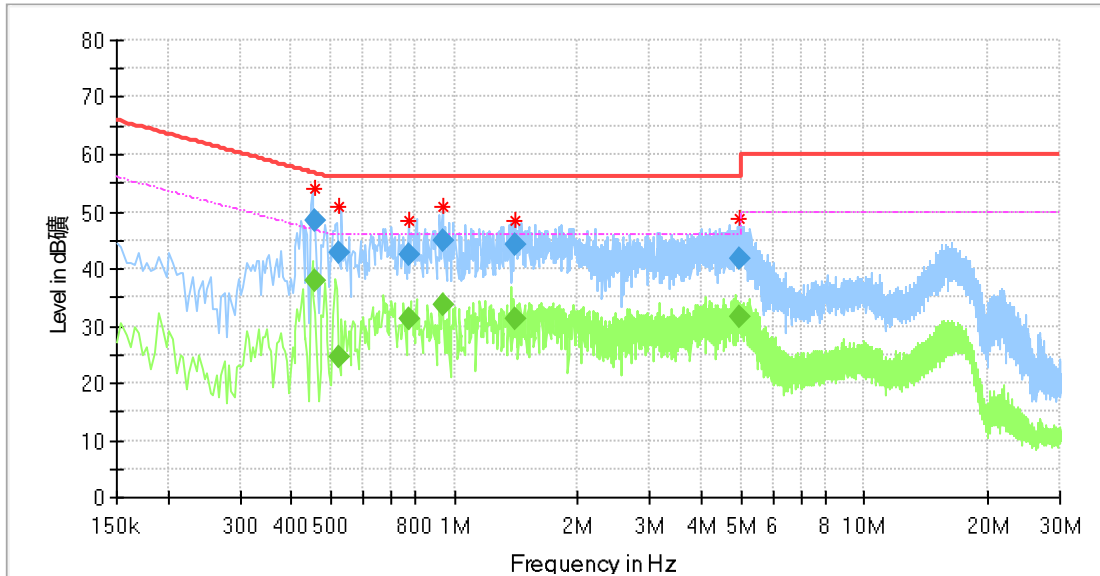

Critical_Freqs

Frequency (MHz)	MaxPeak (dBµV)	Average (dBµV)	Limit (dBµV)	Margin (dB)	Line	Corr. (dB)
0.454500	54.12	---	56.88	2.76	L1	10.3
0.525500	51.00	---	56.00	5.00	L1	10.3
0.773500	48.46	---	56.00	7.54	L1	10.3
0.933500	50.76	---	56.00	5.24	L1	10.3
1.413500	48.53	---	56.00	7.47	L1	10.3
4.937500	48.93	---	56.00	7.07	L1	10.5

Final Result

Frequency (MHz)	QuasiPeak (dBµV)	Average (dBµV)	Limit (dBµV)	Margin (dB)	Line	Corr. (dB)
0.454500	48.45	---	56.79	8.34	L1	10.3
0.454500	---	38.04	46.79	8.75	L1	10.3
0.525500	---	24.52	46.00	21.48	L1	10.3
0.525500	42.93	---	56.00	13.07	L1	10.3
0.773500	42.31	---	56.00	13.69	L1	10.3
0.773500	---	31.09	46.00	14.91	L1	10.3
0.933500	---	33.56	46.00	12.44	L1	10.3
0.933500	45.05	---	56.00	10.95	L1	10.3
1.413500	44.07	---	56.00	11.93	L1	10.3
1.413500	---	31.08	46.00	14.92	L1	10.3
4.937500	41.89	---	56.00	14.11	L1	10.5
4.937500	---	31.69	46.00	14.31	L1	10.5

Remark :

Level=Reading Level + Correction Factor

Correction Factor=Cable Loss + LISN Factor

(The Reading Level is recorded by software which is not shown in the sheet)

Conducted Emission

Product Type : Mi TV Stick
 M/N : MDZ-24-AA
 Operating Condition : Wi-Fi connection+BT control
 Test Specification : Neutral
 Comment : AC 120V/60Hz

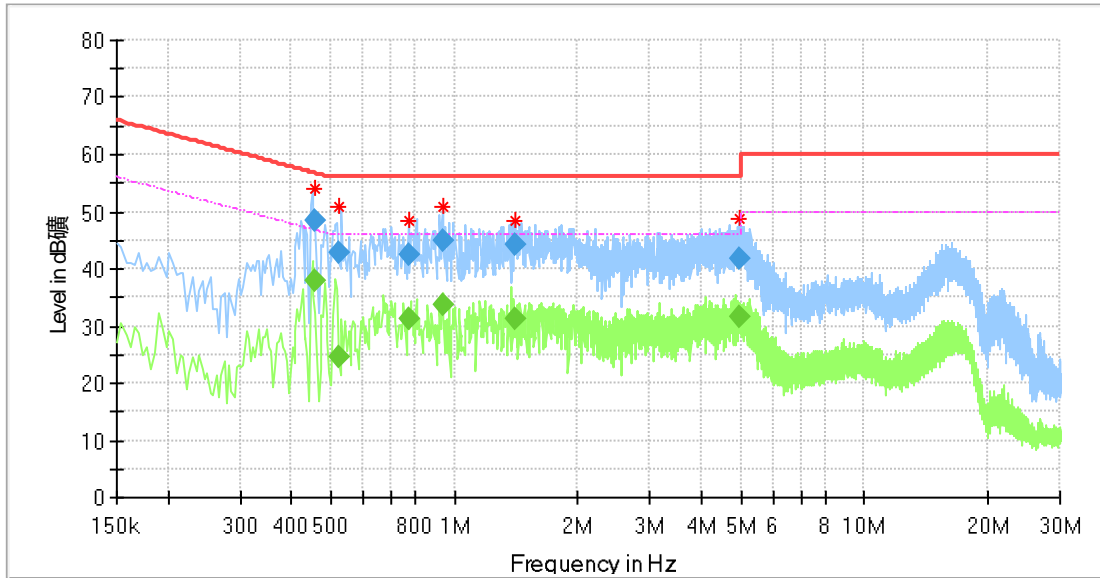

Critical_Freqs

Frequency (MHz)	MaxPeak (dBμV)	Average (dBμV)	Limit (dBμV)	Margin (dB)	Line	Corr. (dB)
0.454500	54.12	---	56.88	2.76	L1	10.3
0.525500	51.00	---	56.00	5.00	L1	10.3
0.773500	48.46	---	56.00	7.54	L1	10.3
0.933500	50.76	---	56.00	5.24	L1	10.3
1.413500	48.53	---	56.00	7.47	L1	10.3
4.937500	48.93	---	56.00	7.07	L1	10.5

Final Result

Frequency (MHz)	QuasiPeak (dBμV)	Average (dBμV)	Limit (dBμV)	Margin (dB)	Line	Corr. (dB)
0.454500	48.45	---	56.79	8.34	L1	10.3
0.454500	---	38.04	46.79	8.75	L1	10.3
0.525500	---	24.52	46.00	21.48	L1	10.3
0.525500	42.93	---	56.00	13.07	L1	10.3
0.773500	42.31	---	56.00	13.69	L1	10.3
0.773500	---	31.09	46.00	14.91	L1	10.3
0.933500	---	33.56	46.00	12.44	L1	10.3
0.933500	45.05	---	56.00	10.95	L1	10.3
1.413500	44.07	---	56.00	11.93	L1	10.3
1.413500	---	31.08	46.00	14.92	L1	10.3
4.937500	41.89	---	56.00	14.11	L1	10.5
4.937500	---	31.69	46.00	14.31	L1	10.5

Remark :

Level=Reading Level + Correction Factor

Correction Factor=Cable Loss + LISN Factor

(The Reading Level is recorded by software which is not shown in the sheet)

9.2 Conducted peak output power

Test Method

1. Connect the power meter to the EUT
 - a) The EUT is configured to transmit continuously, or to transmit with a constant duty factor.
 - b) At all times the EUT is transmitting at its maximum power control level.
 - c) The integration period of the power meter exceeds the repetition period of the transmitted signal by at least a factor of five.
2. Measure the average power of the transmitter. This measurement is an average over both the on and off periods of the transmitter.
3. Adjust the measurement in dBm by adding $10\log(1/x)$, where x is the duty cycle to the measurement result.

Limits

According to §15.247 (b) (1), conducted peak output power limit as below:

Frequency Range MHz	Limit W	Limit dBm
2400-2483.5	≤1	≤30

Test result as below table

802.11b modulation Test Result

Frequency (MHz)	Conducted Peak Output Power (dBm)	Limit (dBm)	Result
Low channel 2412MHz	16.5	30	Pass
Middle channel 2437MHz	17.0	30	Pass
High channel 2462MHz	16.5	30	Pass

802.11g modulation Test Result

Frequency (MHz)	Conducted Peak Output Power (dBm)	Limit (dBm)	Result
Low channel 2412MHz	14.0	30	Pass
Middle channel 2437MHz	14.6	30	Pass
High channel 2462MHz	14.2	30	Pass

802.11n20 modulation Test Result

Frequency (MHz)	Conducted Peak Output Power (dBm)	Limit (dBm)	Result
Low channel 2412MHz	13.2	30	Pass
Middle channel 2437MHz	13.7	30	Pass
High channel 2462MHz	13.3	30	Pass

802.11n40 modulation Test Result

Frequency (MHz)	Conducted Peak Output Power (dBm)	Limit (dBm)	Result
Low channel 2422MHz	13.6	30	Pass
Middle channel 2437MHz	13.7	30	Pass
High channel 2452MHz	13.7	30	Pass

9.3 6dB bandwidth and 99% Occupied Bandwidth

Test Method for 6 dB Bandwidth

1. Use the following spectrum analyzer settings:
RBW=100K, VBW≥3RBW, Sweep = auto, Detector function = peak, Trace = max hold
2. Use the automatic bandwidth measurement capability of an instrument, may be employed using the X dB bandwidth mode with X set to 6 dB, care shall be taken so that the bandwidth measurement is not influenced by any intermediate power nulls in the fundamental emission that might be ≥ 6 dB.
3. Allow the trace to stabilize, record the X dB Bandwidth value.

802.11b modulation Test Result

Frequency (MHz)	6dB bandwidth (MHz)	99 bandwidth (MHz)	Limit (MHz)	Result
Low channel 2412MHz	10.160	14.825	/	Pass
Middle channel 2437MHz	10.160	14.905	/	Pass
High channel 2462MHz	10.160	14.865	/	Pass

802.11g modulation Test Result

Frequency (MHz)	6dB bandwidth (MHz)	99 bandwidth (MHz)	Limit (MHz)	Result
Low channel 2412MHz	16.400	17.183	/	Pass
Middle channel 2437MHz	16.400	17.223	/	Pass
High channel 2462MHz	16.400	17.183	/	Pass

802.11n-HT20 modulation Test Result

Frequency (MHz)	6dB bandwidth (MHz)	99 bandwidth (MHz)	Limit (MHz)	Result
Low channel 2412MHz	17.000	18.022	/	Pass
Middle channel 2437MHz	16.640	18.022	/	Pass
High channel 2462MHz	16.880	18.062	/	Pass

802.11n-HT40 modulation Test Result

Frequency (MHz)	6dB bandwidth (MHz)	99 bandwidth (MHz)	Limit (MHz)	Result
Low channel 2422MHz	35.280	36.284	/	Pass
Middle channel 2437MHz	35.520	36.284	/	Pass
High channel 2452MHz	35.280	36.284	/	Pass

6 dB Bandwidth

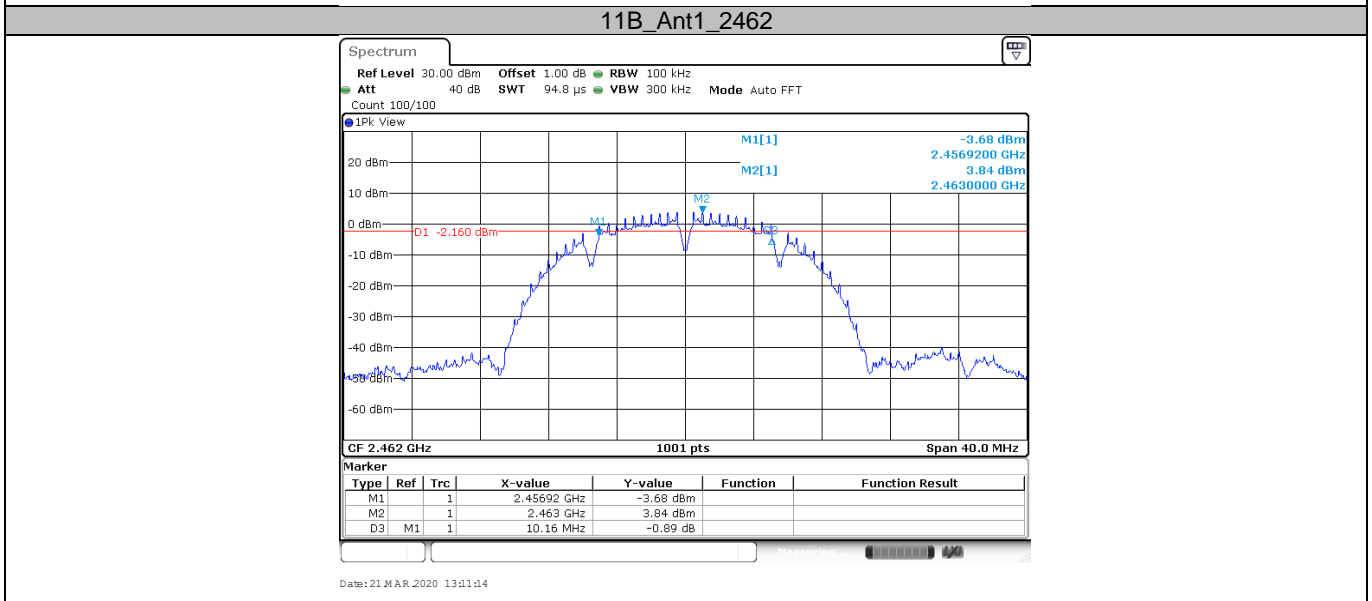
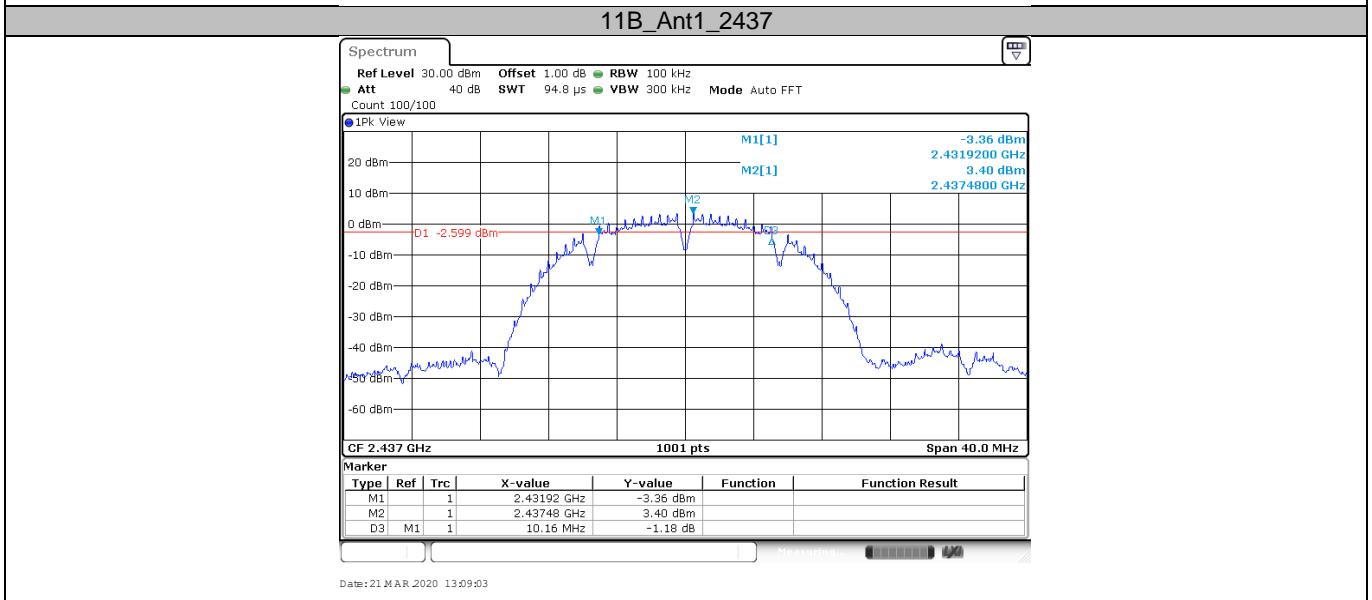
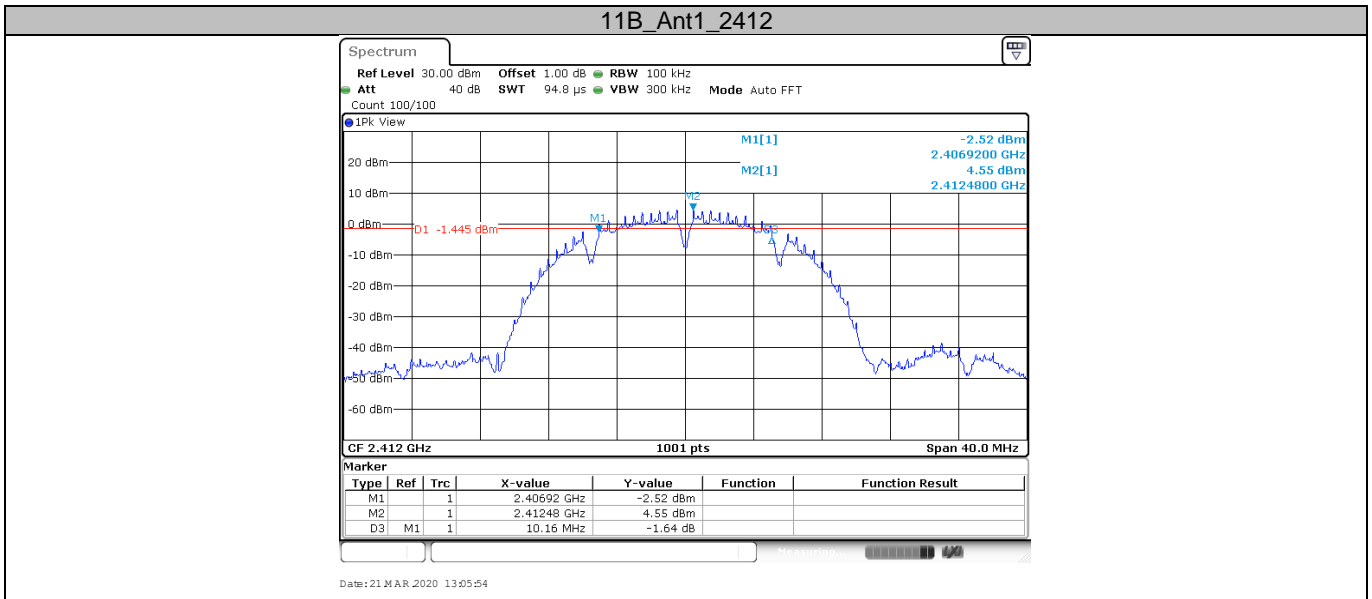

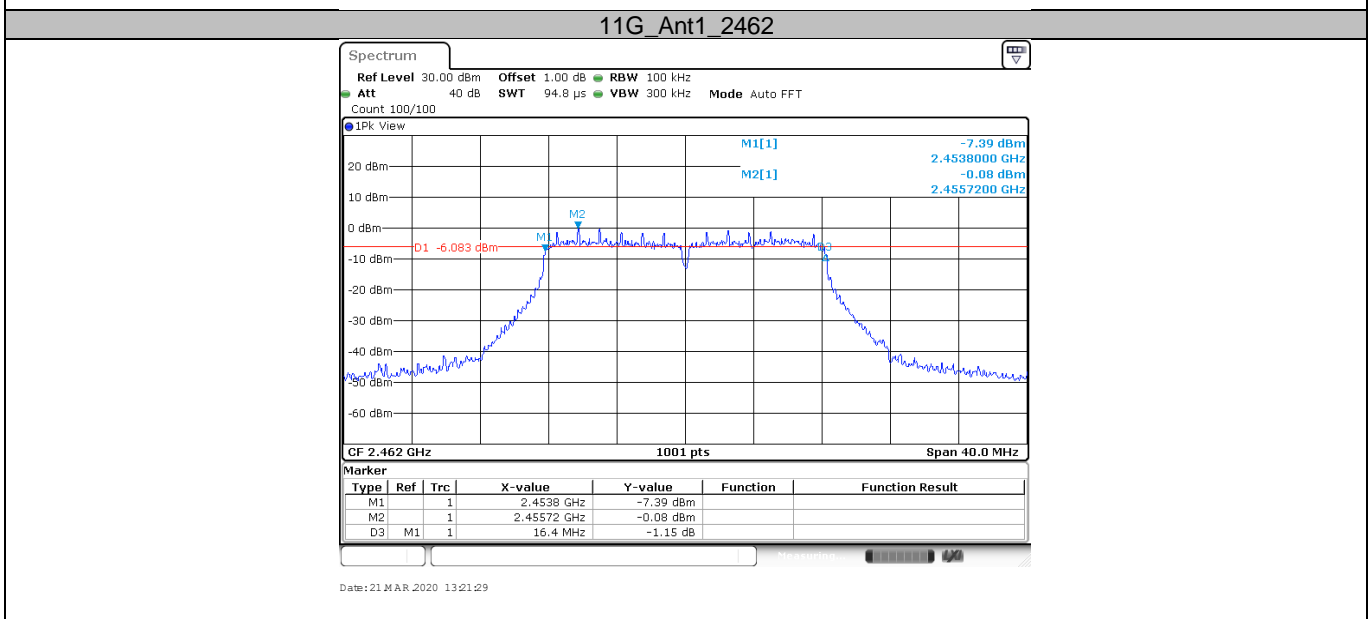
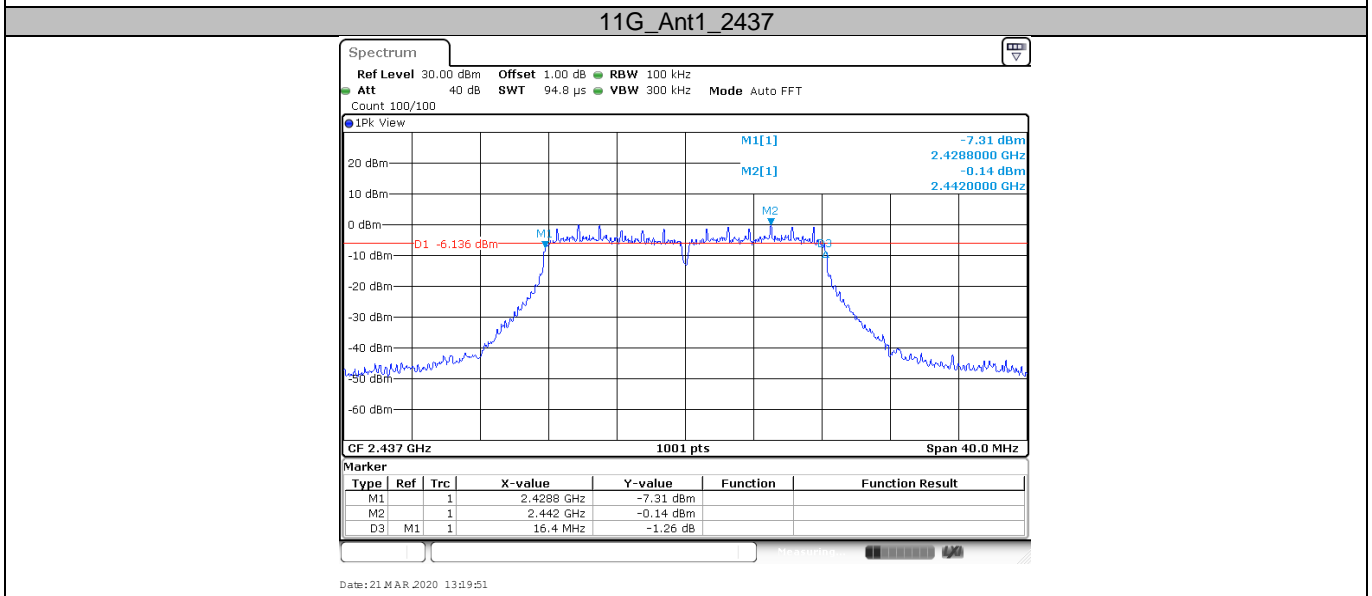
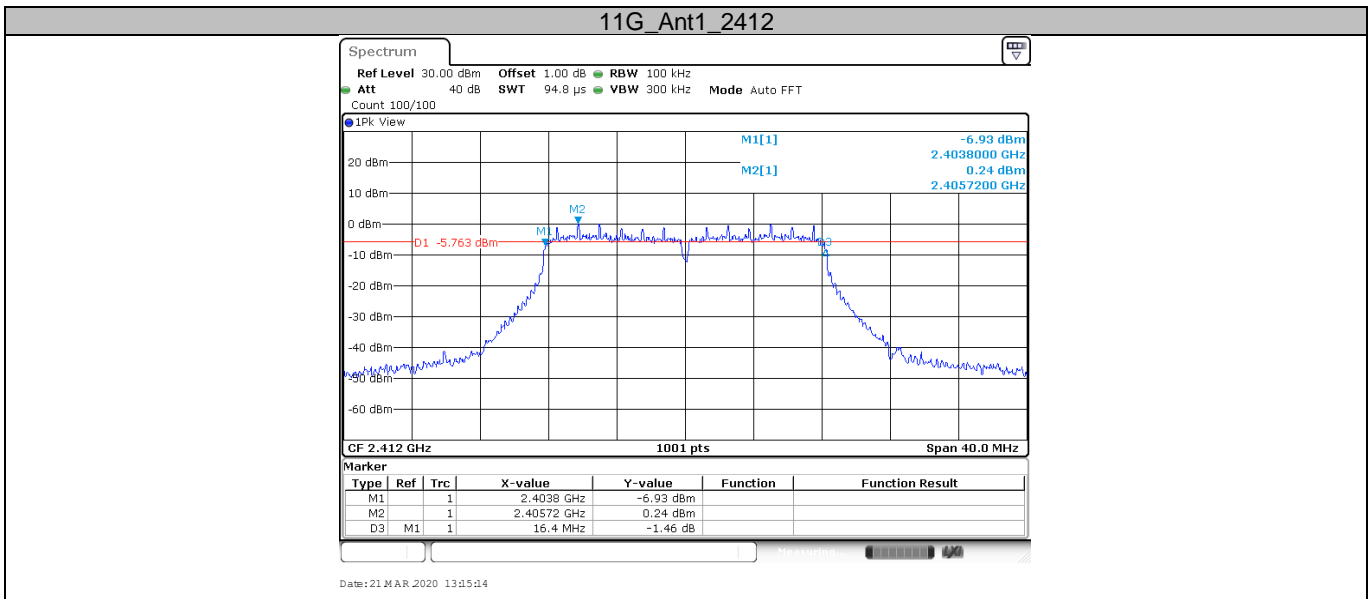

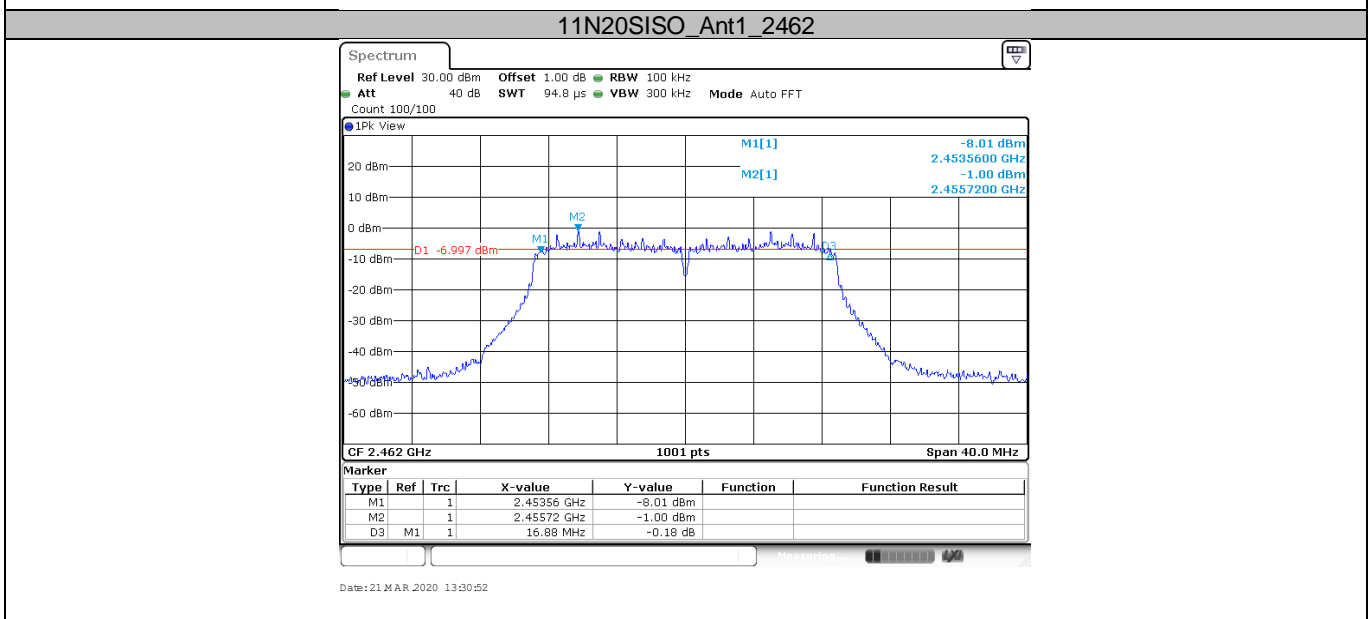
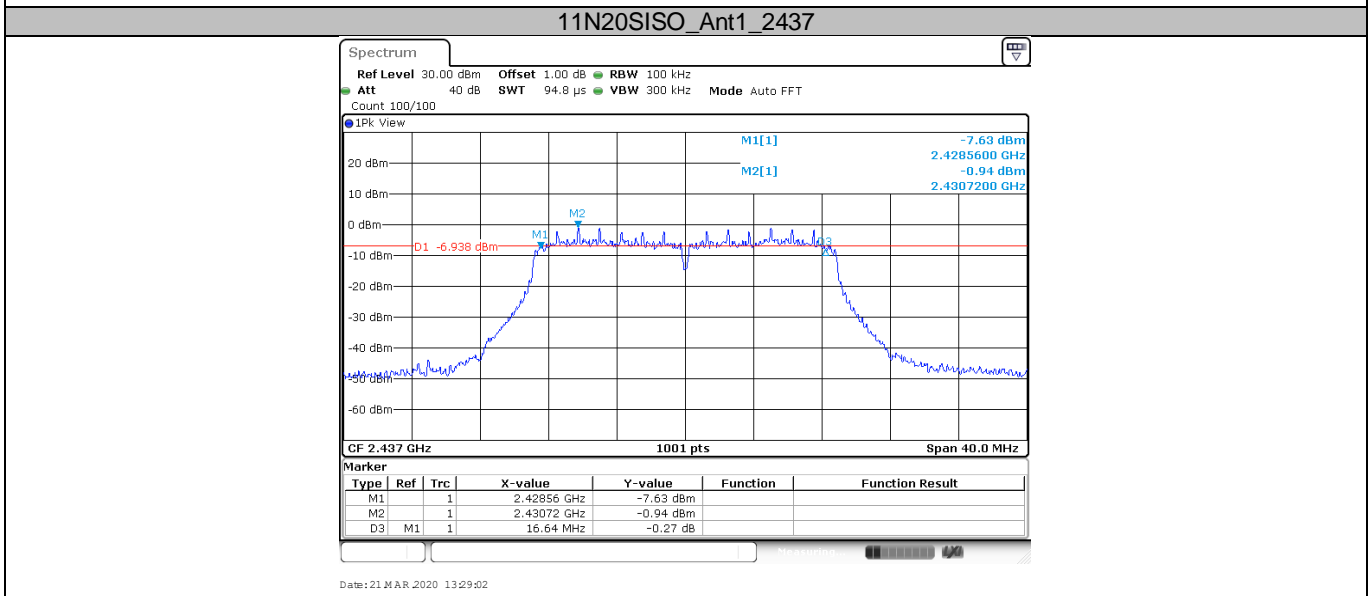
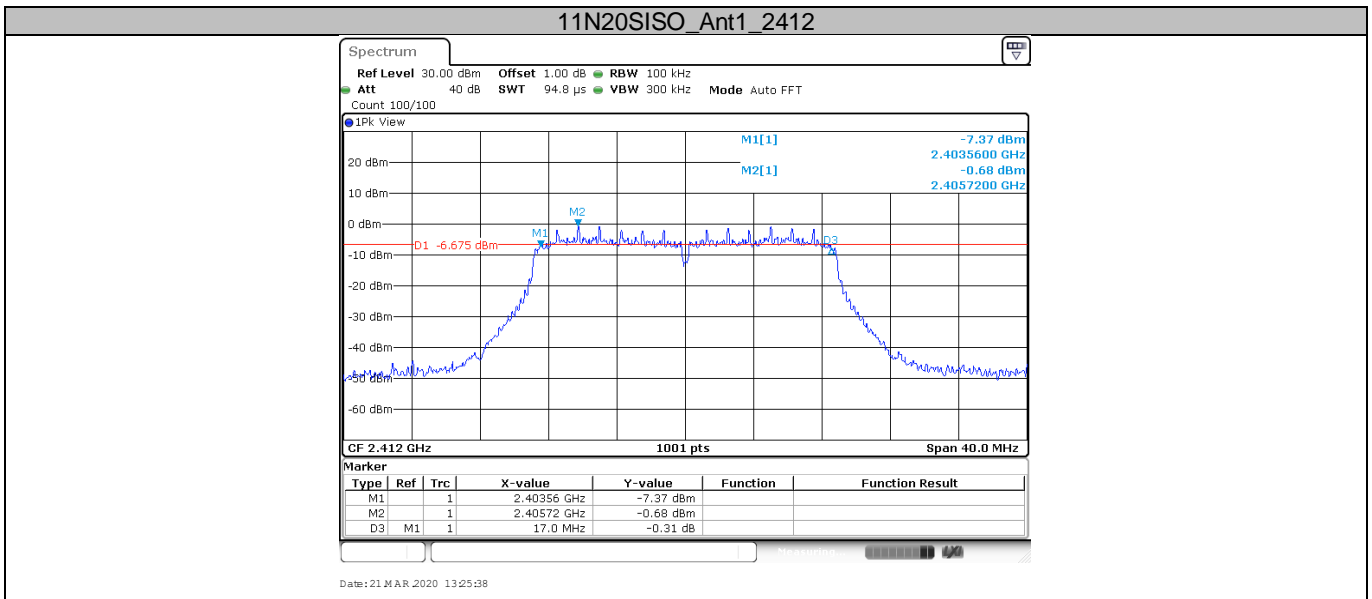

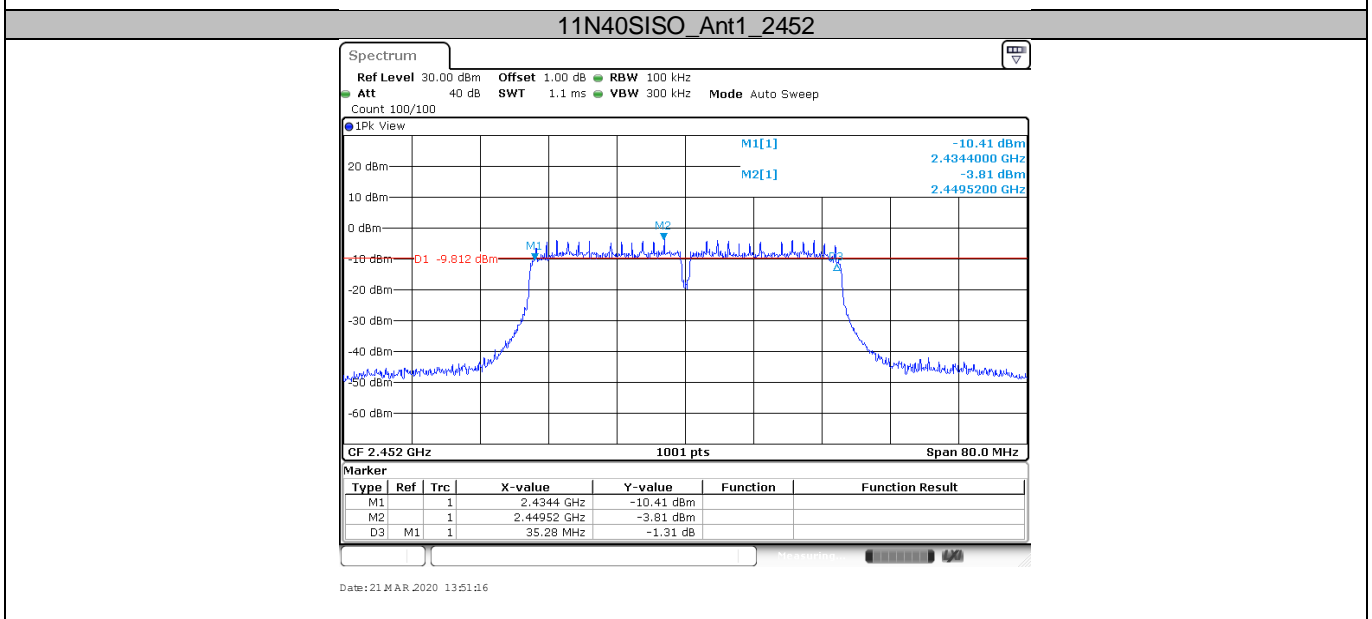
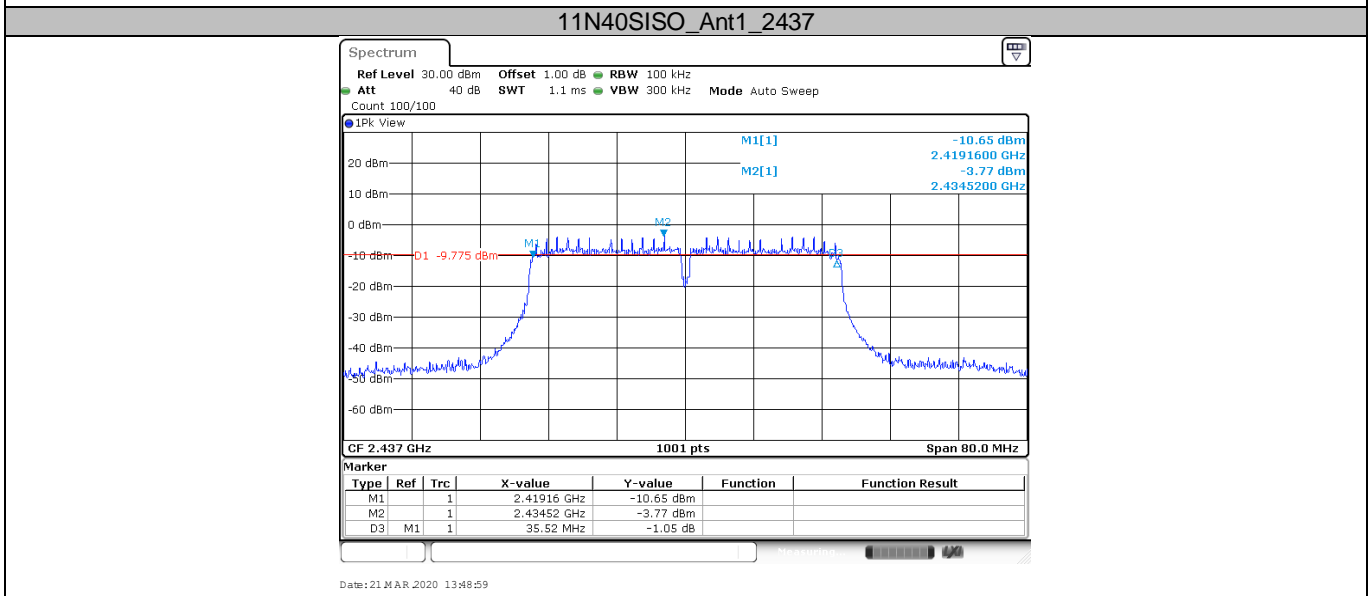
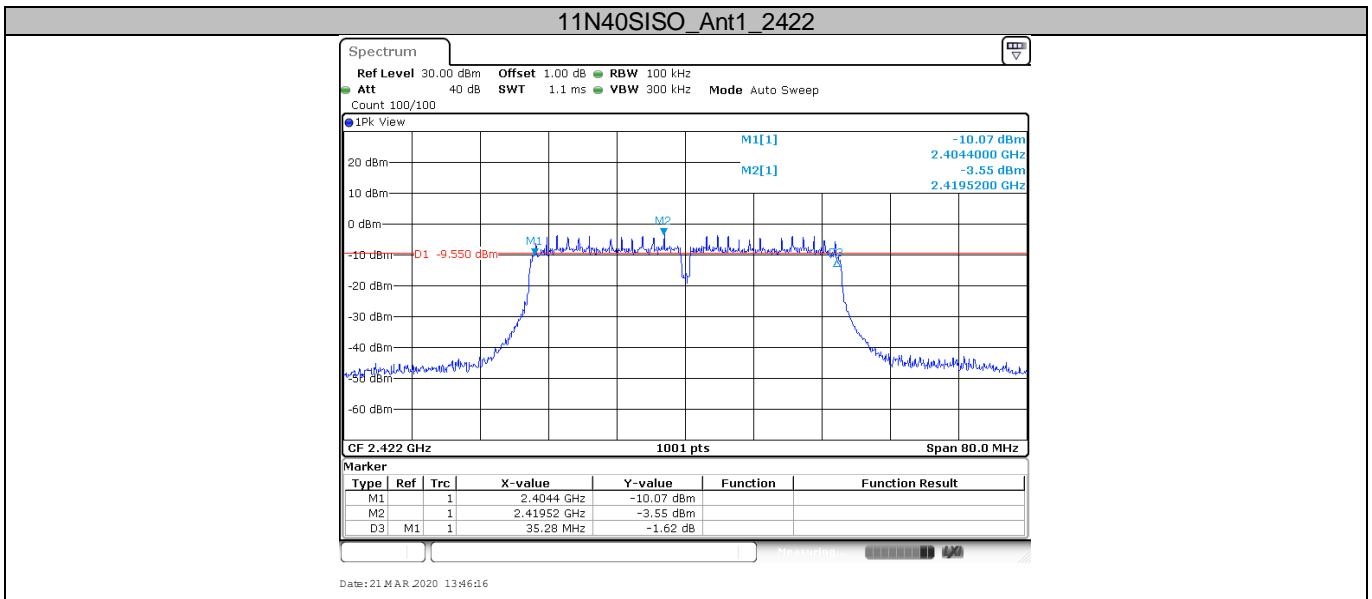

9.4 Power spectral density

Test Method

This procedure shall be used if maximum peak conducted output power was used to demonstrate compliance:

1. Set analyzer center frequency to DTS channel center frequency. RBW=3kHz, VBW≥3RBW, Span=1.5 times DTS bandwidth, Detector=Peak, Sweep=auto, Trace= max hold.
2. Allow trace to fully stabilize, use the peak marker function to determine the maximum amplitude level within the RBW.
3. Repeat above procedures until other frequencies measured were completed.

Limit

Limit [dBm/3KHz]

≤8

802.11b modulation Test Result

Frequency (MHz)	Power spectral density (dBm/3KHz)	Limit (dBm/3KHz)	Result
Low channel 2412MHz	-9.89	8	Pass
Middle channel 2437MHz	-10.17	8	Pass
High channel 2462MHz	-10.42	8	Pass

802.11g modulation Test Result

Frequency (MHz)	Power spectral density (dBm/3KHz)	Limit (dBm/3KHz)	Result
Low channel 2412MHz	-13.55	8	Pass
Middle channel 2437MHz	-14.05	8	Pass
High channel 2462MHz	-14.14	8	Pass

802.11n-HT20 modulation Test Result

Frequency (MHz)	Power spectral density (dBm/3KHz)	Limit (dBm/3KHz)	Result
Low channel 2412MHz	-14.74	8	Pass
Middle channel 2437MHz	-15.09	8	Pass
High channel 2462MHz	-15.20	8	Pass

802.11n-HT40 modulation Test Result

Frequency (MHz)	Power spectral density (dBm/3KHz)	Limit (dBm/3KHz)	Result
Low channel 2422MHz	-16.55	8	Pass
Middle channel 2437MHz	-16.65	8	Pass
High channel 2452MHz	-16.62	8	Pass

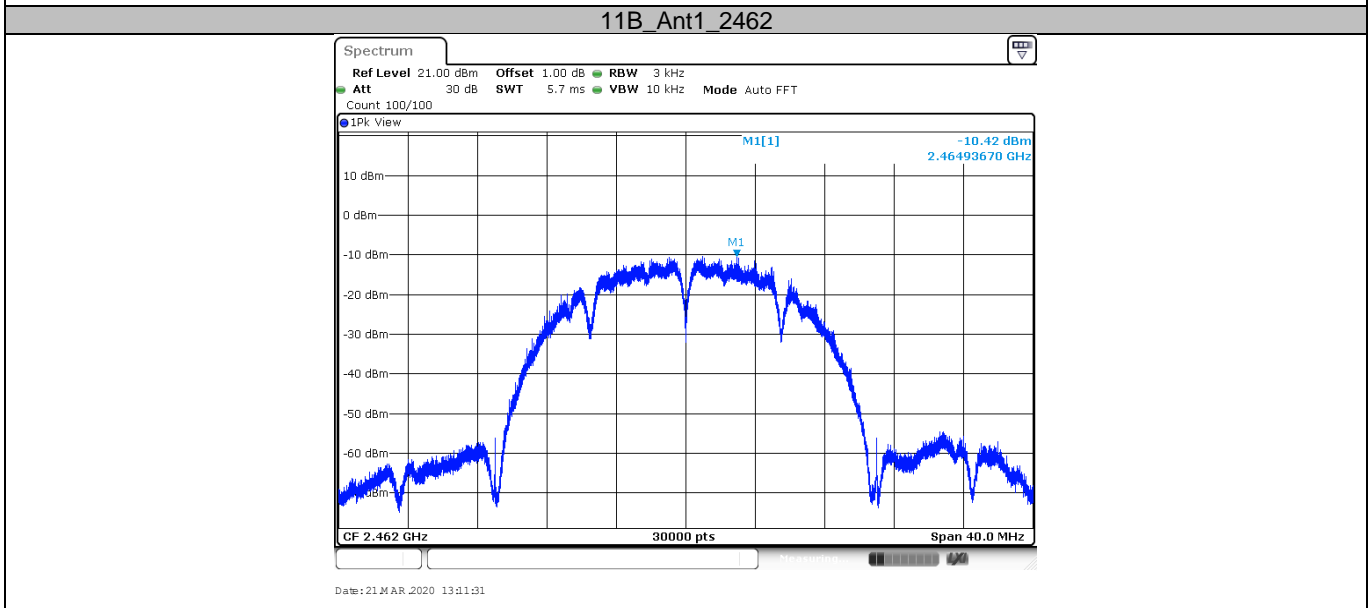
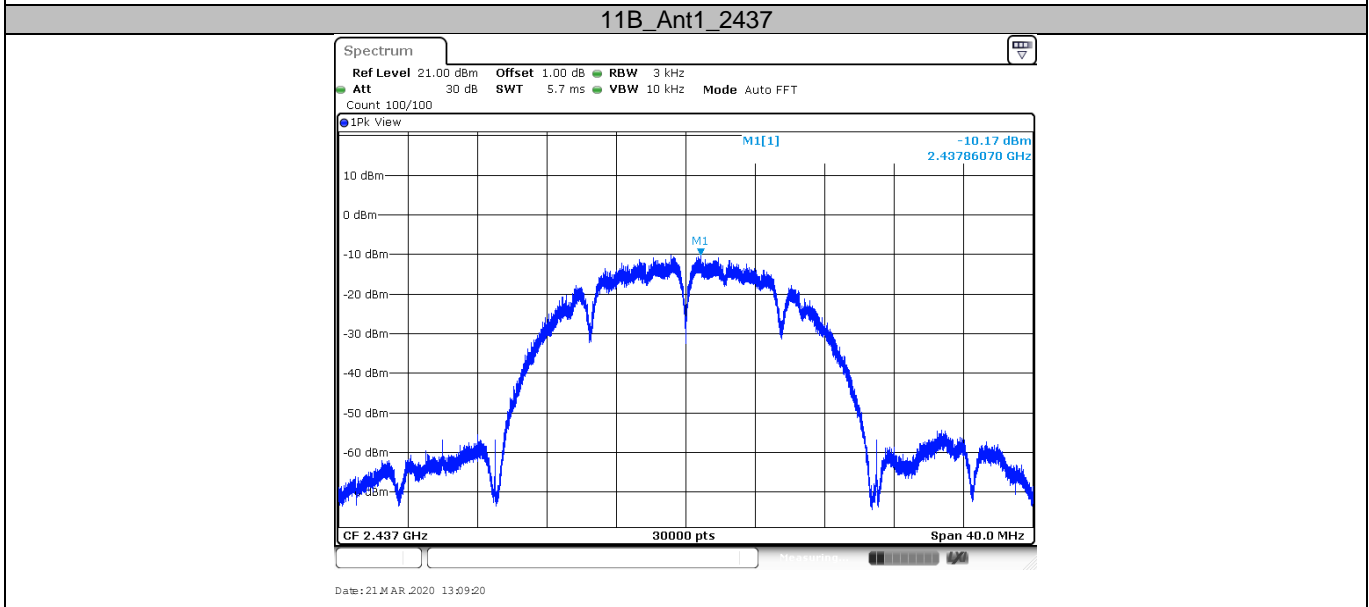
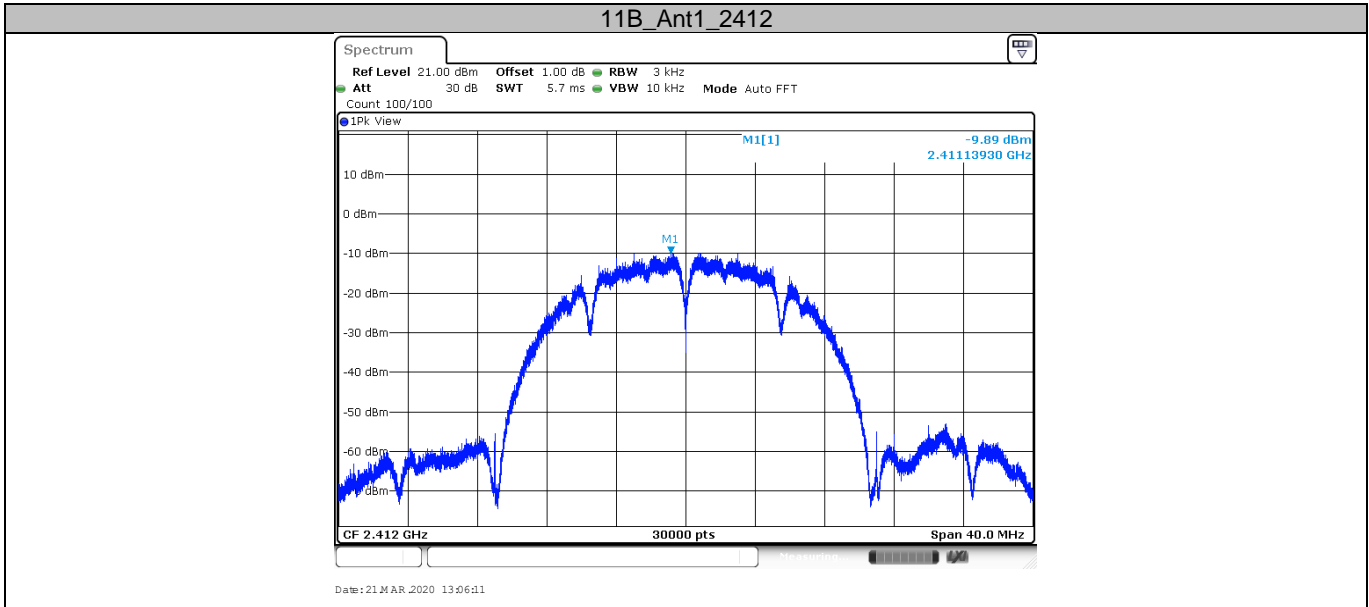

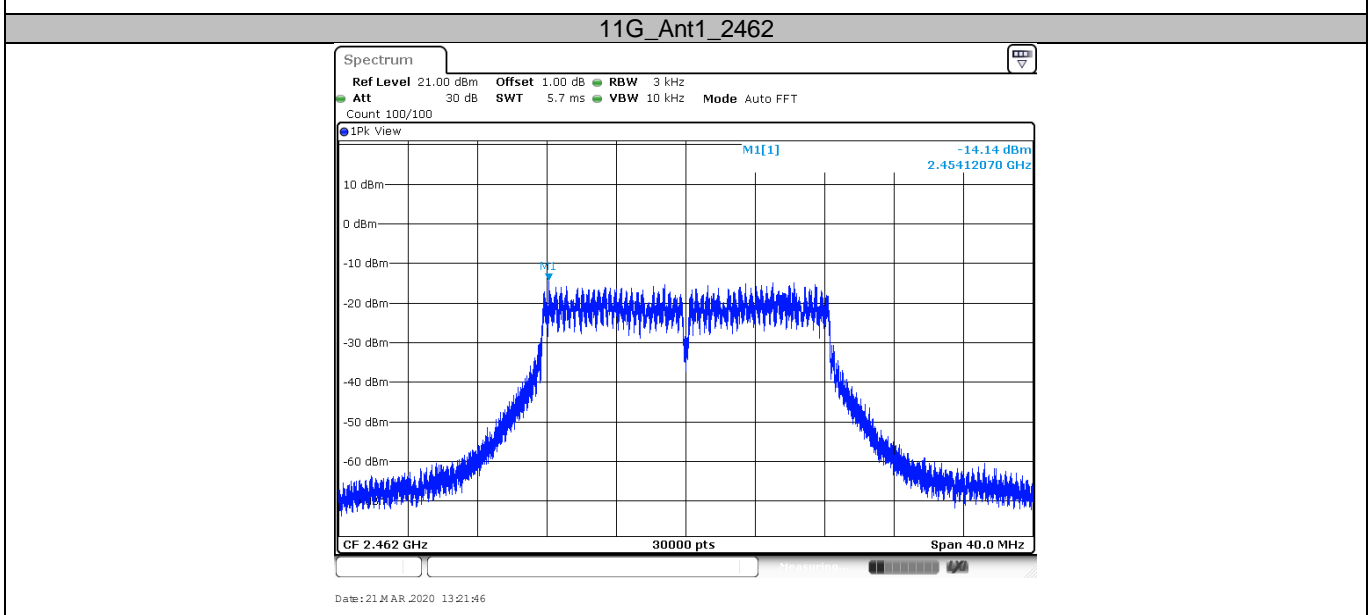
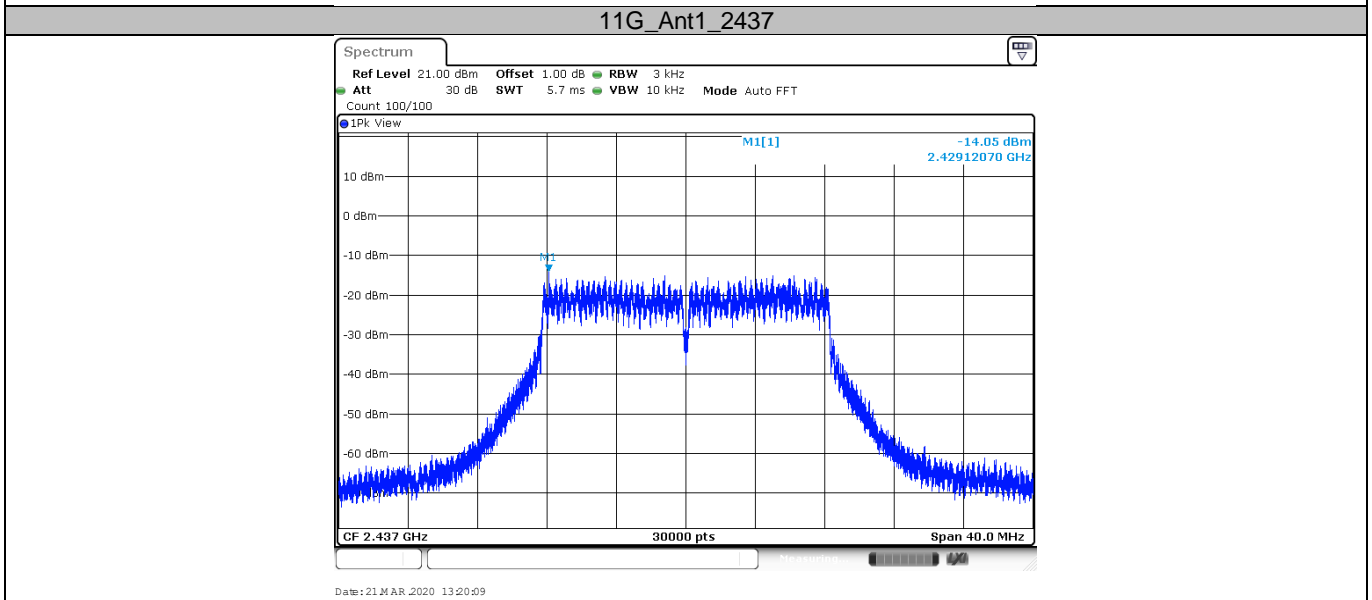
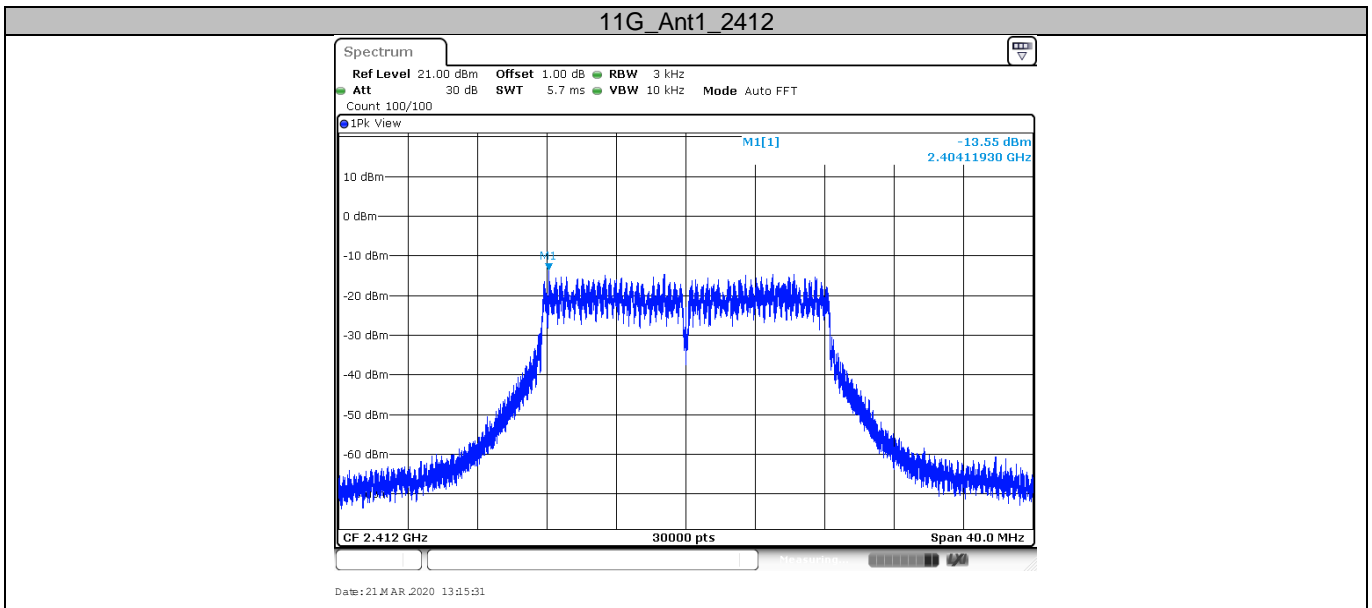

11N20SISO_Ant1_2412

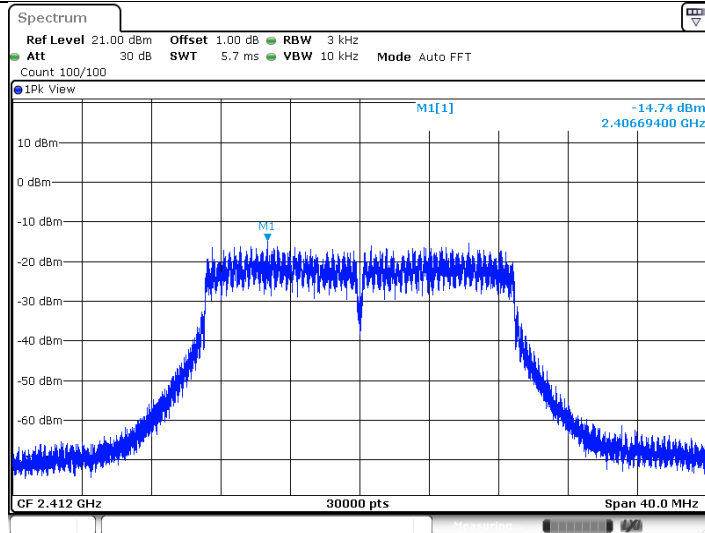

Date: 21 MAR 2020 13:25:55

11N20SISO_Ant1_2437

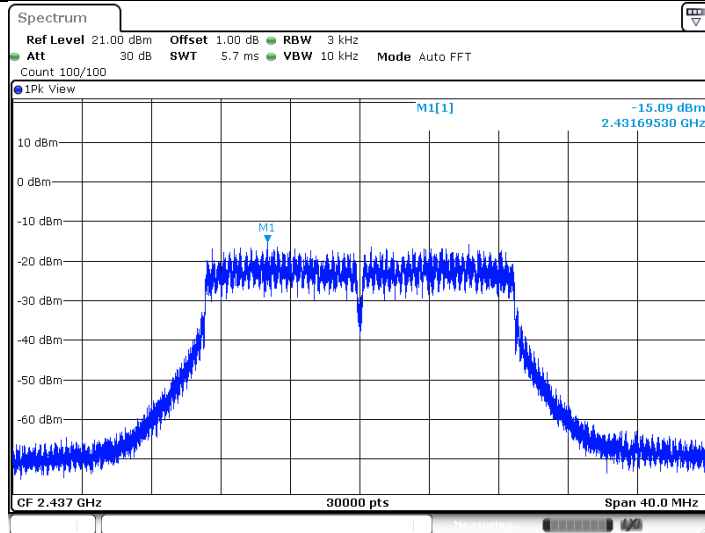

Date: 21 MAR 2020 13:29:19

11N20SISO_Ant1_2462

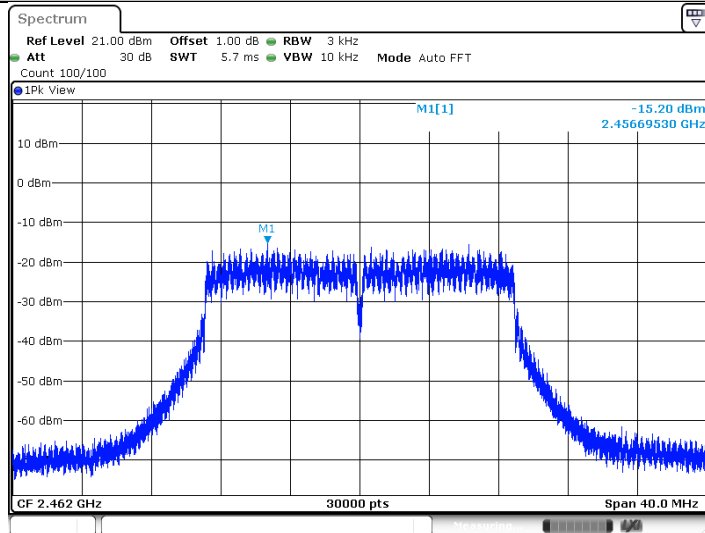

Date: 21 MAR 2020 13:31:09

11N40SISO_Ant1_2422

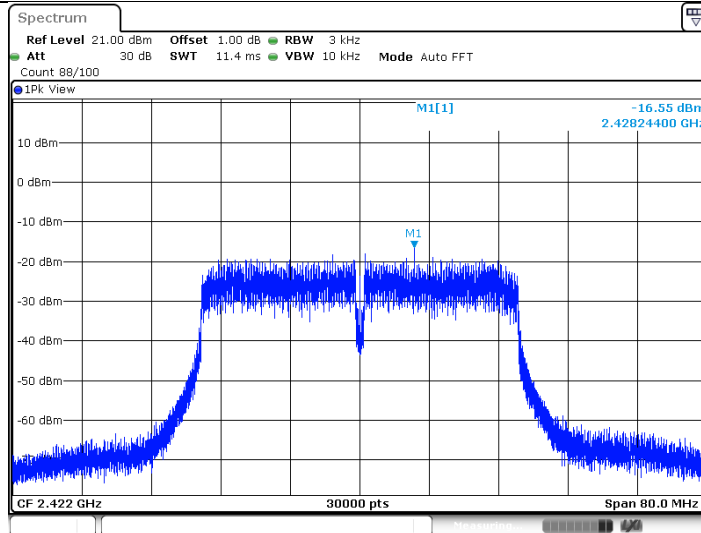

Date: 21 MAR 2020 13:46:34

11N40SISO_Ant1_2437

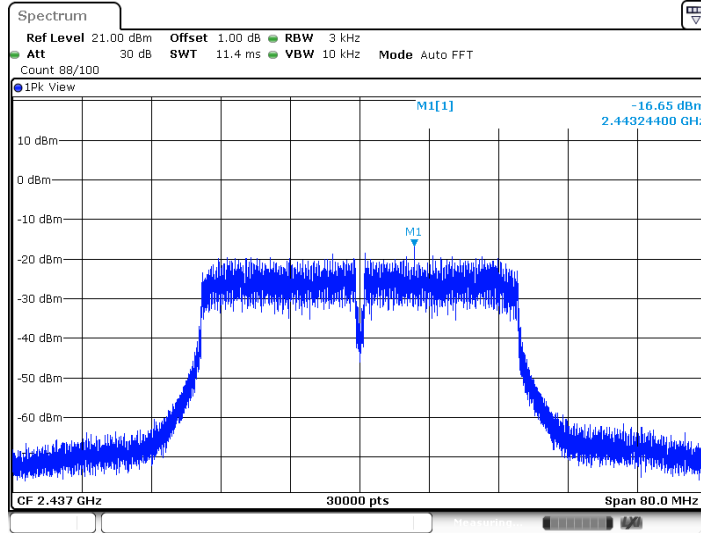

Date: 21 MAR 2020 13:49:16

11N40SISO_Ant1_2452

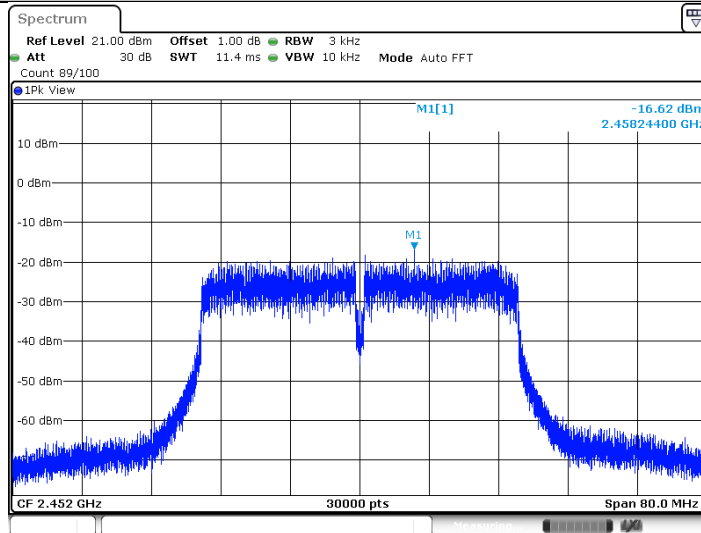

Date: 21 MAR 2020 13:51:34

9.5 Spurious RF conducted emissions

Test Method

1. Use the following spectrum analyzer settings:
Span = wide enough to capture the peak level of the in-band emission and all spurious emissions (e.g., harmonics) from the lowest frequency generated in the EUT up through the 10th harmonic. Typically, several plots are required to cover this entire span.
RBW = 100 kHz, VBW \geq RBW, Sweep = auto, Detector function = peak, Trace = max hold
2. Allow the trace to stabilize. Set the marker on the peak of any spurious emission recorded.
3. The level displayed must comply with the limit specified in this Section. Submit these plots.
4. Repeat above procedures until all frequencies measured were complete.

Limit

Frequency Range MHz	Limit (dBc)
30-25000	-20

Spurious RF conducted emissions

TestMode	Antenna	Channel (MHz)	FreqRange (MHz)	RefLevel (MHz)	Result (dBm)	Limit (dBm)	Verdict
11B	Ant1	2412	Reference	4.10	4.10	---	PASS
		2412	30~1000	30~1000	-67.88	<=-15.9	PASS
		2412	1000~26500	1000~26500	-49.77	<=-15.9	PASS
		2437	Reference	3.73	3.73	---	PASS
		2437	30~1000	30~1000	-67.31	<=-16.27	PASS
		2437	1000~26500	1000~26500	-49.09	<=-16.27	PASS
		2462	Reference	3.61	3.61	---	PASS
		2462	30~1000	30~1000	-67.48	<=-16.39	PASS
11G	Ant1	2412	Reference	0.13	0.13	---	PASS
		2412	30~1000	30~1000	-67.11	<=-19.87	PASS
		2412	1000~26500	1000~26500	-51.92	<=-19.87	PASS
		2437	Reference	-0.30	-0.30	---	PASS
		2437	30~1000	30~1000	-66.92	<=-20.3	PASS
		2437	1000~26500	1000~26500	-51.85	<=-20.3	PASS
		2462	Reference	-0.20	-0.20	---	PASS
		2462	30~1000	30~1000	-67.49	<=-20.2	PASS
11N20SISO	Ant1	2412	Reference	-2.44	-2.44	---	PASS
		2412	30~1000	30~1000	-67.89	<=-22.44	PASS
		2412	1000~26500	1000~26500	-52.63	<=-22.44	PASS
		2437	Reference	-1.10	-1.10	---	PASS
		2437	30~1000	30~1000	-68.43	<=-21.1	PASS
		2437	1000~26500	1000~26500	-51.22	<=-21.1	PASS
		2462	Reference	-1.64	-1.64	---	PASS
		2462	30~1000	30~1000	-68.35	<=-21.64	PASS
11N40SISO	Ant1	2422	Reference	-3.93	-3.93	---	PASS
		2422	30~1000	30~1000	-67.51	<=-23.93	PASS
		2422	1000~26500	1000~26500	-52.5	<=-23.93	PASS
		2437	Reference	-4.10	-4.10	---	PASS
		2437	30~1000	30~1000	-68.14	<=-24.1	PASS
		2437	1000~26500	1000~26500	-51.87	<=-24.1	PASS
		2452	Reference	-3.89	-3.89	---	PASS
		2452	30~1000	30~1000	-65.8	<=-23.89	PASS
2452	1000~26500	1000~26500	-52.3	<=-23.89	PASS		

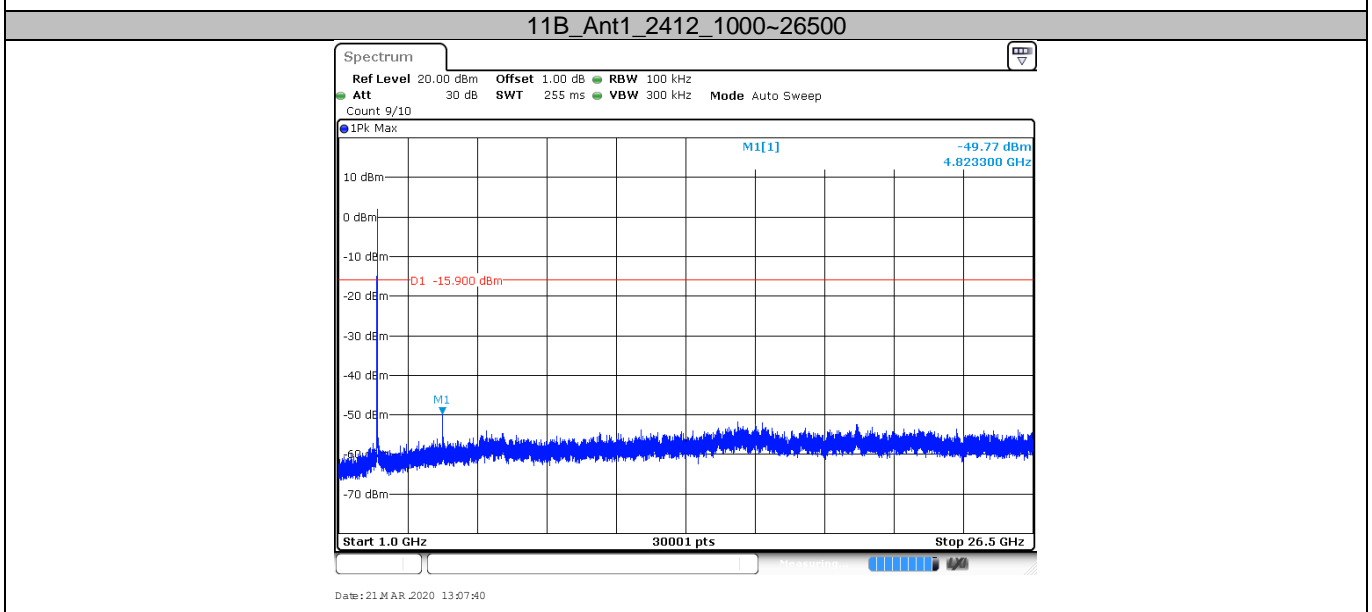
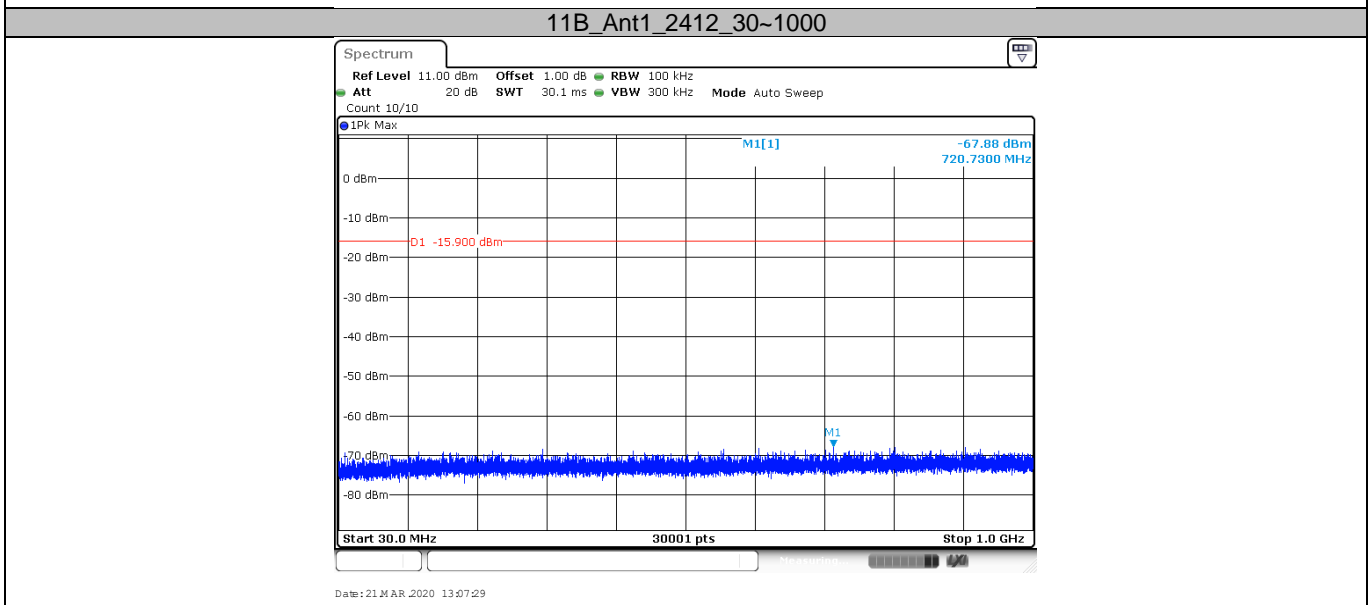
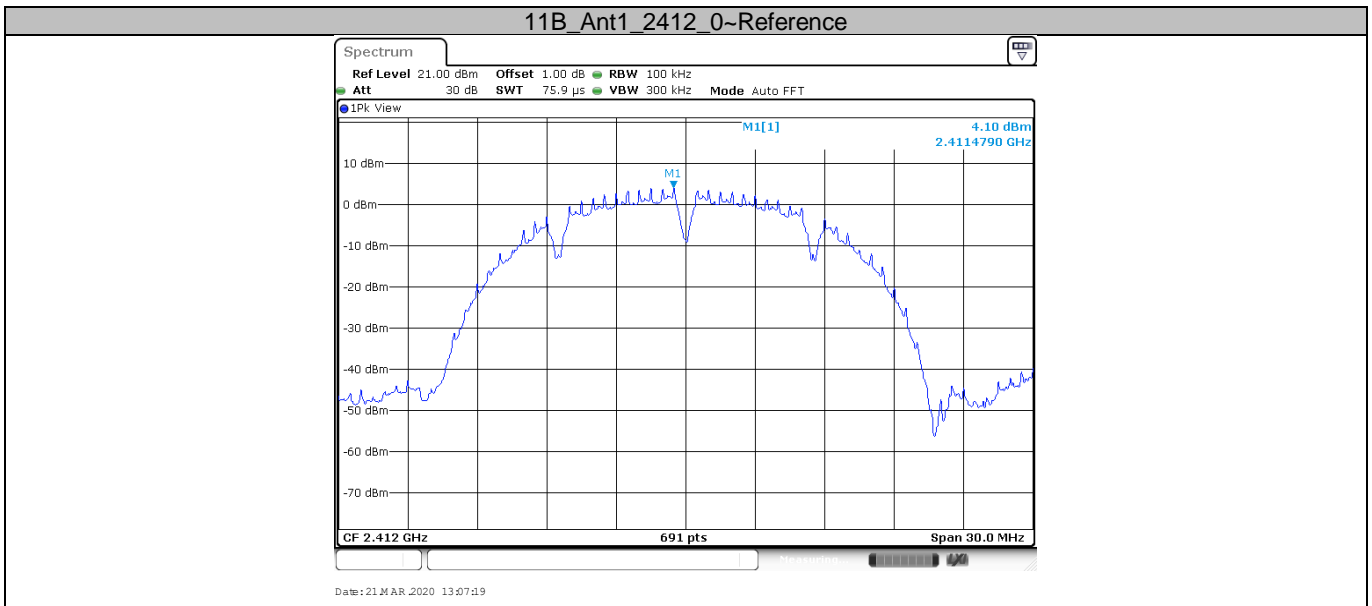

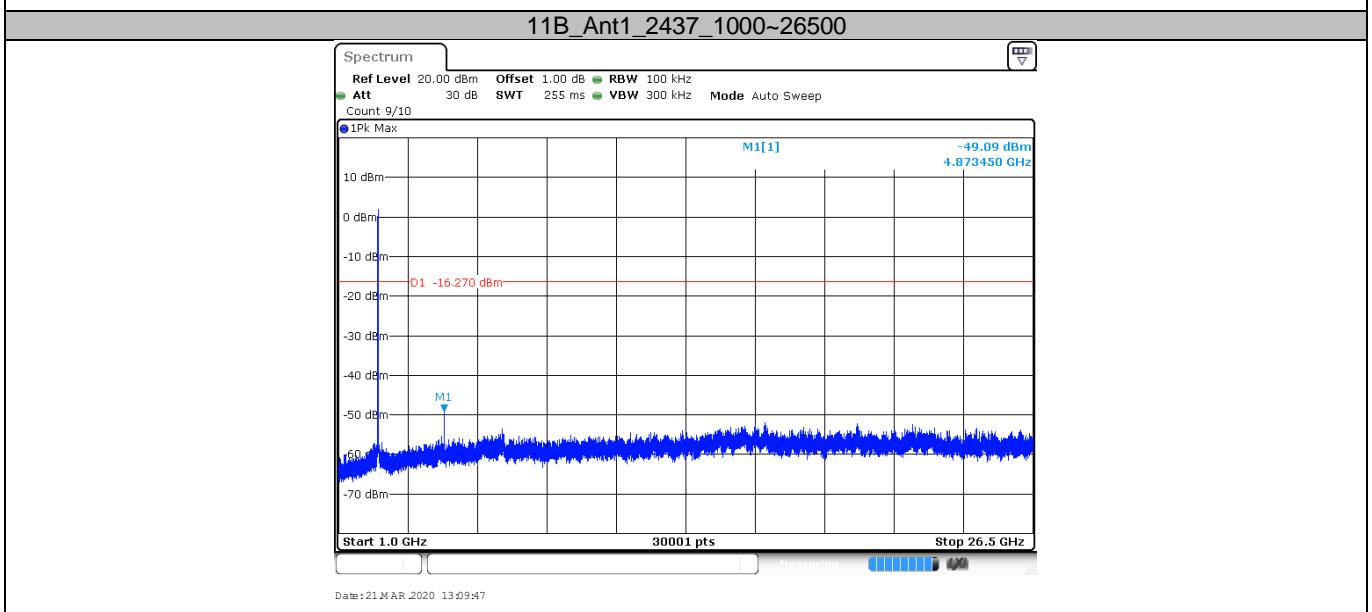
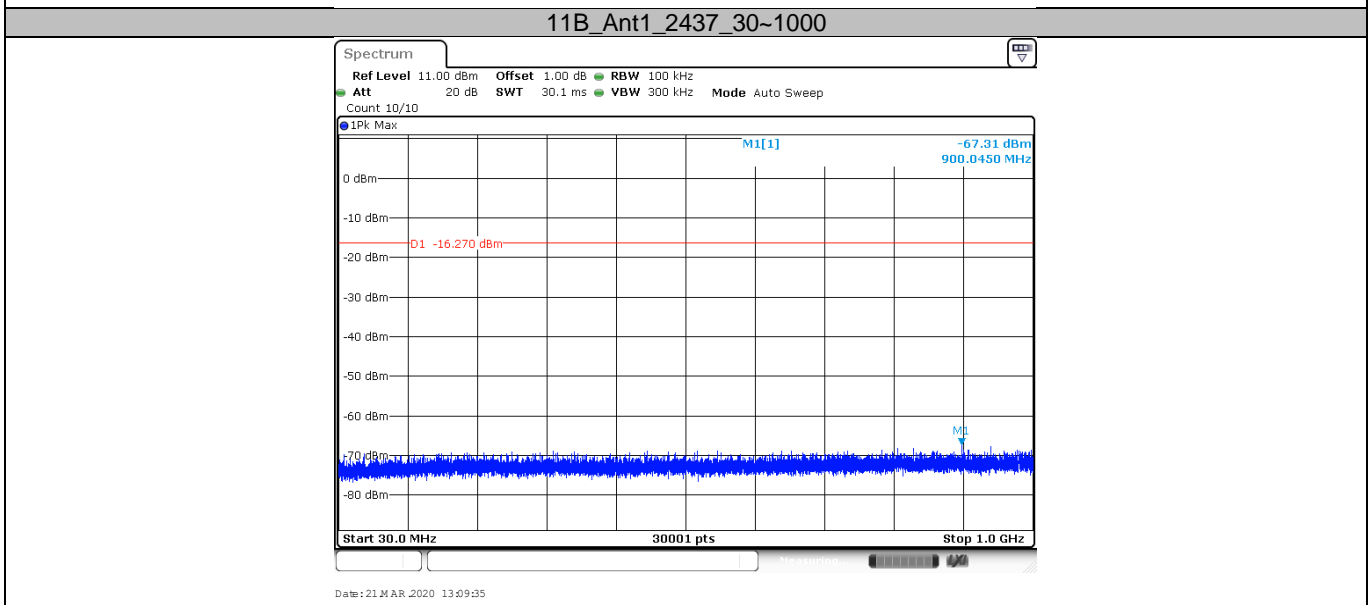
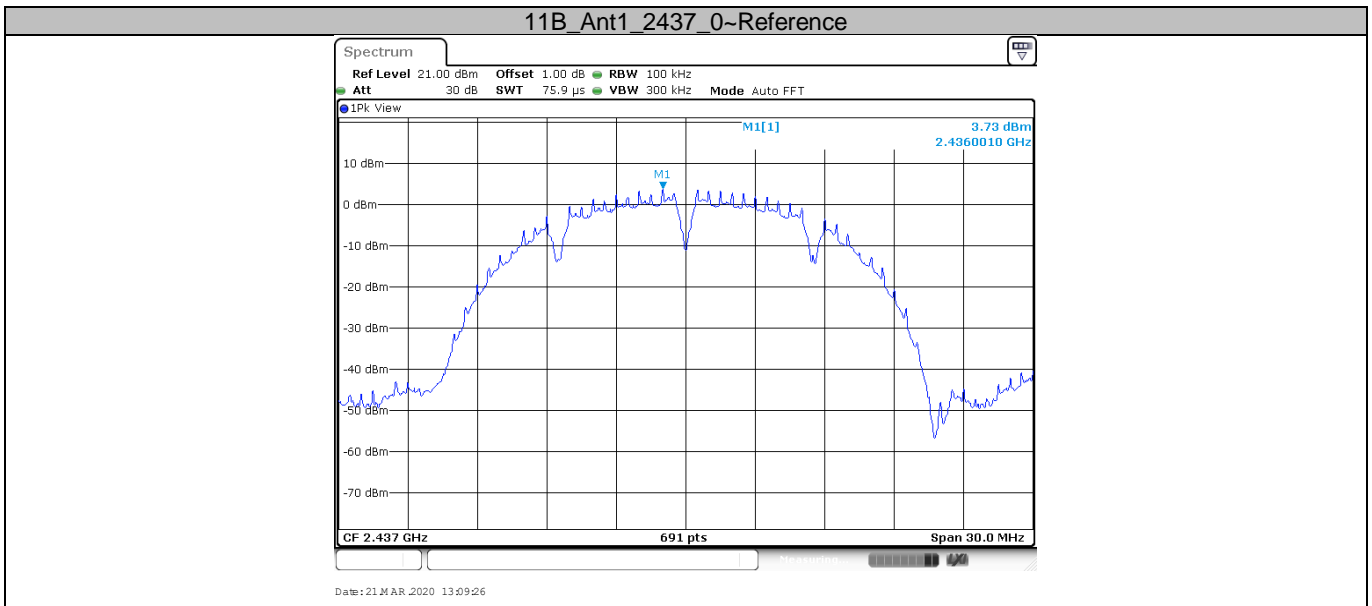

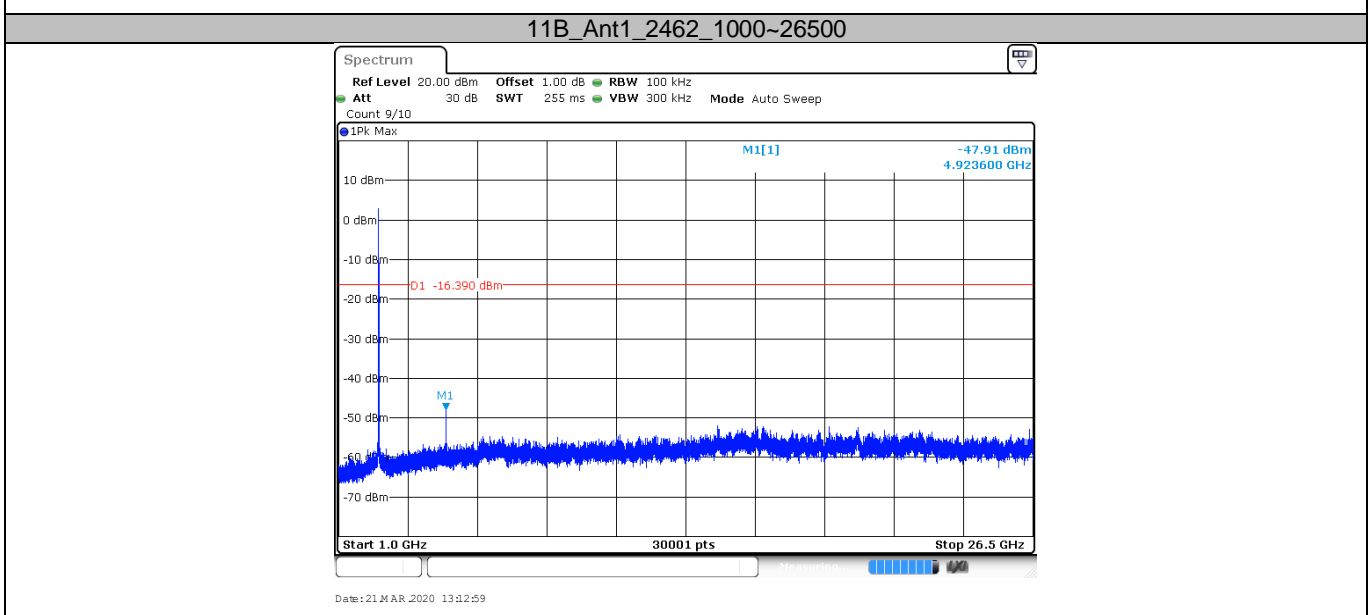
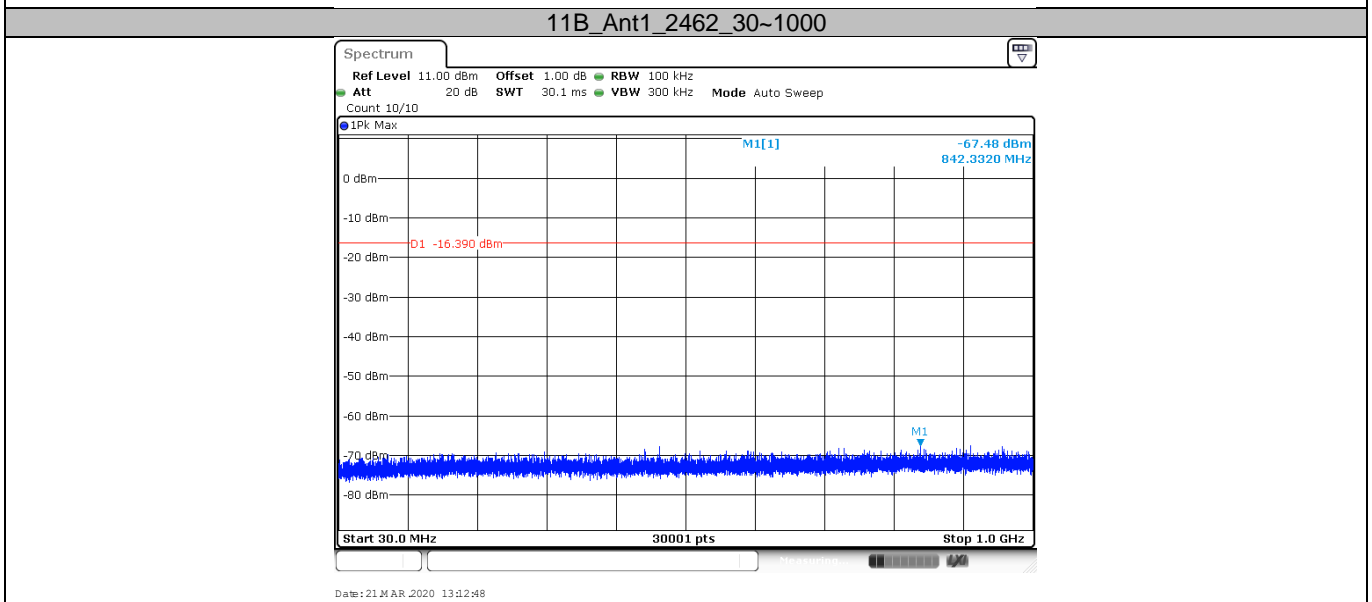
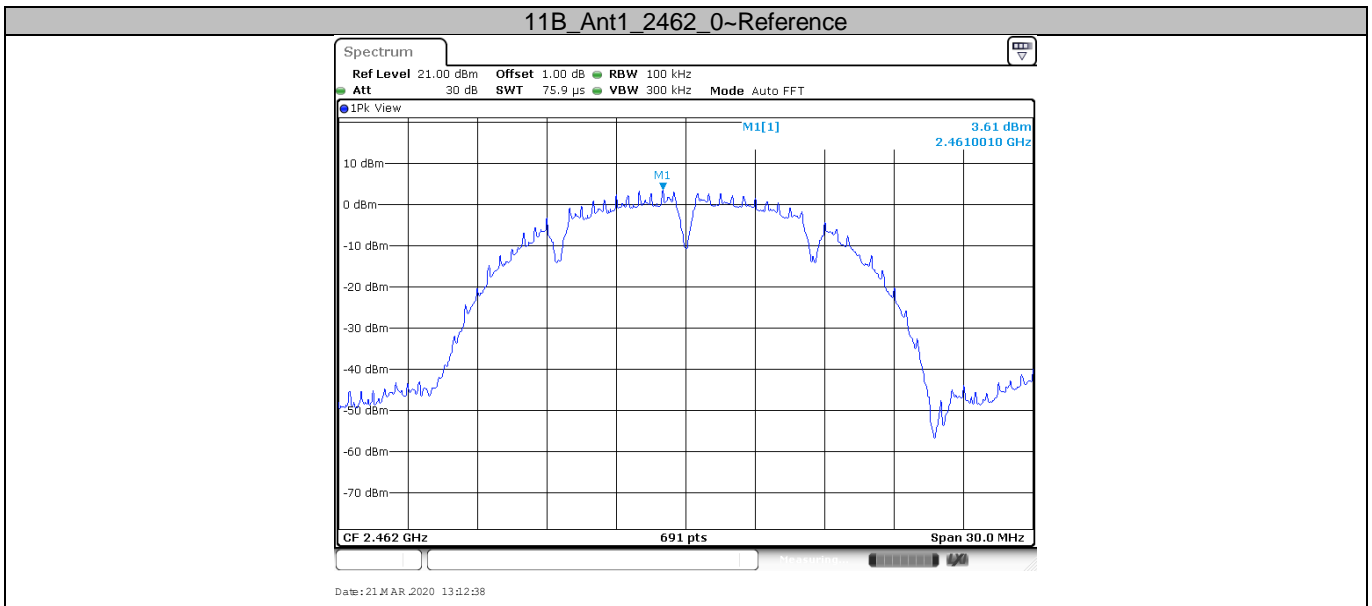

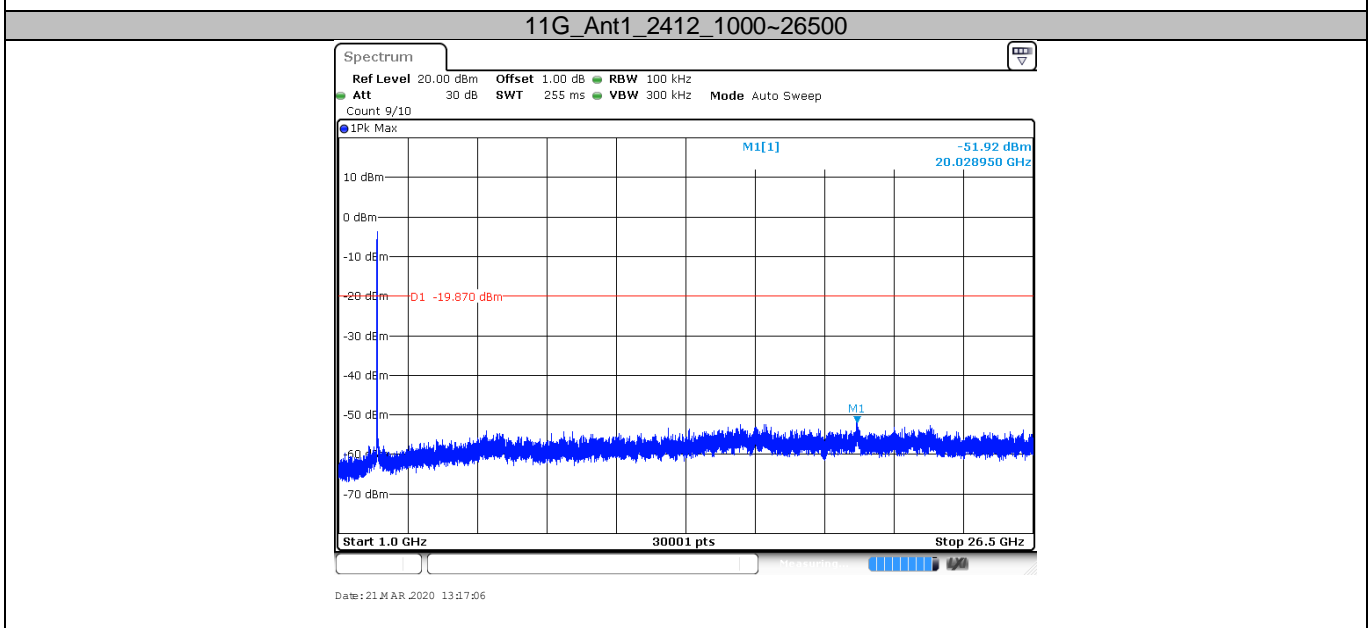
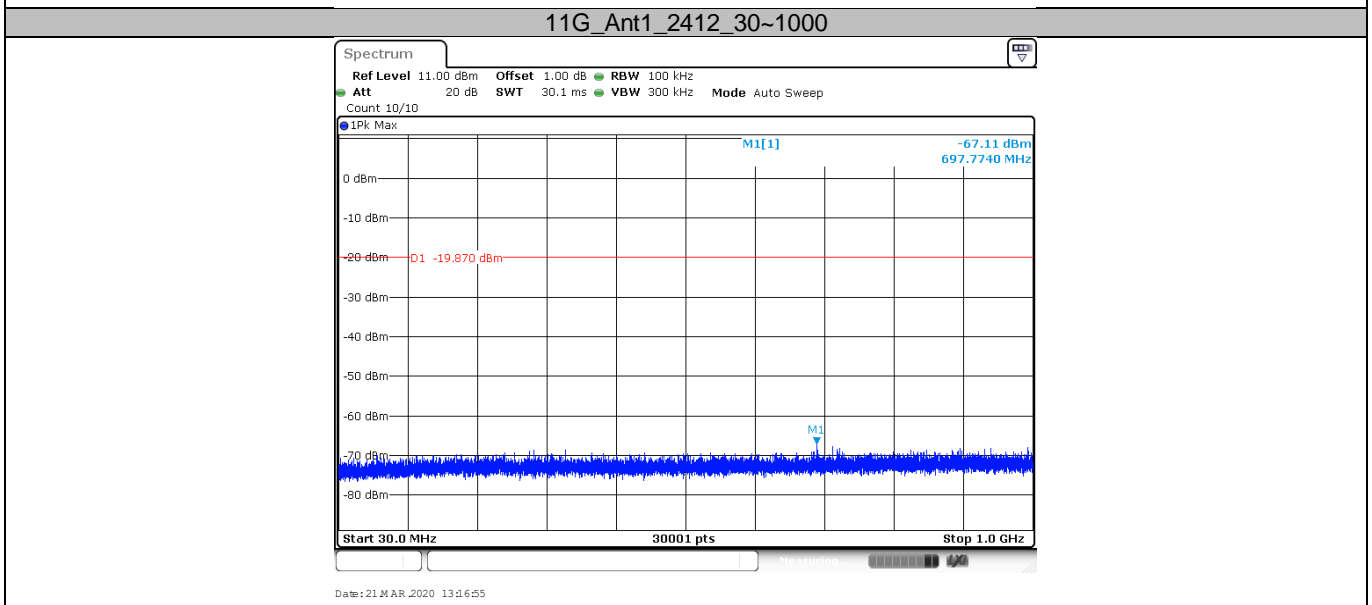
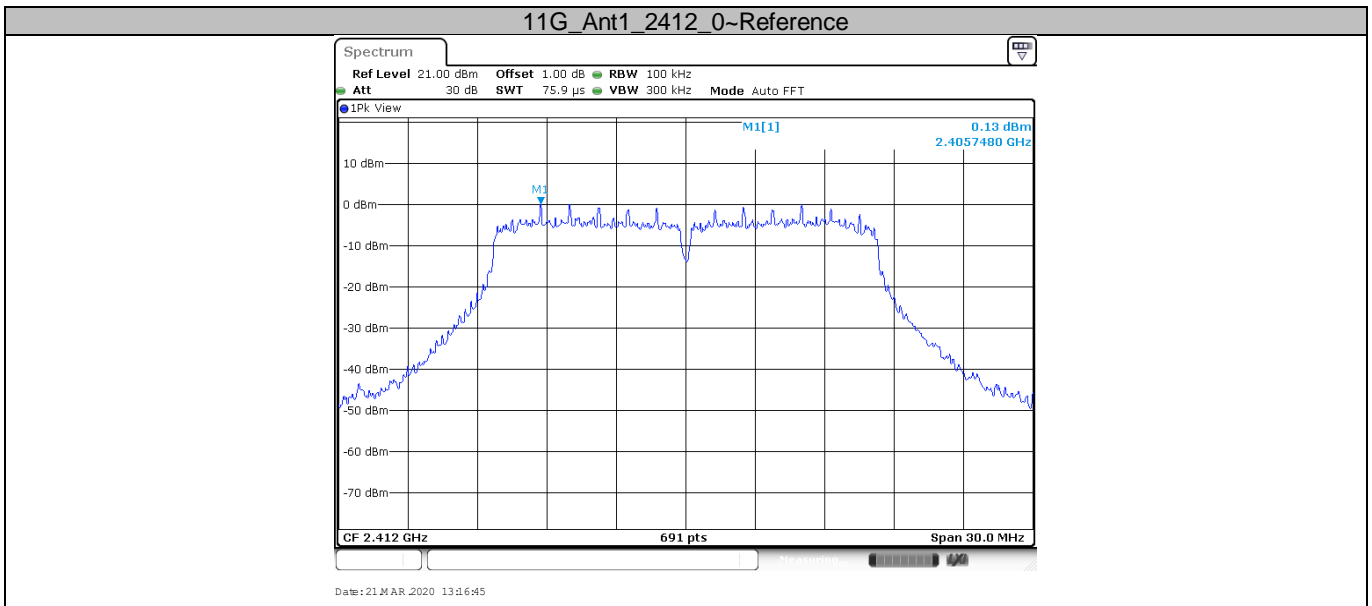

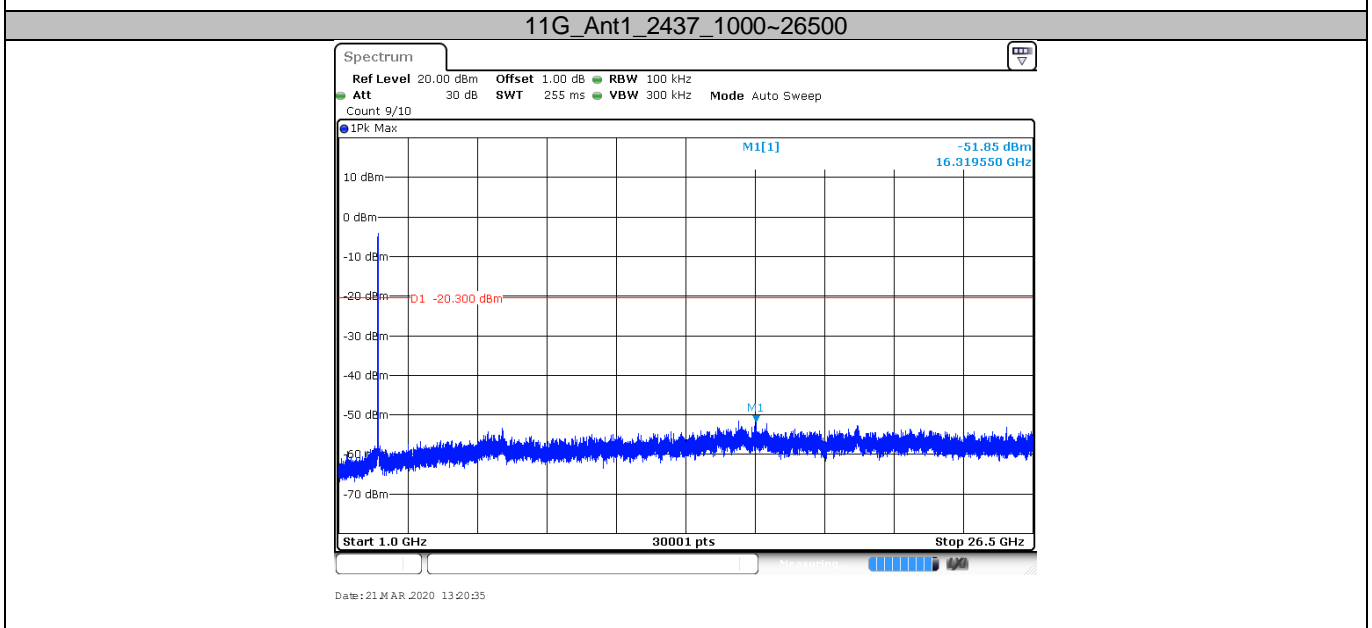
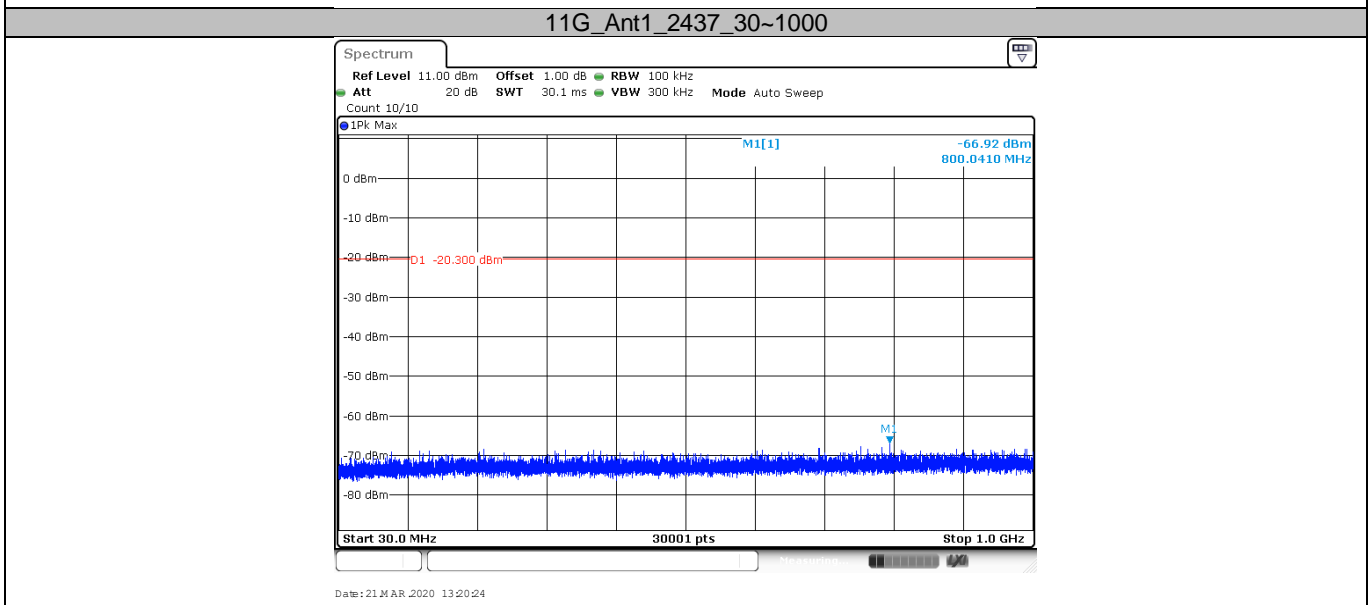
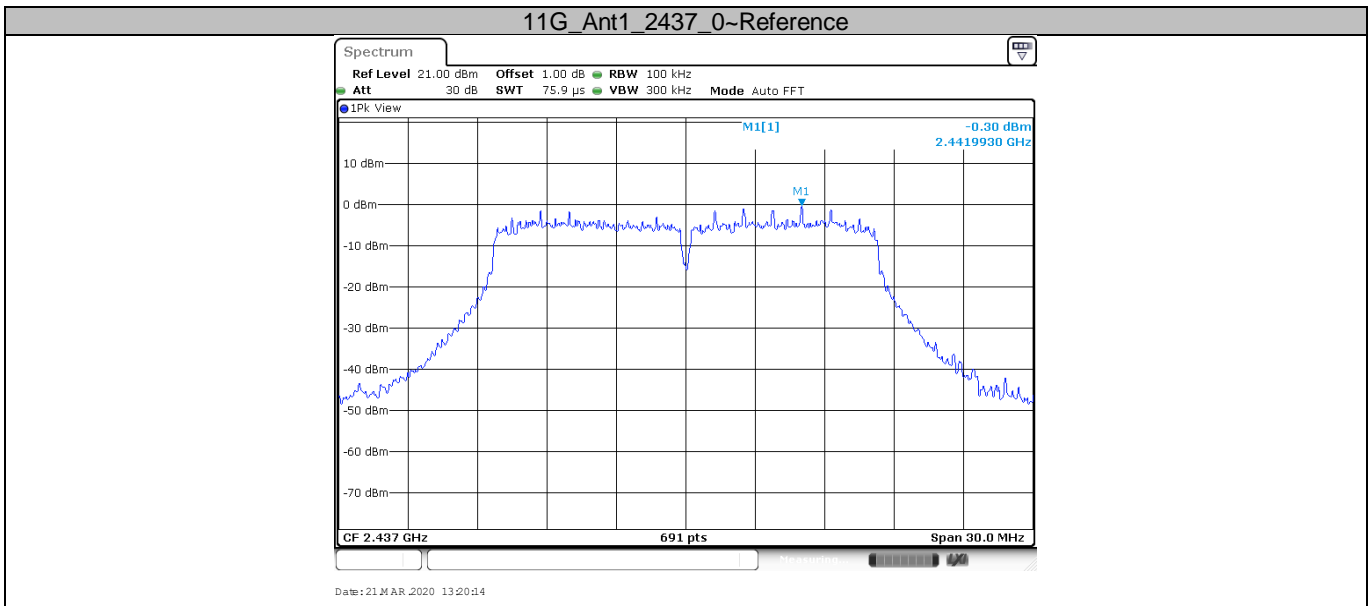

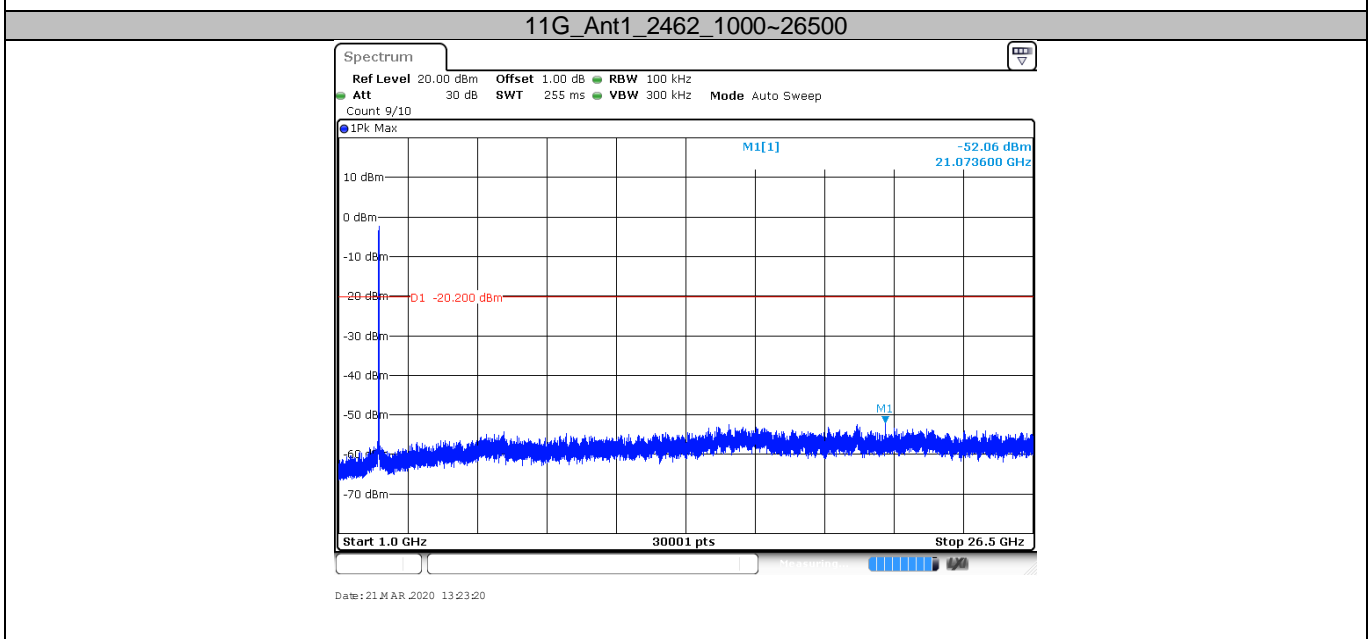
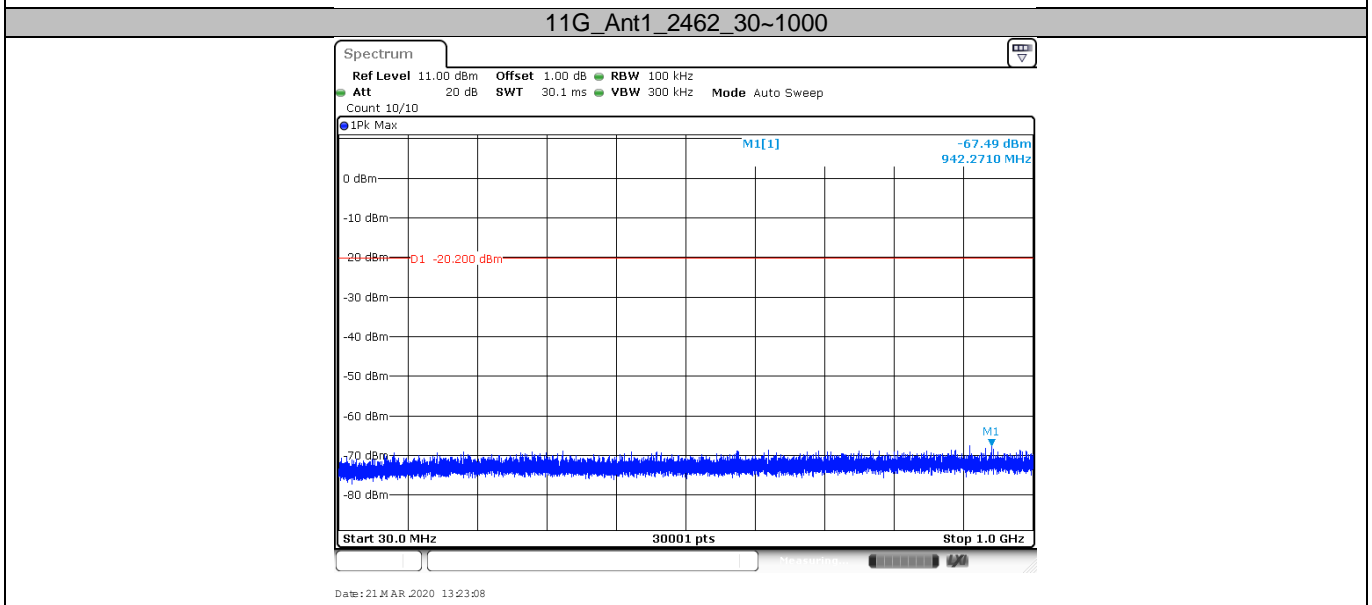
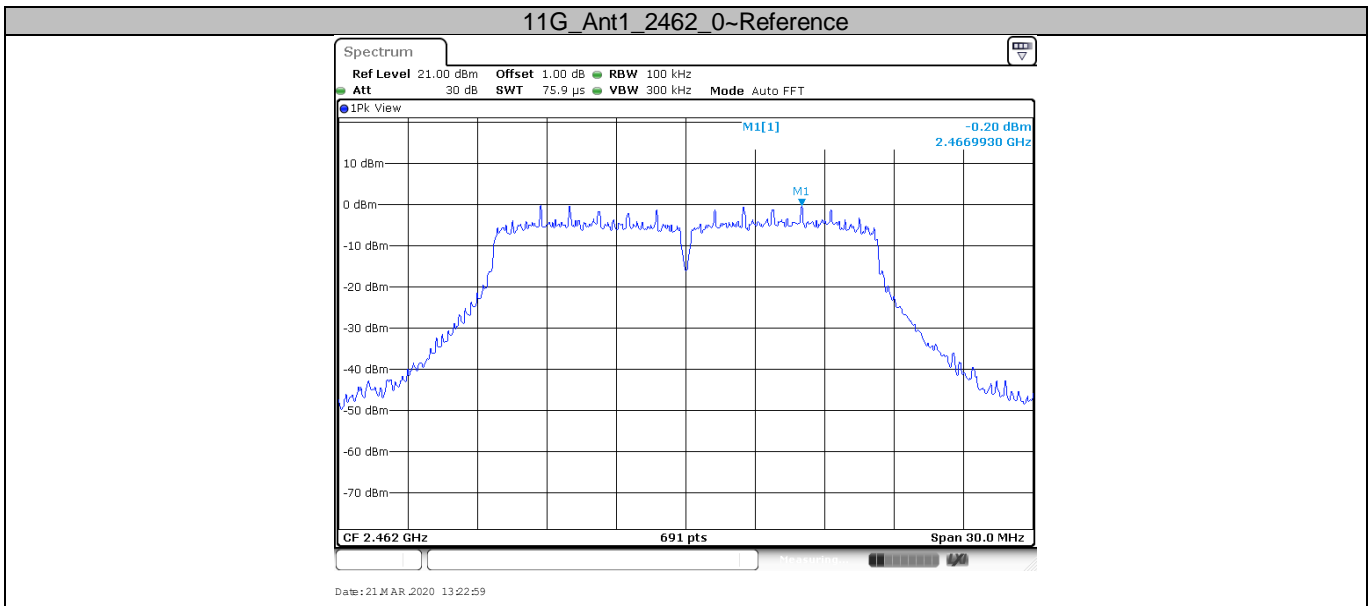

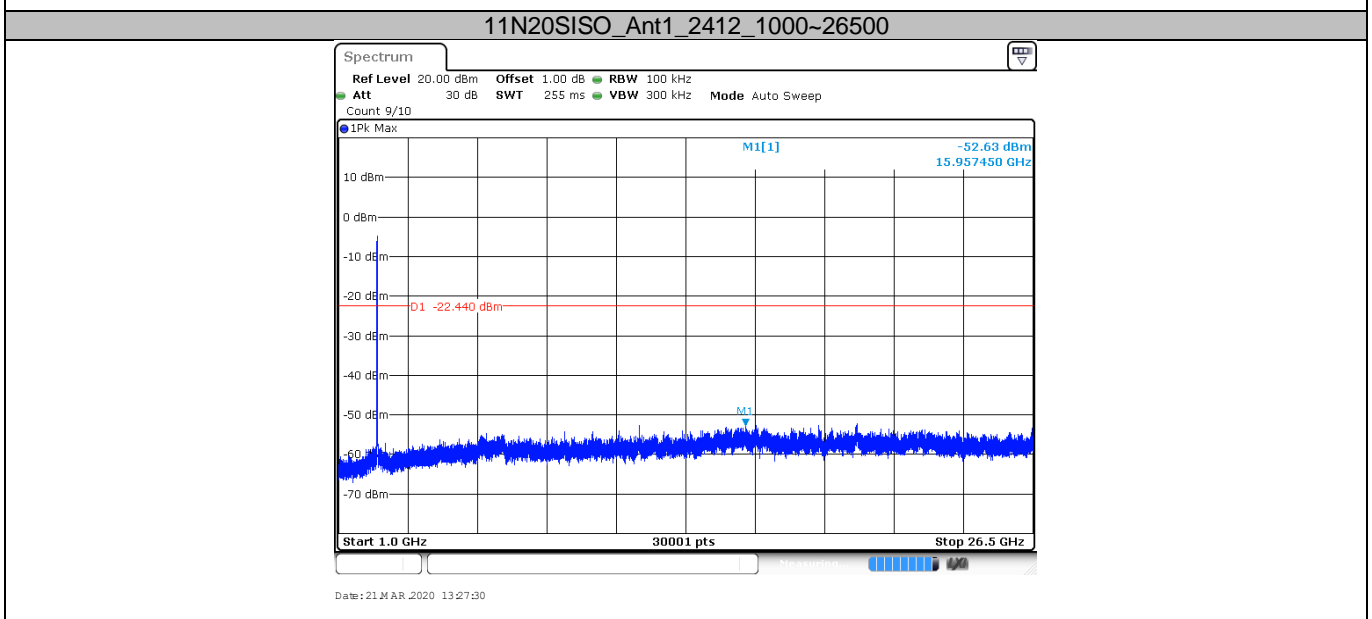
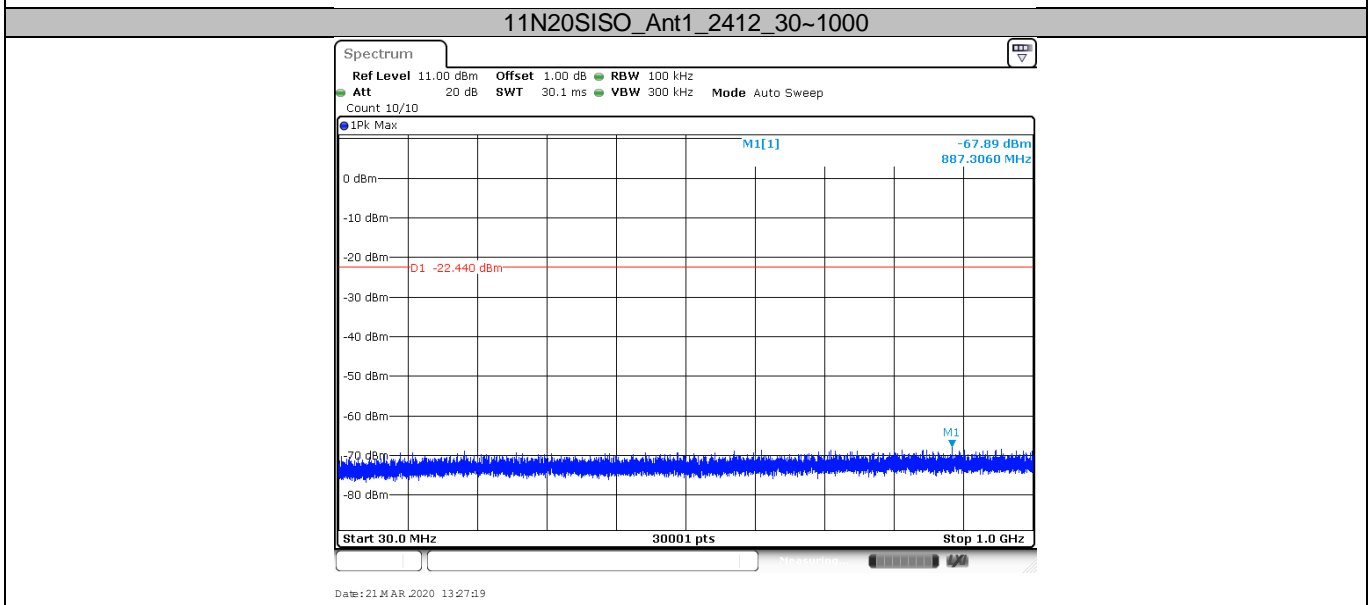
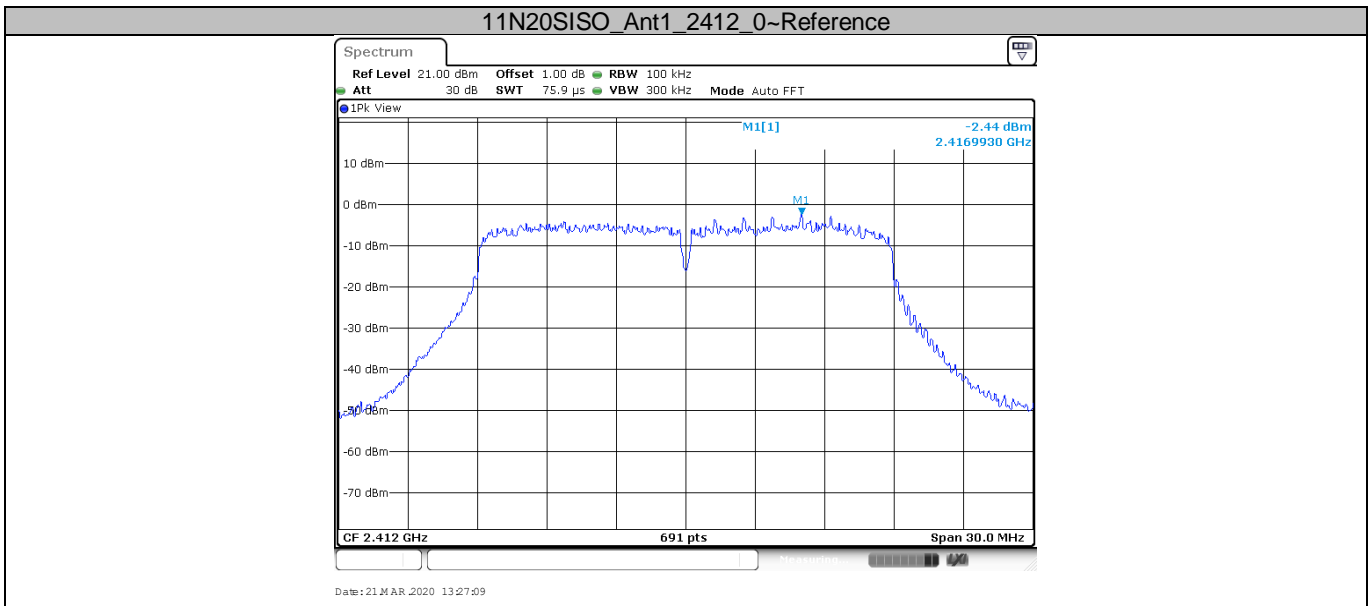

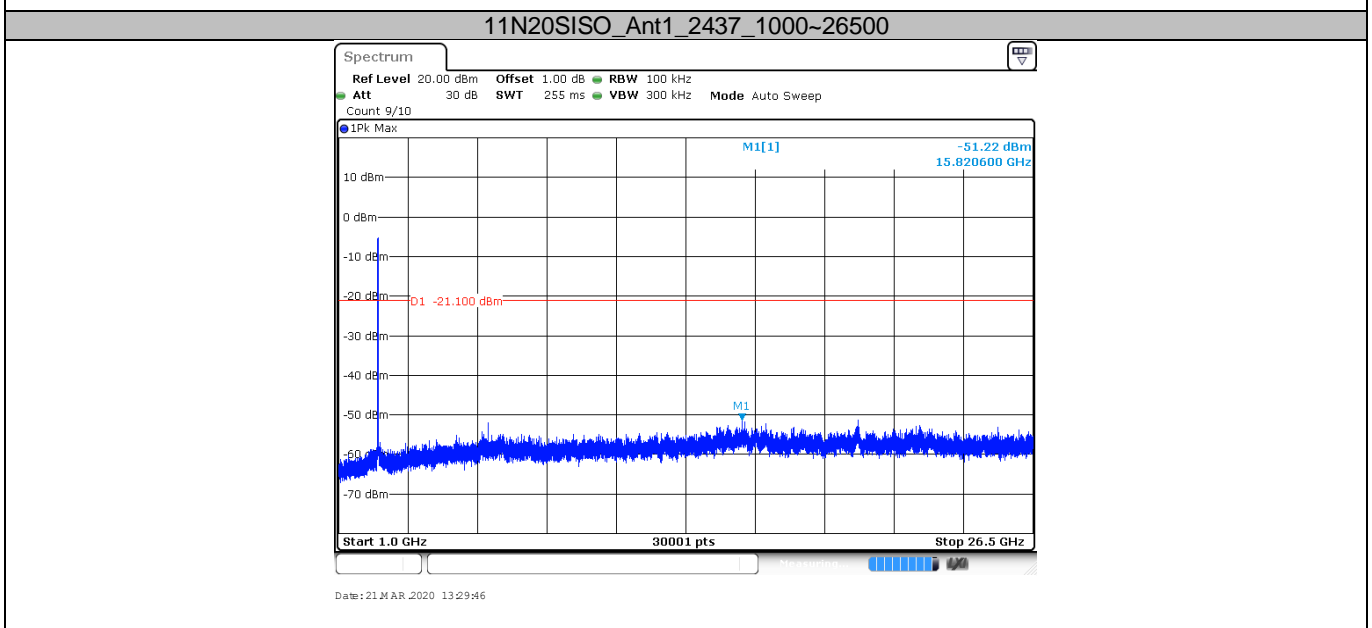
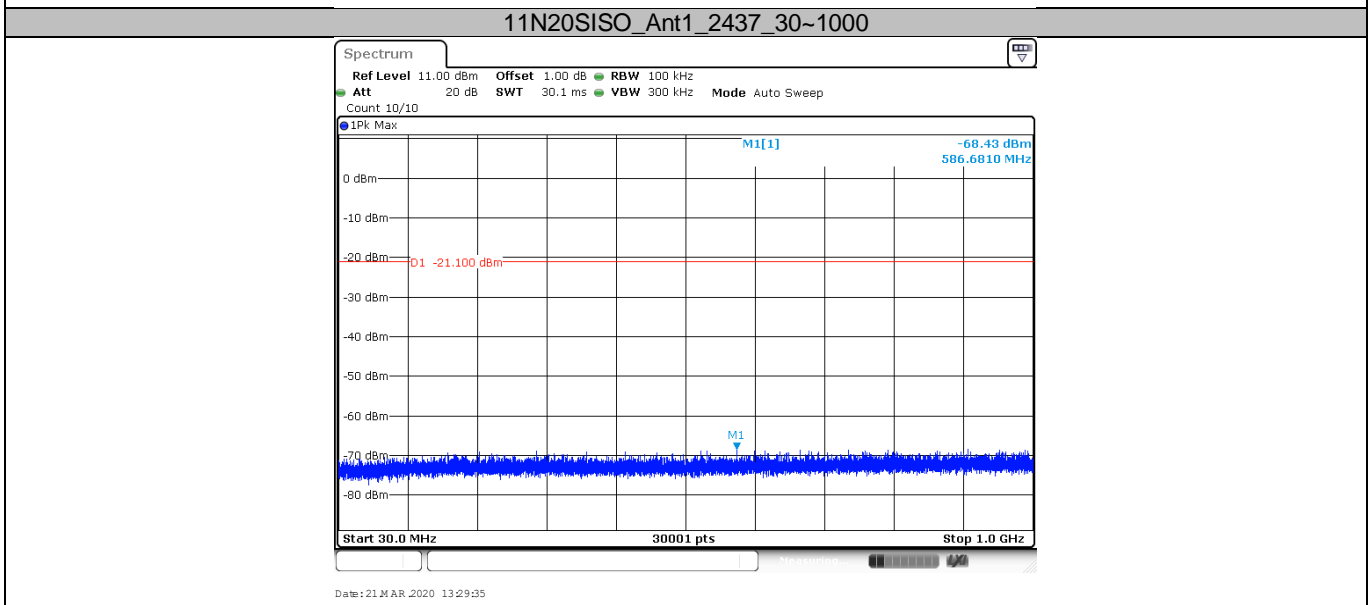
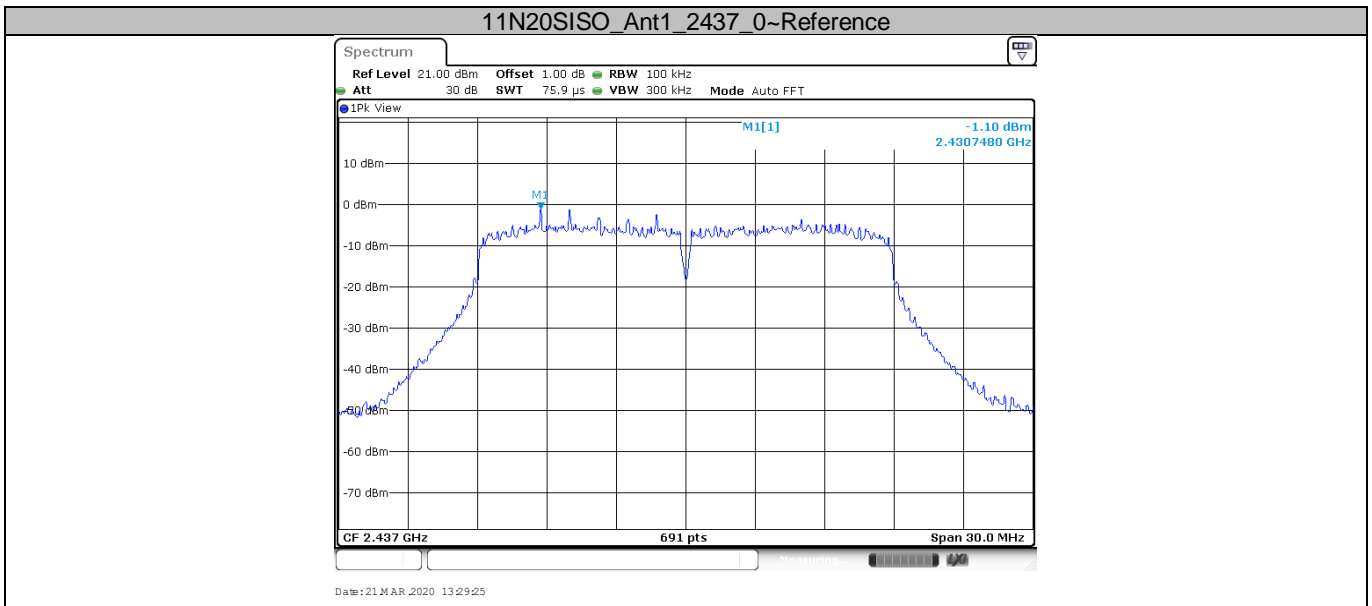

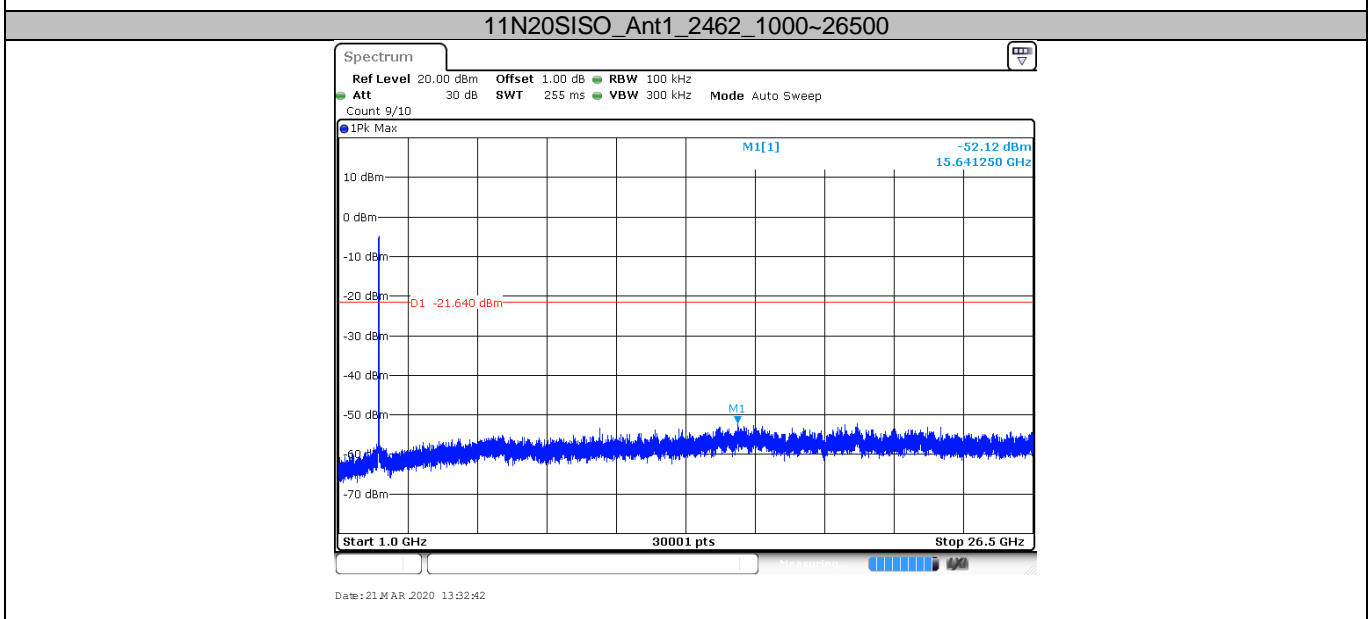
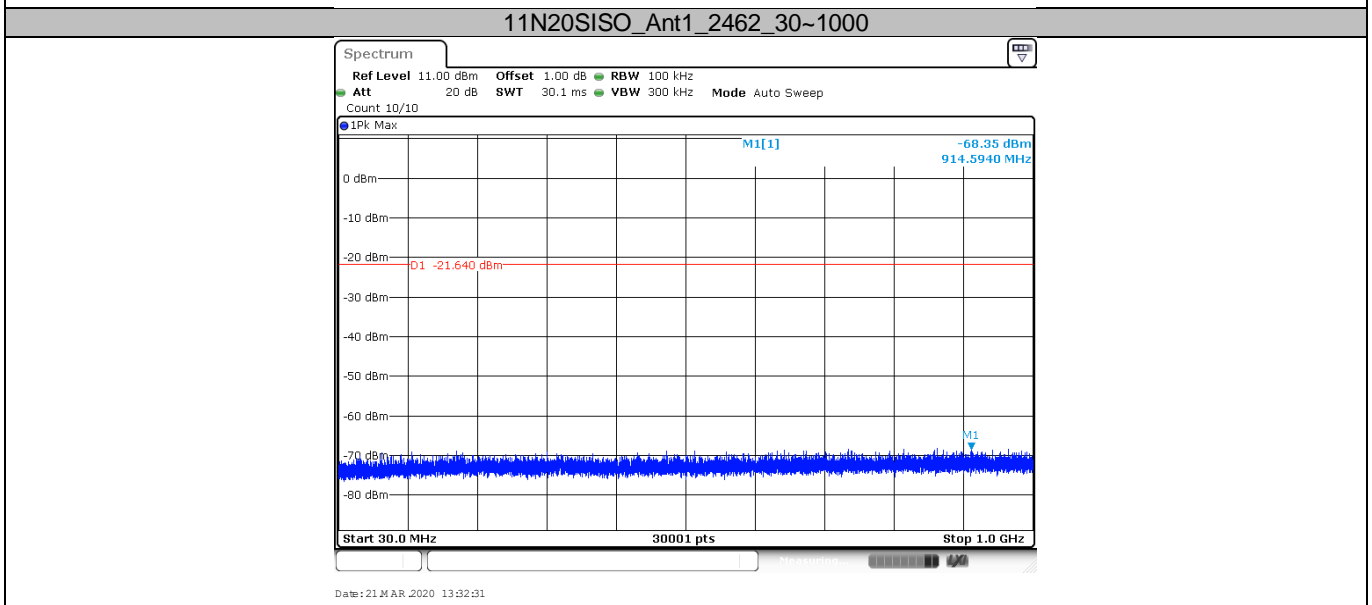
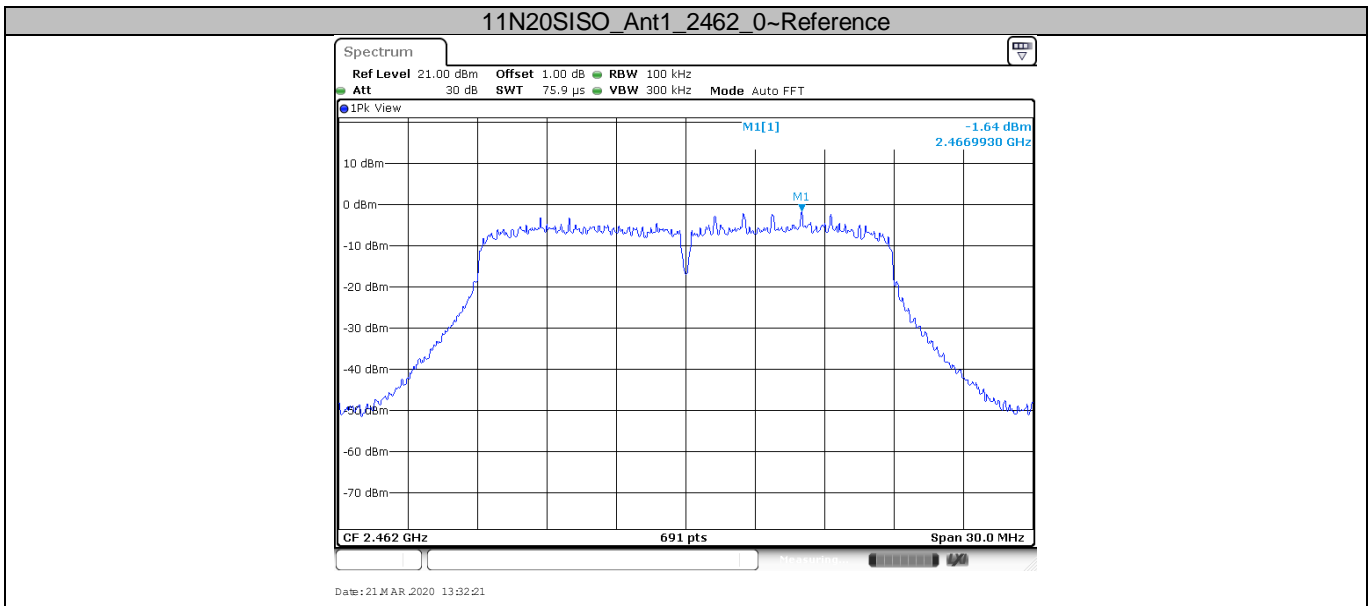

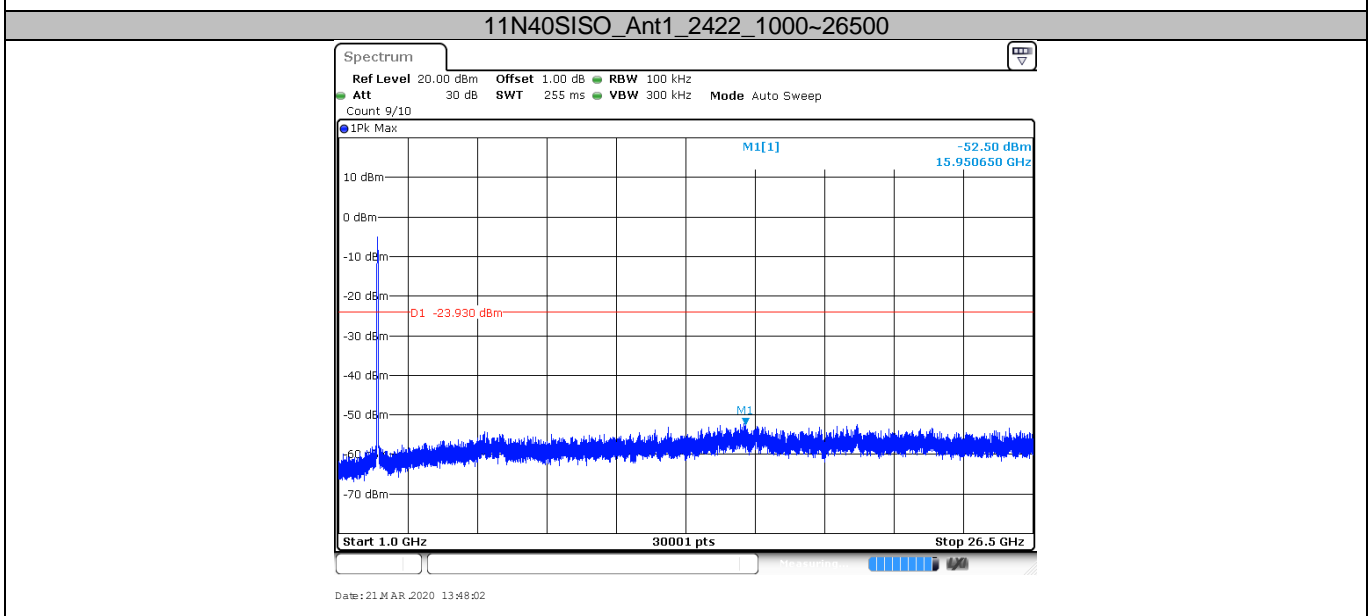
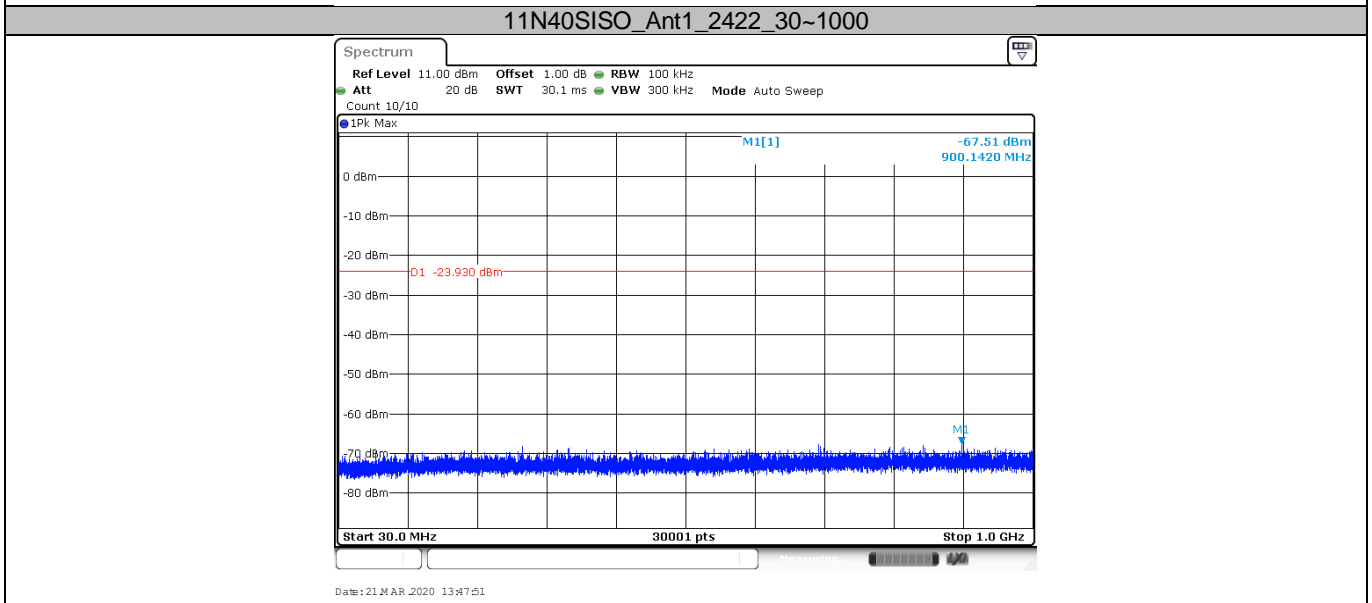
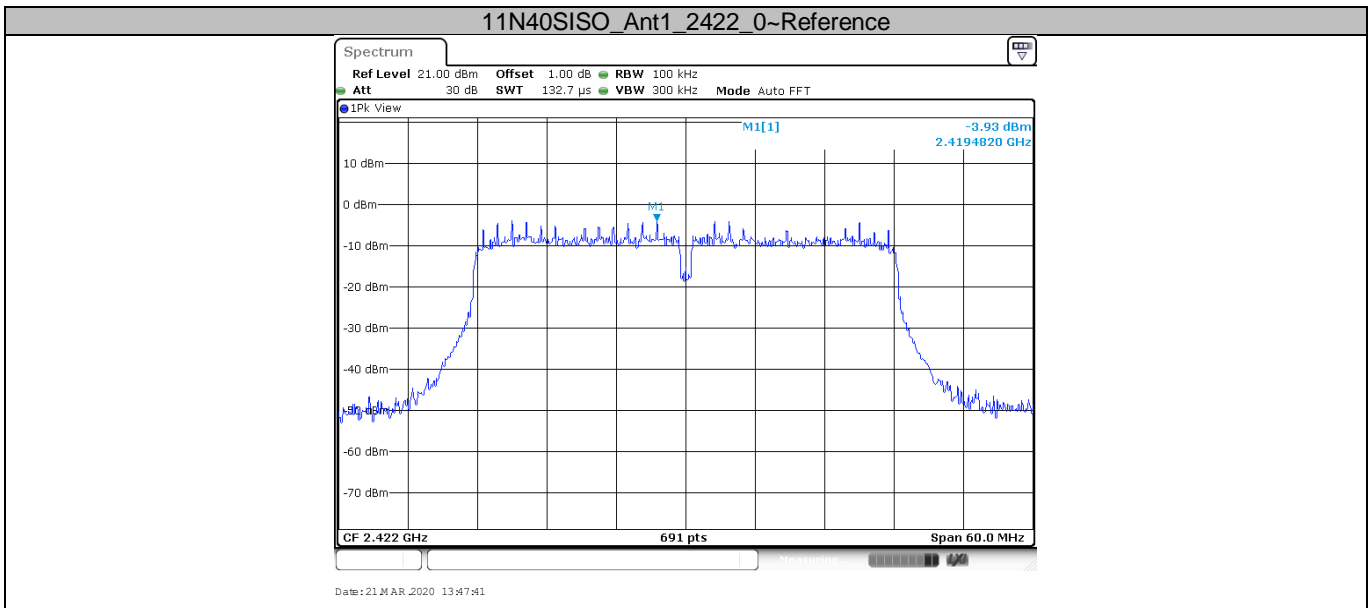

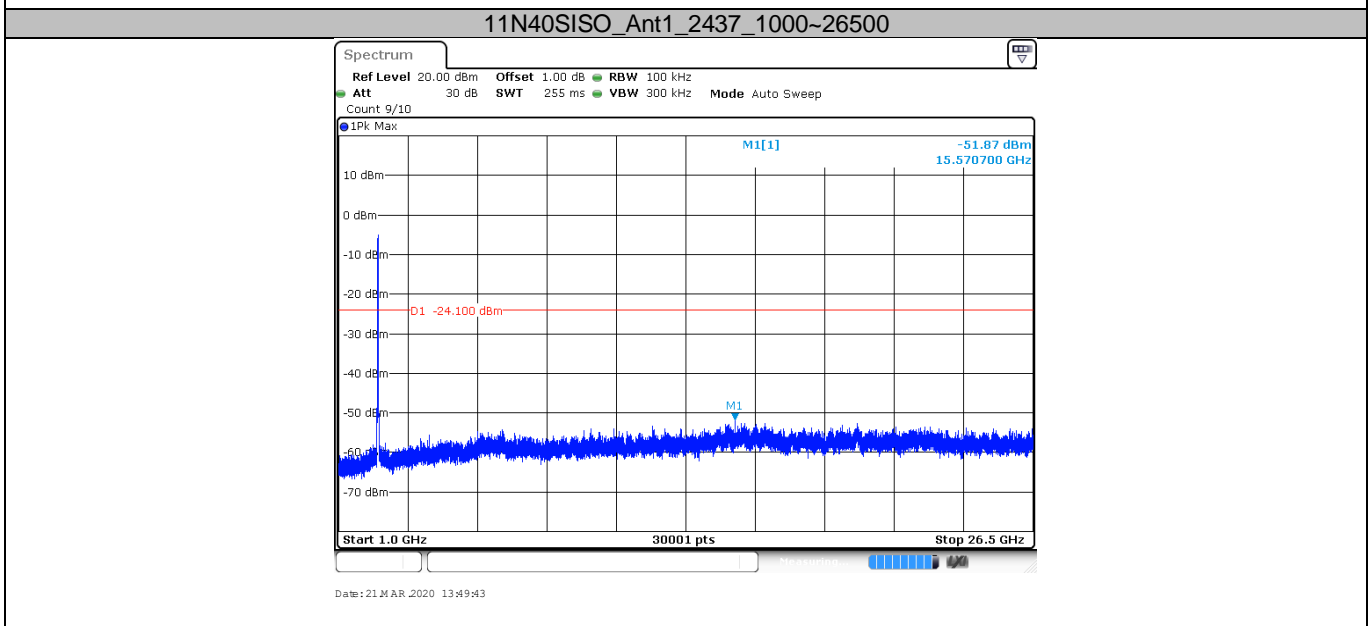
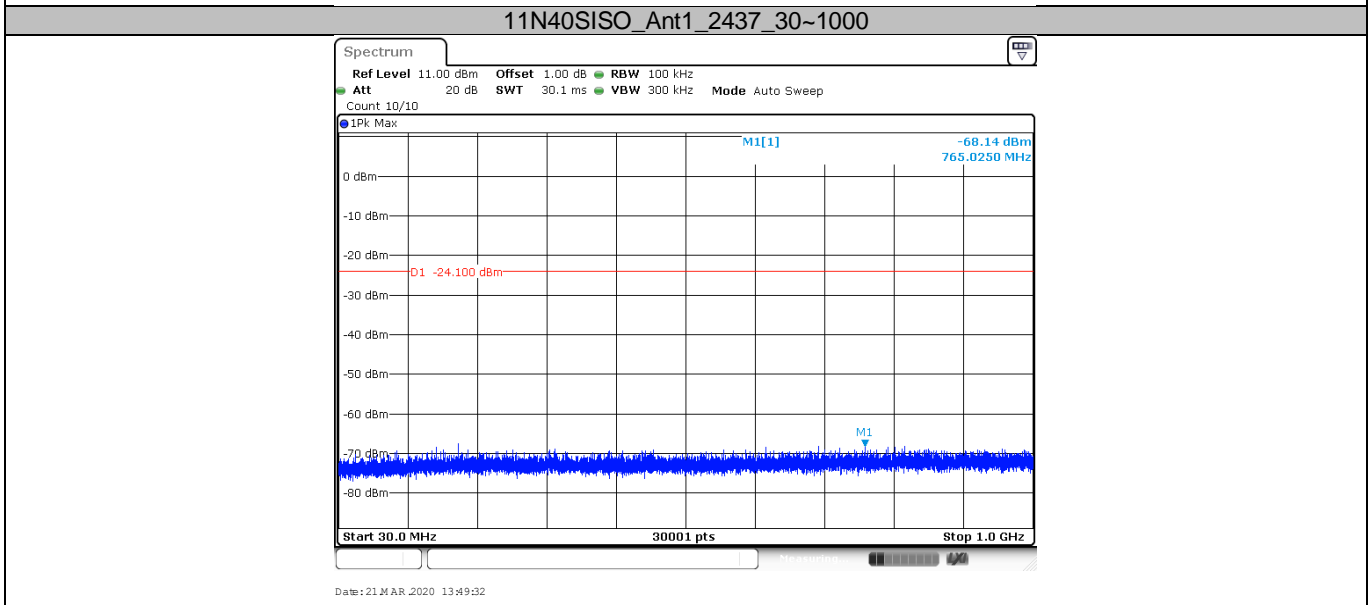
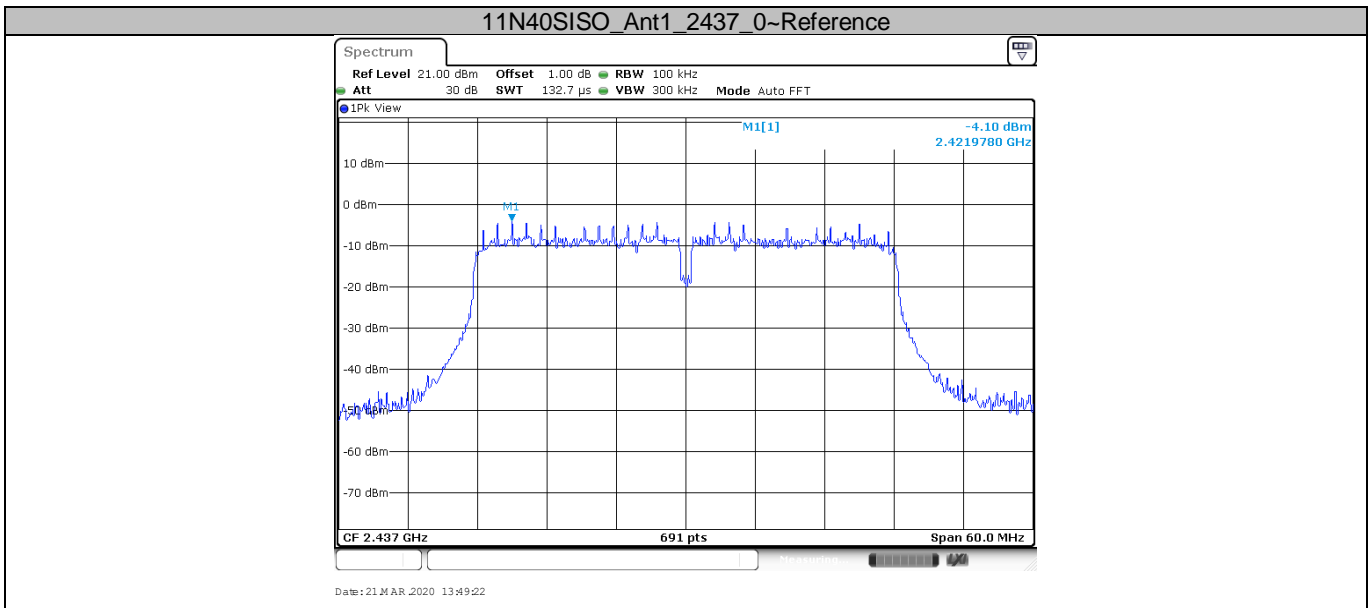

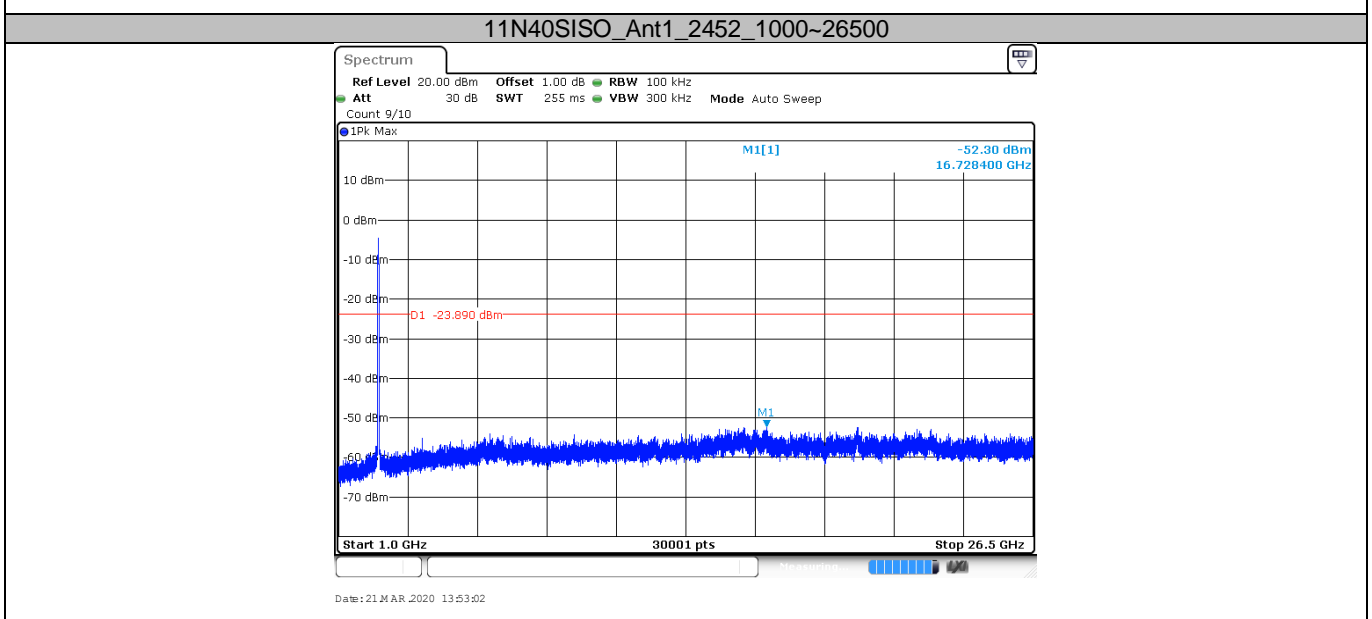
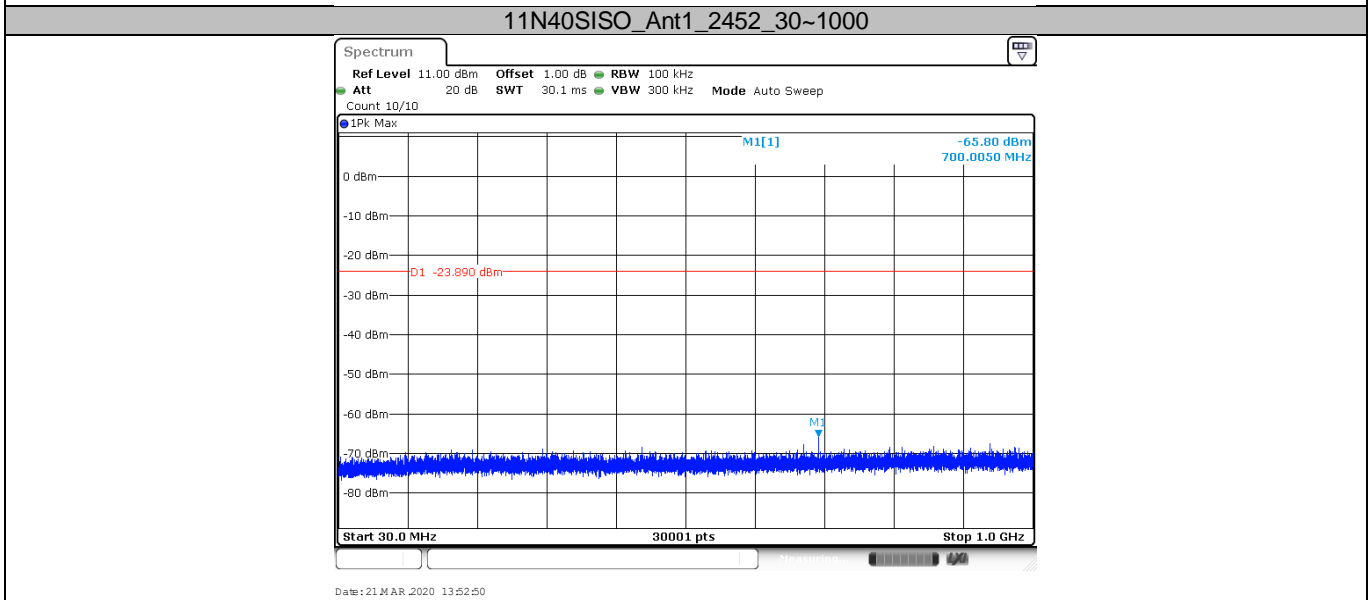
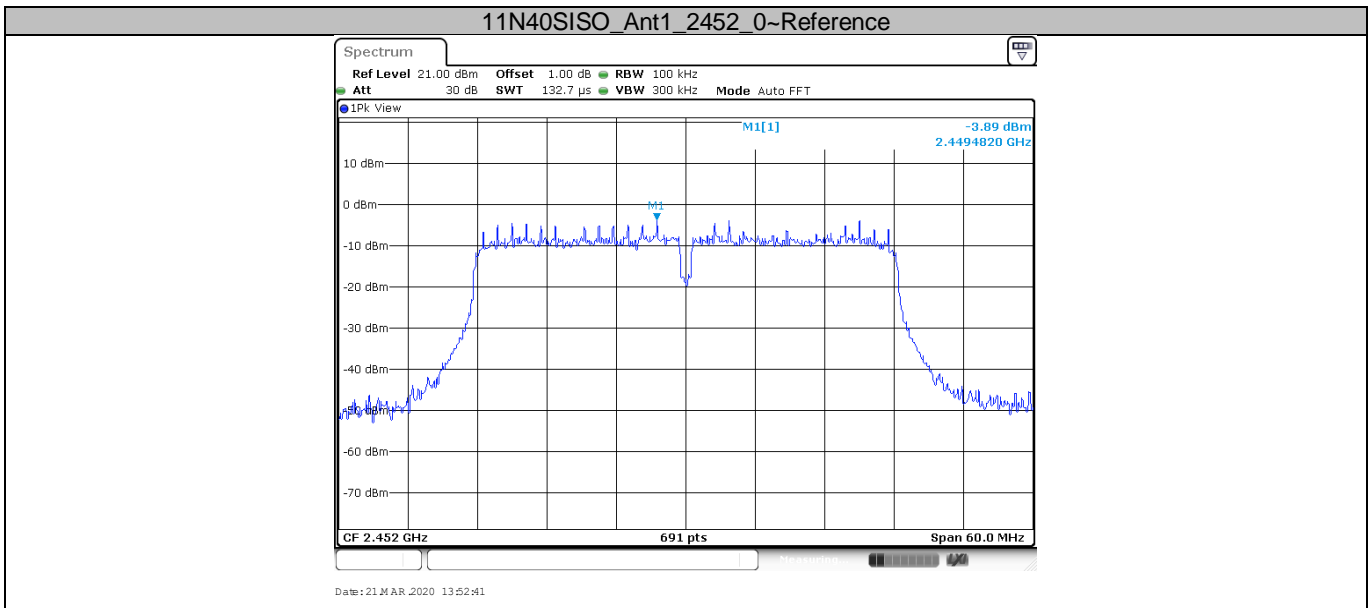

Report Number: 68.950.20.0053.01

Remark: Test of above 1GHz were performed with 1MHz RBW, we can't find any burst, so they are considered to fulfill the requirement with 100KHz RBW without further testing.

9.6 Band edge testing

Test Method

- 1 Use the following spectrum analyzer settings:
Span = wide enough to capture the peak level of the in-band emission and all spurious
RBW = 100 kHz, VBW \geq RBW, Sweep = auto, Detector function = peak, Trace = max hold
- 2 Allow the trace to stabilize, use the peak and delta measurement to record the result.
- 3 The level displayed must comply with the limit specified in this Section. .
- 4 Repeat the test at the hopping off and hopping on mode, submit all the plots.

Limit:

According to §15.247(d), in any 100 kHz bandwidth outside the frequency bands in which the spread spectrum intentional radiator is operating, the radio frequency power that is produced by the intentional radiator shall be at least 20 dB below that in the 100 kHz bandwidth within the band that contains the highest level of the desired power, based on either an RF conducted or a radiated measurement, provided the transmitter demonstrates compliance with the peak conducted power limits. In addition, radiated emissions which fall in the restricted bands, as defined in §15.205(a), must also comply with the radiated emission limits specified in 15.209(a) (see Section 15.205(c)).

Frequency Range MHz	Limit (dBc)
30-25000	-20

Test result:

TestMode	Antenna	ChName	Channel (MHz)	RefLevel (dBm)	Result(dBm)	Limit(dBc)	Verdict
11B	Ant1	Low	2412	3.86	-44.29	<=-11.36	PASS
		High	2462	2.96	-54.18	<=-11.99	PASS
11G	Ant1	Low	2412	-2.43	-41.32	<=-15.61	PASS
		High	2462	-0.39	-52.88	<=-17.79	PASS
11N20SISO	Ant1	Low	2412	-2.31	-43.15	<=-18.44	PASS
		High	2462	-1.15	-52.36	<=-18.87	PASS
11N40SISO	Ant1	Low	2422	-3.77	-41.76	<=-19.89	PASS
		High	2452	-3.87	-45.32	<=-19.74	PASS

Band edge testing

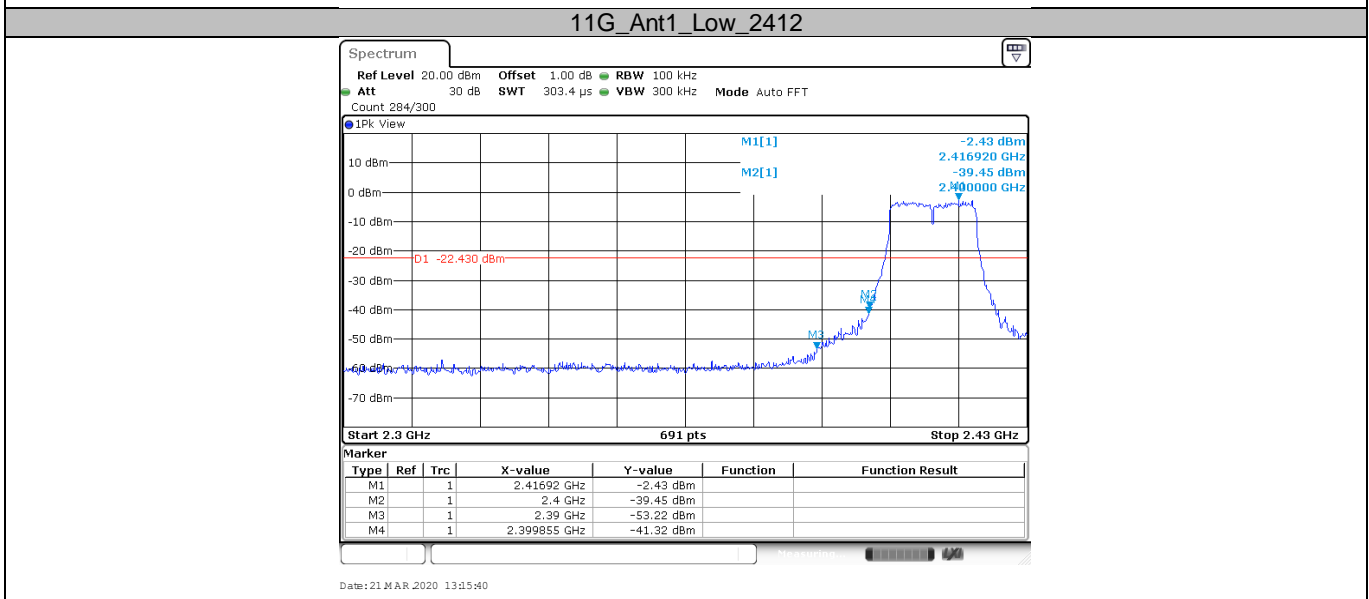
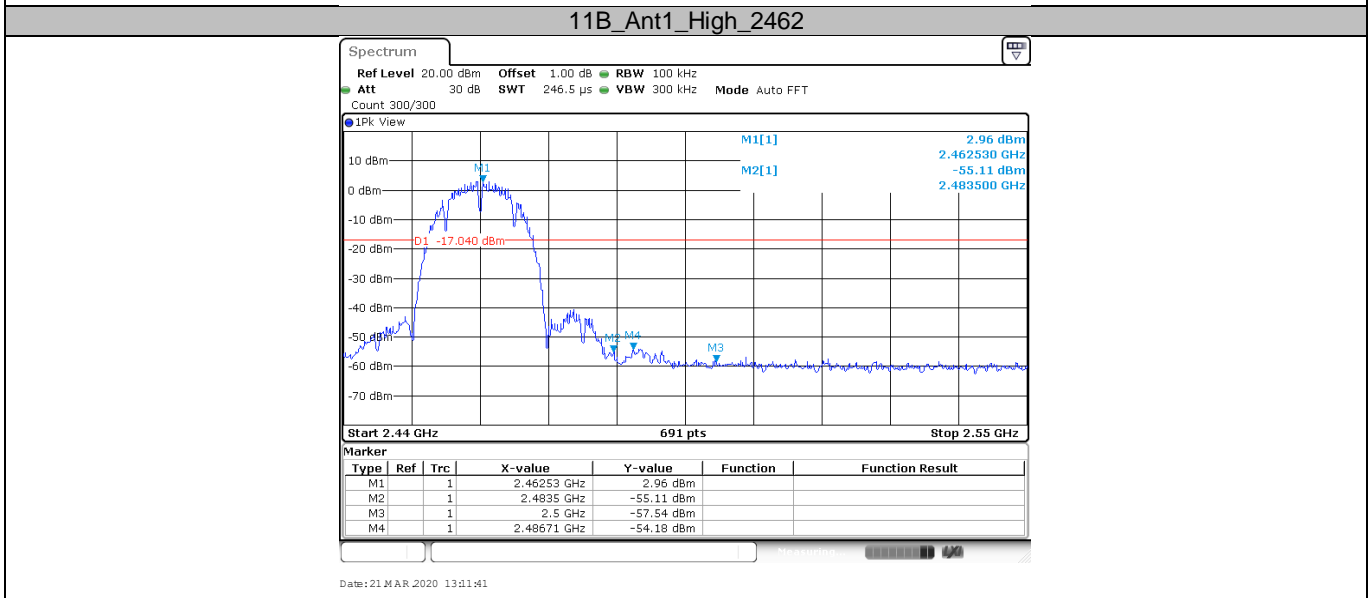
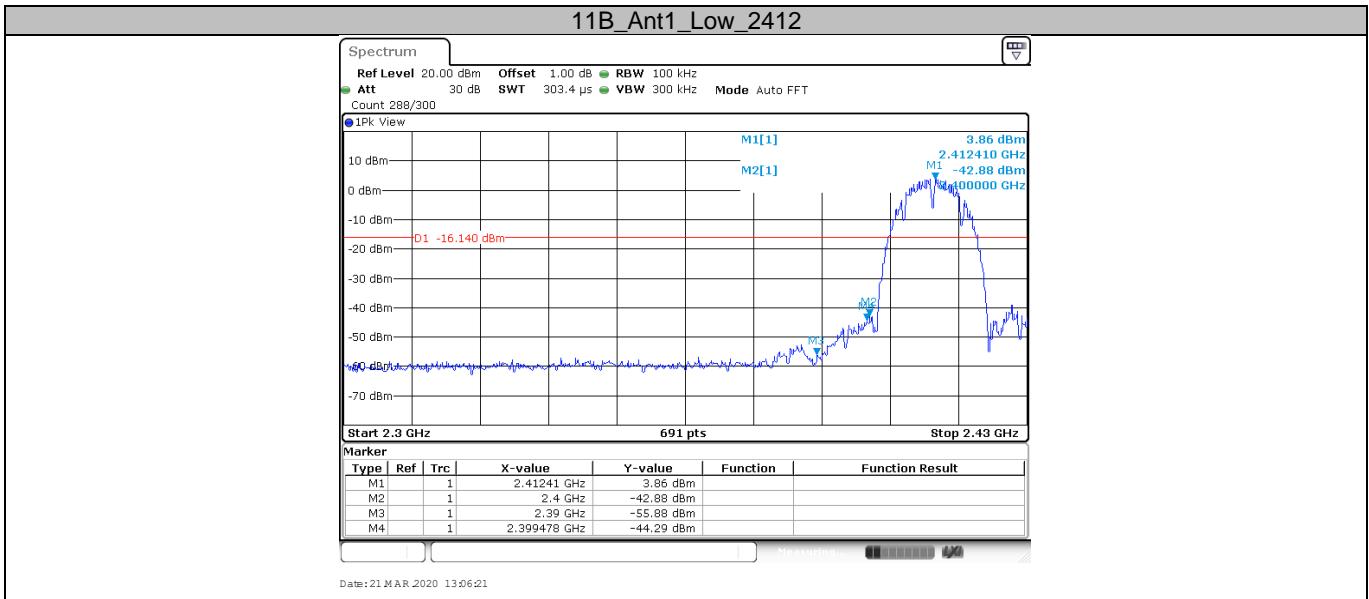

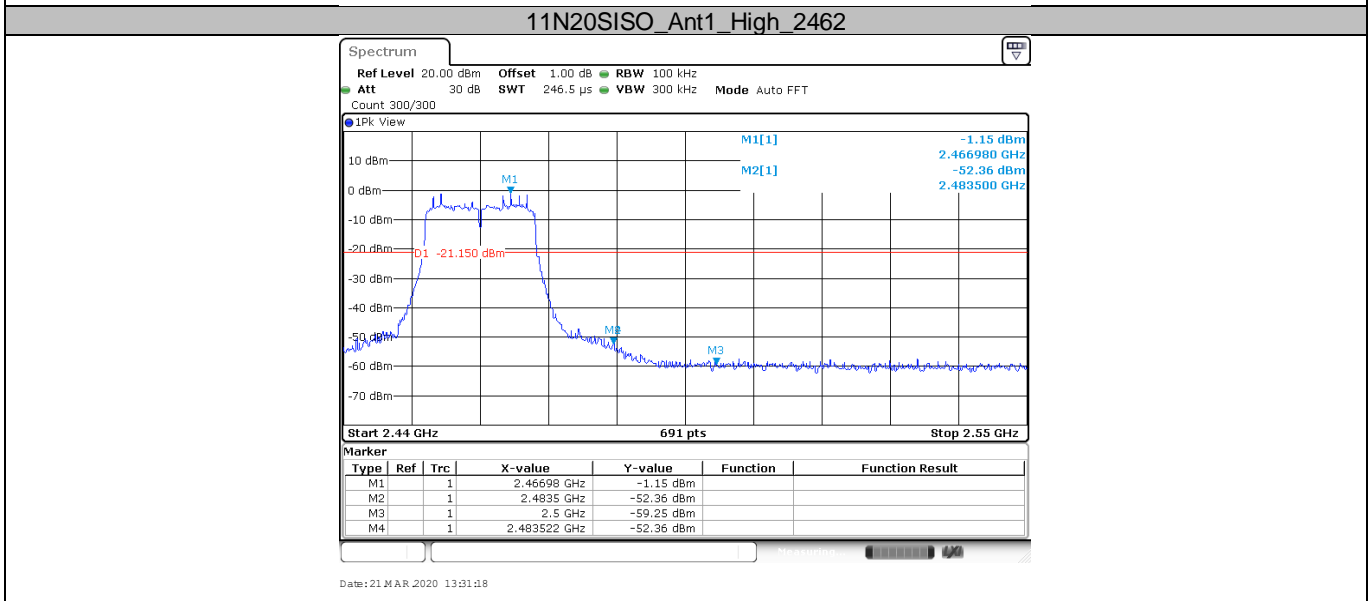
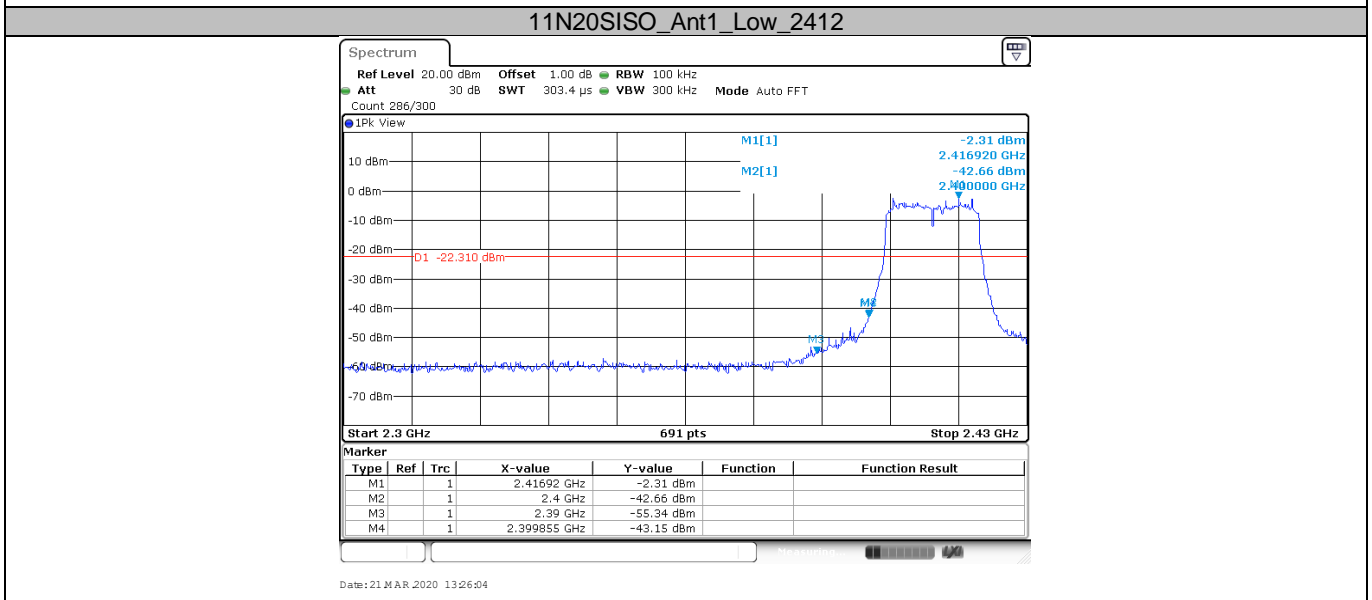
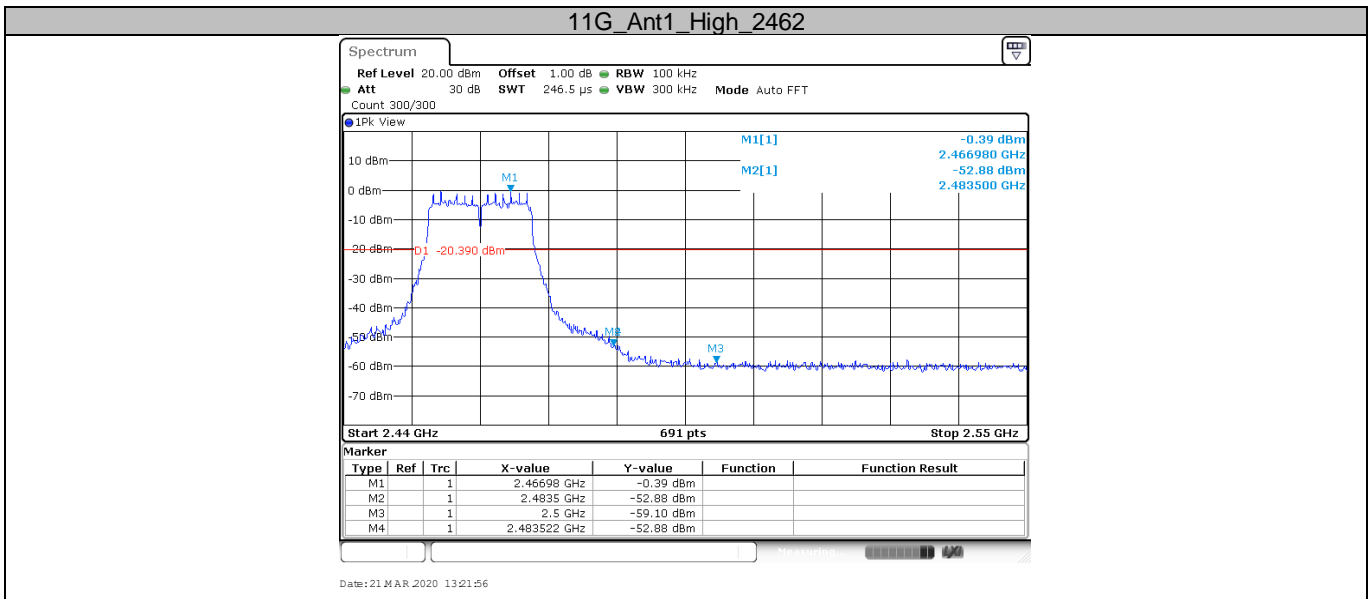

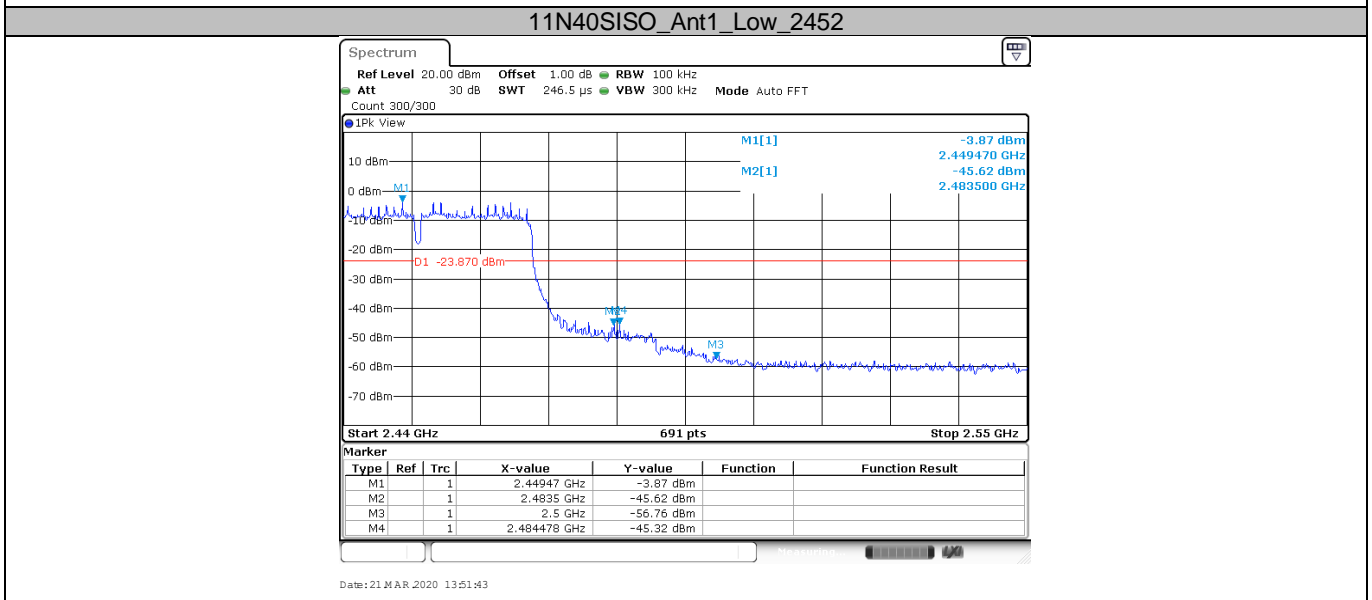
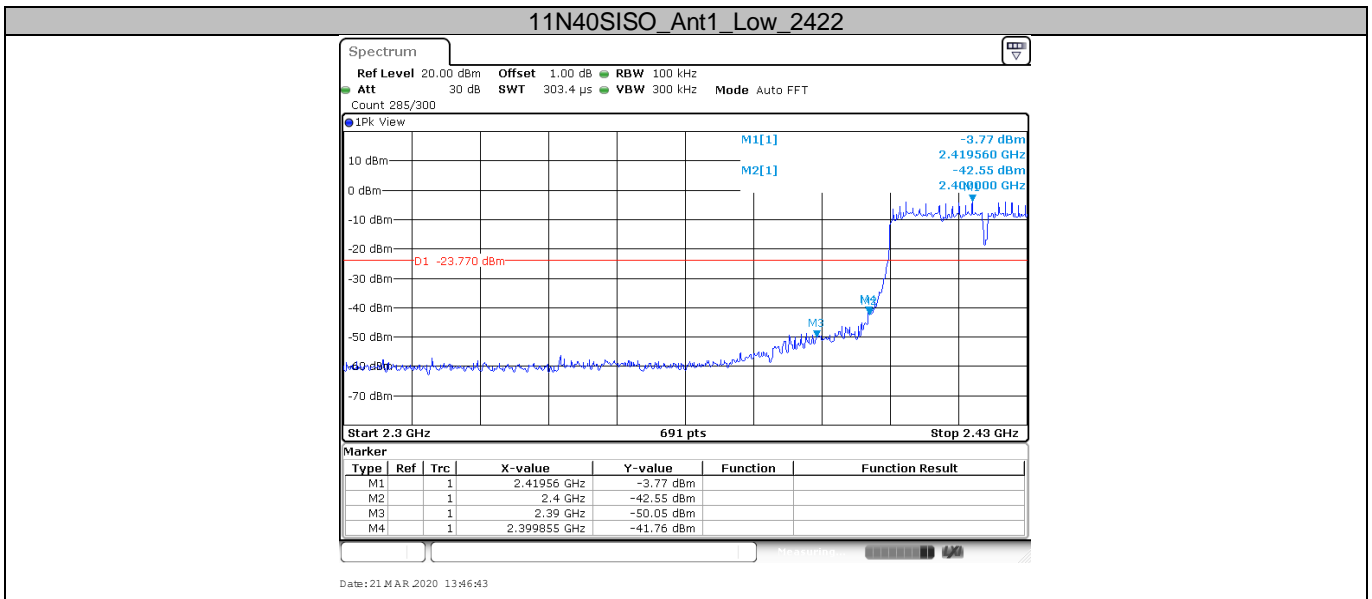

9.7 Spurious radiated emissions for transmitter

Test Method

1. The EUT was placed on a turn table which is 1.5m above ground plane for above 1GHz and 0.8m above ground for below 1GHz at 3 meter chamber room for test. The table was rotated 360 degrees to determine the position of the highest radiation.
2. The EUT was set 3 meters away from the interference – receiving antenna, which was mounted on the top of a variable – height antenna tower.
3. The height of antenna is varied from one meter to four meters above the ground to determine the maximum value of the field strength. Both horizontal and vertical polarizations of the antenna are set to make the measurement.
4. For each suspected emission, the EUT was arranged to its worst case and then the antenna was tuned to heights from 1 meter to 4 meters and the rotatable table was turned from 0 degrees to 360 degrees to find the maximum reading.
5. Use the following spectrum analyzer settings According to C63.10:

For Below 1GHz

Use the following spectrum analyzer settings:

Span = wide enough to capture the peak level of the in-band emission and all spurious
RBW = 100 KHz to 120KHz, VBW ≥ RBW for peak measurement, Sweep = auto, Detector function = peak, Trace = max hold.

For Peak unwanted emissions Above 1GHz:

Span = wide enough to capture the peak level of the in-band emission and all spurious
RBW = 1MHz, VBW ≥ RBW for peak measurement, Sweep = auto, Detector function = peak, Trace = max hold.

Procedures for average unwanted emissions measurements above 1000 MHz

- a) RBW = 1 MHz.
- b) VBW \ [3 × RBW].
- c) Detector = RMS (power averaging), if [span / (# of points in sweep)] \ RBW / 2.
Satisfying this condition can require increasing the number of points in the sweep or reducing the span. If the condition is not satisfied, then the detector mode shall be set to peak.
- d) Averaging type = power (i.e., rms) (As an alternative, the detector and averaging type may be set for linear voltage averaging. Some instruments require linear display mode to use linear voltage averaging. Log or dB averaging shall not be used.)
- e) Sweep time = auto.
- f) Perform a trace average of at least 100 traces if the transmission is continuous. If the transmission is not continuous, then the number of traces shall be increased by a factor of 1 / D, where D is the duty cycle. For example, with 50% duty cycle, at least 200 traces shall be averaged. (If a specific emission is demonstrated to be continuous—i.e., 100% duty cycle—then rather than turning ON and OFF with the transmit cycle, at least 100 traces shall be averaged.)
- g) If tests are performed with the EUT transmitting at a duty cycle less than 98%, then a correction factor shall be added to the measurement results prior to comparing with the emission limit, to compute the emission level that would have been measured had the test been performed at 100% duty cycle. The correction factor is computed as follows:
 - 1) If power averaging (rms) mode was used in the preceding step e), then the correction factor is [10 log (1 / D)], where D is the duty cycle. For example, if the transmit duty cycle was 50%, then 3 dB shall be added to the measured emission levels.

2) If linear voltage averaging mode was used in the preceding step e), then the correction factor is $[20 \log (1 / D)]$, where D is the duty cycle. For example, if the transmit duty cycle was 50%, then 6 dB shall be added to the measured emission levels.

3) If a specific emission is demonstrated to be continuous (100% duty cycle) rather than turning ON and OFF with the transmit cycle, then no duty cycle correction is required for that emission.

Limit

The radio emission outside the operating frequency band shall be at least 20 dB below that in the 100 kHz bandwidth within the band that contains the highest level of the desired power. Radiated emissions which fall in the restricted bands, as defined in section 15.205, must comply with the radiated emission limits specified in section 15.209.

Frequency MHz	Field Strength uV/m	Field Strength dBµV/m	Detector
30-88	100	40	QP
88-216	150	43.5	QP
216-960	200	46	QP
960-1000	500	54	QP
Above 1000	500	54	AV
Above 1000	5000	74	PK

Spurious radiated emissions for transmitter

According to C63.10, if the peak (or quasi-peak) measured value complies with the average limit, it is unnecessary to perform an average measurement, so AV emission value did not show in below table if the peak value complies with average limit.

Below 1G:

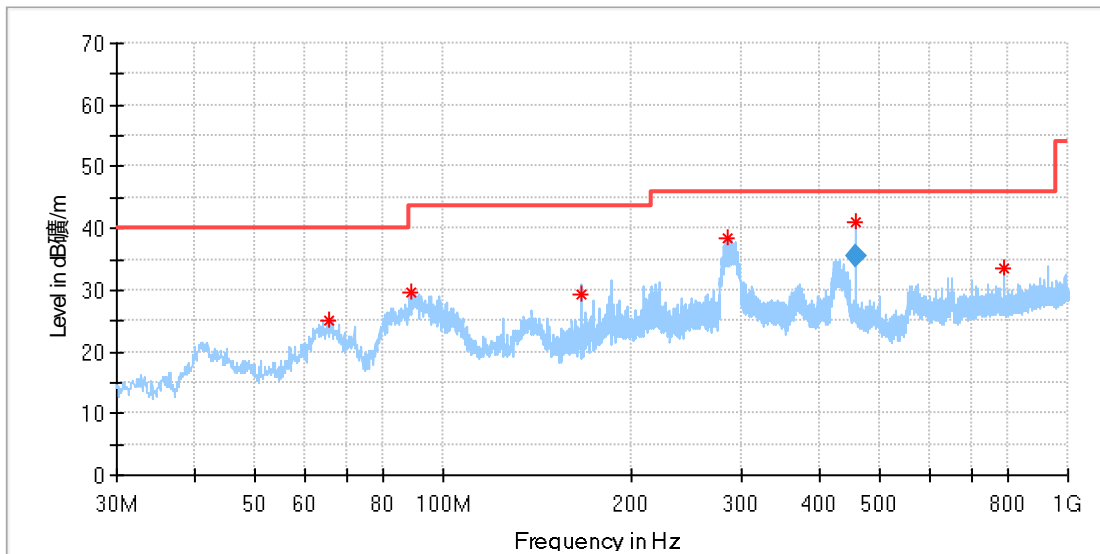

Frequency (MHz)	MaxPeak (dBµV/m)	Limit (dBµV/m)	Margin (dB)	Height (cm)	Pol	Azimuth (deg)	Corr. (dB/m)
65.829375	25.13	40.00	14.87	200.0	H	14.0	15
89.048750	29.69	43.50	13.81	200.0	H	4.0	14
166.709375	29.40	43.50	14.10	100.0	H	30.0	13
285.231250	38.51	46.00	7.49	100.0	H	46.0	18
456.002813	40.92	46.00	5.08	179.0	H	285.0	22
791.328750	33.56	46.00	12.44	100.0	H	260.0	28
Frequency (MHz)	QuasiPeak (dBµV/m)	Limit (dBµV/m)	Margin (dB)	Height (cm)	Pol	Azimuth (deg)	Corr. (dB/m)
456.002813	35.64	46.00	10.36	179.0	H	285.0	22

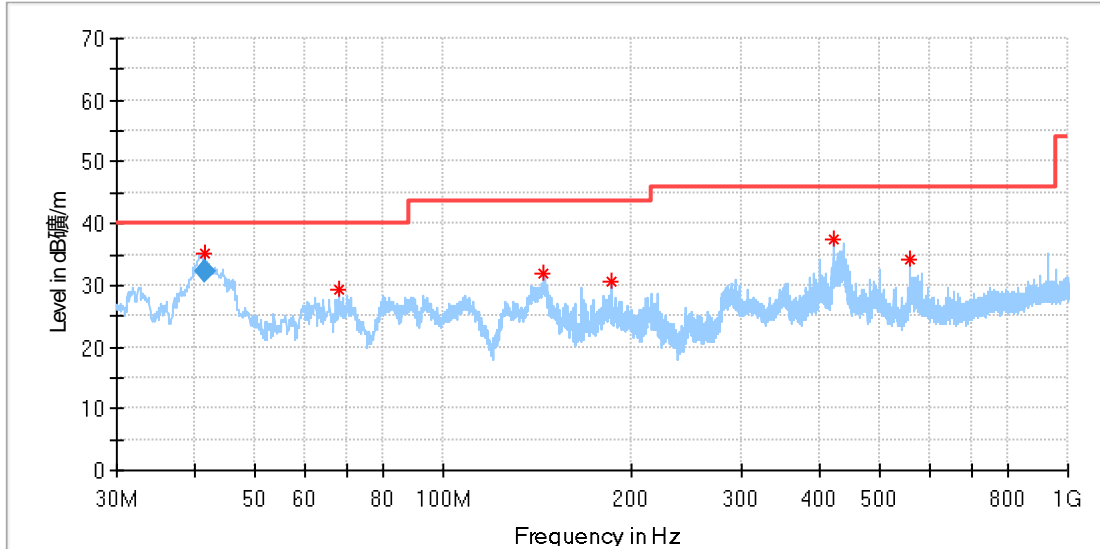

Frequency (MHz)	MaxPeak (dBµV/m)	Limit (dBµV/m)	Margin (dB)	Height (cm)	Pol	Azimuth (deg)	Corr. (dB/m)
41.518750	35.28	40.00	4.72	100.0	V	217.0	17
68.072500	29.45	40.00	10.55	100.0	V	302.0	15
145.066250	31.97	43.50	11.53	100.0	V	0.0	12
185.563750	30.65	43.50	12.85	100.0	V	100.0	15
422.971250	37.35	46.00	8.65	100.0	V	225.0	22
556.891875	34.18	46.00	11.82	100.0	V	178.0	24
Frequency (MHz)	QuasiPeak (dBµV/m)	Limit (dBµV/m)	Margin (dB)	Height (cm)	Pol	Azimuth (deg)	Corr. (dB/m)
41.518750	32.28	40.00	7.72	100.0	V	217.0	17

Transmitting spurious emission test result as below:

802.11B Modulation 2412MHz Test Result

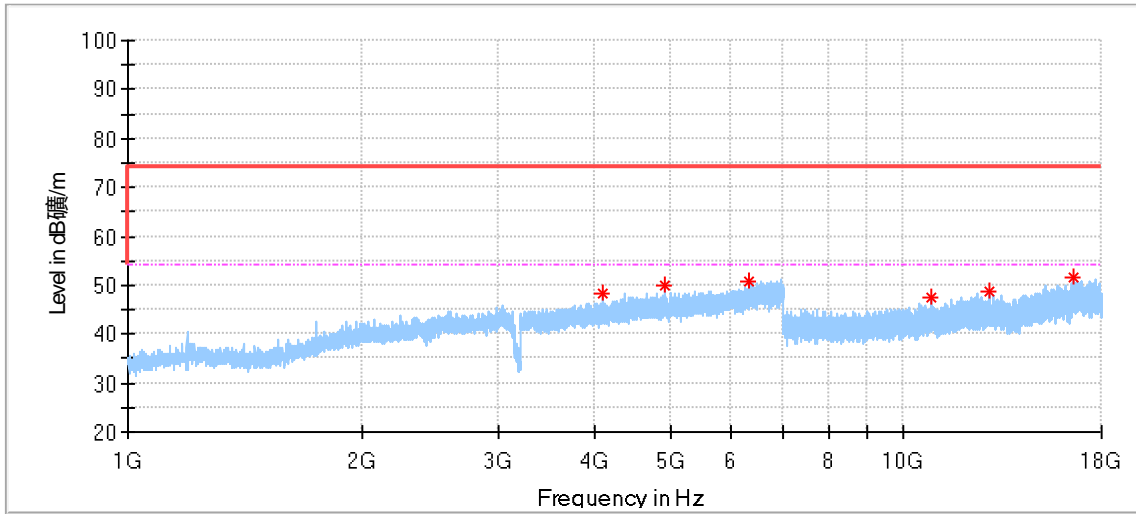

Frequency (MHz)	MaxPeak (dBµV/m)	Limit (dBµV/m)	Margin (dB)	Height (cm)	Pol	Azimuth (deg)	Corr. (dB/m)
4084.500000	48.41	74.00	25.59	150.0	H	218.0	1.4
4924.500000	50.14	74.00	23.86	150.0	H	176.0	2.2
6327.500000	50.88	74.00	23.12	150.0	H	121.0	6.0
10845.500000	47.60	74.00	26.40	150.0	H	227.0	7.9
12879.500000	48.52	74.00	25.48	150.0	H	195.0	10.2
16593.500000	51.48	74.00	22.52	150.0	H	267.0	16.0

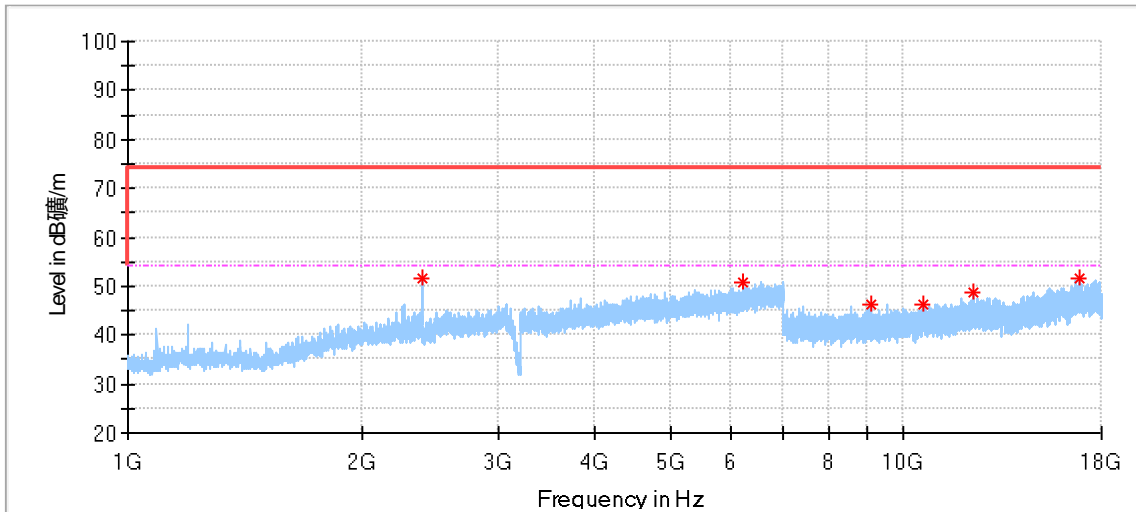

Frequency (MHz)	MaxPeak (dBµV/m)	Limit (dBµV/m)	Margin (dB)	Height (cm)	Pol	Azimuth (deg)	Corr. (dB/m)
2392.000000	51.57	74.00	22.43	150.0	V	300.0	-3.9
6223.500000	50.80	74.00	23.20	150.0	V	178.0	5.5
9107.500000	46.14	74.00	27.86	150.0	V	102.0	6.9
10628.500000	46.31	74.00	27.69	150.0	V	136.0	8.2
12307.500000	48.58	74.00	25.42	150.0	V	272.0	10.0
16901.500000	51.67	74.00	22.33	150.0	V	85.0	16.4

802.11B Modulation 2437MHz Test Result

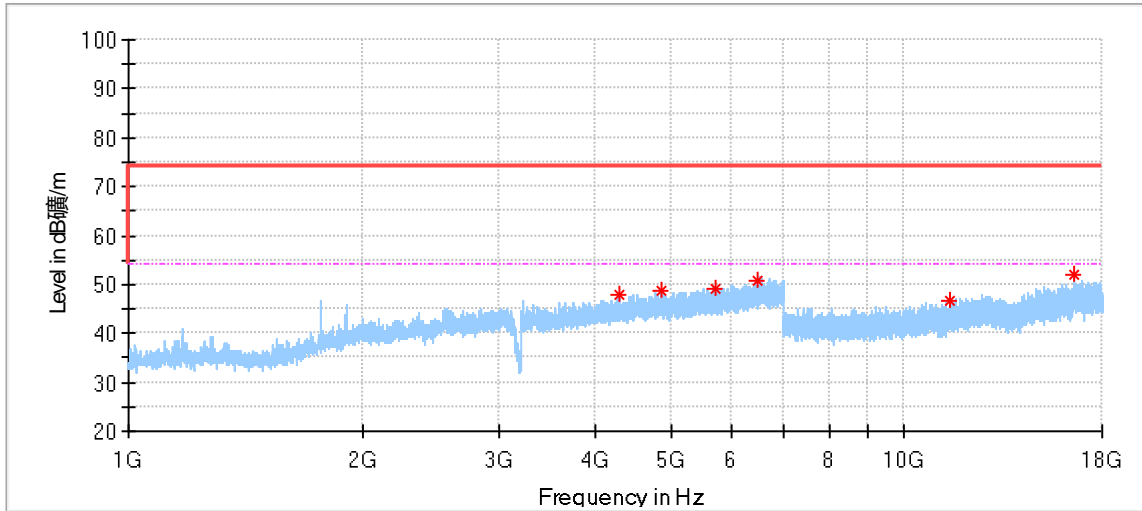

Frequency (MHz)	MaxPeak (dBµV/m)	Limit (dBµV/m)	Margin (dB)	Height (cm)	Pol	Azimuth (deg)	Corr. (dB/m)	Corr. (dB)
4305.000000	48.04	74.00	25.96	150.0	H	283.0	2.0	---
4874.000000	48.75	74.00	25.25	150.0	H	193.0	2.4	---
5727.000000	49.27	74.00	24.73	150.0	H	338.0	3.4	---
6486.000000	50.67	74.00	23.33	150.0	H	193.0	6.5	---
11422.000000	46.48	74.00	27.52	150.0	H	170.0	8.6	---
16576.000000	51.92	74.00	22.08	150.0	H	240.0	16.0	---

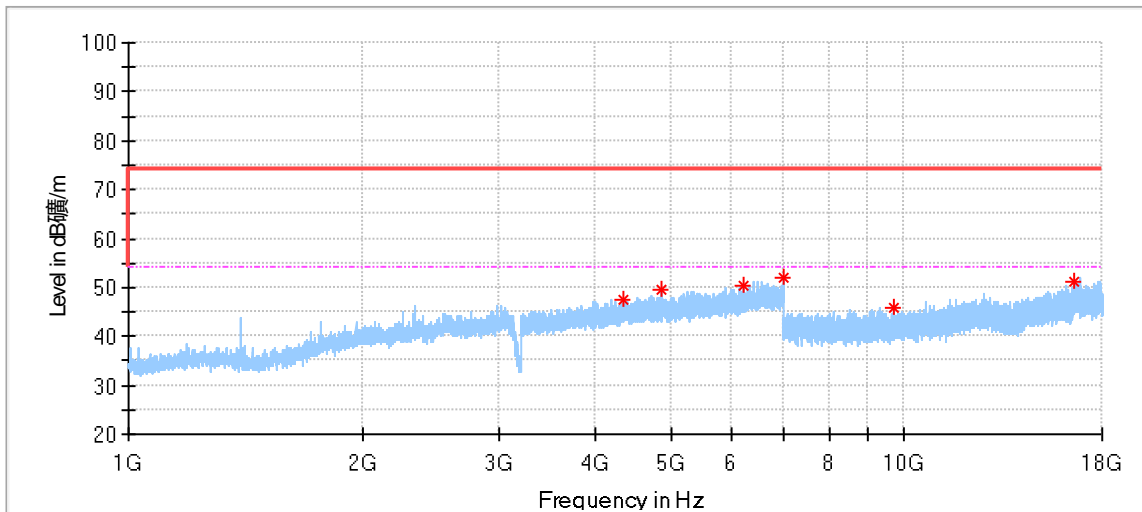

Frequency (MHz)	MaxPeak (dBµV/m)	Limit (dBµV/m)	Margin (dB)	Height (cm)	Pol	Azimuth (deg)	Corr. (dB/m)
4357.500000	47.38	74.00	26.62	150.0	V	234.0	2.8
4874.500000	49.61	74.00	24.39	150.0	V	25.0	2.4
6202.500000	50.30	74.00	23.70	150.0	V	18.0	5.2
6978.500000	52.17	74.00	21.83	150.0	V	344.0	7.1
9702.000000	45.66	74.00	28.34	150.0	V	355.0	7.6
16544.500000	50.98	74.00	23.02	150.0	V	316.0	15.7

802.11B Modulation 2462MHz Test Result

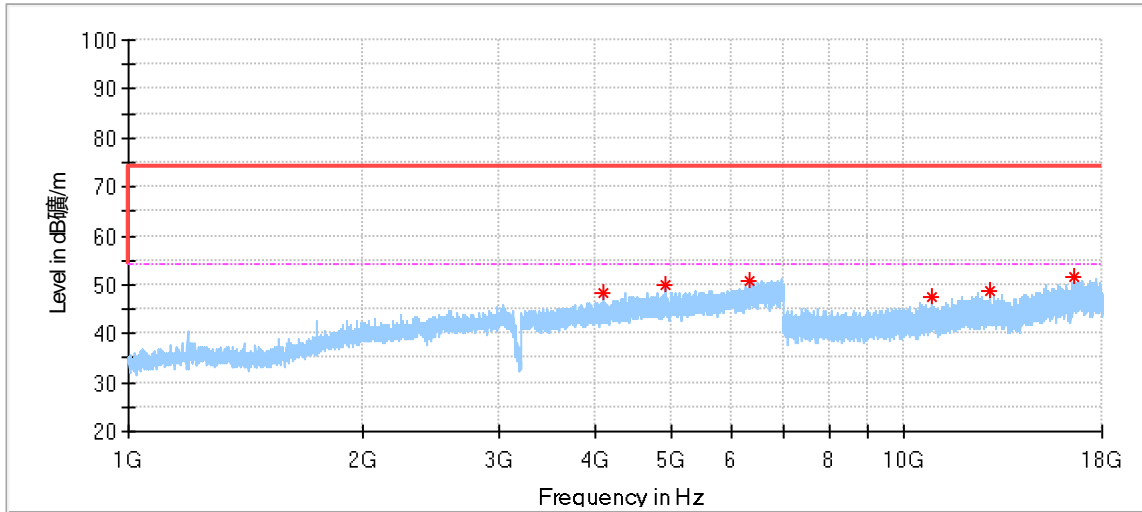

Frequency (MHz)	MaxPeak (dBμV/m)	Limit (dBμV/m)	Margin (dB)	Height (cm)	Pol	Azimuth (deg)	Corr. (dB/m)
4084.500000	48.41	74.00	25.59	150.0	H	218.0	1.4
4924.500000	50.14	74.00	23.86	150.0	H	176.0	2.2
6327.500000	50.88	74.00	23.12	150.0	H	121.0	6.0
10845.500000	47.60	74.00	26.40	150.0	H	227.0	7.9
12879.500000	48.52	74.00	25.48	150.0	H	195.0	10.2
16593.500000	51.48	74.00	22.52	150.0	H	267.0	16.0

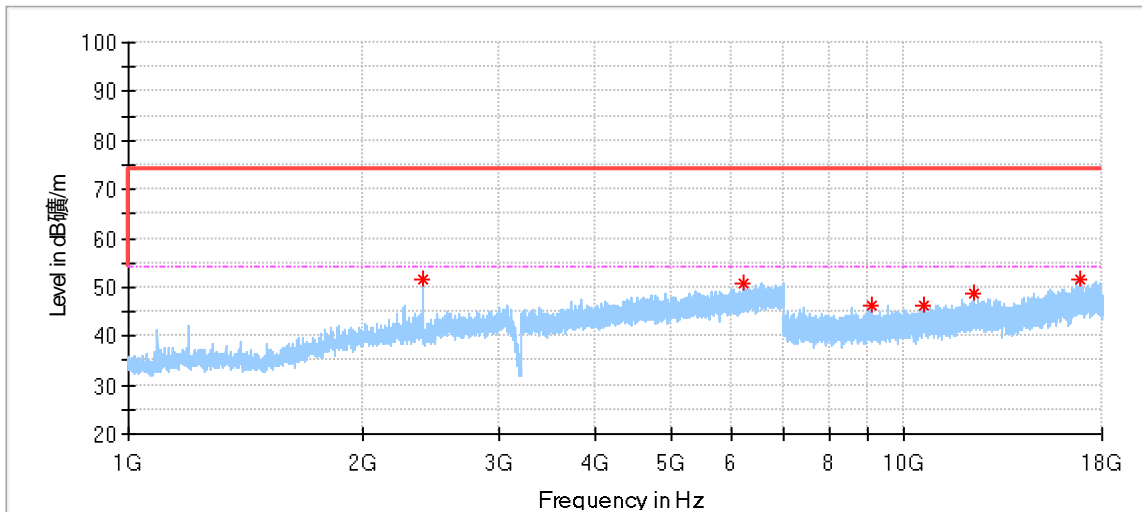

Frequency (MHz)	MaxPeak (dBμV/m)	Limit (dBμV/m)	Margin (dB)	Height (cm)	Pol	Azimuth (deg)	Corr. (dB/m)
2392.000000	51.57	74.00	22.43	150.0	V	300.0	-3.9
6223.500000	50.80	74.00	23.20	150.0	V	178.0	5.5
9107.500000	46.14	74.00	27.86	150.0	V	102.0	6.9
10628.500000	46.31	74.00	27.69	150.0	V	136.0	8.2
12307.500000	48.58	74.00	25.42	150.0	V	272.0	10.0
16901.500000	51.67	74.00	22.33	150.0	V	85.0	16.4

802.11G Modulation 2412MHz Test Result

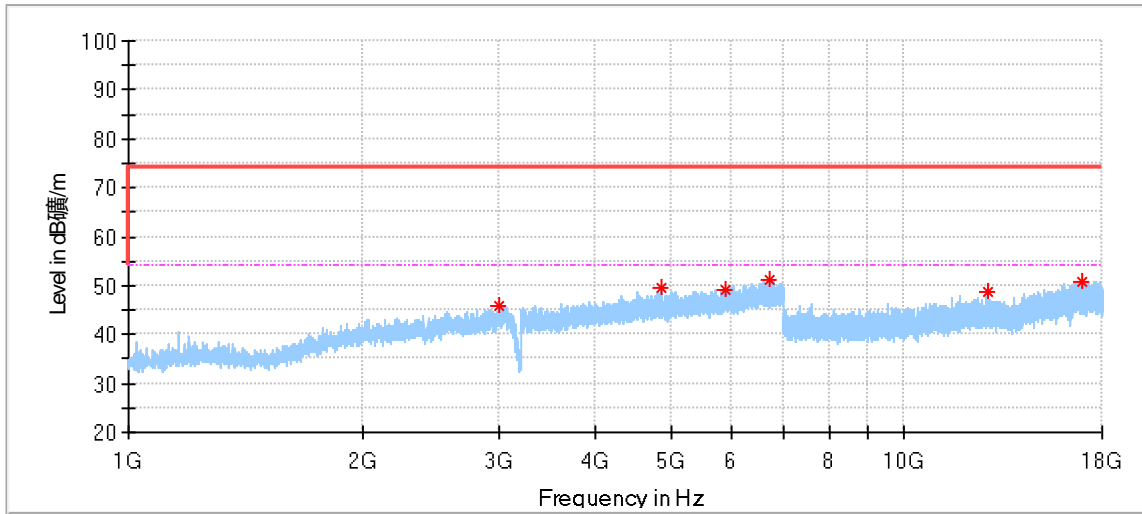

Frequency (MHz)	MaxPeak (dBµV/m)	Limit (dBµV/m)	Margin (dB)	Height (cm)	Pol	Azimuth (deg)	Corr. (dB/m)
3002.500000	45.84	74.00	28.16	150.0	H	183.0	-1.4
4862.000000	49.39	74.00	24.61	150.0	H	288.0	2.3
5876.000000	49.28	74.00	24.72	150.0	H	261.0	4.6
6689.500000	51.18	74.00	22.82	150.0	H	328.0	6.6
12803.000000	48.54	74.00	25.46	150.0	H	307.0	10.3
16950.000000	50.90	74.00	23.10	150.0	H	273.0	16.5

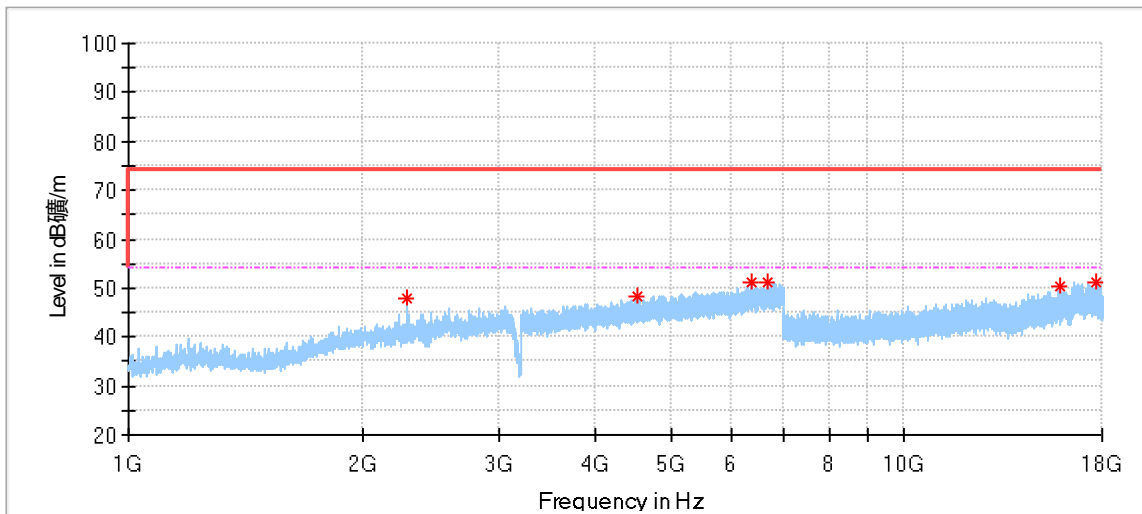

Frequency (MHz)	MaxPeak (dBµV/m)	Limit (dBµV/m)	Margin (dB)	Height (cm)	Pol	Azimuth (deg)	Corr. (dB/m)
2291.500000	47.79	74.00	26.21	150.0	V	219.0	-4.5
4534.000000	48.31	74.00	25.69	150.0	V	54.0	2.9
6370.500000	51.24	74.00	22.76	150.0	V	134.0	6.2
6683.000000	51.23	74.00	22.77	150.0	V	148.0	6.6
15885.500000	50.30	74.00	23.70	150.0	V	298.0	14.0
17728.500000	51.27	74.00	22.73	150.0	V	298.0	17.7

802.11G Modulation 2437MHz Test Result

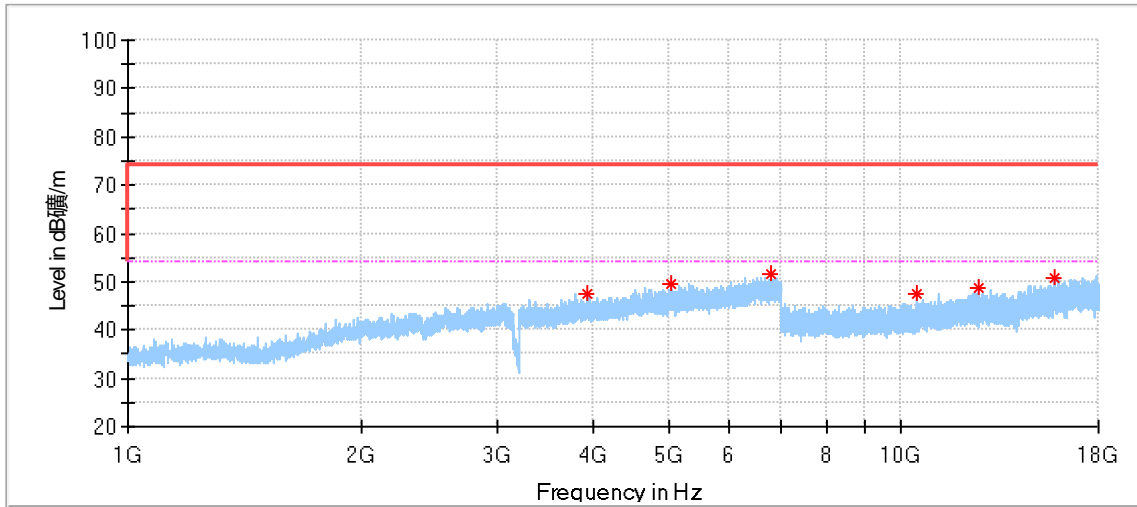

Frequency (MHz)	MaxPeak (dBµV/m)	Limit (dBµV/m)	Margin (dB)	Height (cm)	Pol	Azimuth (deg)	Corr. (dB/m)
3934.500000	47.56	74.00	26.44	150.0	H	33.0	1.0
5044.000000	49.53	74.00	24.47	150.0	H	358.0	2.7
6799.000000	51.63	74.00	22.37	150.0	H	88.0	6.6
10484.500000	47.57	74.00	26.43	150.0	H	313.0	8.0
12617.000000	48.92	74.00	25.08	150.0	H	190.0	9.8
15806.000000	50.64	74.00	23.36	150.0	H	295.0	13.9

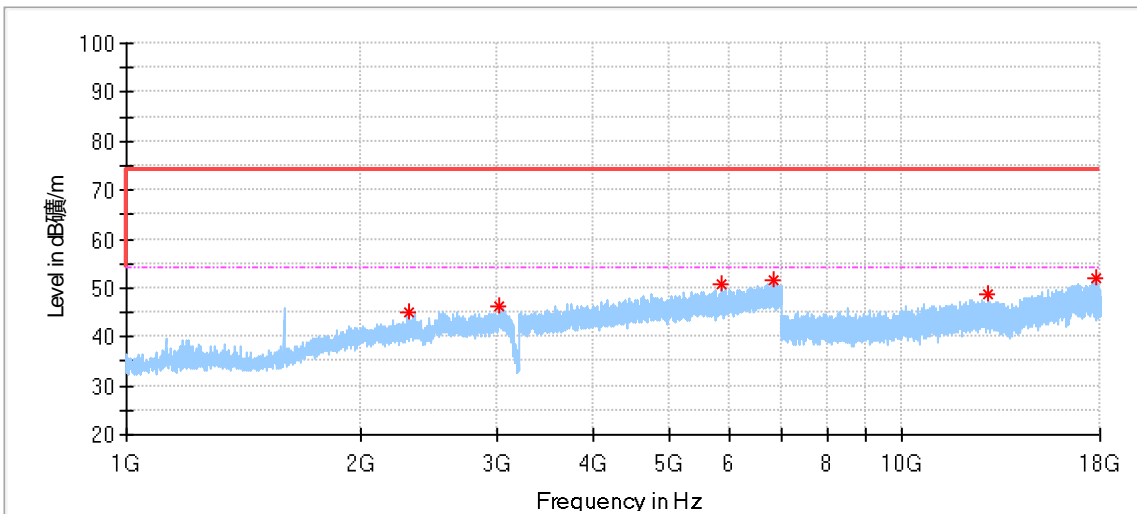

Frequency (MHz)	MaxPeak (dBµV/m)	Limit (dBµV/m)	Margin (dB)	Height (cm)	Pol	Azimuth (deg)	Corr. (dB/m)
2313.500000	45.19	74.00	28.81	150.0	V	202.0	-4.2
3020.000000	46.16	74.00	27.84	150.0	V	57.0	-1.2
5849.000000	50.84	74.00	23.16	150.0	V	245.0	4.1
6808.500000	51.47	74.00	22.53	150.0	V	218.0	6.6
12901.500000	48.82	74.00	25.18	150.0	V	276.0	9.9
17739.000000	51.81	74.00	22.19	150.0	V	136.0	17.9

802.11G Modulation 2462MHz Test Result

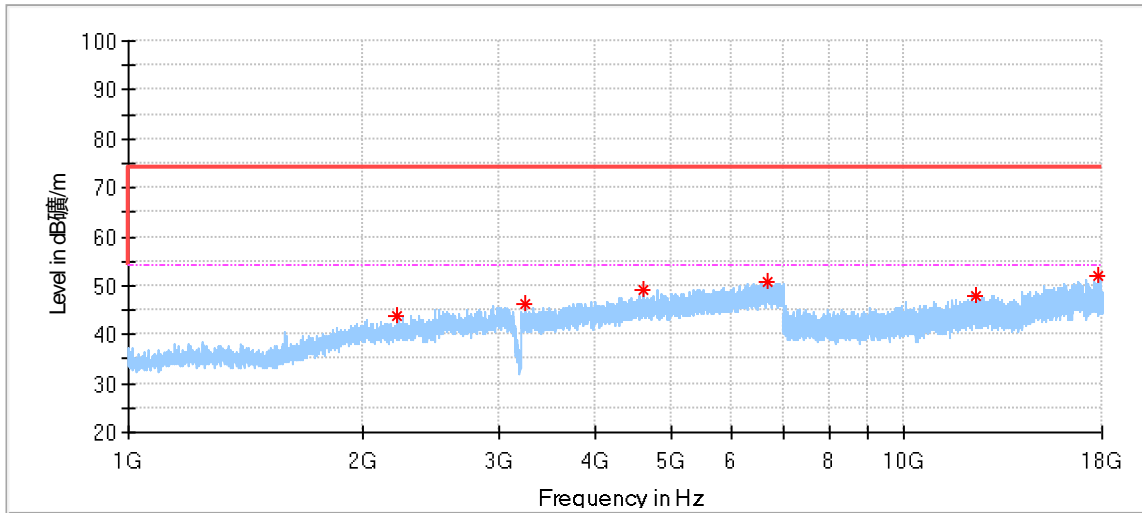

Frequency (MHz)	MaxPeak (dBµV/m)	Limit (dBµV/m)	Margin (dB)	Height (cm)	Pol	Azimuth (deg)	Corr. (dB/m)
2225.000000	43.99	74.00	30.01	150.0	H	136.0	-4.8
3249.000000	46.35	74.00	27.65	150.0	H	243.0	-1.4
4623.500000	49.25	74.00	24.75	150.0	H	47.0	2.8
6647.500000	50.91	74.00	23.09	150.0	H	100.0	6.8
12348.500000	48.04	74.00	25.96	150.0	H	243.0	10.1
17744.000000	51.82	74.00	22.18	150.0	H	140.0	17.8

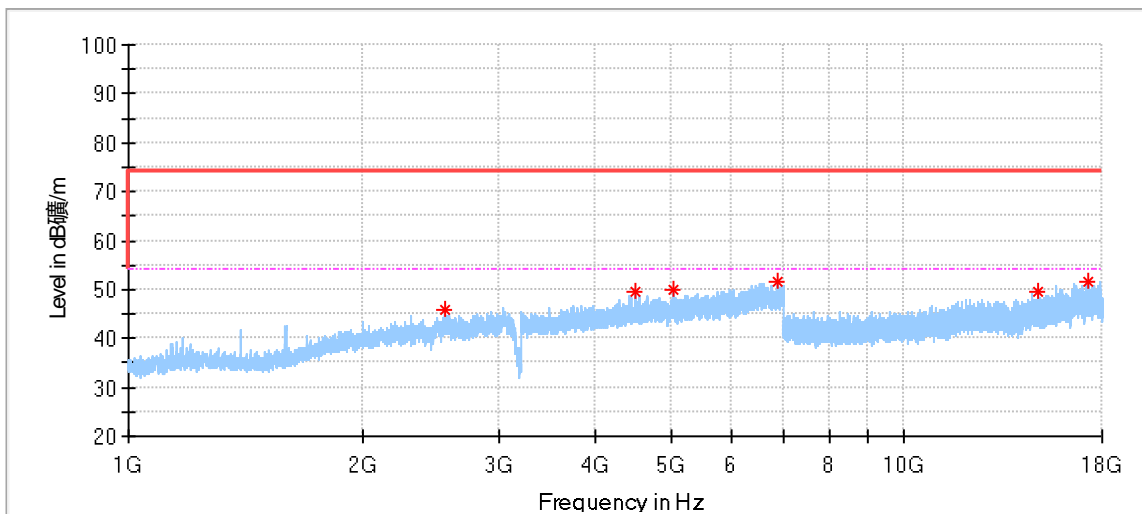

Frequency (MHz)	MaxPeak (dBµV/m)	Limit (dBµV/m)	Margin (dB)	Height (cm)	Pol	Azimuth (deg)	Corr. (dB/m)
2552.000000	45.76	74.00	28.24	150.0	V	185.0	-3.3
4512.000000	49.62	74.00	24.38	150.0	V	163.0	3.0
5049.000000	50.15	74.00	23.85	150.0	V	219.0	2.8
6852.000000	51.70	74.00	22.30	150.0	V	153.0	6.9
14896.000000	49.69	74.00	24.31	150.0	V	88.0	12.2
17248.500000	51.53	74.00	22.47	150.0	V	106.0	17.3

802.11N20 Modulation 2412MHz Test Result

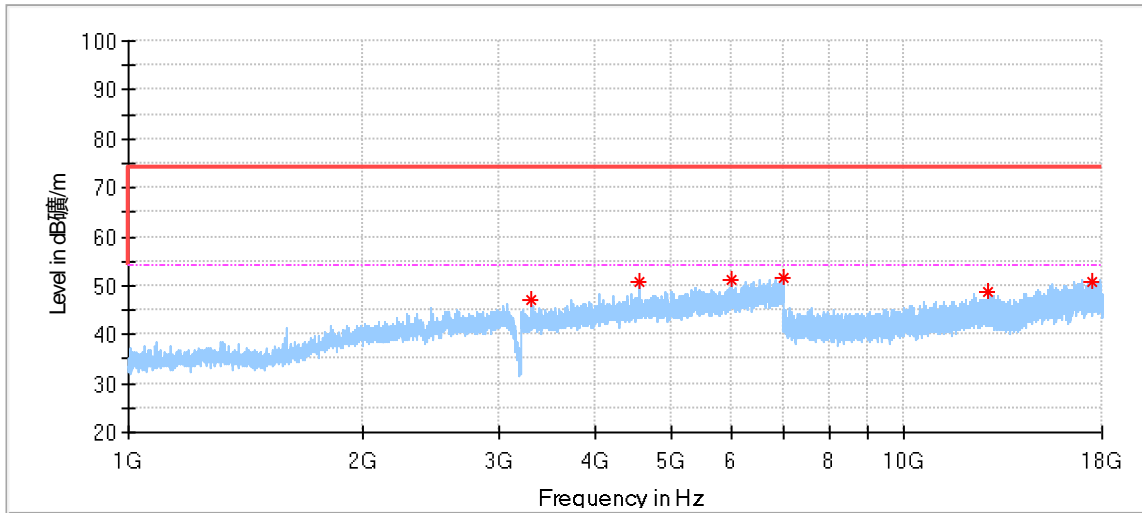

Frequency (MHz)	MaxPeak (dBµV/m)	Limit (dBµV/m)	Margin (dB)	Height (cm)	Pol	Azimuth (deg)	Corr. (dB/m)
3313.500000	47.07	74.00	26.93	150.0	H	314.0	-1.0
4560.500000	50.76	74.00	23.24	150.0	H	25.0	2.8
6007.500000	51.16	74.00	22.84	150.0	H	31.0	5.0
6984.500000	51.58	74.00	22.42	150.0	H	94.0	7.2
12827.500000	48.54	74.00	25.46	150.0	H	240.0	10.1
17458.500000	50.82	74.00	23.18	150.0	H	36.0	16.9

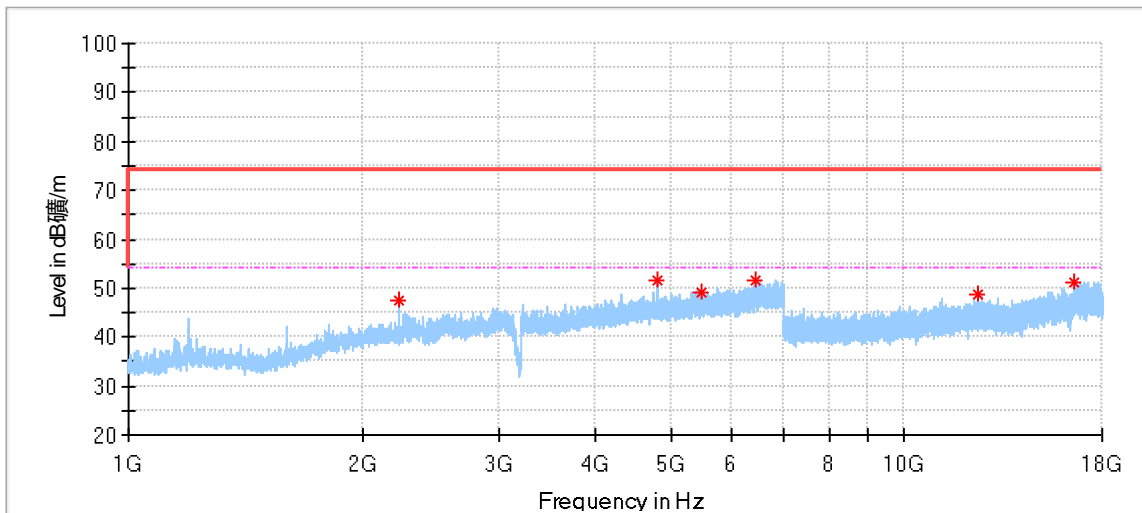

Frequency (MHz)	MaxPeak (dBµV/m)	Limit (dBµV/m)	Margin (dB)	Height (cm)	Pol	Azimuth (deg)	Corr. (dB/m)
2238.000000	47.47	74.00	26.53	150.0	V	211.0	-4.8
4798.500000	51.69	74.00	22.31	150.0	V	235.0	2.5
5463.000000	49.30	74.00	24.70	150.0	V	204.0	2.5
6432.500000	51.70	74.00	22.30	150.0	V	47.0	6.2
12442.000000	48.57	74.00	25.43	150.0	V	26.0	10.1
16587.500000	50.99	74.00	23.01	150.0	V	290.0	16.0

802.11N20 Modulation 2437MHz Test Result

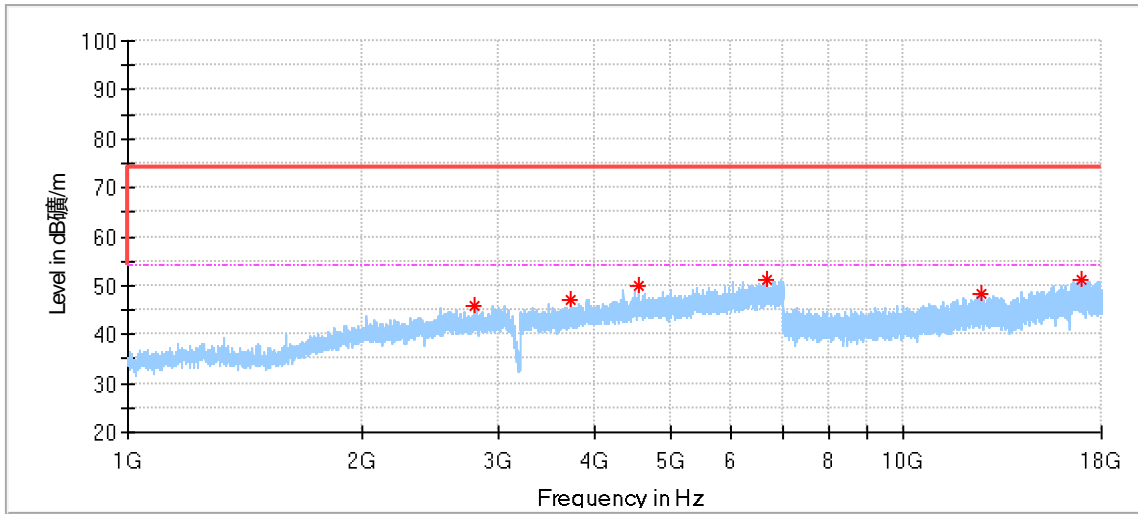

Frequency (MHz)	MaxPeak (dBµV/m)	Limit (dBµV/m)	Margin (dB)	Height (cm)	Pol	Azimuth (deg)	Corr. (dB/m)
2794.500000	45.70	74.00	28.30	150.0	H	6.0	-3.2
3718.000000	46.99	74.00	27.01	150.0	H	293.0	0.7
4560.500000	50.12	74.00	23.88	150.0	H	29.0	2.8
6684.500000	51.27	74.00	22.73	150.0	H	293.0	6.6
12630.000000	48.15	74.00	25.85	150.0	H	203.0	10.0
16916.500000	51.37	74.00	22.63	150.0	H	222.0	16.7

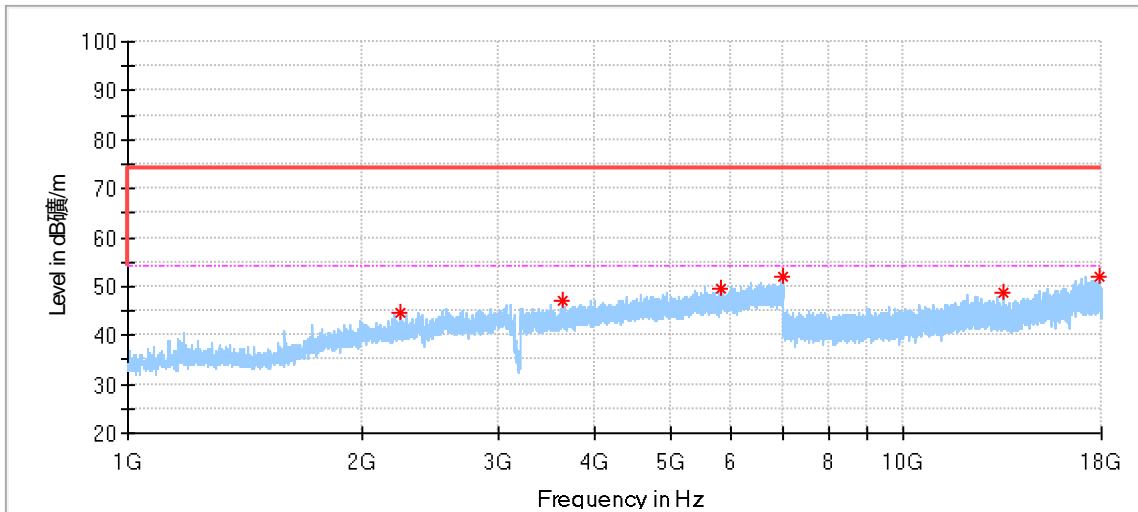

Frequency (MHz)	MaxPeak (dBµV/m)	Limit (dBµV/m)	Margin (dB)	Height (cm)	Pol	Azimuth (deg)	Corr. (dB/m)
2249.500000	44.80	74.00	29.20	150.0	V	193.0	-4.8
3638.000000	47.02	74.00	26.98	150.0	V	190.0	-0.6
5829.500000	49.58	74.00	24.42	150.0	V	120.0	3.6
6984.000000	52.04	74.00	21.96	150.0	V	115.0	7.2
13459.500000	48.64	74.00	25.36	150.0	V	256.0	9.3
17931.500000	52.11	74.00	21.89	150.0	V	310.0	17.5

802.11N20 Modulation 2462MHz Test Result

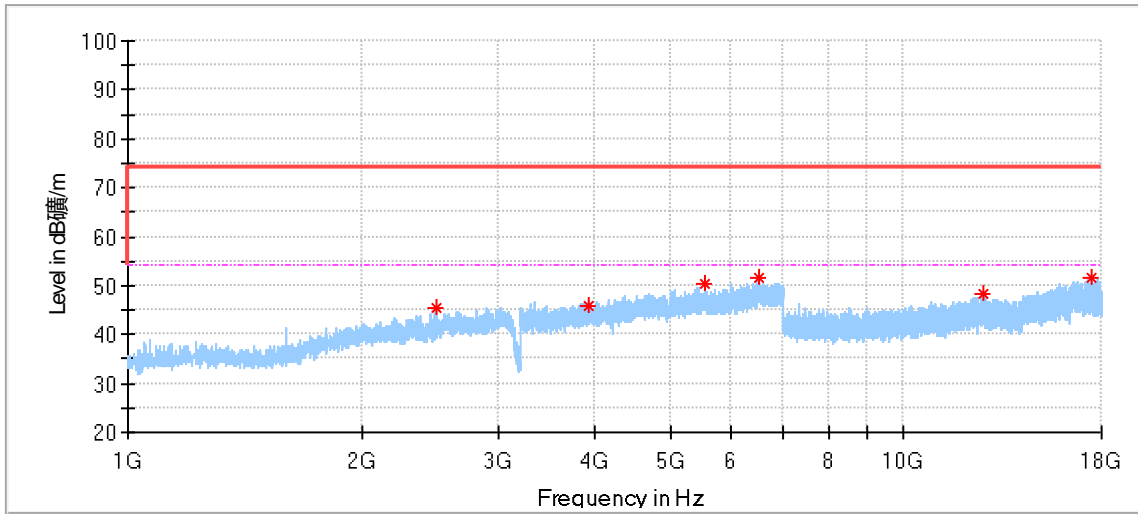

Frequency (MHz)	MaxPeak (dBµV/m)	Limit (dBµV/m)	Margin (dB)	Height (cm)	Pol	Azimuth (deg)	Corr. (dB/m)
2492.000000	45.40	74.00	28.60	150.0	H	157.0	-3.4
3920.000000	45.79	74.00	28.21	150.0	H	135.0	0.7
5558.500000	50.43	74.00	23.57	150.0	H	123.0	2.7
6493.500000	51.47	74.00	22.53	150.0	H	336.0	6.6
12660.000000	48.41	74.00	25.59	150.0	H	314.0	9.8
17477.500000	51.55	74.00	22.45	150.0	H	259.0	16.9

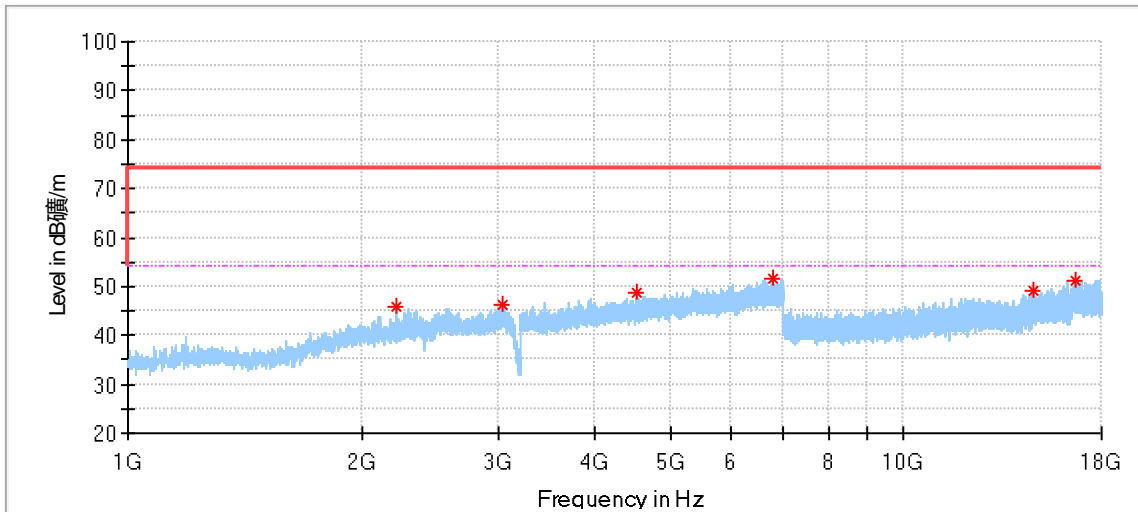

Frequency (MHz)	MaxPeak (dBµV/m)	Limit (dBµV/m)	Margin (dB)	Height (cm)	Pol	Azimuth (deg)	Corr. (dB/m)
2222.000000	45.75	74.00	28.25	150.0	V	199.0	-4.8
3037.500000	46.18	74.00	27.82	150.0	V	210.0	-1.1
4537.500000	48.60	74.00	25.40	150.0	V	282.0	2.9
6767.000000	51.53	74.00	22.47	150.0	V	103.0	6.6
14722.000000	49.31	74.00	24.69	150.0	V	170.0	11.5
16680.500000	51.07	74.00	22.93	150.0	V	170.0	16.6

802.11N40 Modulation 2422MHz Test Result

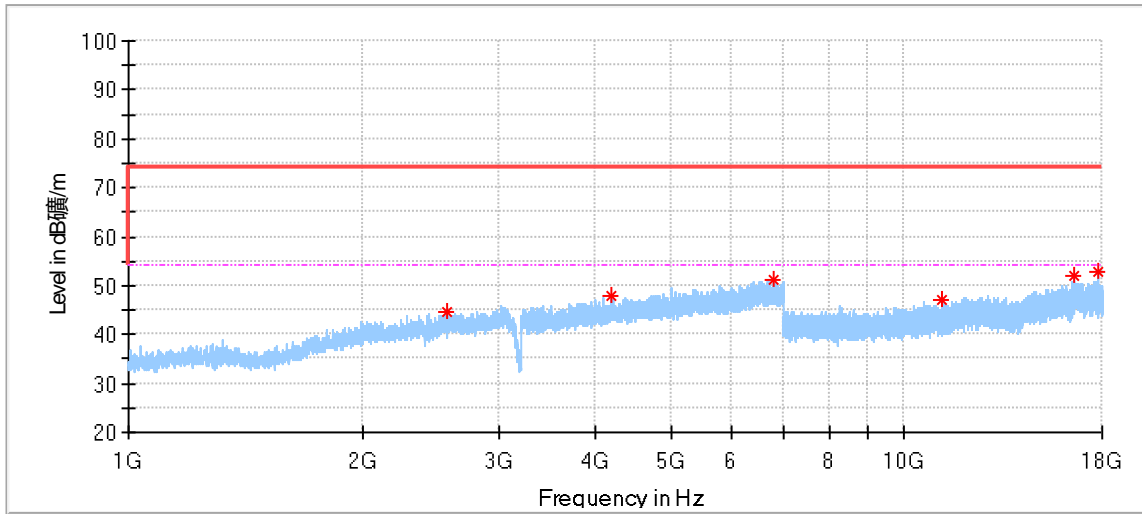

Frequency (MHz)	MaxPeak (dBµV/m)	Limit (dBµV/m)	Margin (dB)	Height (cm)	Pol	Azimuth (deg)	Corr. (dB/m)
2570.500000	44.73	74.00	29.27	150.0	H	329.0	-3.1
4200.500000	47.82	74.00	26.18	150.0	H	52.0	2.2
6780.500000	51.29	74.00	22.71	150.0	H	71.0	6.5
11215.000000	46.94	74.00	27.06	150.0	H	119.0	8.2
16596.500000	51.93	74.00	22.07	150.0	H	258.0	16.1
17772.500000	52.65	74.00	21.35	150.0	H	31.0	17.6

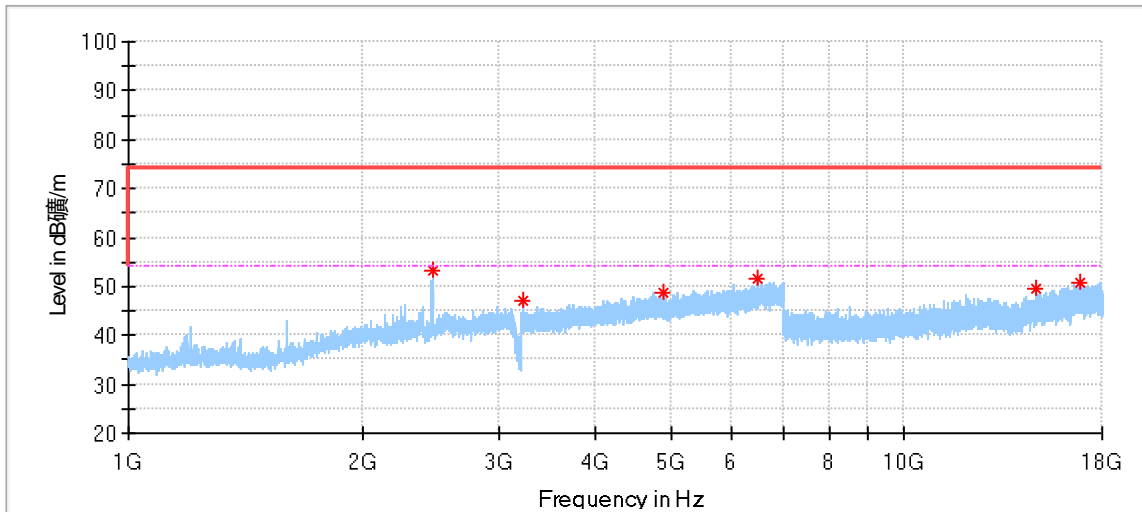

Frequency (MHz)	MaxPeak (dBµV/m)	Limit (dBµV/m)	Margin (dB)	Height (cm)	Pol	Azimuth (deg)	Corr. (dB/m)
2464.500000	53.23	74.00	20.77	150.0	V	179.0	-3.5
3221.500000	46.93	74.00	27.07	150.0	V	245.0	-1.3
4890.000000	48.63	74.00	25.37	150.0	V	30.0	2.7
6459.000000	51.53	74.00	22.47	150.0	V	233.0	6.1
14749.000000	49.48	74.00	24.52	150.0	V	118.0	11.7
16859.000000	50.62	74.00	23.38	150.0	V	154.0	16.9

802.11N40 Modulation 2437MHz Test Result

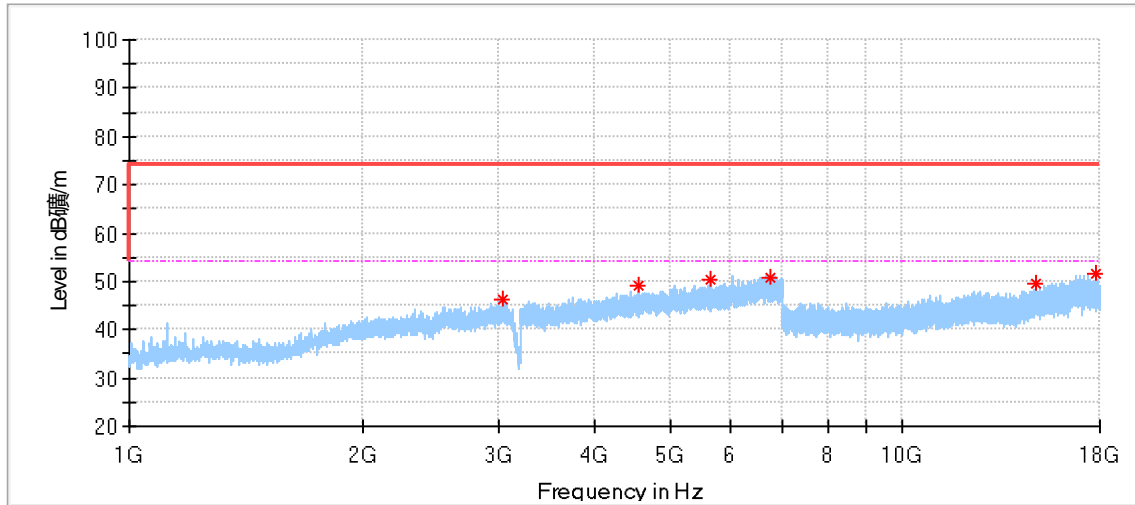

Frequency (MHz)	MaxPeak (dBµV/m)	Limit (dBµV/m)	Margin (dB)	Height (cm)	Pol	Azimuth (deg)	Corr. (dB/m)
3033.500000	46.31	74.00	27.69	150.0	H	355.0	-1.1
4546.000000	48.95	74.00	25.05	150.0	H	285.0	2.9
5661.000000	50.41	74.00	23.59	150.0	H	252.0	3.2
6739.500000	50.90	74.00	23.10	150.0	H	183.0	6.5
14912.000000	49.61	74.00	24.39	150.0	H	121.0	12.1
17746.000000	51.62	74.00	22.38	150.0	H	70.0	17.8

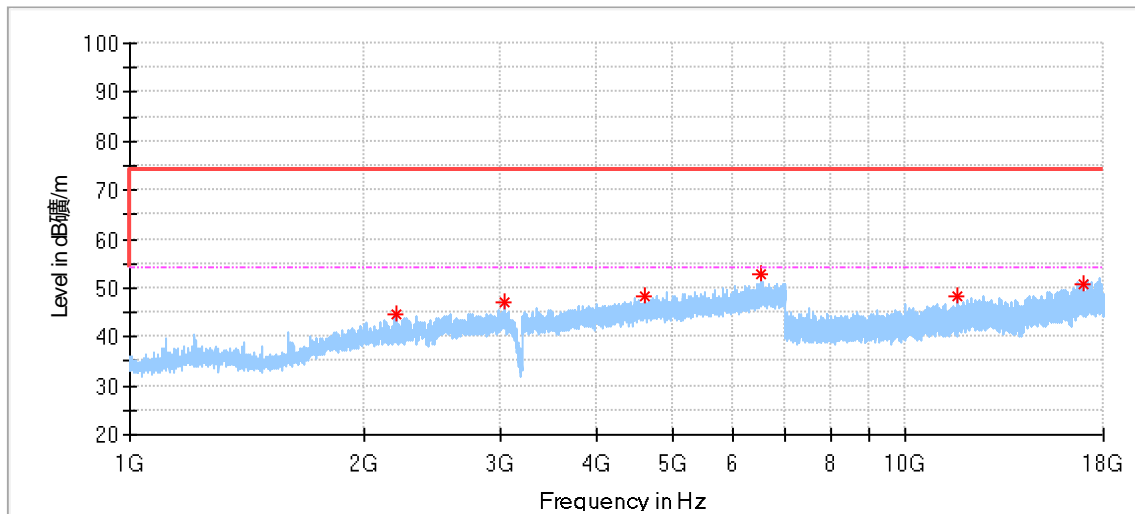

Frequency (MHz)	MaxPeak (dBµV/m)	Limit (dBµV/m)	Margin (dB)	Height (cm)	Pol	Azimuth (deg)	Corr. (dB/m)
2210.500000	44.42	74.00	29.58	150.0	V	215.0	-4.8
3048.000000	46.88	74.00	27.12	150.0	V	240.0	-1.1
4624.000000	48.38	74.00	25.62	150.0	V	240.0	2.8
6499.500000	52.88	74.00	21.12	150.0	V	93.0	6.6
11633.000000	48.45	74.00	25.55	150.0	V	334.0	9.0
16952.500000	50.64	74.00	23.36	150.0	V	6.0	16.5

802.11N40 Modulation 2452MHz Test Result

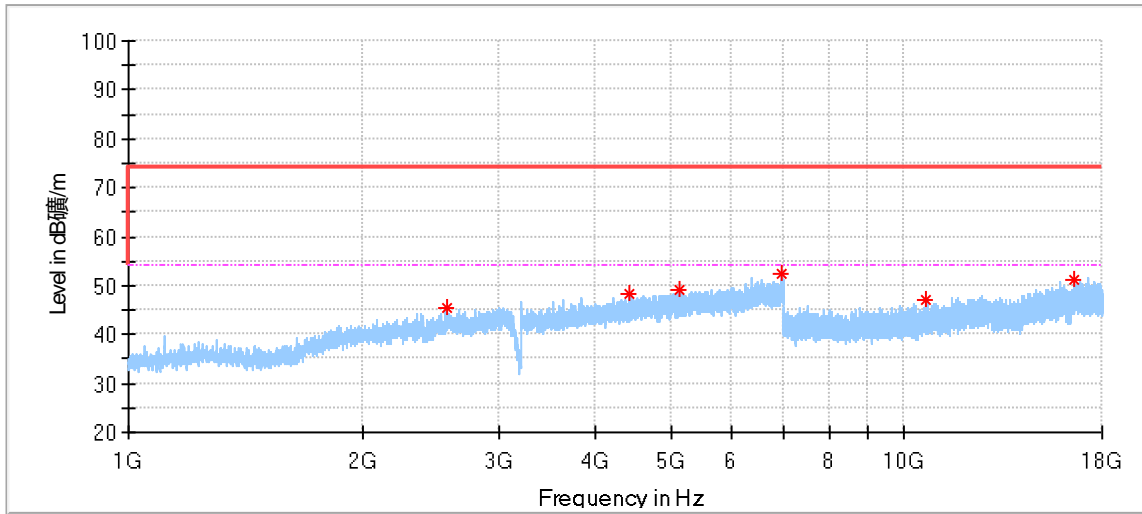

Frequency (MHz)	MaxPeak (dBµV/m)	Limit (dBµV/m)	Margin (dB)	Height (cm)	Pol	Azimuth (deg)	Corr. (dB/m)
2574.000000	45.50	74.00	28.50	150.0	H	119.0	-3.1
4419.500000	48.25	74.00	25.75	150.0	H	59.0	2.3
5124.000000	49.23	74.00	24.77	150.0	H	244.0	1.7
6933.500000	52.22	74.00	21.78	150.0	H	286.0	6.8
10634.500000	47.14	74.00	26.86	150.0	H	65.0	8.2
16585.000000	51.31	74.00	22.69	150.0	H	253.0	16.0

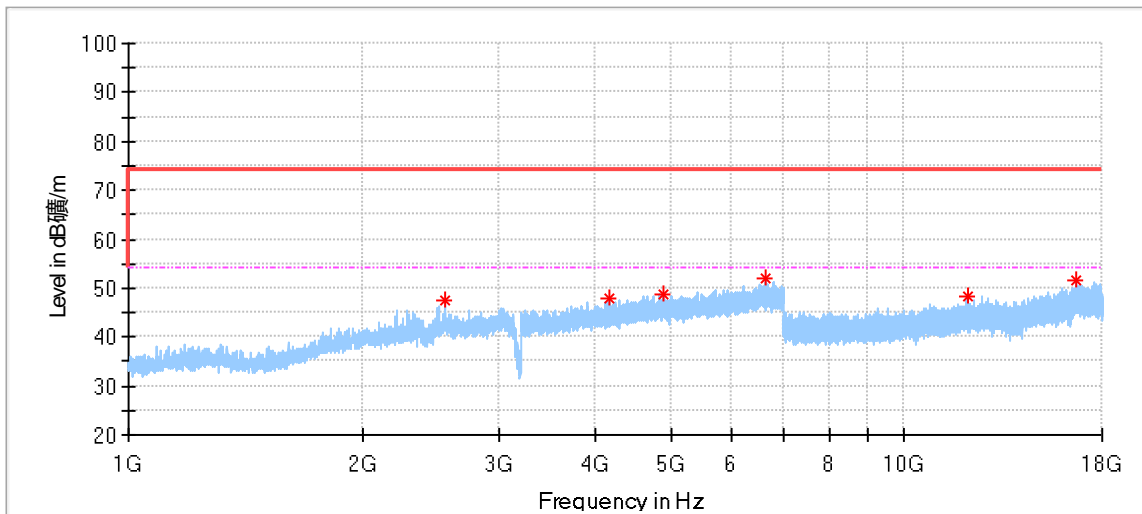

Frequency (MHz)	MaxPeak (dBµV/m)	Limit (dBµV/m)	Margin (dB)	Height (cm)	Pol	Azimuth (deg)	Corr. (dB/m)
2556.000000	47.29	74.00	26.71	150.0	V	213.0	-3.3
4168.500000	47.96	74.00	26.04	150.0	V	5.0	1.7
4892.500000	48.54	74.00	25.46	150.0	V	236.0	2.7
6646.000000	52.05	74.00	21.95	150.0	V	111.0	6.8
12097.500000	48.27	74.00	25.73	150.0	V	297.0	9.8
16701.000000	51.41	74.00	22.59	150.0	V	121.0	16.6

Remark:

- (1) Data of measurement within this frequency range shown "--" in the table above means the reading of emissions are the noise floor or attenuated more than 10dB below the permissible limits or the field strength is too small to be measured.
- (2) Level=Reading Level + Correction Factor
Above 1GHz: Corrector factor = Antenna Factor + Cable Loss- Amplifier Gain
Below 1GHz: Corrector factor = Antenna Factor + Cable Loss
(The Reading Level is recorded by software which is not shown in the sheet)

10 Test Equipment List

Radiated Emission Test

Description	Manufacturer	Model no.	Serial no.	cal. due date
EMI Test Receiver	Rohde & Schwarz	ESR 26	101269	2020-6-28
Trilog Super Broadband Test Antenna	Schwarzbeck	VULB 9163	707	2020-6-28
Horn Antenna	Rohde & Schwarz	HF907	102294	2020-6-22
Loop Antenna	Rohde & Schwarz	HFH2-Z2	100398	2020-7-7
Pre-amplifier	Rohde & Schwarz	SCU 18	102230	2020-6-28
Signal Generator	Rohde & Schwarz	SMY01	839369/005	2020-6-28
Attenuator	Agilent	8491A	MY39264334	2020-6-28
3m Semi-anechoic chamber	TDK	9X6X6	----	2020-7-7
Test software	Rohde & Schwarz		Version 9.15.00	N/A

TS8997 Test System

DESCRIPTION	MANUFACTURER	MODEL NO.	SERIAL NO.	CAL. DUE DATE
Signal Generator	Rohde & Schwarz	SMB100A	108272	2020-6-28
Vector Signal Generator	Rohde & Schwarz	SMBV100A	262825	2020-6-28
Signal Analyzer	Rohde & Schwarz	FSV40	101030	2020-6-28
Vector Signal Generator	Rohde & Schwarz	SMU 200A	105324	2020-6-28
RF Switch Module	Rohde & Schwarz	OSP120/OSP-B157	101226/100851	2020-6-28
Power Splitter	Weinschel	1580	SC319	2020-7-7
10dB Attenuator	Weinschel	4M-10	43152	2020-7-6
10dB Attenuator	R&S	DNF	DNF-001	2020-6-28
10dB Attenuator	R&S	DNF	DNF-002	2020-6-28
10dB Attenuator	R&S	DNF	DNF-003	2020-6-28
Test software	Rohde & Schwarz	EMC32	Version 10.38.00	N/A

Conducted Emission Test

Description	Manufacturer	Model no.	Serial no.	cal. due date
EMI Test Receiver	Rohde & Schwarz	ESR 3	101782	2020-6-28
LISN	Rohde & Schwarz	ENV4200	100249	2020-6-28
LISN	Rohde & Schwarz	ENV216	100326	2020-6-28
Attenuator	Shanghai Huaxiang	TS2-26-3	080928189	2020-6-28
Test software	Rohde & Schwarz	EMC32	Version 9.15.00	N/A

11 System Measurement Uncertainty

For a 95% confidence level, the measurement expanded uncertainties for defined systems, in accordance with the recommendations of ISO 17025 were:

System Measurement Uncertainty

System Measurement Uncertainty	
Test Items	Extended Uncertainty
Uncertainty for Conducted Emission 150kHz-30MHz (for test using High Voltage Probe TK9420(VT9420))	3.21 dB
Uncertainty for Radiated Spurious Emission 25MHz-3000MHz	Horizontal: 4.91dB; Vertical: 4.89dB;
Uncertainty for Radiated Spurious Emission 3000MHz-18000MHz	Horizontal: 4.80dB; Vertical: 4.79dB;
Uncertainty for Radiated Spurious Emission 18000MHz-40000MHz	Horizontal: 4.89dB; Vertical: 4.87dB;
Uncertainty for Conducted RF test with TS 8997	RF Power Conducted: 1.16dB Frequency test involved: 0.6x10 ⁻⁷ or 1%