

FCC Radio Test Report

FCC ID: 2AIMRMDZ16AB

This report concerns (check one): Original Grant Class I Change Class II Change

Project No. : 1605C248
Equipment : MI BOX
Model Name : MDZ-16-AB
Applicant : Beijing Xiaomi Electronics Co.,Ltd
Address : Room 707,7F,Building 5,No 58,JinghaiWulu Road ,Beijing economic and Technological Development Zone

Date of Receipt : May 27, 2016
Date of Test : May 27, 2016 ~ Jul. 04, 2016
Issued Date : Jul. 05, 2016
Tested by : BTL Inc.

Testing Engineer :

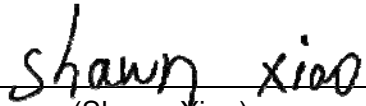
(Shawn Xiao)

Technical Manager :

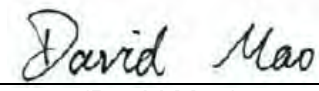
(David Mao)

Authorized Signatory :

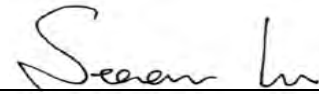
(Steven Lu)

B T L I N C .

No.3, Jinshagang 1st Road, Shixia, Dalang Town, Dongguan,
Guangdong, China.

TEL: +86-769-8318-3000 FAX: +86-769-8319-6000

Declaration

BTL represents to the client that testing is done in accordance with standard procedures as applicable and that test instruments used has been calibrated with standards traceable to international standard(s) and/or national standard(s).

BTL's reports apply only to the specific samples tested under conditions. It is manufacture's responsibility to ensure that additional production units of this model are manufactured with the identical electrical and mechanical components. **BTL** shall have no liability for any declarations, inferences or generalizations drawn by the client or others from **BTL** issued reports.

BTL's report must not be used by the client to claim product certification, approval, or endorsement by NVLAP, NIST, or any agency of the Federal Government.

This report is the confidential property of the client. As a mutual protection to the clients, the public and **BTL-self**, extracts from the test report shall not be reproduced except in full with **BTL's** authorized written approval.

BTL's laboratory quality assurance procedures are in compliance with the **ISO Guide 17025** requirements, and accredited by the conformity assessment authorities listed in this test report.

Limitation

For the use of the authority's logo is limited unless the Test Standard(s)/Scope(s)/Item(s) mentioned in this test report is (are) included in the conformity assessment authorities acceptance respective.

Table of Contents	Page
1 . CERTIFICATION	6
2 . SUMMARY OF TEST RESULTS	7
2.1 TEST FACILITY	8
2.2 MEASUREMENT UNCERTAINTY	8
3 . GENERAL INFORMATION	9
3.1 GENERAL DESCRIPTION OF EUT	9
3.2 DESCRIPTION OF TEST MODES	10
3.3 TABLE OF PARAMETERS OF TEXT SOFTWARE SETTING	11
3.4 BLOCK DIAGRAM SHOWING THE CONFIGURATION OF SYSTEM TESTED	12
3.5 DESCRIPTION OF SUPPORT UNITS	12
4 . EMC EMISSION TEST	13
4.1 CONDUCTED EMISSION MEASUREMENT	13
4.1.1 POWER LINE CONDUCTED EMISSION LIMITS	13
4.1.2 TEST PROCEDURE	13
4.1.3 DEVIATION FROM TEST STANDARD	13
4.1.4 TEST SETUP	14
4.1.5 EUT OPERATING CONDITIONS	14
4.1.6 EUT TEST CONDITIONS	14
4.1.7 TEST RESULTS	14
4.2 RADIATED EMISSION MEASUREMENT	15
4.2.1 RADIATED EMISSION LIMITS	15
4.2.2 TEST PROCEDURE	16
4.2.3 DEVIATION FROM TEST STANDARD	16
4.2.4 TEST SETUP	17
4.2.5 EUT OPERATING CONDITIONS	18
4.2.6 EUT TEST CONDITIONS	18
4.2.7 TEST RESULTS (9KHZ TO 30MHZ)	19
4.2.8 TEST RESULTS (30MHZ TO 1000 MHZ)	19
4.2.9 TEST RESULTS (ABOVE 1000 MHZ)	19
5 . BANDWIDTH TEST	20
5.1 APPLIED PROCEDURES	20
5.1.1 TEST PROCEDURE	20
5.1.2 DEVIATION FROM STANDARD	20
5.1.3 TEST SETUP	20
5.1.4 EUT OPERATION CONDITIONS	20
5.1.5 EUT TEST CONDITIONS	20
5.1.6 TEST RESULTS	20
6 . MAXIMUM PEAK CONDUCTED OUTPUT POWER TEST	21

Table of Contents	Page
6.1 APPLIED PROCEDURES / LIMIT	21
6.1.1 TEST PROCEDURE	21
6.1.2 DEVIATION FROM STANDARD	21
6.1.3 TEST SETUP	21
6.1.4 EUT OPERATION CONDITIONS	21
6.1.5 EUT TEST CONDITIONS	21
6.1.6 TEST RESULTS	21
7 . ANTENNA CONDUCTED SPURIOUS EMISSION	22
7.1 APPLIED PROCEDURES / LIMIT	22
7.1.1 TEST PROCEDURE	22
7.1.2 DEVIATION FROM STANDARD	22
7.1.3 TEST SETUP	22
7.1.4 EUT OPERATION CONDITIONS	22
7.1.5 EUT TEST CONDITIONS	22
7.1.6 TEST RESULTS	22
8 . POWER SPECTRAL DENSITY TEST	23
8.1 APPLIED PROCEDURES / LIMIT	23
8.1.1 TEST PROCEDURE	23
8.1.2 DEVIATION FROM STANDARD	23
8.1.3 TEST SETUP	23
8.1.4 EUT OPERATION CONDITIONS	23
8.1.5 EUT TEST CONDITIONS	23
8.1.6 TEST RESULTS	23
9 . MEASUREMENT INSTRUMENTS LIST	24
10 . EUT TEST PHOTO	26
ATTACHMENT A - CONDUCTED EMISSION	30
ATTACHMENT B - RADIATED EMISSION (9KHZ TO 30MHZ)	35
ATTACHMENT C - RADIATED EMISSION (30MHZ TO 1000MHZ)	38
ATTACHMENT D - RADIATED EMISSION (ABOVE 1000MHZ)	51
ATTACHMENT E - BANDWIDTH	100
ATTACHMENT F – MAXIMUM PEAK CONDUCTED OUTPUT POWER	109
ATTACHMENT G - ANTENNA CONDUCTED SPURIOUS EMISSION	111
ATTACHMENT H - POWER SPECTRAL DENSITY	124

REPORT ISSUED HISTORY

Issued No.	Description	Issued Date
BTL-FCCP-3-1605C248	Original Issue.	Jul. 05, 2016

1. CERTIFICATION

Equipment : MI BOX
Brand Name : MI
Model Name : MDZ-16-AB
Applicant : Beijing Xiaomi Electronics Co.,Ltd
Manufacturer : Beijing Xiaomi Electronics Co.,Ltd
Address : Room 707,7F,Building 5,No 58,JinghaiWulu Road ,Beijing economic and
Technological Development Zone
Factory : TCL Technoly Electronics (Huizhou) Co.,Ltd.
Address : 37, Zhongkai Hi-tech Development Zone, Huizhou Guangdong 516006,
P.R.China
Date of Test : May 27, 2016 ~ Jul. 04, 2016
Test Sample : Engineering Sample
Standard(s) : FCC Part15, Subpart C:(15.247) / ANSI C63.10-2013

The above equipment has been tested and found compliance with the requirement of the relative standards by BTL Inc.

The test data, data evaluation, and equipment configuration contained in our test report (Ref No. BTL-FCCP-3-1605C248) were obtained utilizing the test procedures, test instruments, test sites that has been accredited by the Authority of TAF according to the ISO-17025 quality assessment standard and technical standard(s).

2. SUMMARY OF TEST RESULTS

Test procedures according to the technical standard(s):

Applied Standard(s): FCC Part15 (15.247) , Subpart C				
Standard(s)	Section	Test Item	Judgment	Remark
15.207		Conducted Emission	PASS	
15.247(d)		Antenna conducted Spurious Emission	PASS	
15.247(a)(2)		6dB Bandwidth	PASS	
15.247(b)(3)		Peak Output Power	PASS	
15.247(e)		Power Spectral Density	PASS	
15.203		Antenna Requirement	PASS	
15.209/15.205		Transmitter Radiated Emissions	PASS	

NOTE:

(1) "N/A" denotes test is not applicable in this test report.

2.1 TEST FACILITY

The test facilities used to collect the test data in this report is at the location of No.3,Jinshagang 1st Road, Shixia, Dalang Town, Dongguan, Guangdong, China.
BTL's test firm number for FCC: 319330

2.2 MEASUREMENT UNCERTAINTY

Where relevant, the following measurement uncertainty levels have been estimated for tests performed on the EUT as specified in CISPR 16-4-2. The BTL measurement uncertainty is less than the CISPR 16-4-2 U_{CISPR} requirement.

The reported uncertainty of measurement $y \pm U$, where expanded uncertainty U is based on a standard uncertainty multiplied by a coverage factor of $k=2$, providing a level of confidence of approximately 95 %.

A. Conducted Measurement:

Test Site	Method	Measurement Frequency Range	U, (dB)
DG-C02	CISPR	150 KHz ~ 30MHz	2.32

B. Radiated Measurement:

Test Site	Method	Measurement Frequency Range	Ant. H / V	U, (dB)
DG-CB03	CISPR	9KHz~30MHz	V	3.79
		9KHz~30MHz	H	3.57
		30MHz ~ 200MHz	V	3.82
		30MHz ~ 200MHz	H	3.78
		200MHz ~ 1,000MHz	V	4.10
		200MHz ~ 1,000MHz	H	4.06
		1GHz~18GHz	V	3.12
		1GHz~18GHz	H	3.68
		18GHz~40GHz	V	4.15
		18GHz~40GHz	H	4.14

Note: Unless specifically mentioned, the uncertainty of measurement has not been taken into account to declare the compliance or non-compliance to the specification.

3. GENERAL INFORMATION

3.1 GENERAL DESCRIPTION OF EUT

Equipment	MI BOX	
Brand Name	MI	
Model Name	MDZ-16-AB	
Model Difference	N/A	
Product Description	Operation Frequency	2412~2462 MHz
	Modulation Technology	802.11b:DSSS 802.11g:OFDM 802.11n:OFDM
	Bit Rate of Transmitter	802.11b: 11/5.5/2/1 Mbps 802.11g: 54/48/36/24/18/12/9/6 Mbps 802.11n up to 300 Mbps
	Output Power (Max.)	802.11b: 19.74dBm 802.11g: 19.99dBm 802.11n(20MHz): 19.36dBm 802.11n(40MHz): 19.99dBm
Power Source	DC Voltage supplied from AC/DC adapter. #1 Brand /Model: MI / AY11BA-AF0522102 #2 Brand /Model: MI / GSCU2100S05V215S	
Power Rating	#1 I/P: 100-240V~0.5A 50/60Hz O/P:5.2V $\overline{\overline{=}}$ 2.1A #2 I/P: 100-240V~0.3A 50/60Hz O/P:5.2V $\overline{\overline{=}}$ 2.1A	

Note:

- For a more detailed features description, please refer to the manufacturer's specifications or the user's manual.
- Channel List:

CH01 – CH11 for 802.11b, 802.11g, 802.11n(20MHz) CH03 – CH09 for 802.11n(40MHz)							
Channel	Frequency (MHz)	Channel	Frequency (MHz)	Channel	Frequency (MHz)	Channel	Frequency (MHz)
01	2412	04	2427	07	2442	10	2457
02	2417	05	2432	08	2447	11	2462
03	2422	06	2437	09	2452		

3. Table for Filed Antenna

Ant.	Brand	Model Name	Antenna Type	Connector	Gain (dBi)
1	MI	ANT_M12	PCB	N/A	3.3

3.2 DESCRIPTION OF TEST MODES

To investigate the maximum EMI emission characteristics generated from EUT, the test system was pre-scanning tested based on the consideration of following EUT operation mode or test configuration mode which possibly have effect on EMI emission level. Each of these EUT operation mode(s) or test configuration mode(s) mentioned above was evaluated respectively.

Pretest Mode	Description
Mode 1	TX B MODE CHANNEL 01/06/11
Mode 2	TX G MODE CHANNEL 01/06/11
Mode 3	TX N-20MHZ MODE CHANNEL 01/06/11
Mode 4	TX N-40MHZ MODE CHANNEL 03/06/09
Mode 5	Normal Link

The EUT system operated these modes were found to be the worst case during the pre-scanning test as following:

For Conducted Test	
Final Test Mode	Description
Mode 5	TX MODE

For Radiated Test	
Final Test Mode	Description
Mode 1	TX B MODE CHANNEL 01/06/11
Mode 2	TX G MODE CHANNEL 01/06/11
Mode 3	TX N-20MHZ MODE CHANNEL 01/06/11
Mode 4	TX N-40MHZ MODE CHANNEL 03/06/09

Note:

- (1) The measurements are performed at the high, middle, low available channels.
- (2) 802.11b mode: DBPSK (1Mbps)
 802.11g mode: OFDM (6Mbps)
 802.11n HT20 mode : BPSK (6.5Mbps)
 802.11n HT40 mode : BPSK (13.5Mbps)
 For radiated emission tests, the highest output powers were set for final test.
- (3) For radiated below 1G test, the 802.11b is found to be the worst case and recorded.
- (4) The EUT was programmed to be in continuously transmitting mode and the transmit duty cycle is not less than 98%.

3.3 TABLE OF PARAMETERS OF TEXT SOFTWARE SETTING

During testing, channel & power controlling software provided by the customer was used to control the operating channel as well as the output power level. The RF output power selection is for the setting of RF output power expected by the customer and is going to be fixed on the firmware of the final end product power parameters of WLAN

Test software version	N/A		
Frequency (MHz)	2412	2437	2462
802.11b	17	18	18
802.11g	10	10	10
802.11n (20MHz)	10	10	10
Frequency	2422	2437	2452
802.11n (40MHz)	10	10	10

3.4 BLOCK DIAGRAM SHOWING THE CONFIGURATION OF SYSTEM TESTED

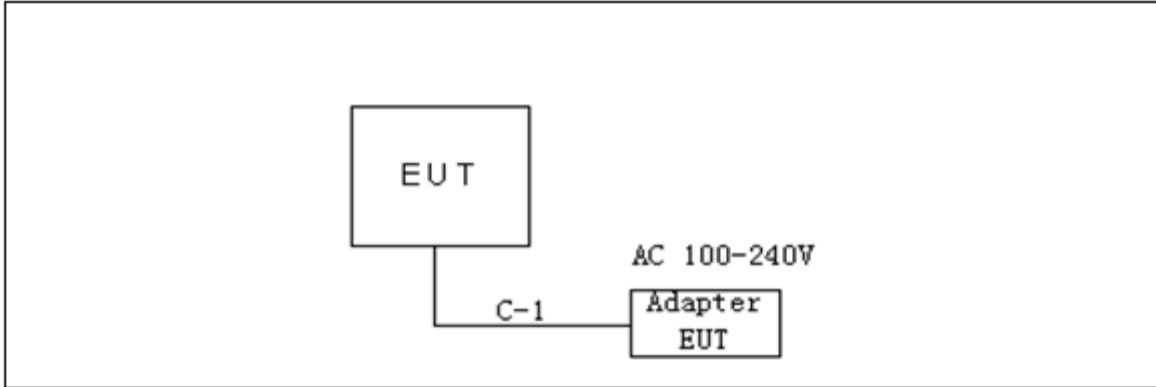

3.5 DESCRIPTION OF SUPPORT UNITS

The EUT has been tested as an independent unit together with other necessary accessories or support units. The following support units or accessories were used to form a representative test configuration during the tests.

Item	Equipment	Mfr/Brand	Model/Type No.	FCC ID	Series No.
-	-	-	-	-	-

Item	Shielded Type	Ferrite Core	Length	Note
C-1	NO	NO	1m	DC Cable

4. EMC EMISSION TEST

4.1 CONDUCTED EMISSION MEASUREMENT

4.1.1 POWER LINE CONDUCTED EMISSION LIMITS (Frequency Range 150KHz-30MHz)

Frequency of Emission (MHz)	Conducted Limit (dB μ V)	
	Quasi-peak	Average
0.15 -0.50	66 to 56*	56 to 46*
0.50 -5.0	56	46
5.0 -30.0	60	50

Note:

- (1) The limit of " * " decreases with the logarithm of the frequency
- (2) The test result calculated as following:
 Measurement Value = Reading Level + Correct Factor
 Correct Factor = Insertion Loss + Cable Loss + Attenuator Factor(if use)
 Margin Level = Measurement Value - Limit Value

The following table is the setting of the receiver

Receiver Parameters	Setting
Attenuation	10 dB
Start Frequency	0.15 MHz
Stop Frequency	30 MHz
IF Bandwidth	9 KHz

4.1.2 TEST PROCEDURE

- a. The EUT was placed 0.8 meters from the horizontal ground plane with EUT being connected to the power mains through a line impedance stabilization network (LISN). All other support equipments powered from additional LISN(s). The LISN provide 50 Ohm/ 50uH of coupling impedance for the measuring instrument.
- b. Interconnecting cables that hang closer than 40 cm to the ground plane shall be folded back and forth in the center forming a bundle 30 to 40 cm long.
- c. I/O cables that are not connected to a peripheral shall be bundled in the center. The end of the cable may be terminated, if required, using the correct terminating impedance. The overall length shall not exceed 1 m.
- d. LISN at least 80 cm from nearest part of EUT chassis.
- e. For the actual test configuration, please refer to the related Item –EUT Test Photos.

4.1.3 DEVIATION FROM TEST STANDARD

No deviation

4.1.4 TEST SETUP

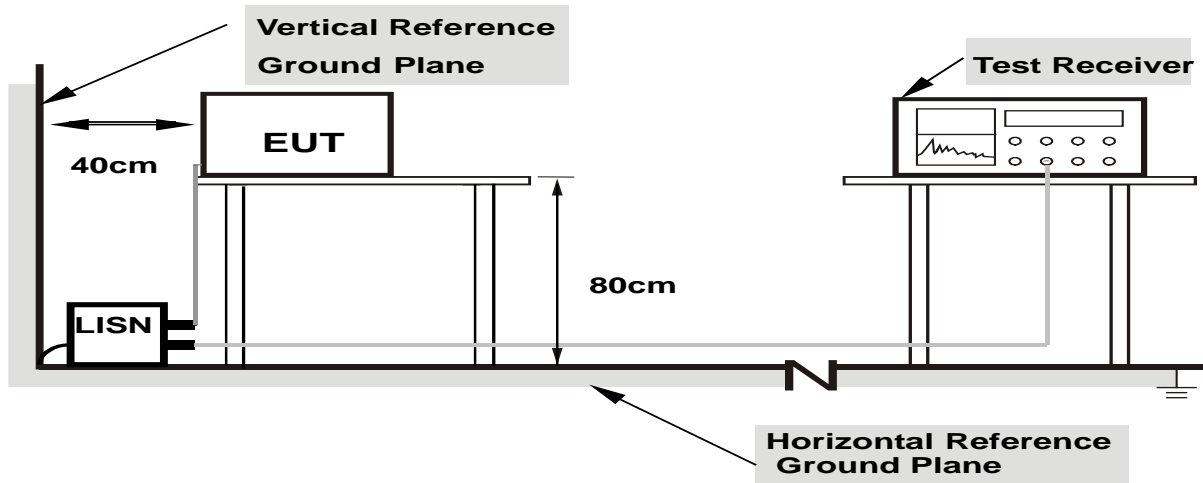

- Note:**
- 1. Support units were connected to second LISN.
 - 2. Both of LISNs (AMN) are 80 cm from EUT and at least 80 from other units and other metal planes

4.1.5 EUT OPERATING CONDITIONS

The EUT was placed on the test table and programmed in normal function.

4.1.6 EUT TEST CONDITIONS

Temperature: 25°C Relative Humidity: 55% Test Voltage: AC 120V/60Hz

4.1.7 TEST RESULTS

Please refer to the Attachment A.

4.2 RADIATED EMISSION MEASUREMENT

4.2.1 RADIATED EMISSION LIMITS

In case the emission fall within the restricted band specified on 15.205(a), then the 15.209(a) limit in the table below has to be followed.

LIMITS OF RADIATED EMISSION MEASUREMENT (9KHz-1000MHz)

Frequency (MHz)	Field Strength (microvolts/meter)	Measurement Distance (meters)
0.009~0.490	2400/F(KHz)	300
0.490~1.705	24000/F(KHz)	30
1.705~30.0	30	30
30~88	100	3
88~216	150	3
216~960	200	3
960~1000	500	3

LIMITS OF RADIATED EMISSION MEASUREMENT (Above 1000MHz)

Frequency (MHz)	(dBuV/m) (at 3 meters)	
	PEAK	AVERAGE
Above 1000	74	54

Notes:

- (1) The limit for radiated test was performed according to FCC PART 15C.
- (2) The tighter limit applies at the band edges.
- (3) Emission level (dBuV/m)=20log Emission level (uV/m).
- (4) The test result calculated as following:
 Measurement Value = Reading Level + Correct Factor
 Correct Factor = Antenna Factor + Cable Loss - Amplifier Gain(if use)
 Margin Level = Measurement Value - Limit Value

Spectrum Parameter	Setting
Attenuation	Auto
Start Frequency	1000 MHz
Stop Frequency	10th carrier harmonic
RBW / VBW (Emission in restricted band)	1MHz / 3MHz for Peak, 1MHz / 1/T for Average

Receiver Parameter	Setting
Attenuation	Auto
Start ~ Stop Frequency	9KHz~90KHz for PK/AVG detector
Start ~ Stop Frequency	90KHz~110KHz for QP detector
Start ~ Stop Frequency	110KHz~490KHz for PK/AVG detector
Start ~ Stop Frequency	490KHz~30MHz for QP detector
Start ~ Stop Frequency	30MHz~1000MHz for QP detector

4.2.2 TEST PROCEDURE

- a. The measuring distance of at 3 m shall be used for measurements. The EUT was placed on the top of a rotating table 0.8 meter above the ground at a 3 meter semi-anechoic chamber. The table was rotated 360 degrees to determine the position of the highest radiation.(below 1GHz)
- b. The measuring distance of at 3 m shall be used for measurements. The EUT was placed on the top of a rotating table 1.5 meter above the ground at a 3 meter semi-anechoic chamber. The table was rotated 360 degrees to determine the position of the highest radiation.(above 1GHz)
- c. The height of the equipment or of the substitution antenna shall be 0.8m or 1.5m; the height of the test antenna shall vary between 1 m to 4 m. Both horizontal and vertical polarizations of the antenna are set to make the measurement.
- d. For each suspected emission, the EUT was arranged to its worst case and then the antenna was tuned to heights find the maximum reading (used Bore sight function).
- e. The receiver system was set to peak and average detect function and specified bandwidth with maximum hold mode when the test frequency is above 1GHz.
- f. The initial step in collecting conducted emission data is a receiver peak detector mode pre-scanning the measurement frequency range. Significant peaks are then marked and then Quasi Peak detector mode re-measured.
- g. All readings are Peak unless otherwise stated QP in column of Note. Peak denotes that the Peak reading compliance with the QP Limits and then QP Mode measurement didn't perform. (below 1GHz)
- h. All readings are Peak Mode value unless otherwise stated AVG in column of Note. If the Peak Mode Measured value compliance with the Peak Limits and lower than AVG Limits, the EUT shall be deemed to meet both Peak & AVG Limits and then only Peak Mode was measured, but AVG Mode didn't perform. (above 1GHz)
- i. For the actual test configuration, please refer to the related Item –EUT Test Photos.

4.2.3 DEVIATION FROM TEST STANDARD

No deviation

4.2.4 TEST SETUP

(A) Radiated Emission Test Set-Up Frequency Below 1 GHz

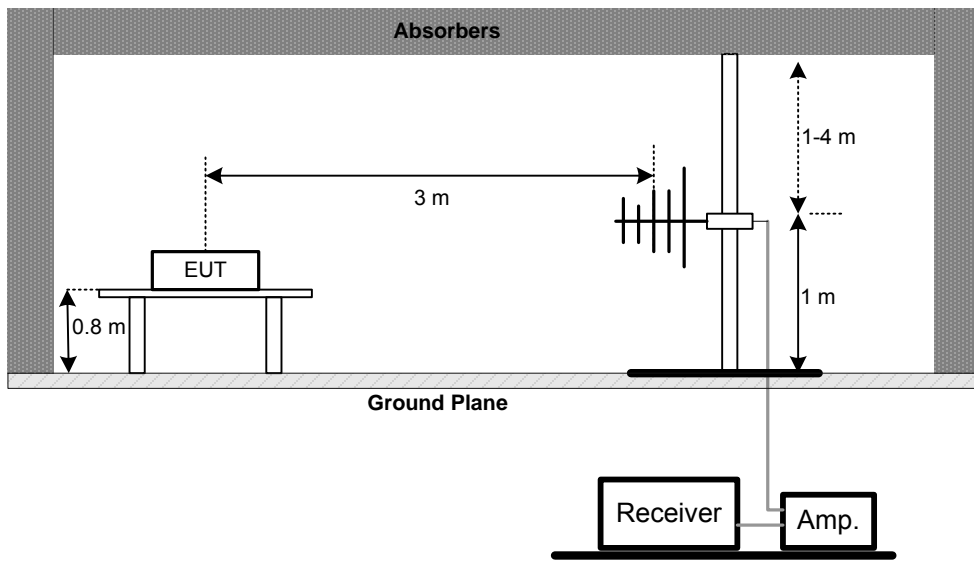

(B) Radiated Emission Test Set-Up Frequency Above 1 GHz

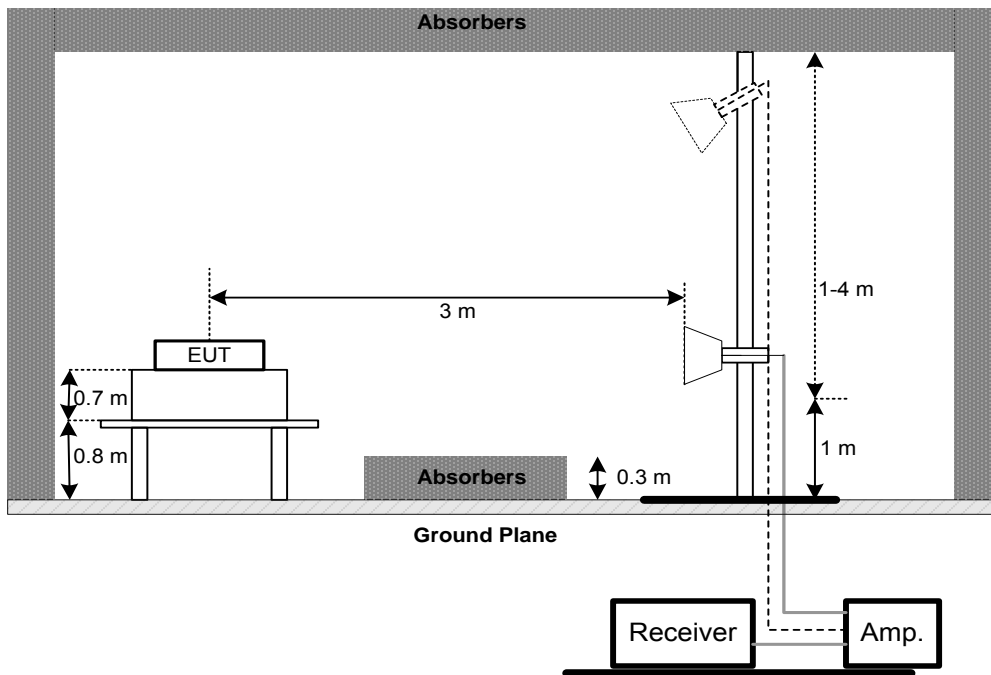

(C) For Radiated Emissions Below 30MHz

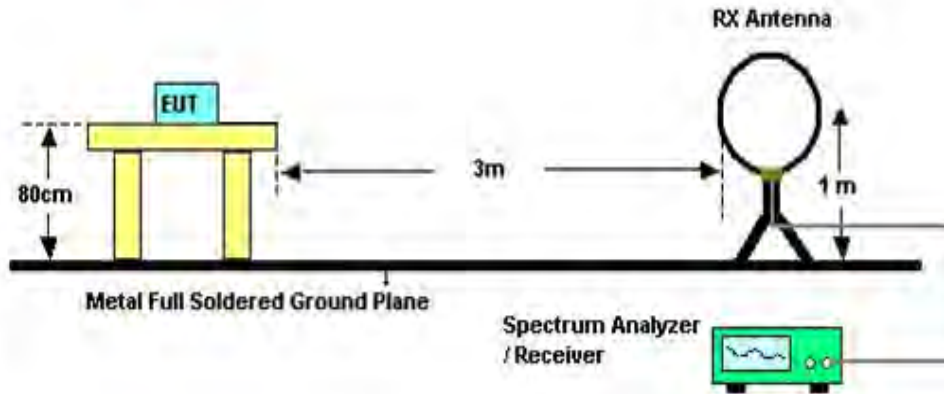

4.2.5 EUT OPERATING CONDITIONS

The EUT was programmed to be in continuously transmitting mode.

4.2.6 EUT TEST CONDITIONS

Temperature: 25°C Relative Humidity: 55% Test Voltage: AC 120V/60Hz

4.2.7 TEST RESULTS (9KHZ TO 30MHZ)

Please refer to the Attachment B

Remark:

- (1) The amplitude of spurious emissions which are attenuated by more than 20 dB below the permissible value has no need to be reported.
- (2) Distance extrapolation factor = $40 \log(\text{specific distance} / \text{test distance})$ (dB).
- (3) Limit line = specific limits (dBuV) + distance extrapolation factor.

4.2.8 TEST RESULTS (30MHZ TO 1000 MHZ)

Please refer to the Attachment C.

4.2.9 TEST RESULTS (ABOVE 1000 MHZ)

Please refer to the Attachment D.

Remark:

- (1) No limit: This is fundamental signal, the judgment is not applicable.
For fundamental signal judgment was referred to Peak output test.

5. BANDWIDTH TEST

5.1 APPLIED PROCEDURES

FCC Part15 (15.247) , Subpart C			
Section	Test Item	Frequency Range (MHz)	Result
15.247(a)(2)	Bandwidth	2400-2483.5	PASS

5.1.1 TEST PROCEDURE

- a. The EUT was directly connected to the spectrum analyzer and antenna output port as show in the block diagram below,
- b. Spectrum Setting: RBW= 100KHz, VBW=300KHz, Sweep time = 2.5 ms.

5.1.2 DEVIATION FROM STANDARD

No deviation.

5.1.3 TEST SETUP

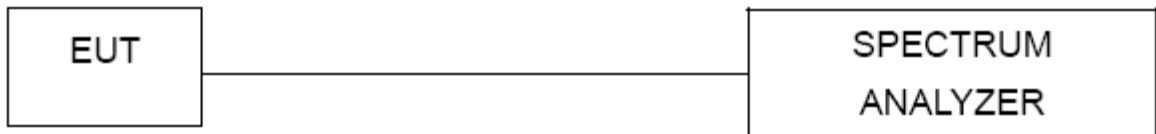

5.1.4 EUT OPERATION CONDITIONS

The EUT was programmed to be in continuously transmitting mode.

5.1.5 EUT TEST CONDITIONS

Temperature: 25°C Relative Humidity: 55% Test Voltage: AC 120V/60Hz

5.1.6 TEST RESULTS

Please refer to the Attachment E.

6. MAXIMUM PEAK CONDUCTED OUTPUT POWER TEST

6.1 APPLIED PROCEDURES / LIMIT

FCC Part15 (15.247) , Subpart C				
Section	Test Item	Limit	Frequency Range (MHz)	Result
15.247(b)(3)	Maximum Output Power	1 Watt or 30dBm	2400-2483.5	PASS

6.1.1 TEST PROCEDURE

- a. The EUT was directly connected to the power meter and antenna output port as show in the block diagram below,
- b. The maximum peak conducted output power was performed in accordance with method 9.1.2 of FCC KDB 558074 D01 DTS Meas Guidance v03r05.

6.1.2 DEVIATION FROM STANDARD

No deviation.

6.1.3 TEST SETUP



6.1.4 EUT OPERATION CONDITIONS

The EUT was programmed to be in continuously transmitting mode.

6.1.5 EUT TEST CONDITIONS

Temperature: 25°C Relative Humidity: 55% Test Voltage: AC 120V/60Hz

6.1.6 TEST RESULTS

Please refer to the Attachment F.

7. ANTENNA CONDUCTED SPURIOUS EMISSION

7.1 APPLIED PROCEDURES / LIMIT

In any 100 kHz bandwidth outside the frequency band in which the spread spectrum or digitally modulated device is operating, the RF power that is produced shall be at least 20 dB below that in the 100 kHz bandwidth within the band that contains the highest level of the desired power, based on either an RF conducted or a radiated measurement, provided that the transmitter demonstrates compliance with the peak conducted power limits.

7.1.1 TEST PROCEDURE

- a. The EUT was directly connected to the spectrum analyzer and antenna output port as show in the block diagram below,
- b. Spectrum Setting: RBW= 100KHz, VBW=300KHz, Sweep time = Auto.
- c. Offset=antenna gain+cable loss

7.1.2 DEVIATION FROM STANDARD

No deviation.

7.1.3 TEST SETUP

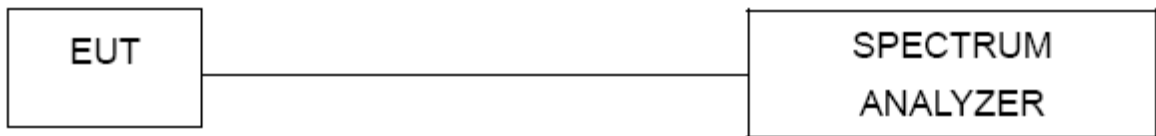

7.1.4 EUT OPERATION CONDITIONS

The EUT was programmed to be in continuously transmitting mode.

7.1.5 EUT TEST CONDITIONS

Temperature: 25°C Relative Humidity: 55% Test Voltage: AC 120V/60Hz

7.1.6 TEST RESULTS

Please refer to the Attachment G.

8. POWER SPECTRAL DENSITY TEST

8.1 APPLIED PROCEDURES / LIMIT

FCC Part15 (15.247) , Subpart C				
Section	Test Item	Limit	Frequency Range (MHz)	Result
15.247(e)	Power Spectral Density	8 dBm (in any 3KHz)	2400-2483.5	PASS

8.1.1 TEST PROCEDURE

- a. The EUT was directly connected to the spectrum analyzer and antenna output port as show in the block diagram below,
- b. Spectrum Setting: RBW=3KHz, VBW=10KHz, Sweep time = Auto.

8.1.2 DEVIATION FROM STANDARD

No deviation.

8.1.3 TEST SETUP

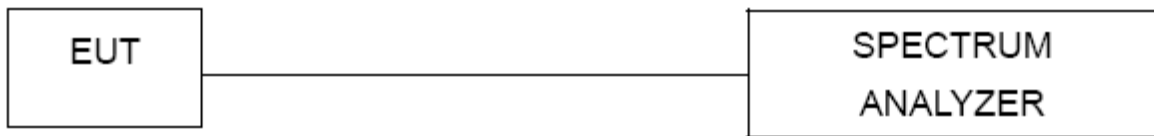

8.1.4 EUT OPERATION CONDITIONS

The EUT was programmed to be in continuously transmitting mode.

8.1.5 EUT TEST CONDITIONS

Temperature: 25°C Relative Humidity: 55% Test Voltage: AC 120V/60Hz

8.1.6 TEST RESULTS

Please refer to the Attachment H.

9. MEASUREMENT INSTRUMENTS LIST

Conducted Emission Measurement					
Item	Kind of Equipment	Manufacturer	Type No.	Serial No.	Calibrated until
1	LISN	EMCO	3816/2	0052765	Mar. 27, 2017
2	LISN	R&S	ENV216	101447	Mar. 27, 2017
3	Test Cable	emci	RG223(9KHz-30 MHz)	C_17	Mar. 10, 2017
4	EMI Test Receiver	R&S	ESCI	100382	Mar. 27, 2017
5	50Ω Terminator	SHX	TF2-3G-A	08122901	Mar. 27, 2017
6	Measurement Software	Farad	EZ-EMC Ver.NB-03A1-01	N/A	N/A

Radiated Emission Measurement					
Item	Kind of Equipment	Manufacturer	Type No.	Serial No.	Calibrated until
1	Antenna	Schwarzbeck	VULB9160	9160-3232	Mar. 27, 2017
2	Amplifier	HP	8447D	2944A09673	Nov. 09, 2016
3	Receiver	AGILENT	N9038A	MY52130039	Oct. 11, 2016
4	Test Cable	emci	LMR-400(30MHz-1GHz)	C-01	Jun. 27, 2017
5	Control	CT	SC100	N/A	N/A
6	Position Control	MF	MF-7802	MF780208416	N/A
7	Antenna	ETS	3115	00075789	Mar. 27, 2017
8	Amplifier	Agilent	8449B	3008A02274	Nov. 01, 2016
9	Receiver	AGILENT	N9038A	MY52130039	Oct. 11, 2016
10	Test Cable	emci	EMC104-SM-S M-10000(1GHz-26.5GHz)	C-68	Jun. 27, 2017
11	Controller	CT	SC100	N/A	N/A
12	Broad-Band Horn Antenna	Schwarzbeck	BBHA 9170	9170319	Apr. 23, 2017
13	Microwave Preamplifier With Adaptor	EMC INSTRUMENT	EMC2654045	980039 & HA01	Mar. 27, 2017
14	Active Loop Antenna	R&S	HFH2-Z2	830749/020	Sep. 07, 2016
15	Measurement Software	Farad	EZ-EMC Ver.NB-03A1-01	N/A	N/A

6dB Bandwidth Measurement					
Item	Kind of Equipment	Manufacturer	Type No.	Serial No.	Calibrated until
1	Spectrum Analyzer	R&S	FSP 40	100185	Oct. 11, 2016

Peak Output Power Measurement					
Item	Kind of Equipment	Manufacturer	Type No.	Serial No.	Calibrated until
1	P-series Power meter	Agilent	N1911A	MY45100473	Oct. 26, 2016
2	Wireband Power sensor	Agilent	N1921A	MY51100041	Oct. 26, 2016

Antenna Conducted Spurious Emission Measurement					
Item	Kind of Equipment	Manufacturer	Type No.	Serial No.	Calibrated until
1	Spectrum Analyzer	R&S	FSP 40	100185	Oct. 11, 2016

Power Spectral Density Measurement					
Item	Kind of Equipment	Manufacturer	Type No.	Serial No.	Calibrated until
1	Spectrum Analyzer	R&S	FSP 40	100185	Oct. 11, 2016

Remark: "N/A" denotes no model name, serial no. or calibration specified.
 All calibration period of equipment list is one year.

10. EUT TEST PHOTO

Conducted Measurement Photos



Radiated Measurement Photos

9KHz to 30MHz

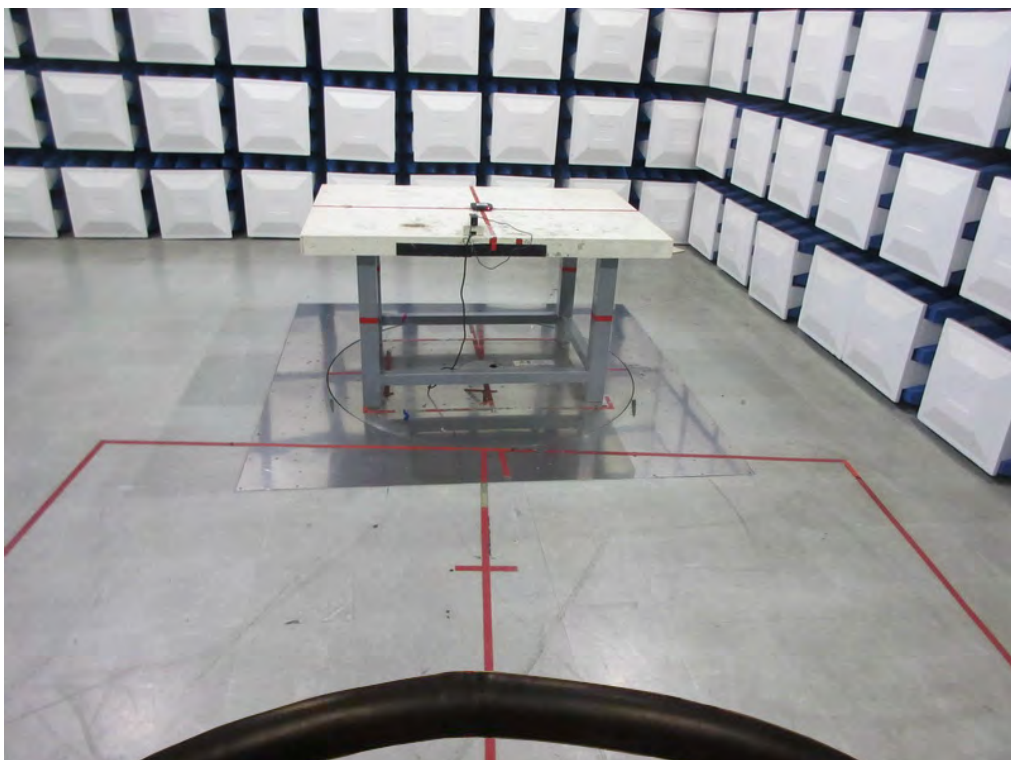

Radiated Measurement Photos

30MHz to 1000MHz



Radiated Measurement Photos

Above 1000MHz

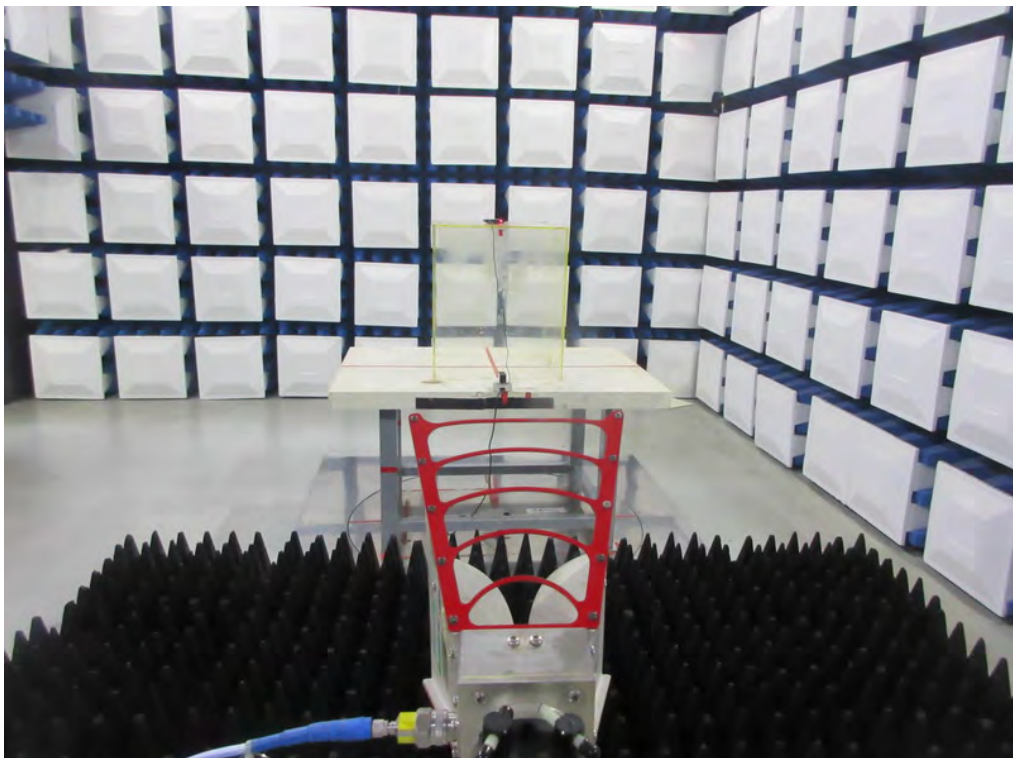
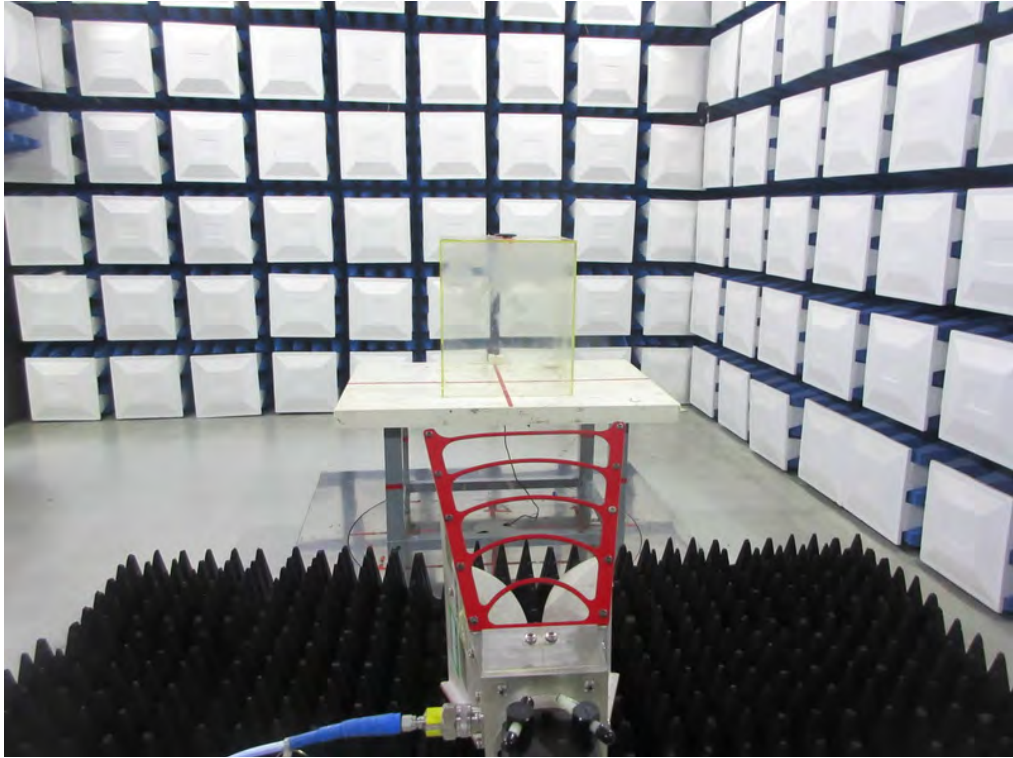

ATTACHMENT A - CONDUCTED EMISSION

Test Mode: TX Mode- Adapter: MI / GSCU2100S05V215S

Line

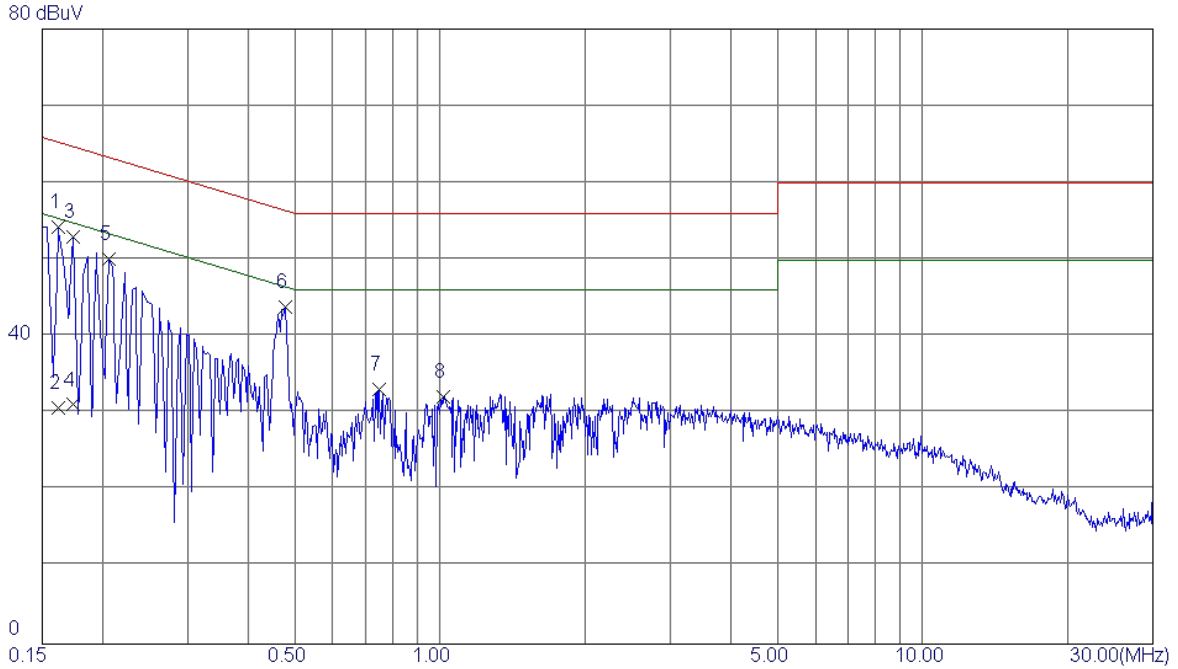

No.	Freq. MHz	Reading Level dBuV	Correct Factor dB	Measure ment dBuV	Limit dBuV	Margin dB	Detector	Comment
1 *	0.1620	44.66	9.52	54.18	65.36	-11.18	Peak	
2	0.1620	21.20	9.52	30.72	55.36	-24.64	AVG	
3	0.1740	43.37	9.52	52.89	64.77	-11.88	Peak	
4	0.1740	21.60	9.52	31.12	54.77	-23.65	AVG	
5	0.2060	40.50	9.53	50.03	63.37	-13.34	Peak	
6	0.4780	34.22	9.62	43.84	56.37	-12.53	Peak	
7	0.7500	23.35	9.70	33.05	56.00	-22.95	Peak	
8	1.0140	22.47	9.76	32.23	56.00	-23.77	Peak	

Test Mode: TX Mode- Adapter: MI / GSCU2100S05V215S

Neutral

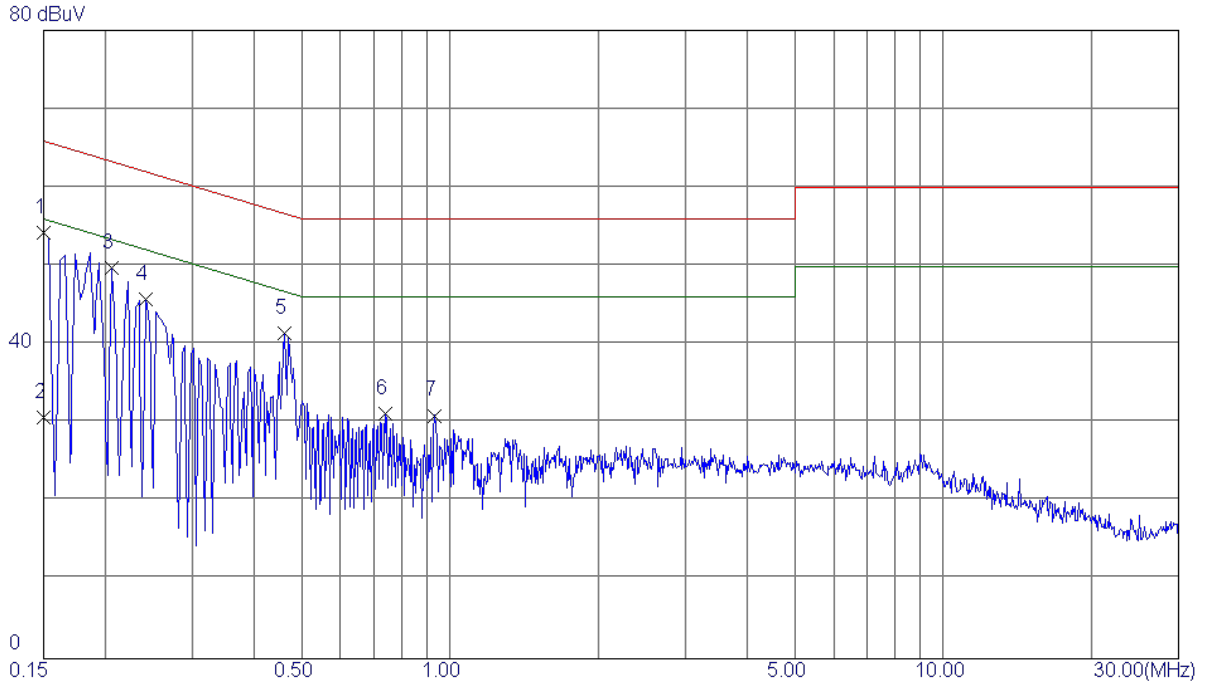

No.	Freq. MHz	Reading Level dBuV	Correct Factor dB	Measure ment dBuV	Limit dBuV	Margin dB	Detector	Comment
1 *	0.1500	44.75	9.52	54.27	66.00	-11.73	Peak	
2	0.1500	21.20	9.52	30.72	56.00	-25.28	AVG	
3	0.2060	40.18	9.53	49.71	63.37	-13.66	Peak	
4	0.2420	36.25	9.53	45.78	62.03	-16.25	Peak	
5	0.4620	32.02	9.44	41.46	56.66	-15.20	Peak	
6	0.7380	21.74	9.49	31.23	56.00	-24.77	Peak	
7	0.9300	21.30	9.66	30.96	56.00	-25.04	Peak	

Test Mode: TX Mode- Adapter: MI / AY11BA-AF0522102

Line

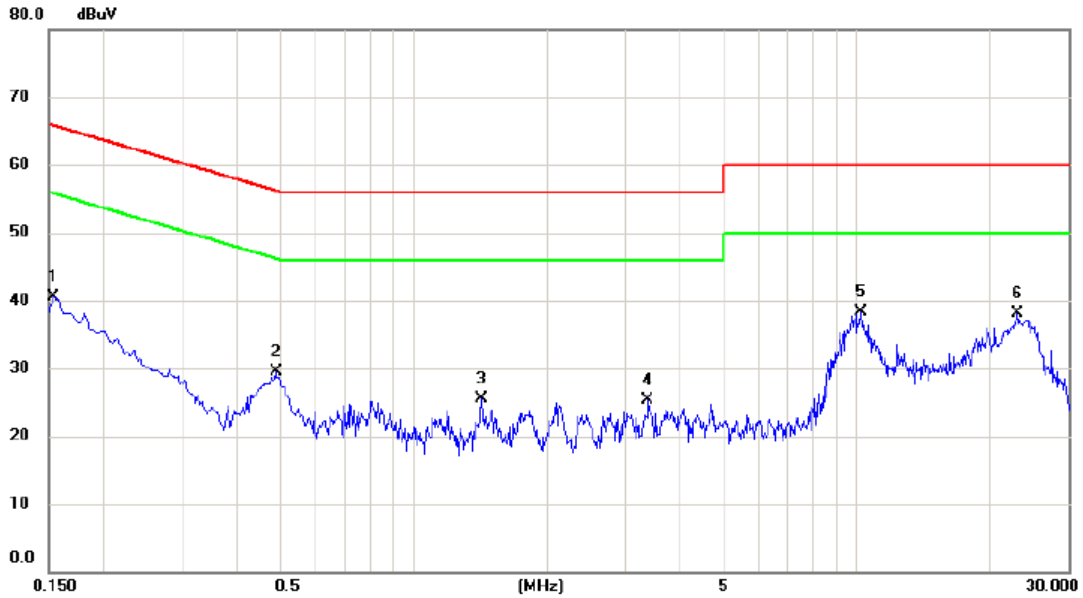

No. Mk.	Freq. MHz	Reading Level dBuV	Correct Factor dB	Measurement dBuV	Limit dBuV	Margin dB	Detector	Comment
1	0.1540	30.84	9.68	40.52	65.78	-25.26	QP	
2	0.4890	19.73	9.69	29.42	56.18	-26.76	QP	
3	1.4254	15.68	9.73	25.41	56.00	-30.59	QP	
4	3.3814	15.40	9.83	25.23	56.00	-30.77	QP	
5 *	10.2332	28.27	9.95	38.22	60.00	-21.78	QP	
6	23.0181	28.06	9.95	38.01	60.00	-21.99	QP	

Test Mode: TX Mode- Adapter: MI / AY11BA-AF0522102

Neutral

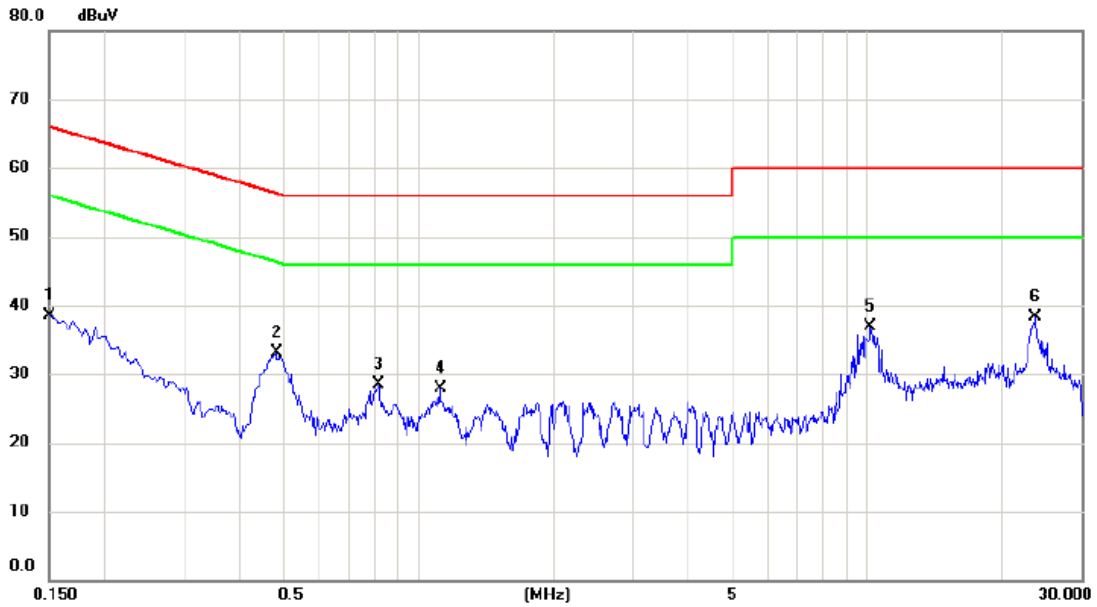

No.	Mk.	Freq. MHz	Reading Level dBuV	Correct Factor dB	Measure- ment dBuV	Limit dBuV	Margin dB	Detector	Comment
1		0.1500	28.74	9.68	38.42	66.00	-27.58	QP	
2		0.4812	23.33	9.69	33.02	56.32	-23.30	QP	
3		0.8131	18.72	9.70	28.42	56.00	-27.58	QP	
4		1.1170	18.12	9.72	27.84	56.00	-28.16	QP	
5		10.1791	26.98	9.96	36.94	60.00	-23.06	QP	
6	*	23.7615	28.30	9.95	38.25	60.00	-21.75	QP	

ATTACHMENT B - RADIATED EMISSION (9KHZ TO 30MHZ)

Test Mode:	TX Mode- Adapter: MI / GSCU2100S05V215S
------------	---

Frequency (MHz)	Ant 0°/90°	Read level dBuV/m	Factor (dB)	Measured(FS) (dBuV/m)	Limit (dBuV/m)	Margin (dB)	Note
0.0092	0°	13.4	24.9840	38.3840	128.3285	-89.9445	AVG
0.0092	0°	14.28	24.9840	39.2640	148.3285	-109.0645	PEAK
0.028	0°	6.77	23.7933	30.5633	118.6611	-88.0977	AVG
0.028	0°	8.1	23.7933	31.8933	138.6611	-106.7677	PEAK
0.0361	0°	3.29	23.2803	26.5703	116.4541	-89.8837	AVG
0.0361	0°	5.54	23.2803	28.8203	136.4541	-107.6337	PEAK
0.0583	0°	1.29	22.2340	23.5240	112.2909	-88.7669	AVG
0.0583	0°	2.54	22.2340	24.7740	132.2909	-107.5169	PEAK
0.5092	0°	19.33	19.8294	39.1594	73.4665	-34.3070	QP
1.9525	0°	23.77	19.5048	43.2748	69.5400	-26.2652	QP

Frequency (MHz)	Ant 0°/90°	Read level dBuV/m	Factor (dB)	Measured(FS) (dBuV/m)	Limit (dBuV/m)	Margin (dB)	Note
0.0121	90°	13.28	24.3000	37.5800	125.9485	-88.3685	AVG
0.0121	90°	14.8	24.3000	39.1000	145.9485	-106.8485	PEAK
0.0264	90°	7.29	23.8947	31.1847	119.1721	-87.9875	AVG
0.0264	90°	8.95	23.8947	32.8447	139.1721	-106.3275	PEAK
0.0435	90°	5.37	22.8117	28.1817	114.8344	-86.6528	AVG
0.0435	90°	6.36	22.8117	29.1717	134.8344	-105.6628	PEAK
0.0581	90°	1.54	22.2380	23.7780	112.3207	-88.5427	AVG
0.0581	90°	2.85	22.2380	25.0880	132.3207	-107.2327	PEAK
0.6219	90°	22.29	20.1901	42.4801	71.7298	-29.2497	QP
2.0545	90°	24.51	19.4673	43.9773	69.5400	-25.5627	QP

Test Mode: TX Mode- Adapter: MI / AY11BA-AF0522102

Frequency (MHz)	Ant 0°/90°	Read level dBuV/m	Factor (dB)	Measured(FS) (dBuV/m)	Limit (dBuV/m)	Margin (dB)	Note
0.0093	0°	13.25	24.98	38.23	128.23	-90.01	AVG
0.0093	0°	14.63	24.98	39.61	148.23	-108.63	PEAK
0.0281	0°	6.58	23.79	30.37	118.63	-88.26	AVG
0.0281	0°	8.07	23.79	31.86	138.63	-106.77	PEAK
0.0364	0°	3.38	23.26	26.64	116.38	-89.74	AVG
0.0364	0°	5.24	23.26	28.50	136.38	-107.88	PEAK
0.0582	0°	1.39	22.24	23.63	112.31	-88.68	AVG
0.0582	0°	2.56	22.24	24.80	132.31	-107.51	PEAK
0.5090	0°	19.84	19.83	39.67	73.47	-33.80	QP
1.9526	0°	23.41	19.50	42.91	69.54	-26.63	QP

Frequency (MHz)	Ant 0°/90°	Read level dBuV/m	Factor (dB)	Measured(FS) (dBuV/m)	Limit (dBuV/m)	Margin (dB)	Note
0.0122	90°	13.24	24.30	37.54	125.88	-88.34	AVG
0.0122	90°	14.58	24.30	38.88	145.88	-107.00	PEAK
0.0264	90°	7.16	23.89	31.05	119.17	-88.12	AVG
0.0264	90°	8.73	23.89	32.62	139.17	-106.55	PEAK
0.0432	90°	5.49	22.83	28.32	114.89	-86.57	AVG
0.0432	90°	6.52	22.83	29.35	134.89	-105.54	PEAK
0.0581	90°	1.74	22.24	23.98	112.32	-88.34	AVG
0.0581	90°	2.91	22.24	25.15	132.32	-107.17	PEAK
0.6216	90°	22.17	20.19	42.36	71.73	-29.37	QP
2.0543	90°	23.84	19.47	43.31	69.54	-26.23	QP

ATTACHMENT C - RADIATED EMISSION (30MHZ TO 1000MHZ)

Test Mode: TX B MODE CHANNEL 01 - Adapter: MI / GSCU2100S05V215S

Vertical

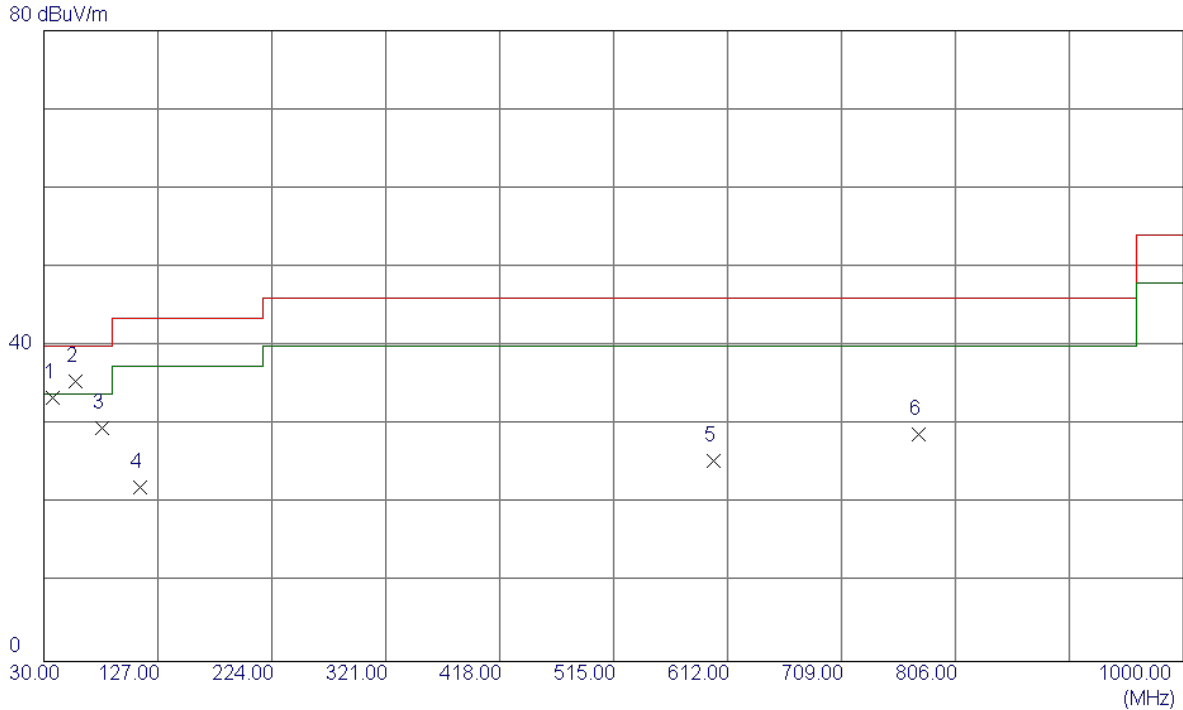

No.	Freq. MHz	Reading Level dBuV/m	Correct Factor dB	Measure ment dBuV/m	Limit dBuV/m	Margin dB	Detector	Comment
1	37.7599	47.47	-14.04	33.43	40.00	-6.57	Peak	
2 *	57.1600	49.04	-13.55	35.49	40.00	-4.51	Peak	
3	79.4700	45.71	-16.04	29.67	40.00	-10.33	Peak	
4	111.4800	36.49	-14.46	22.03	43.50	-21.47	Peak	
5	600.3600	33.27	-7.85	25.42	46.00	-20.58	Peak	
6	774.9600	30.70	-1.83	28.87	46.00	-17.13	Peak	

Test Mode: TX B MODE CHANNEL 01- Adapter: MI / GSCU2100S05V215S

Horizontal

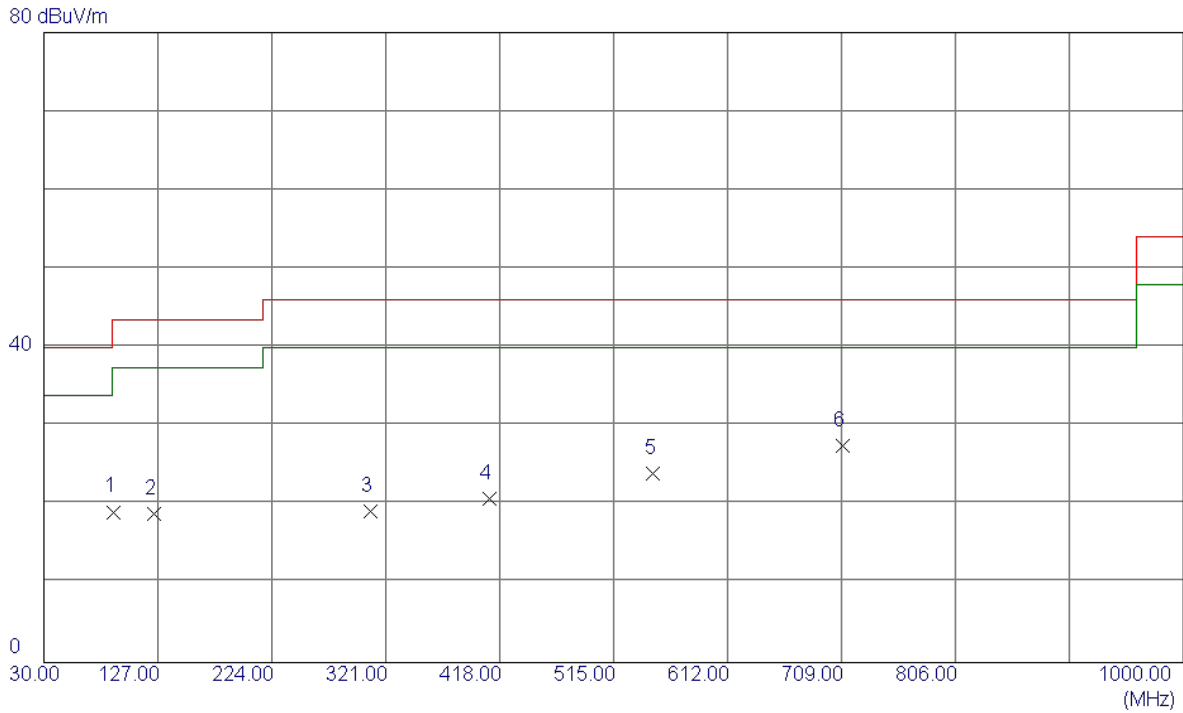

No.	Freq. MHz	Reading Level dBuV/m	Correct Factor dB	Measure ment dBuV/m	Limit dBuV/m	Margin dB	Detector	Comment
1	89.1700	36.52	-17.40	19.12	43.50	-24.38	Peak	
2	124.0900	31.92	-13.00	18.92	43.50	-24.58	Peak	
3	308.3900	29.82	-10.65	19.17	46.00	-26.83	Peak	
4	409.2700	29.14	-8.33	20.81	46.00	-25.19	Peak	
5	548.9500	29.33	-5.38	23.95	46.00	-22.05	Peak	
6 *	709.9699	30.56	-2.99	27.57	46.00	-18.43	Peak	

Test Mode: TX B MODE CHANNEL 06- Adapter: MI / GSCU2100S05V215S

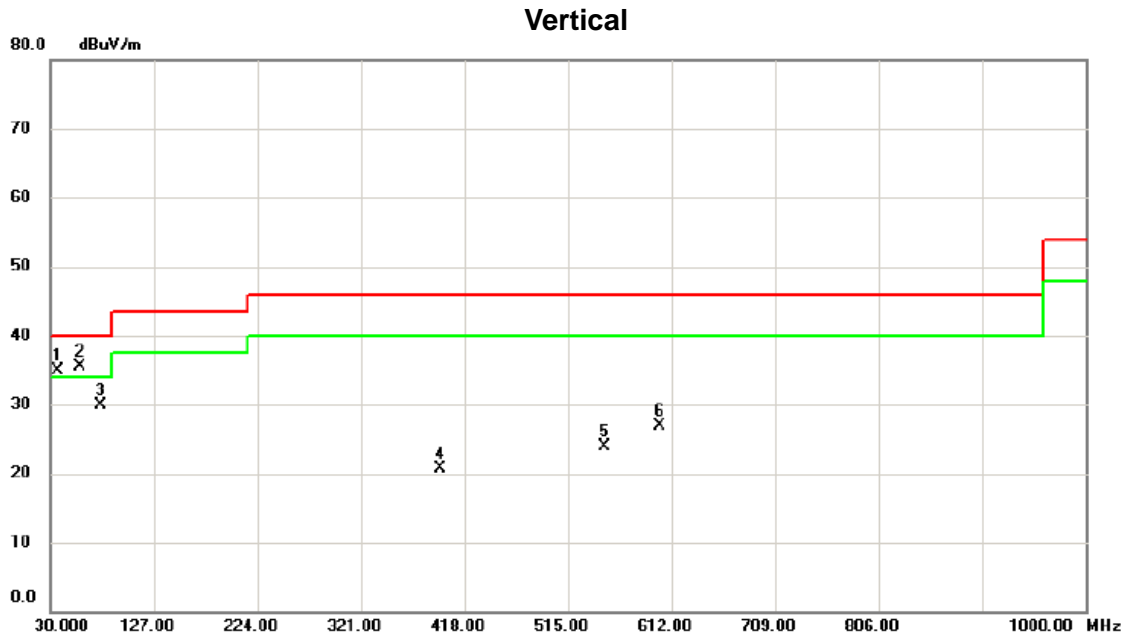

No.	Mk.	Freq. MHz	Reading Level dBuV	Correct Factor dB	Measure- ment dBuV/m	Limit dBuV/m	Margin dB	Detector	Comment
1	!	36.7900	48.85	-13.86	34.99	40.00	-5.01	peak	
2	*	57.1600	49.13	-13.54	35.59	40.00	-4.41	peak	
3		76.5600	46.24	-16.35	29.89	40.00	-10.11	peak	
4		394.7200	29.37	-8.62	20.75	46.00	-25.25	peak	
5		548.9500	29.37	-5.37	24.00	46.00	-22.00	peak	
6		600.3600	34.84	-7.85	26.99	46.00	-19.01	peak	

Test Mode: TX B MODE CHANNEL 06- Adapter: MI / GSCU2100S05V215S

Horizontal

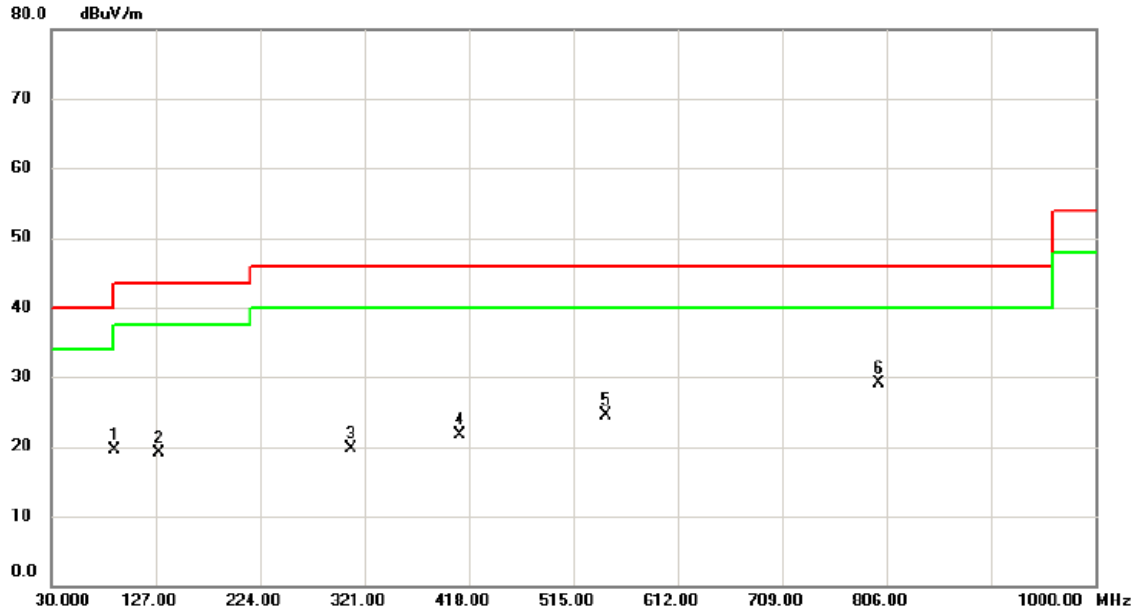

No.	Mk.	Freq. MHz	Reading Level dBuV	Correct Factor dB	Measure- ment dBuV/m	Limit dBuV/m	Margin dB	Detector	Comment
1		89.1700	36.97	-17.39	19.58	43.50	-23.92	peak	
2		129.9100	31.48	-12.37	19.11	43.50	-24.39	peak	
3		308.3900	30.28	-10.65	19.63	46.00	-26.37	peak	
4		409.2700	30.07	-8.33	21.74	46.00	-24.26	peak	
5		545.0700	30.19	-5.77	24.42	46.00	-21.58	peak	
6	*	798.2400	30.02	-0.82	29.20	46.00	-16.80	peak	

Test Mode: TX B MODE CHANNEL 11- Adapter: MI / GSCU2100S05V215S

Vertical

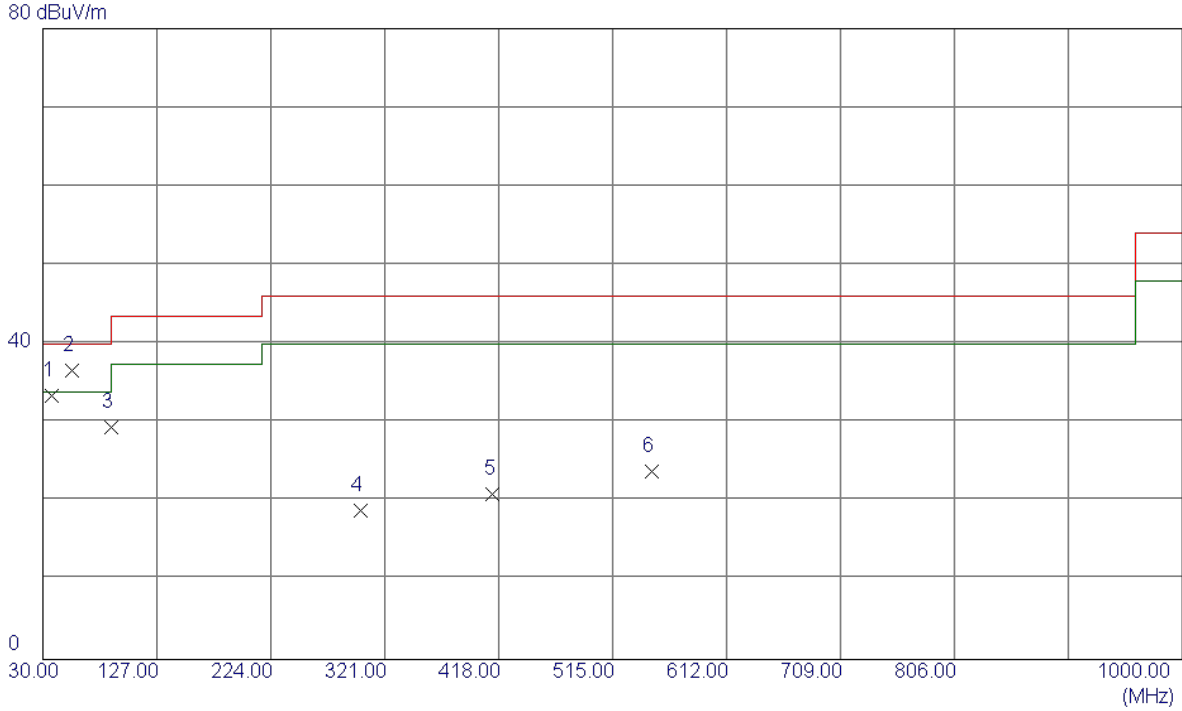

No.	Freq. MHz	Reading Level dBuV/m	Correct Factor dB	Measure ment dBuV/m	Limit dBuV/m	Margin dB	Detector	Comment
1	37.7599	47.41	-14.04	33.37	40.00	-6.63	Peak	
2 *	55.2200	49.97	-13.33	36.64	40.00	-3.36	Peak	
3	88.2000	46.87	-17.39	29.48	43.50	-14.02	Peak	
4	300.6300	29.33	-10.47	18.86	46.00	-27.14	Peak	
5	413.1500	29.37	-8.35	21.02	46.00	-24.98	Peak	
6	547.9800	29.32	-5.48	23.84	46.00	-22.16	Peak	

Test Mode: TX B MODE CHANNEL 11- Adapter: MI / GSCU2100S05V215S

Horizontal

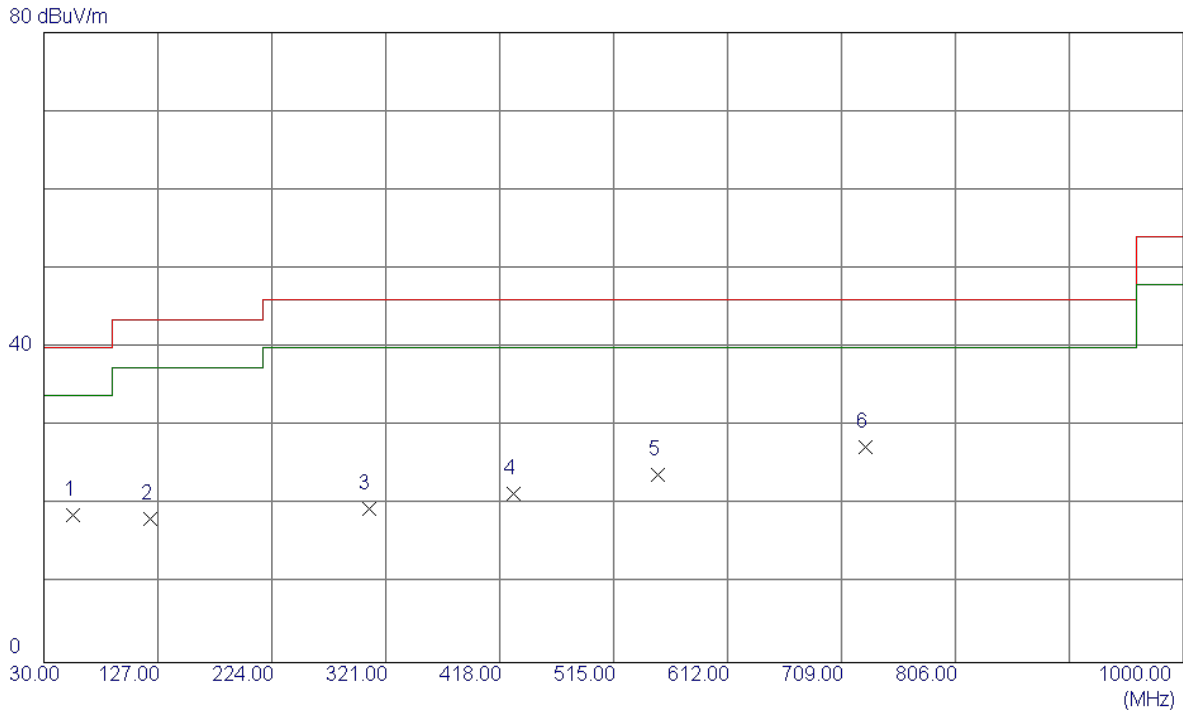

No.	Freq. MHz	Reading Level dBuV/m	Correct Factor dB	Measure ment dBuV/m	Limit dBuV/m	Margin dB	Detector	Comment
1	55.2200	31.99	-13.33	18.66	40.00	-21.34	Peak	
2	120.2100	31.63	-13.43	18.20	43.50	-25.30	Peak	
3	306.4500	30.09	-10.61	19.48	46.00	-26.52	Peak	
4	429.6400	29.90	-8.45	21.45	46.00	-24.55	Peak	
5	552.8300	29.33	-5.42	23.91	46.00	-22.09	Peak	
6 *	729.3700	30.36	-2.96	27.40	46.00	-18.60	Peak	

Test Mode: TX B MODE CHANNEL 01 - Adapter: MI / AY11BA-AF0522102

Vertical

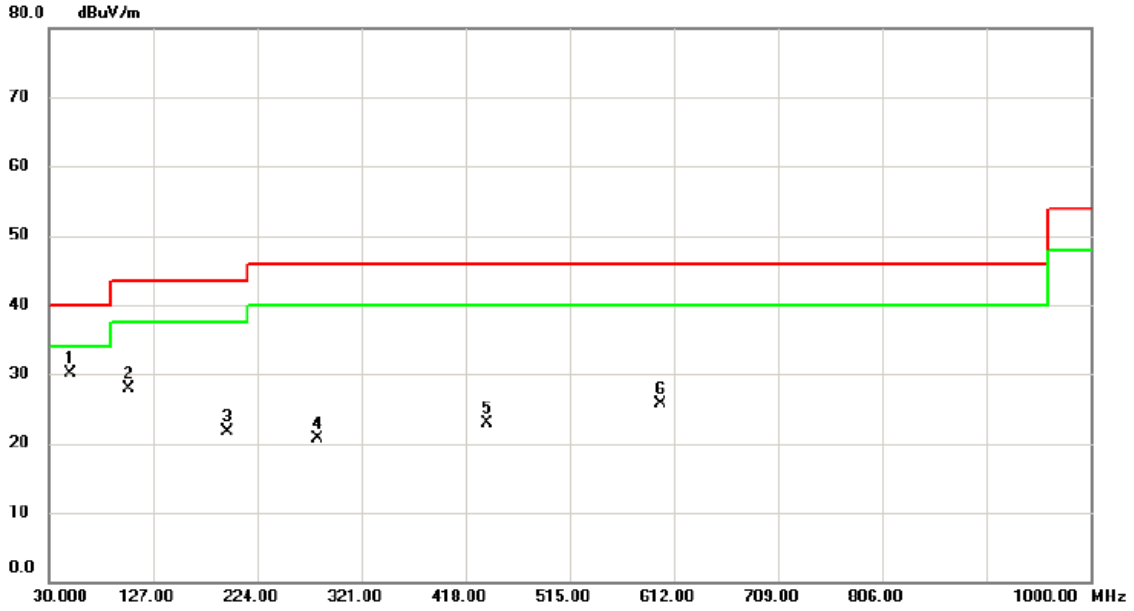

No.	Mk.	Freq. MHz	Reading Level dBuV	Correct Factor dB	Measure- ment dBuV/m	Limit dBuV/m	Margin dB	Detector	Comment
1	*	49.5000	42.17	-12.07	30.10	40.00	-9.90	peak	
2		104.0000	42.05	-14.21	27.84	43.50	-15.66	peak	
3		196.5000	35.25	-13.45	21.80	43.50	-21.70	peak	
4		280.0000	32.49	-11.73	20.76	46.00	-25.24	peak	
5		438.0000	30.01	-7.10	22.91	46.00	-23.09	peak	
6		600.0000	30.72	-5.10	25.62	46.00	-20.38	peak	

Test Mode: TX B MODE CHANNEL 01 - Adapter: MI / AY11BA-AF0522102

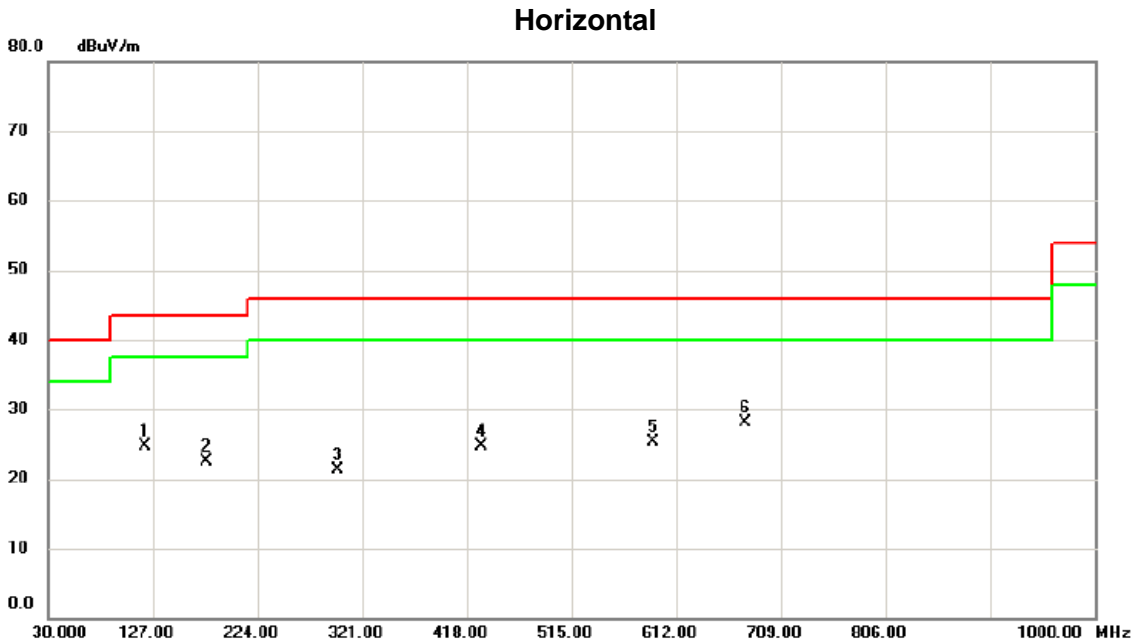

No.	Mk.	Freq. MHz	Reading Level dBuV	Correct Factor dB	Measure- ment dBuV/m	Limit dBuV/m	Margin dB	Detector	Comment
1		119.5000	37.27	-12.61	24.66	43.50	-18.84	peak	
2		177.0000	34.11	-11.70	22.41	43.50	-21.09	peak	
3		299.0000	31.24	-9.96	21.28	46.00	-24.72	peak	
4		432.0000	31.89	-7.11	24.78	46.00	-21.22	peak	
5		591.0000	30.28	-5.02	25.26	46.00	-20.74	peak	
6	*	676.5000	29.53	-1.36	28.17	46.00	-17.83	peak	

Test Mode: TX B MODE CHANNEL 06- Adapter: MI / AY11BA-AF0522102

Vertical

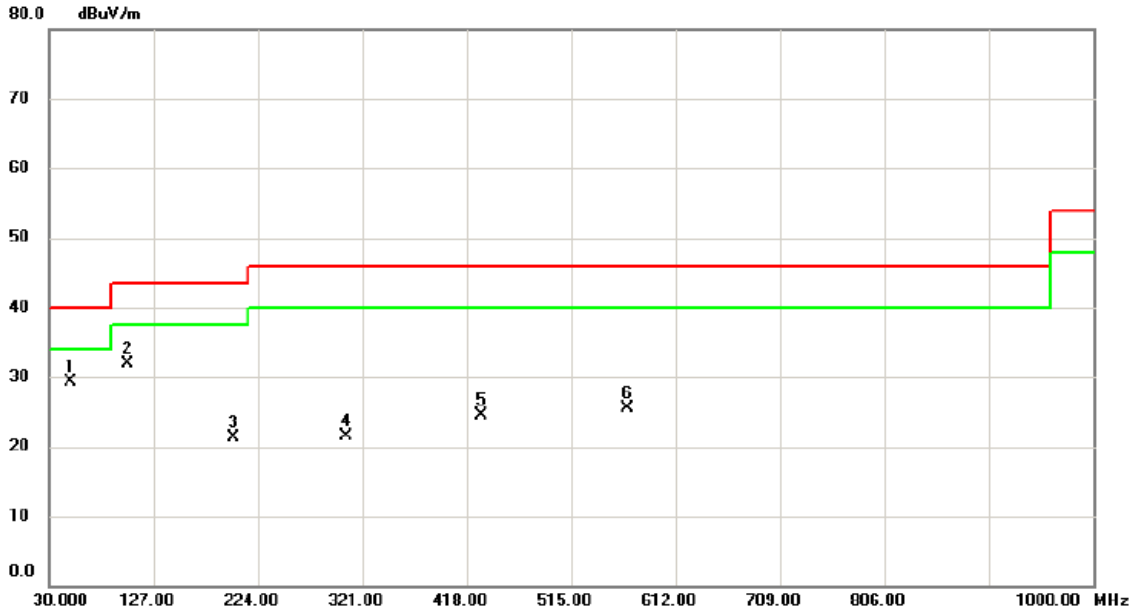

No.	Mk.	Freq.	Reading Level	Correct Factor	Measurement	Limit	Margin	Detector	Comment
		MHz	dBuV	dB	dBuV/m	dBuV/m	dB		
1	*	50.5000	41.37	-12.10	29.27	40.00	-10.73	peak	
2		102.5000	46.29	-14.31	31.98	43.50	-11.52	peak	
3		201.0000	35.03	-13.67	21.36	43.50	-22.14	peak	
4		305.5000	31.55	-10.05	21.50	46.00	-24.50	peak	
5		432.0000	31.70	-7.11	24.59	46.00	-21.41	peak	
6		568.0000	30.23	-4.80	25.43	46.00	-20.57	peak	

Test Mode: TX B MODE CHANNEL 06- Adapter: MI / AY11BA-AF0522102

Horizontal

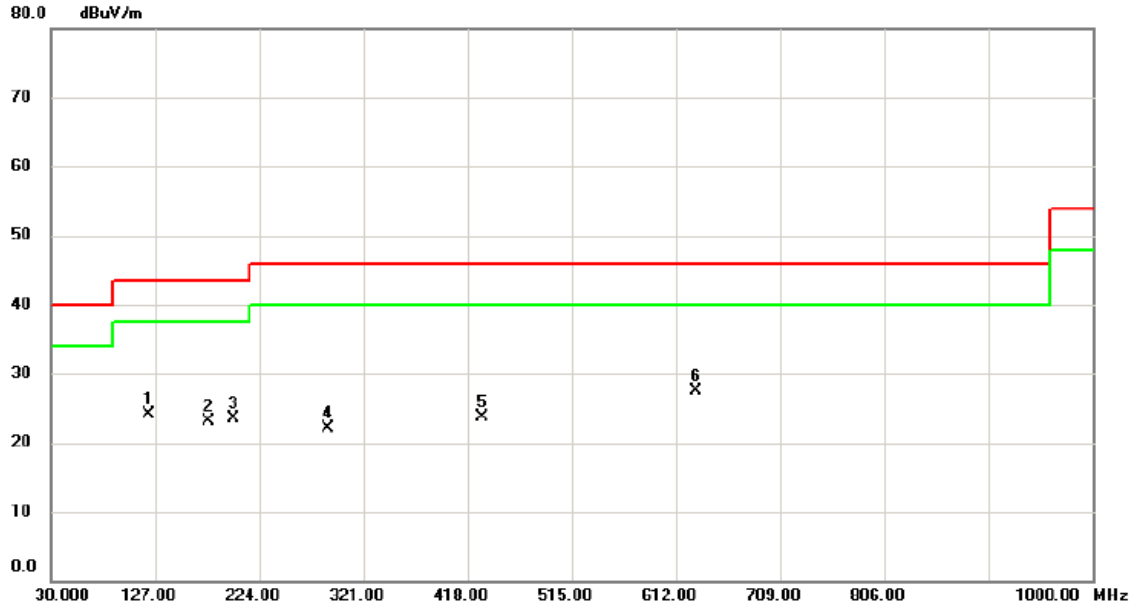

No.	Mk.	Freq.	Reading Level	Correct Factor	Measurement	Limit	Margin	Detector	Comment
		MHz	dBuV	dB	dBuV/m	dBuV/m	dB		
1		121.0000	36.49	-12.41	24.08	43.50	-19.42	peak	
2		177.0000	34.84	-11.70	23.14	43.50	-20.36	peak	
3		199.5000	37.16	-13.59	23.57	43.50	-19.93	peak	
4		288.5000	32.33	-10.27	22.06	46.00	-23.94	peak	
5		432.0000	30.90	-7.11	23.79	46.00	-22.21	peak	
6	*	631.0000	30.58	-3.10	27.48	46.00	-18.52	peak	

Test Mode: TX B MODE CHANNEL 11- Adapter: MI / AY11BA-AF0522102

Vertical

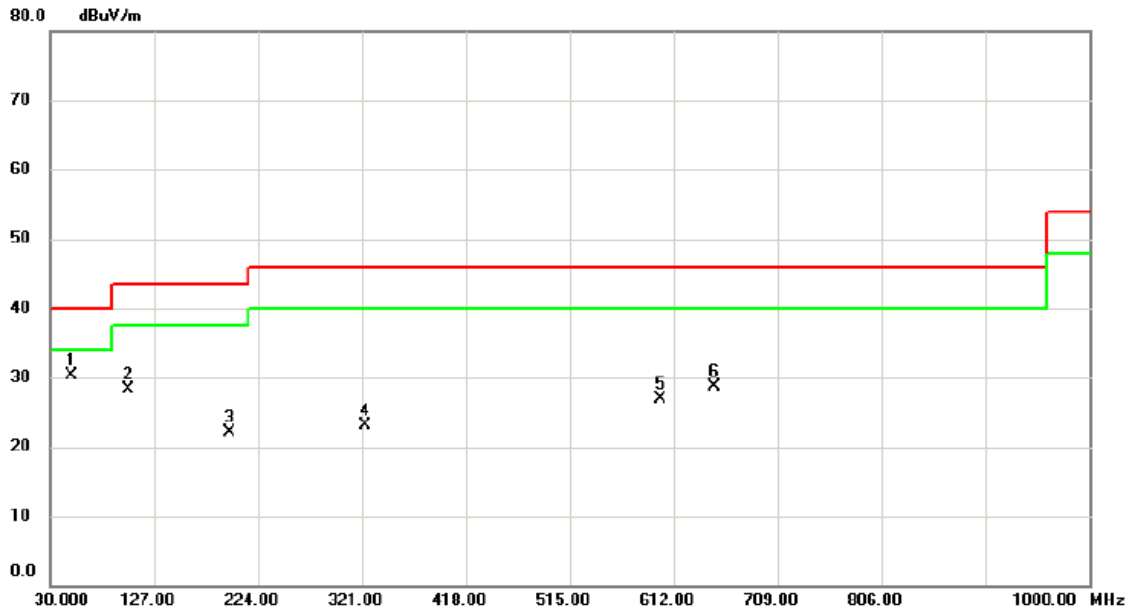

No.	Mk.	Freq. MHz	Reading Level dBuV	Correct Factor dB	Measure- ment dBuV/m	Limit dBuV/m	Margin dB	Detector	Comment
1	*	49.5000	42.34	-12.07	30.27	40.00	-9.73	peak	
2		102.5000	42.54	-14.31	28.23	43.50	-15.27	peak	
3		197.5000	35.52	-13.51	22.01	43.50	-21.49	peak	
4		324.0000	33.55	-10.35	23.20	46.00	-22.80	peak	
5		600.0000	32.05	-5.10	26.95	46.00	-19.05	peak	
6		650.0000	30.54	-1.88	28.66	46.00	-17.34	peak	

Test Mode: TX B MODE CHANNEL 11- Adapter: MI / AY11BA-AF0522102

Horizontal

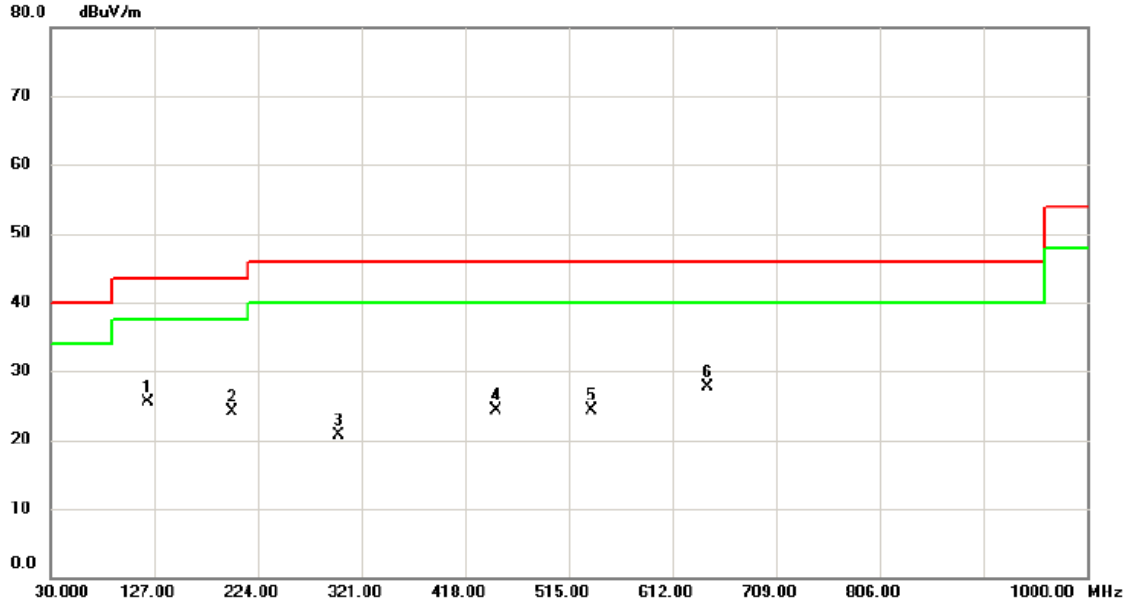

No.	Mk.	Freq. MHz	Reading Level dBuV	Correct Factor dB	Measure- ment dBuV/m	Limit dBuV/m	Margin dB	Detector	Comment
1	*	121.0000	37.96	-12.41	25.55	43.50	-17.95	peak	
2		200.5000	37.84	-13.65	24.19	43.50	-19.31	peak	
3		299.5000	30.60	-9.96	20.64	46.00	-25.36	peak	
4		447.5000	31.36	-7.07	24.29	46.00	-21.71	peak	
5		536.0000	29.88	-5.52	24.36	46.00	-21.64	peak	
6		645.0000	29.93	-2.20	27.73	46.00	-18.27	peak	

ATTACHMENT D - RADIATED EMISSION (ABOVE 1000MHZ)

Orthogonal Axis :	X
Test Mode :	TX B MODE 2412MHz

Vertical

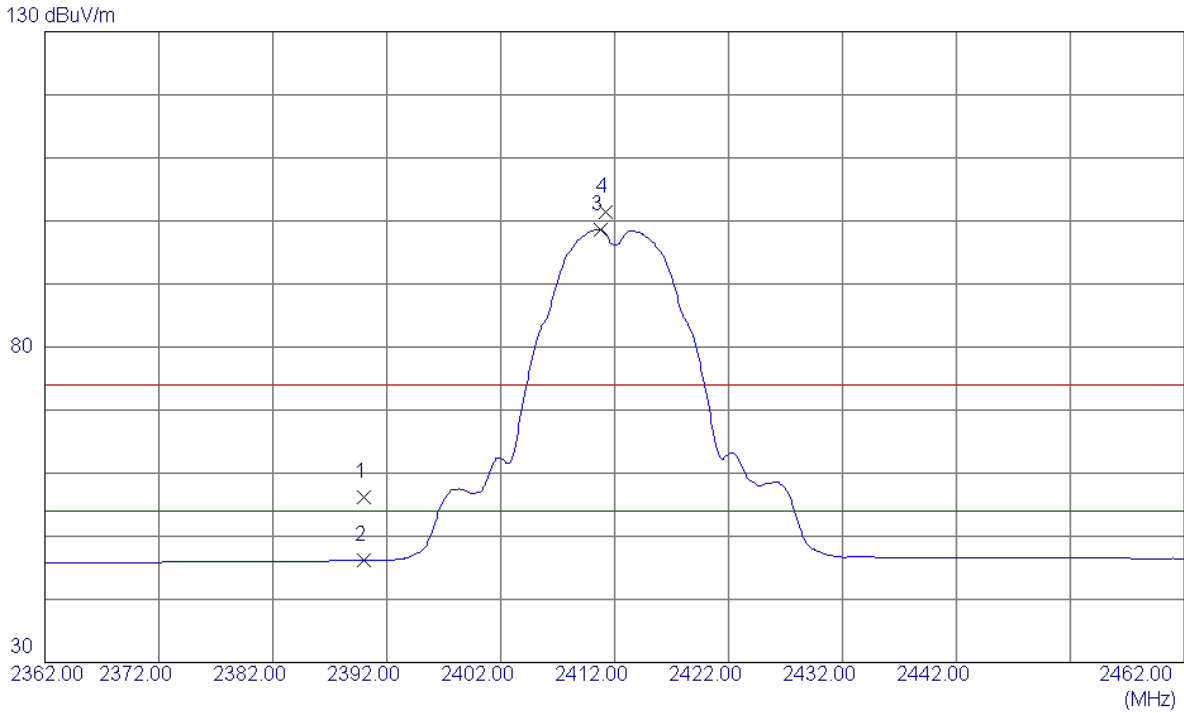

No.	Freq. MHz	Reading Level dBuV/m	Correct Factor dB	Measure ment dBuV/m	Limit dBuV/m	Margin dB	Detector	Comment
1	2390.0000	23.39	32.77	56.16	74.00	-17.84	Peak	
2	2390.0000	13.46	32.77	46.23	54.00	-7.77	AVG	
3 *	2410.8000	65.79	32.85	98.64	54.00	44.64	AVG	NO LIMIT
4	2411.2000	68.56	32.85	101.41	74.00	27.41	Peak	NO LIMIT

Orthogonal Axis :	X
Test Mode :	TX B MODE 2412MHz

Vertical

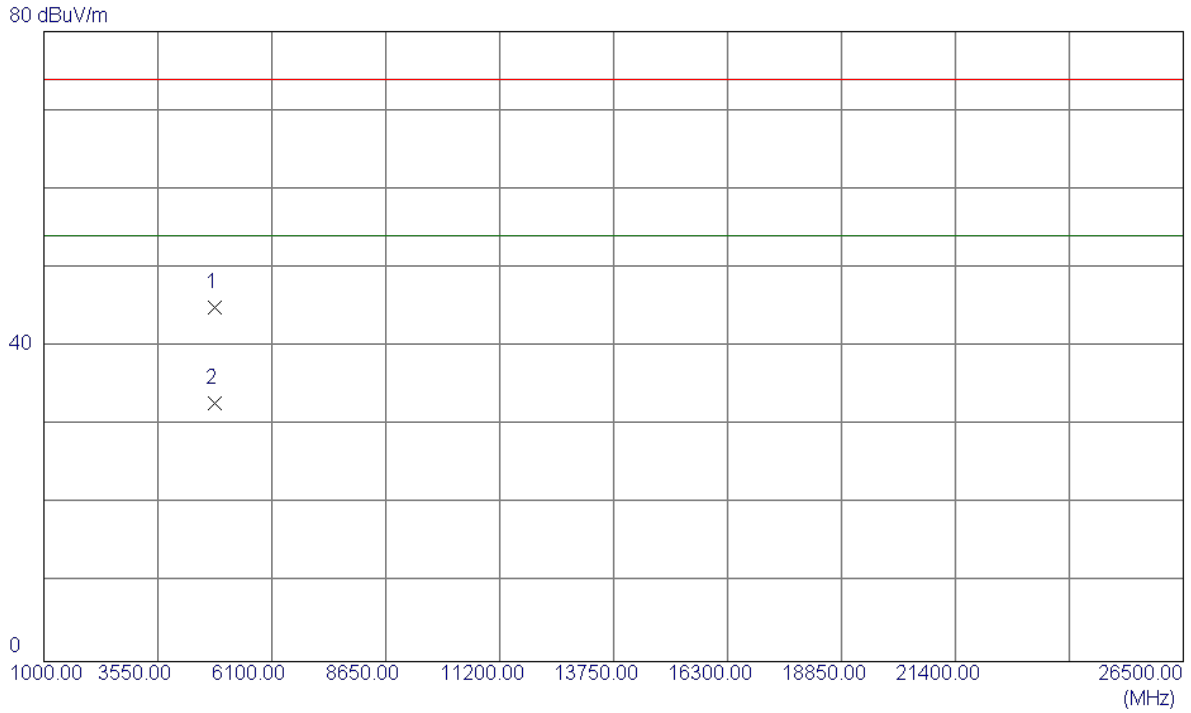

No.	Freq. MHz	Reading Level dBuV/m	Correct Factor dB	Measure ment dBuV/m	Limit dBuV/m	Margin dB	Detector	Comment
1	4823.9200	40.23	4.69	44.92	74.00	-29.08	Peak	
2 *	4823.9700	28.08	4.69	32.77	54.00	-21.23	AVG	

Orthogonal Axis :	X
Test Mode :	TX B MODE 2412MHz

Horizontal

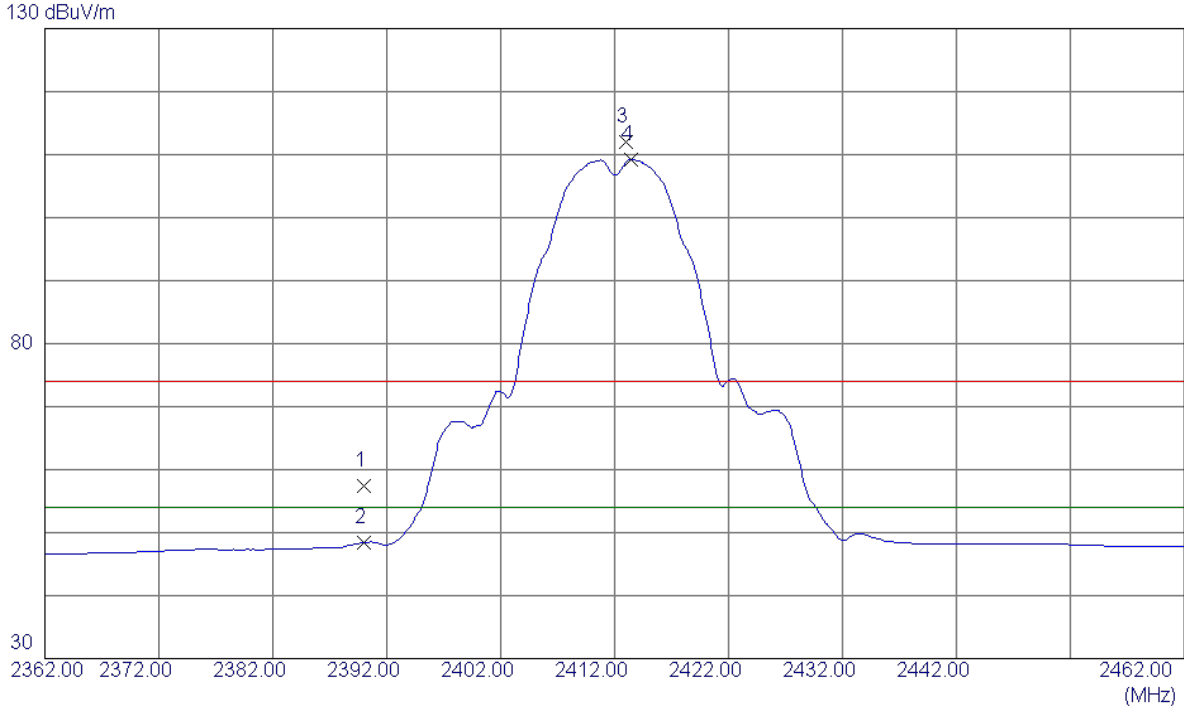

No.	Freq. MHz	Reading Level dBuV/m	Correct Factor dB	Measure ment dBuV/m	Limit dBuV/m	Margin dB	Detector	Comment
1	2390.0000	24.62	32.77	57.39	74.00	-16.61	Peak	
2	2390.0000	15.64	32.77	48.41	54.00	-5.59	AVG	
3	2413.0000	79.15	32.86	112.01	74.00	38.01	Peak	NO LIMIT
4 *	2413.4000	76.35	32.86	109.21	54.00	55.21	AVG	NO LIMIT

Orthogonal Axis :	X
Test Mode :	TX B MODE 2412MHz

Horizontal

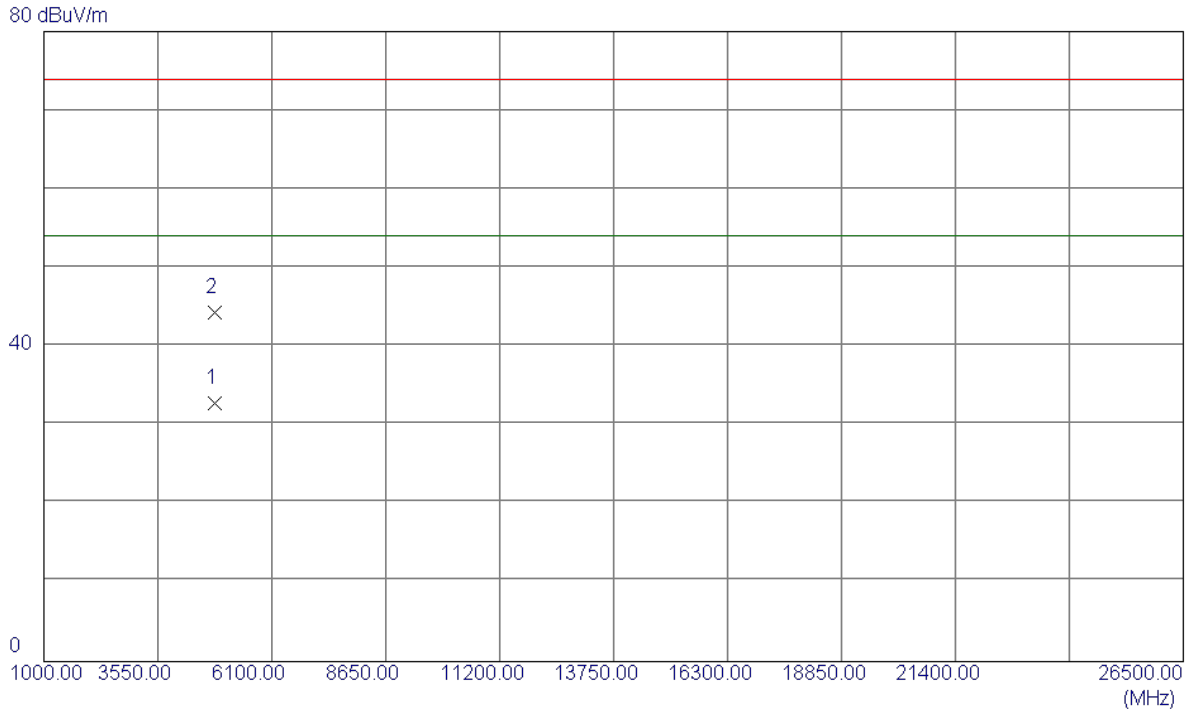

No.	Freq. MHz	Reading Level dBuV/m	Correct Factor dB	Measure ment dBuV/m	Limit dBuV/m	Margin dB	Detector	Comment
1 *	4823.9700	28.06	4.69	32.75	54.00	-21.25	AVG	
2	4824.0400	39.66	4.69	44.35	74.00	-29.65	Peak	

Orthogonal Axis :	X
Test Mode :	TX B MODE 2437MHz

Vertical

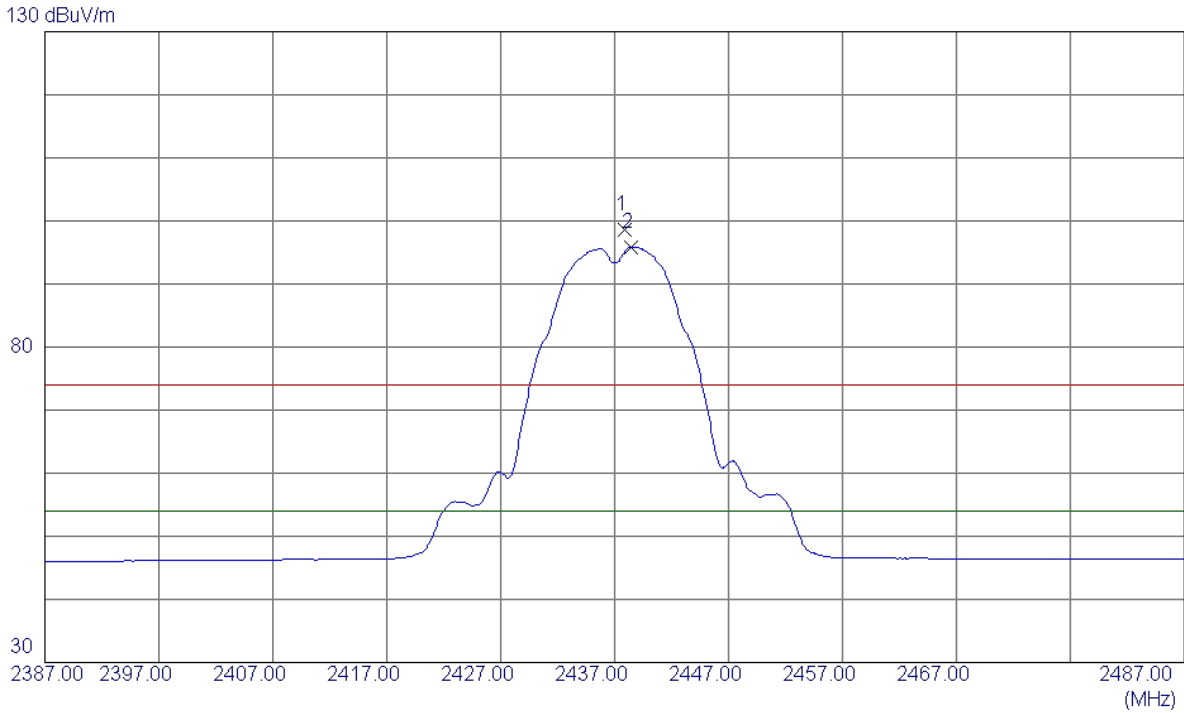

No.	Freq. MHz	Reading Level dBuV/m	Correct Factor dB	Measure ment dBuV/m	Limit dBuV/m	Margin dB	Detector	Comment
1	2437.9000	65.55	32.96	98.51	74.00	24.51	Peak	NO LIMIT
2 *	2438.4000	62.89	32.97	95.86	54.00	41.86	AVG	NO LIMIT

Orthogonal Axis :	X
Test Mode :	TX B MODE 2437MHz

Vertical

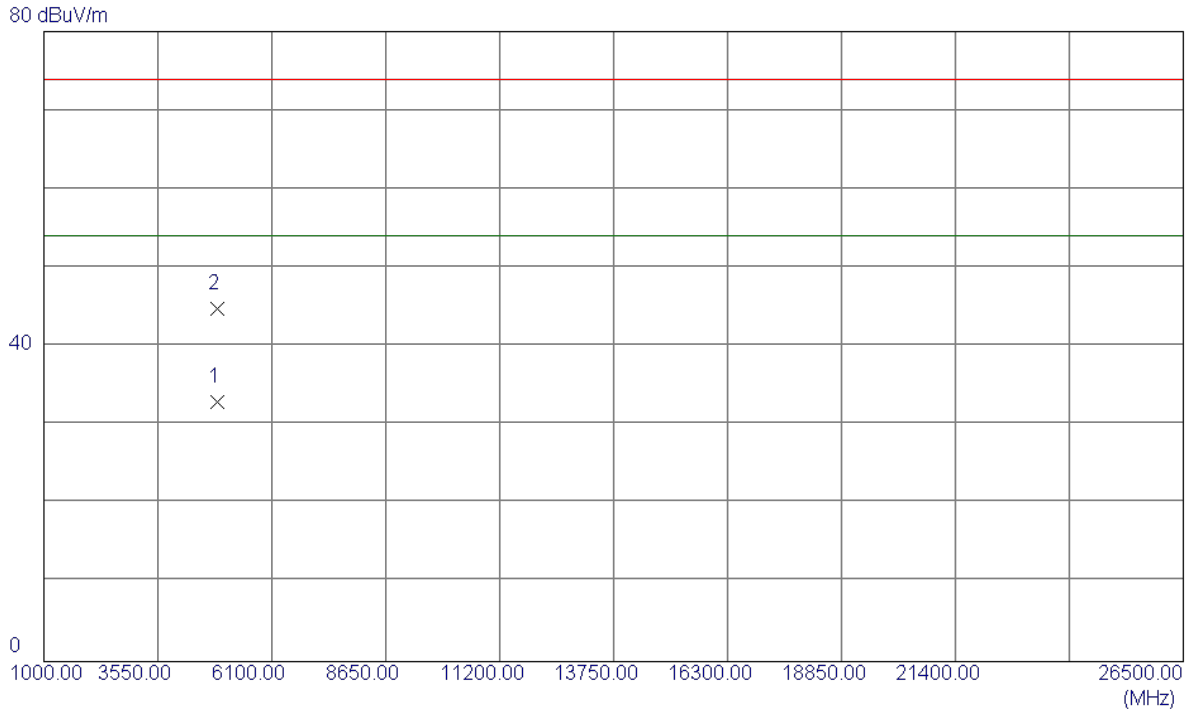

No.	Freq. MHz	Reading Level dBuV/m	Correct Factor dB	Measure ment dBuV/m	Limit dBuV/m	Margin dB	Detector	Comment
1 *	4874.0299	28.06	4.89	32.95	54.00	-21.05	AVG	
2	4874.0350	39.86	4.89	44.75	74.00	-29.25	Peak	

Orthogonal Axis :	X
Test Mode :	TX B MODE 2437MHz

Horizontal

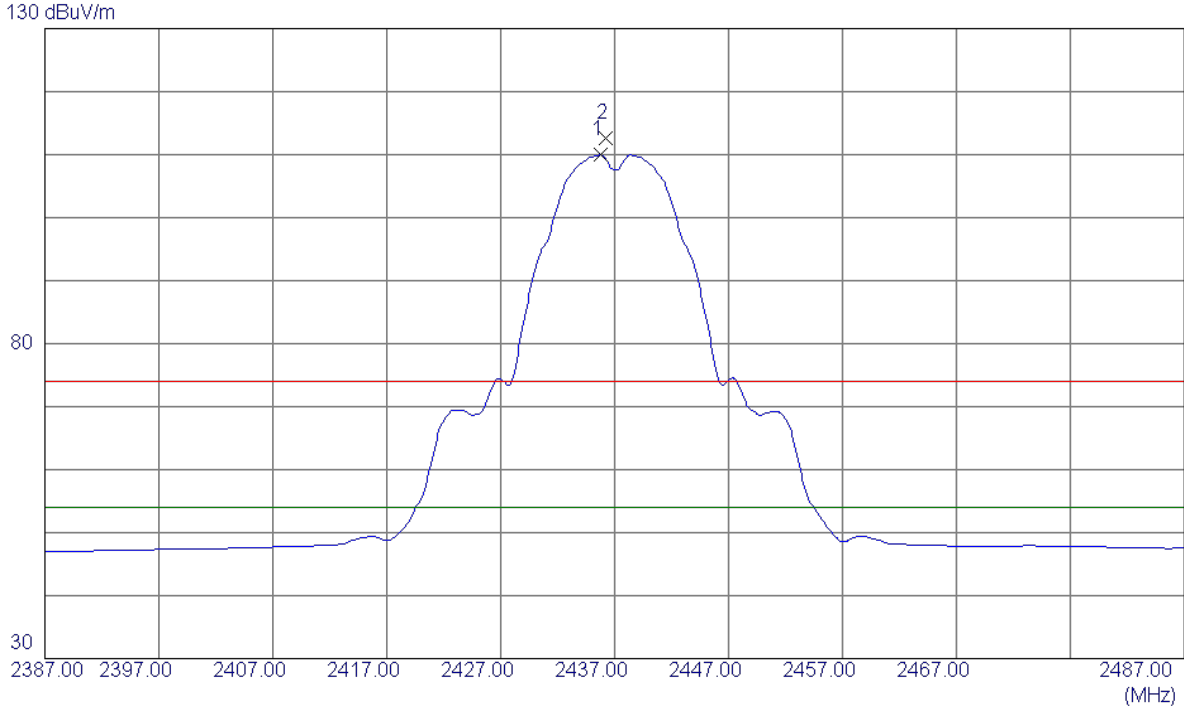

No.	Freq. MHz	Reading Level dBuV/m	Correct Factor dB	Measure ment dBuV/m	Limit dBuV/m	Margin dB	Detector	Comment
1 *	2435.8000	76.94	32.96	109.90	54.00	55.90	AVG	NO LIMIT
2	2436.2000	79.64	32.96	112.60	74.00	38.60	Peak	NO LIMIT

Orthogonal Axis :	X
Test Mode :	TX B MODE 2437MHz

Horizontal

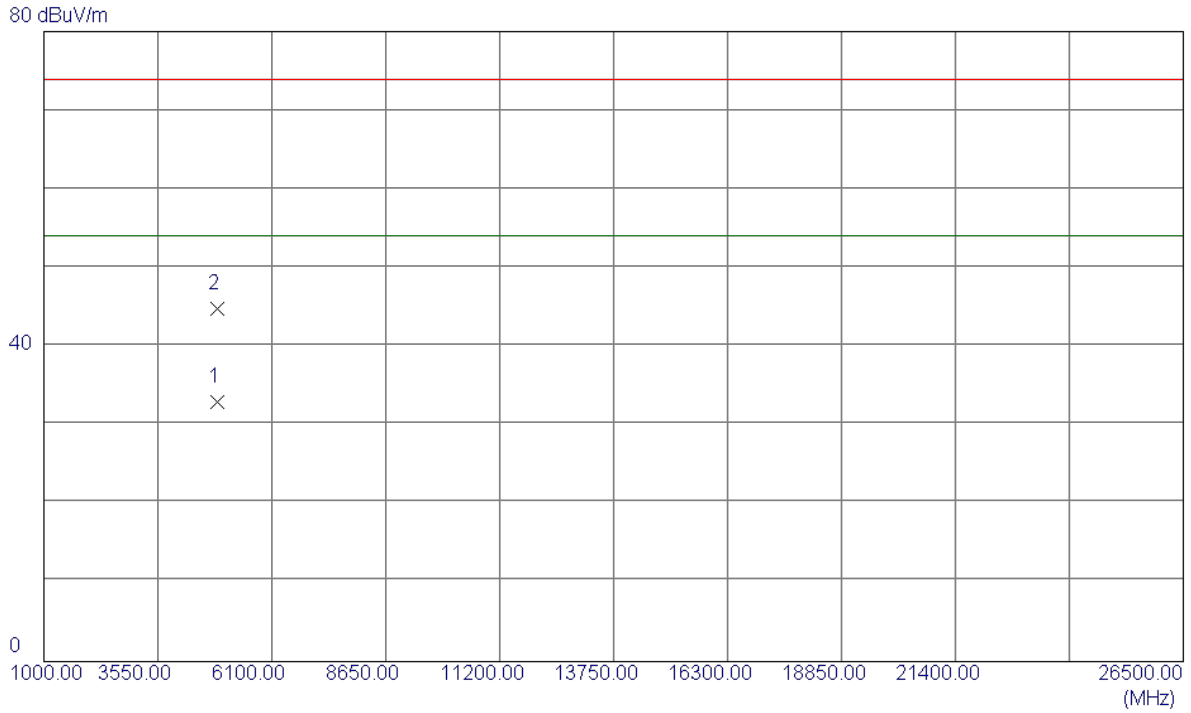

No.	Freq. MHz	Reading Level dBuV/m	Correct Factor dB	Measure ment dBuV/m	Limit dBuV/m	Margin dB	Detector	Comment
1 *	4873.9750	28.06	4.89	32.95	54.00	-21.05	AVG	
2	4874.0099	39.88	4.89	44.77	74.00	-29.23	Peak	

Orthogonal Axis :	X
Test Mode :	TX B MODE 2462MHz

Vertical

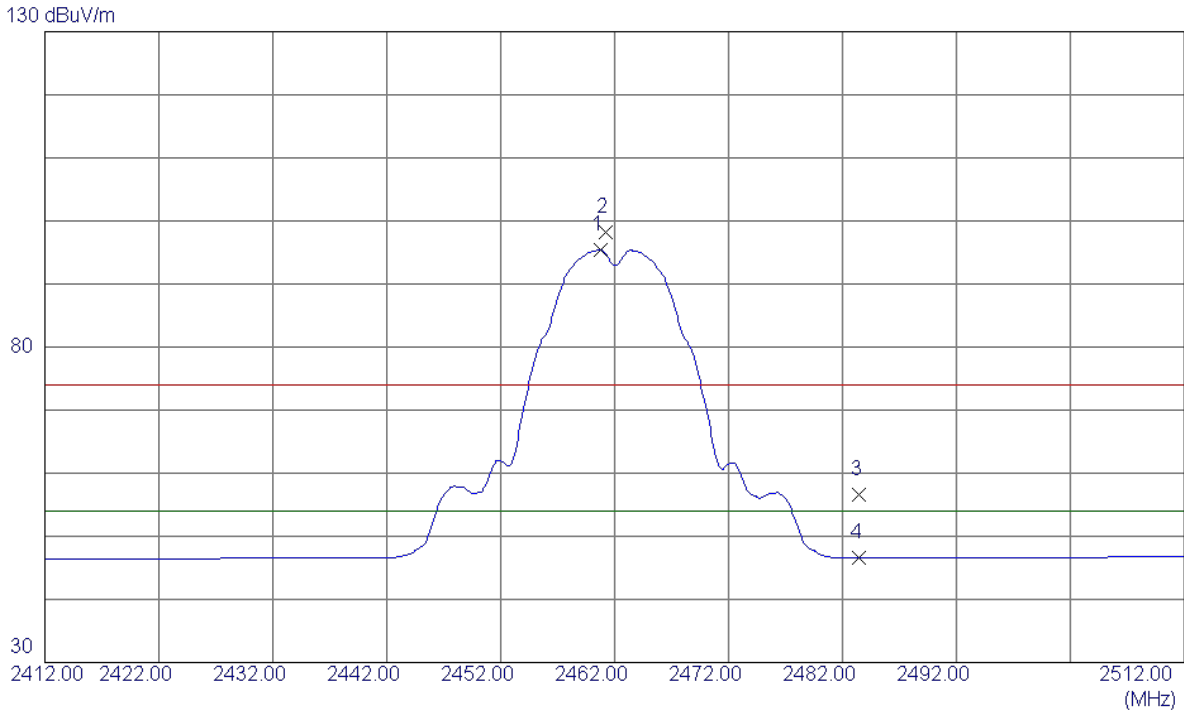

No.	Freq. MHz	Reading Level dBuV/m	Correct Factor dB	Measure ment dBuV/m	Limit dBuV/m	Margin dB	Detector	Comment
1 *	2460.8000	62.33	33.06	95.39	54.00	41.39	AVG	NO LIMIT
2	2461.2000	65.15	33.06	98.21	74.00	24.21	Peak	NO LIMIT
3	2483.5000	23.38	33.15	56.53	74.00	-17.47	Peak	
4	2483.5000	13.48	33.15	46.63	54.00	-7.37	AVG	

Orthogonal Axis :	X
Test Mode :	TX B MODE 2462MHz

Vertical

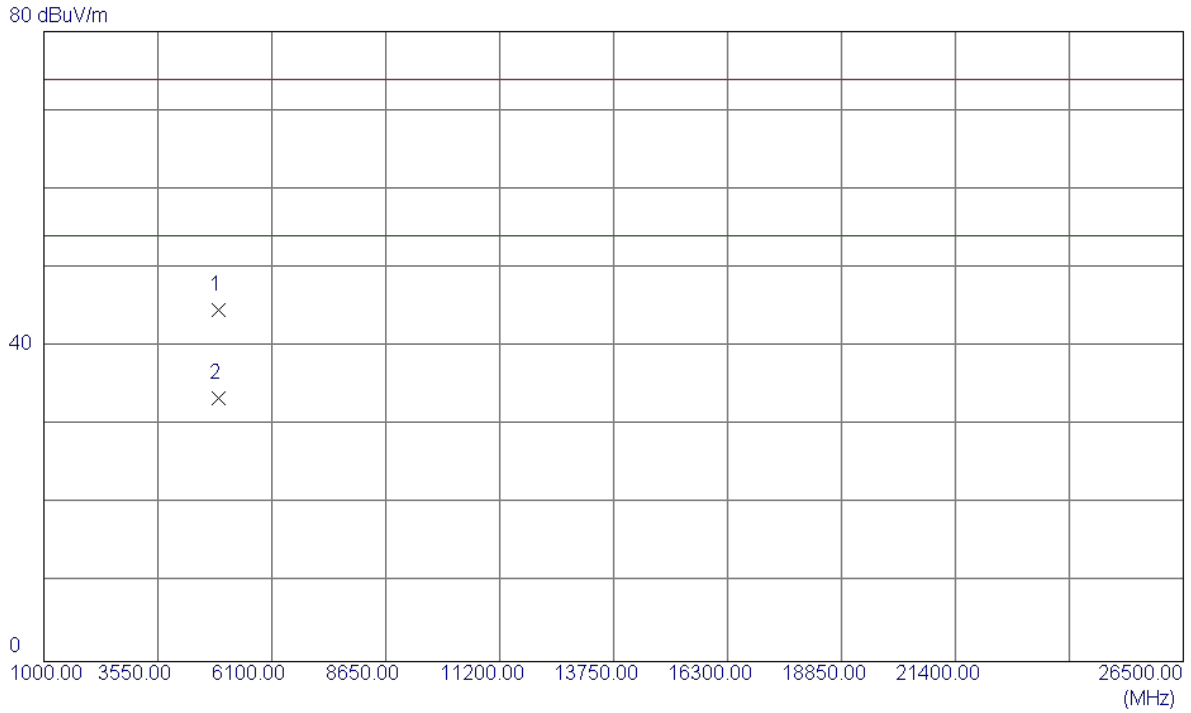

No.	Freq. MHz	Reading Level dBuV/m	Correct Factor dB	Measurement dBuV/m	Limit dBuV/m	Margin dB	Detector	Comment
1	4924.0150	39.61	5.08	44.69	74.00	-29.31	Peak	
2 *	4924.0700	28.36	5.08	33.44	54.00	-20.56	AVG	

Orthogonal Axis :	X
Test Mode :	TX B MODE 2462MHz

Horizontal

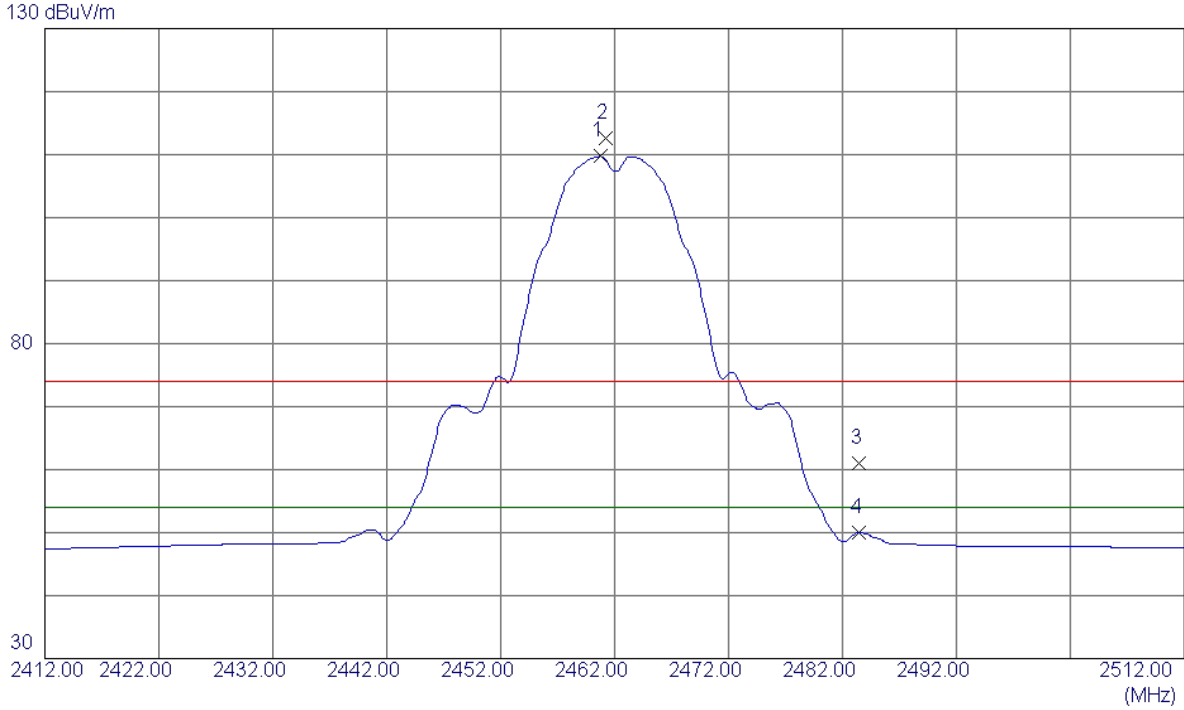

No.	Freq. MHz	Reading Level dBuV/m	Correct Factor dB	Measure ment dBuV/m	Limit dBuV/m	Margin dB	Detector	Comment
1 *	2460.8000	76.65	33.06	109.71	54.00	55.71	AVG	NO LIMIT
2	2461.2000	79.51	33.06	112.57	74.00	38.57	Peak	NO LIMIT
3	2483.5000	27.80	33.15	60.95	74.00	-13.05	Peak	
4	2483.5000	16.85	33.15	50.00	54.00	-4.00	AVG	

Orthogonal Axis :	X
Test Mode :	TX B MODE 2462MHz

Horizontal

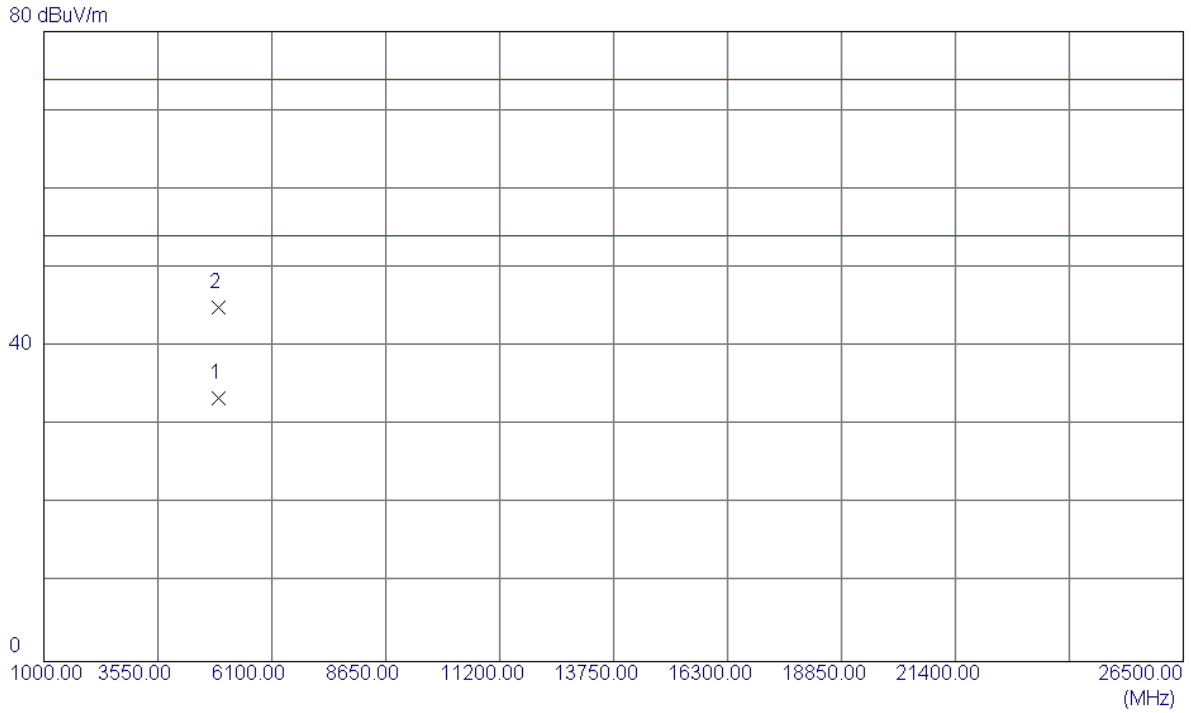

No.	Freq. MHz	Reading Level dBuV/m	Correct Factor dB	Measure ment dBuV/m	Limit dBuV/m	Margin dB	Detector	Comment
1 *	4923.9400	28.31	5.08	33.39	54.00	-20.61	AVG	
2	4924.0299	39.86	5.08	44.94	74.00	-29.06	Peak	

Orthogonal Axis :	X
Test Mode :	TX G MODE 2412MHz

Vertical

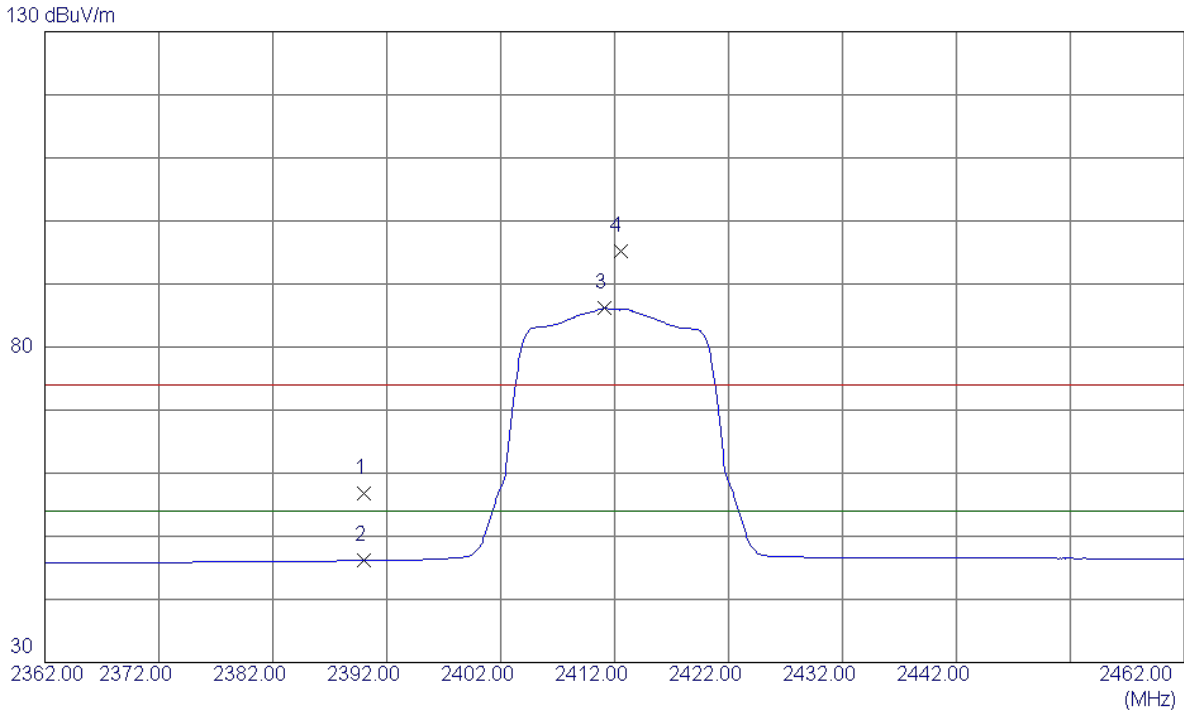

No.	Freq. MHz	Reading Level dBuV/m	Correct Factor dB	Measure ment dBuV/m	Limit dBuV/m	Margin dB	Detector	Comment
1	2390.0000	23.96	32.77	56.73	74.00	-17.27	Peak	
2	2390.0000	13.38	32.77	46.15	54.00	-7.85	AVG	
3 *	2411.1000	53.31	32.85	86.16	54.00	32.16	AVG	NO LIMIT
4	2412.5000	62.42	32.86	95.28	74.00	21.28	Peak	NO LIMIT

Orthogonal Axis :	X
Test Mode :	TX G MODE 2412MHz

Vertical

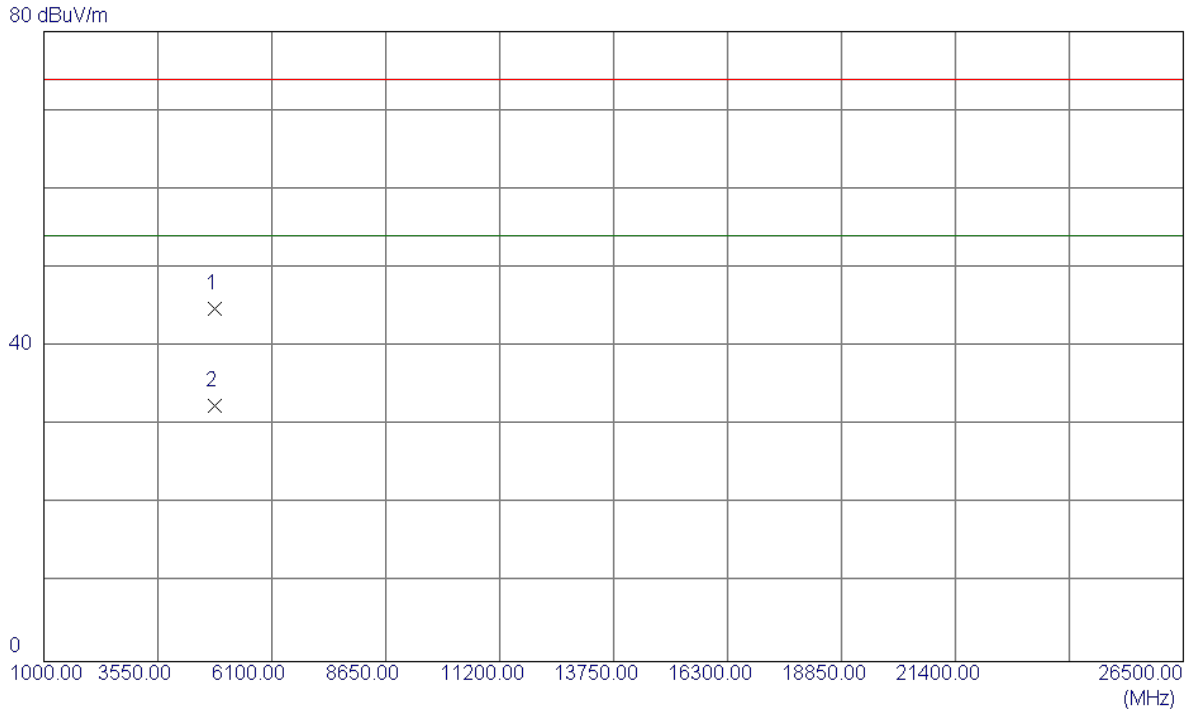

No.	Freq. MHz	Reading Level dBuV/m	Correct Factor dB	Measurement dBuV/m	Limit dBuV/m	Margin dB	Detector	Comment
1	4823.8800	40.18	4.69	44.87	74.00	-29.13	Peak	
2 *	4823.8700	27.83	4.69	32.52	54.00	-21.48	AVG	

Orthogonal Axis :	X
Test Mode :	TX G MODE 2412MHz

Horizontal

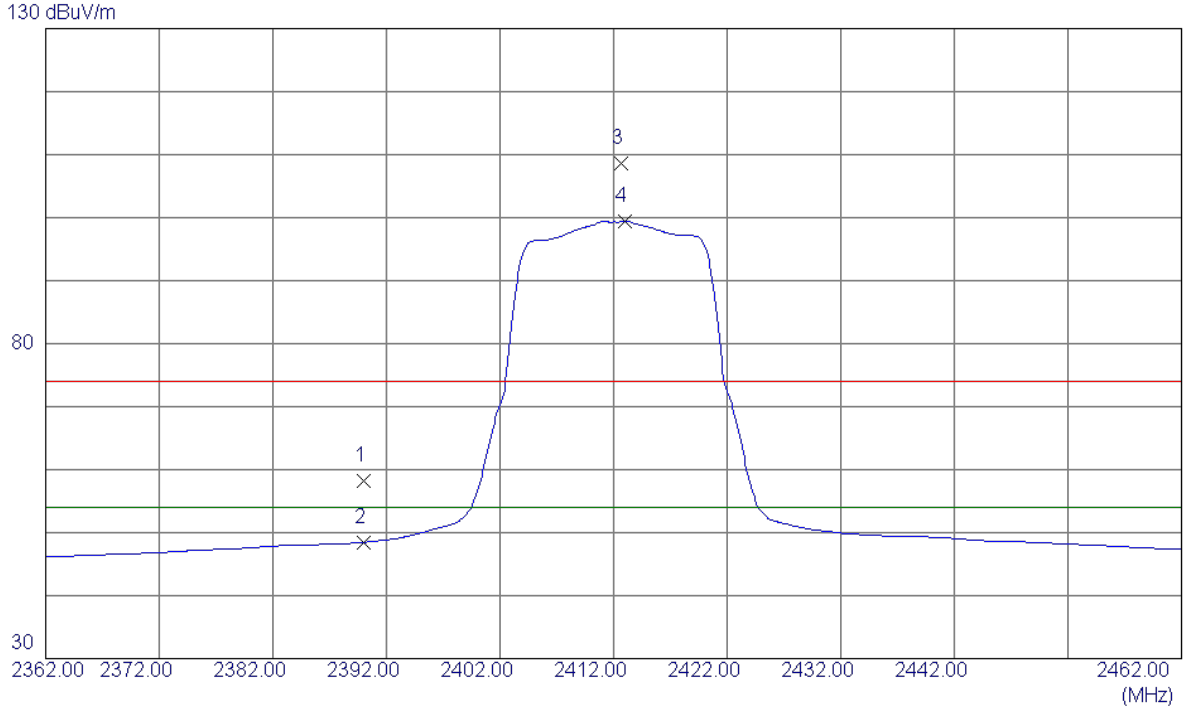

No.	Freq. MHz	Reading Level dBuV/m	Correct Factor dB	Measure ment dBuV/m	Limit dBuV/m	Margin dB	Detector	Comment
1	2390.0000	25.46	32.77	58.23	74.00	-15.77	Peak	
2	2390.0000	15.68	32.77	48.45	54.00	-5.55	AVG	
3	2412.7000	75.69	32.86	108.55	74.00	34.55	Peak	NO LIMIT
4 *	2413.0000	66.58	32.86	99.44	54.00	45.44	AVG	NO LIMIT

Orthogonal Axis :	X
Test Mode :	TX G MODE 2412MHz

Horizontal

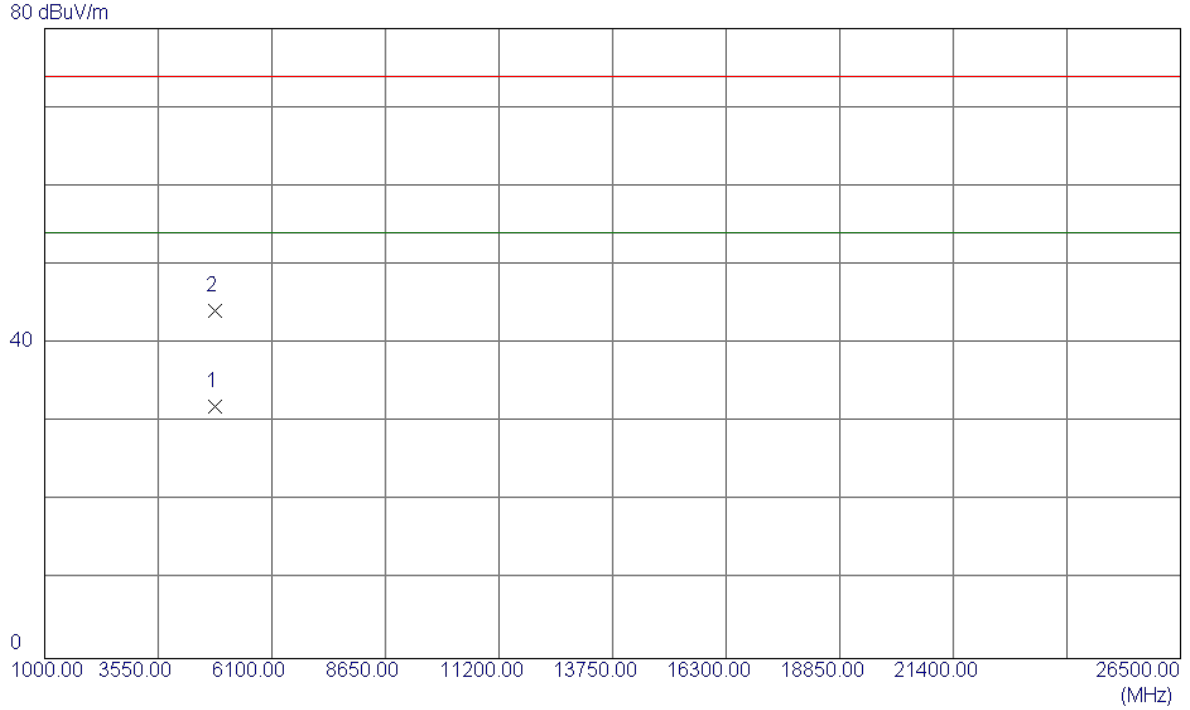

No.	Freq. MHz	Reading Level dBuV/m	Correct Factor dB	Measure ment dBuV/m	Limit dBuV/m	Margin dB	Detector	Comment
1 *	4823.8100	27.26	4.69	31.95	54.00	-22.05	AVG	
2	4824.0200	39.54	4.69	44.23	74.00	-29.77	Peak	

Orthogonal Axis :	X
Test Mode :	TX G MODE 2437MHz

Vertical

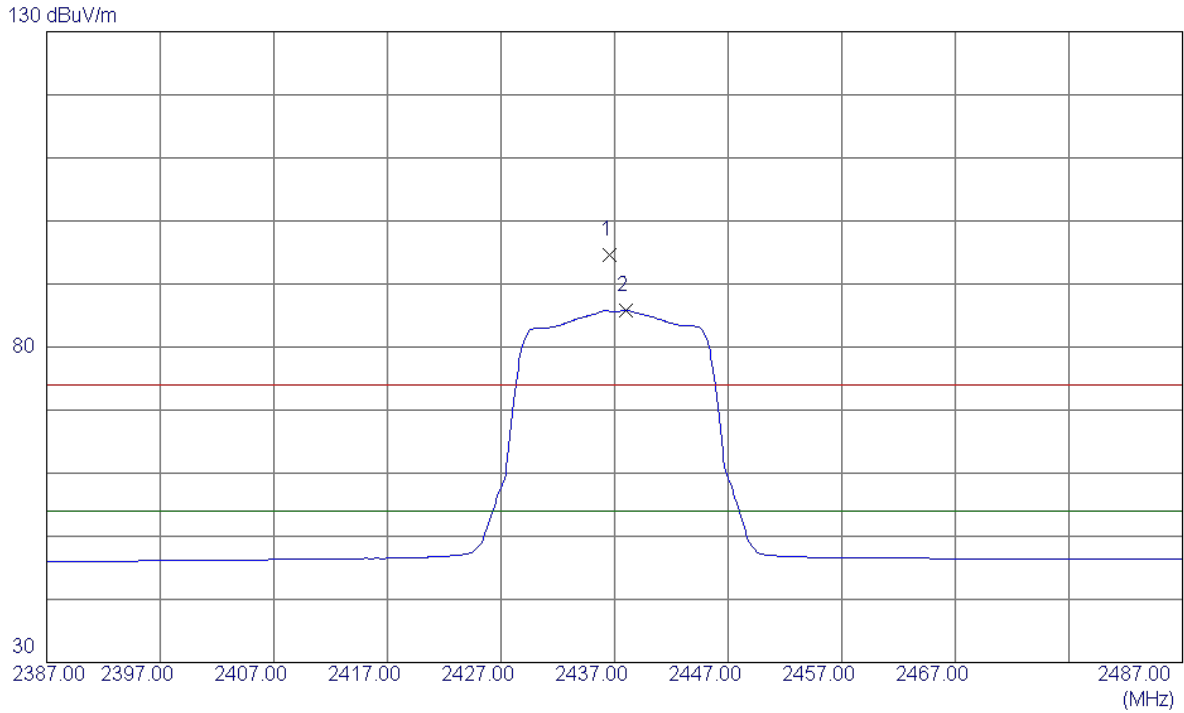

No.	Freq. MHz	Reading Level dBuV/m	Correct Factor dB	Measure ment dBuV/m	Limit dBuV/m	Margin dB	Detector	Comment
1	2436.6000	61.60	32.96	94.56	74.00	20.56	Peak	NO LIMIT
2 *	2438.0000	52.88	32.96	85.84	54.00	31.84	AVG	NO LIMIT

Orthogonal Axis :	X
Test Mode :	TX G MODE 2437MHz

Vertical

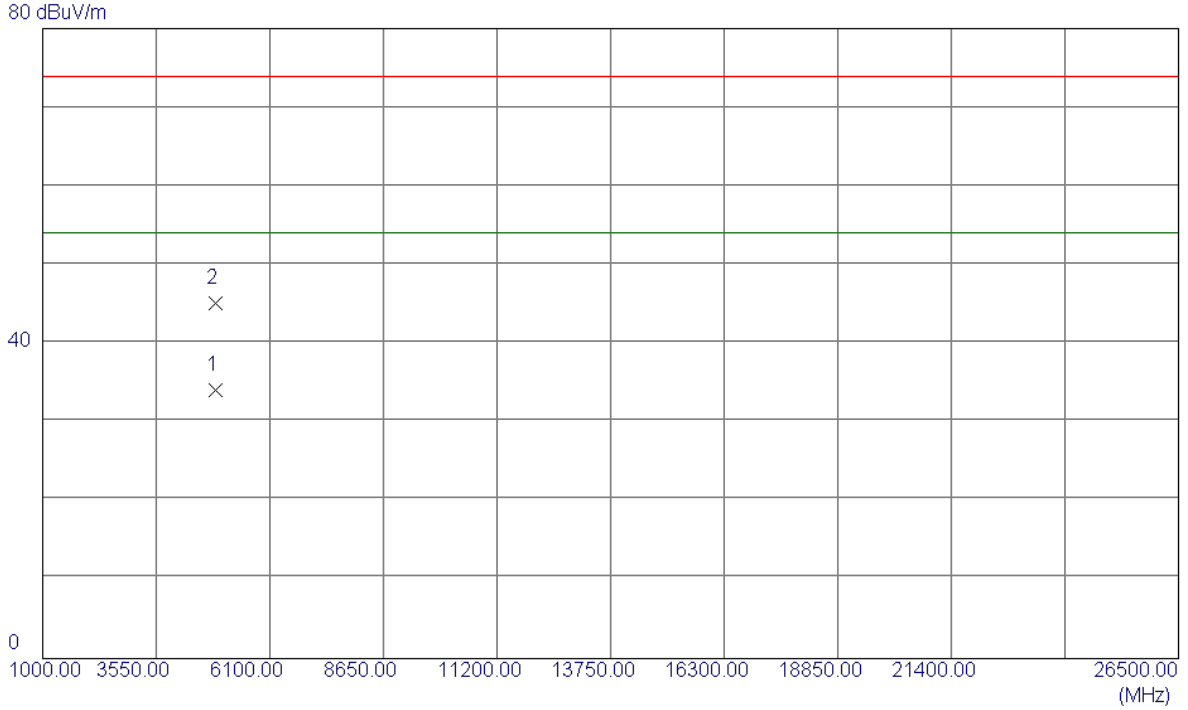

No.	Freq. MHz	Reading Level dBuV/m	Correct Factor dB	Measure ment dBuV/m	Limit dBuV/m	Margin dB	Detector	Comment
1 *	4874.0400	29.16	4.89	34.05	54.00	-19.95	AVG	
2	4874.0410	40.26	4.89	45.15	74.00	-28.85	Peak	

Orthogonal Axis :	X
Test Mode :	TX G MODE 2437MHz

Horizontal

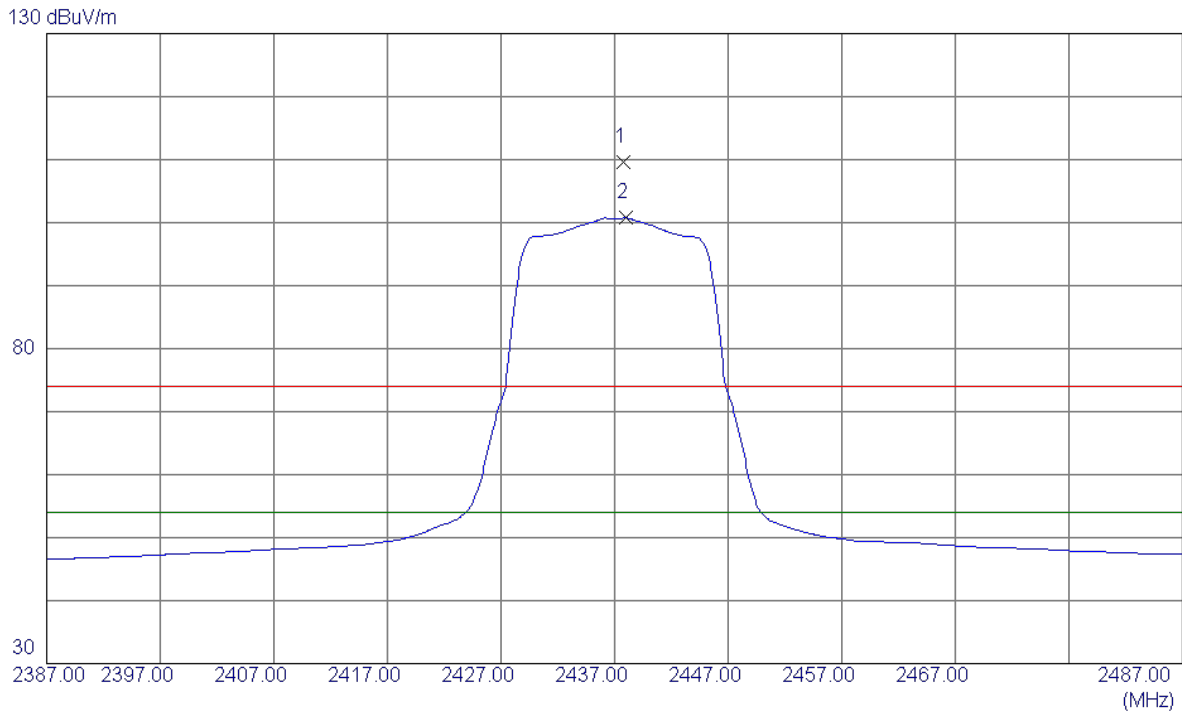

No.	Freq. MHz	Reading Level dBuV/m	Correct Factor dB	Measure ment dBuV/m	Limit dBuV/m	Margin dB	Detector	Comment
1	2437.8000	76.71	32.96	109.67	74.00	35.67	Peak	NO LIMIT
2 *	2438.0000	67.77	32.96	100.73	54.00	46.73	AVG	NO LIMIT

Orthogonal Axis :	X
Test Mode :	TX G MODE 2437MHz

Horizontal

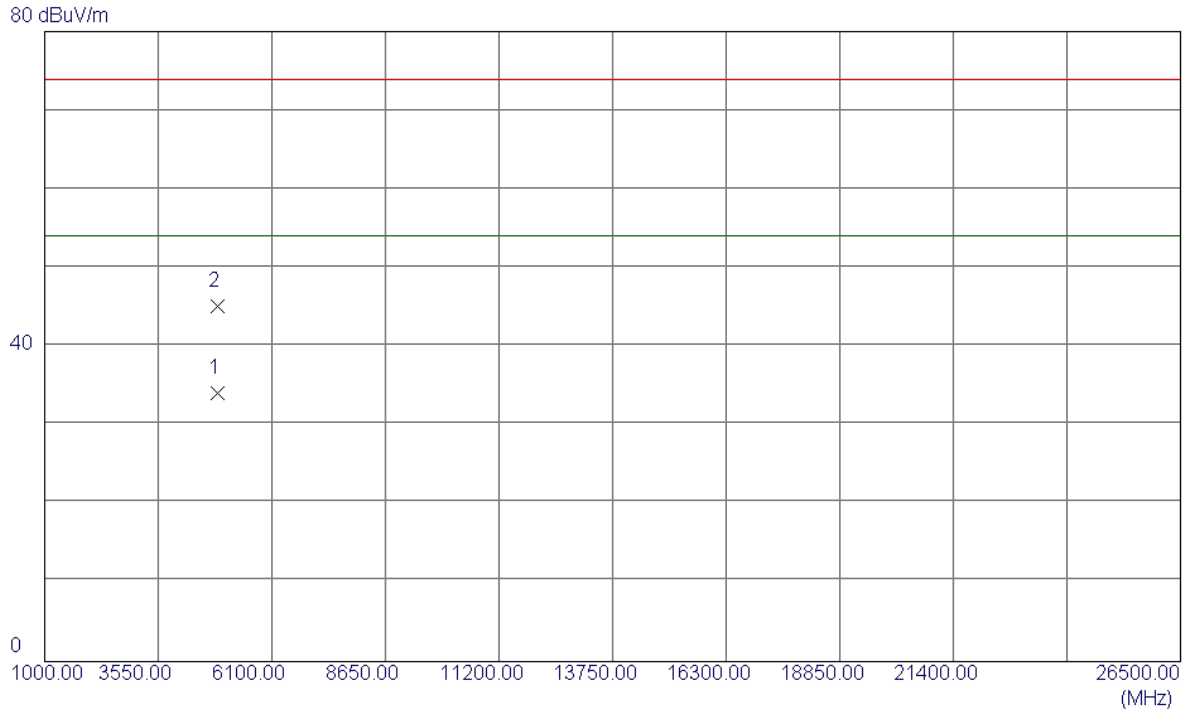

No.	Freq. MHz	Reading Level dBuV/m	Correct Factor dB	Measure ment dBuV/m	Limit dBuV/m	Margin dB	Detector	Comment
1 *	4873.8530	29.14	4.89	34.03	54.00	-19.97	AVG	
2	4874.0299	40.18	4.89	45.07	74.00	-28.93	Peak	

Orthogonal Axis :	X
Test Mode :	TX G MODE 2462MHz

Vertical

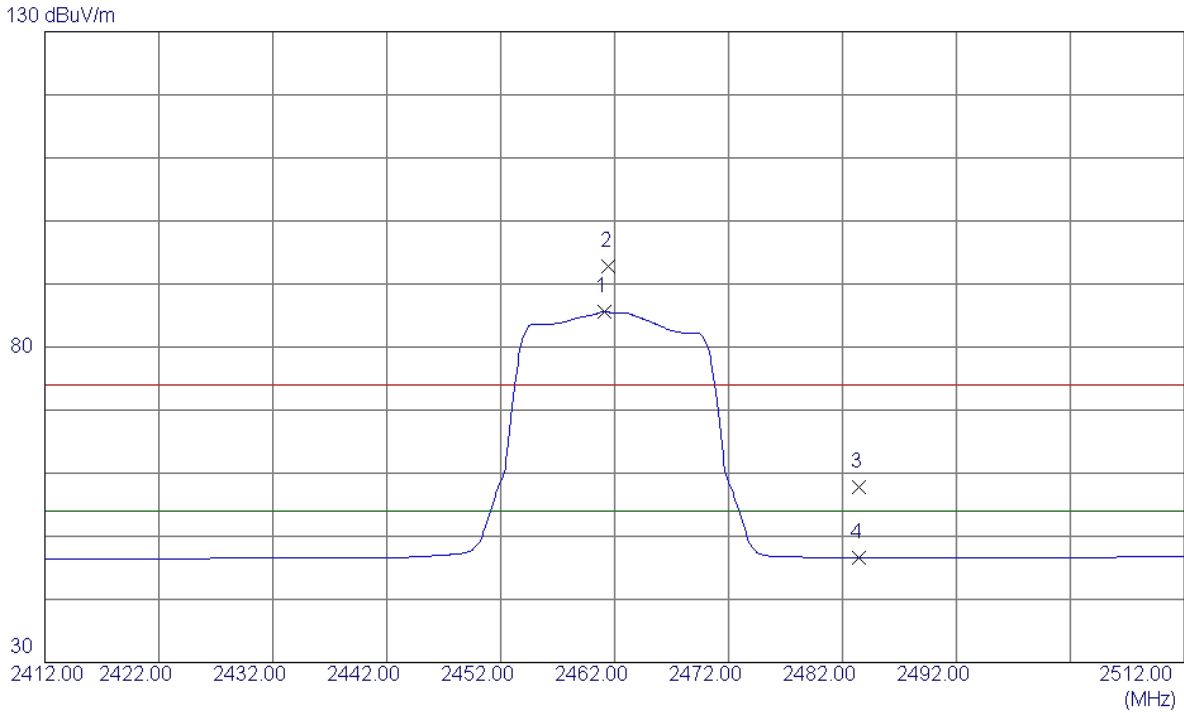

No.	Freq. MHz	Reading Level dBuV/m	Correct Factor dB	Measure ment dBuV/m	Limit dBuV/m	Margin dB	Detector	Comment
1 *	2461.1000	52.58	33.06	85.64	54.00	31.64	AVG	NO LIMIT
2	2461.5000	59.70	33.06	92.76	74.00	18.76	Peak	NO LIMIT
3	2483.5000	24.66	33.15	57.81	74.00	-16.19	Peak	
4	2483.5000	13.37	33.15	46.52	54.00	-7.48	AVG	

Orthogonal Axis :	X
Test Mode :	TX G MODE 2462MHz

Vertical

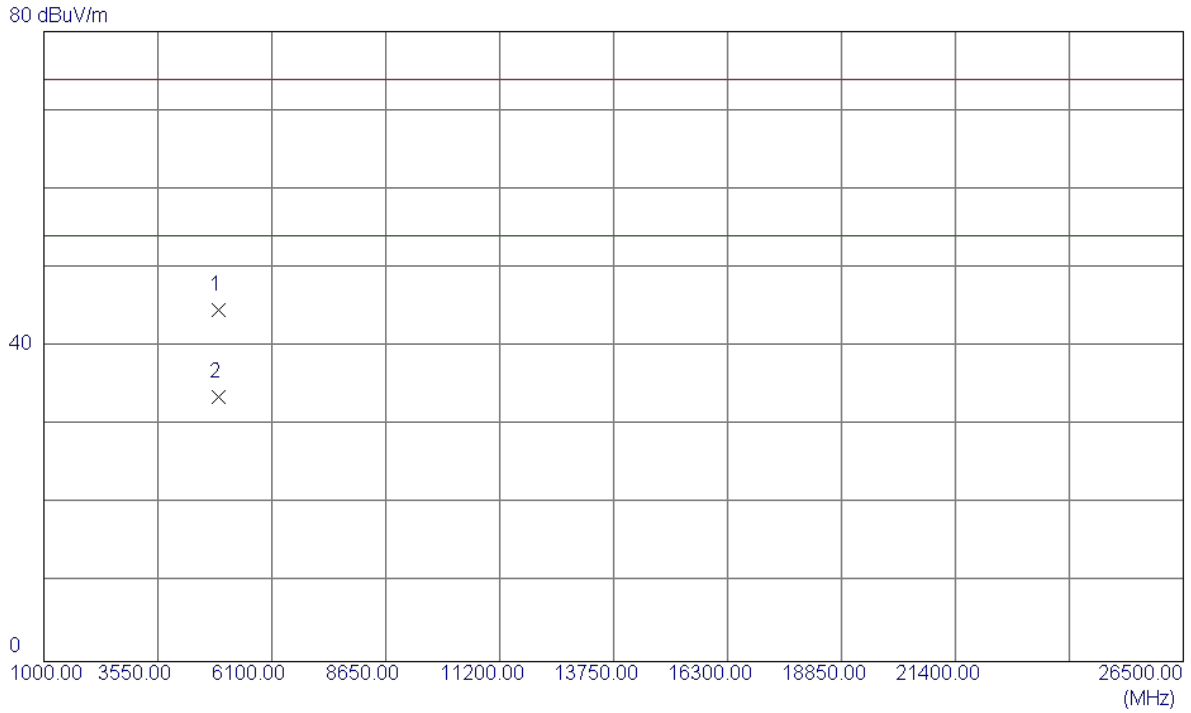

No.	Freq. MHz	Reading Level dBuV/m	Correct Factor dB	Measurement dBuV/m	Limit dBuV/m	Margin dB	Detector	Comment
1	4924.0210	39.50	5.08	44.58	74.00	-29.42	Peak	
2 *	4924.0680	28.56	5.08	33.64	54.00	-20.36	AVG	

Orthogonal Axis :	X
Test Mode :	TX G MODE 2462MHz

Horizontal

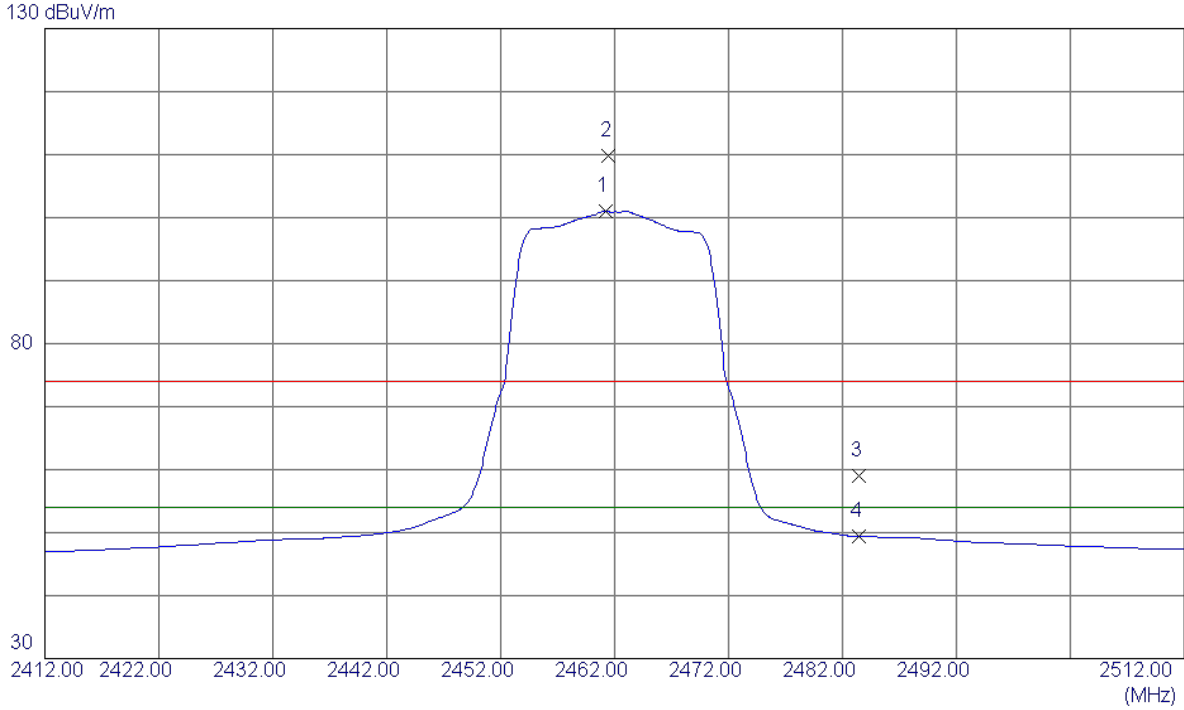

No.	Freq. MHz	Reading Level dBuV/m	Correct Factor dB	Measure ment dBuV/m	Limit dBuV/m	Margin dB	Detector	Comment
1 *	2461.2000	67.94	33.06	101.00	54.00	47.00	AVG	NO LIMIT
2	2461.5000	76.82	33.06	109.88	74.00	35.88	Peak	NO LIMIT
3	2483.5000	25.77	33.15	58.92	74.00	-15.08	Peak	
4	2483.5000	16.20	33.15	49.35	54.00	-4.65	AVG	

Orthogonal Axis :	X
Test Mode :	TX G MODE 2462MHz

Horizontal

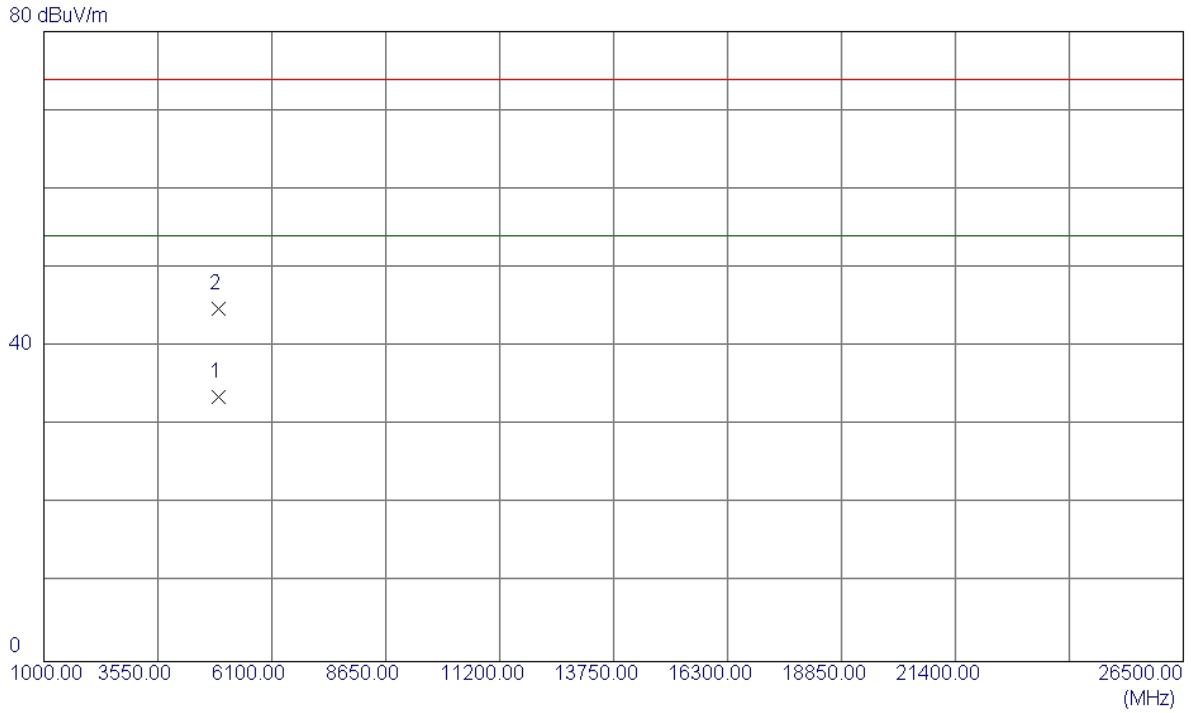

No.	Freq. MHz	Reading Level dBuV/m	Correct Factor dB	Measure ment dBuV/m	Limit dBuV/m	Margin dB	Detector	Comment
1 *	4923.9200	28.48	5.08	33.56	54.00	-20.44	AVG	
2	4924.0700	39.71	5.08	44.79	74.00	-29.21	Peak	

Orthogonal Axis :	X
Test Mode :	TX N-20M MODE 2412MHZ

Vertical

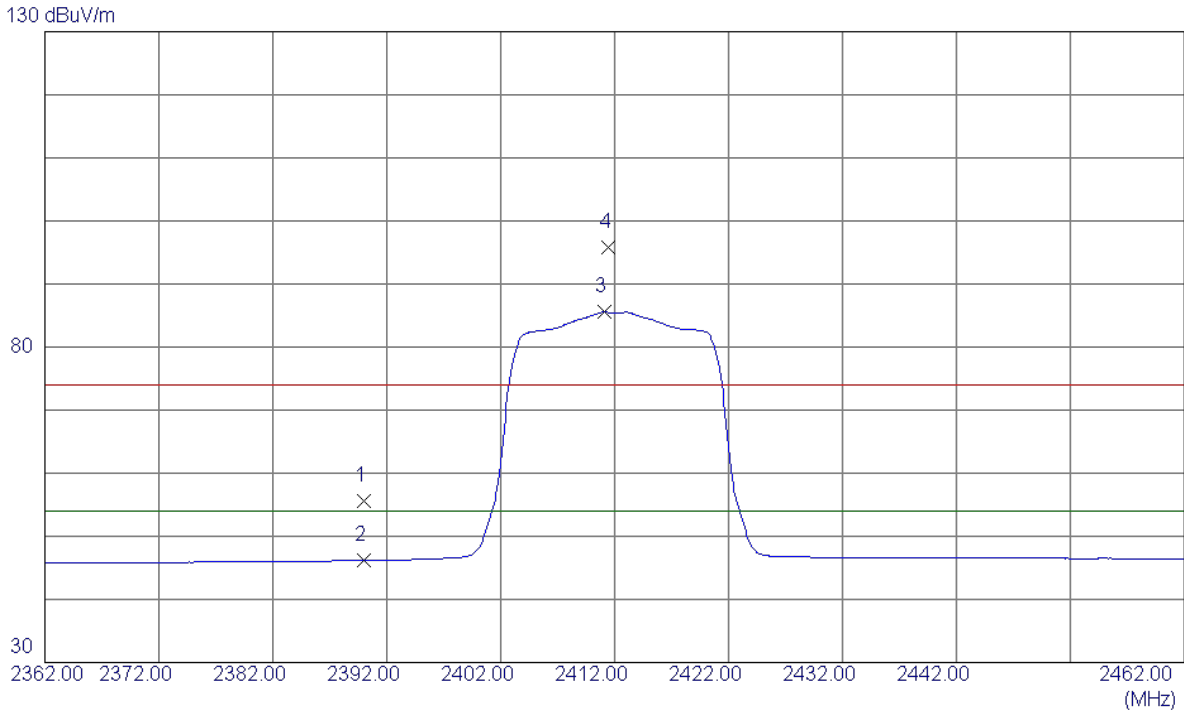

No.	Freq. MHz	Reading Level dBuV/m	Correct Factor dB	Measure ment dBuV/m	Limit dBuV/m	Margin dB	Detector	Comment
1	2390.0000	22.84	32.77	55.61	74.00	-18.39	Peak	
2	2390.0000	13.39	32.77	46.16	54.00	-7.84	AVG	
3 *	2411.1000	52.71	32.85	85.56	54.00	31.56	AVG	NO LIMIT
4	2411.5000	62.95	32.86	95.81	74.00	21.81	Peak	NO LIMIT

Orthogonal Axis :	X
Test Mode :	TX N-20M MODE 2412MHz

Vertical

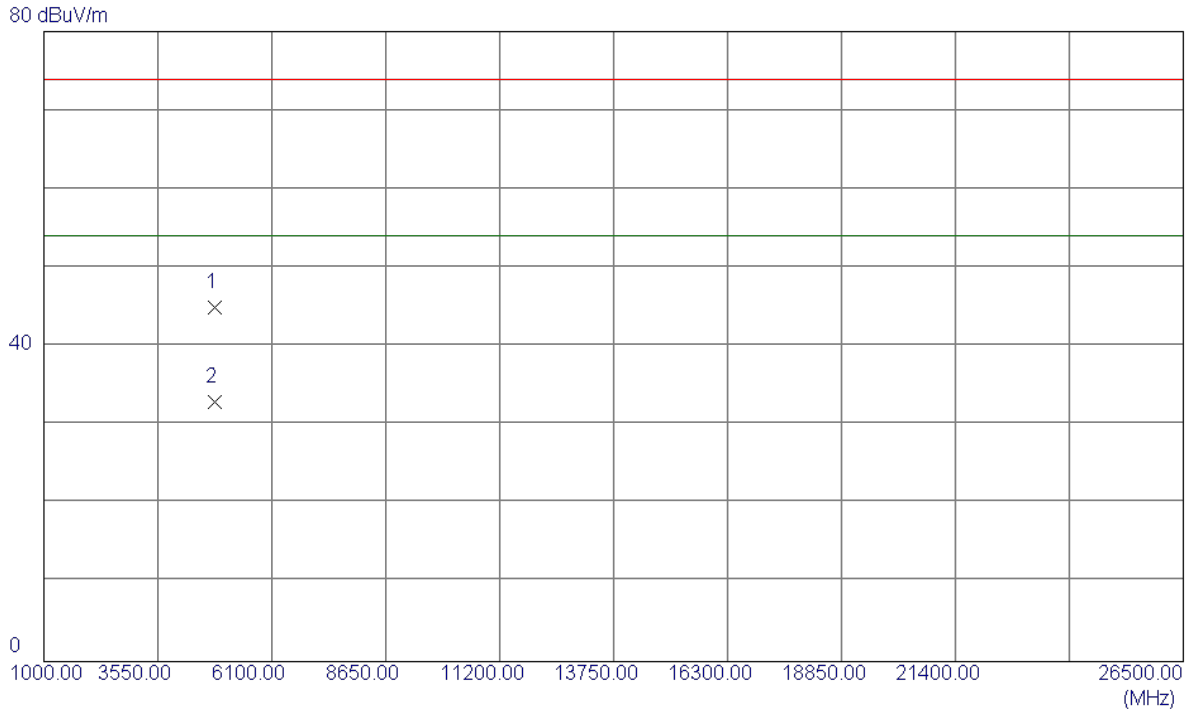

No.	Freq. MHz	Reading Level dBuV/m	Correct Factor dB	Measure ment dBuV/m	Limit dBuV/m	Margin dB	Detector	Comment
1	4823.7900	40.31	4.69	45.00	74.00	-29.00	Peak	
2 *	4823.7599	28.25	4.69	32.94	54.00	-21.06	AVG	

Orthogonal Axis :	X
Test Mode :	TX N-20M MODE 2412MHZ

Horizontal

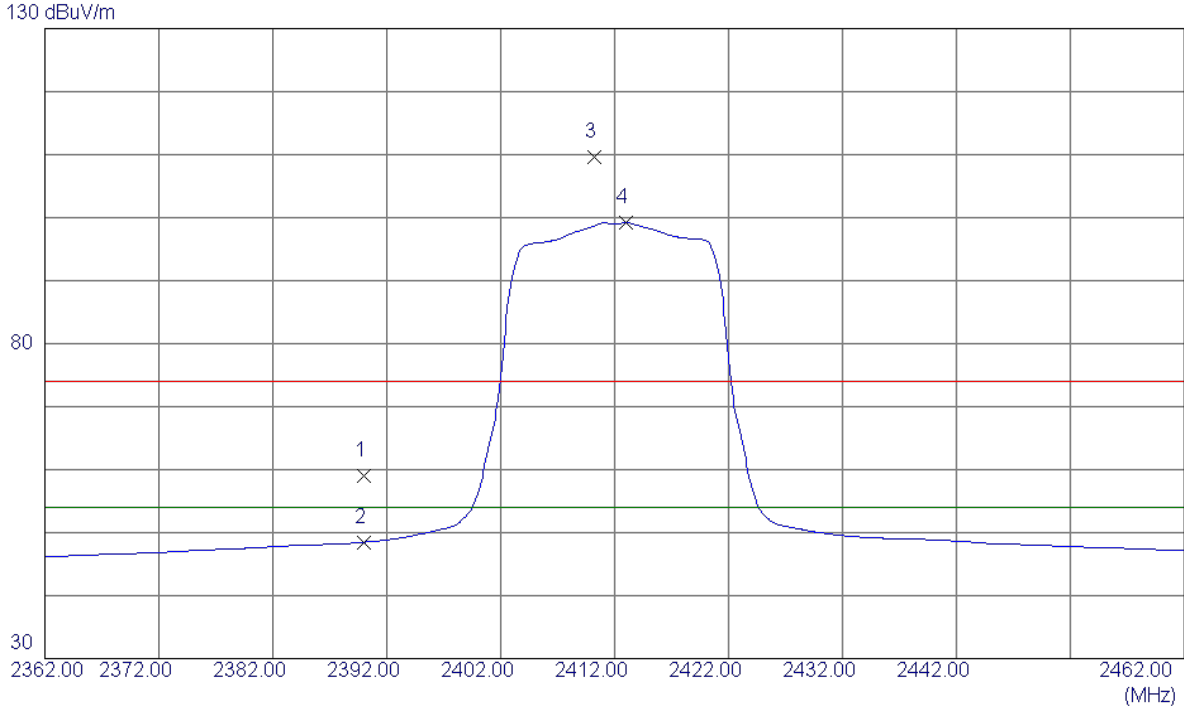

No.	Freq. MHz	Reading Level dBuV/m	Correct Factor dB	Measure ment dBuV/m	Limit dBuV/m	Margin dB	Detector	Comment
1	2390.0000	26.26	32.77	59.03	74.00	-14.97	Peak	
2	2390.0000	15.71	32.77	48.48	54.00	-5.52	AVG	
3	2410.2000	76.71	32.85	109.56	74.00	35.56	Peak	NO LIMIT
4 *	2413.0000	66.37	32.86	99.23	54.00	45.23	AVG	NO LIMIT

Orthogonal Axis :	X
Test Mode :	TX N-20M MODE 2412MHz

Horizontal

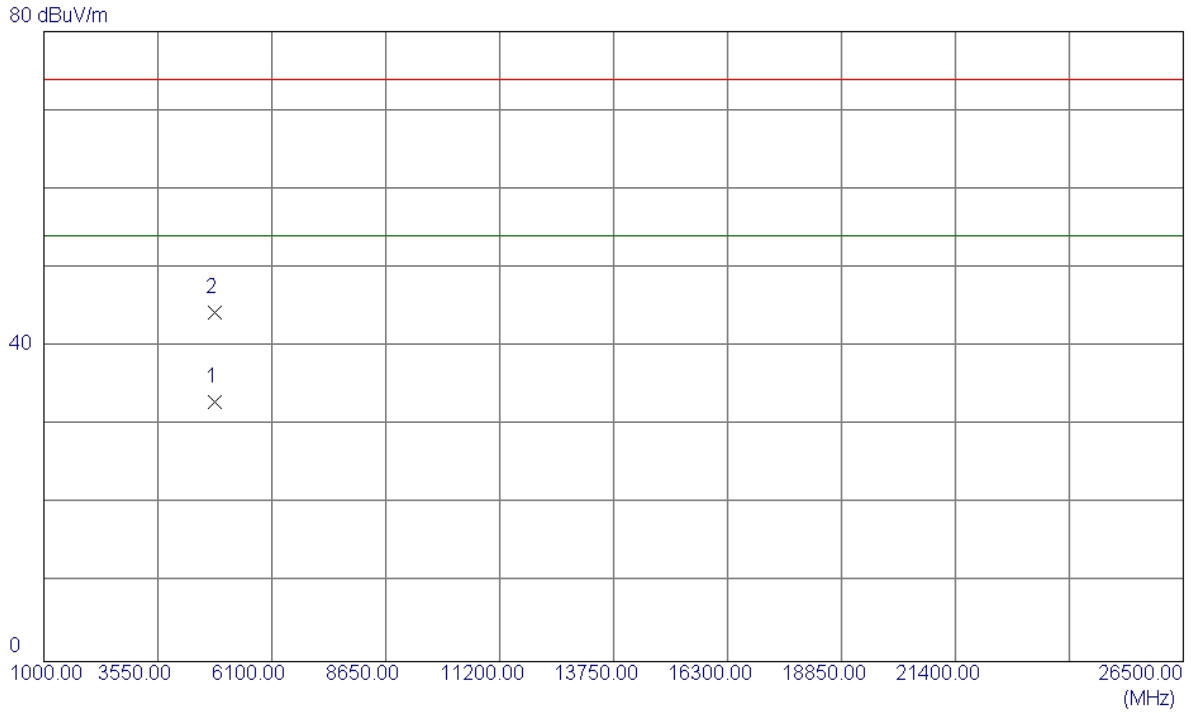

No.	Freq. MHz	Reading Level dBuV/m	Correct Factor dB	Measure ment dBuV/m	Limit dBuV/m	Margin dB	Detector	Comment
1 *	4824.8000	28.25	4.70	32.95	54.00	-21.05	AVG	
2	4824.2100	39.57	4.69	44.26	74.00	-29.74	Peak	

Orthogonal Axis :	X
Test Mode :	TX N-20M MODE 2437MHz

Vertical

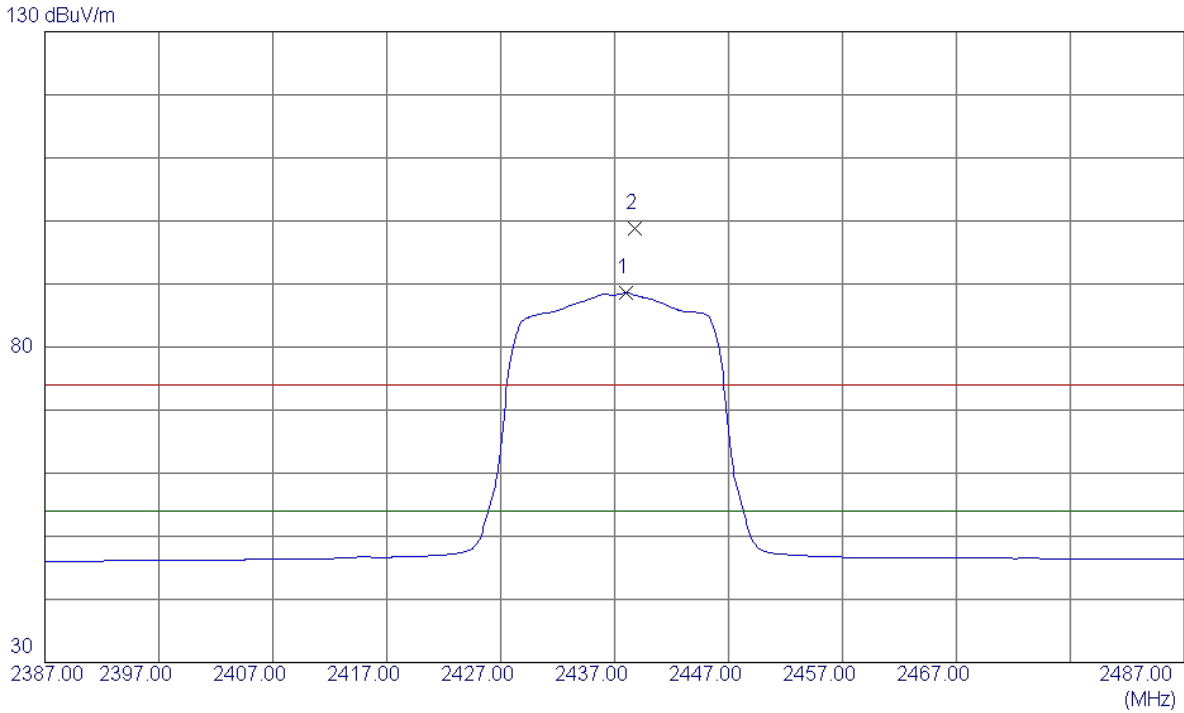

No.	Freq. MHz	Reading Level dBuV/m	Correct Factor dB	Measure ment dBuV/m	Limit dBuV/m	Margin dB	Detector	Comment
1 *	2438.0000	55.61	32.96	88.57	54.00	34.57	AVG	NO LIMIT
2	2438.8000	65.89	32.97	98.86	74.00	24.86	Peak	NO LIMIT

Orthogonal Axis :	X
Test Mode :	TX N-20M MODE 2437MHz

Vertical

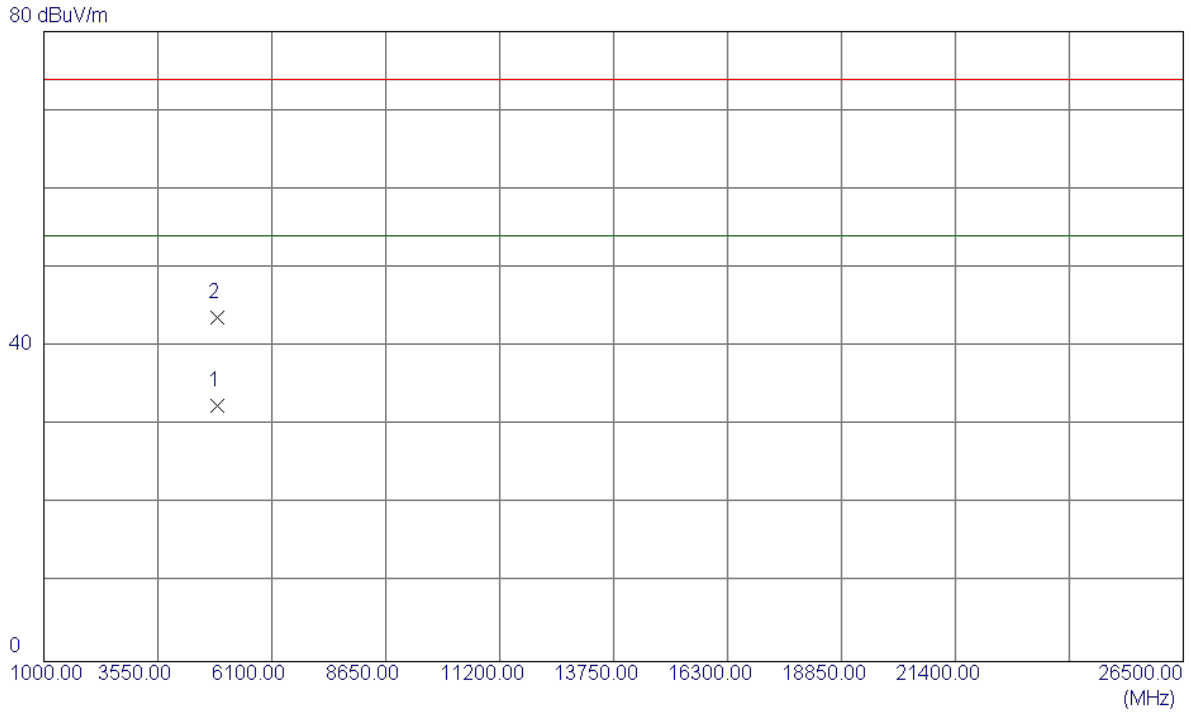

No.	Freq. MHz	Reading Level dBuV/m	Correct Factor dB	Measure ment dBuV/m	Limit dBuV/m	Margin dB	Detector	Comment
1 *	4874.1200	27.56	4.89	32.45	54.00	-21.55	AVG	
2	4874.1400	38.82	4.89	43.71	74.00	-30.29	Peak	

Orthogonal Axis :	X
Test Mode :	TX N-20M MODE 2437MHz

Horizontal

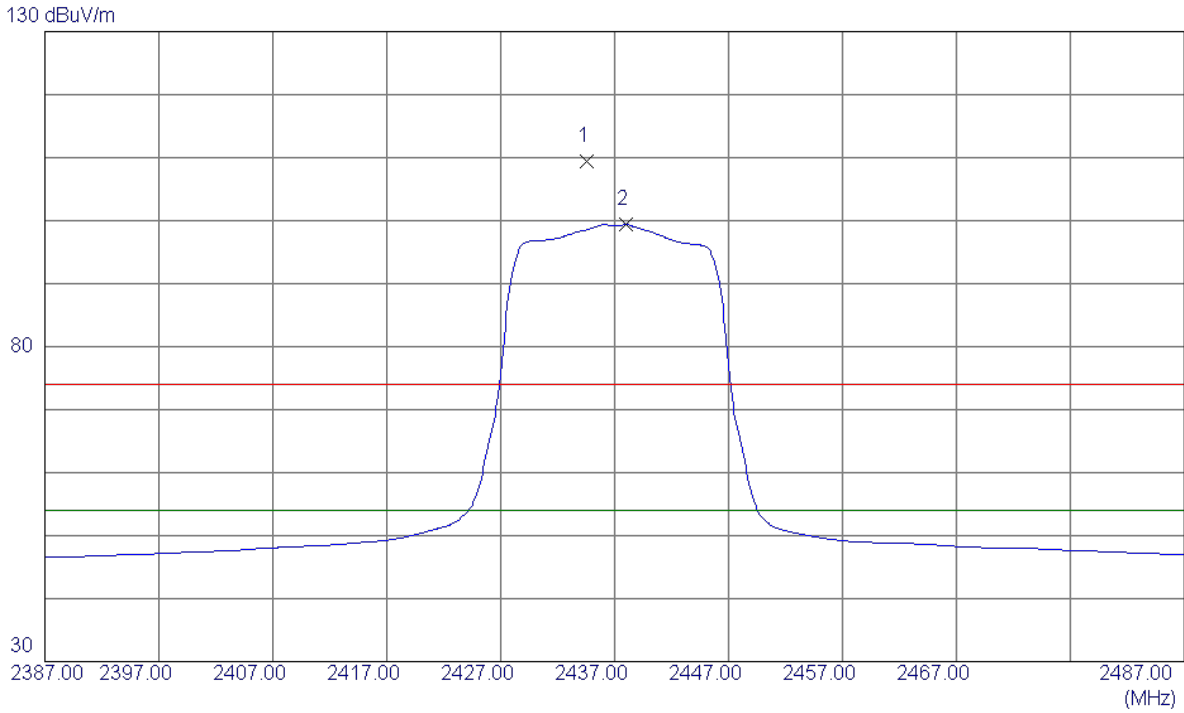

No.	Freq. MHz	Reading Level dBuV/m	Correct Factor dB	Measure ment dBuV/m	Limit dBuV/m	Margin dB	Detector	Comment
1	2434.6000	76.45	32.95	109.40	74.00	35.40	Peak	NO LIMIT
2 *	2438.0000	66.41	32.96	99.37	54.00	45.37	AVG	NO LIMIT

Orthogonal Axis :	X
Test Mode :	TX N-20M MODE 2437MHz

Horizontal

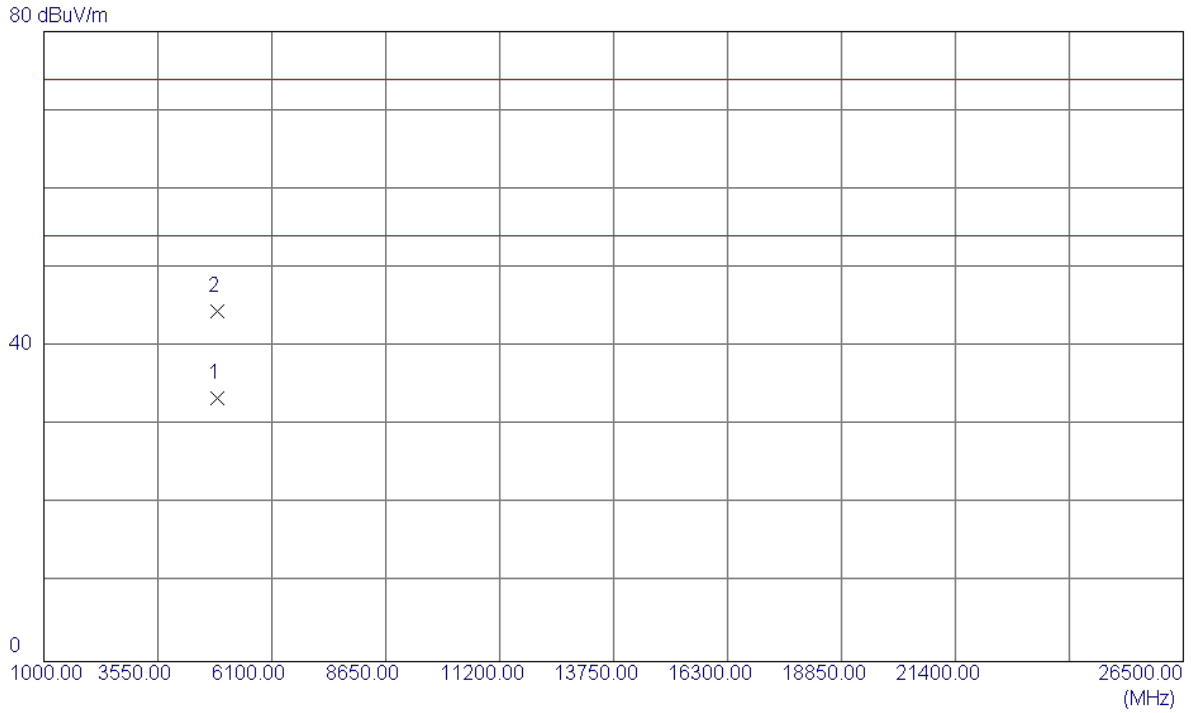

No.	Freq. MHz	Reading Level dBuV/m	Correct Factor dB	Measure ment dBuV/m	Limit dBuV/m	Margin dB	Detector	Comment
1 *	4873.7519	28.48	4.89	33.37	54.00	-20.63	AVG	
2	4874.6800	39.57	4.89	44.46	74.00	-29.54	Peak	

Orthogonal Axis :	X
Test Mode :	TX N-20M MODE 2462MHz

Vertical

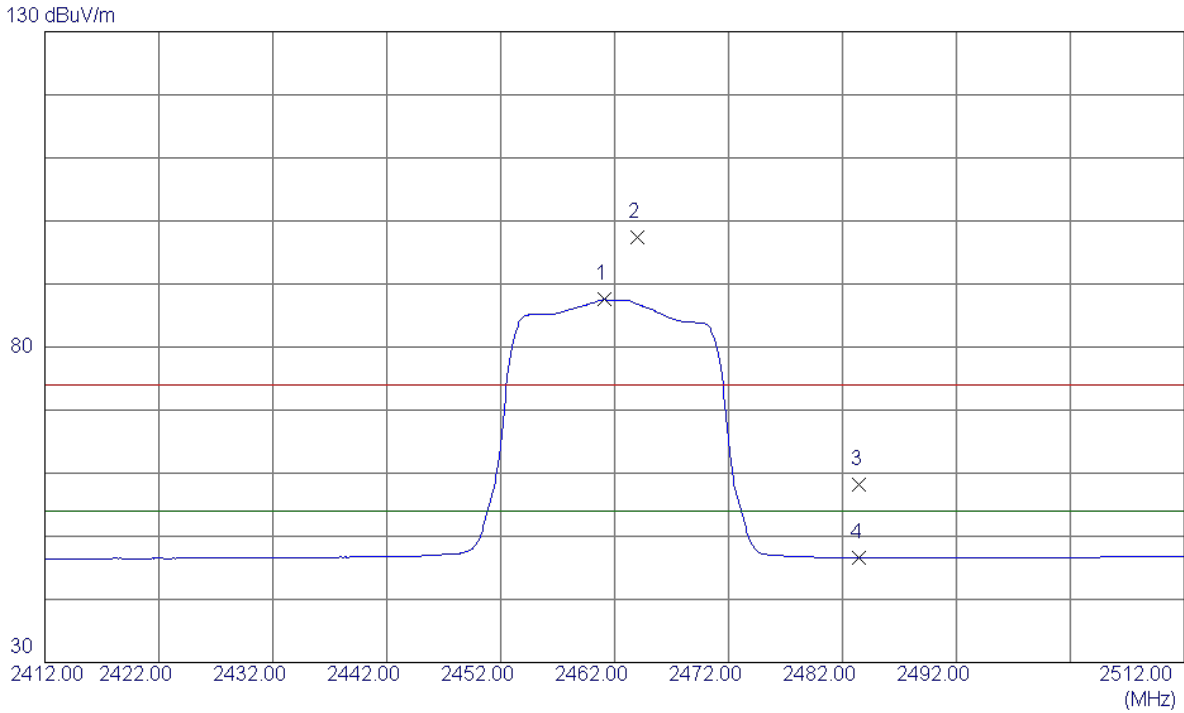

No.	Freq. MHz	Reading Level dBuV/m	Correct Factor dB	Measure ment dBuV/m	Limit dBuV/m	Margin dB	Detector	Comment
1 *	2461.1000	54.47	33.06	87.53	54.00	33.53	AVG	NO LIMIT
2	2464.0000	64.42	33.07	97.49	74.00	23.49	Peak	NO LIMIT
3	2483.5000	24.96	33.15	58.11	74.00	-15.89	Peak	
4	2483.5000	13.41	33.15	46.56	54.00	-7.44	AVG	

Orthogonal Axis :	X
Test Mode :	TX N-20M MODE 2462MHz

Vertical

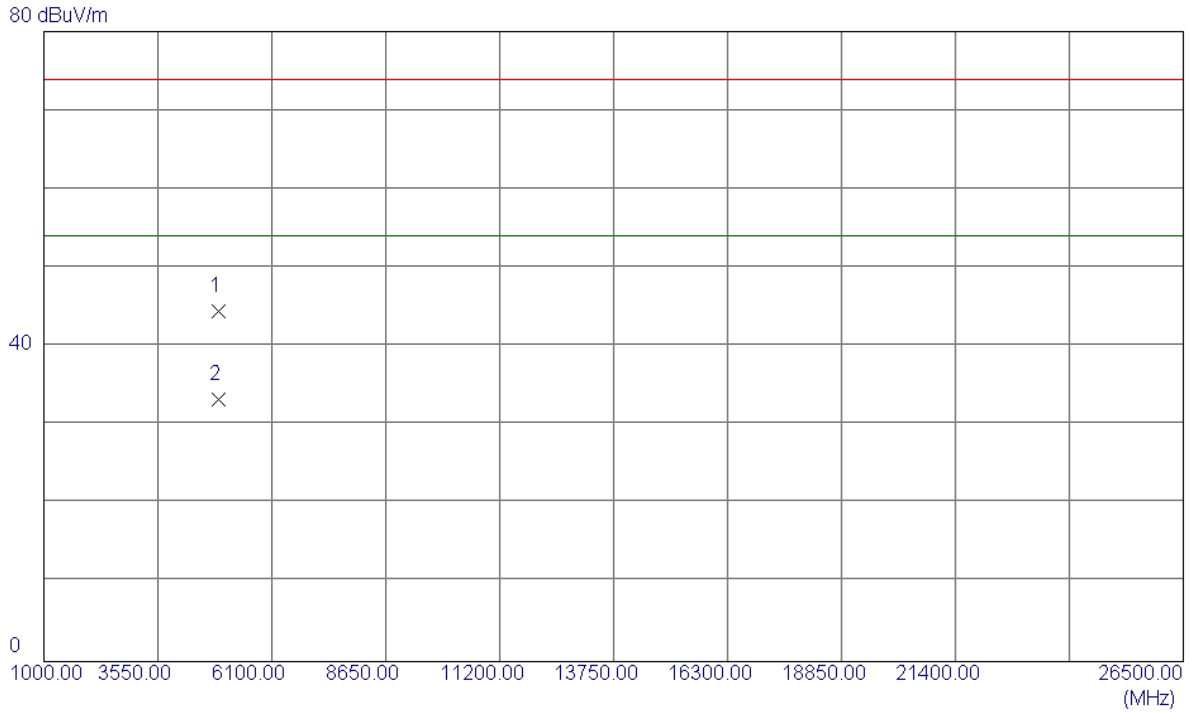

No.	Freq. MHz	Reading Level dBuV/m	Correct Factor dB	Measure ment dBuV/m	Limit dBuV/m	Margin dB	Detector	Comment
1	4924.0210	39.46	5.08	44.54	74.00	-29.46	Peak	
2 *	4924.0900	28.26	5.08	33.34	54.00	-20.66	AVG	

Orthogonal Axis :	X
Test Mode :	TX N-20M MODE 2462MHz

Horizontal

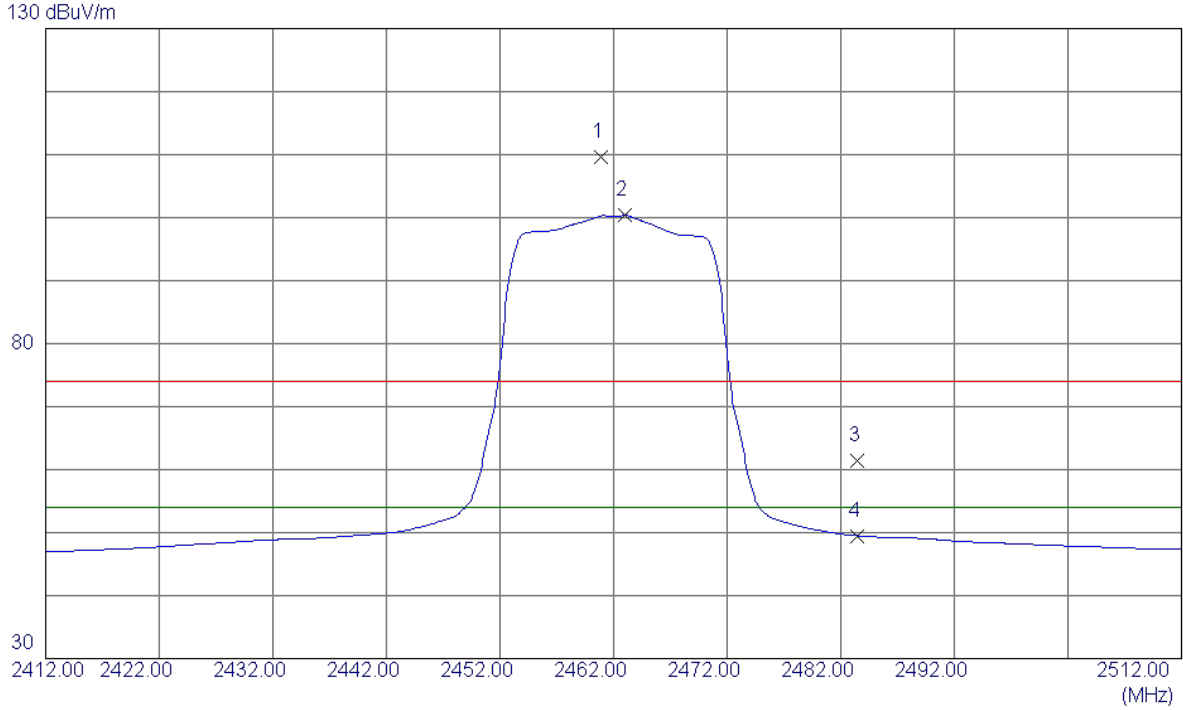

No.	Freq. MHz	Reading Level dBuV/m	Correct Factor dB	Measure ment dBuV/m	Limit dBuV/m	Margin dB	Detector	Comment
1	2460.9000	76.60	33.06	109.66	74.00	35.66	Peak	NO LIMIT
2 *	2463.0000	67.29	33.07	100.36	54.00	46.36	AVG	NO LIMIT
3	2483.5000	28.17	33.15	61.32	74.00	-12.68	Peak	
4	2483.5000	16.33	33.15	49.48	54.00	-4.52	AVG	

Orthogonal Axis :	X
Test Mode :	TX N-20M MODE 2462MHz

Horizontal

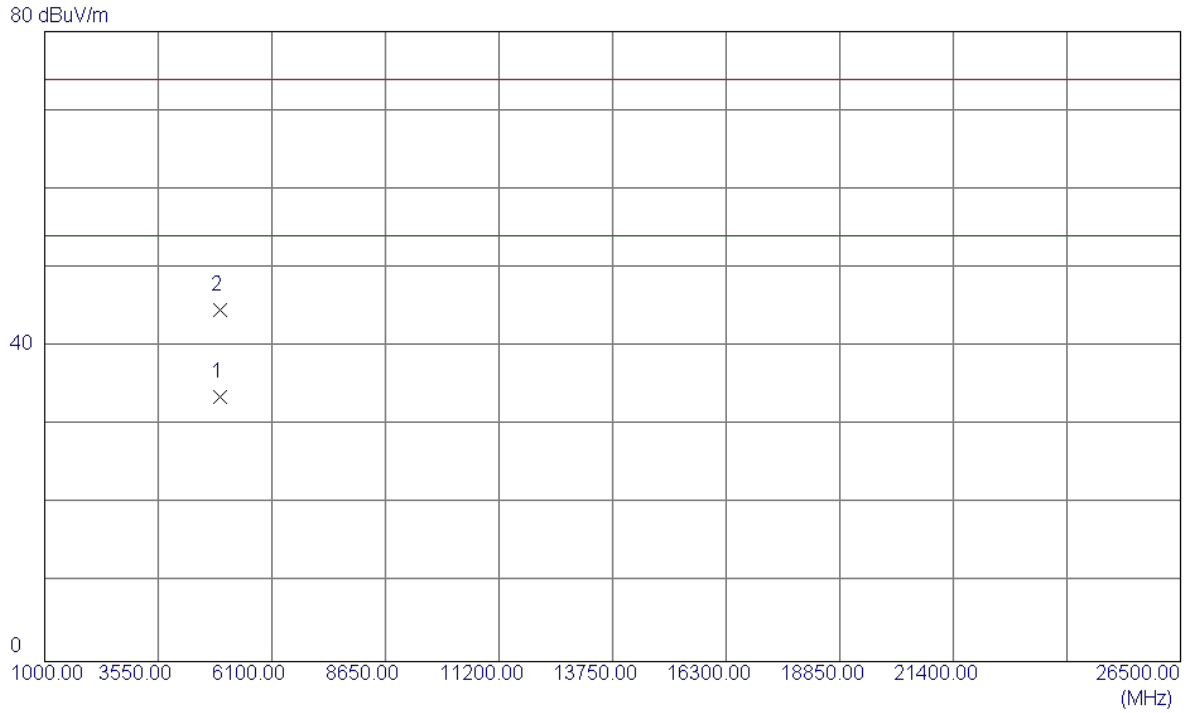

No.	Freq. MHz	Reading Level dBuV/m	Correct Factor dB	Measure ment dBuV/m	Limit dBuV/m	Margin dB	Detector	Comment
1 *	4924.3400	28.57	5.08	33.65	54.00	-20.35	AVG	
2	4924.2700	39.63	5.08	44.71	74.00	-29.29	Peak	

Orthogonal Axis :	X
Test Mode :	TX N-40M MODE 2422MHz

Vertical

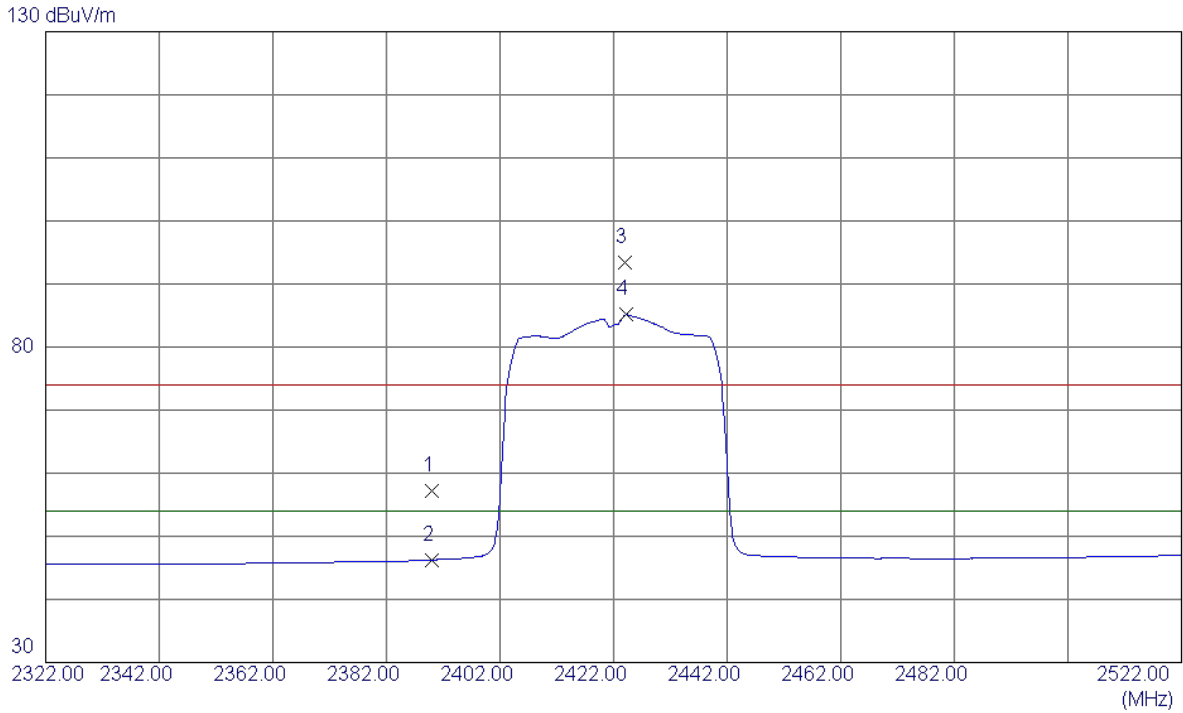

No.	Freq. MHz	Reading Level dBuV/m	Correct Factor dB	Measure ment dBuV/m	Limit dBuV/m	Margin dB	Detector	Comment
1	2390.0000	24.50	32.77	57.27	74.00	-16.73	Peak	
2	2390.0000	13.50	32.77	46.27	54.00	-7.73	AVG	
3	2424.0000	60.40	32.91	93.31	74.00	19.31	Peak	NO LIMIT
4 *	2424.2000	52.20	32.91	85.11	54.00	31.11	AVG	NO LIMIT

Orthogonal Axis :	X
Test Mode :	TX N-40M MODE 2422MHz

Vertical

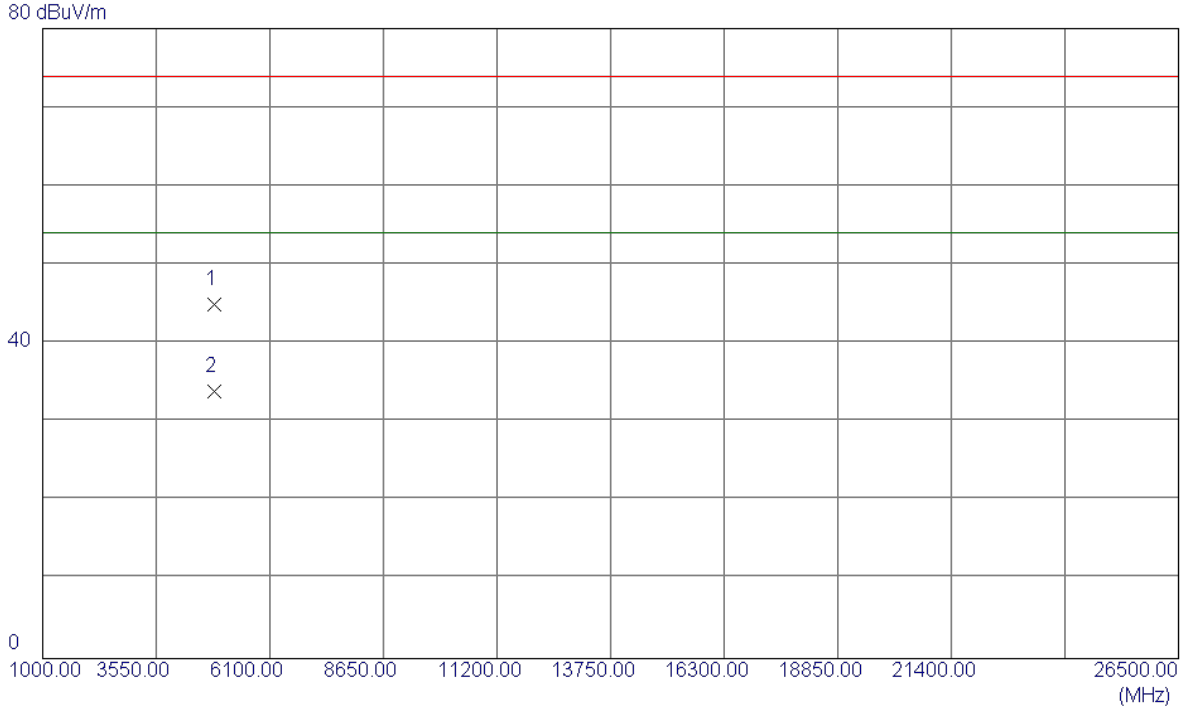

No.	Freq. MHz	Reading Level dBuV/m	Correct Factor dB	Measure ment dBuV/m	Limit dBuV/m	Margin dB	Detector	Comment
1	4844.8100	40.23	4.77	45.00	74.00	-29.00	Peak	
2 *	4843.7900	29.08	4.77	33.85	54.00	-20.15	AVG	

Orthogonal Axis :	X
Test Mode :	TX N-40M MODE 2422MHz

Horizontal

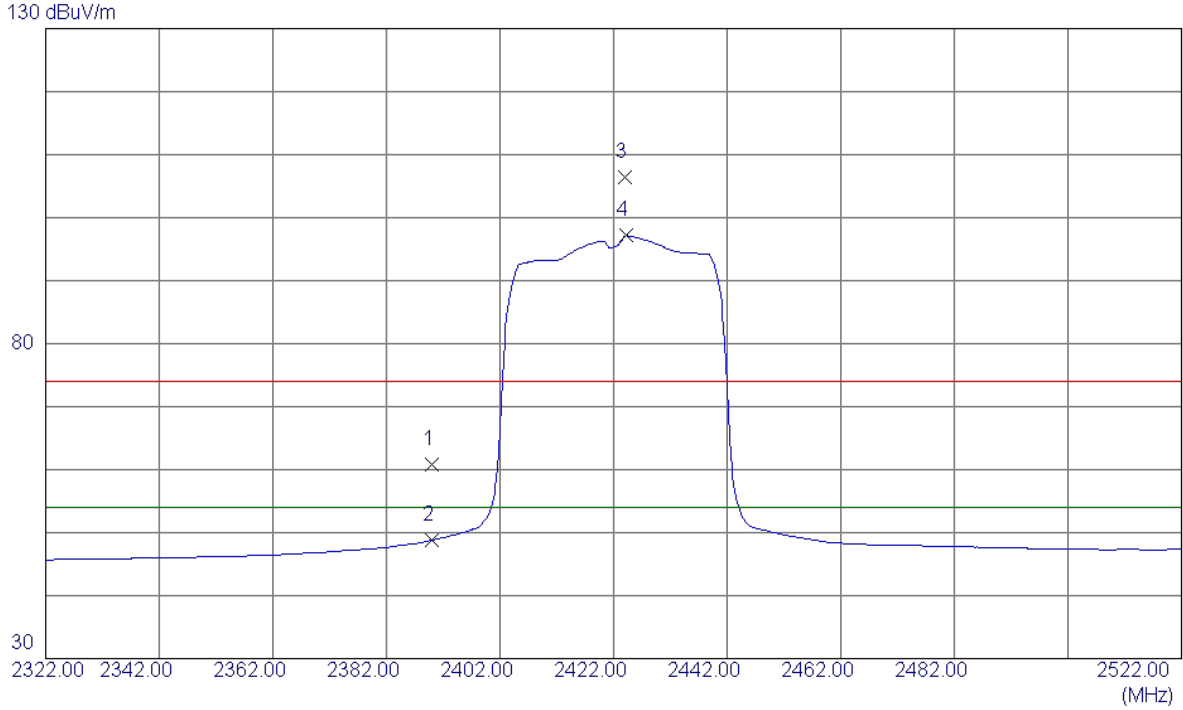

No.	Freq. MHz	Reading Level dBuV/m	Correct Factor dB	Measure ment dBuV/m	Limit dBuV/m	Margin dB	Detector	Comment
1	2390.0000	28.01	32.77	60.78	74.00	-13.22	Peak	
2	2390.0000	16.04	32.77	48.81	54.00	-5.19	AVG	
3	2424.0000	73.49	32.91	106.40	74.00	32.40	Peak	NO LIMIT
4 *	2424.2000	64.21	32.91	97.12	54.00	43.12	AVG	NO LIMIT

Orthogonal Axis :	X
Test Mode :	TX N-40M MODE 2422MHz

Horizontal

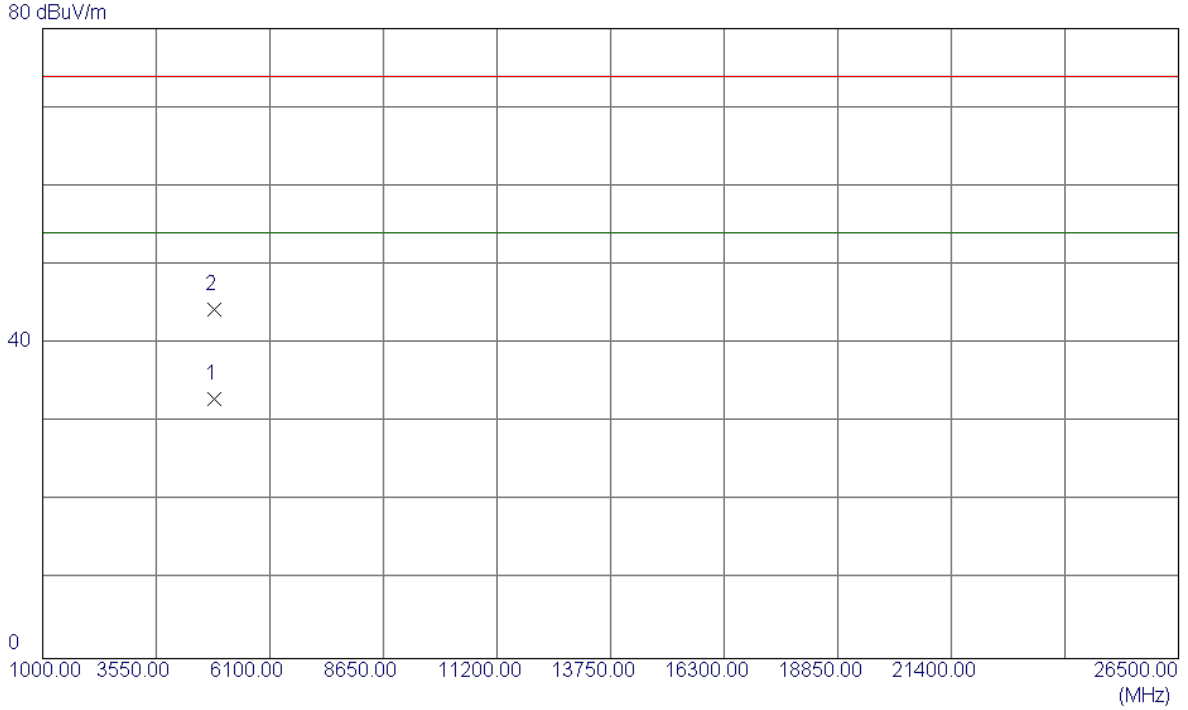

No.	Freq. MHz	Reading Level dBuV/m	Correct Factor dB	Measure ment dBuV/m	Limit dBuV/m	Margin dB	Detector	Comment
1 *	4844.1200	28.12	4.77	32.89	54.00	-21.11	AVG	
2	4843.0200	39.58	4.77	44.35	74.00	-29.65	Peak	

Orthogonal Axis :	X
Test Mode :	TX N-40M MODE 2437MHz

Vertical

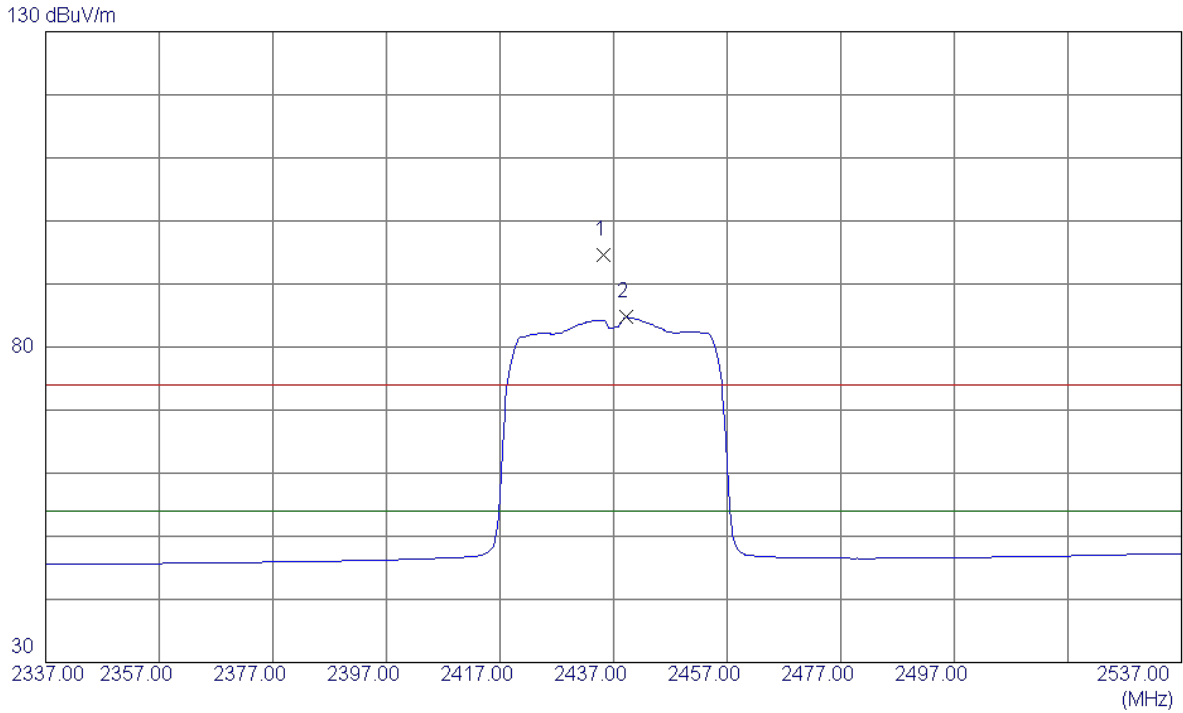

No.	Freq. MHz	Reading Level dBuV/m	Correct Factor dB	Measure ment dBuV/m	Limit dBuV/m	Margin dB	Detector	Comment
1	2435.2000	61.61	32.95	94.56	74.00	20.56	Peak	NO LIMIT
2 *	2439.2000	51.75	32.97	84.72	54.00	30.72	AVG	NO LIMIT

Orthogonal Axis :	X
Test Mode :	TX N-40M MODE 2437MHz

Vertical

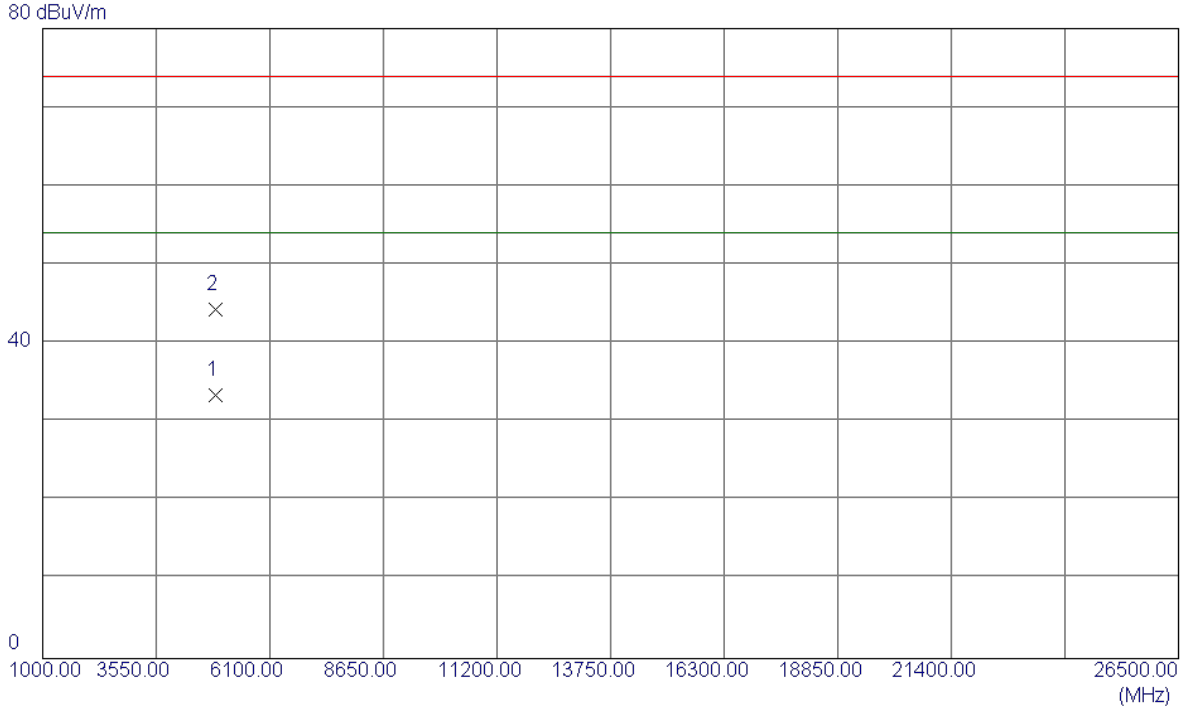

No.	Freq. MHz	Reading Level dBuV/m	Correct Factor dB	Measure ment dBuV/m	Limit dBuV/m	Margin dB	Detector	Comment
1 *	4874.0400	28.51	4.89	33.40	54.00	-20.60	AVG	
2	4874.0520	39.36	4.89	44.25	74.00	-29.75	Peak	

Orthogonal Axis :	X
Test Mode :	TX N-40M MODE 2437MHz

Horizontal

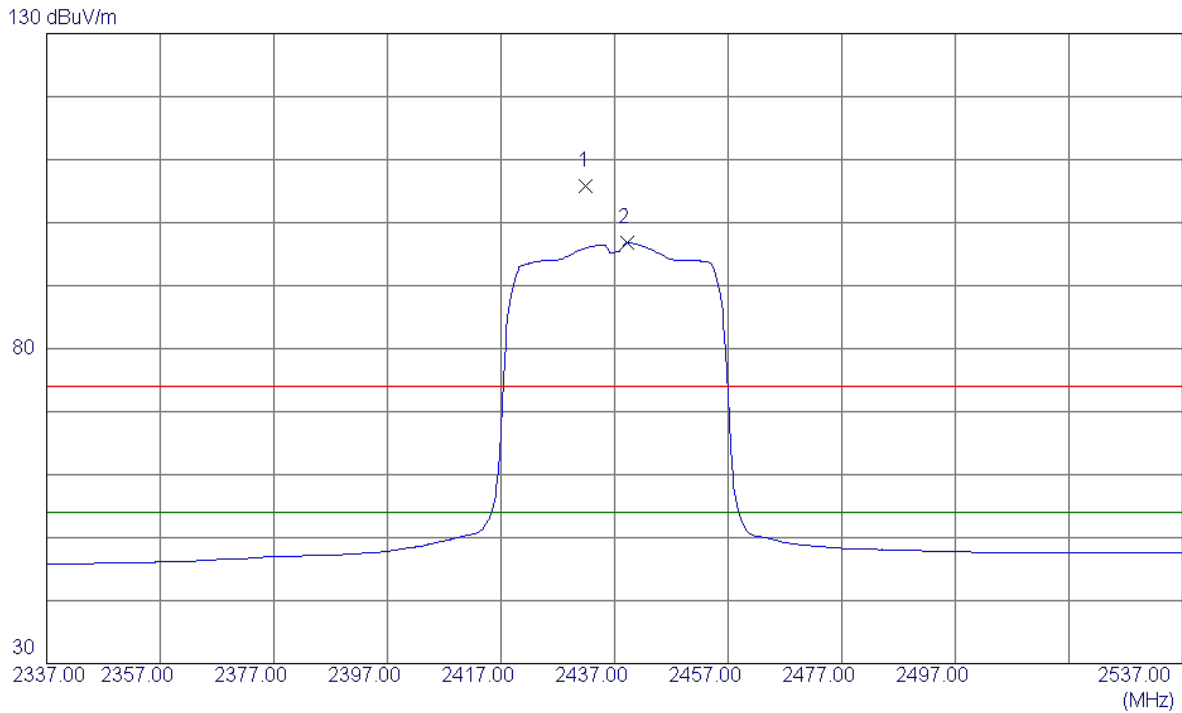

No.	Freq. MHz	Reading Level dBuV/m	Correct Factor dB	Measure ment dBuV/m	Limit dBuV/m	Margin dB	Detector	Comment
1	2432.0000	72.92	32.94	105.86	74.00	31.86	Peak	NO LIMIT
2 *	2439.2000	63.90	32.97	96.87	54.00	42.87	AVG	NO LIMIT

Orthogonal Axis :	X
Test Mode :	TX N-40M MODE 2437MHz

Horizontal

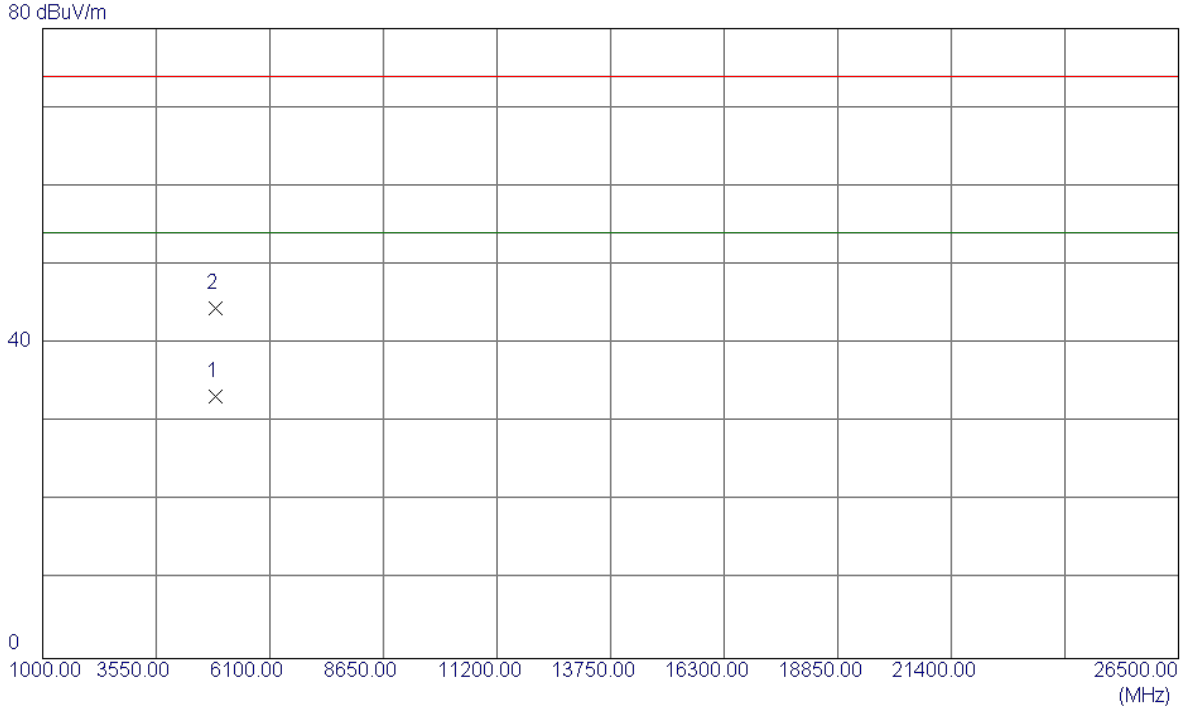

No.	Freq. MHz	Reading Level dBuV/m	Correct Factor dB	Measure ment dBuV/m	Limit dBuV/m	Margin dB	Detector	Comment
1 *	4873.9200	28.40	4.89	33.29	54.00	-20.71	AVG	
2	4874.8900	39.52	4.89	44.41	74.00	-29.59	Peak	

Orthogonal Axis :	X
Test Mode :	TX N-40M MODE 2452MHz

Vertical

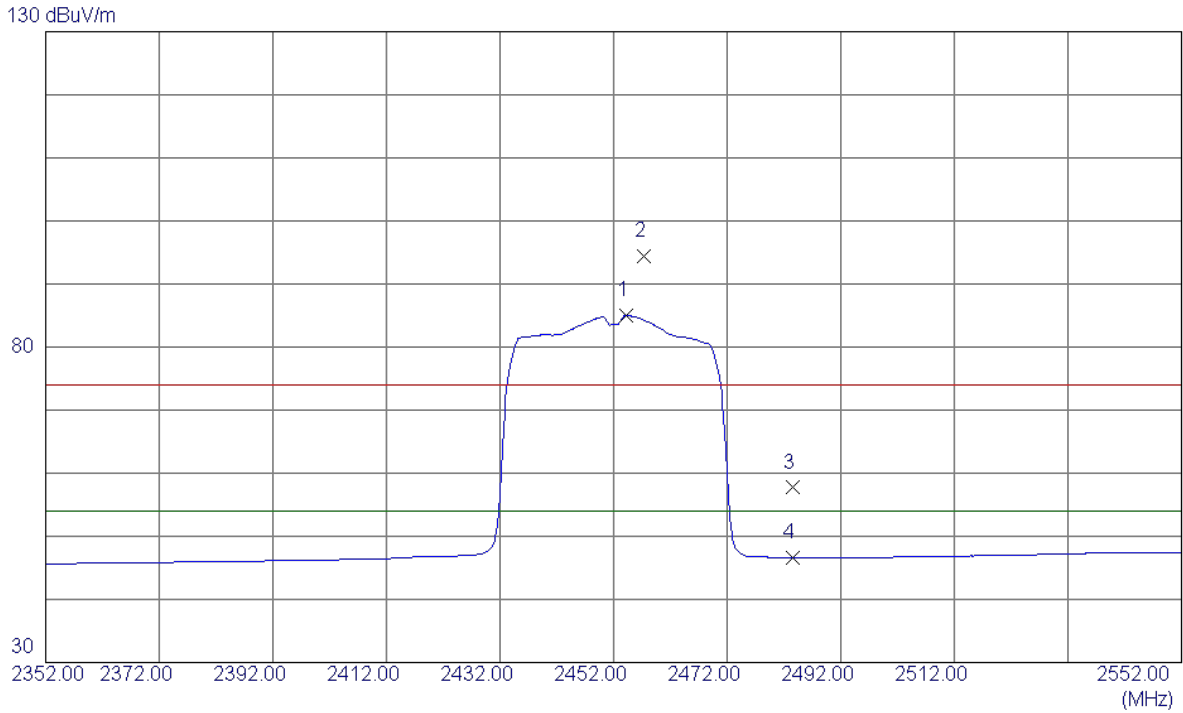

No.	Freq. MHz	Reading Level dBuV/m	Correct Factor dB	Measure ment dBuV/m	Limit dBuV/m	Margin dB	Detector	Comment
1 *	2454.2000	52.06	33.03	85.09	54.00	31.09	AVG	NO LIMIT
2	2457.4000	61.39	33.04	94.43	74.00	20.43	Peak	NO LIMIT
3	2483.5000	24.55	33.15	57.70	74.00	-16.30	Peak	
4	2483.5000	13.45	33.15	46.60	54.00	-7.40	AVG	

Orthogonal Axis :	X
Test Mode :	TX N-40M MODE 2452MHz

Vertical

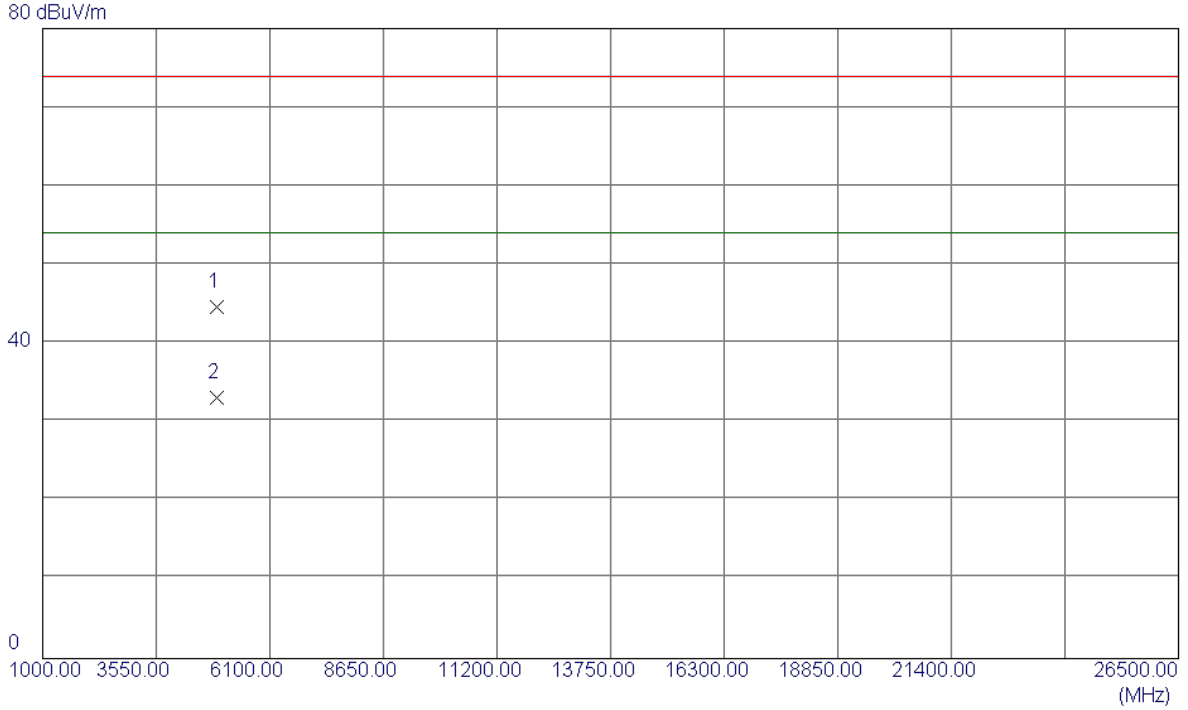

No.	Freq. MHz	Reading Level dBuV/m	Correct Factor dB	Measure ment dBuV/m	Limit dBuV/m	Margin dB	Detector	Comment
1	4904.0150	39.61	5.01	44.62	74.00	-29.38	Peak	
2 *	4904.0700	28.17	5.01	33.18	54.00	-20.82	AVG	

Orthogonal Axis :	X
Test Mode :	TX N-40M MODE 2452MHz

Horizontal

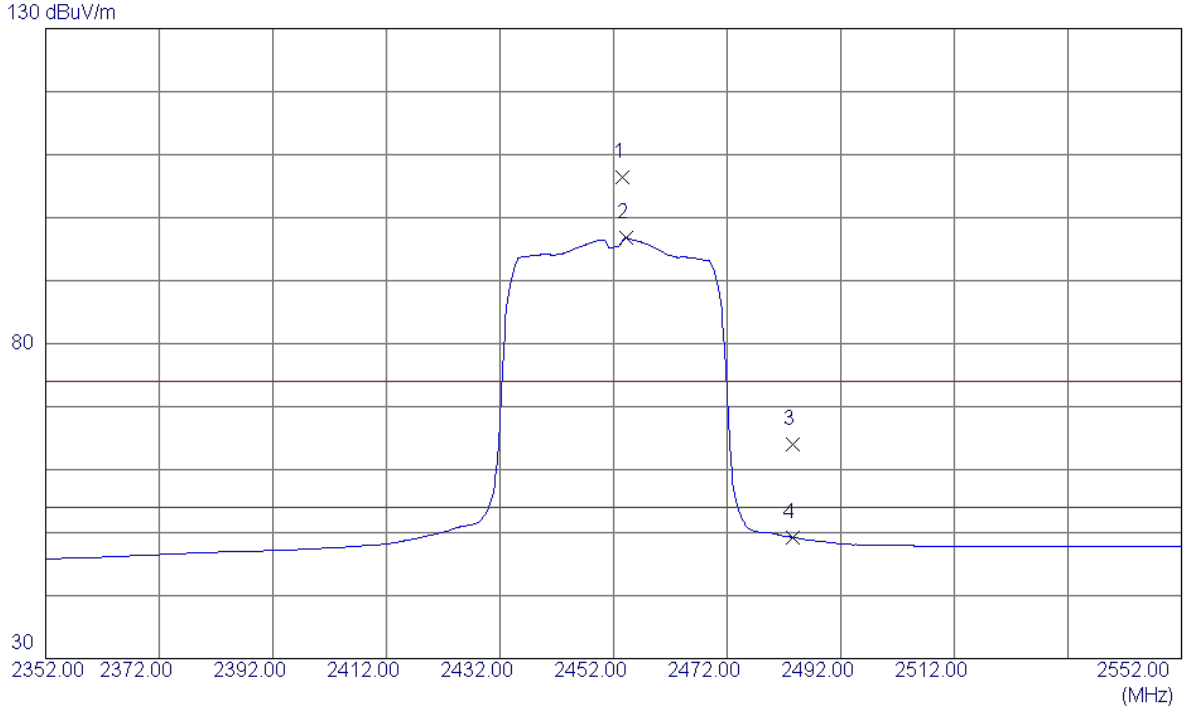

No.	Freq. MHz	Reading Level dBuV/m	Correct Factor dB	Measure ment dBuV/m	Limit dBuV/m	Margin dB	Detector	Comment
1	2453.6000	73.35	33.03	106.38	74.00	32.38	Peak	NO LIMIT
2 *	2454.2000	63.71	33.03	96.74	54.00	42.74	AVG	NO LIMIT
3	2483.5000	30.77	33.15	63.92	74.00	-10.08	Peak	
4	2483.5000	16.06	33.15	49.21	54.00	-4.79	AVG	

Orthogonal Axis :	X
Test Mode :	TX N-40M MODE 2452MHz

Horizontal

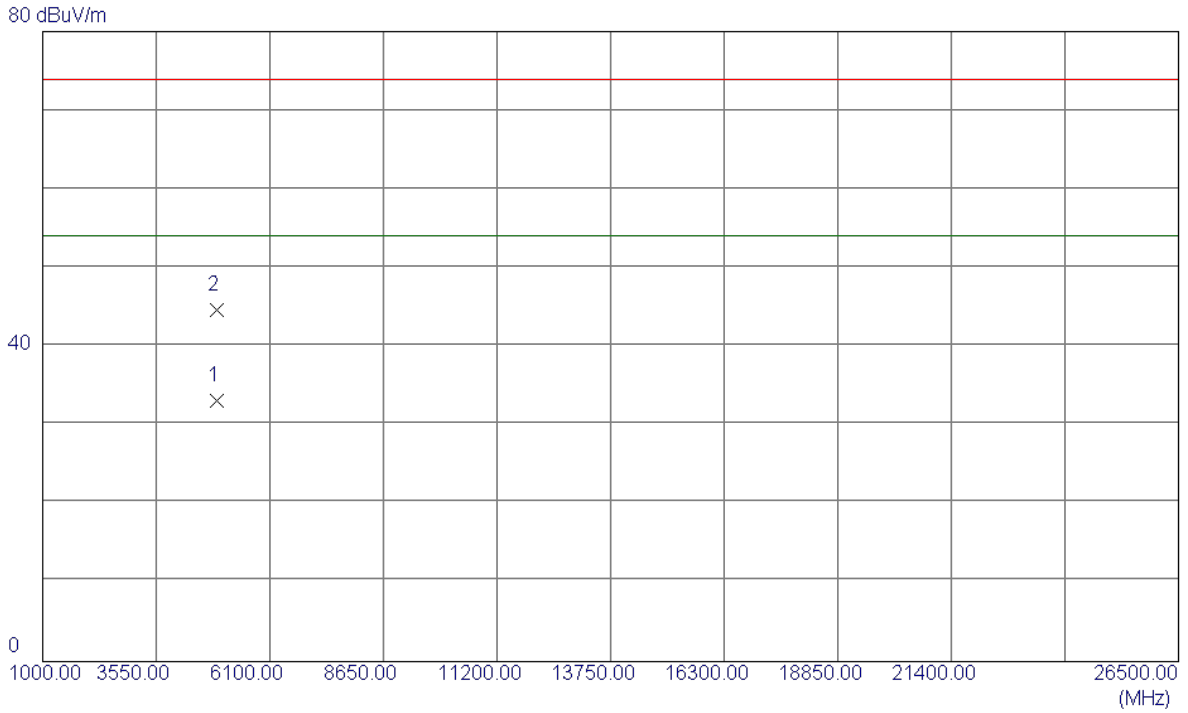

No.	Freq. MHz	Reading Level dBuV/m	Correct Factor dB	Measure ment dBuV/m	Limit dBuV/m	Margin dB	Detector	Comment
1 *	4904.2400	28.15	5.01	33.16	54.00	-20.84	AVG	
2	4904.1700	39.63	5.01	44.64	74.00	-29.36	Peak	

ATTACHMENT E - BANDWIDTH

Test Mode : TX B Mode_CH01/06/11

Frequency (MHz)	6dB Bandwidth (MHz)	99% Occupied BW (MHz)	Min. Limit (kHz)	Test Result
2412	8.60	12.24	500	Complies
2437	8.64	12.20	500	Complies
2462	9.10	12.24	500	Complies

TX CH01

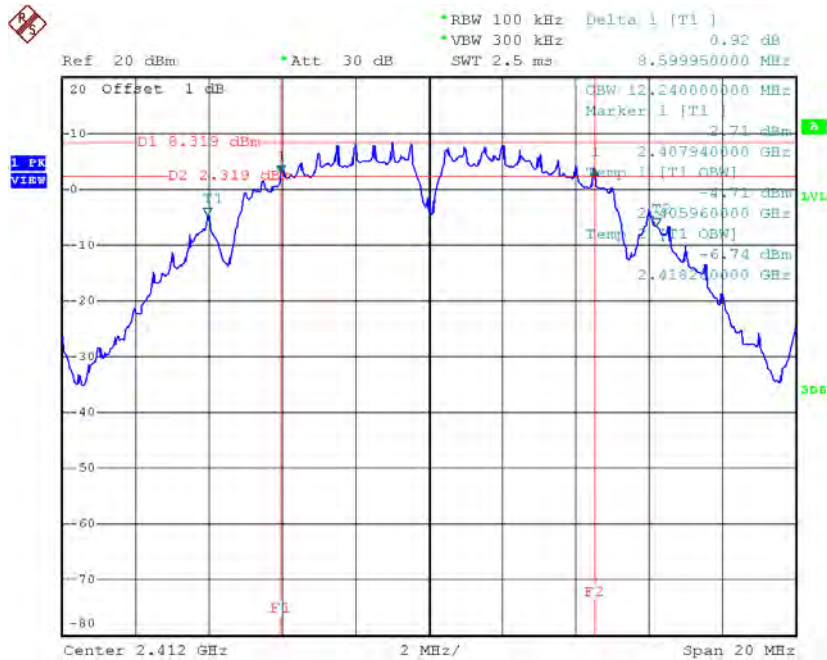

Date: 13.JUN.2016 10:13:47

TX CH06

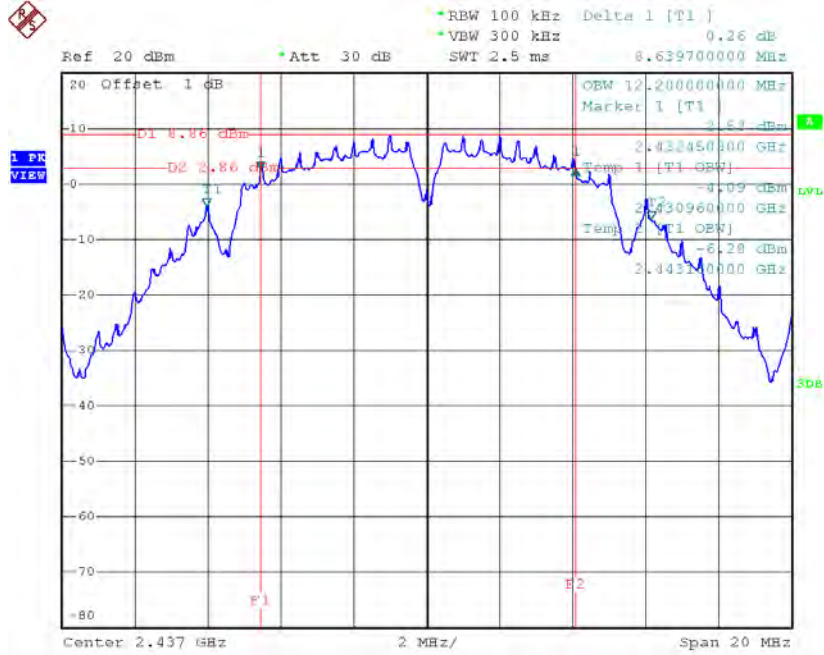

Date: 13.JUN.2016 10:15:58

TX CH11

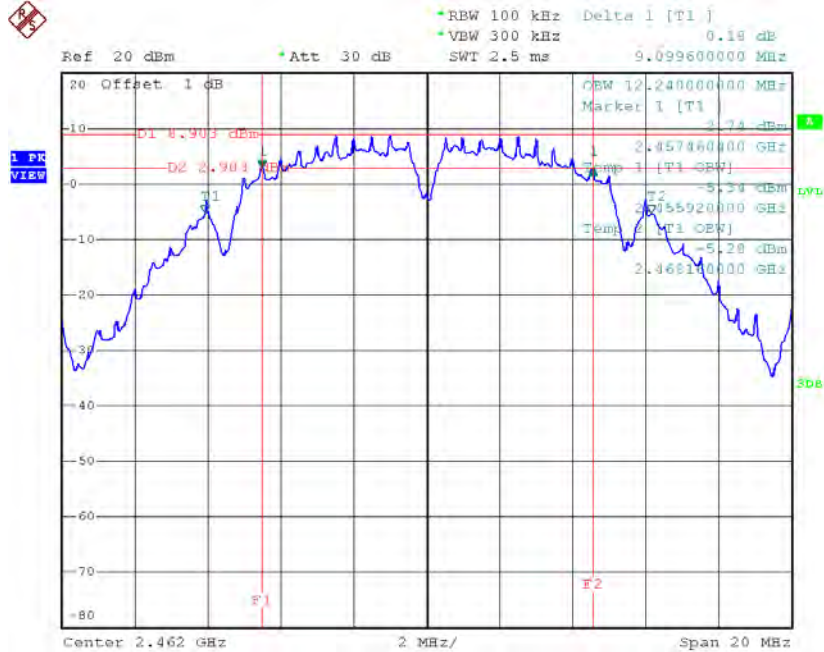

Date: 13.JUN.2016 10:17:34

Test Mode: TX G Mode_CH01/06/11

Frequency (MHz)	6dB Bandwidth (MHz)	99% Occupied BW (MHz)	Min. Limit (kHz)	Test Result
2412	16.38	16.44	500	Complies
2437	16.38	16.40	500	Complies
2462	16.35	16.44	500	Complies

TX CH01

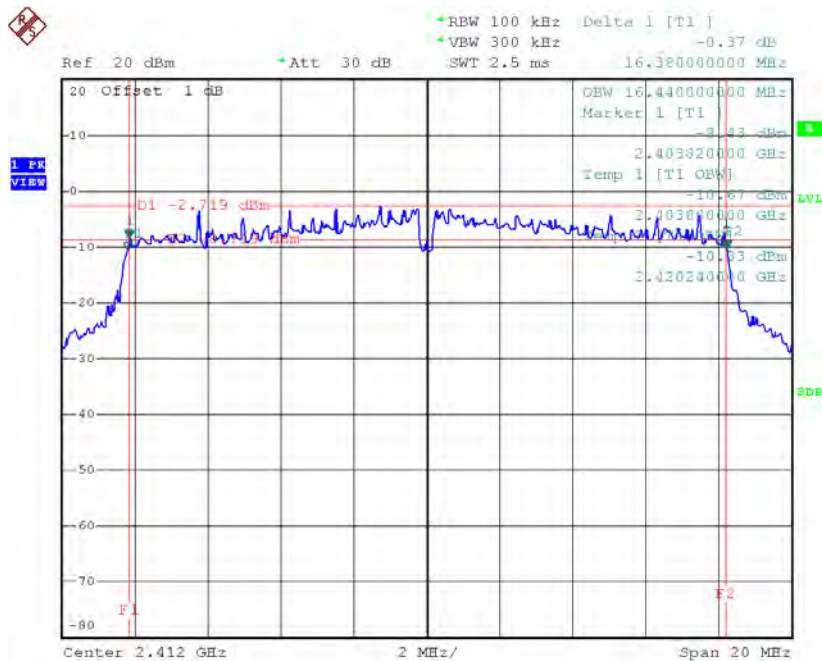

Date: 13.JUN.2016 10:23:36

TX CH06

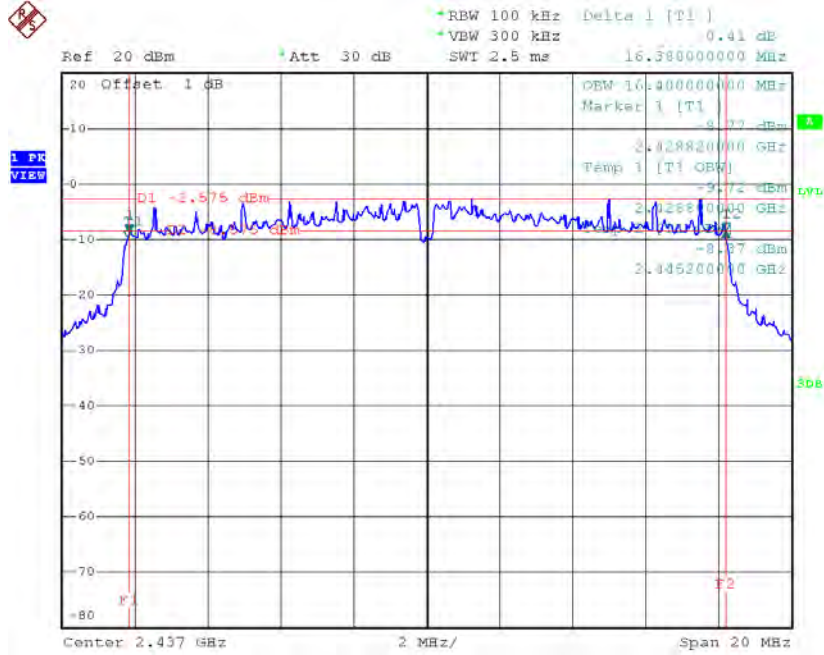

Date: 13.JUN.2016 10:24:47

TX CH11

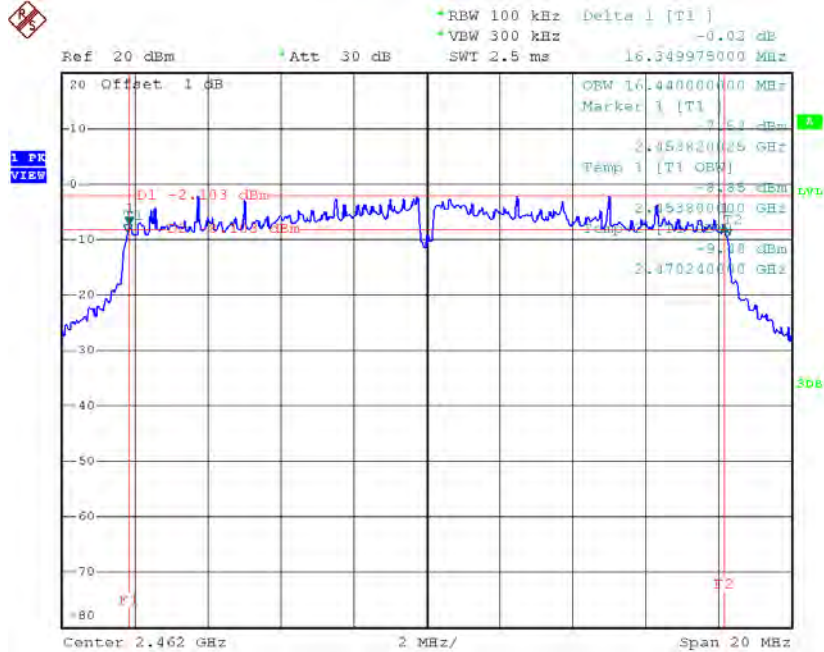

Date: 13.JUN.2016 10:26:02

Test Mode : TX N-20MHz Mode_CH01/06/11

Frequency (MHz)	6dB Bandwidth (MHz)	99% Occupied BW (MHz)	Min. Limit (kHz)	Test Result
2412	16.62	17.64	500	Complies
2437	17.06	17.64	500	Complies
2462	17.60	17.60	500	Complies

TX CH01

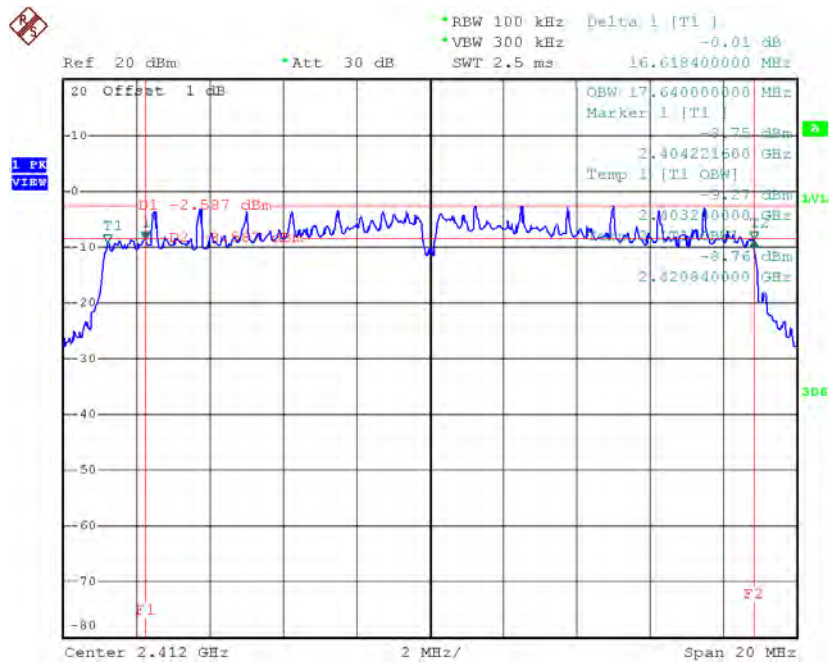

Date: 13.JUN.2016 10:29:04

TX CH06

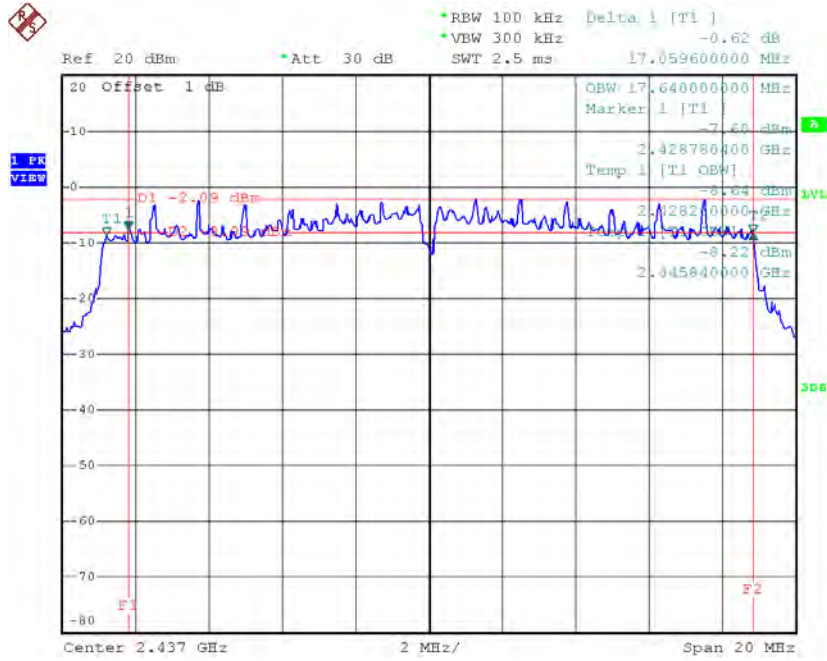

Date: 13.JUN.2016 10:30:16

TX CH11

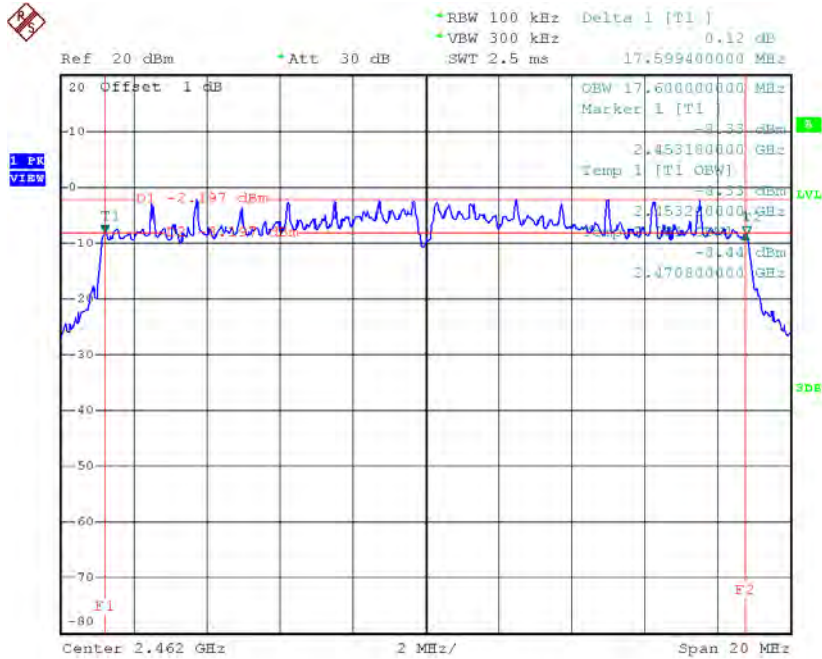

Date: 13.JUN.2016 10:31:12

Test Mode : TX N-40MHz Mode_CH03/06/09

Frequency (MHz)	6dB Bandwidth (MHz)	99% Occupied BW (MHz)	Min. Limit (kHz)	Test Result
2422	35.96	36.00	500	Complies
2437	35.60	36.00	500	Complies
2452	35.84	36.08	500	Complies

TX CH03

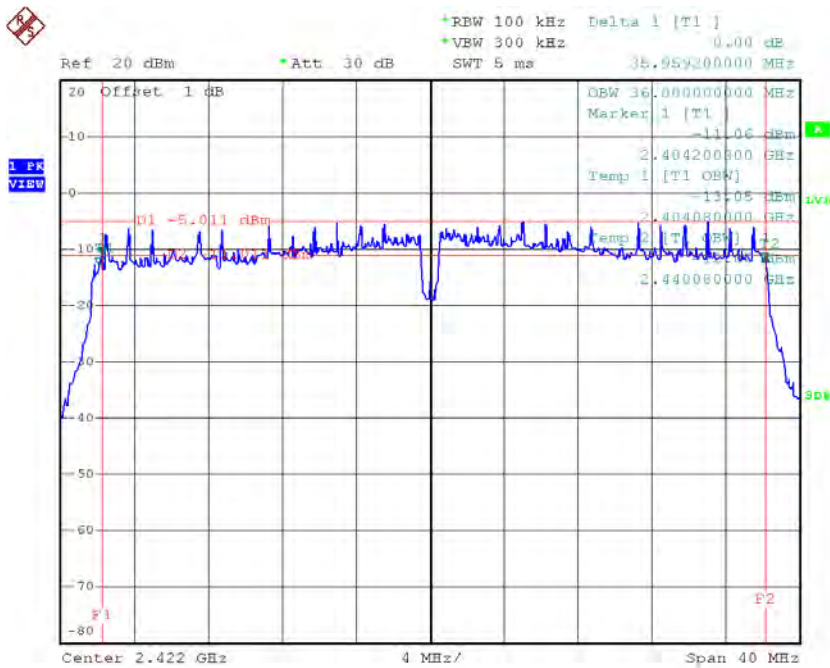

Date: 13.JUN.2016 10:33:58

TX CH06

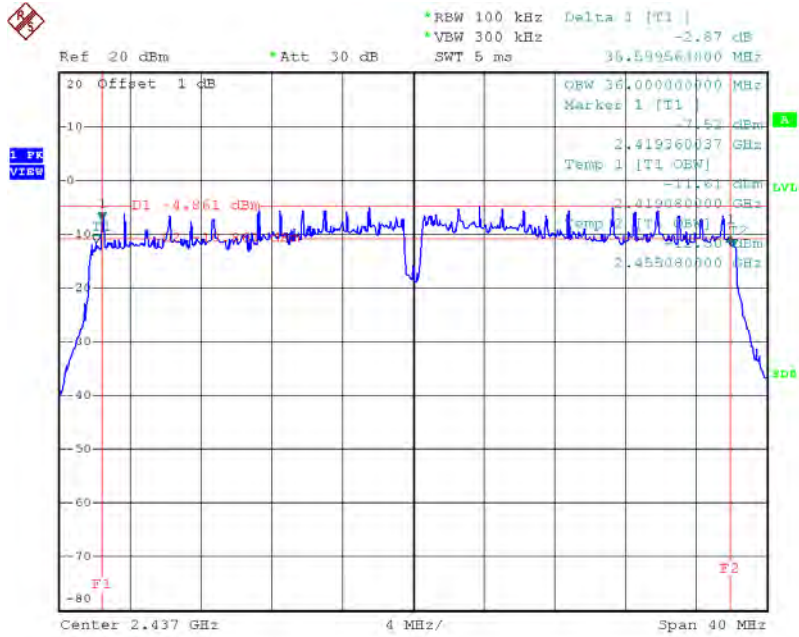

Date: 13.JUN.2016 10:35:09

TX CH09

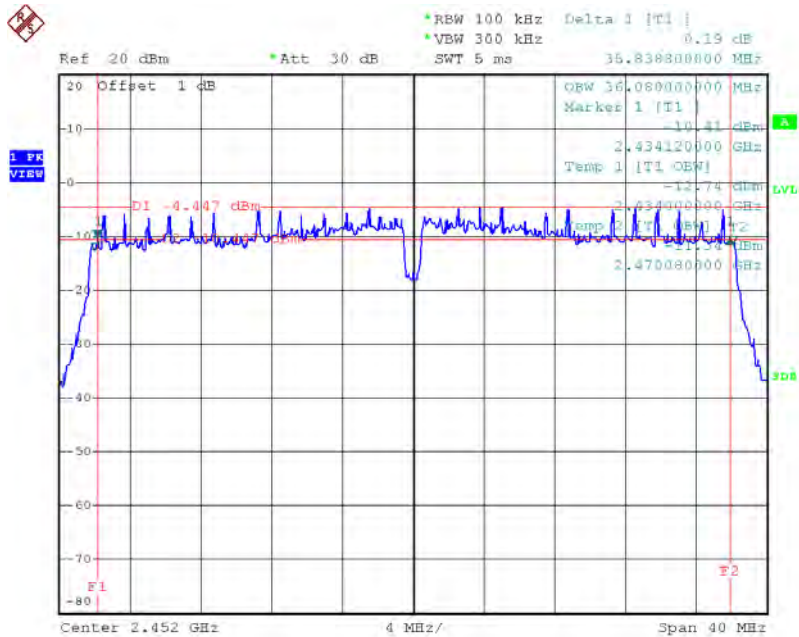

Date: 13.JUN.2016 10:36:20

ATTACHMENT F – MAXIMUM PEAK CONDUCTED OUTPUT POWER

Test Mode :TX B Mode_CH01/06/11					
Frequency (MHz)	Conducted Power (dBm)	Conducted Power (W)	Max. Limit (dBm)	Max. Limit (W)	Result
2412	19.45	0.09	30.00	1.00	Complies
2437	19.58	0.09	30.00	1.00	Complies
2462	19.74	0.09	30.00	1.00	Complies

Test Mode :TX G Mode_CH01/06/11					
Frequency (MHz)	Conducted Power (dBm)	Conducted Power (W)	Max. Limit (dBm)	Max. Limit (W)	Result
2412	19.61	0.09	30.00	1.00	Complies
2437	19.81	0.10	30.00	1.00	Complies
2462	19.99	0.10	30.00	1.00	Complies

Test Mode :TX N20 Mode_CH01/06/11					
Frequency (MHz)	Conducted Power (dBm)	Conducted Power (W)	Max. Limit (dBm)	Max. Limit (W)	Result
2412	19.08	0.08	30.00	1.00	Complies
2437	19.34	0.09	30.00	1.00	Complies
2462	19.36	0.09	30.00	1.00	Complies

Test Mode :TX N40 Mode_CH03/06/09					
Frequency (MHz)	Conducted Power (dBm)	Conducted Power (W)	Max. Limit (dBm)	Max. Limit (W)	Result
2422	19.98	0.10	30.00	1.00	Complies
2437	19.59	0.09	30.00	1.00	Complies
2452	19.99	0.10	30.00	1.00	Complies

**ATTACHMENT G - ANTENNA CONDUCTED SPURIOUS
EMISSION**

Test Mode : TX B Mode

TX B mode CH01

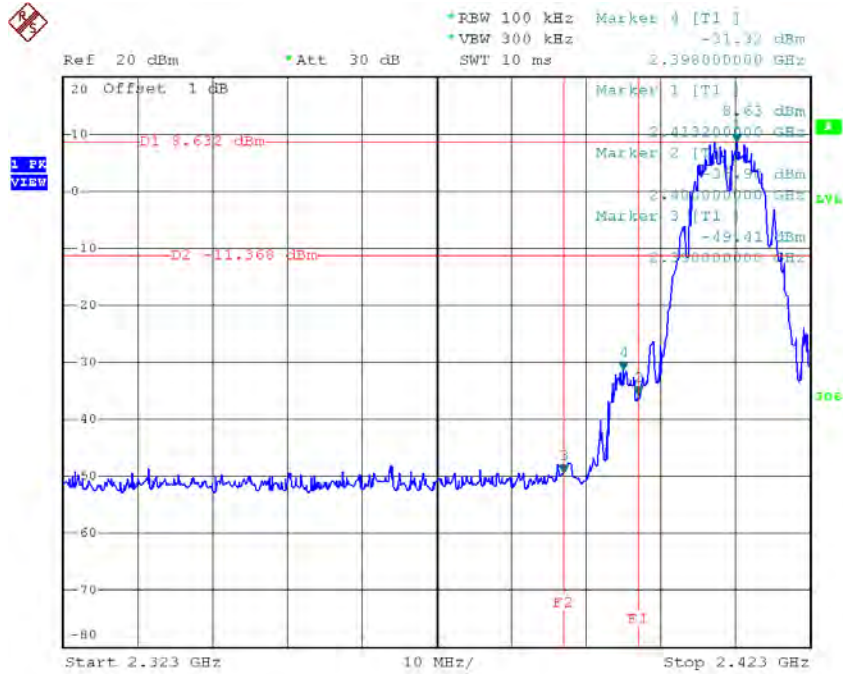

Date: 13.JUN.2016 10:14:09

TX B mode CH11

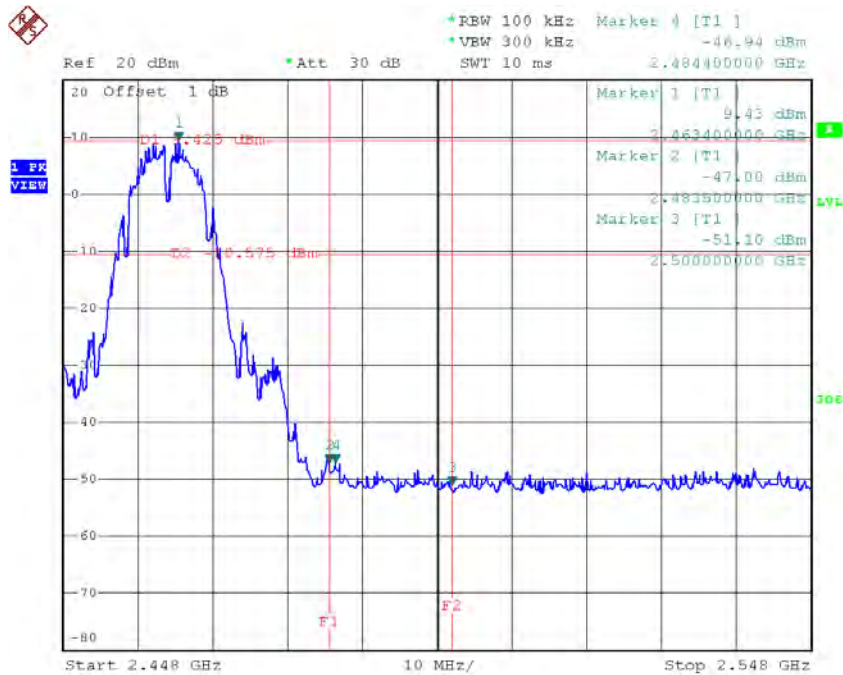

Date: 13.JUN.2016 10:17:56

TX B mode CH01 (10 Harmonic of the frequency)

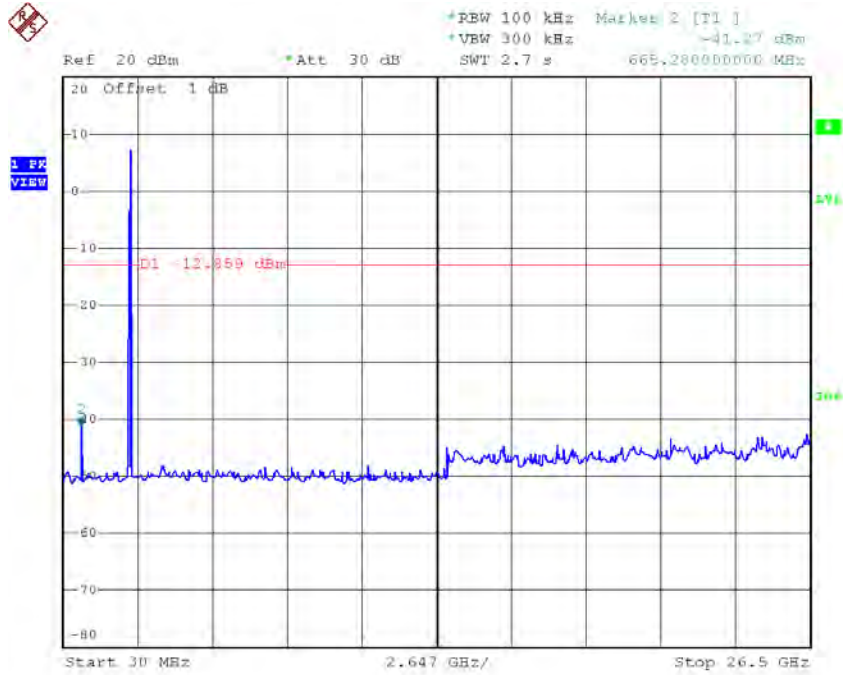

Date: 13.JUN.2016 10:14:01

TX B mode CH06 (10 Harmonic of the frequency)

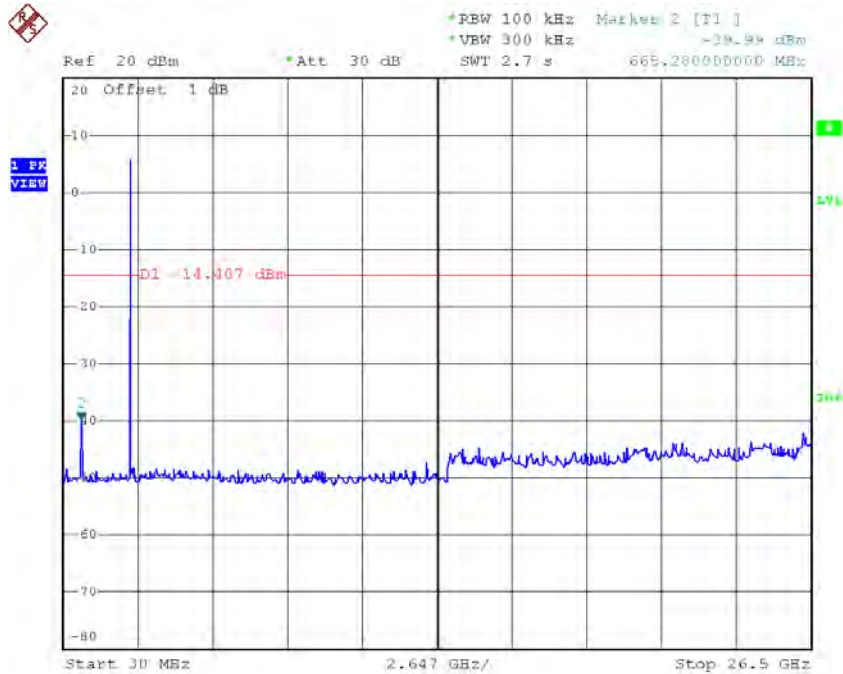

Date: 13.JUN.2016 10:16:12

TX B mode CH11 (10 Harmonic of the frequency)

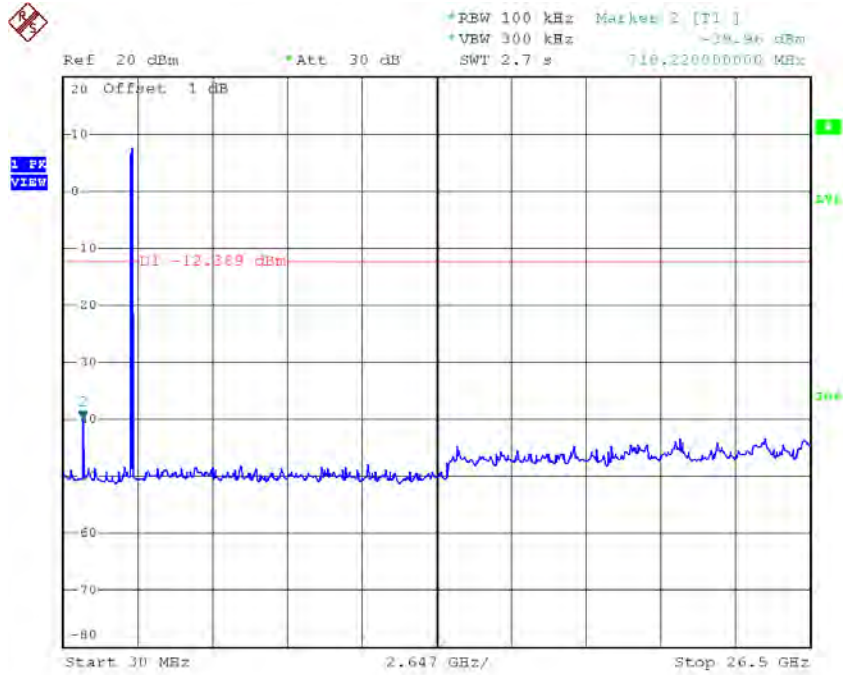

Date: 13.JUN.2016 10:17:48

Test Mode : TX G Mode

TX G mode CH01

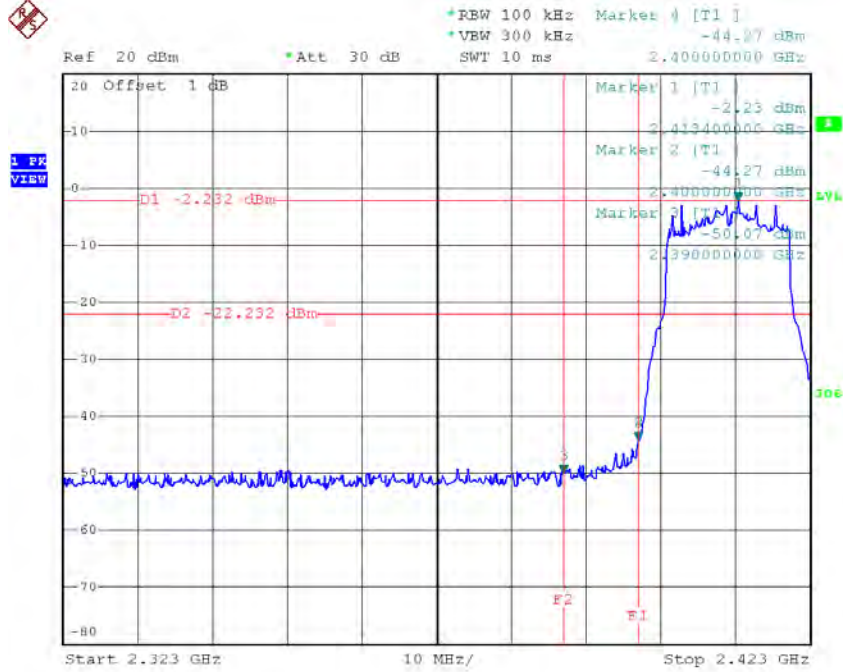

Date: 13.JUN.2016 10:23:57

TX G mode CH11

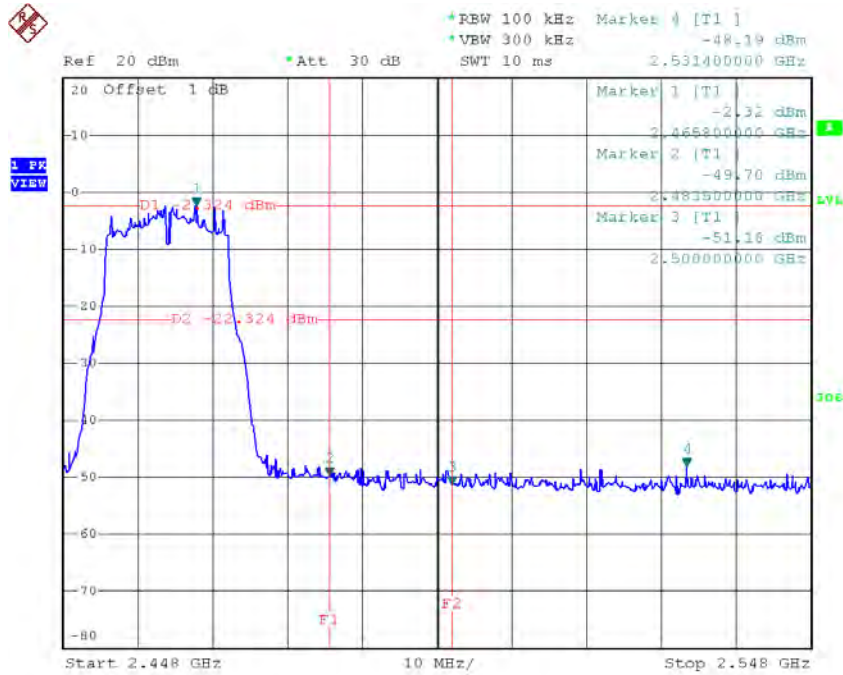

Date: 13.JUN.2016 10:26:24

TX G mode CH01 (10 Harmonic of the frequency)

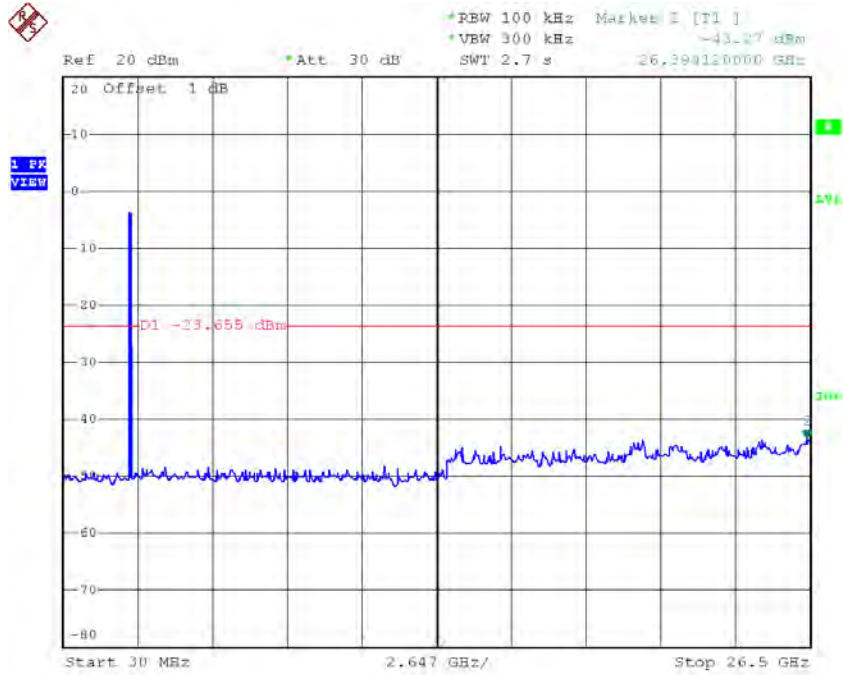

Date: 13.JUN.2016 10:23:49

TX G mode CH06 (10 Harmonic of the frequency)

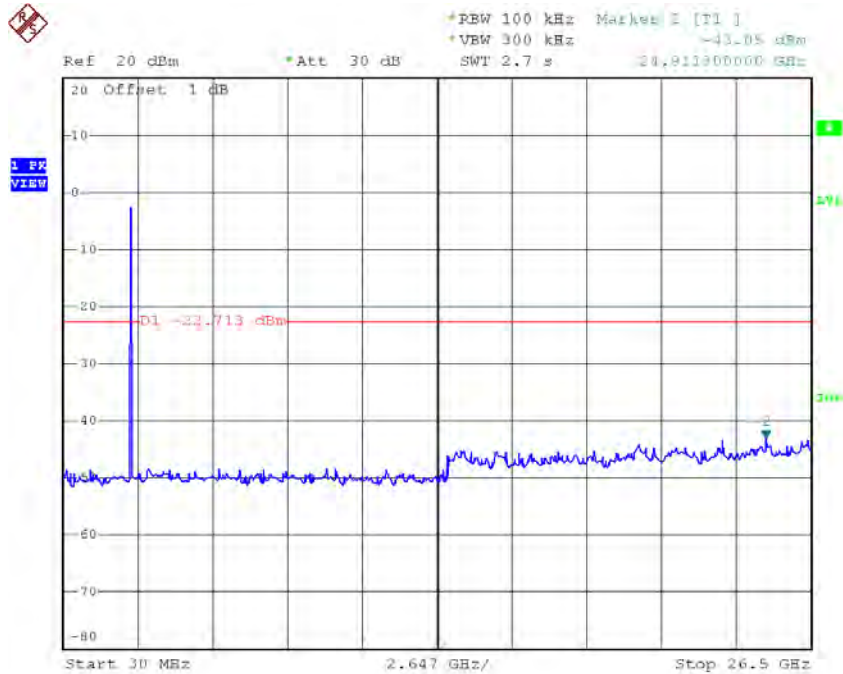

Date: 13.JUN.2016 10:25:01

TX G mode CH11 (10 Harmonic of the frequency)

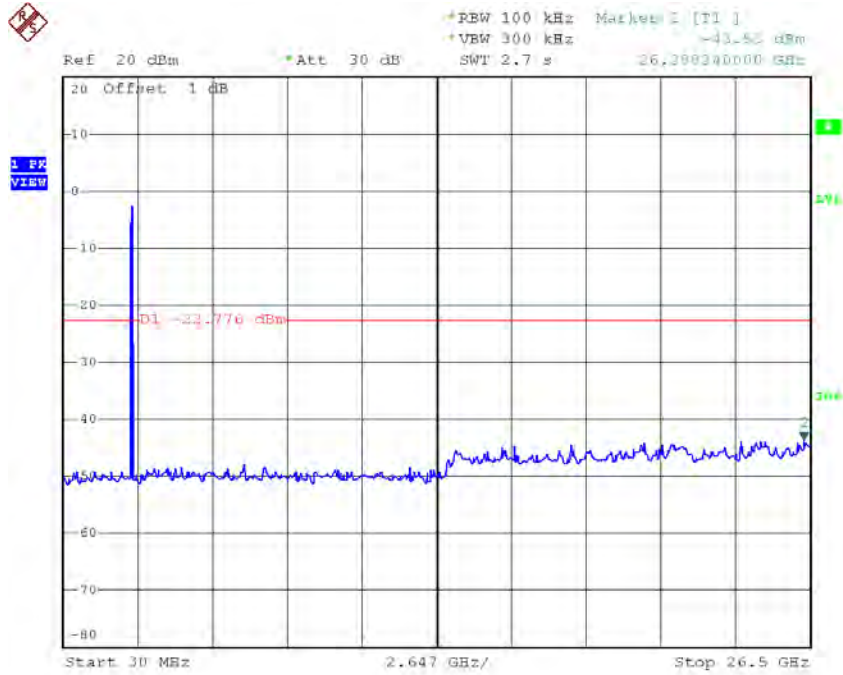

Date: 13.JUN.2016 10:26:16

Test Mode : TX N-20M Mode

TX HT20 mode CH01

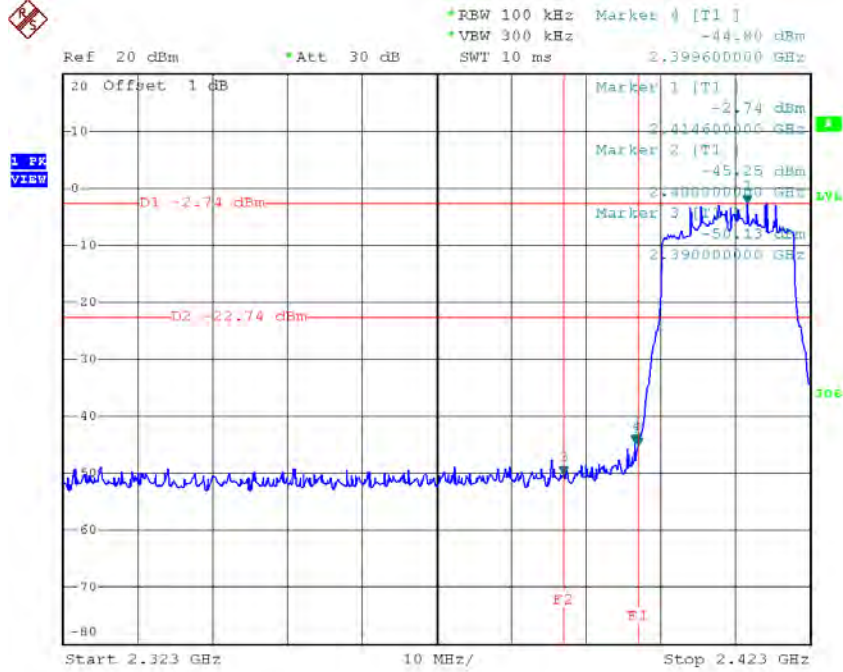

Date: 13.JUN.2016 10:29:25

TX HT20 mode CH11

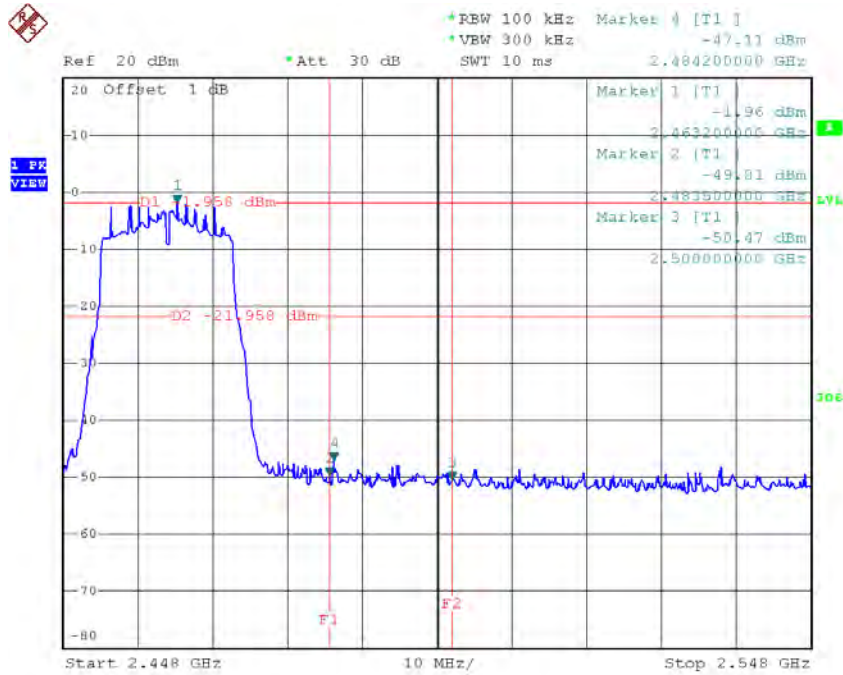

Date: 13.JUN.2016 10:31:34

TX HT20 mode CH01 (10 Harmonic of the frequency)

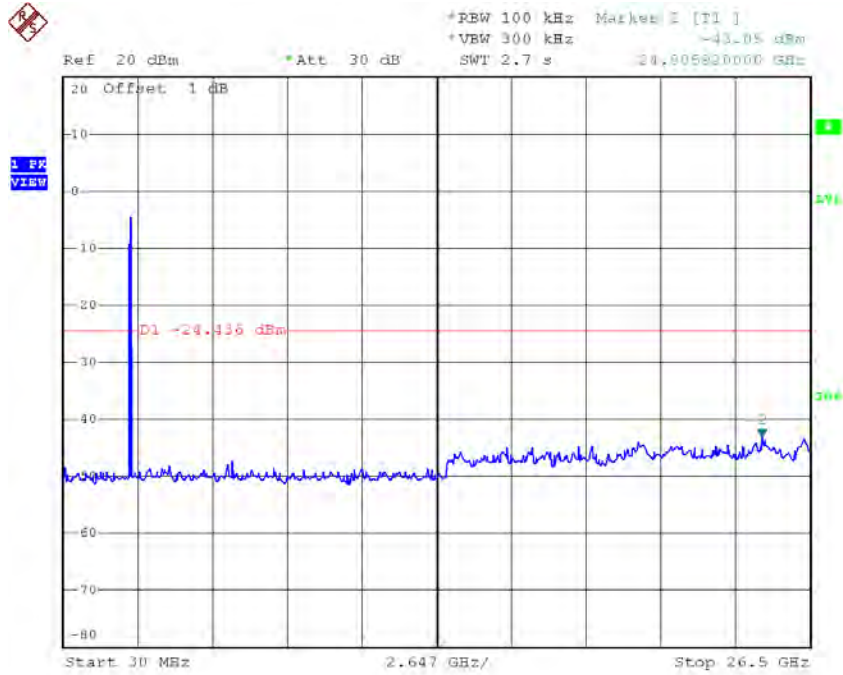

Date: 13.JUN.2016 10:29:18

TX HT20 mode CH06 (10 Harmonic of the frequency)

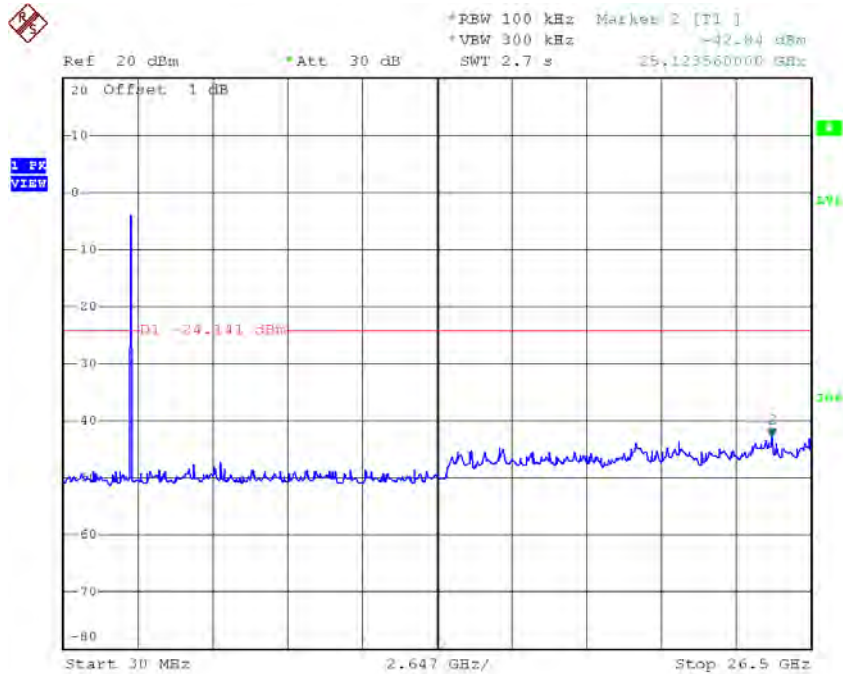

Date: 13.JUN.2016 10:30:30

TX HT20 mode CH11 (10 Harmonic of the frequency)

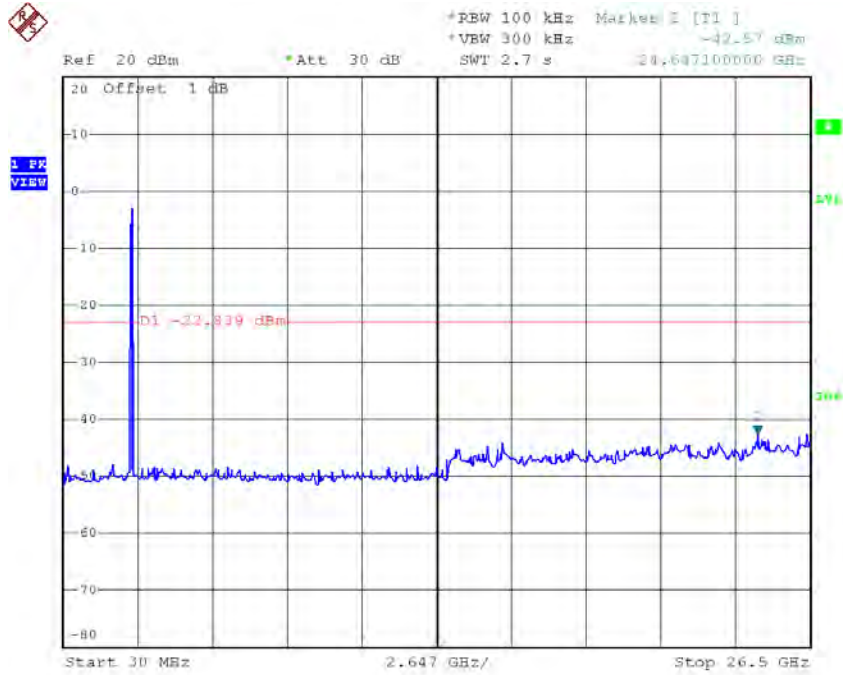

Date: 13.JUN.2016 10:31:26

Test Mode : TX N-40M Mode

TX HT40 mode CH03

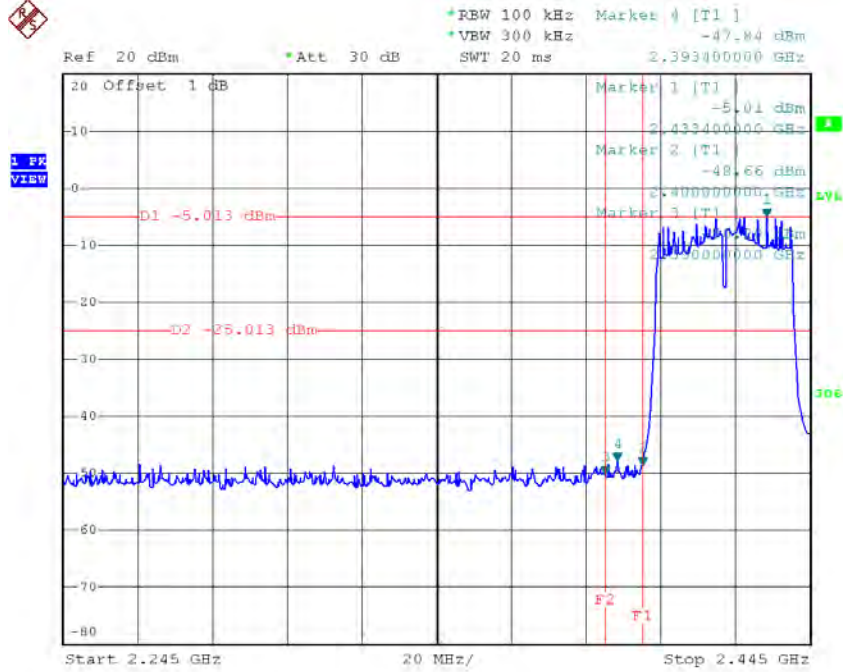

Date: 13.JUN.2016 10:34:20

TX HT40 mode CH09

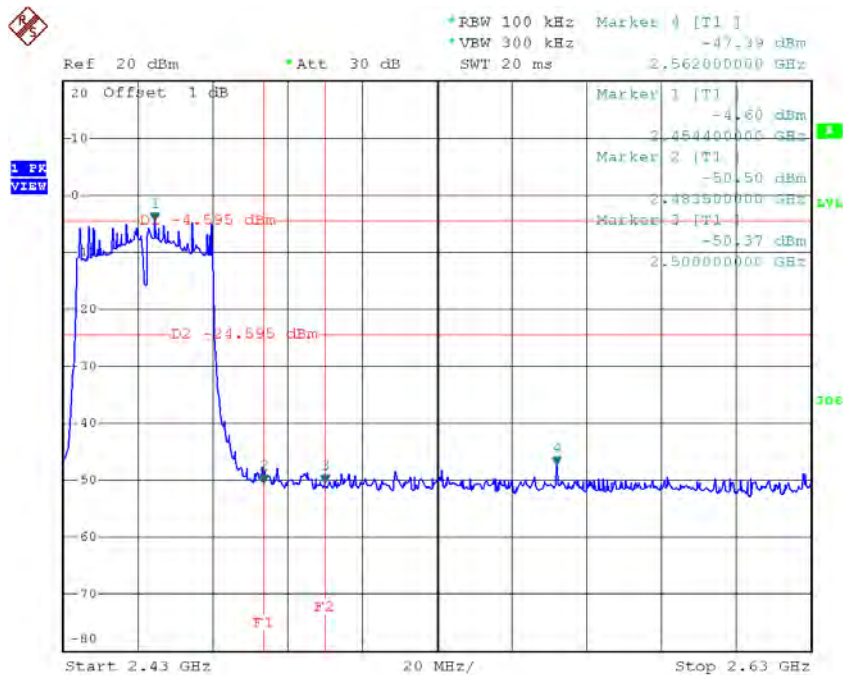

Date: 13.JUN.2016 10:36:41

TX HT40 mode CH03 (10 Harmonic of the frequency)

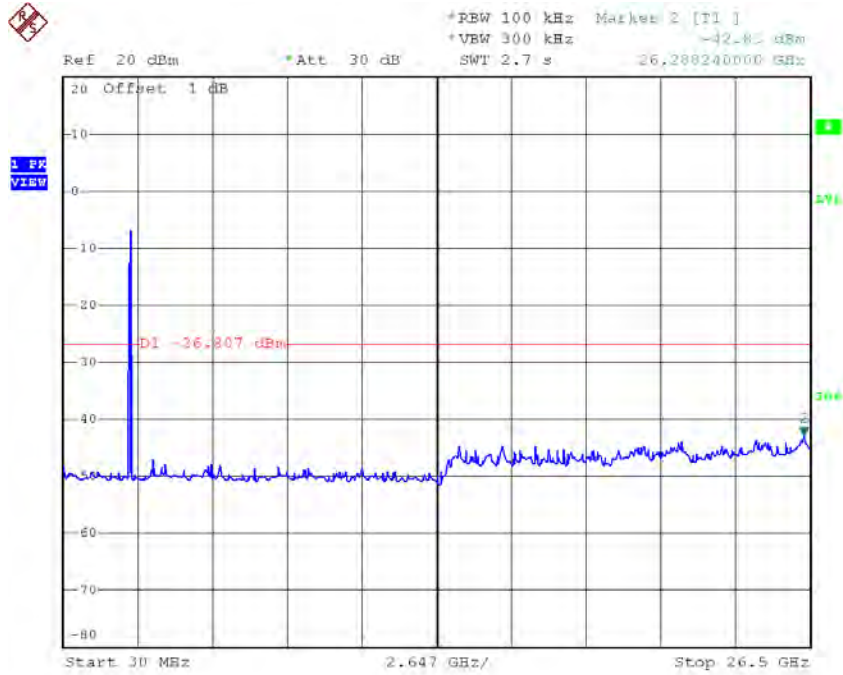

Date: 13.JUN.2016 10:34:12

TX HT40 mode CH06 (10 Harmonic of the frequency)

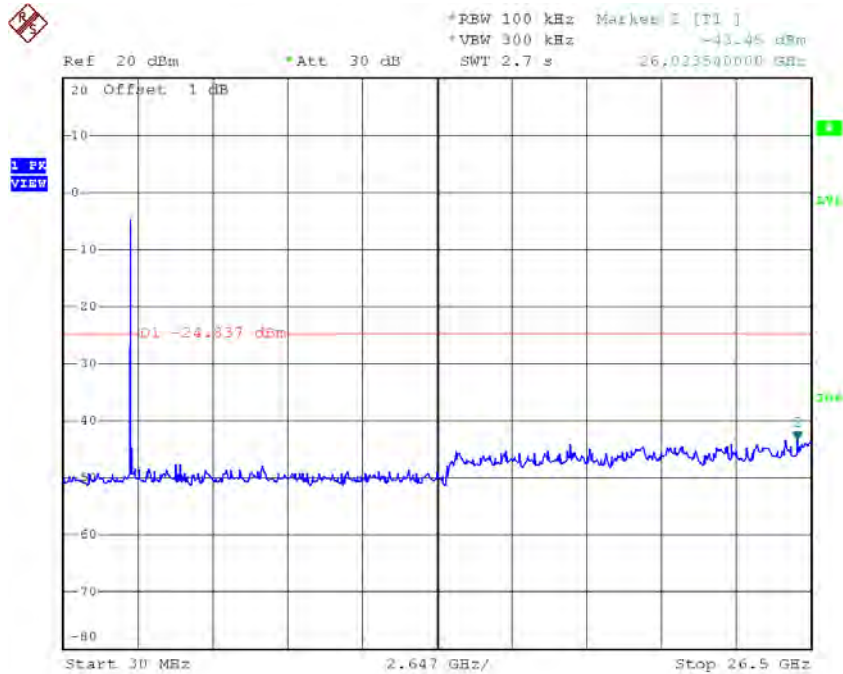

Date: 13.JUN.2016 10:35:23

TX HT40 mode CH09 (10 Harmonic of the frequency)

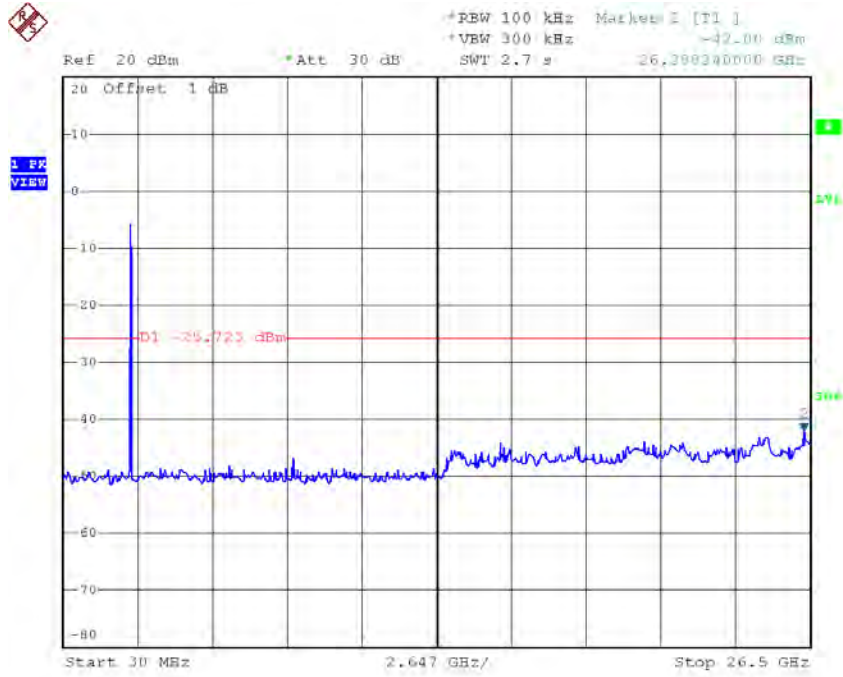

Date: 13.JUN.2016 10:36:33

ATTACHMENT H - POWER SPECTRAL DENSITY

Test Mode :TX B Mode_CH01/06/11

Frequency (MHz)	Power Density (dBm/3kHz)	Power Density (mW/3kHz)	Max. Limit (dBm/3kHz)	Result
2412	-6.03	0.2495	8.00	Complies
2437	-6.22	0.2388	8.00	Complies
2462	-5.19	0.3027	8.00	Complies

TX CH01



Date: 13.JUN.2016 10:14:18

TX CH06



Date: 13.JUN.2016 10:16:21

TX CH11



Date: 13.JUN.2016 10:18:05

Test Mode :TX G Mode_CH01/06/11

Frequency (MHz)	Power Density (dBm/3kHz)	Power Density (mW/3kHz)	Max. Limit (dBm/3kHz)	Result
2412	-14.49	0.0356	8.00	Complies
2437	-15.51	0.0281	8.00	Complies
2462	-13.48	0.0449	8.00	Complies

TX CH01

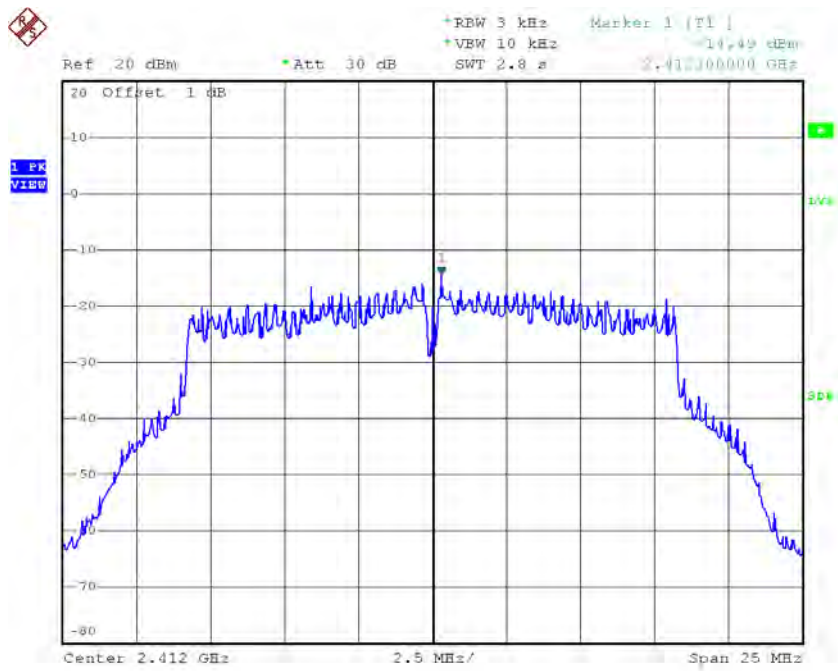

Date: 13.JUN.2016 10:24:06

TX CH06

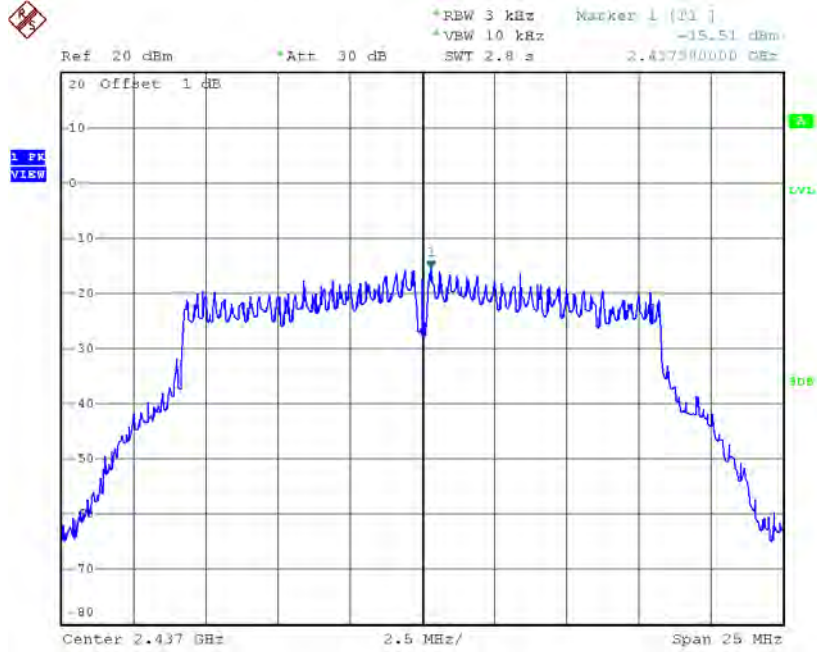

Date: 13.JUN.2016 10:25:10

TX CH11

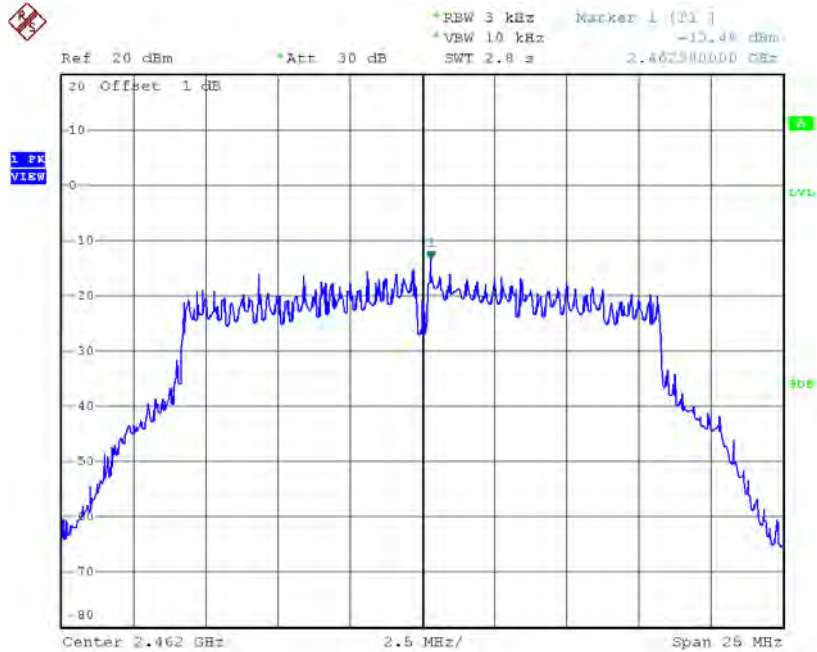

Date: 13.JUN.2016 10:26:33

Test Mode : TX N-20M Mode_CH01/06/11

Frequency (MHz)	Power Density (dBm/3kHz)	Power Density (mW/3kHz)	Max. Limit (dBm/3kHz)	Result
2412	-16.02	0.0250	8.00	Complies
2437	-16.16	0.0242	8.00	Complies
2462	-15.76	0.0265	8.00	Complies

TX CH01

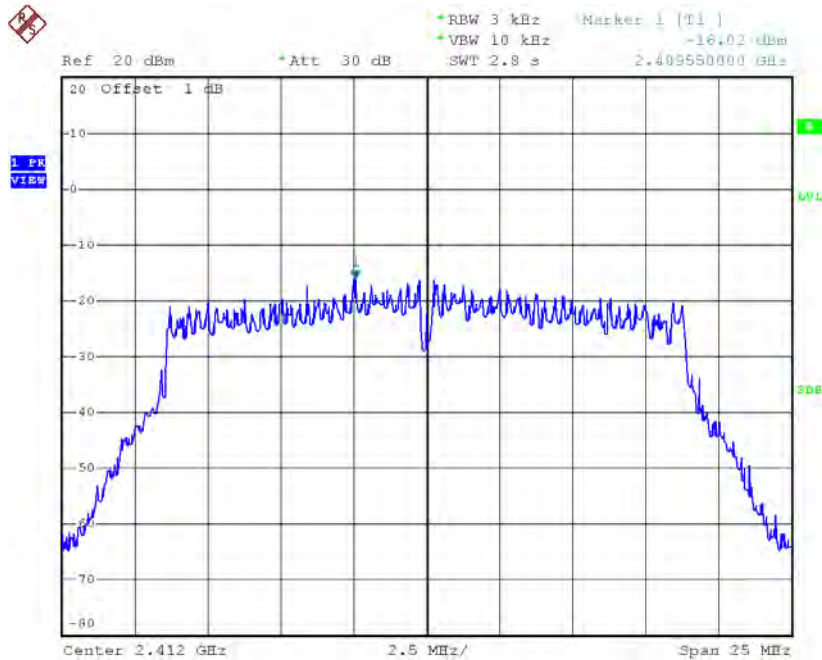

Date: 13.JUN.2016 10:29:35

TX CH06

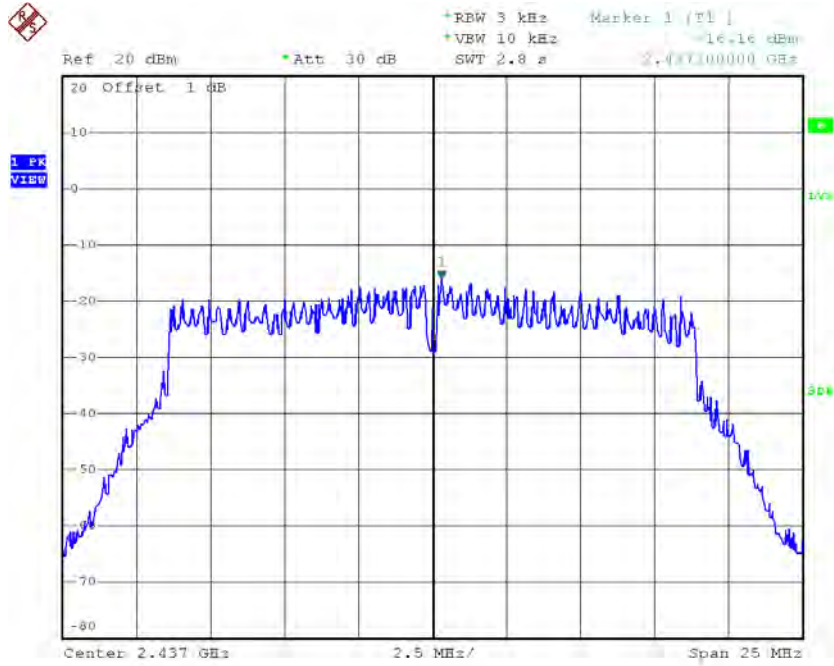

Date: 13.JUN.2016 10:30:39

TX CH11

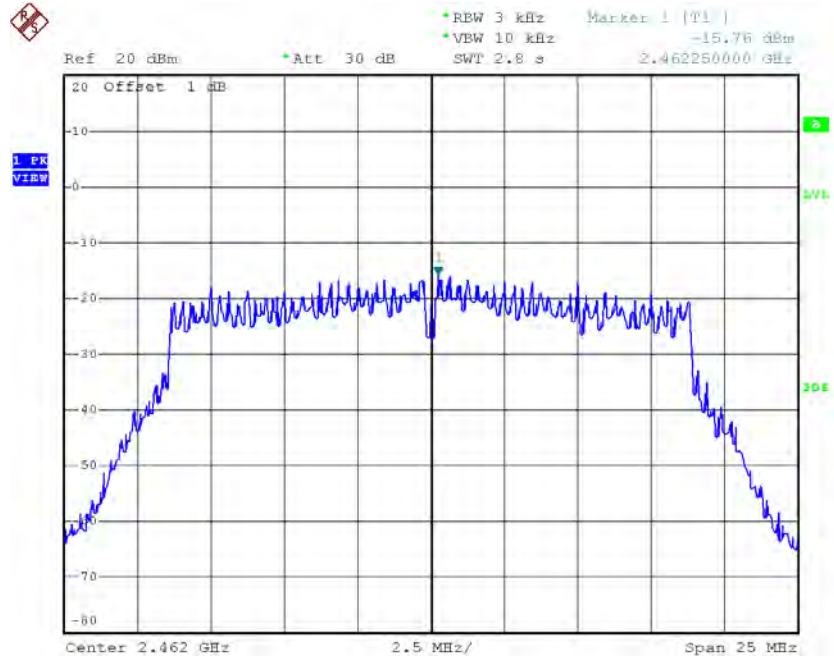

Date: 13.JUN.2016 10:31:43

Test Mode : TX N-40M Mode_CH03/06/09

Frequency (MHz)	Power Density (dBm/3kHz)	Power Density (mW/3kHz)	Max. Limit (dBm/3kHz)	Result
2422	-19.38	0.0115	8.00	Complies
2437	-17.58	0.0175	8.00	Complies
2452	-18.05	0.0157	8.00	Complies

TX CH03

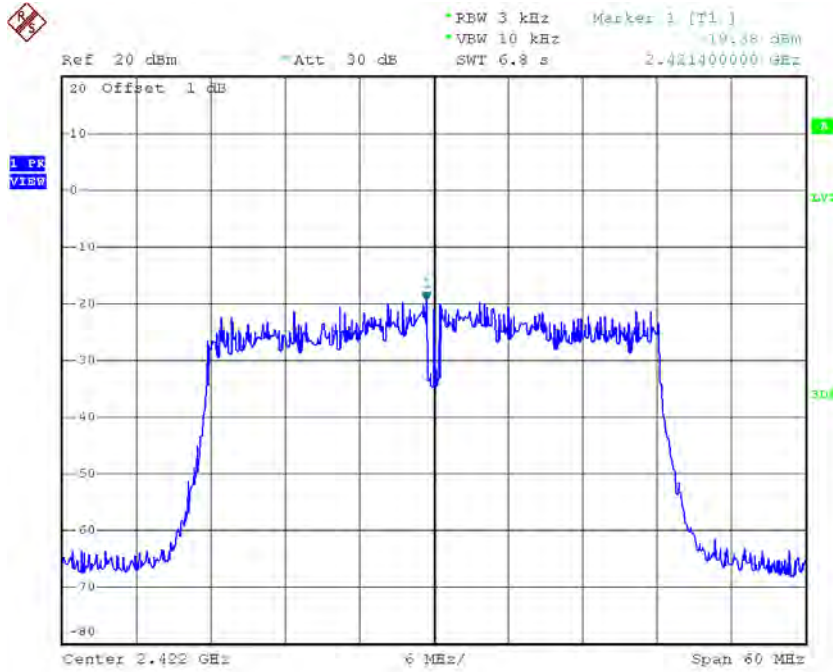

Date: 13, JUN. 2016 10:34:32

TX CH06

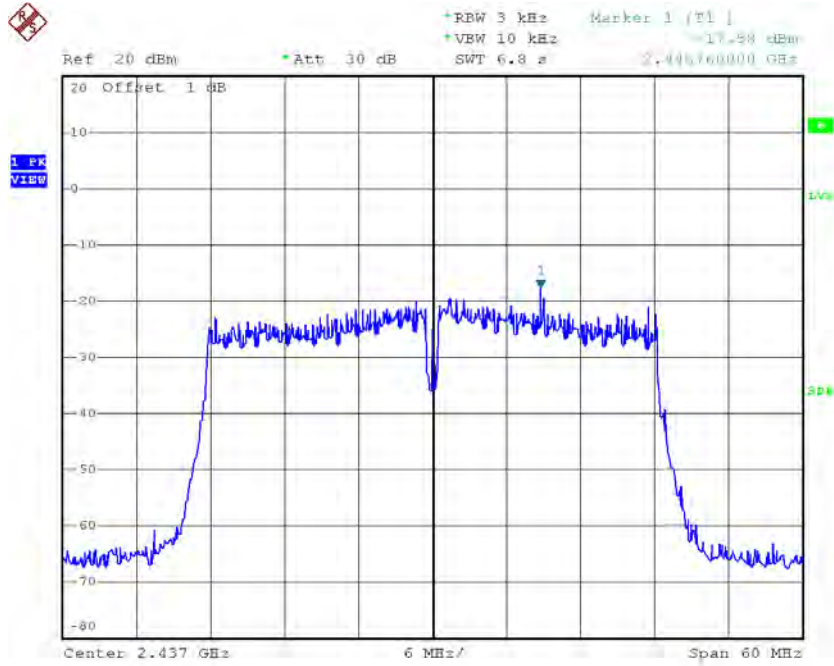

Date: 13.JUN.2016 10:35:35

TX CH09

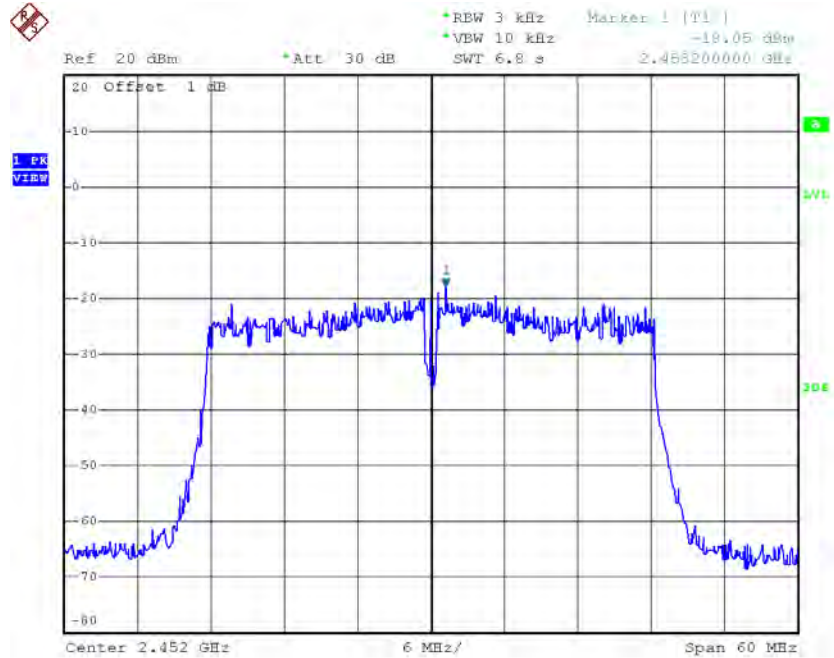

Date: 13.JUN.2016 10:36:53